

INTERGENERATIONAL VILLAGE

SLAYTON, MINNESOTA

Envisioning Design Prototypes for Senior Living



Report #: CAP 242



Southwest Regional Sustainable
Development Partnership

UNIVERSITY OF MINNESOTA
EXTENSION

cura
Center for Urban
& Regional Affairs



COLLEGE OF
DESIGN
UNIVERSITY OF MINNESOTA

INTERGENERATIONAL VILLAGE

SLAYTON, MINNESOTA

Final Report
November 2020



DESIGN AND REPORT DEVELOPMENT

Virajita Singh	Associate Vice Provost, Office for Equity and Diversity, Senior Research Fellow, Center for Sustainable Building Research
Rajeev Atha	Master of Architecture' 20, Master of Science in Sustainable Design' 20, College of Design Graduate Research Assistant, Center for Sustainable Building Research

COMMUNITY PARTNERS AND PLANNING TEAM

Lynn Johnson	President, Operation Prairie Venture
Eileen MaloneBeach	Vice-President, Operation Prairie Venture
Molly Malone	Secretary, Operation Prairie Venture
Deb Penoyer	Treasurer, Operation Prairie Venture
Connie Shaver	Board member, Operation Prairie Venture
Anne Dybsetter	Executive Director, Southwest Regional Sustainable Development Partnership, UMN

PHOTOS IF NOT OTHERWISE CREDITED, FROM:

Connie Shaver, Molly Malone

CONTENTS

Partners _____	04
Acknowledgements _____	05
Executive Summary _____	07
Section One: Introduction _____	11
Section Two: Precedents _____	21
Section Three: Community Engagement _____	31
Section Four: Context Analysis _____	45
Section Five: Design _____	53
Resources _____	71
References _____	73

PARTNERS



Operation Prairie Venture (OPV) intends to create an intergenerational residential setting to house older adults, care for young children, and enrich the community. At this time, OPV is working on multiple fronts to be a national model for intergenerational elder care.

Expanding on existing national and international elder care arrangements, OPV will build a model for supporting older adults who wish to age in a welcoming rural environment.

Southwest Regional Sustainable
Development Partnership

UNIVERSITY OF MINNESOTA
EXTENSION

The University of Minnesota Extension Southwest Regional Sustainable Development Partnership (Southwest RSDP) is a community-driven board of directors working with community members across the region to create and sustain healthy ecosystems, strong local economies and vibrant, self-reliant rural towns.

cura
Center for Urban
& Regional Affairs

The Center for Urban and Regional Affairs (CURA) pursues its urban and regional mission by facilitating and supporting connections between state and local governments, neighborhoods, nonprofit organizations, and relevant resources at the University, including faculty and students from appropriate campuses, colleges, centers or departments.



COLLEGE OF
DESIGN

UNIVERSITY OF MINNESOTA

The Center for Sustainable Building Research (CSBR) is working to transform the built environment in ways that provide for the ecological, economic, and social needs of the present without compromising those of the future.

CSBR's Design for Community Resilience program works with Minnesota communities to offer place-based, integrated solutions based on state-of-the-art sustainability and regenerative design research to address economic, social and environmental dimensions at multiple scales.

ACKNOWLEDGEMENTS

We express sincere thanks to all those who contributed to the project and design process for their participation in and contributions to the vision of the Intergenerational Village.

Operation Prairie Venture

Lynn Johnson Molly Malone Eileen MaloneBeach Connie Shaver Deb Penoyer

Southwest Regional Development Commission

Jason Walker Jessica Welu

Contributors of Research Input

Mandy Brecher, Oasis Care Home
Josh Malchow, City Administrator, Slayton

Attendees of Community Meetings

Lorna Bader
Sheila Crowley
Katie Fuoss
Kate Harmsen
Terri Hurd
Molly Peterson
Ethanie Schmidt
Karen Tommerasen
Calvin Wurpts



Image: Molly Malone

EXECUTIVE SUMMARY

This project, led by the non-profit organization Operation Prairie Venture (OPV) and partners, envisions an intergenerational village in Slayton, Minnesota with independent and assisted living options, community engagement spaces, and other amenities, including a childcare center. Working with other partners in Murray County and beyond, it aims to establish an intergenerational village that offers residences for older adults, assisted living, memory care, and a childcare center.

Section One, Introduction, sets the context for the project with the design brief and a history of Murray County and the City of Slayton. Murray County, located in southwest Minnesota, was established in 1857 by the Minnesota Territorial Legislature and was formally organized in 1872. Today, Slayton is a small farming community of 2000 people. It has been impacted like many Minnesota rural communities by the exodus of working-age adults. As younger people leave the community, the older adults are less likely to find needed goods and services and are more likely to relocate to larger, more distant towns and cities. Older adults in the community need more support and opportunities to age in place.

Section Two, on Precedents, describes the projects and additional research that informed the development of the Intergenerational Village design.

Section Three, on Community Engagement, documents community participation and input given by community members to the Intergenerational Village vision in two meetings held virtually on Zoom in July and August 2020. Section Three also documents the key inputs from the community and the survey results conducted by the Southwest Regional Development Commission. A survey conducted by the Southwest Regional Development Commission, in collaboration with OPV was launched in early July 2020. As of August 2020, 72 responses were recorded.

Section Four, on Context Analysis, documents and analyzes the City of Slayton on a macro scale to investigate the city's possible assets and networks.

SLAYTON



Section Five, on Design, documents design approach, design considerations, design prototypes, phasing of the project and design recommendations for the future. The design considerations aim to address the physical, social, emotional, intellectual, occupational, spiritual and environmental wellbeing of the residents of the Intergenerational Village through architectural design interventions.

Design recommendations for Future expansion are as follows:

1. Develop and adopt a clear economic model and business plan for the project that takes into account guest care and economic viability.
2. Select an appropriate site for the project that offers connection to the outdoors and to local amenities.
3. Integrate social, environmental and economic aspects of the project with the design
4. Integrate sustainable and regenerative design principles into the design.
5. Integrate regenerative and sustainable design in the RFP for architecture, landscape and planning consultant hires.
6. Gather intermittent input to the project from community stakeholders and experts.



Image: Molly Malone



SECTION ONE:

INTRODUCTION

THIS SECTION SETS THE PROJECT CONTEXT WITH A DESIGN BRIEF AND
A HISTORY OF MURRAY COUNTY AND THE CITY OF SLAYTON.



Image: A Guide to Slayton, Lakenwoods.com

PROJECT INTRODUCTION

INTERGENERATIONAL VILLAGE

This project led by the non-profit organization Operation Prairie Venture (OPV) and its partners, envisions an intergenerational village in Slayton, Minnesota that offers independent and assisted living options, community engagement space, and other amenities including a child care center. Working with other partners in Murray County and beyond, OPV aims to establish an intergenerational village that includes residences for older adults, including assisted living and memory care residences, and a child care center.

Like many Minnesota rural communities, Slayton, a small farming community of about 2000 people has been impacted by the exodus of working-age adults. As younger people leave the community, older adults are less able to find local goods and services and must relocate to more larger, distant towns and cities. Gensler Research Institute articulates the value of community support for older adults from a global and national perspective

“According to the World Health Organization, the world population age 60 and over is projected to increase from 900 million in 2015 to 2 billion in 2050. And in the U.S., the 65+ cohort will nearly double to 83.7 million. More older Americans will be healthier, active and pursuing alternate lifestyles. Many will continue to work, engage and mentor future generations, and support our growing economy. With ongoing leaps in service and medical technologies, our need for single-sourced care at a retirement community will no longer be needed by everyone. The future holds opportunities for a variety of alternative lifestyle choices. Our society will need to embrace our full spectrum of generations and develop age-integrated flexible environments where the elderly are once again considered “elders” and are a valuable, experienced resource to society.

Not only do we need to cross generational divides, we also need to unite across industries to fully integrate the successes of each field and their collective knowledge to develop new options for our changing lifestyles.”³⁵

A series of meetings organized in Slayton in 2019 to assess community needs provided affirmation. Older adults (most of whom were women, and many of whom were widows who lived alone in farm houses) indicated their interest in moving to an assisted living facility in town. Such a move, they suggested would be a relief to their, often physically distant children. The proposed village would serve residents from Slayton and the rest of Murray County to make aging in place an option.

The proposed intergenerational village will benefit all stakeholders by helping to meet the social, physical, economic, and psychological needs of older residents, children, and parents. For example, by integrating childcare into the facility, young families currently struggling to find childcare will benefit

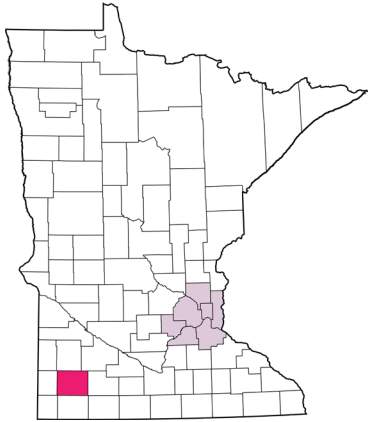

State of Minnesota showing Murray County in pink

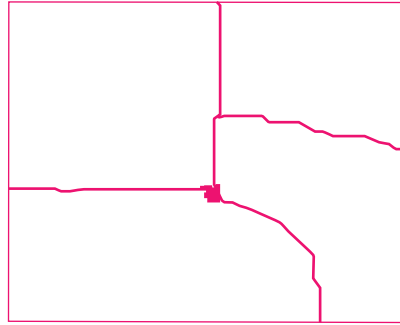

City of Slayton and State Highways in Murray County.

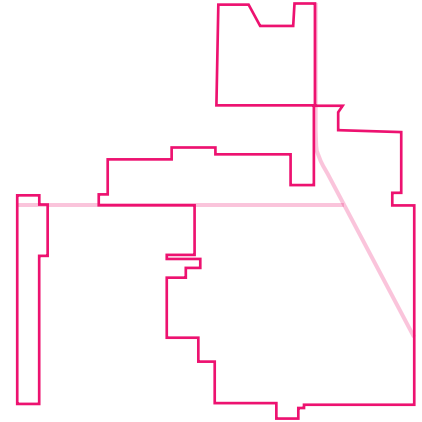

City of Slayton outline with State Highways.

from a safe and welcoming setting for their children. In addition, the larger Slayton community will benefit because local money is more likely to circulate within the community. The area hospital will also benefit because the next nearest hospital is 30 miles away, and travel time, particularly in winter, and the shortage of healthcare workers endangers older adults who need prompt attention, including heart attack and stroke victims.

Ultimately, the project has the potential to revitalize an aging community by allowing its members to age in place in a multigenerational setting. In doing so, the project may bolster community benefits by boosting economic activity and fostering community health.

PARTICIPATORY PREDESIGN

The research and community participatory design process conducted from June 2020 to August 2020 and documented in this report was facilitated by the Design for Community Resilience program at the Center for Sustainable Building Research, College of Design, University of Minnesota - Twin Cities campus. The design process was funded by the Southwest Regional Sustainable Development Partnership (SWRSDP) with community-based assistantship support from the Center for Urban & Regional Affairs (CURA). The Design for Community Resilience program works with Minnesota communities to offer place-based, integrated solutions based on state-of-the-art sustainability and regenerative design research that addresses economic, social and environmental dimensions at multiple scales. Sections Three, Four and Five of this report include outcomes of community engagement, context analysis and design as a result of this process.

CONTEXT

HISTORICAL SIGNIFICANCE OF MURRAY COUNTY

Murray County, located in southwest Minnesota, was established in 1857 by the Minnesota Territorial Legislature and was formally organized in 1872. Murray County, named after William Porter “Pitt” Murray, a member of the Territorial House of Representatives, is a 30 mile by 24 mile rectangle measuring an area of 720 square miles in southwest Minnesota.

The history of Murray County stretches to the Late Prehistoric Period (1100-1700 CE), with evidence of an early settlement of the Great Oasis People in the northwest corner of the county. However, very little is known about this settlement’s history and it was declared abandoned by 1200 CE. In modern history, the primary inhabitants of Murray County belonged to the Sisseton and Wahpeton Dakota tribes, prior to European colonization. Following the first European visit by Philander Prescott in 1831, the first white settlements were established around Lake Shetek.

The US-Dakota War in 1862, was followed by an exodus of Dakota people from Minnesota. The number of immigrants also slowed in the 1860s, when the census indicated a presence of 210 residents. However, by 1880, there were over 3,604 people in the county. By the turn of the century there were close to 12,000 residents. The addition of railroad lines promoted immigration and development of the county. The mass immigration in Murray County consisted of New England Yankees along with people from Scandinavian, German and Canadian ancestry.

As the population grew, it became vital to organize, incorporate and plat the county. In 1872, the county established five townships with elected commissioners. Over the next decade, a total of twenty townships were founded in Murray County. Originally, the city of Currie was the county seat, but in 1890 the county seat was awarded to the City of Slayton.

Agriculture has been and continues to be a crucial driver of Murray County’s economy. The increase in immigration at the turn of the century led to more farms. Between 1870 and 1900, the area of agricultural farmlands increased from 2,400 acres to 385,000 acres with wheat, oats, barley, corn and soybean the major crops. The average farm size was 210 acres.

The population peaked in 1940 with 15,000 residents and this increased population diversified Murray County occupations. Industries and companies such as Des Moines River Cement, Tile Works, Silverdale Tile Factory, Huisken Meat Center, and the Slayton Boat Factory along with the Teepotah Resort and the Valhalla Island Resort were established in Murray County in the middle of the twentieth century.

Technological advancements in livestock breeding, hybrid seeds, crop genetics, fertilizers and pesticides along with mechanized farming resulted in increased agricultural production. Farms were further diversified with hog confinements, beef feedlots and large scale dairy production. The average

farm sizes increased from 210 acres to 339 acres.

After 1940, the population peak slowly began to decline. From its 1940 high of 15,000 residents Murray County is now home to 8,276 residents (as of 2018). Although the population declined, changes in the late twentieth and early twenty first centuries increased the county's occupational diversity. Although agriculture is still its main industry, other businesses such as engineering, healthcare and renewable energy have gained popularity.



Murray County Courthouse 1892-1981

Image: Murray County Historical Society

CITY OF SLAYTON

Slayton Township was organized on July 20, 1872. It was initially called "Center" due to its central location in Murray County. In 1882, after the railway village was platted, the township was renamed to "Slayton", to honor Charles W. Slayton, its founder and chief proprietor. He was a real estate dealer who lived in Slayton for two years in 1881-82. The city in section 15 was incorporated on February 26, 1883, and reincorporated on September 30, 1918. It had a station on Chicago, St. Paul, Minneapolis and Omaha Railroad, and the post office was established in 1881.⁵

When Slayton was formally recognized as a city in 1872, Currie was designated the county seat. In 1886, as the Slayton population grew, the residents of Slayton filed a petition to relocate the county seat and courthouse from Currie to Slayton. This led to a four-year long battle for the seat in which a series of public petitions, elections and court cases debated the potential move. Finally, in June 1890, the Minnesota Supreme Court ruled in favor of moving the county seat to Slayton.

Slayton and Currie also vied for hosting the Murray County Fair. The Murray County Fair was first hosted by the Murray County Agricultural Society (MCAS) in 1880 at Avoca. In 1885, the MCAS established its official fairgrounds in Currie. In 1884, Slayton residents who aspired to host the next county fair, formed a rival organization to the MCAS. Over the subsequent 15 years, two fairs took place in Murray County - one in Slayton and one in Currie. However, as the City of Slayton grew, so did the size and popularity of its fair. By 1898, the Slayton Fair was bigger, and better attended than the Currie Fair and won the battle for Murray County Fair. Slayton won this battle, too, and in 1912, MCAS purchased 36-acres for new fairgrounds in Slayton.

The City of Slayton expanded with its increasing population and the popularity of its County Fair. By 1925, additional infrastructure included the establishment of three banks, six churches, paved streets, lumber yards, grain elevators, a modern hospital, various types of stores, as well as telephone systems that connected Slayton to the rest of Murray County. The social infrastructure included offices, new schools, recreational facilities and civic and fraternal organizations. The Slayton community continues to thrive to this day.

In 2018, Slayton's population was 1,997 with the median age of 45.4 years. Between 2010 and 2018, Slayton's population decreased by about 7% from 2,147 to 1,997. In terms of the age distribution, 50.8% of the population is 45 years or older and 26.4% being 65 years or older. The gender ratio is slightly tilted toward women with 52.5% female and 47.5% male residents. In addition, 18.8% of Slayton residents live with a disability.

According to the United States Census Bureau Data, 97.1% of Slayton's population is white, 1.36% is black or African American, 1.01% is Hispanic, 0.354% identifies as an other race, and 0.152% identifies as Asian. A small fraction of the population (1.6%) speaks English as a second language, and 99.6% are United States citizens.

The median household income of Slayton residents is \$48,088 with approximately 9.3% of the population living below the poverty line. However, 76.8% of the residents are homeowners and the median property value is \$75,600. A household in Slayton has an average of two cars and its residents' average commute time is 15.7 minutes.

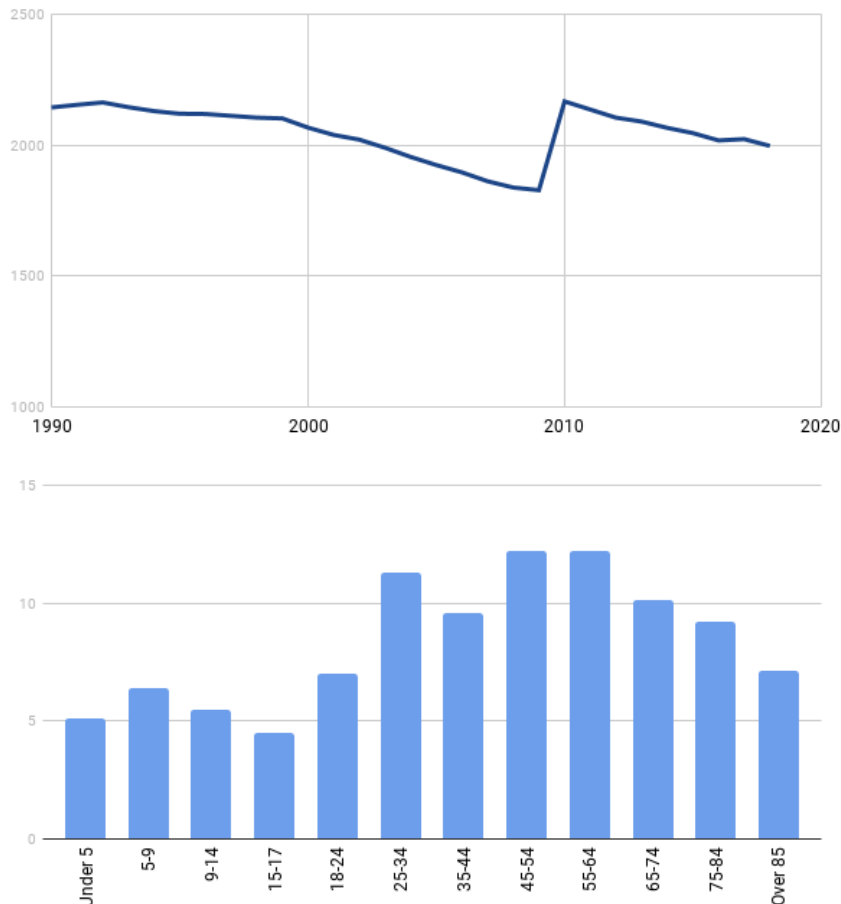

Top: Line Chart Population Change in Slayton from 1990 to 2018
 Bottom: Bar Chart showing Age Distribution in Slayton in 2018



High School, Slayton, 1950

Image: LakenWoods.com



Broadway Ave. Slayton, 1968

Image: Minnesota Historical Society



Image: Dezeen, 2017. Haptic Architects, 2016

An architectural rendering of a modern building with a glass facade and a wooden walkway. The building has a prominent glass wall on the right side, showing an interior with a hanging light fixture and a balcony with plants. The walkway is made of light-colored wood and is populated with several people, including a woman in a patterned dress and a child in a white sweater and patterned skirt. The scene is set in a landscaped area with tall grasses and a tree. The overall atmosphere is bright and airy, suggesting a modern, community-oriented living environment.

SECTION TWO:

PRECEDENTS

THIS SECTION DESCRIBES SOME OF THE PROJECTS AND ADDITIONAL RESEARCH THAT INFORMED THE DEVELOPMENT OF THE INTERGENERATIONAL VILLAGE.

PRECEDENT: LUVERNE, MINNESOTA

OASIS CARE HOME

Oasis Care Home, a family-owned and operated assisted living facility, is located in Luverne, in southwestern Minnesota. Oasis Care Home can house six residents at a given time. The architecture of the care home takes its inspiration from a traditional Midwestern house. The open concept house consists of a living room, dining space with an open kitchen, and a sunroom connected to an outdoor patio. There are six bedrooms on the second floor with jack-and-jill style bathrooms shared between them. Handrails and handlebars at various locations help residents regain their independence and enable them to move freely in the house.

Along with assisted living for the elderly, Oasis Care Home provides memory care for its residents. The care home has various activities for social engagement, however, it is observed that informal conversations around the dining room are the most essential form of social interaction. The combination of a low number of residents, a staff member present at all times and an architectural space suggestive of a home, offers residents a personalized experience.

Images: Oasis Care Home, Mandy Brecher

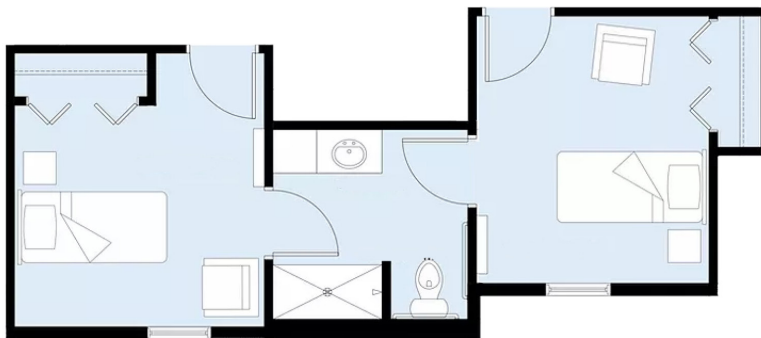

PRECEDENT: WARROAD, MINNESOTA

WARROAD SENIOR LIVING CENTER

Wold Architects and Engineers designed the Warroad Senior Living Center with a north woods home or lodge as inspiration. The campus spread over 24-acres consists of 34 assisted living units, 22 independent living units, 10 memory care units, and 49 skilled nursing units. Living units are segregated in four buildings according to the type of care, function and purpose. However, all four buildings are connected to the “Town Center.” The Town Center provides the residents the experiential quality of going out to town. It incorporates indoor boulevards and amenities such as a chapel, beauty shops, fitness center, club room, business center, cafes, and more.

The Warroad Senior Living Center promotes spiritual, creative, social, emotional, physical, intellectual, and sensory well-being through various activities and programs. The architecture of the facility reflects Northern Minnesotan rural culture, particularly in its lodge-like appearance and its organization around the Town Center.

“Residents may choose their level of connection to the community and the services offered, providing them with a sense of separation and autonomy.”¹³

Images: Wold Architects and Engineers



NEWBRIDGE ON THE CHARLES

NewBridge on the Charles is an intergenerational campus with a variety of senior housing options. It also includes a setting for 450 students at the Rashi School on the same parcel of land. The 162-acre NewBridge campus located along the Charles River on the outskirts of Boston. It is collaboratively designed by Perkins Eastman Architects and Chan Krieger. The living accommodations include 50 cottages, 24 villa apartments, 182 apartments, 51 traditional assisted living apartments, 40 memory support rooms, and a 268-resident healthcare center with 220 long-term care residents and 48 sub-acute patients.

In addition to the integration of physical, emotional and spiritual dimensions, the design also highlights sustainable architecture design. By adopting the LEED design principles as a guide, the design was developed with green roofs, underground pedestrian walkways, rainwater harvesting, and one of the largest closed-loop geothermal systems in New England. These design implementations resulted in a 50% savings of natural gas consumption and a 35% reduction in CO₂ emissions.

“With an extensive palette of natural materials and naturally-occurring colors and patterns, a cohesive design emerged that connects residents to the natural environment whether inside or outdoors.”¹⁶

Images: Perkins Eastman Architects



PRECEDENT: SANTA ROSA, CALIFORNIA

SPRING LAKE VILLAGE

Designed by Perkins Eastman Architects, Spring Lake Village is a retirement community with assisted living facilities. The 26-acre campus is located in Northern California's Sonoma Valley wine country. Spring Lake Village consists of 84 living units with options for 62 independent living units or apartments, and 22 senior assisted living and memory care units. The independent living apartments provide residents with the choice of living in two or three story villas as well as single story cottage duplexes; the larger 22-unit villa is a home to the assisted living units.

Spring Lake Village also focuses on sustainable development and environmentally responsive design. The climate of California and its ongoing battle with drought enabled Perkins Eastman to include low impact site features such as bioswales for stormwater treatment, underground stormwater retention facilities and water saving plumbing fixtures. Integration of social, cultural and environmental measures has made Spring Lake Village a resilient community.

"The seven dimensions for its resident's well-being – social, emotional, spiritual, environmental, occupational, intellectual, and physical—and the goals associated with each, became the central theme on which the community's transformation was based."²⁸

Images: Perkins Eastman Architects

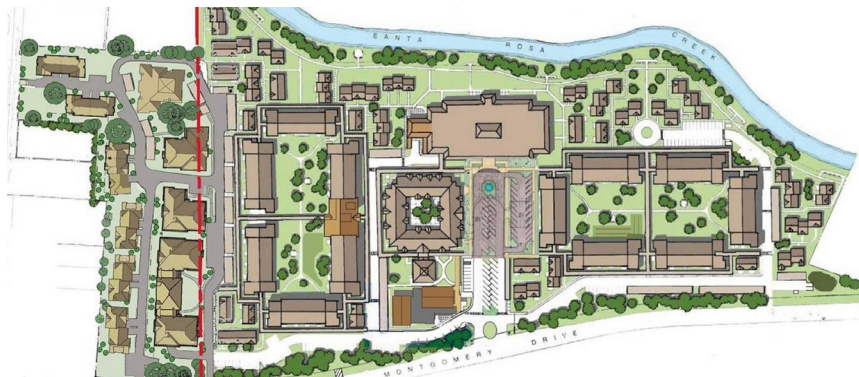

STEINFELD RETIREMENT AND NURSING CENTER

The Steinfeld Retirement and Nursing Center designed by Dietger Wissounig Architekten, is located in Steinfeld, Austria. The building was conceived in accordance with the concept of low-energy houses, and its two-story wooden facade was inspired by the environment and its residents' roots. The timber framed building which emerges from a concrete base adopted rural, regional construction techniques. The strategic location of windows reveals the layout for the viewer, and suggests the introvert-extrovert nature of residential units of the building.

The building hosts a covered courtyard which functions as a three tiered winter garden, and forms a space for social interaction. The courtyard also filters natural light along the corridors on its perimeter. This courtyard, an example of introversion, is complemented by the extroversion of the terraces and verandas that form the center's other community spaces. Steinfeld Retirement and Nursing Center is also shared by the neighbouring school, day visitors to the area contributing to the home's integration into the local community.

"The most important thing about this building, however, is the high standard of living for its residents achieved through the intelligent interaction of public and private, and interior and exterior."³⁰

Images: Archello, Dietger Wissounig Architekten



PRECEDENT: STOCKHOLM, SWEDEN

SLIVIABO

SilviaBo, a housing project on the outskirts of Stockholm, Sweden, is a collaborative effort between IKEA, Skanska, and Silviahemmet, a dementia-care foundation established by Queen Silvia of Sweden. This project is a response to the country's aging population and demand for assisted living units, focuses on accommodating those who are 55 years and older.

The concept for SilviaBo was adapted from IKEA and Skanska's existing housing development - BoKlok. Internationally recognized BoKlok has about 11,000 living units across Sweden, Finland and Norway. Built from prefabricated wooden components that are assembled on the side, these houses can vary from two to four stories with combinations of one or two bedroom apartments.

Adapting the principles of BoKlok, SilviaBo incorporates its key features with wider entrances, minimal thresholds, and building automation. The modularity of the architecture enables the inhabitants to stay in their own space even if they develop serious complications in later stages of life.

"Wellbeing and social interaction will also form a key part of SilviaBo. IKEA envisages the housing incorporating a number of community facilities like a "village green" and a clubhouse complete with barbecues and pergolas."⁴⁰

Images: Dezeen, Ikea



PRECEDENT: GENSLER RESEARCH INSTITUTE

BOOMTOWN

In 2019, the Gensler Research Institute developed a conceptual design for evolving communities that provide opportunities and encouragement for intergenerational living. The research proposal called BoomTown, was conceived through the consideration of the communities of MacArthur Park in Los Angeles, California and Ivy City in Washington D.C.

BoomTown is a community model that integrates smart design and holistic planning features into senior living spaces. The model first recognizes Naturally Occurring Retirement Communities (NORCs), and then augments them with urban mixed-use planning elements, sustainable design measures and opportunities for strengthening social bonds between all generations in the community. The research on the BoomTown prototype builds on the common interests and shared resources that connect multigenerational communities.

Gensler also recognized the importance of coordinating physical, social, policy and community factors. It is crucial to consciously build relationships between community members to create networks that are typically informal, voluntary and reciprocal because such networks lead to sustainable community development. The resulting social architecture and environment aligns individual and communal interests, and experiences by addressing the challenges, needs and opportunities for the wellbeing of the community and its residents.

Image: Gensler Research Institute



“The idea of developing a new vision of community life—a BoomTown that would reflect the independent, health-centered customized lives that Boomers live.” Lee Lindahl. According to the Gensler Research Institute, achieving the goal of Boomtown’s “ageless living” requires the following essential elements:

1. Mixed-use convenience: The provision of quick and easy access to retail, transportation, healthcare and nightlife.³⁶
2. Tech-enabled service delivery: App-based access to everything from healthcare to everyday services like dry cleaning and grocery delivery.³⁶
3. Wellness-focused: The incorporation of community gardens, walking trails, fitness centers and targeted wellness services from acupuncturists and massage therapists to counsellors.³⁶
4. Activity-centered: The availability of co-working spaces, maker spaces, and incubator offices promoting small business development and entrepreneurship, as well as flexible spaces for community gatherings and other interests.³⁶
5. Design-conscious: The implementation of universal design principles that seamlessly integrate adaptability and ease of use into all aspects of the built environment.³⁶
6. Smart development: The prioritization of reusing and repurposing existing building stock to ensure the preservation of existing community aesthetics and to foreground the importance of sustainability.³⁶

Image: Gensler Research Institute

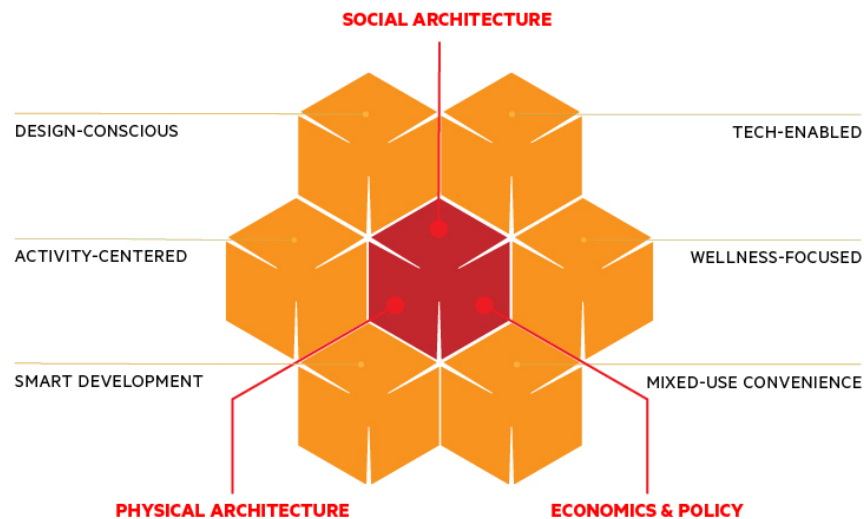



Image: City of Slayton



SECTION THREE:

COMMUNITY ENGAGEMENT

THIS SECTION DOCUMENTS COMMUNITY PARTICIPATION AND INPUT GIVEN BY COMMUNITY MEMBERS IN TWO MEETINGS HELD VIRTUALLY ON ZOOM IN JULY AND AUGUST 2020. ALSO DOCUMENTED ARE KEY INPUTS FROM THE COMMUNITY AND THE SURVEY RESULTS CONDUCTED BY THE SOUTHWEST REGIONAL DEVELOPMENT COMMISSION.



OPERATION PRAIRIE VENTURE

SLAYTON · MINNESOTA

Intergenerational Living Center

Operation Prairie Venture in collaboration with the University of Minnesota’s Southwest Regional Sustainable Development Partnerships and the Center for Sustainable Building Research, College of Design is engaged in proposing a master plan for the ‘Operation Prairie Venture Intergenerational Living Center’ a quality living and thriving neighborhood environment that connects with intergenerational community members and amenities in the region. Using the agency of architectural design process the project aims to leverage and connect existing socio-cultural assets and promote physical, social, intellectual, emotional, occupational, spiritual and environmental wellbeing for the residents of Slayton and surrounding communities that will live in and use the facilities. We invite your perspective and input to the design process and project development.

Our mission is to build innovative services and spaces for older adults that enable all generations to live and thrive in a vibrant community.

Please join us for a Operation Prairie Venture Intergenerational Living Center Virtual Community Input Session!

Community Input Session 1

Date: Thursday, 23 July, 2020

Time: 9:00 AM to 10:30 AM

Location: <https://umn.zoom.us/j/93824876587>



Evolution of Main Street

Southwest Regional Sustainable Development Partnership

UNIVERSITY OF MINNESOTA
EXTENSION

Center for Urban and Regional Affairs (CURA)

UNIVERSITY OF MINNESOTA
Driven to Discover™

COLLEGE OF DESIGN

UNIVERSITY OF MINNESOTA



Center for Sustainable Building Research

COMMUNITY INPUT SESSION 1

The first community meeting engaged community members in exploring the scope and parameters of the project.

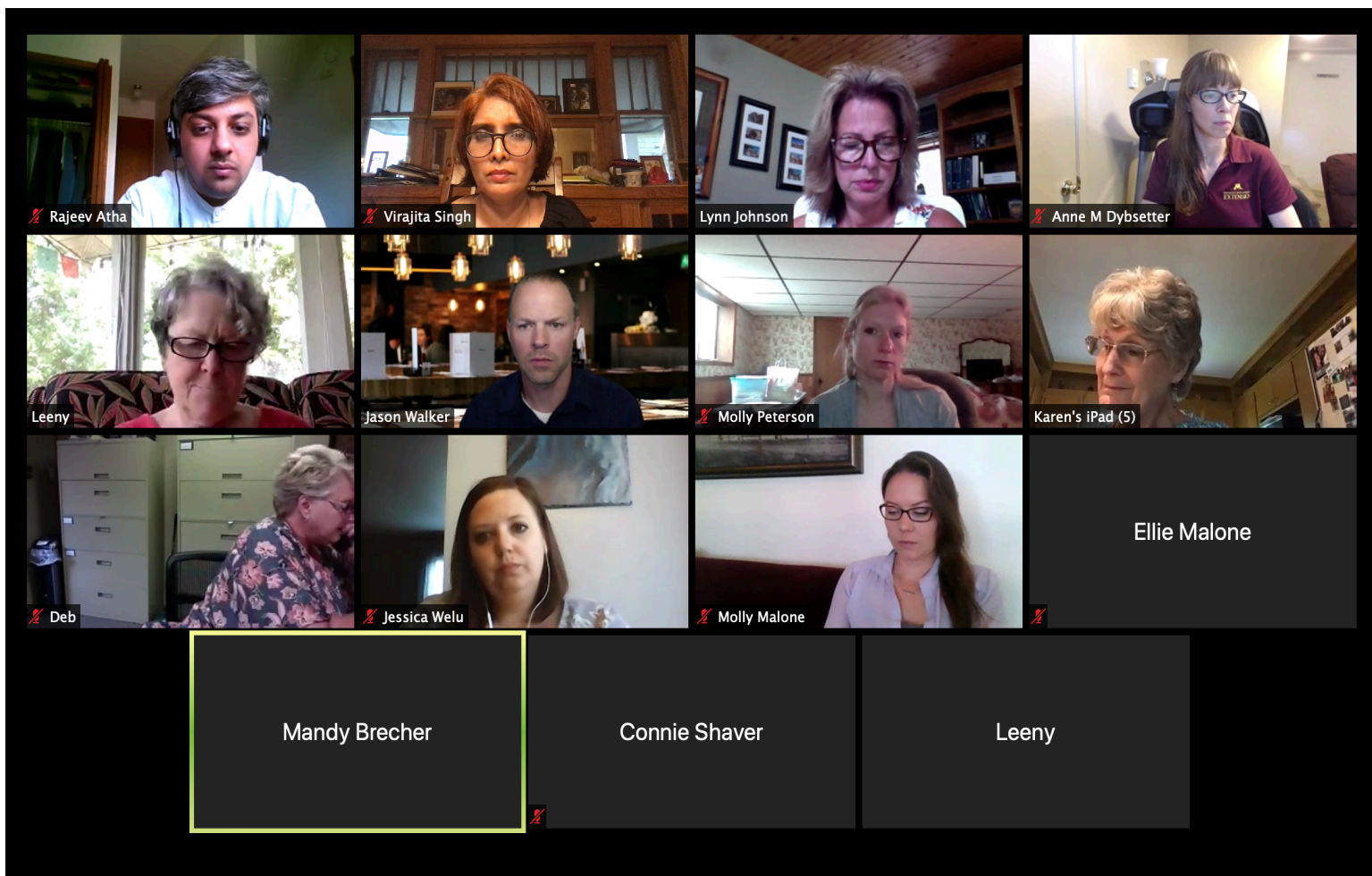

Virtual Community Input Session 1, Zoom, 23 July 2020

What is **Intergenerational**?

Existing or occurring between generations.
The thread connecting different age spectrums of a society.
A building that serves the evolving needs of the society.

The demand by seniors to not be called "seniors" is not one of vanity. It is one of realism. With life expectancy rising and health levels improving, the traditional notion of a "senior" is no longer relevant.



Physical

Social

Emotional

Intellectual

Occupational

Spiritual

Environmental

Neighborhood that connects generations which remains timeless.



What kind of living situation do you envision as you age?

Where would you like to move?

What comes to your mind on hearing the term "Intergenerational Village"?

Why would you like to move to an Intergenerational Village?



Above: Slides from the presentation of Community Engagement Input Session 2, 13 August 2020

COMMUNITY INPUT SESSION 2

The second community meeting engaged community members for their input to design precedents, typologies and prototypes.

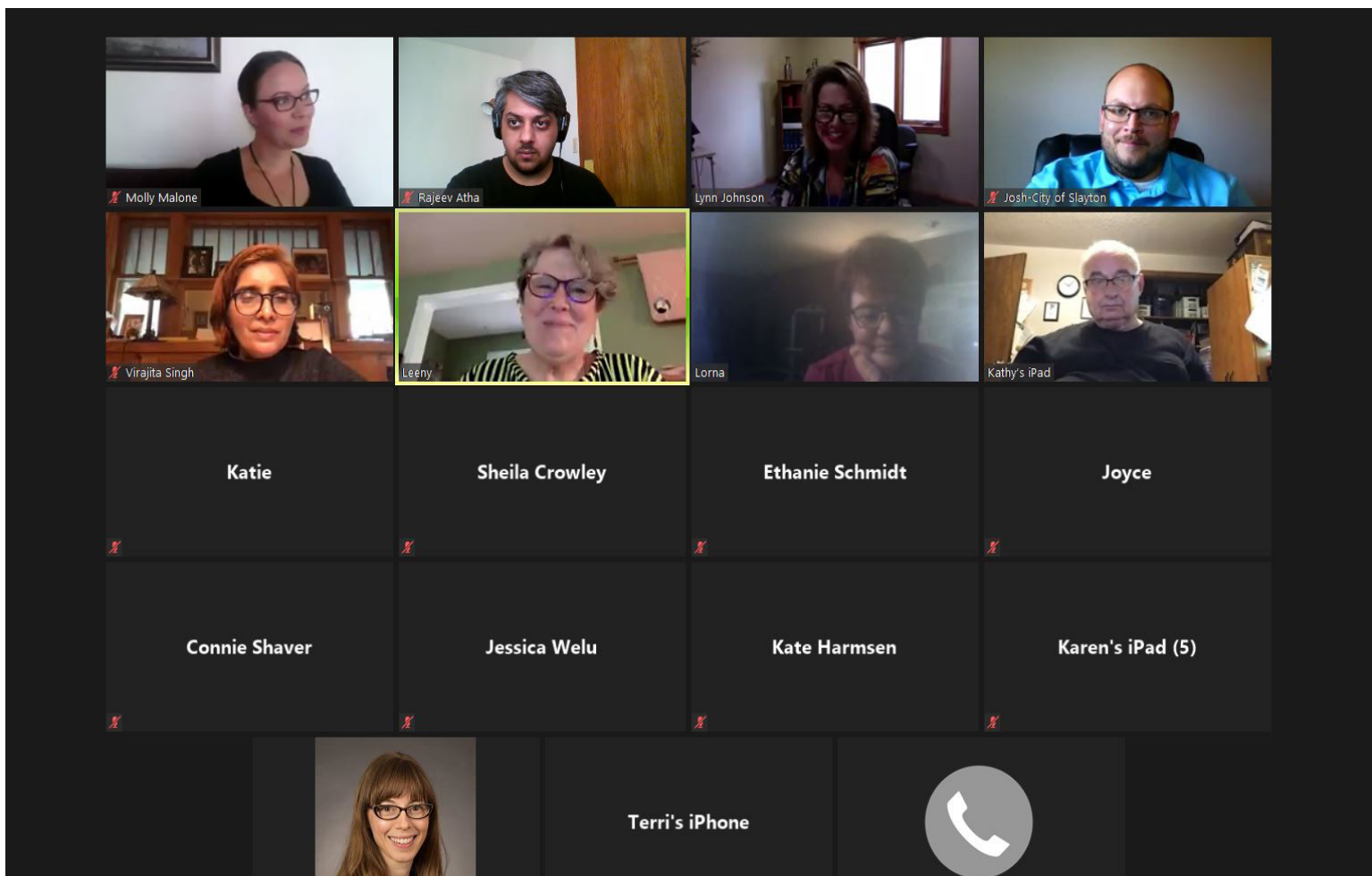

Virtual Community Input Session 1, Zoom, 13 August 2020

What Services for Older Adults are Missing or Need Improvement?

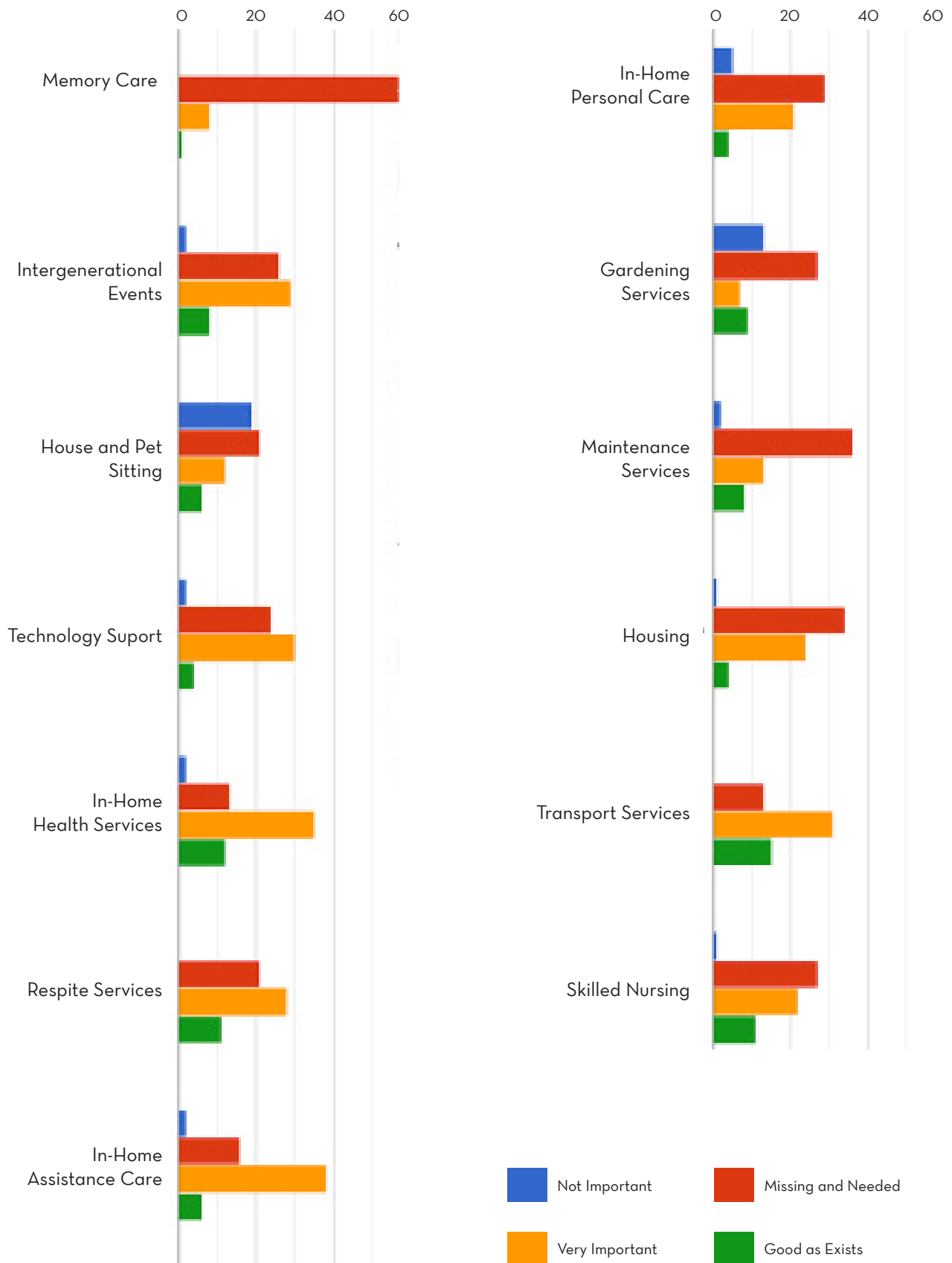

SURVEY RESULTS

A survey conducted by the Southwest Regional Development Commission, in collaboration with Operation Prairie Venture was launched in early July 2020. As of August 2020, 82 responses were recorded. The results of the survey were synthesized by the following questions:

1. What services for older adults are missing or need improvement?
2. What types of building projects should the Intergenerational Village and Operation Prairie Venture pursue?
3. What comments do you have about service needs for older adult?
4. How has the closure of the Slayton Rehabilitation and Healthcare Center impacted you, your family and/or your community?
5. What comments do you have about housing needs for older adults in the Slayton area?

These comments are presented as written and represent the views of respondents.

What comments do you have about service needs for older adult?

- "Definitely there is a need for additional housing for the elderly. Independent, congregate and assisted living are needed, as there are waiting lists on these types of housing that are within our county. We need assisted living that offers higher level of care also and also will accept insulin dependent diabetics. Memory Care housing is a need. Memory care units within a 60 mile radius of Slayton have waiting lists. Additional services for home care are also needed. There is no home care within a 30 mile radius that offers daily services to Murray County residents to help, for example, with getting dressed, applying support stockings, providing medication compliance reminders from pill caddies, just to name a few. These services aren't billable to Medicare or other insurances. Home Care is very expensive for the services provided. Nursing home placement is also getting more difficult, especially for those that need quite a bit of care or have memory deficits due to the staffing shortages in the nursing homes where they aren't able to meet the needs requested and refuse the admission. These are just a few of the priority needs that I see."
- "Nothing has been done for seniors who want to downsize their living. Moving out of our bigger homes to a smaller, one level condo or apt complex. Even assistant living to nursing home. Look at Fulda!!"
- "While there are many services available through Hospice of Murray County and the Murray County Medical Center, more options are always welcome. Home care for the "day to day" needs of people who are otherwise able to function independently would be very helpful, I suspect."
- "There are so many older adults in Murray Co & most of these services are welcome. I am 91 years and in my own home and when the time comes I still want to stay in the Slayton area."
- "Housing for all stages of the elderly. Assisted and independent living housing. The residents cares to be met with compassion and tenderness."

What Types of Building Projects Should the Intergenerational Village and Operation Prairie Venture Pursue?

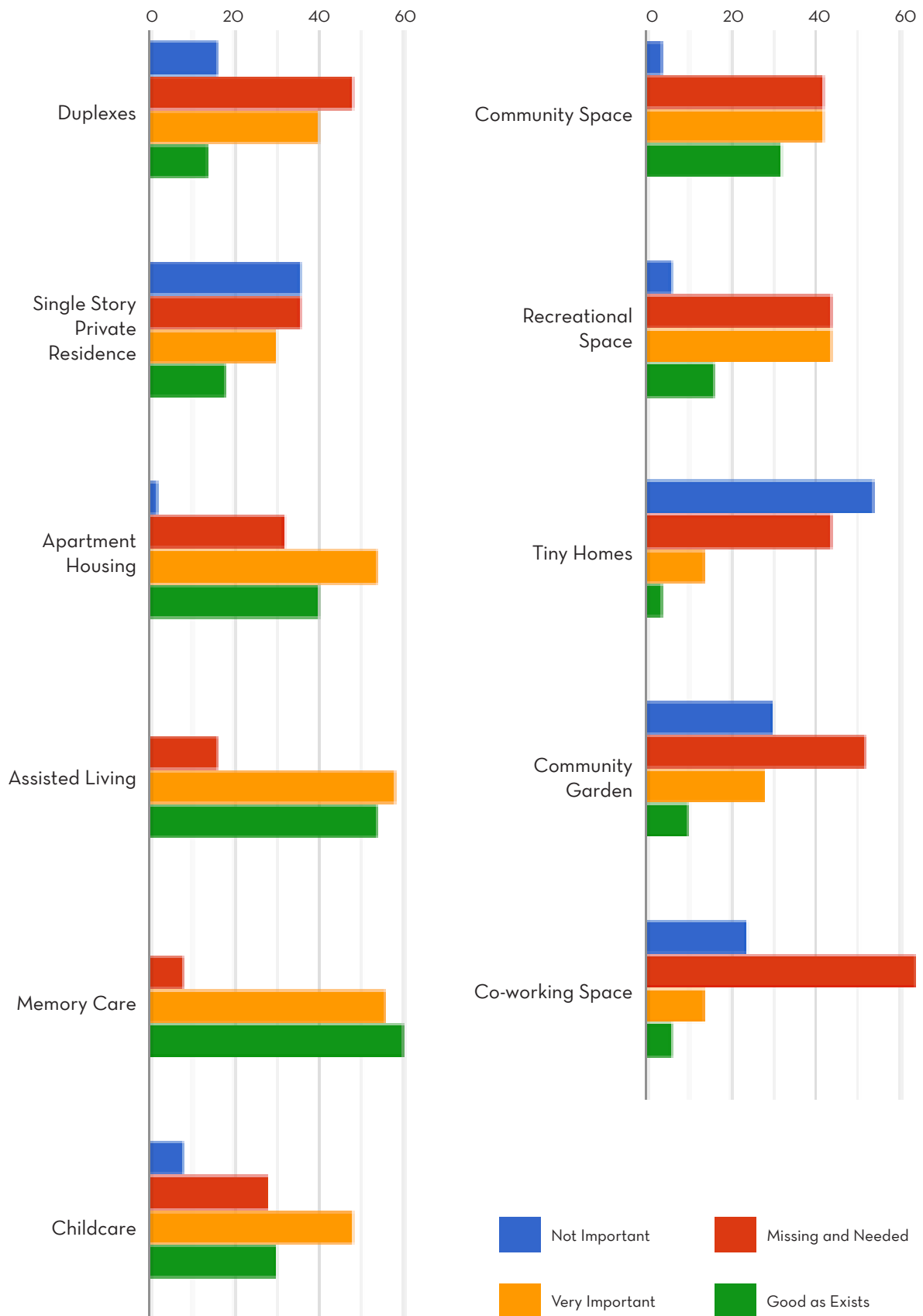

SURVEY RESULTS

Need a home for dementia and Alzheimers.”

- “I always thought I’d have a place to go if I could not drive & when my eye sight gets bad, I’d like to stay at home if I could’t handle it myself I’d have a place to go.”

How has the closure of the Slayton Rehabilitation and Healthcare Center impacted you, your family and/or your community?

- “Most of the community is elderly and their children aren’t around to help and the constant turnover at the hospital and lack of community knowledge/awareness of the issues, doesn’t do anything to keep medical professionals around. Even lack of knowledge from law enforcement during the flooding and blizzards has put people at risk, so why would anyone stay in a community like that? People need to stop having their safety compromised just because they’re elderly.”
- “For us it would be that if we need nursing care, we would need to move out of town.”
- “Family needs to place loved ones farther away. Volunteers have less opportunities. Jobs lost.”
- “Had to put loved one in Worthington. Now we need to travel to see her and her friends don’t visit. Not able to stop in for a quick visit.”
- “Brother in law had to seek services outside the county, causing a hardship for his wife and greater distances to travel to see him. Lost jobs impacted friends. Liked having the option in Slayton available as I age (now 61).”
- “I am a pastor. I now have to travel at least 20 minutes to get to the nearest nursing/retirement home to visit my members who can no longer live in their homes. I suspect some of my members are living in their homes when they should have skilled care or assisted living because they don’t want to move away from the community.”
- “I was hoping it would be here for my mother, who is living by herself, and doing well, but has health issues. She is 89.”
- “Both of my elderly parents resided at the slayton rehabilitation center one or more times. Our community needs that service ... for the patients and their families. And, it’s sooo hard to see that building and site sitting there empty with no activity.”
- “The closing has forced families to place ones in location NOT easily accessible due to traveling distances. Having the center in Slayton allowed friends and relatives the opportunity to visit. The closing has contributed to a sense of isolation not only among the elderly but family as well. There is a sense of betrayal because family had to move their loved ones away from the familiar to the scary and unknown (places and people who are unfamiliar and the environment not as family orientated as Slayton was)”
- “Impact to me was so hard to see that someone had the ability to come and evict residents that have lived there for years and felt comfortable with the people around them and the care they were receiving. Community - it ripped the area apart as people moved away to find employment, along

with loved ones being pulled away from the people that would see them regularly. It is like pushing the ones away from home to send them to another town. So very sad.”

- “Someone in my family was there when it closed and came home, which was too soon making it difficult for the care giver.”
- “It certainly helped make the decision to probably leave the community if & when that time comes. One only guesses what one will need.”
- “My mother had to leave town and be placed in a different nursing home. The limit frequency of visitors has been hard on her. Loss of jobs for our community is always a negative.”
- “I have lost touch with many senior members of the community because they moved out of town, and of course, COVID has only made it worse. I hope they have all found new people in their lives, none of them were my relatives.”
- “I worked at the facility for about 10 years before and after it was sold to a large corporation and saw the effectiveness of a community run nursing facility. Having local control over a senior living makes it a much friendlier and responsive atmosphere.”
- “Friends & family that were near cannot visit/see their relatives after the closure without traveling longer distances. With COVID in the picture at this time they can’t visit their relatives at all.”
- “My grandpa was in the nursing home when it closed. He was able to be at home for several months afterward but coordinating in-home services seemed to be a challenge.”
- “There’s a sadness among people. Relatives, family members and friends have been displaced to all parts of the state. Slayton is their home.”
- “We lost friends to other communities, other than that it didn’t affect our family much.”
- “I work for the SeniorLinkAge Line in Slayton and have seen first hand the devastation that is caused by family members that were in LTC needing to go to other communities. Very sad for consumers and family to be separated or moved from their community that has always been home.”

What comments do you have about housing needs for older adults in the Slayton area?

- “Kids aren’t sticking around so something needs to be in place to help. Need more things available in winter months so elderly don’t just sit around. Most of the adult population is elderly so why not spend a bit more money on their needs. Have kids do gardening or pet sitting to get them active in summer months. Get some of the gardening kits where elderly can garden from their wheelchair so they are active.”
- “Very necessary to have more accessible housing for seniors”
- “It is an eyesore in the community It has certainly impacted families even though not use personally”
- “There is definitely a need for affordable housing for seniors. Assisted

SURVEY RESULTS

living and memory care units may be difficult to staff due to demands of the staff and the wages.”

- “There is limited housing for older adults that need add'l healthcare services.”
- “There are lists of up to 20 or more waiting to secure housing in Slayton senior housing so we need to look in other towns if we need to move. Some of us have lived here all our lives and would like to stay in our “golden” years. Slayton has done well to provide for its youth, i.e., swimming pool, summer rec., library, excellent school programs, churches provide youth programs also.”
- “The housing needs continue to increase each year. If older people are to continue to live in Slayton we need housing. Nice twin homes are missing. Duplexes are missing. More assisted living space is needed. I have been looking in other communities that do have this housing but prefer to stay in Slayton.”
- “We need a nursing home”
- “More opportunities beyond assisted living needed”
- “Needed. We are a retirement community. We want to stay in Slayton, but will want to downsize into a duplex or townhome eventually. Not available now.”
- “I really want our elders to be able to stay in the local community when living alone becomes untenable.”
- “There is a great need for condos or town houses. Many elderly live in homes with a yard to take care of + it gets to be too much work. Possibly with two bedrooms + no steps + garages”
- “Why aren’t we making better use of what is there? I believe that Sunrise Terrace has many vacancies but not sure if that is correct. Also, is Lindenwood full?”
- “Housing for older adults that cannot take care by themselves is needed.”
- “getting more important for aging and vulnerable people”
- “I am not an older adult. But from what I have heard from that community, there are many that are looking to move out of the large homes they raised their families in for decades. They want single level, maybe two to three bedroom rentals. Or they are willing to move into areas that are senior living with the option for assisted living.”
- “Older adults who are healthy are looking for smaller, independent living with less upkeep. Addressing this would also open up housing market for others.”
- “Assisted living, nursing home with memory care wing are all needed”
- “We need to have a stronger memory care unit and nursing home.”
- “People are interested in a transition place, where they can give up the whole property care, and stay locally where family and friends that they have grown to know can still stop in and have conversations with them till the end of their life. Those local people are familiar faces.”
- “Assisted Living is the best place for an adult who can take care of themselves but not take care of their own home.”

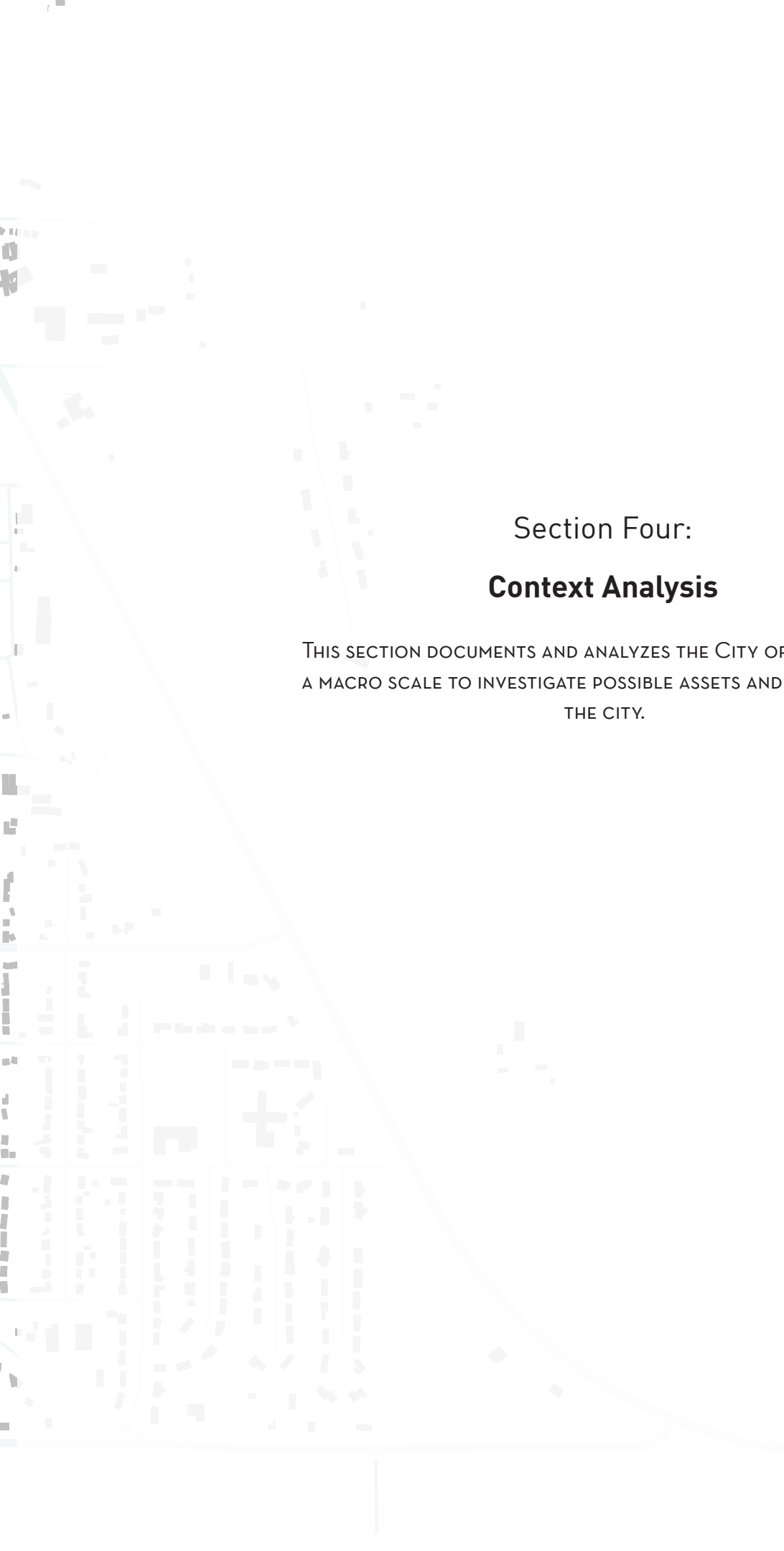

Image: Tim Middagh, DGlobe.com, Slayton begins work on community mural

SURVEY RESULTS

- "A big need for assistant living as well as housing for those who have memory lost."
- "If not for the hospitals and wonderful care they give then graduate to physical therapy, it all would come more quickly to leave more the area."
- "I could also see a child care facility of some sort in the same area so seniors could at least be volunteers and help even if not staff at a child care facility."
- "There are many of us who will need to downsize! Very important for our community."
- "I believe what the Golden Living Center did was wrong. Unfortunately, people who have lived here all their lives had to move to other areas. I think we, as a community, need to help seniors in our area."
- "it would be a great benefit to Slayton and Murray County"
- "Sad that older adults need to leave Slayton for NH care. Sad for families that have to have their loved ones in other communities."





Section Four:
Context Analysis

THIS SECTION DOCUMENTS AND ANALYZES THE CITY OF SLAYTON ON A MACRO SCALE TO INVESTIGATE POSSIBLE ASSETS AND NETWORKS IN THE CITY.

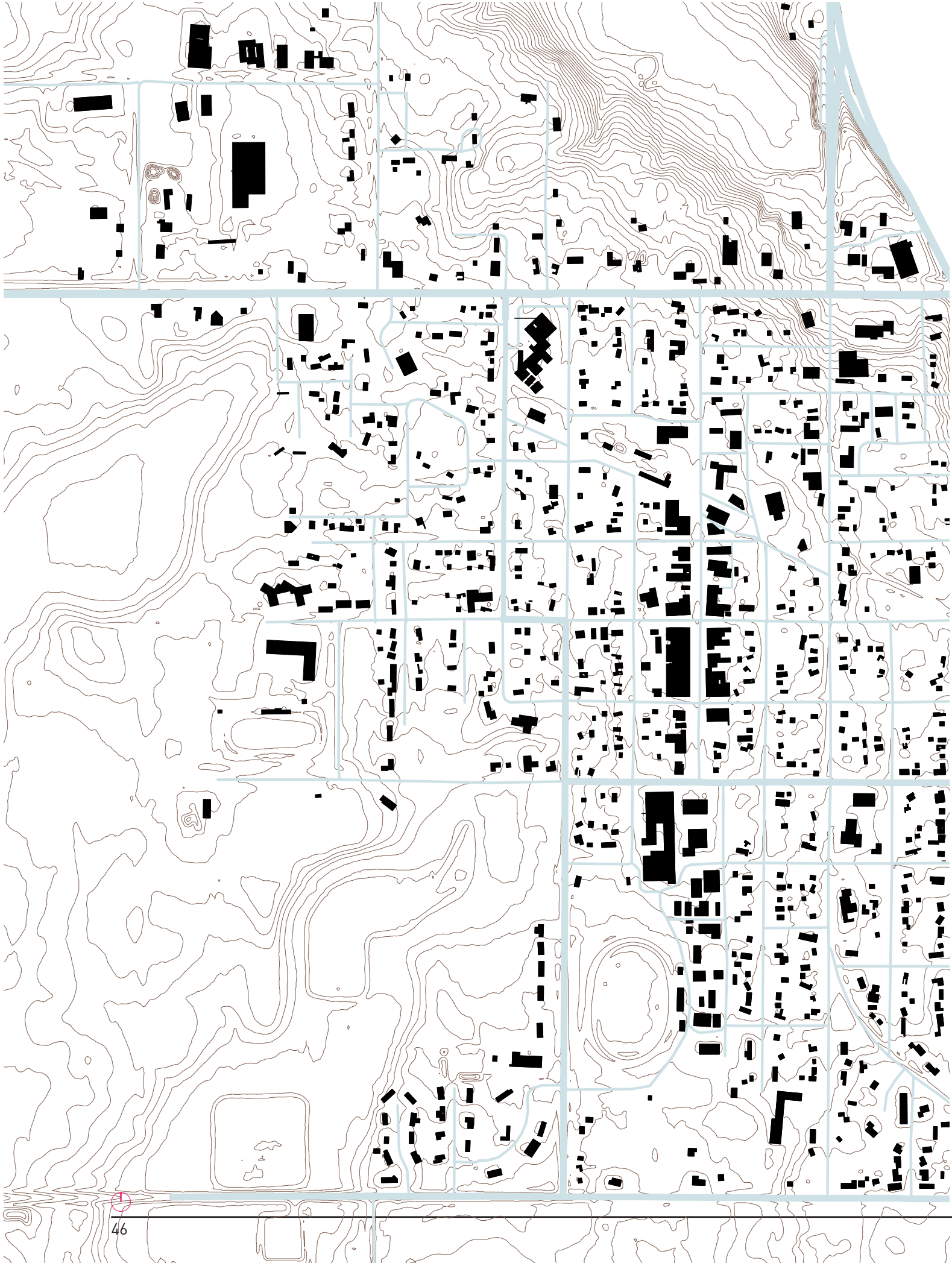

CITY STREET AND BUILDINGS LAYOUT

Analyzing the street and building layouts in Slayton was a critical step in the design process. A typical city residential block in Slayton measures at 150 ft. by 450 ft. To designate a walkability score, a Slayton block was compared to Portland, Oregon and Sacramento, California, which are considered best and least walkable cities respectively. Slayton fared in the middle of the spectrum and was designated an averagely walkable city.

The street layout shows the locations of buildings in Slayton and the open spaces around them. Main Street is compact with buildings while the residential buildings are scarcely spread throughout neighborhood blocks and the city. It also includes the topography of the city, which shows that Slayton is fairly flat with occasional gentle slopes.

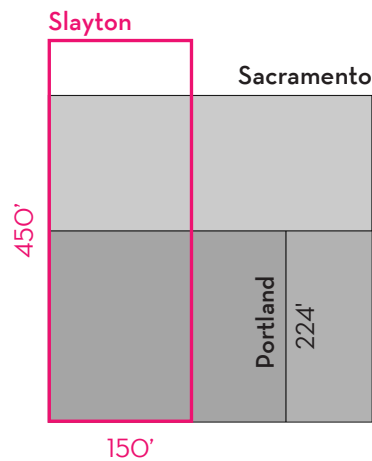
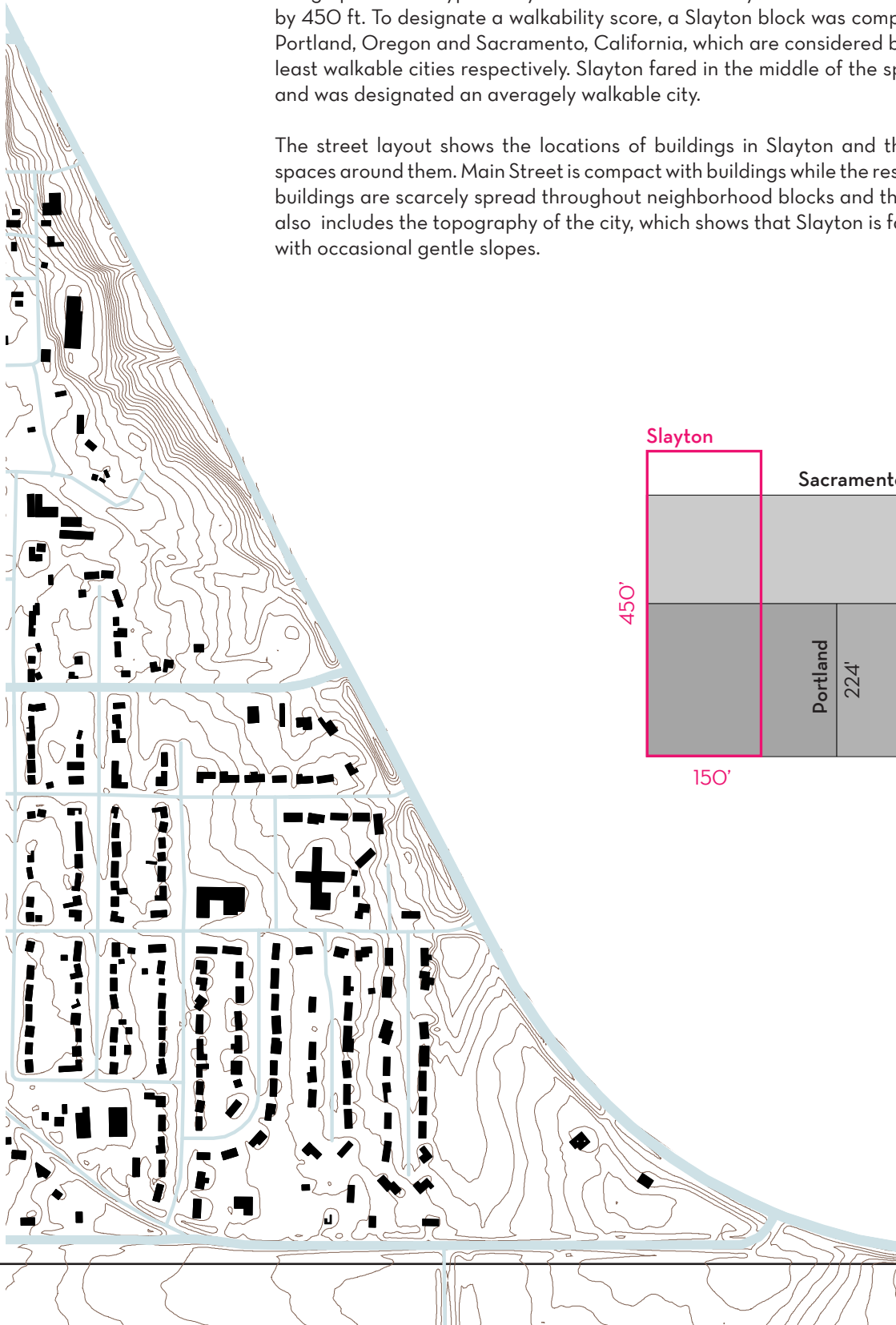



LAND USE MAP

The land use map superimposed on the street and building layout of the city reveals the function of Slayton's buildings. The map illustrates the importance of Main Street which acts as the city's spine and commercial corridor. Residential and institutional spaces radiate from Main Street while industries exist on the city's fringe.

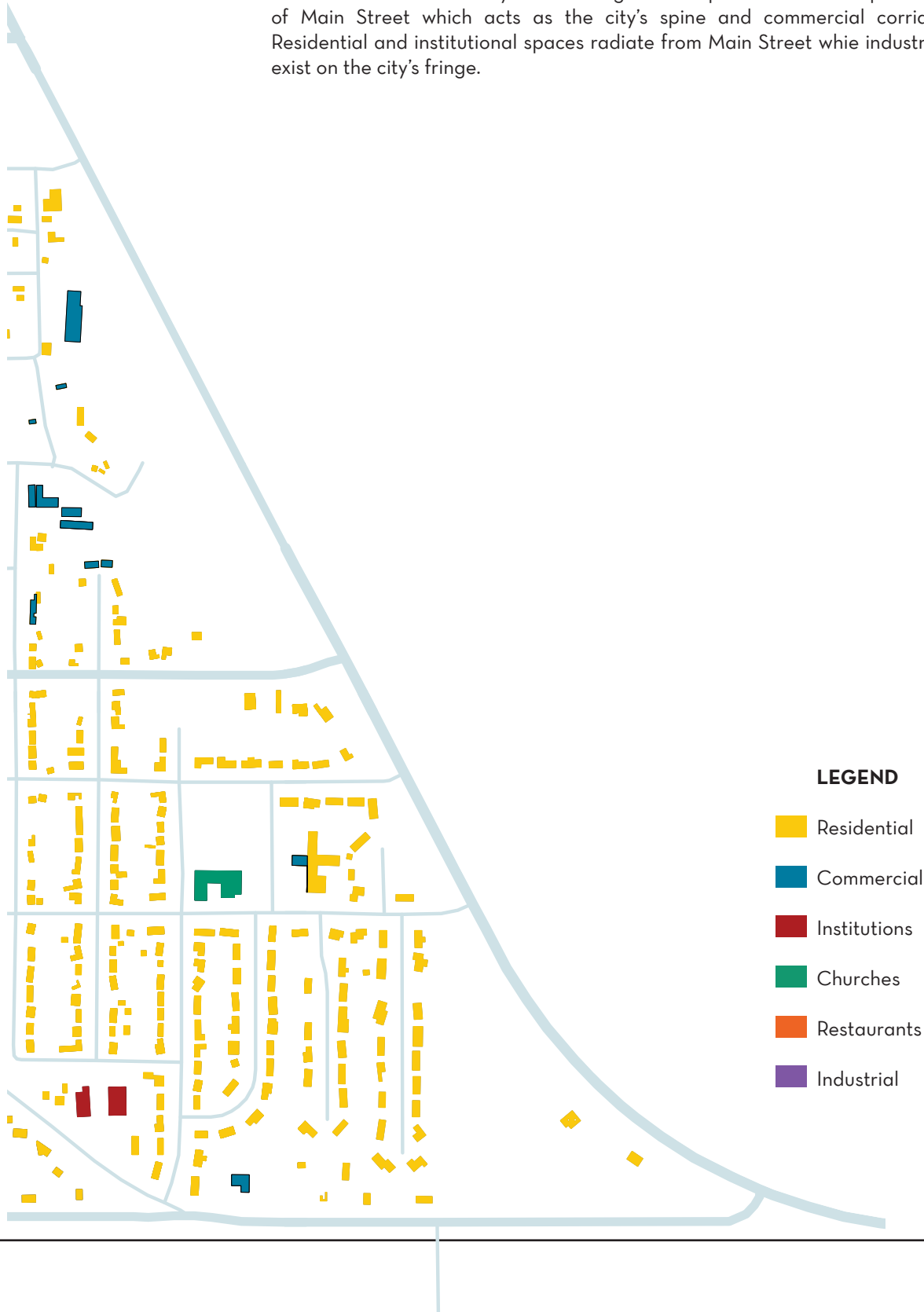

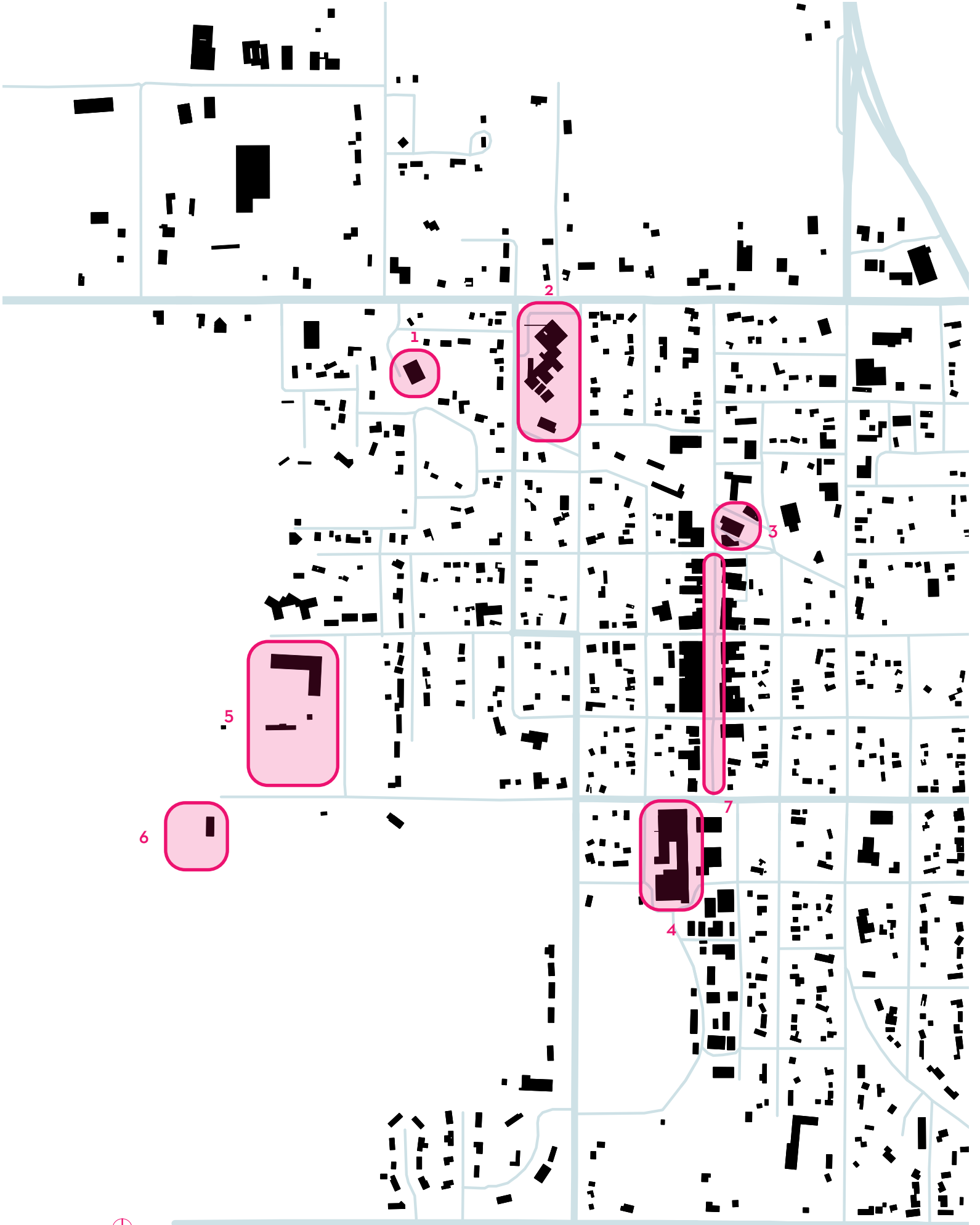

ASSETS

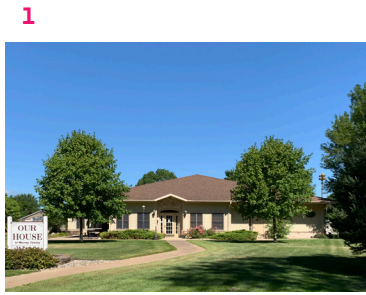

Hospice of Murray County, Connie Shaver



Murray County Medical Center, LakenWoods.com



Slayton Public Library, LakenWoods.com



Murray County Central High School, Connie Shaver



West Elementary School, Connie Shaver



Slaytona, LakenWoods.com



Main Street, Slayton, Connie Shaver



Main Street, Slayton, DGlobe.com

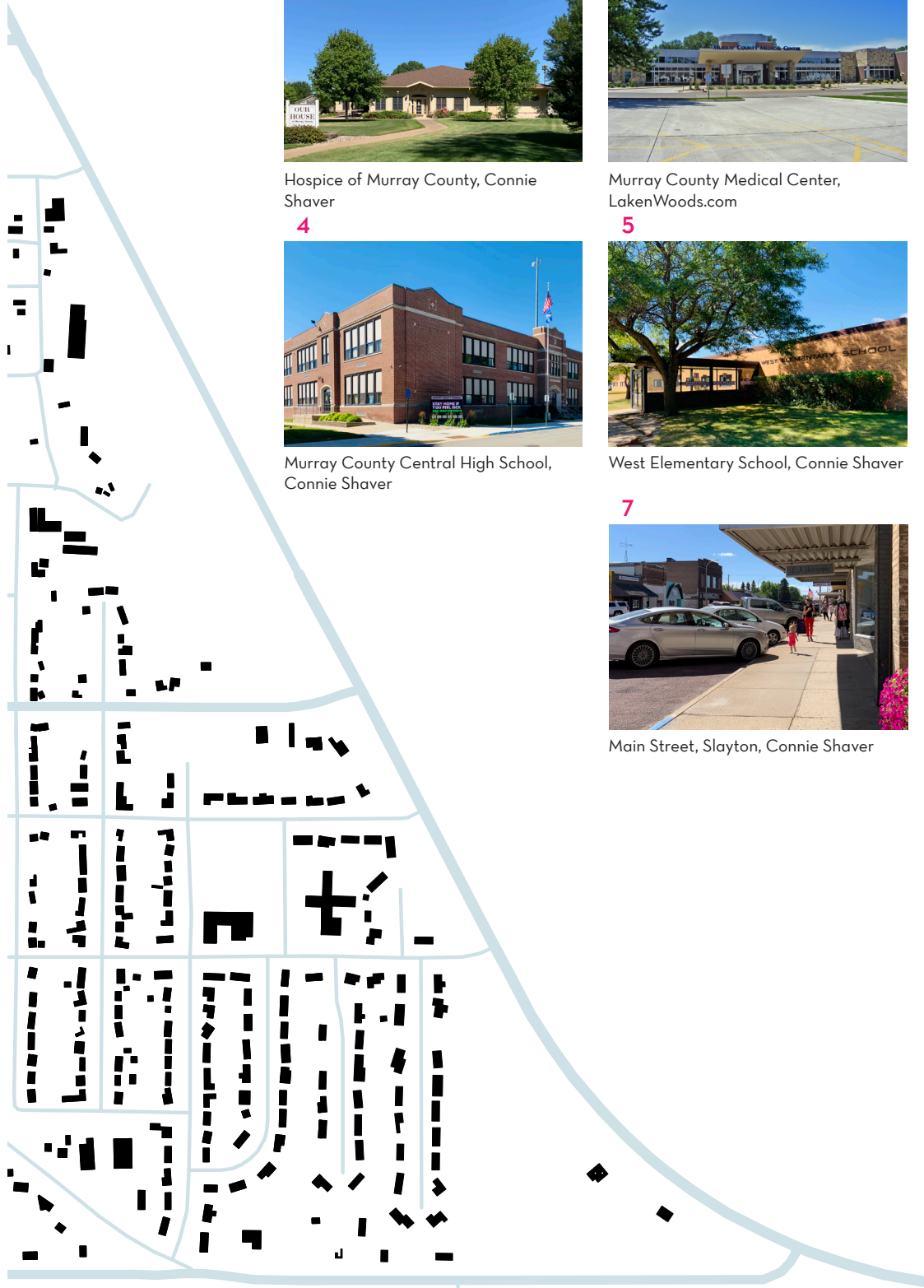

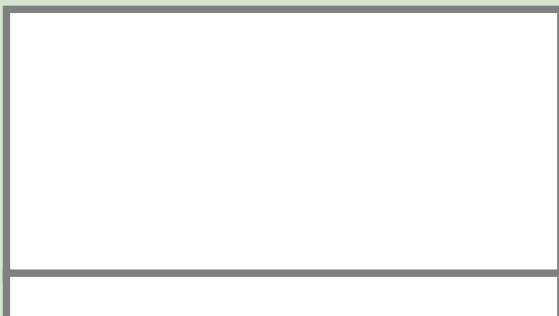
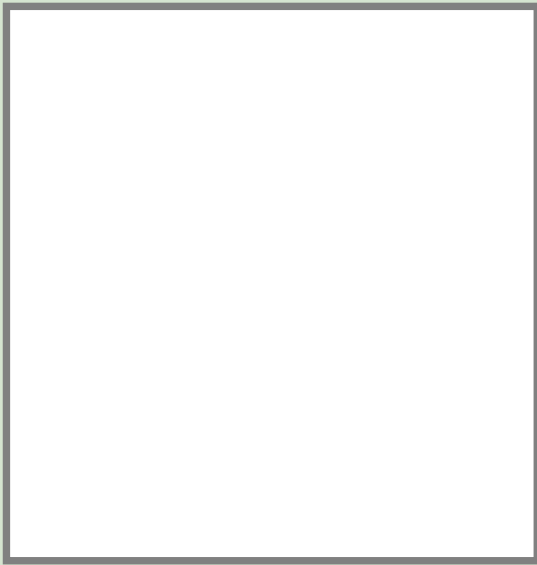
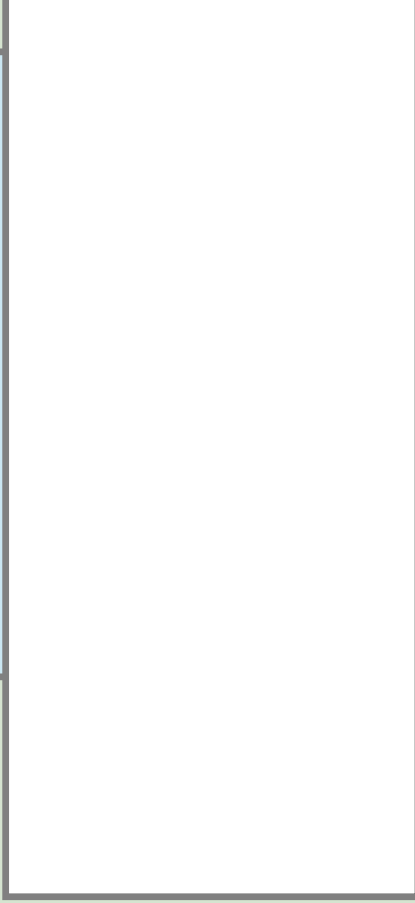
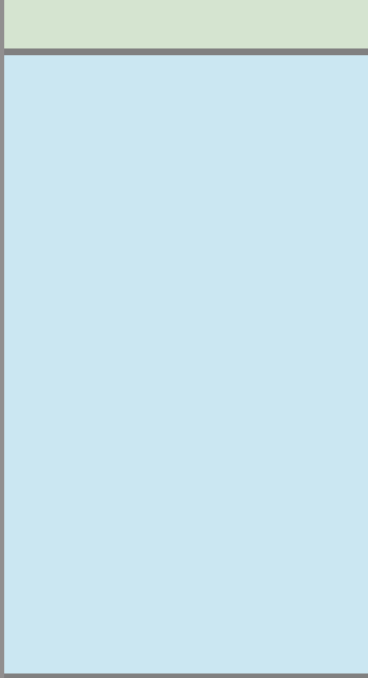
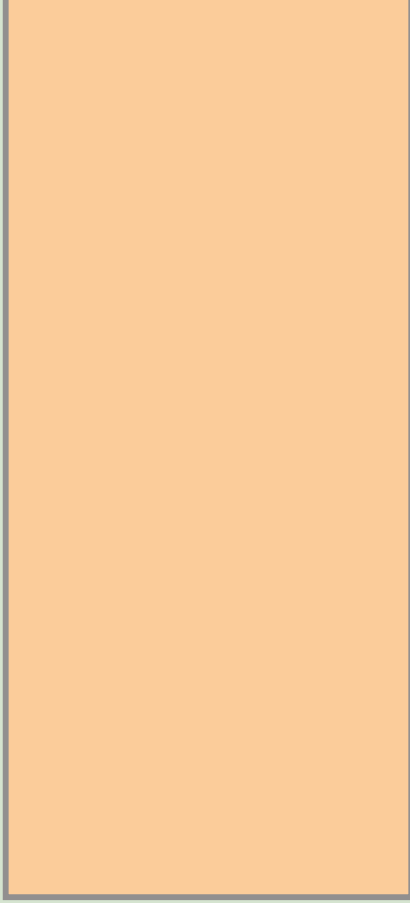

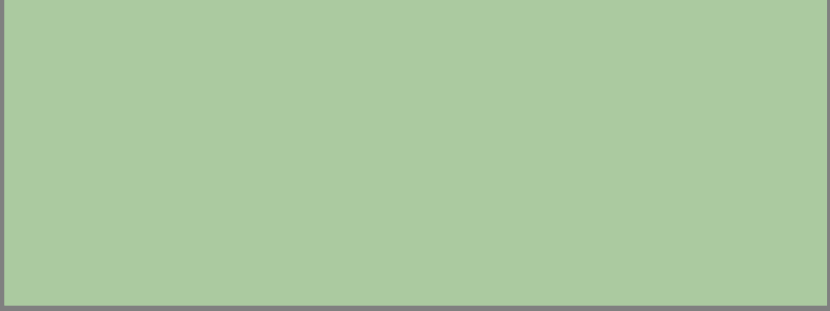

Section Five:

Design

THIS SECTION DOCUMENTS DESIGN APPROACH, DESIGN CONSIDERATIONS, DESIGN PROTOTYPES, PHASING OF THE PROJECT AND DESIGN RECOMMENDATIONS FOR THE FUTURE.

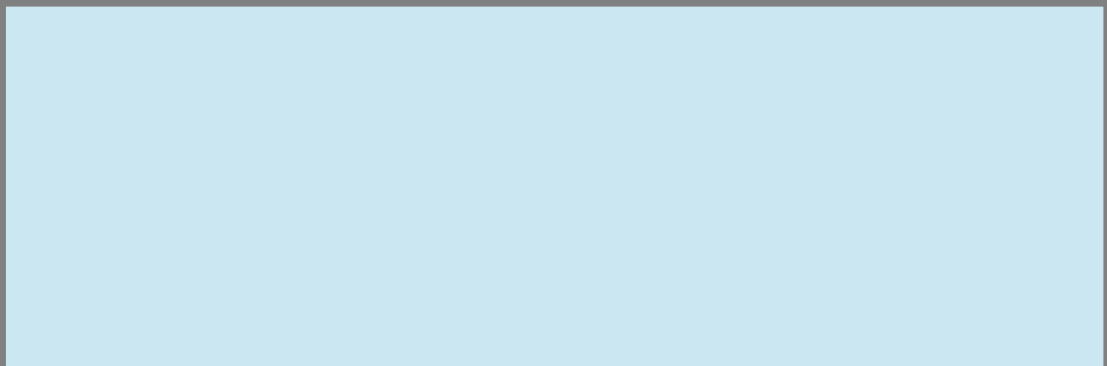
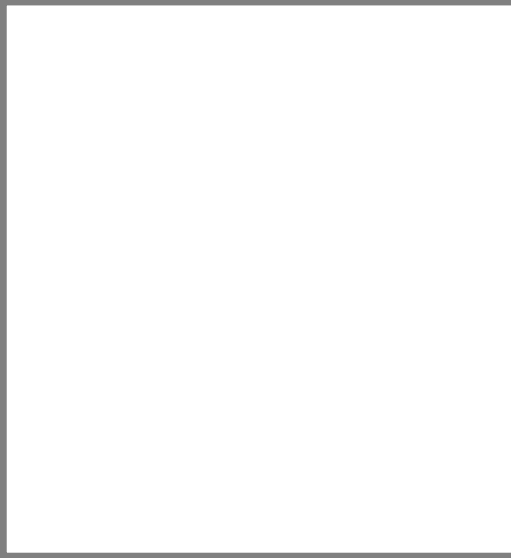



Image: Google Maps

DESIGN APPROACH

This design project was conceptualized through literature and precedent research, the project context and the design brief. The design for the Intergenerational Village takes a four step design approach with design considerations, provision for a kit of parts, neighborhood prototypes with phasing of the project and design recommendations for the future design and expansion.

The Intergenerational Village formulated design considerations for architectural interventions inspired by the literature, precedent research and intermittent community interactions. This framework was then used to create a “kit of parts” providing the community with housing units to be calibrated according to the community’s current and future needs. In addition to the kit of parts, the community also receives proposed prototypes for neighborhood designs and future design recommendations.

The Intergenerational Village design is a parametric framework and can be adopted by the community to satisfy Slayton’s current and future requirements with flexibility and adaptability of Slayton’s urban environment and architecture.

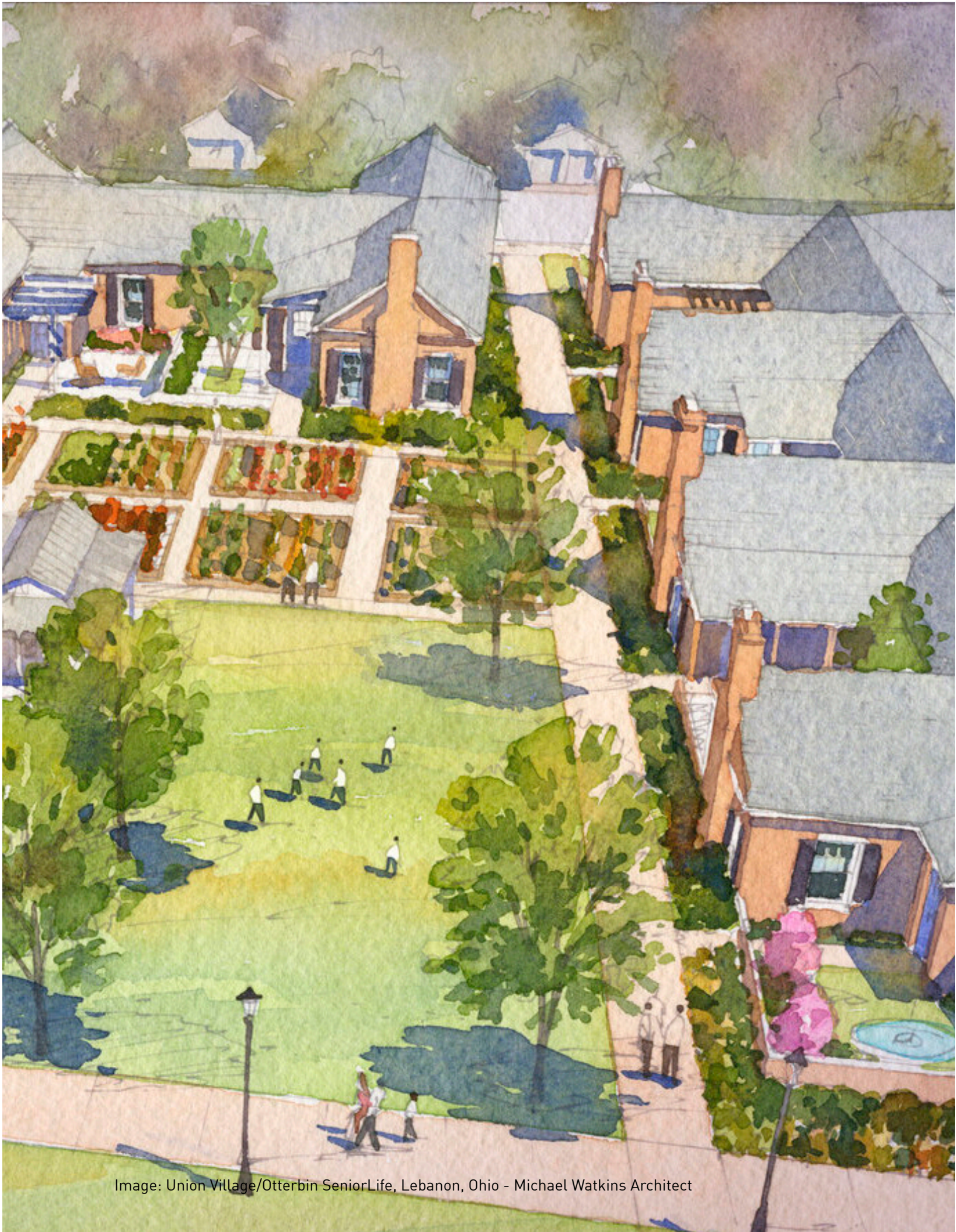

Image: Union Village/Otterbin SeniorLife, Lebanon, Ohio - Michael Watkins Architect

DESIGN CONSIDERATIONS

Design considerations aim to address the physical, social, emotional, intellectual, occupational, spiritual and environmental wellbeing of the residents of the Intergenerational Village through architectural design interventions.

THE SEVEN ELEMENTS OF THE INTERGENERATIONAL VILLAGE

Physical

Architectural elements in the Intergenerational Village design physical well-being through active design strategies such as strategic juxtaposition of the buildings to increase exercise, walking and movement. Active design strategies also promote the use of staircases and ramps and contribute to the resident's physical wellbeing.

In addition to making use of active architectural design, the Intergenerational Village design provides a space for the community to host fitness programs. This creates an environment for intergenerational interaction while also serving the larger community.

Social

The Intergenerational Village design promotes social wellbeing through elements that increase interaction within the village and with the community around it. For instance, to reflect Slayton's interest in and reliance on farming, the design incorporates community gardens in the form of greenhouses. The greenhouse is a perennial element and provides residents comfort during winter, while also hosting a weekly farmer's market throughout the year.

The weekly farmer's market celebrates Slayton's long lasting farming community. The inclusive attribute of the farmer's market invites the participation of local grocery and other retailers in Slayton. The market adds to the existing social infrastructure of the city by hosting weekly festivities.

Emotional

To promote emotional well-being on an intergenerational scale, it is essential to break barriers between generations. The Intergenerational Village design enhances the possibility for interactions between generations by envisioning residents engaged in programs focused on childcare, hobby development, and collaboration of elementary and high school students with youth enrichment and education programs. The design also fosters residential well-being through its association with the Murray County Medical Center and the Hospice of Murray County which will provide medical services for independent and assisted living residents.

The need for social interaction is complemented by the need for autonomy. This design resolves this paradox by providing spaces for residents that provide them with the necessary safe space for personal growth and emotional wellbeing.

Intellectual

The Intergenerational Village design fosters intellectual development of its residents and neighboring community, in part by providing co-working spaces, which serve as business incubators. These spaces, by providing opportunities for different generations to share experiences can produce mutual benefits and encourage engagement among the wider spectrum of the Intergenerational Village residents.

The design promotes intellectual development of young adults with afterschool youth enrichment and education programs providing Slayton with opportunities to encourage entrepreneurship, grow small scale industries and serve as an inspiration for youth.

Occupational

In general, the Intergenerational Village design's focus on occupational well-being seeks to retain and update occupations that may be dying out in Slayton. Because Slayton is a predominantly farming community, the occupational well-being built into the design reflects the importance of sustainable farming practices, social responsibility and the interdependence of farming and the environment. For example, the Intergenerational Village design's greenhouse offers a method for establishing innovative agribusiness practices based on the experiences of senior residents. Further, the opportunity to use the produce from the greenhouse in the Intergenerational Village's community kitchen demonstrates the possibility of fostering a farm-to-table culinary ethos.

Along with farming, the Intergenerational Village design creates opportunities for food preservation, jams, and art and crafts to aid occupational wellbeing.

Spiritual

Spirituality is an essential element in human development and aging. Late life is often a time for reflecting on our lives and our choices, as well as reconciliation and forgiveness. Across cultures, old age tends to be a time for making peace with family, friends and perhaps even a deity. The Intergenerational Village design's focus on spiritual wellbeing attempts to preserve and nurture the rich history and culture of Slayton. Consequently, the design includes programs associated with spiritual growth such as church services, and study and prayer groups. . It also includes design elements to encourage the integration with nature and spirituality through nature trails and walks. The design offers opportunities for spiritual growth through individual contemplation and prayer as well through community services. Ideally, the Intergenerational Village will collaborate with local churches to promote the spiritual well-being for its residents.

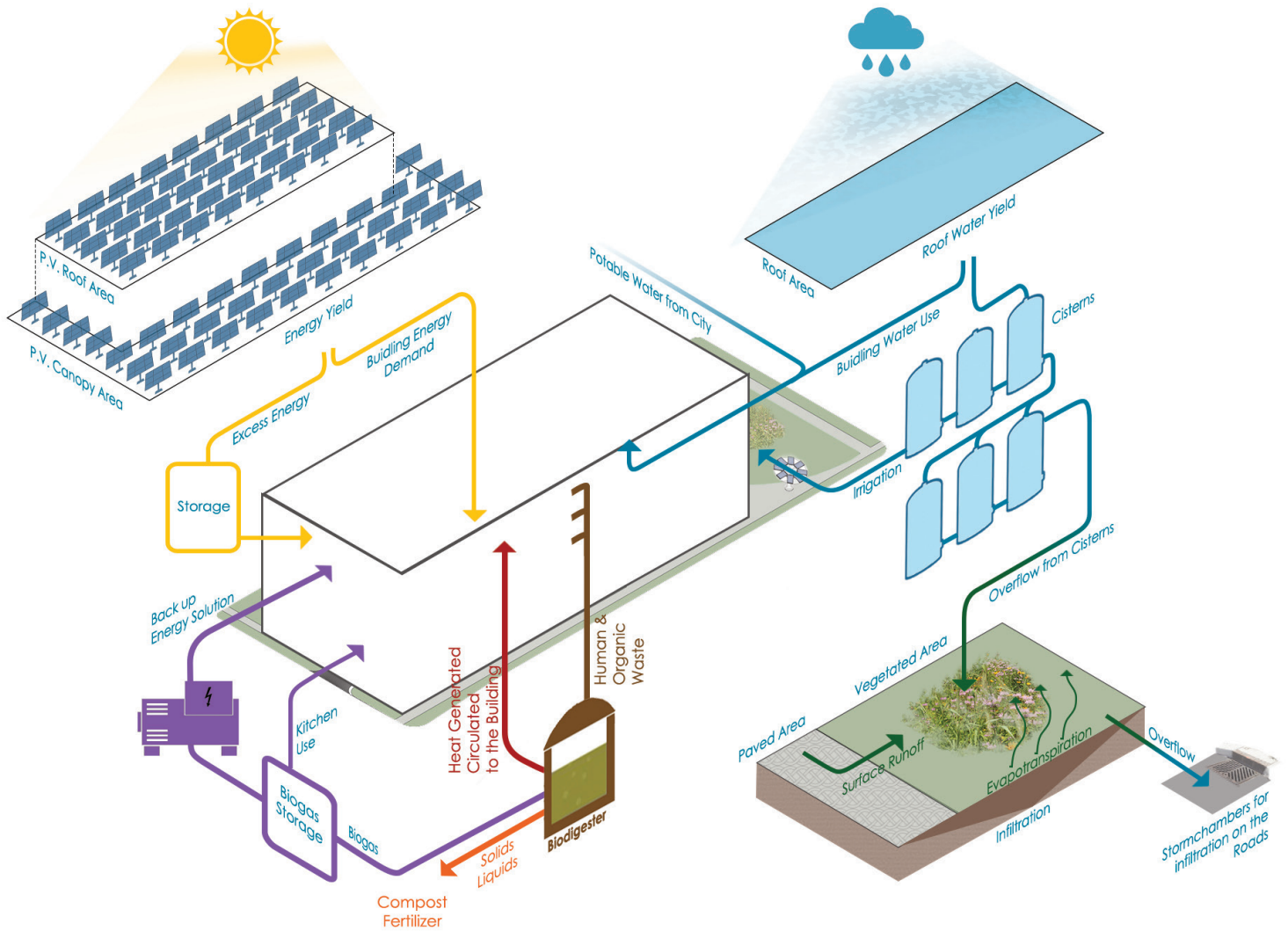

Diagram: Sustainable Design Systems

Environmental

The Intergenerational Village design incorporates social, cultural and environmental elements wellbeing to foster a resilience among its community members. Environmental wellbeing and equity are achieved through on-site energy production, active waste management systems and water conservation. Further, the design determines that selection of materials are locally sourced, and Forest Stewardship Council certified (FSC) to bring the community closer to carbon neutrality. The inclusion of food production on site also lowers the project's carbon footprint.



Image: Almshouse, London, England - Witherford Watson Mann Architects

KIT OF PARTS

The design for the Intergenerational Village includes a kit of parts that can be customized according to community need. The kit of parts include a community center or “the Village Center”, various housing typologies based on required levels of care for residents and neighborhood prototypes as design guidelines to develop it. The kit of parts empowers Intergenerational Village residents and the community to make any adaptations necessary to satisfy future needs or trends. At a city scale, the kit of parts gives the community the opportunity to design their neighborhoods in an attempt to parametric design ideology.

The levels of care and independence established for the housing typology reflect the importance of intergenerational living. In addition, the housing proposed for the project looks at three broader categories of **independent living, medium assistance living and high assistance living**. Flexibility and adaptability serve as key features, hence, at an architectural scale at least one dimension of the buildings is constant. A resident’s home has the ability to adapt itself to accommodate changes in function and need without moving the resident to a different unit. This means that an independent living unit can be transformed into a high assisted living based on the resident’s requirement.

The neighborhood prototypes are the cohesive element binding the kit of parts to create the Intergenerational Village. These prototypes also answer the question of project phasing, and provide an opportunity for future expansion. The design provides recommendations and guidelines as a set of suggestions for future development to complement the kit of parts and the neighborhood prototypes.

VILLAGE CENTER

The program designed for the Intergenerational Village Center is listed below:

1. A welcome center with administrative offices
2. Coworking Spaces, Flex Space: These spaces cater to a wider spectrum of participants for intergenerational interaction. The programs included for co-working flex spaces include a homework center, an incubator center for entrepreneurship, space for hobby development, space for book clubs along with wood and metal workshops.
3. A Community Dining Hall: The dining hall primarily serves the Intergenerational Village residents and the children attending the day care center. It consists of a community kitchen and a community refrigerator as a part of a food exchange program. Local cafes can be invited to make use of the space as an offline outlet.
4. An Assisted Living Satellite Clinic: The medical space at the Village Center consists of assisted living rooms, a nursing station, examination rooms for doctors appointments, and a safe space for mental health consultancy.
5. A Daycare Center providing childcare services and playrooms for children.
6. A Farmer’s Market Space.
7. Community Gardens, Greenhouse.

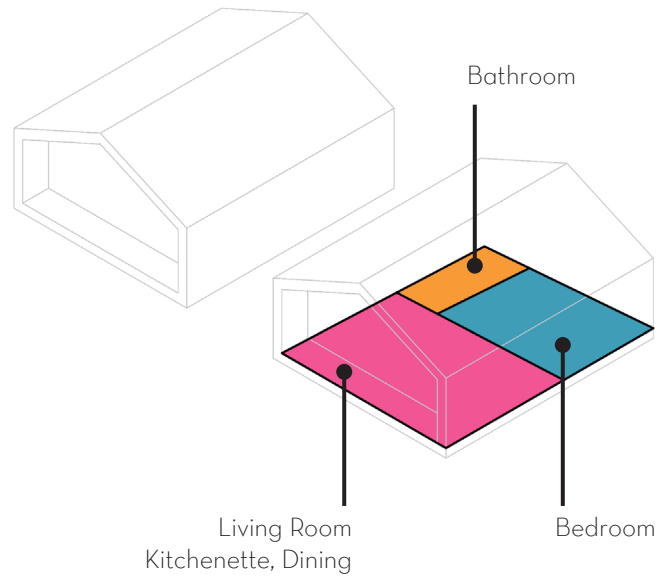
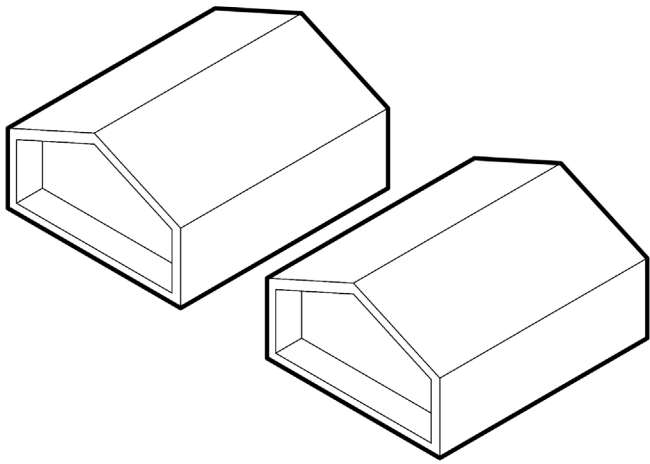

Independence Unit: Single Family Cabin

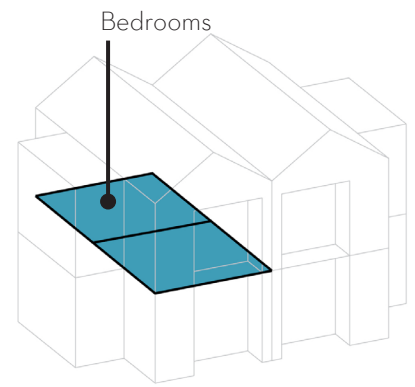
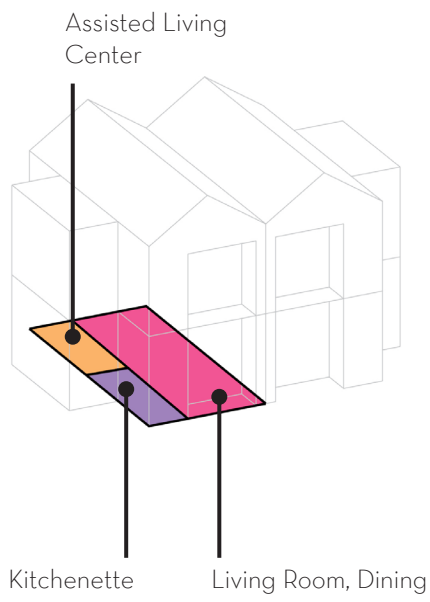
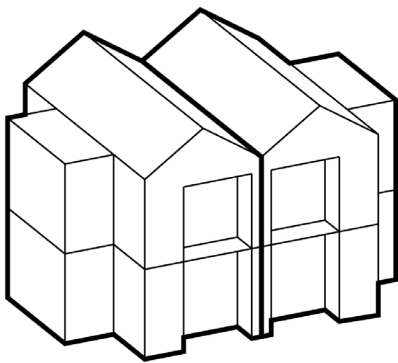

Independence Unit: Single Family Cabin

KIT OF PARTS: HOUSING UNITS

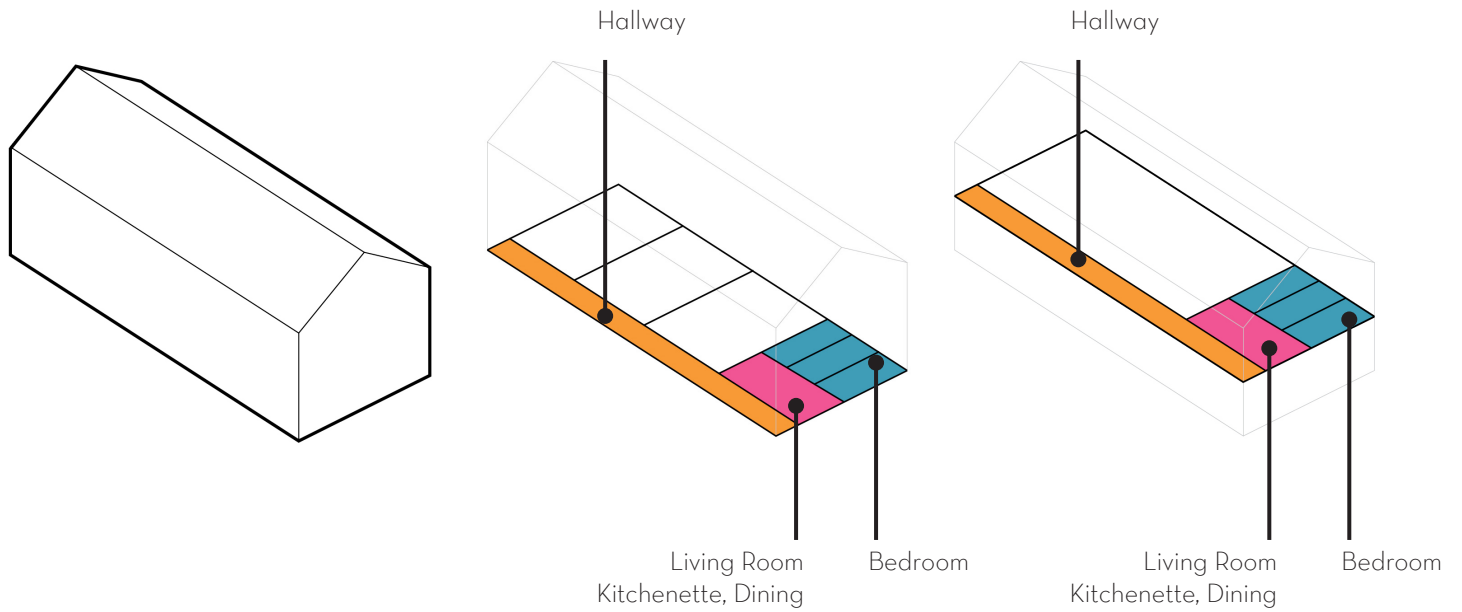

Medium-High Assistance Unit: Apartment Housing

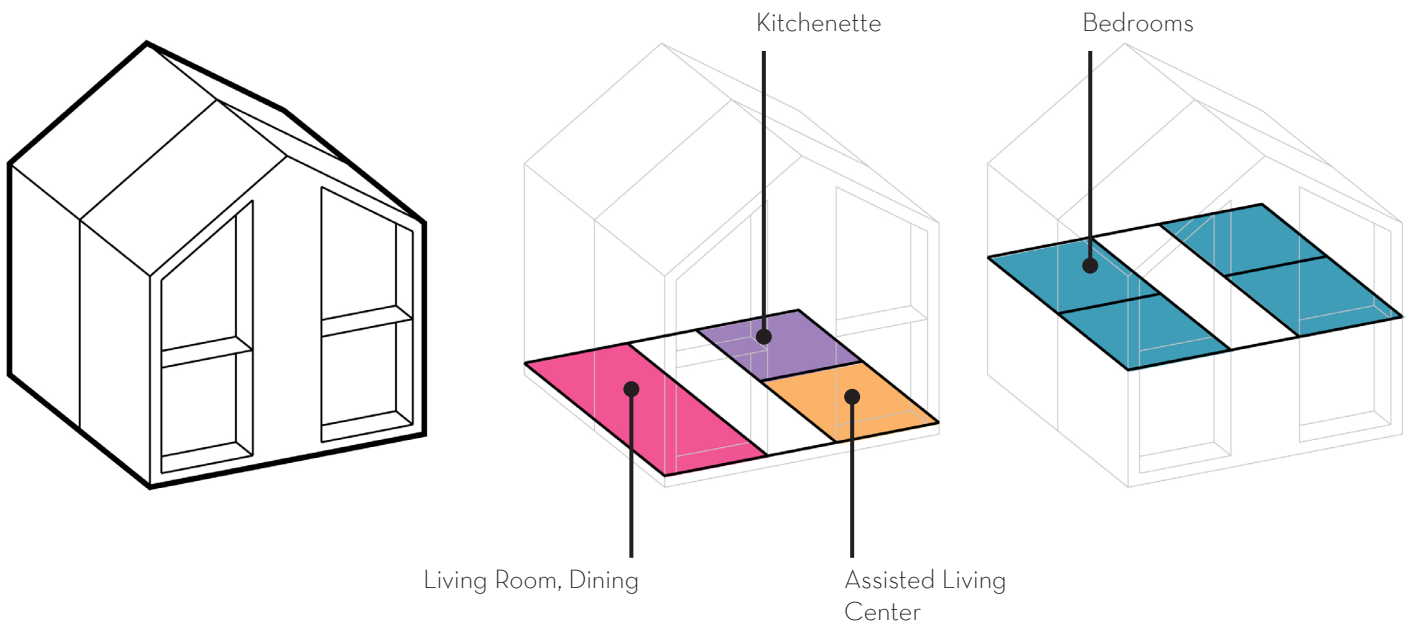

High Assistance Unit: Care Homes

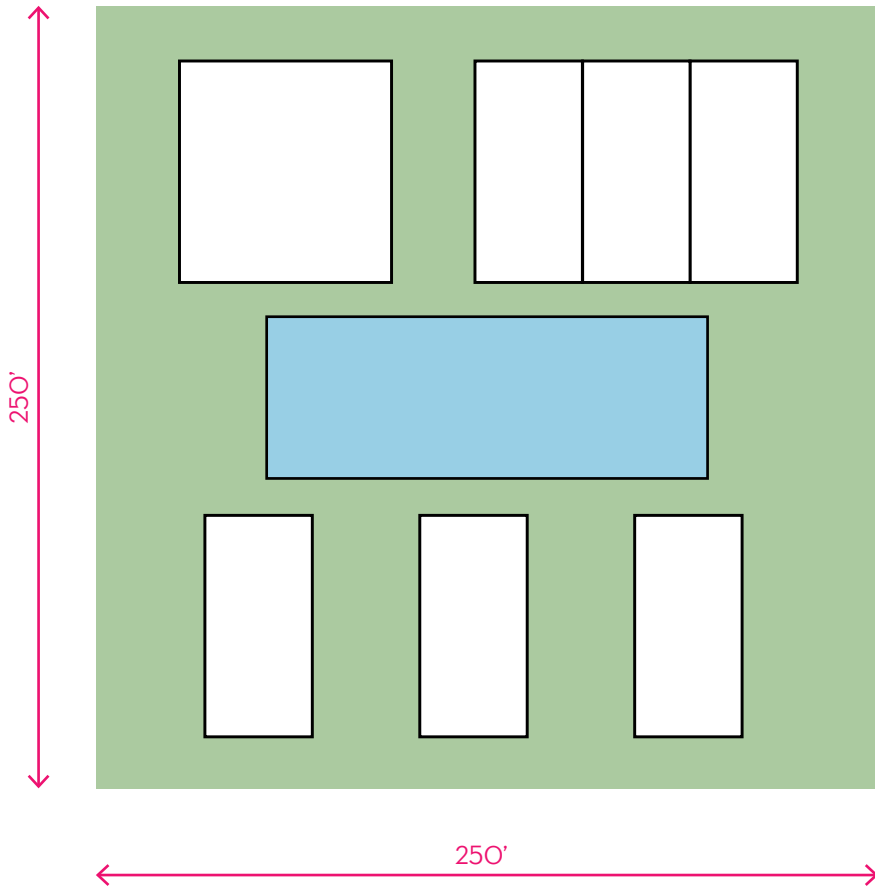
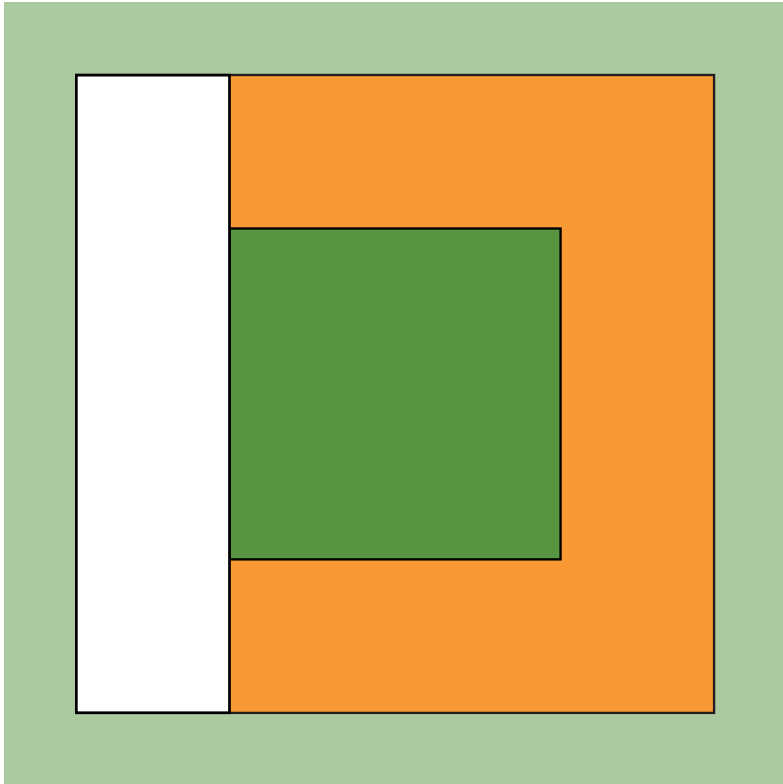

NEIGHBORHOOD PROTOTYPE ONE : PERIMETER BLOCKS

The Perimeter Blocks prototype evolved from the perimeter blocks of Barcelona and Paris. The concept was developed around the paradox between and the balance among what is known as introvert and extrovert architecture. The perimeter blocks have an introverted courtyard in the surrounded by buildings at the edge of the neighborhood block. This creates an intimate personal setting in the courtyard, while the buildings take advantage of the surrounding environment due their extrovert nature.

The 250 ft. by 250 ft. Intergenerational Village neighborhood block design evolved from the walkability score derived from Portland city blocks. The established city block was then re-imagined with the concept of perimeter blocks. According to this vision, the northern perimeter block is made up of The Village Center, apartment housing and the open courtyard form. The southern perimeter block is comprised of a greenhouse courtyard with a care home, townhouses, and single family cabins around it.

The progression of the housing typologies depends on the levels of care and assistance they provide. High assistance units of apartments and care homes are closest to the Village Center to provide residents' ease of access to shared amenities; in case of an emergency assistance could swiftly reach these residents. The independent units with townhouses and single family cabins are further from the Village Center.

The design principle for the future expansion for perimeter blocks follow a 250 ft. by 250 ft footprint with the built environment at the periphery of the neighborhood block.

Village Center



Greenhouse



High Assistance Units

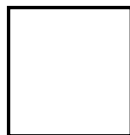

Care Home

Medium-High Assistance Units



Apartment Housing

Independence Units

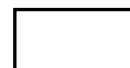

Single Family Cabins

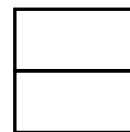

Townhouse

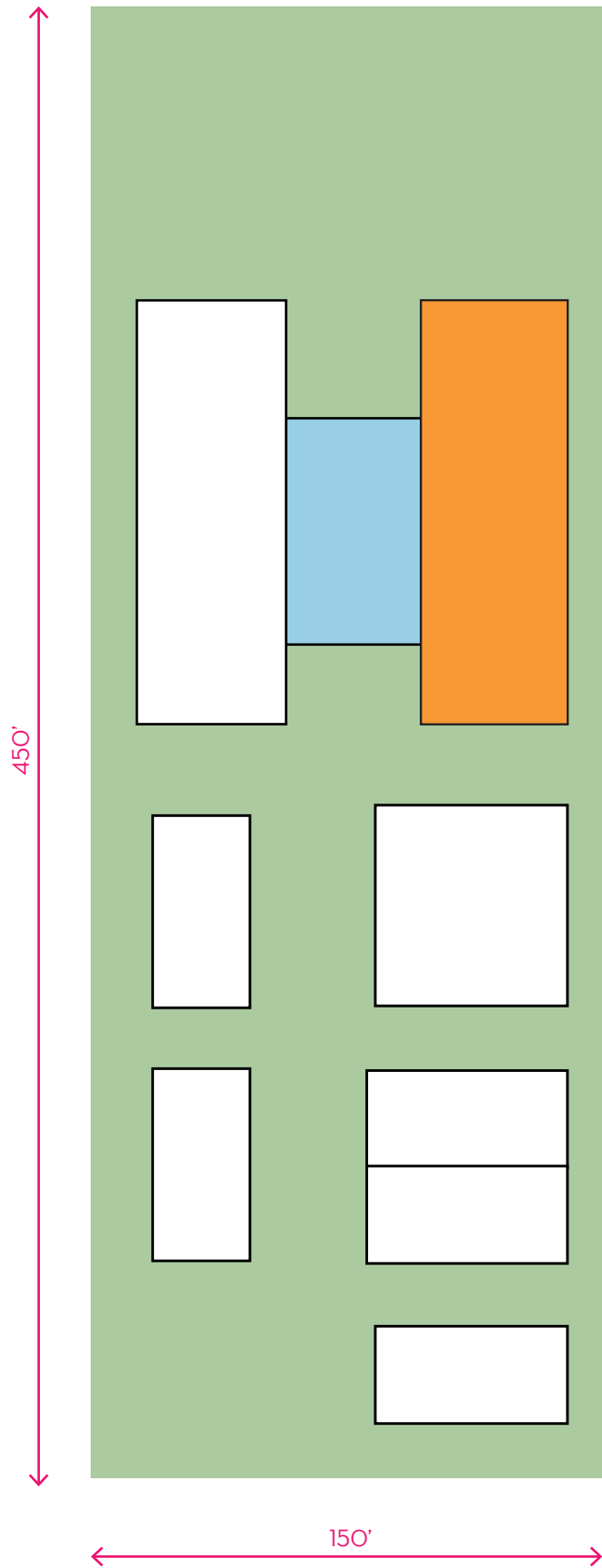

NEIGHBORHOOD PROTOTYPE TWO : GREENHOUSE COURTYARD

The Greenhouse Courtyard scheme takes the existing Slayton city block into consideration. The community's familiarity with the 150 ft. by 450 ft. block layout may help the Intergenerational Village to blend in with Slayton's existing rural fabric. In this scheme, the centrally located greenhouse becomes a courtyard between the Village Center and apartment housing. The greenhouse transitions into a green corridor to lead to the care homes, townhouses, and single-family cabin units.

The Greenhouse Courtyard provides a balance between indoor and outdoor experiences, and the greenhouse provides a perennial nature interaction for the residents.

The progression of the housing typologies depends on the levels of care and assistance they provide. High assistance units of apartments and care homes are closest to the Village Center to provide residents' ease of access to shared amenities; in case of an emergency assistance could swiftly reach these residents. The independent units with townhouses and single family cabins are further from the Village Center.

The design principles for future expansion of the Greenhouse Courtyard scheme include replication of the 150 ft by 450 ft parcel. The built environment is scattered in the neighborhood with a greenhouse that becomes a courtyard.





Image: Steinfeld Retirement and Nursing Center, Dietger Wissounig Architekten

DESIGN RECOMMENDATIONS FOR FUTURE EXPANSION

1. Develop and adopt a clear economic model and business plan for the project that takes into account guest care and economic viability.
2. Select an appropriate site for the project that offers connection to the outdoors and to local amenities.
3. Integrate social, environmental and economic aspects of the project with the design .
4. Integrate sustainable and regenerative design principles into the design.
5. Integrate regenerative and sustainable design in the RFP for architecture, landscape and planning consultant hires.
6. Gather intermittent input to the project from community stakeholders and experts.



Image: Connie Shaver

RESOURCES

LITERATURE

Designing Senior Housing for Safe Interaction during COVID 19 - Research study conducted by MASS Design Group.

1. <https://massdesigngroup.org/covidresponse>
2. <https://massdesigngroup.org/sites/default/files/multiple-file/2020-07/Designing%20Senior%20Housing%20for%20Safe%20Interaction.pdf>
3. https://www.archdaily.com/945383/mass-design-group-creates-covid-19-guide-for-senior-housing?ad_source=search&ad_medium=search_result_all

PRECEDENTS

Intergenerational Learning Center, Chicago, IL. Architect: NADAA, Boston

1. <http://www.nadaaa.com/portfolio/intergenerational-center/>
2. Senior Living, Foster City, CA. Architect: Perkins Eastman
3. http://www.perkinseastman.com/category_2400021_senior_living

Westminster Village, Scottsdale, AZ. Architects: Perkins Eastman.

http://www.perkinseastman.com/project_2400233_westminster_village

Monarch Landing, Naperville, IL. Architects: Perkins Eastman

http://www.perkinseastman.com/project_3411671_monarch_landing

Sephardic Community Center, Brooklyn, NY. Architect: BSKS Architects.

<https://bkskarch.com/work/sephardic-community-center/>

Kampung Admiralty, Singapore. Architect: WOHA, Singapore

1. <https://www.archdaily.com/904646/kampung-admiralty-woha>
2. https://youtu.be/h38on_FY9Mk

Swan Hill District Health Residential Aged Care, Australia. Architects: Design Worldwide Partnership

<http://dwp.com/lifestyle-project/swan-hill-district-health-residential-aged-care/>

Churchill Intergenerational Hub, Australia. Architects: Suters Architects

<https://www.archdaily.com/85336/churchill-integenerational-hub-suters-architects>

Retirement and Nursing Home, Austria. Architect: Sedlak Rissland Architekten

<https://www.srap.land/projects/altenwohn-und-pflegeheim/>

Vrijburcht, Netherlands:

1. <https://cludblog.wordpress.com/2017/06/16/vrijburcht-amsterdam/>
2. <https://righttobuildtoolkit.org.uk/case-studies/vrijburcht-amsterdam/#>
3. <https://www.architectureindevelopment.org/project.php?id=499>
4. <http://dash-journal.com/vrijburcht/>
5. <https://climate-adapt.eea.europa.eu/metadata/case-studies/vrijburcht-a-privately-funded-climate2013proof-collective-garden-in-amsterdam>

Drømmehagen, Norway. Architect: Haptic

1. <https://hapticarchitects.com/work/drbaak-drbaak/>
2. <https://www.dezeen.com/2016/11/17/haptic-designs-elderly-housing-clt-drobak-norway/>



Veterans March during Murray County Fair Parade

REFERENCES

SECTION ONE: INTRODUCTION

History

1. Gaul, A. T. (2019, December 28). Murray County. MNopedia. <https://www.mnopedia.org/place/murray-county>.
2. Myaradel. Slayton. Murray County. <https://murraycountymn.com/my-product/slayton/>.
3. Slayton Minnesota Community Guide. Guide to Slayton Minnesota. <http://www.lakesnwoods.com/Slayton.htm>.
4. Slayton, MN. Destination Small Town. <https://www.destinationsmalltown.com/towns/slayton-mn>.

Demography

5. At-a-glance information about Slayton. <http://www.mncompass.org/profiles/city/slayton>.
6. Bureau, U. S. C. (2019, April 4). Search Results. The United States Census Bureau. <https://www.census.gov/search-results.html?searchType=web%2CSlayton+city%2C+MN>.
7. Is Slayton the best Minnesota city for your business? Minnesota Outline. <https://www.minnesota-demographics.com/slayton-demographics>.
8. Slayton, MN. Data USA. <https://datausa.io/profile/geo/slayton-mn>.

SECTION TWO: PRECEDENTS

Oasis Care Home - Luverne, MN

9. Atha, R., & Singh, V. (2020, July 9). Oasis Care Home, Luverne MN - Mandy Brecher. Interview.
10. Oasis Care Home Luverne MN. oasiscahome. <https://www.oasiscahomemn.com/>.

Warroad Senior Living Center - Warroad, MN

11. Bakken, R. (2009, August 19). Warroad Senior Living Center rises from the ashes. Grand Forks Herald. <https://www.grandforksherald.com/news/2106314-warroad-senior-living-center-rises-ashes>.
12. Warroad Senior Living Center. Facebook. <https://www.facebook.com/WarroadSeniorLivingCenter/>.
13. Warroad Senior Living Center. Wold Architects and Engineers. <https://www.woldae.com/project/warroad-senior-living-center/>.
14. Warroadseniorlivingcenter. (2020, March 27). Home. Warroad Senior Living Center. <https://warroadseniorlivingcenter.com/>.

NewBridge on the Charles - Dedham, MA

15. Engineering News-Record. (2015, October 29). NewBridge on the Charles, Dedham, Mass. Engineering NewsRecord RSS. <https://www.enr.com/articles/20797-newbridge-on-the-charles-dedham-mass>.
16. Hebrew SeniorLife: NewBridge on the Charles. architectmagazine.com. (2012, December 13). <https://www.architectmagazine.com/project-gallery/hebrew-seniorlife-newbridge-on-the-charles>.
17. Hebrew SeniorLife: NewBridge on the Charles. Architizer. (2016, January 26). <https://architizer.com/projects/hebrew-seniorlife-newbridge-on-the-charles/>.
18. Newbridge On The Charles. BOSTON'S HIDDEN SACRED SPACES. <http://www.hiddensacredspaces.org/newbridge-on-the-charles>.
19. Newbridge on the Charles: Leggat McCall Properties. Leggat McCall Properties Newbridge on the Charles Comments. <https://www.lmp.com/newbridge-on-the-charles/>.
20. Perkins Eastman: Hebrew Seniorlife NewBridge on the Charles. Perkins Eastman | Hebrew Seniorlife NewBridge on the Charles. http://www.perkinseastman.com/project_2400933_hebrew_seniorlife_newbridge_on_the_charles.
21. Stolbach, L., Wolff, F., & Bronner, D. NewBridge on the Charles. NewBridge on the Charles - Luxury Senior Living | Hebrew SeniorLife. <https://www.hebrewseniorlife.org/newbridge>.
22. U.S. News & World Report. U.S. News & World Report. <https://health.usnews.com/best-nursing-homes/area/ma/newbridge-on-the-charles-skilled-nursing-facility-225774>.

Spring Lake Village, Santa Rosa, CA

23. Liao, A. (2018, June 29). Getting Better with Age: Design for Senior and Assisted Living Facilities. https://www.architectmagazine.com/practice/getting-better-with-age-design-for-senior-and-assisted-living-facilities_o.
24. Living Options. Spring Lake Village. (2018, March 27). <https://covia.org/spring-lake-village/living-options/>.
25. Perkins Eastman: Spring Lake Village. Perkins Eastman | Spring Lake Village. http://www.perkinseastman.com/project_3439925_spring_lake_village.
26. Spring Lake Village. AssistedLiving.com. <https://www.assistedliving.com/california/santa-rosa/spring-lake-village/>.
27. Spring Lake Village. Cahill Contractors. (2020, March 6). <https://cahill-sf.com/portfolio/spring-lake-village/>.
28. Spring Lake Village: Perkins Eastman. Archello. <https://archello.com/project/spring-lake-village>.

Steinfeld Retirement and Nursing Home, Austria:

29. Nursing Home and Centre for Senior Citizens in Steinfeld. DETAIL inspiration. <https://inspiration.detail.de/nursing-home-and-centre-for-senior-citizens-in-steinfeld-103280.html?lang=en>.
30. Retirement and Nursing Home Steinfeld: Dietger Wissounig Architekten. Archello. <https://archello.com/project/retirement-and-nursing-home-steinfeld>.
31. Steinfeld Retirement and Nursing Home. (2013, December 3). <https://www.wissounig.com/projects/altenwohn-und-pflegeheim-steinfeld?lang=en>.

BoomTown - Gensler Research Center

32. Day, T. D., Hampton, S., Latham, L., Lindahl, L., Sommerhalder, O., Yu, S., & Zhou, D. (2019). Designing Intergenerational Communities. Gensler Research Institute.
33. Day, T. D., Hampton, S., Latham, L., Lindahl, L., Sommerhalder, O., Yu, S., & Zhou, D. (2019, April 1) Designing Intergenerational Communities: Gensler Research Institute: Research & Insight. Gensler. <https://www.gensler.com/research-insight/gensler-research-institute/designing-intergenerational-communities>.
34. Donovan, S., & Latham, L. (2019, December 3). Designing Intergenerational Communities: Dialogue Blog: Research & Insight. Gensler. <https://www.gensler.com/research-insight/blog/designing-intergenerational-communities>.
35. Latham, L. (2017, August 31). BoomTown: The Promise of 'Ageless Thinking' - Urban Planning and Design - architecture and design. GenslerOn. <http://www.gensleron.com/cities/2017/8/31/boomtown-the-promise-of-ageless-thinking.html?q=intergenerational>.
36. Latham, L. (2017, December 5). Building BoomTown: Ageless Communities That Are Inclusive and Purpose-Driven - Urban Planning and Design - architecture and design. GenslerOn. <http://www.gensleron.com/cities/2017/12/5/building-boomtown-ageless-communities-that-are-inclusive-and.html?q=intergenerational>.
37. Latham, L., Lindahl, L., & Day, T. D. (2017, August 17). BoomTown: A Future for All Ages - Urban Planning and Design - architecture and design. GenslerOn. <http://www.gensleron.com/cities/2017/8/17/boomtown-a-future-for-all-ages.html>.
38. Lindahl, L. (2017, July 29). BoomTown: Common Interests Trump Common Ages - Urban Planning and Design - architecture and design. GenslerOn. <http://www.gensleron.com/cities/2017/9/7/boomtown-common-interests-trump-common-ages.html?q=intergenerational>.

SilviaBo, Sweden

39. Om seniorbostäderna SilviaBo. BoKlok Sverige. <https://www.boklok.se/om-seniorbostaderna-silviabo/>.
40. Crook, L. (2019, August 20). IKEA and Queen of Sweden adapt modular BoKlok housing for the elderly. Dezeen. <https://www.dezeen.com/2019/08/20/ikea-boklok-prefabricated-silviabo-elderly-housing/>.

SECTION FIVE: DESIGN

Design Considerations

41. Union Village. Michael Watkins Architect, LLC. <https://www.michaelwatkinsarchitect.com/projects/union-village>.

Kit of Parts

42. Almshouse. Witherford Watson Mann architects. <http://www.wmmarchitects.co.uk/projects/almshouse-southwark>.



Southwest Regional Sustainable
Development Partnership

UNIVERSITY OF MINNESOTA
EXTENSION

cura
Center for Urban
& Regional Affairs



COLLEGE OF
DESIGN
UNIVERSITY OF MINNESOTA