

MACINDOE IAN EDWARD BOX 390 MAYO U OF M MACINTYRE WILLIAM ROSS 17 E 4TH ST MACIOSEK CHARLES JOSEF 2937 FLORIDA AVE SO MACIVER DOUGLAS LEONAR GAY HALL MACIVER JOYCE CHARLOTT 524 E 5TH ST MACIVER RUTH IRENE	GRAD 373-5042 MPL 69 DULTH 723-0759 DULUTH 69 GC 929-7119 SLP ST LOUIS PARK 69 MORRS LOWRY 71 MORRS LOWRY 69 MORRS LOWRY	MACRAFIC RICHARD WAYNE 71 IT	MACREADY GEORGE BYRON 378 4TH ST SE MACTAVISH IAN FREDRICK 1609 UNIVERSITY AVE SE MACY DAVID H 1827 YORK AVE MADAY THOMAS PATRICK 3500 38TH AVE SO MADEN GERALD WILLIAM 3419 PIERCE ST NE MADEN GREGORY MARTIN 5043 30TH AVE SO MADEN JOHN ROBERT 2535 JOHNSON NE MADEN KATHLEEN ALICE	GRAD 339-2130 MPL EUGENE OR 70 CLA 331-1335 MPL MINNEAPOLIS 71 AGFHE 735-3120 STP ST PAUL 68 GC 722-0571 MPL MINNEAPOLIS 69 GC 781-7931 MPL MINNEAPOLIS 68 GC 729-2571 MPL MINNEAPOLIS 68 IT ST1-7313 MPL MINNEAPOLIS 70 CLA MPL LITTLE FALLS 68 PH	MAERTENS LOIS MARIE 5224 ABBOTT SO MAETZOLD DEBORAH KAY GAY HALL MAGANINI PAMELA ANNETT 36 ENGLAND AVE MAGARA COLLEEN GENEVIE 323 BURNTSIDE DR MAGARIGAL EILEEN THERE 1425 6TH ST SE MAGDA JOSEPH MICHAEL 2928 EWING AVE NO MAGDANZ ERIC JOHN 3019 18TH AVE SO MAGEDANZ DOROTHY C 4730 CENTRAL AVE NE MAGEE JAMES IRVING 7475 OSSEO RD APT 109 MAGER EUGENE BENEDICT BREWSTER HALL MAGER GARY PETER MD 615 E 18TH MAGIE ROBERT HARRISON 126 WARWICK SE MAGILL NADINE E 815 MTH AVE E MAGILL THOMAS SANFORD 815 N 7TH AVE E MAGNAN JAMES CYRIL 421 CEDAR AVE MAGNAN MARY ANN SYLVIA 1327 7TH ST MAGNAN ROSANNE JOAN 418 13TH AVE SE MAGNELL KENNETH ROBERT	70 CLA 922-9405 MPL MINNEAPOLIS 70 MORRS 589-4792 ALEXANDRIA 69 DULTH 624-5182 DULUTH 70 CLA 374-3723 GDV GOLDEN VALLEY 69 ED MPL MEDIA PA 68 GC 588-6179 ROB ROBBINSDALE AS ED 724-1501 MPL MINNEAPOLIS GRAD 788-3627 MPL 68 ED 533-4240 BRP ROBBINSDALE 70 AGFHE 647-3724 STP LESUEUR 70 CLA 336-3083 MPL 68 LAW 71 DULTH 558-05 DULUTH 68 DULTH 722-8902 DULUTH 69 CLA MPL LITTLE FALLS 69 CLA 331-2223 MPL BRANCH 69 CLA MPL MINNEAPOLIS GRAD
MACK JOEL DONALD MACK JUDITH YVONNE MACK MARJORIE ANNE MACK RICHARD THOMAS 1920 DAYTON MACK ROBERT CALLAN 1003 8TH ST SE MACK SPENCER PETER 5145 WOODLAWN BLVD MACKAY CHRISTINE ANN 421 N 22ND AVE W MACKAY DENNIS JOHN 421 N 22 AVE W MACKAY JAMES DONALD PIONEER HALL MACKAY JAMES ELDOREDGE	GRAD GRAD 68 MED 70 CLA 646-6283 STP ST PAUL 68 IT 331-8964 MPL POLASKI VA 68 UCUL 721-2553 MPL MINNEAPOLIS 68 DULTH 722-3470 DULUTH 71 DULTH 722-3470 DULUTH 69 BUS MPL NOYES 69 IT POLLOCK SD GRAD	MADEN MICHAEL JAMES MADEN MICHAEL THOMAS CENTENNIAL HALL MADEN PATRICIA ANN 5449 26TH AVE SO MADEN PATRICK JAMES 13 W 4TH ST MADEN THOMAS FRANCIS 5449 26TH AVE SO MADDOX GAIL ANN GRIGGS HALL K215 MADER MICHAEL PHILLIP RR 2 BOX 731 MADER RICHARD EARL JR 5152 DANENS DR MADERA THOMAS FRANCIS 5456 GIRARD AVE NO MADILL RICHARD DONALD 123 N 63 AVE W MADISON DIANE JEAN 3606 WASHBURN N MADISON EUNICE JEANETT	MADEN MICHAEL THOMAS GRAD 339-7421 MPL MECHANICSVIL 69 ED 722-8141 MPL MINNEAPOLIS 70 DULTH 727-2685 DULUTH 71 CLA 722-8141 MPL MINNEAPOLIS 70 DULTH 724-9978 69 GC 472-1214 MND MOUND 70 CLA 941-2486 EDN EDINA 70 PHARM 588-6783 BRC BROOKLYN CENTER 69 DULTH 624-9026 DULUTH 69 CLA 521-8389 MPL MINNEAPOLIS 71 DULTH DULUTH 69 CLA 336-3791 MPL INTERNAT FALLS 71 ED MPL LISMORE GRAD	MAGNELL STEFFEN INGVAR 6316 EDEEN PRAIRIE RD MAGNER DANIEL THOMAS 2235 SNEILING AVE N MAGNEY VIRGIL MAURICE 5709 LYNWOOD BLVD MAGNON THOMAS LED 9409 BLAISDELL AVE MAGNUS JACQUELINE LOUI 5306 JUNIATA ST MAGNUS KATHY KUNKEL JO 1407 N CLEVELAND MAGNUSON ALBERT CARL AS ED	68 CLA 938-6877 HOP HOPKINS AS CLA 631-2874 ROV ROSEVILLE 69 GC 472-1823 MND MOUND 69 GC 881-5063 BLT BLOOMINGTON 71 DULTH 525-5780 DULUTH 68 ED 645-9716 STP BRAINERD AS ED	
MACKAY KENNETH DONALD MACKAY WILLIAM GRANT 1406 7 ST SE MACKEN SUSAN ELISE CONSTOCK HALL MACKENZIE DAVID ROSS 5250 ELK ST MACKENZIE JULIA ANN V 1321 7TH ST SE MACKENZIE REED KING 1760 W 76TH ST MACKERETH ROBERT DALE	GRAD 70 IT MPL ALBERT LEA 70 PHARM 333-2161 MPL WILLMAR GRAD WTB MAHTOMEDI 70 CLA MPL DENVER CO 68 LAW 861-3681 RHF EAU CLAIRE WI AS AGFHE 274-5515	MADLAND DAVID GEORGE MADOLE SCOTT WILLIAM 1479 W IDAHO AVE MADOURIS WILLIAM G 1752 SHIELDS AVE MADSEN DIANE JEAN MADSEN DOUGLAS ROY 3850 W 126TH ST MADSEN FRED EMIL 835 E THIRD ST MADSEN GLENN WAYNE PIONEER HALL MADSEN JAMES DAVID 1605 PORTLAND AVE SO MADSEN JEROLD LEROY 2507 LONDON RD MADSEN LAURA LEIGH 65 ARTHUR AVE SE MADSEN LINDA CHRISTINE GRIGGS HALL MADSEN MARK CARL FRONTIER HALL MADSEN MELVIN LYLE 3922 38TH AVE SO MADSEN RUSSELL DUWANE	MADLAND DAVID GEORGE 68 CLA 645-7229 FLM FALCON HEIGHTS 68 ED 644-1106 STP 71 CLA MONTICELLO 68 GC 890-2419 MINNEAPOLIS 71 CLA 776-4642 STP SAN ANTONIO TX 69 CLA MPL ARCO 69 UCUL 338-9094 MPL 71 DULTH MOOSE LAKE 68 ED 339-4372 MPL 70 DULTH 771-7610 ST PAUL 71 CLA MPL WHEATON 68 IT 722-4992 MPL GRAD	MAGNUSON BRUCE EDWARD 3412 31ST AVE NE MAGNUSON BRUCE LOUIS 1395 FOREST MAGNUSON CAROLYN JOY 319 25TH ST W MAGNUSON DALE WILLIAM 2328 CHILCOMBE AVE MAGNUSON DIANE LEIGH AS GC 784-7780 SKP SPRING LAKE PK 71 CLA 774-5876 STP ST PAUL 68 CLA 537-3122 ROB ROBBINSDALE 68 MED 338-0157 MPL EDINA GRAD	70 NURS 561-2813 BRC BROOKLYN CENTER GRAD 335-2605 MPL 70 CLA 561-2813 BRC BROOKLYN CENTER 71 DULTH 834-4722 THO HARBORS 69 DULTH 724-3658 DULUTH 69 IT 473-2915 WAY AUSTIN 69 GC 488-4689 STP ST PAUL 69 IT 331-7916 MPL EDINA 71 DULTH 624-9579 DULUTH 69 AGFHE STP BLOOMING PR GRAD MPL TACOMA WA GRAD 935-6540 HOP 70 AGFHE	
MACKKEY JOHN WILLIAM 339 GILEAD MACKKEY LINDA MARIE 1436 N 9 AVE E MACKKEY WILLIAM RUSSELL 1807 WASHINGTON AVE SO MACKIE JAMES BUSS RT 5 BOX 108W MACKIE JAMES GILBERT CENTENNIAL HALL MACKIE ROBERT DALE PIONEER HALL MACKINNEY FLORETTA GAL 1701 STANFORD MACKINNON JAMES DAVIS ANDREW HOUSE 5TH ST SE MACKLIN SUSAN LOUISE PIONEER HALL MACKLIN WILLIAM EDWARD 525 21ST AVE SO MACKLING MARGARET M CONSTOCK HALL MACKRELL RICHARD THOMA	68 DULTH 722-2549 ST PAUL 71 DULTH 728-2014 DULUTH 69 GC MPL MRNE ST CROIX 70 CLA 474-5822 EXC EXCELSIOR 68 BISOE MPL ST PAUL 68 IT 373-6162 MPL ST PAUL 69 GC 699-8194 STP ST PAUL 70 CLA MPL LONG LAKE 71 CLA 354-4568 MPL NEW ULM 68 CLA 339-5390 MPL NEW ULM 68 PH 373-7080 MPL WINNIPEG 68 GC	MADSON DAVID CLEMENT PIONEER HALL MADSON DONALD PETER 2521 JAMES AVE NO MADSON ERIC ROLFE RT 3 BOX 653 MADSON JAMES PALMER 871 DAYTON AVE MADSON MARLAND LEROY 809 EAST 94TH ST MADSON NOLAN DEAN FRONTIER HALL MADSON PEGGY ANNETTE 209 SHADY OAK RD MADURA JOHN PAUL TERRITORIAL HALL 9 425 MADYCH WOLODYMYR ROMAN 617 9TH AVE SE MAECKELBERGH GERALD RI 425 RICE CREEK BLVD MAECKELBERGH MICHAEL J 3074 RESTORMEL MAEDER EDWARD C JR 6501 PARKWOOD RD MAEDER MARY SUSAN 286 MARSHALL AVE MAEDER TERESA CATERINE 370 NO FINN ST MAEGI VELLO JOHANNES 4721 WINGARD LANE MAEGLEY WENDEL JOSEPH	MADSON DAVID CLEMENT 71 CLA MPL HUTCHINSON 71 IT 522-8595 MPL MINNEAPOLIS 71 CLA 472-3422 MND MOUND 68 AGFHE 227-4689 STP BLOOMING PR GRAD 884-1262 BLT 71 CLA MPL HANKATO 71 AGFHE 935-7807 HOP HOPKINS 69 ED 333-6593 MPL AUSTIN GRAD 331-2837 MPL HAMTRAMCK MI GRAD 786-5446 FRD DULUTH 68 DULTH 624-2583 DULUTH GRAD 938-3772 MPL MINNEAPOLIS 71 CLA 222-9337 STP ST PAUL 69 ED 646-1646 STP ST PAUL 71 IT 561-4465 BRC BROOKLYN CENTER GRAD	MAGNUSON PATRICIA ANN 3221 POE ROAD MAGNUSON PAUL ANDREW 7 BARTON AVE SE MAGNUSON PAULA MARY 3221 POE ROAD MAGNUSON RICK ALIVER MTD RT BOX 518 MAGNUSON ROBERT DALE 1319 BRAINERD AVE MAGNUSON RONALD ALLAN 170 E WAYZATA BLVD MAGNUSON RONALD JOHN 912 FARRINGTON MAGNUSON STEVEN EDWARD 1601 UNIVERSITY AVE SE MAGNUSON SUSAN LINDA 129 N 28TH AVE W MAGNUSON ANN ELIN 1276 RAYMOND AVE MAGNUSON BRIAN KEITH 708 5TH ST SE MAGNUSON DEANNE BORTO 4913 ARLINGTON DR MAGNUSON DIANE MARIE MAGNUSON PAUL CYRUS 1988 BREWSTER ST MAGNUSON ROGER ALAN 1505 N CLEVELAND AVE MAGOFFIN JAMES AARON	69 GC 823-7369 MPL FERGUSS FALLS GRAD 644-6514 69 GC AS GC 784-7780 SKP SPRING LAKE PK 71 CLA 774-5876 STP ST PAUL 68 CLA 537-3122 ROB ROBBINSDALE 68 MED 338-0157 MPL EDINA GRAD 70 NURS 561-2813 BRC BROOKLYN CENTER GRAD 335-2605 MPL 70 CLA 561-2813 BRC BROOKLYN CENTER 71 DULTH 834-4722 THO HARBORS 69 DULTH 724-3658 DULUTH 69 IT 473-2915 WAY AUSTIN 69 GC 488-4689 STP ST PAUL 69 IT 331-7916 MPL EDINA 71 DULTH 624-9579 DULUTH 69 AGFHE STP BLOOMING PR GRAD MPL TACOMA WA GRAD 935-6540 HOP 70 AGFHE GRAD 645-6139 STP ST PAUL 69 VET M 646-3196 STP BLOOMING PR 69 GC	
MACKPHAIL ALAN JEFFREY 915 20TH AVE S MACKPHAIL KENT GILNDR 5333 MINNEHAMA BLVD SO MACKPHAIL WILLIAM STUAR	69 BUS 922-6092 MPL MINNEAPOLIS 69 GC 926-0022 EDN EDINA 69 BUS	MAERCKLEIN PETER BERNA 419 ERIE ST SE MAERTENS JOSEPH DAVID 615 SE 6TH ST	MAERCKLEIN PETER BERNA 69 CLA 831-9058 MPL KENYON 68 IT 331-5410 MPL WABASSO	MAGREW JAMES ALLEN 3133 JERSEY AVE MAGRISO ISRAEL 525 UNIV AVE SE MAGUIRE DANIEL JAMES 1810 GARFIELD ST NE MAGUIRE JAMES HARRY VERMILION HALL 122	69 GC 929-8461 SLP ST LOUIS PARK GRAD 335-6935 MPL 70 CLA 789-5510 MPL 70 DULTH 724-9886 ST PAUL	







MARTHALER KATHRYN LEE 5205 WINDSOR AVE MARTHALER MARY ANN GAY HALL	70 AGFHE 929-1116 EDN EDINA 71 MORRS SAUK CENTRE	MARTIN NANCY ELIZABETH 701 UNIVERSITY AVE SE MARTIN NANCY LOUISE 1316 7TH ST SE MARTIN ORLA JANE	GRAD 332-3740 MPL CINCINNATI OH 70 CLA 331-1491 MPL MINNETONKA 68 GC MONTEVIDEO	MARTINSON RONALD LEE 1214 W 2ND ST MARTINSON SHARLEEN ANN	GRAD EVELETH 71 CLA ZUMBRO FALLS	
MARTI NANCY JANE 3085 MILDRED DR MARTI SHIRLEY RUTH 1502 RAYMOND AVE MARTI VICKI IRENE SANFORD HALL MARTIG ROBERT RUDOLPH E 7TH ST MARTIN ANITA CAROL 911 JOHNSON AVE MARTIN BRENT LEONARD 4080 XENWOOD AVE MARTIN BRUCE EDWARD 1626 W 25TH ST MARTIN BRUCE MICHAEL 1985 KNAPP AVE W 2 MARTIN CAROLYN ANN MARI 16235 9TH AVE N MARTIN DAVID GRIFFITHS 5308 1ST AVE SO MARTIN DEBORAH JANE	69 CLA 633-5024 ROV ROSEVILLE 68 AGFHE 646-3786 STP SLEEPY EYE 70 CLA 339-0931 MPL KASSON 68 MORRS 589-2095 CLINTON 70 CLA WTB WHITE BEAR LAKE 71 CLA 929-8304 SLP ST LOUIS PARK 70 CLA 377-4452 MPL MINNEAPOLIS GRAD 645-7119 STP 68 NURS 473-9491 WAY HAYZATA 70 IT MPL MINNEAPOLIS 70 CLA MINNETONKA BCH	MARTIN RHODA WEATHERS 2813 DELAWARE SE MARTIN RICHARD MARTIN 2143 CHILD DEVELOPMENT MARTIN ROGER KENT 5196 ELK ST MARTIN RONALD GARY 3101 12TH AVE SO MARTIN RONALD GENE 312 SO DNASSO BLVD MARTIN ROSEMARY ANASTA 1721 E 1ST ST MARTIN SANDRA JANE RT 4 BOX 82 MARTIN SAUNDRA OLIVE 5316 TIOGA ST MARTIN SHEILA KAY 4111 BEARD AVE SO MARTIN STEPHEN HAMMOND 2285 W HOYT MARTIN TERRY LYNN 230 W 93RD ST MARTIN THOMAS STEPHEN 501 5TH ST SE MARTIN TIMOTHY JOSEPH 2149 BUSH AVE MARTIN VIRVE PAUL 8714 SECOND AVE SO MARTIN WILLIAM DAVID J 1021 RAYMOND AVE MARTIN WILLIAM REED	68 IT 331-6056 MPL GRAD 339-6990 MPL MINNEAPOLIS 70 IT 429-5209 WTB WHITE BEAR LAKE 68 IT 729-0887 MPL AS GC 484-4056 ROV ROSEVILLE GRAD 724-8279 DULUTH 68 BUS 474-8514 EXC EXCELSIOR 69 DULTH DULUTH 70 CLA MPL MINNEAPOLIS GRAD 645-2636 STP ST PAUL 71 CLA 888-6047 BLT BLOOMINGTON 70 CLA 421-4494 MPL ANOKA 69 GC 735-0665 STP ST PAUL GRAD 888-1019 BLT GRAD 645-1156 STP ANACONDA MT GRAD	MARTINSON STEVEN LEROY 723 A KELLY CIRCLE MARTINSON SUSAN LARSON 4929 EWING SO MARTINSON TERRY LEE	71 DULTH 722-4593 DULUTH 69 ED 926-9644 MPL MINNEAPOLIS 70 IT HALLOCK 69 IT 331-7961 MPL ST LOUIS PARK 69 GC 724-1179 3925 BLOOMINGTON AVE SO MPL MINNEAPOLIS GRAD MPL 71 PHARM MPL TOWER 69 CLA 729-2231 MPL MINNEAPOLIS 71 CLA 729-2231 MPL MINNEAPOLIS AS ED	
MARTIN DEBORAH JEAN 5205 MIRROR LAKES DR MARTIN DON JAMES 1407 PASCAL MARTIN DONALD RICHARD 1374 BERKELEY AVE MARTIN EDWARD ARTHUR 5316 TIOGA ST MARTIN EDWARD LOUIS	71 CLA 929-1808 EDN EDINA 68 AGFHE 645-5600 STP ROCHESTER 70 CLA 699-2853 STP ST PAUL 71 DULTH 525-3637 AS ED 69 MED 645-2636 STP ST PAUL 69 DULTH 724-3105 BEACH FL 69 BUS	MARTIN WILLIAM RICHARD RT 4 BOX 82 MARTIN WILLIAM WADE 424 5TH ST SE MARTINE DAVID DARWIN P O ST PAUL CAMPUS MARTINEAU JANICE IRENE 1308 5TH ST SE MARTINEAU LYNNE LERAE 969 BIDWELL ST MARTINEAU SHEILA CLAIR 1387 CLEVELAND MARTINI BONITA LYNN 1121 5TH ST SE MARTINI CHARLES ALLAN 2026 4TH AVE SO MARTINI DAVID JOHN 317 6TH AVE SE MARTINKA WILLIAM NICHAS	69 DULTH 724-3105 BEACH FL 69 BUS 69 ED 644-9398 FLH FALCON HEIGHTS 68 AGFHE 645-2636 FLH 68 IT 68 LAW 331-8622 MPL EDINA 68 ED 888-4940 BLT 69 GC ST9-7722 MPL MINNEAPOLIS 68 IT 926-5944 MPL MINNEAPOLIS 71 PHARM MPL ROCHESTER 69 IT 69 IT 633-3418 ROV 70 CLA 788-6135 MPL MINNEAPOLIS 69 LAW MPL FARIBAULT 70 CLA 789-1256 STA ST ANTHONY 70 CLA 331-1335 MPL MINNEAPOLIS AS ED 71 CLA 922-5426 EDN EDINA 68 CLA 545-5224 GOV GOLDEN VALLEY 69 DULTH 724-6274 DULUTH 68 DULTH 626-2871 DULUTH 70 IT MPL MONTROSE 68 IT 489-3038 STP ST PAUL 71 CLA 822-6083 MPL MINNEAPOLIS 70 CLA 339-1033 MPL WILLMAR 71 CLA 588-2917 ROB ROBBINSDALE 68 CLA 331-1335 MPL SARATOGA CA GRAD ORANGE PARK FL	MARX DANIEL JOHN 1436 ARONA ST MARX GERALD WILLIAM 615 15TH AVE SE MARX PATRICK WAYNE GAY HALL MARX ROBERT LEE TERRITORIAL HALL MARX RUTH NUNAMAKER MA GRAD MARX WALLACE ALLEN GRAD MARXHAUSEN BENJAMIN WA 815 COPE AVE W MARXHAUSEN JAMES EDWAR 5034 ALDRICH SO MARNYAK DIANE CAROL 3938 29TH AVE SO MARZ TIMOTHY PAUL 512 BEAUMONT MARZINSKE LINDA LEE SPOONER HALL MARZOLF NADINE ELIZABE COMSTOCK HALL MASAMZ JOSEPHINE ANNA 2028 PORTLAND AVE MASCHING DONALD FREDER 68 MORSC BREDA IA GRAD 646-8530 STP CHICAGO IL 70 AGFHE 646-8530 STP SHEVLIN 71 AGFHE 578-5021 STP HOMEWOOD IL GRAD 68 GC 935-0596 MPL EXCELSIOR 71 CLA 373-7437 MPL HINCKLEY 70 AGFHE STP HOPKINS 69 IT 331-2350 MPL LAGOS 70 CLA 335-3985 MPL MINNEAPOLIS 69 BUS 789-0111 MPL MINNEAPOLIS 71 CLA 1923 WASHINGTON ST NE MASLER GARY IRVING 3055 VIRGINIA SO MASLEY PETER BRUCE 2901 MADISON ST NE MASLOVE ALLAN MICHAEL CENTENNIAL HALL MASLOWSKI BARBARA ANN 1217 29 ST MASLOWSKI MICHAEL BERN 17125 THOMAS AVB SO MASON BARBARA ANN 650 LEICESTER MASON CAROL SUE 4804 16TH AVE SO MASON CHARLES JAMES 3081 LONG LAKE RD	MARTINSON THOMAS RICHARD 605 SE ONTARIO MARTINSON THOMAS RICHARD 3925 BLOOMINGTON AVE SO MARTON ALEJANDRO B P O BOX 9652 MARTTILA JAMES KONST TERRITORIAL MARTY CAROL LYNN 4609 COFFEY LN MARTY DANIEL PAUL 4609 COFFEY LANE MARTZ PATRICIA ANN	69 ED 455-5416 SSP SOUTH ST PAUL 71 CLA 774-1577 STP ST PAUL 71 CLA 226-4836 STP ST PAUL GRAD MPL EVANSVILLE IN 68 IT 722-4839 MPL MINNEAPOLIS 71 AGFHE 647-3793 STP CIRCLE PINES GRAD 373-5687 ST PAUL GRAD 331-4033 MPL 69 CLA 698-3603 STP ST PAUL 69 GC 699-2756 STP ST PAUL GRAD 644-8323 STP EAU CLAIRE WI 68 IT 331-1283 MPL EAU CLAIRE WI 70 MORRS ROCHESTER 71 CLA 765-4400 MPL PRESTON GRAD GRAD 484-1083 STP 70 CLA 742-8815 MPL MINNEAPOLIS 69 GC 722-8979 MPL MINNEAPOLIS 69 IT 771-6357 STP ST PAUL 71 MORRS 589-4693 ALBERT LEA 70 CLA 333-2161 MPL PRESTON 70 CLA 645-8919 STP ST PAUL 68 MORSC BREDA IA GRAD 646-8530 STP CHICAGO IL 70 AGFHE 646-8530 STP SHEVLIN 71 AGFHE 578-5021 STP HOMEWOOD IL GRAD 68 GC 935-0596 MPL EXCELSIOR 71 CLA 373-7437 MPL HINCKLEY 70 AGFHE STP HOPKINS 69 IT 331-2350 MPL LAGOS 70 CLA 335-3985 MPL MINNEAPOLIS 69 BUS 789-0111 MPL MINNEAPOLIS 71 CLA 1923 WASHINGTON ST NE MASLER GARY IRVING 3055 VIRGINIA SO MASLEY PETER BRUCE 2901 MADISON ST NE MASLOVE ALLAN MICHAEL CENTENNIAL HALL MASLOWSKI BARBARA ANN 1217 29 ST MASLOWSKI MICHAEL BERN 17125 THOMAS AVB SO MASON BARBARA ANN 650 LEICESTER MASON CAROL SUE 4804 16TH AVE SO MASON CHARLES JAMES 3081 LONG LAKE RD
MARTIN LAWRENCE EDWARD 1711 E 88TH ST MARTIN LINDA LOUISE 230 GEORGIA AVE N MARTIN MARGARET ANN 108 10M MARTIN MARVIN LEE 3963 YOSEMITE AVE MARTIN MARY KAY 215 MAPLE HILL RD MARTIN MARY MARGARET 959 W SHERREN MARTIN MICHAEL PHILLIP 5801 CLINTON AVE SO MARTIN MICHAEL ROBERT 4370 VERNON AVE SO	69 GC 881-8079 BLT BLOOMINGTON 69 ED 545-9511 GOV GOLDEN VALLEY AS GC 373-4894 MPL DUNNELL 71 CLA 929-2205 SLP ST LOUIS PARK 71 CLA WE8-6311 HOP HOPKINS 70 CLA 489-3840 ROV ROSEVILLE 70 CLA 866-3569 MPL MINNEAPOLIS 71 CLA 929-0731 EDN EDINA	MARTINSON BLAINE ALLAN 11A SILVER LAKE HOMES MARTINSON BRADLEY JAME 6111 STAR LANE NE MARTINSON CHRISTINE JU 5127 GIRARD AVE NO MARTINSON DAVID LEE 4922 LYNDALE SO MARTINSON DONALD IVAN 5127 GIRARD AVE NO MARTINSON GREGORY EARL GAY HALL MARTINSON JAMES BROOKS 1321 FRANKLIN AVE SE MARTINSON JEANINE ABBO 1215 53RD ST W MARTINSON JON WELLMAN WADDELL TRAILER CT MARTINSON KEITH DEAN 223A 8TH AVE SE MARTINSON LEFAY ALLIST 916 SE ESSEX MARTINSON LYNN VIRGIL MARTINSON MARY ELLEN MARTINSON PATRICIA ANN 1640 CLARENCE MARTINSON RUEEL ANTHON 2920 SO 9TH ST MARTINSON RICHARD LEE 4630 JAY ST	68 CLA 588-7418 GOV GOLDEN VALLEY 71 CLA 588-7418 GOV GOLDEN VALLEY 69 PHARM VIRGINIA 69 DULTH 741-3737 VIRGINIA 70 LAW 560-1027 FRD BRAINERD 71 CLA 522-0309 MPL MINNEAPOLIS 71 CLA 823-8501 MPL MINNEAPOLIS 69 ED 522-0309 MPL 70 MORRS STARBUCK 70 CLA 333-0765 MPL HOPKINS 71 CLA 935-0410 MPL 68 MORRS CLINTON 68 ED MPL 69 AGFHE 331-3744 MPL ZUMBRO FALLS 71 IT 68 GC 771-0736 STP ST PAUL 71 DENT MPL 69 DULTH 525-1142 DULUTH	MARTINSON THOMAS RICHARD 605 SE ONTARIO MARTINSON THOMAS RICHARD 3925 BLOOMINGTON AVE SO MARTON ALEJANDRO B P O BOX 9652 MARTTILA JAMES KONST TERRITORIAL MARTY CAROL LYNN 4609 COFFEY LN MARTY DANIEL PAUL 4609 COFFEY LANE MARTZ PATRICIA ANN	69 ED 455-5416 SSP SOUTH ST PAUL 71 CLA 774-1577 STP ST PAUL 71 CLA 226-4836 STP ST PAUL GRAD MPL EVANSVILLE IN 68 IT 722-4839 MPL MINNEAPOLIS 71 AGFHE 647-3793 STP CIRCLE PINES GRAD 373-5687 ST PAUL GRAD 331-4033 MPL 69 CLA 698-3603 STP ST PAUL 69 GC 699-2756 STP ST PAUL GRAD 644-8323 STP EAU CLAIRE WI 68 IT 331-1283 MPL EAU CLAIRE WI 70 MORRS ROCHESTER 71 CLA 765-4400 MPL PRESTON GRAD GRAD 484-1083 STP 70 CLA 742-8815 MPL MINNEAPOLIS 69 GC 722-8979 MPL MINNEAPOLIS 69 IT 771-6357 STP ST PAUL 71 MORRS 589-4693 ALBERT LEA 70 CLA 333-2161 MPL PRESTON 70 CLA 645-8919 STP ST PAUL 68 MORSC BREDA IA GRAD 646-8530 STP CHICAGO IL 70 AGFHE 646-8530 STP SHEVLIN 71 AGFHE 578-5021 STP HOMEWOOD IL GRAD 68 GC 935-0596 MPL EXCELSIOR 71 CLA 373-7437 MPL HINCKLEY 70 AGFHE STP HOPKINS 69 IT 331-2350 MPL LAGOS 70 CLA 335-3985 MPL MINNEAPOLIS 69 BUS 789-0111 MPL MINNEAPOLIS 71 CLA 1923 WASHINGTON ST NE MASLER GARY IRVING 3055 VIRGINIA SO MASLEY PETER BRUCE 2901 MADISON ST NE MASLOVE ALLAN MICHAEL CENTENNIAL HALL MASLOWSKI BARBARA ANN 1217 29 ST MASLOWSKI MICHAEL BERN 17125 THOMAS AVB SO MASON BARBARA ANN 650 LEICESTER MASON CAROL SUE 4804 16TH AVE SO MASON CHARLES JAMES 3081 LONG LAKE RD	



MATTSON DARLA RAE PIONEER CT MATTSON DIANNE MAUREEN 512 77TH AVE NO MATTSON DONNA JEAN PIONEER COURT MATTSON DONNA JEAN BURNTSIDE HALL 121 MATTSON FRED ERNEST	68 NURS MPL MORA 68 ED BRP BROOKLYN PARK 68 ED 373-6087 MPL 71 DULUTH 724-9873 COON RAPIDS AS DULTH	MAUNU RONALD DENNIS 61 JAY COOKE RD MAUPIN EARL WAYNE DEXTER HALL MAUPINS CARRIE LAVERNE 625 N 9TH AVE E MAUPINS SYLVIA A 625 N 9 AVE E MAURATH EDWARD JAMES 414 7TH ST SE MAUREN NANCY ANN 7239 NEWTON SO MAURER CATHERINE LYNN BURNTSIDE HALL 126 MAURER JOYCE MARIE 3983 NO FAIRVIEW AVE MAURER STEVEN ALBERT 2770 XERXES AVE SO MAURINE MARY ANN 2209 W 6TH ST MAURIZIO MARYJANE NAFI 1022 OHIO MAURSTAD BETTY LOUISE 3357 LOUISIANA AVE SO MAURSTAD PETER EDWIN 1323 7TH AVE MAUS ALINE T 1308 5TH ST SE MAUSETH DONALD TRUMAN 1199 ENGLEWOOD AVE MAUSZYCKI ROBERT JOHN	68 DULTH 879-9337 ESKO 70 AGFHE STP PINE CITY 70 DULTH 724-0194 DULUTH 71 DULTH 724-0194 DULUTH GRAD 332-7918 MPL MESA AZ 70 CLA 869-4652 RHF RICHFIELD 71 DULTH 724-9873 BAYPORT 70 CLA 633-3893 ANH ARDEN HILLS 69 LAW 920-7128 MPL LANCASTER PA 70 DULTH 722-1391 DULUTH 69 GC 224-0945 WSP WEST ST PAUL GRAD 929-1950 SLP ST LOUIS PARK 70 CLA 283-2184 INTERNAT FALLS 70 CLA 332-9637 MPL WATER MILL NY 69 BUS 646-0031 STP ST PAUL 68 IT	MAYBERG JEREMY PHILLIP 979 14TH AVE SE MAYBERG SUSAN MARGARET 4503 GOLF TER MAYEDA CYNTHIA JOY 8021 W 34 1/2 ST MAYER BARBARA BOHAN GR	70 CLA 331-2247 MPL ST LOUIS PARK 71 CLA 922-5277 EDN EDINA 71 CLA 938-2488 SLP ST LOUIS PARK 68 CLA	MAYER BARRY LEE TERRITORIAL HALL MAYER DONALD PHILLIP MAYER GARY JAMES MAYER GERALDINE ANN GRIGGS HALL K115 MAYER HELEN MARIE MAYER JAMES HOWARD P O 762 MAYER JEFFREY GEORGE 4620 FIRST AVE SO MAYER JOHN STEVEN 5216 UPTON AVE S MAYER MICHAEL RALPH 3225 DIAMOND EIGHT TERR MAYER PAUL ALVIN MAYER RICHARD DAVID MAYER ROBERT LOUIS MAYER THOMAS GEORGE 945 17TH AVE SE MAYER THOMAS PAUL 319 8TH ST SE MAYER WALTER HENRY JR	71 IT MPL FARGO ND 70 CLA 68 ED 70 DULTH 724-9957 LAKE ELMO GRAD 70 MORRS BELGRADE 70 CLA 745-1377 MPL MINNEAPOLIS 68 GC 926-3089 MPL MINNEAPOLIS GRAD 788-3543 MPL JACKSON WI 70 CLA AUSTIN GRAD GRAD 69 MED 331-6922 MPL MINNEAPOLIS 71 CLA MPL HASTINGS GRAD	MATTSON LYNN VICTORIA 810 8TH ST SE MATTSON LYNTE GLEN MATTSON MARY CHRISTY 1325 MISSOURI AVE MATTSON MERIKAY HELEN 1616 MERRILL MATTSON MICHAEL GILBER MATTSON MICHAEL JOHN BX 115 ESKO MATTSON MICHELE RAE 914 E 2ND ST MATTSON MORRIS GARY FRONTIER HALL MATTSON PATRICIA DIANE WESLEY HOUSE MATTSON PATRICIA RAE MATTSON PETER AUGUSTUS DEPT OF BOTANY MATTSON PETER EVAN 2392 W LARPEUR MATTSON PETER STEPHEN 212 N 9TH AVE E MATTSON RICHARD HARRY 2177 KNAPP MATTSON ROBERT CARL 3347 44TH AVE SO MATTSON ROBERT LEONARD 4544 ADAIR AVE NO MATTSON THOMAS GEORGE 1126 5TH ST SE MATTSON VIRGINIA ANNE 1407 ALASKA AVE MATTSON WILLIAM JOHN J MATTSON WILLIAM THOMAS TORRANCE HALL 127 MATTSON JAMES PAUL 4621 VINCENT SO MATULA DENNIS LEE ERIE PLAZA APT 5E MATULAITIS WILLIAM MAT 330 8TH ST SE MATUSAK SR LORRAINE 2400 W LARPEUR MATUSESKI MARY KATHRYN BAILEY HALL MATUSKA DAVID PAUL 5691 QUINCY AVE MATYI JOHN LOUIS 5815 19TH AVE SO MATZ ELDON REUBEN MATZ PAUL WILLIAM MAU BRUCE ELLIOT 3345 UNIV AVE SE MAUD BARBARA ANN CHINN 116 HARWICK SE MAUER SUSAN KAY 1092 HAZELWOOD ST MAUGER PAUL ALLAN 175 W LARPEUR AVE MAUGHAN HAROLD WILLIAM 404 E 4TH ST MAUGHAN STANLEY ROBERT 404 E 4TH ST MAULWURF DOUGLAS ANTHO	71 CLA MPL FOREST LAKE 68 GC 71 DULTH 724-1242 DULUTH 68 CLA HU9-6369 STP ST PAUL 69 GC 68 DULTH 879-7579 ESKO 71 DULTH 727-6636 COTTON 70 CLA 778-3362 SLP CANNON FALLS 68 AGFHE STP SPICER 70 MORRS HOFFMAN GRAD 339-5081 MPL MINNETONKA 69 AGFHE 646-1088 STP MILACA 68 DULTH 724-7608 DULUTH GRAD 645-5332 STP CHAPMAN NB 70 CLA 729-0346 MPL MINNEAPOLIS 69 GC 537-6050 CYT CRYSTAL 70 LAW MPL BIWABIK 69 CLA 699-8196 STP ST PAUL GRAD 70 DULTH 724-9841 SILVER BAY 68 GC 992-8740 MPL MINNEAPOLIS 71 IT MPL HASTINGS 69 CLA 336-3461 MPL RENO NV GRAD 646-6981 STP LISLE IL 71 AGFHE STP BEHIDJI GRAD 784-0604 NWB JACKSON 70 CLA 722-7217 MPL MINNEAPOLIS 68 BUS 69 MORSC WASECA GRAD 331-6135 MPL TRIMONT GRAD 339-1089 MPL 71 CLA 771-7916 STP ST PAUL GRAD 488-7331 STP CHESHIRE CT 70 MORRS 589-2268 MORRIS 68 MORRS MORRIS AS CLA	MAX ALAN STEVEN MAX KRISTINE IRENE MAX LEONARD MICHAEL RT 4 BOX 527 MAXA DWIGHT PHILIP MAXANT BONNIE LYNN 419 WRIE ST SE MAXFIELD LOREN WALLACE 2840 PILOT KNOB RD MAXSON DOUGLAS RAY 420 8TH ST SE MAXSON EMILY RUTH MAXSON STEPHEN JOHN 1636 W MINNEHAMA MAXWELL ARTHUR FREDER 636 LOWRY AVE NE MAXWELL GRAHAM SAMUEL MAXWELL HELEN LOUISE 827 E 1ST ST MAXWELL JAMES WILLIAM MAXWELL MARILYN KAY 2815 MERRILL ST MAXWELL MARY MARGARET 1440 COMMERCE ST MAXWELL MERRILEE JO MEREDITH HALL MAXWELL PETER JAMES 1418 MADISON ST NE MAXWELL RANDALL LYNN BAILEY HALL MAXWELL ROBERT EUGENE 4533 30TH AVE S MAXWELL ROBERT KINGSLE MAXWELL SHARON LEE 3543 DUPONT N MAY DAVID WILLIAM 306 W OWATONNA ST MAY FRANK AUSTIN JR 787 6TH AVE NW MAY GALE KENNETH MAY GEORGE ALEXANDER 6645 PARKWOOD RD MAY GEORGE LEWIS 1926 ST CLAIR AVE MAY JAMES FREDRICK 1409 COMO AVE SE MAY JOSEPH EUGENE 3852 YATES AVE NO MAY JUDY ANN 810 8TH ST SE MAY JULIANN MARIE LARS MAY LED L 1115 THOMAS AVE N MAY LESLIE MARIE 1012 3TH ST SE MAY MARSHA ELLEN 4038 QUEEN NO MAY NANCY MELINDA SANFORD HALL MAY FERRY ALAN 186 FRONTIER HALL MAY THEODORE NOAH 341 2ND ST NE MAY THOMAS ALFRED 798 CASE ST MAY THOMAS LAWRENCE PHI HU DELTA FRATERNITY	70 DENT 71 CLA 771-8368 68 GC 70 CLA 474-7808 EXC EXCELSIOR 69 ED 70 CLA 331-1597 MPL RIVERSIDE IL 70 CLA 454-3559 MEN MENDOTA 68 DENT 336-9249 MPL ST PETER GRAD 69 AGFHE 646-1740 STP ST PAUL 68 GC 781-2176 MPL GRAD 68 DULTH 724-8451 DULUTH GRAD 70 CLA ROV ROSEVILLE 69 AGFHE 631-2732 ROV ROSEVILLE 71 CLA 474-7404 STP EXCELSIOR 68 CLA 789-8782 MPL 70 AGFHE 647-9241 STP RED WING GRAD 722-7308 MPL ELIDA OH GRAD 71 CLA 522-0156 MPL MINNEAPOLIS AS DULTH 728-3894 DULUTH 69 IT 633-0030 NWB BRANDON FL 68 MORRS 589-4846 ORTONVILLE 70 CLA 935-3266 EDN EDINA 70 LAW STP ST PAUL 70 DENT 331-8842 MPL SIOUX FALLS SD 68 GC KE3-8064 ROB ROBBINSDALE 68 CLA 331-2607 MPL TAQPI AS ED 71 CLA 521-0253 MPL MINNEAPOLIS 70 CLA 331-4504 MPL SOUTH ST PAUL 70 CLA 929-2761 MPL MINNEAPOLIS 71 CLA MPL MINNEAPOLIS 70 CLA MPL BEHIDJI 69 LAW 336-3894 MPL SIOUX FALLS SD 69 IT STP BEHIDJI 70 MORRS ST CLOUD	MAYBERG JEREMY PHILLIP 979 14TH AVE SE MAYBERG SUSAN MARGARET 4503 GOLF TER MAYEDA CYNTHIA JOY 8021 W 34 1/2 ST MAYER BARBARA BOHAN GR MAYER BARRY LEE TERRITORIAL HALL MAYER DONALD PHILLIP MAYER GARY JAMES MAYER GERALDINE ANN GRIGGS HALL K115 MAYER HELEN MARIE MAYER JAMES HOWARD P O 762 MAYER JEFFREY GEORGE 4620 FIRST AVE SO MAYER JOHN STEVEN 5216 UPTON AVE S MAYER MICHAEL RALPH 3225 DIAMOND EIGHT TERR MAYER PAUL ALVIN MAYER RICHARD DAVID MAYER ROBERT LOUIS MAYER THOMAS GEORGE 945 17TH AVE SE MAYER THOMAS PAUL 319 8TH ST SE MAYER WALTER HENRY JR MAYERLE MARY CAROL COMSTOCK HALL MAYERON CANDACE NYLES 514 14TH AVE SE MAYERON CONSTANCE BETH 2628 MONTEREY AVE MAYERON DENNIS 1770 BEECHWOOD AVE MAYFIELD MICHAEL JOHN 12048 MISSISSIPPI DR MAYHOOD CLIFTON RALPH 621 5 ST SE MAYLATH DONALD O 4824 VIRGINIA AVE NO MAYNARD LINDA RAB 361 POWELL HALL MAYNARD SR SANDRA 628 4TH ST SE MAYOTTE ALLAN CLARK 1143 15TH AVE SE MAYOU JOSEPH LEO MAYRY JAMES ALAN 3910 HAINES RD MAYSILLES JAMES HENRY MAZAR KEITH NICHOLAS 991 SUMMIT AVE NO MAZOROL PATRICK ALLEN 8750 CLINTON AVE SO MAZURKIEWICZ HENRYK BO 802 E NEVADA AVE MAZURKO PETER EDWARD 2311 MONROE ST NE MAZZOLA LARS CHARLES 2537 5TH AVE S MCADAMS LAYERLE YVONNE 401 1/2 E 4TH ST MCALACK PHYLLIS CAROL COMSTOCK HALL MCALONEY GERALDINE RAT 4026 THOMAS AVE NO MCALOON THOMAS PETER MCALPINE JANE ELLEN 1366 W MINNEHAMA MCANALLY DAVID KULS 3359 CENTRAL AVE NB MCANALLY KATHIE LYNN 3237 ALDRICH AVE SO MCANDREW KEVIN MICHAEL 8700 VINCENT AVE SO MCANDREWS MARGARET MAR RR 2 BOX 38 MCANDREWS MICHAEL THOM 6435 MORGAN AVE SO MCANINCH DOUGLAS LEWIS 100 W 104TH ST MCANINCH SUSAN LOUISE 100 W 104TH ST MCANINCH VIRGINIA CARO 503 6TH ST SE MCARDLE GEORGIA MAE COMSTOCK HALL MCARDLE TERRY JOHN GRIGGS HALL 8213 MCARTHUR BRUCE DUNCAN 1515 HOLDRIDGE MCARTHUR JERIE MARIE MCARTHUR SUSAN EDITH 314 10TH AVE SE	70 CLA 331-2247 MPL ST LOUIS PARK 71 CLA 922-5277 EDN EDINA 71 CLA 938-2488 SLP ST LOUIS PARK 68 CLA 71 IT MPL FARGO ND 70 CLA 68 ED 70 DULTH 724-9957 LAKE ELMO GRAD 70 MORRS BELGRADE 70 CLA 745-1377 MPL MINNEAPOLIS 68 GC 926-3089 MPL MINNEAPOLIS GRAD 788-3543 MPL JACKSON WI 70 CLA AUSTIN GRAD GRAD 69 MED 331-6922 MPL MINNEAPOLIS 71 CLA MPL HASTINGS GRAD 69 ED MPL SOUTH ST PAUL 68 CLA MPL ST LOUIS PARK 71 CLA 922-7828 SLP ST LOUIS PARK 69 CLA 699-4261 STP ST PAUL 70 IT 427-1225 OSO OSSEO 71 CLA 331-2926 MPL MINNEAPOLIS GRAD 533-3025 NWH 69 NURS 339-0531 MPL MOORHEAD 70 NURS 333-9784 MPL MILWAUKEE WI 68 CLA 331-3011 MPL ALBERT LEA GRAD GRAD 722-4348 CHISHOLM GRAD 70 IT 451-7940 SSP SOUTH ST PAUL 71 IT 881-0168 BLT BLOOMINGTON 69 GC 776-7566 STP ST PAUL 70 CLA 789-3861 MPL MINNEAPOLIS GRAD 335-2925 MPL SPRINGWATER NY GRAD 722-7280 DULUTH GRAD 373-7102 MPL CAMDEN NJ 70 CLA 521-1748 MPL MINNEAPOLIS 68 IT 68 AGFHE 644-4229 STP ST PAUL 68 GC 781-9511 MPL 70 CLA 822-4137 MPL MINNEAPOLIS 69 GC 881-9680 BLT BLOOMINGTON 70 AGFHE 423-1415 ROS ROSEMOUNT 69 GC 869-3988 RHF RICHFIELD 70 CLA 881-4329 BLT BLOOMINGTON 69 CLA 881-4329 BLT BLOOMINGTON 70 CLA 331-8757 MPL BLOOMINGTON 70 CLA 373-7284 MPL ANOKA 68 DULTH 724-9801 BENA 68 GC 473-6348 WAY GRAD 69 ED 333-4527 MPL MINNEAPOLIS
--	---	--	--	--	--	--	--	--	--	--	--	---	--







MCGUIRE DENNIS JOHN 71 DENT  
 3306 10TH AVE SO  
 MCGUIRE JOHN MICHAEL  
 CENTENNIAL HALL  
 MCGUIRE MARTHA JANE  
 1805 VERMILION RD  
 MCGUIRE MARY ANN 71 NURS 781-4011  
 1805 GARFIELD ST NE  
 MCGUIRE RICHARD GREGOR  
 1235 HIGHLAND PKWY  
 MCGUIRE ROBERT MICHAEL 68 GC 788-6295  
 1010 GOULD AVE  
 MCGUIRE SR M KENNETH  
 COMSTOCK HALL  
 MCGUIRE TERRANCE MARTI 71 CLA 724-4696  
 2430 35TH AVE SO  
 MCGUIRE TERRENCE WILLI 70 IT 326-7493  
 GREEN ISLE  
 MCGULPIN GARY RICHARD 68 GC 888-1581  
 906 90TH ST E  
 MCHALE MARTIN JAMES  
 252 EMERALD AVE  
 MCHALE WILLIAM JAMES  
 5218 10TH ST SO  
 MCHATTIE PEDER EUGENE 71 IT  
 MCHONE RONALD HENRY 71 MORRS 342-5932  
 RT 2 HANCOCK  
 MCHUGH CHARLES RUSSELL  
 418 7TH ST SE  
 MCILQUHAM KAREN ANN 70 ED 824-9740  
 3225 COLUMBUS AVE SO  
 MCINERNEY RUTH ELLEN 68 CLA  
 MCINERNEY THOMAS ANDRE 68 GC 571-6497  
 1807 JACKSON ST NE  
 MCINERNEY DENNIS QUENTI  
 GRAD  
 MCINERNY DIANE MARY 70 CLA 888-7306  
 10824 FRANCE AVE SO  
 MCINERNY STEPHEN JOHN 69 GC 949-5844  
 4524 31ST AVE SO  
 MCINNIS DIANNE LEE 68 CLA  
 MCINNIS JACOLYN FAY 68 ED  
 5322 POWELL HALL  
 MCINTIRE SARA CATHERIN  
 2125 E RIVER TERR  
 MCINTIRE SHELLEY ANNE 71 IT  
 MCINTOSH BRUCE GREAVES 69 GC 926-3764  
 4116 W 44TH ST  
 MCINTOSH ELIZABETH JAN 71 CLA 825-3328  
 5404 WENTWORTH AVE SO  
 MCINTOSH KENNETH WAYNE 69 GC  
 MCINTOSH NORMAN EARL 69 DULTH 722-6541  
 1131 N 6TH AVE E  
 MCINTYRE DONALD RICHA  
 GRAD  
 MCINTYRE GEORGE THOMAS 70 CLA  
 2885 DEMONTREVILLE RD  
 MCINTYRE WILLIAM DALE 70 DULTH 879-6023  
 122 3RD ST CLOQUET  
 MCIVER BARBARA JEAN 70 CLA  
 708 5TH ST SE  
 MCKANE JAMES PATRICK 68 CLA 771-7752  
 1319 DESOTO  
 MCKASY BERT JOHN 68 LAW 644-5740  
 2007 PORTLAND AVE  
 MCKASY HELEN ANN 70 CLA 332-2034  
 1010 SE 4TH ST  
 MCKASY MARY MARGARET 68 AGFHE  
 MCKASY MICHAEL JOSEPH AS IT  
 23 E HENNEPIN AVE  
 MCKAY ARCHIE JOSEPH 3 69 GC 722-5198  
 5665 WOODLAWN BLVD  
 MCKAY CAROLYN JEAN 68 MED 646-4158  
 2349 CARTER AVE  
 MCKAY GERALD ROBERT  
 2730 DUPONT AVE SO  
 MCKAY JAMES CLARENCE 70 DULTH 525-5454  
 4412 GLADSTONE ST  
 MCKAY JANE TERESA 70 AGFHE 866-0926  
 5600 CLINTON AVE SO  
 MCKAY KATHLEEN ELLEN 70 CLA 646-4158  
 2349 CARTER AVE  
 MCKAY MARY LOUISE 71 CLA 631-1292  
 1293 BURKE  
 MCKAY MICHAEL CAMERON 71 IT 827-1815  
 5300 11TH AVE SO  
 MCKAY ROBERT JUSTIN AS ED  
 2407 CEDARWOOD RIDGE  
 MCKAY ROBERT PATRICK 69 GC 631-1292  
 1293 W BURKE AVE  
 MCKAY SALLY JEAN 70 CLA 224-0144  
 110 W BERNARD  
 MCKAY SANDRA THOMAS LE 71 DULTH 727-3367  
 2730 DUPONT S  
 MCKAY TERRYANNE GRACE 71 DULTH 727-3367  
 2236 W 11TH ST  
 MCKEE HARRY HARRISON 3 69 GC 698-3978  
 682 KENNETH  
 MCKEE JAMES ROLLAND  
 CENTENNIAL HALL  
 MCKEE MARGARET ANN 70 CLA 823-4984  
 5101 TENTH AVE SO  
 MCKEE MARY CATHERINE 71 CLA 537-2815  
 3837 MAJOR AVE NO  
 MCKEEN CHARLES DALE 71 IT 537-5959  
 7659 49TH AVE N  
 MCKEEN DAVID ARTHUR 68 GC 699-5843  
 1324 SARGENT AVE  
 MCKEEN GLORIA BLAISDEL 68 ED  
 MCKEEN JOHN EDWIN 70 IT 224-0815  
 911 GODDRICH  
 MCKEEN MARY CATHERINE 69 ED 824-0082  
 5448 10TH AVE SO  
 MCKEEVER PATRICK JOSEF 68 VET M 615-5346  
 2110 KNAPP ST  
 MCKELLAR BONNIE LYNN 71 CLA 331-1099  
 1302 7TH ST SE  
 MCKELLIP GARY WILLIAM 68 GC 474-7959  
 RT 5 BOX 122 W  
 MCKENNA BONNIE LOU 68 CLA 451-7711  
 757 21ST AVE NO  
 MCKENNA CAROL ANN 70 AGFHE 929-8814  
 5603 BENTON AVE  
 MCKENNA DAVID WILLIAM 70 LAW 373-6401  
 TERRITORIAL HALL  
 MCKENNA PETER JAMES 69 DULTH 525-1628  
 5411 JAY ST  
 MCKENNA SUSAN ALLISON 71 CLA 929-8814  
 5603 BENTON AVE SO  
 MCKENNEY JANICE SUE 68 AGFHE 644-4222  
 1387 N CLEVELAND AVE  
 MCKENZIE DARLEEN RAE 71 CLA 588-9338  
 3415 MAJOR AVE NO  
 MCKENZIE KAREN LEE  
 COMSTOCK HALL  
 MCKENZIE THOMAS GRANT 69 IT 331-2427  
 708 UNIV AVE SE  
 MCKEON JOHN STEPHEN 68 CLA 521-2022  
 3228 KNOX AVE NO  
 MCKEON KATHLEEN MAE 68 ED  
 MCKEON MICHAEL JOHN 68 DULTH 728-2498  
 1907 GREYSOLON RD  
 MCKIBBAGE GORDON JOSEF 70 CLA 724-6644  
 3633 19TH AVE SO  
 MCKIBBEN CORINNE LEE 70 AGFHE 645-9241  
 307 AN BAILEY HALL  
 MCKIBBEN MARY MYERS VI 71 DULTH 727-6636  
 4629 BROWNDALE AVE S  
 MCKIBBON SANDRA KAY 69 ED  
 914 E 2ND ST  
 MCKIERNAN JEANNETTE LO 71 DULTH 722-2023  
 502 N 22ND AVE W  
 MCKINH TERRY GUY 70 CLA  
 CENTENNIAL HALL  
 MCKINLEY PATRICIA ANN 69 DULTH 771-2010  
 41 MORNINGSIDE DRIVE  
 MCKINNEY CAROL ANN 71 CLA 869-8752  
 1412 W 61 ST SW  
 MCKINNEY JAMES CLAYTON 68 CLA 331-7920  
 10020 12TH AVE SE  
 MCKINNEY JUDITH ANN 71 AGFHE 222-5998  
 1162 BELLOWS  
 MCKINNEY MICHAEL WILLI 68 GC 929-5687  
 1617 UNIVERSITY AVE SE  
 MCKINNEY ROBERT ODELL 71 CLA  
 FRONTIER HALL  
 MCKINNIE CATO ALLEN 68 GC 545-7111  
 1315 ZEALAND AVE NO  
 MCKINNON RONALD ALLAN 69 CLA 728-4728  
 137 GREENWOOD ST  
 MCKNIGHT MARGARET JEAN 69 CLA  
 801 UNIVERSITY AVE SE  
 MCKOWEN CRIGHTON JOHN 69 GC 588-5154  
 3420 PARKVIEW BLVD  
 MCKOWN JUDITH JEAN 71 CLA  
 SANFORD HALL  
 MCKOWN RICHARD FRED 68 GC  
 7413 PILLSBURY AVE SO  
 MCKUSKY WILLIAM BERNAR 68 IT 331-7931  
 515 10TH AVE SE  
 MCLACHLAN MURRAY CHARL 70 CLA FE1-1114  
 1617 UNIVERSITY AVE SE  
 MCLAGAN MARK ROYAL 70 CLA 451-0569  
 213 DESSA LN  
 MCLAIN HARVEY THOMAS 69 ED 338-4938  
 220 3RD AVE SE  
 MCLAIN LINDA SUSAN 71 DULTH 724-3834  
 109 W TOLEDO ST  
 MCLANE LAVONNE RAE 68 GC  
 MCLAREN JOHN ALEXANDER 70 IT  
 FRONTIER HALL  
 MCLAUGHLIN DANIEL BRUC 68 IT 331-9918  
 212 WALNUT ST  
 MCLAUGHLIN JAMES M 70 CLA 331-5467  
 1515 UNIVERSITY SE  
 MCLAUGHLIN JEFFREY BRI 70 CLA 331-3432  
 1115 5TH ST SE  
 MCLAUGHLIN JOHN WILSON 70 CLA 927-4840  
 4213 SO CEDAR LK RD  
 MCLAUGHLIN KEITH RAY 70 AGFHE 774-8233  
 1344 FREMONT AVE  
 MCLAUGHLIN MAUREEN ANN 69 GC  
 MINNETONKA  
 MCLAUGHLIN MICHAEL C 69 PHARM  
 390 W COTTAGE AVE  
 MCLAUGHLIN RANDY WILLI 71 CLA 439-2914  
 811 W WILLARD  
 MCLAUGHLIN TIMOTHY SEA 71 CLA 331-3432  
 1115 5TH ST SE  
 MCLAUGHLIN WARREN DONA 69 BUS  
 809 6TH ST SE  
 MCLEAN JOHN STANLEY 69 CLA 771-4838  
 1110 CASE AVE  
 MCLEAN SUSAN CATHERINE 70 CLA 455-5313  
 1005 16TH AVE NO  
 MCLEAN THOMAS GRANT 70 DULTH 525-4645  
 910 NORTHLAND AVE  
 MCLEAN THOMAS JAMES 70 CLA 771-1895  
 784 E NEVADA  
 MCLEAN VERONICA MARIE 70 CLA 225-8765  
 730 LINCOLN AVE  
 MCLEAN WILLIAM ROBERT 70 CLA 644-3213  
 1230 HEWITT AVE  
 MCLEES JUDITH ELAINE 71 DULTH  
 305 ARROWHEAD RD  
 MCLEISTER BONNIE CECIL 71 CLA 822-0288  
 4900 LYNDALE SO  
 MCLEISTER JULIE MARGUE 71 CLA 822-0288  
 4900 LYNDALE AVE SO  
 MCLELLAN DONN SCOTT 71 DULTH  
 1975 EUSTIS ST  
 MCLELLAN KATHRYN JEAN 68 CLA 545-1112  
 2929 MERLEN DR  
 MCLENNAN JANE FRANCIS 70 DULTH 724-3664  
 1912 WOODHAVEN LANE  
 MCLENNAN KATHERINE GLE 71 CLA 781-1237  
 3413 WILSHIRE PL NE  
 MCLEOD GARY WAYNE 70 IT 533-8388  
 5511 QUAIL AVE NO  
 MCLEOD JAMES DOUGLAS 68 MED FR4-3564  
 4535 ROANOK RD  
 MCLEOD ROBERT JEFFREY 70 LAW 374-3564  
 4535 ROANOK RD  
 MCLINN PETER MICHAEL 69 DENT WA6-1591  
 4509 DUNHAM DR  
 MCLISH MICHAEL BRUCE 71 DULTH 724-2530  
 114 CHESTER PKWY  
 MCLUEN PATRICK JOHN 71 CLA 436-8964  
 RIVER CREST RD RT 5  
 MCMAHAN ANDREW KNIGHT 71 DULTH 727-6636  
 727 15TH AVE SE  
 MCMAMILL PAUL HENRY 68 IT  
 2320 25TH AVE SO  
 MCMAHON CHRISTINE SHER 71 CLA 488-7176  
 2202 NO DALE ST  
 MCMAHON JUDITH MAY 71 CLA 722-7931  
 3710 MINNEHAHA AVE SO  
 MCMAHON KATHLEEN JOY 70 CLA 698-5812  
 118 AMHERST ST  
 MCMAHON KAY ELLEN 70 DULTH  
 HOPKINS  
 MCMAHON MARY KATHLEEN 70 CLA 822-7069  
 4139 WENTWORTH AVE SO  
 MCMAMON MICHAEL JAMES 70 CLA 949-9588  
 5304 29TH AVE SO  
 MCMAMON RICHARD WAYNE 69 DULTH 724-2709  
 207 E WADENA ST  
 MCMAMON ROSE MARY 70 AGFHE 222-2306  
 1351 MANOMIN  
 MCMAMON SR MARIE MARCE AS ED  
 GRAD 439-5859  
 BPT BAYPORT  
 MCMANUS BRUCE WILLIAM 69 DULTH 729-8855  
 516 SO 4TH ST  
 MCMANUS CARY PATRICK 69 DULTH 729-8855  
 RT 4 BOX 469L  
 MCMANUS DAVID CHARLES 71 CLA  
 338 SO CLEVELAND  
 MCMANUS ELAINE MARIE 70 CLA  
 718 UNIV AVE SE  
 MCMANUS MICHAEL GEORGE 70 DULTH 729-8489  
 4489 MIDWAY RD  
 MCMANUS TERRY LOUISE 69 CLA 699-7672  
 1722 GRAND AVE  
 MCMANUS THOMAS PATRICK 70 CLA 699-1903  
 338 SO CLEVELAND  
 MCMARTIN JAMES ANDREW 71 IT 693-8426  
 TERRITORIAL  
 MCMARTIN JOHN EDMOND 70 CLA 439-2578  
 410 W SYCAMORE  
 MCMASTERS RICHARD DWBN 69 VET M 644-9608  
 2204 DAYTON AVE  
 MCMILLAN DAVID DUNCAN 70 LAW 645-1244  
 1631 CARL ST  
 MCMILLEN MAUREEN CECIL 71 CLA 823-2481  
 3213 E CALHOUN BLVD  
 MCMILLEN ROBERTA ANN 70 CLA 920-4108  
 5501 NEWTON  
 MCMILLIN BARBARA LEE 71 CLA  
 1777 EDGERTON  
 MCMILLIN DONALD RICHAR 68 ED 776-0456  
 1777 EDGERTON  
 MCMINN DENNIS GORDON 71 CLA 451-2618  
 525 12TH AVE SO  
 MCMOY PATRICIA JILL 71 AGFHE 644-1174  
 2074 COMD AVE  
 MCMULLEN WARREN MATTHE 71 DULTH 644-2453  
 1717 FRY ST  
 MCMUNN JOHN CARTER 70 CLA  
 8 PENN AVE SO  
 MCMURTRY ANITA LOUISE 70 CLA  
 8 PENN AVE SO

MCURTRY LARRY GLEN 8 PENN AVE SO MCNABB MICHAEL WILLIAM FRONTIER HALL MCNABB TERRY WILLIAM RT 1 LOBSTER LAKE MCNAIR MICHAEL DOUGLAS 1122 COMO AVE SE MCNALLAN NANCY LEE 3813 THOMAS AVE SO MCNALLY PATRICK JAMES MCNAMARA JAMES DENNIS MCNAMARA JEAN OLDHAM 4813 W SUNNYSLOPE RD MCNAMARA JOHN RICHARD 106 W GERANIUM MCNAMARA KAREN LEE 4144 20TH AVE SO MCNAMARA MICHAEL JAY 2327 CHAMBERSBURG AVE MCNAMARA MICHAEL JOHN 4144 20TH AVE SO MCNAMARA THOMAS MICHAEL 106 W GERANIUM MCNAUGHTON SUSAN AGNES 1743 FREMONT AVE MCNEAL SHERRY RAE 3500 ULYSSES ST NE MCNEE ARTHUR WILLIAM 1815 UNIVERSITY SE MCNEELY DANIELLE JEAN 1921 BOHLAND AVE MCNEELY DIRK LINSEY PIONEER HALL MCNEELY GREGORY FRONTIER HALL MCNEIL ALICE ELIZABETH 1177 LAUREL AVE MCNEIL NANCY JO 1012 5TH ST SE MCNEIL WILLIAM DOUGLAS MCNEILL DENNIS RAY MCNEILL DERRY KEVIN 1454 W SKILLMAN MCNEILL SANDRA SUSAN 1575 ST PAUL AVE MCNEILLY GREGORY LYNN CENTENNIAL HALL MCNELLIS KATHLEEN CARE MCNELLIS SUSAN KAY 855 W IDAHO MCNELLY FREDERICK WRI 106 W 7TH MCNELLY WILLIAM ROBERT 2621 HUMBOLDT AVE SO MCNICOLAS MAUREEN ANN 1206 LINCOLN SO MCNISH ROBERT JAMES JR 5650 ZEALAND AVE N MCNULTY MICHAEL JAMES 1186 BURKE MCNULTY THOMAS MICHAEL MCNURLAN MARION 5032 HARRIET AVE SO MCPARTLAND JOHN WILLIAM 1407 SUMNER ST MCPARTLIN ROBERT JOSEPH MCPARTLIN THOMAS HUGH 724 3RD AVE SE MCPECK LARRY JESS 5649 JAMES SO MCPECK WALTER AMOS MCPHERSON CAROL WENDT MCPHERSON NANCY LEE CAMDEN HALL MCPHILLIPS SR REGINA M COMSTOCK HALL MCQUADE EDGAR M 3835 THOMAS AVE SO MCQUEEN KATHLEEN LOIS 1909 SARGENT MCQUILLAN BRIDGET ROSE 1142 SELBY MCQUILLAN PATRICIA JEA 7201 OAKLAWN MCQUISTON MARY GLENNIS 311 10TH AVE SE MCRAE JAMES ANDREW JR 2841 MARION ST MCRAVEN DONALD JR MCRAVEN JACQUELINE ANN 681 DUPONT NO MCREYNOLDS DORIS JANET 2220 16TH AVE S MCREYNOLDS WILLIAM IRV 2220 16TH AVE SO MCROBERTS DIANE MARIE MCROBERTS KATHLEEN LAU 1096 NEVADA AVE	68 IT 374-2259 MPL WELCOME 71 CLA MPL DMAHA NB 71 MORRS 834-2636 MINNEAPOLIS 70 LAW MPL FARGO ND 71 CLA 926-7416 MPL MINNEAPOLIS 70 MORRS CHOKIO 69 DULTH HASTINGS 70 CLA 920-3073 EDN EDINA 70 CLA 488-3475 STP ST PAUL 68 ED 729-4902 MPL MINNEAPOLIS 71 DULTH 727-3778 DULUTH 70 CLA 729-4902 MPL MINNEAPOLIS 71 CLA 488-3475 STP ST PAUL 70 CLA 774-3552 STP ST PAUL 70 CLA 781-2958 MPL MINNEAPOLIS 69 CLA 331-5946 MPL MINNEAPOLIS 68 GC 699-6181 STP ST PAUL 69 ED MPL LUVERNE 69 GC 429-7682 MPL WHITE BEAR LAKE 71 CLA 646-2119 STP ST PAUL 70 CLA 331-9760 MPL EDINA GRAD 69 BUS 71 CLA 646-0215 RDV ROSEVILLE 70 CLA 699-6762 STP ST PAUL 70 CLA MPL MORA GRAD 70 CLA 489-5586 STP ST PAUL 69 MORRS 589-1446 ALBERT LEA 68 IT 377-7024 MPL CROSBY 68 ED 374-3006 MPL OAK LAWN IL 68 LAW 533-4983 MPL AS CLA 489-5570 MPL MINNEAPOLIS GRAD 71 CLA 824-0680 MPL MINNEAPOLIS 70 CLA 699-8741 STP ST PAUL 71 IT 68 MED 338-7380 MPL ST PAUL 71 CLA MPL MINNEAPOLIS 70 CLA 70 CLA 69 MORRS 589-1030 ORTONVILLE 68 PH MPL MARYKNOLL NY GRAD 927-7485 MPL MINNEAPOLIS 70 AGFHE 698-8085 STP ST PAUL 71 CLA 645-5691 STP ST PAUL 70 CLA 920-5249 EDN EDINA 70 CLA 333-7285 MPL ST PAUL 71 CLA 484-9093 RDV ROSEVILLE 68 GC AS GC 377-0280 MPL GRAD 729-2028 MPL SPRINGFIELD OR GRAD 729-2028 MPL 70 MORRS HOWARD LAKE 70 MORRS HERMAN	MCROBERTS RAYMOND SPEN 5724 PENNSYLVANIA AVE MCROBERTS RONALD EDWARD MCROBERTS THOMAS BLANE 204 E 3RD ST MCSHANE JAMES THOMAS 819 SO 1/2 AVE NE MCSHANE JEREMIAH EDWARD 819 SO 1/2 AVE NE MCSHANE JOHN MICHAEL 2908 SALEM AVE MCSHANE MICHAEL BERNARD 409 UNIVERSITY AVE SE MCSHANE THOMAS JAMES FRONTIER HALL MCSHANNOCK KATHLEEN ANN 1820 E ARLINGTON MCSHERRY THOMAS LYLE 355 DEMONT AVE MCSHERRY THOMAS MICHAEL 355 DEMONT AVE E MCSWEENEY SALLY MARTHA 3028 EWING SO MCSWIGGEN MARGARET MAR MCTAGGART SUSAN ELIZABETH 1121 SE 5TH ST MCTEAGUE TERRANCE RICH 1382 WELLESLEY AVE MCVAY TIMOTHY WILLIAM 3839 SHERIDAN MCVEY CHARLES RONALD 1618 EUSTIS MCVEY SUZANNE BROWN MA 1618 EUSTIS MCWATERS ROGER WARREN 1166 FIFIELD ST MCWILLIAMS CAROL ANN BAILEY HALL MCWILLIAMS MAURA ANN 1801 FRANKLIN AVE SE MEACHAM KAREN RAE MEAD BRENT JAY 315 16TH AVE SE MEAD BRYAN RUSSELL 7201 GRAND SO MEAD EVONNE MARIE 708 5TH ST SE MEAD MARSHALL JOHN GRIGGS HALL C311 MEAD PHILIP HARRY 1724 ROLLINS AVE SE MEADE BRONWEN ELIZABETH 4415 DUPONT SO MEADE JOHN GREGORY MEADE JOHN JOSEPH 4564 ZENITH AVE NO MEADOWS HARRY 3441 EMERSON AVE SO MEAGHER PATRICK D 708 5TH ST SE MEAKINS BEVERLY ANN BURNTSIDE HALL 105 MEALEY KATHLEEN ANNE 3446 STINSON BLVD NE MEALEY KATHLEEN JEANNE 833 E RIVER RD MEALEY ROBERT CAREY 1640 E 7TH MEALEY THOMAS PATRICK 3446 STINSON MEALEY WILLIAM FRANCIS 3446 STINSON BLVD MEANS RODNEY JEROME 691 FIRST AVE NW MEANY JANET OLSON 10520 N SHORE DR MEANY MARGARET MARY 8600 COLFAX AVE SO MEANY PATRICIA DOROTHY 3146 W CALHOUN BLVD MEARS NORMAN POWELL MEARS THOMAS VAL MEBUST BRUCE LYNN BLAKELY HALL MECHELKE CRAIG LOREN 2850 NO MCKNIGHT RD MECHELKE LARRY ALLEN 2850 N MCKNIGHT RD MECHELKE RICHARD LEE 720 12TH AVE SE MECHLER GREGORY PAUL MECHLER TERESA JEAN 3144 PENNSYLVANIA AVE MECHON GEORGIA RENE 1908 E 3RD ST APT2 MECHTEL JEAN HELEN 7533 CARMEN AVE HECKLENBURG SUSAN LEE 636 STEWART AVE MEDBERY GLEN BENNER MEDCALF LINDA KAY 6933 OLIVER AVE SO	68 IT KEY-7003 CYT CRYSTAL 69 MORRS HERMAN 68 MORRS 589-2600 MINNEAPOLIS 70 CLA 788-8533 MPL MINNEAPOLIS 71 CLA 788-2823 CLH COLUMBIA HTS 68 IT 922-1900 SLP ST LOUIS PARK 70 LAW 331-1498 MPL WASECA 71 CLA MPL WASECA 70 AGFHE 776-7861 STP ST PAUL 70 IT 484-5744 LTC LITTLE CANADA GRAD 484-5744 STP 68 GC 926-0939 MPL MINNEAPOLIS 71 CLA MINNETONKA 69 ED 331-1381 MPL BRAINERD 71 CLA 698-7376 STP ST PAUL 71 CLA 920-7238 MPL NORTHFIELD GRAD 645-1521 STP ST JOSEPH MO 68 OT 645-1521 LRD TOPEKA KS GRAD 644-6612 STP CROOKSTON 69 AGFHE 645-9241 STP FISHER 70 CLA 336-0490 MPL HIBBING 70 AGFHE 70 CLA MPL RED LAKE FALLS 68 GC 866-8947 RHF RICHFIELD 69 AGFHE 331-9726 MPL SEWARD NB 70 DULTH 724-9880 WADENA GRAD 70 CLA 588-0071 MPL MINNEAPOLIS 70 CLA 823-7370 102 MPL BECKLEY WV GRAD 331-9768 MPL MATTOON WI 71 DULTH 724-9914 EXCELSIOR 69 GC 781-4075 MPL MINNEAPOLIS 70 CLA MPL NORTH ST PAUL 70 CLA 774-3348 MPL MINNEAPOLIS 69 GC 781-4075 MPL MINNEAPOLIS 69 BUS 781-4075 MPL MINNEAPOLIS GRAD 633-8495 NWB ROTHSCHILD WI AS DULTH 525-5584 DULUTH 71 CLA 888-4776 BLT BLOOMINGTON 69 ED 920-7354 MPL ROSE CREEK 70 DULTH ST PAUL GRAD 71 MORRS 589-3121 GLENWOOD 70 CLA 777-3794 NSP NORTH ST PAUL 69 GC 777-3794 NSP NORTH ST PAUL 69 GC 331-4533 MPL STILLWATER 69 BUS 71 CLA 929-6475 S SLP ST LOUIS PARK 68 DULTH 728-2046 ELY 69 GC 451-8152 ING INVER GROVE 68 AGFHE 451-7502 SSP SOUTH ST PAUL 68 CLA 71 CLA 869-9530 RHF RICHFIELD	MEDCALF THOMAS WILLIAM 69 BUS MEDCHILL CLARICE V 4096 MEADOWBROOK LANE MEDCRAFT NANCY GAYLE 979 W SMERREN ST MEDELMAN JOHN PAUL JR 655 GOODRICH AVE MEDEENWALDT BARBARA JEA 796 WINSLOW AVE MEDEENWALDT GLENN ERVIN 796 WINSLOW MEDER CHERYL ANN COMSTOCK HALL MEDIN DANIEL LEE MEDIN GARY RUSSELL 521 DIAMOND LK LA MEDIN THOMAS ALLEN 1428 5TH ST SO MEDINA JOSE RODRIGO MEDLAND MICHAEL BARCRO 625 15TH AVE SE MEDLIN W MICHAEL 928 LAKE AVE SO MEDLOCK GEORGIA ANN 3733 4TH AVE S MEDNIS ASTRIDE ILZE 4049 17TH AVE SO MEDNIS HAROLD IVARS 1122 8TH ST SE MEDVED CHARLES WILFORD 1132 COLLETTE PL MEDVED JOHN PAUL 815 13TH AVE SE MEE MICHAEL FRANCIS MEEHAN SUSAN LEONA 1215 OAKBURY RD MEEHAN THOMAS KEVIN 1319 7TH ST SE MEEHL NANCY NORINE 1623 CARL IB MEEK SUSAN ANN HELEN PIONEER CT MEEK THOMAS BLDG 55 MEES HENRY BENJAMIN MEES JAMES OTTO 715 6TH ST SE MEGARRY WILLIAM JOHN 505 HUMBOLDT AVE NO MEGEE RALPH DAVIDSON 3 2044 BREWSTER MEGLICH MARY KATHLEEN 713 15TH AVE SE MEHAFFEY DAVID JAMES 3128 HARRIET SO MEHIGAN PATRICIA KATHL 509 8TH AVE SE MEHL CYNTHIA SUE GAY HALL MEHL MONICA ANN BURNTSIDE HALL 105 MEHLHOUSE MARY ALICE SANFORD HALL MEHLING MARTIN DAVID 2202 E 2ND ST MEHRAN FARHAD 3306 CENTENNIAL HALL MEHRKENS JOSEPH ROY 415 E BAILBY HALL MEICHSNER MARCIA THARA AS MORRS MEIDAL CLAUDIA ANN 2327 WILKYNS AVE MEIER BARBARA JEAN 241 15TH AVE N MEIER DAVID LEO 5713 40TH AVE SO MEIER JOHN SANFORD 1815 UNIVERSITY AVE SE MEIER JON BRADLEY 718 IOMA AVE MEIER MARVIN DBAN 822 E 9TH ST MEIER PHYLLIS MARGARET 3640 GEORGIA AVE NO MEIER SHARON HULDA SPOONER HALL MEIER STEVEN FRANK 5036 OLIVER SO MEIER WESLEY ROGER 2101 KNAPP MEIERBACHTOL BRIAN JOH 71 CLA 922-8037 MPL MINNEAPOLIS 69 GC 335-1539 MPL 71 IT 373-6943 MPL WOOD LAKE 70 IT 522-0373 MPL MINNEAPOLIS 69 DULTH AUSTIN 71 CLA 824-4927 MPL MINNEAPOLIS
--	---	--	--	--





MEZZ JONATHON ARNY 1000 18TH AVE SE MEZZENGA SUSAN MARY 2701 BRIGHTON AV NE MHIRIPIRI STANLAKE REX 515 DELAWARE SE APT 104 MIAD ANTONID 3755 JOPPA AVE MICCICHE PASQUALE EUGE 315 RAVOUX ST MICCOLIS JOSE MARIA FO 2049 KNAPP MIGELI ANTHONY RUSSELL 659 LINCOLN ST NE MICHAEL ELAINE 947 DAYTON MICHAELIS DENNIS GEORG 5528 NOKOMIS AVE MICHAELS GRETA BROCKHA 2180 W HOYT AVE MICHAELSON PAUL DAVID 704 E 131ST ST MICHAELSON RICHARD EAR 7 W NO CLOQUET RD MICHALIK JOHN JAMES 2531 35TH AVE SO MICHALOV CHARLES JOHN 2319 HARDING NE MICHALS JACK TERRY 525 10TH AVE SE MICHALSKI BEVERLY KAY 348 W PAGE ST MICHALSKI CHERYL ANN 1811 E NEBRASKA AVE MICHALSKI DAVID ROBERT BREWSTER HALL MICHALSKI PETER ANTHON 413 OAK ST SE MICHALSKI ROGER ALLEN 1433 JEFFERSON ST NE MICHALSKI WILLARD JAME 430 N 84TH AVE W MICHAUD CAROL JEAN 5458 NO LEXINGTON MICHAUD GREGORY LEE 5139 KIMBERLY RD MICHAUD JULIE ANNE 5438 NO LEXINGTON MICHAUD MERIDITH ANNE 505 UNIVERSITY AVE SE MICHAUD MICHAEL JOHN 1095 JUND AVE MICHEL MARY CANDIDA PIONEER COURT MICHEL MARY CRESCENCE PIONEER COURT MICHELETTI ROBERT STEP  MICHELICH ROBERT JAMES CENTENNIAL HALL MICHELS BERNARD LEO 510 COVENTRY MICHELS JEANETTE LEDNA 982 15TH AVE SE MICHELS KATHLEEN ANN 3811 DARTMOUTH DR MICHELS LESTER DAVID PIONEER HALL MICHELS PEGGY ANN 624 1/2 ATLANTIC MICHELSON ANNE LOUISE 1410 N CENTRAL AVE MICHELSON DEAN RICHARD 2450 HEIMEL SO MICHELSON FRANCES ISAB 2349 1/2 LONG AVE MICHELSON LAUREL HOPE 1216 DOUGLAS AVE MICHELSON RONALD W 4645 33RD AVE SO MICHIE BONNIE WALKER C 7432 CLOMAN WAY E MICHIE THOMAS WILLIAM TERRITORIAL HALL MICHL RUTH MARY 317 12TH AVE NO MICKA WILLIAM FRANK 413 5TH ST SE MICKELBERG RONALD CORN 3820 MACALASTER DR NE MICKELSEN KENNETH JAME 5325 LOGAN AVE S MICKELSEN MARGARET LYN 2430 GREYSOLON RD MICKELSEN PAUL LEE  MICKELSEN PEGGY DIANE  MICKELSEN ROBERT GLENN 323 7TH ST SE MICKELSON CONNIE LOUIS 1561 SHERWOOD MICKELSON CURTIS JAMES 2835 PASCAL MICKELSON JAMES WELDON 2018 E 2ND ST MICKELSON JOAN MARIE 3204 HUMBOLDT SO MICKELSON JOAN MARIE 417 LOGAN AVE NO  MICKELSON KAREN SUE 3204 HUMBOLDT AVE S MICKELSON LARRY GORDON 1985 STILLWATER ST MICKELSON PATRICIA SUS 5516 30TH AVE SO MICKELSON PETER JAMES  MICKELSON PHILIP JULIA 1751 WOODLAND AVE MICKELSON STEPHEN HARO 10143 FREMONT AVE SO MICKELSON STEVEN BRUCE 4539 WASHBURN NO MICKELSON THOMAS HARTI 3808 ADAIR AVE N MICKETTS JAMES PAUL 3324 HENNEPIN AVE SO MICKLE DENNIS IRWIN 1427 E 4TH ST MICKLIN DAVID STEWART CENTENNIAL HALL MICKLIN RITA RAE 801 UNIV AVE SE KIDDLEBROOKS BURTON ST 5124 W 105TH ST MIDDLECAMP CHERYL ANN 204 11TH AVE NO MIDDLECAMP DAVID ERIC 204 11TH AVE NO MIDDLETON DANIEL EMERS 2610 UTICA AVE SO MIDJE HOWARD CYRUS 1280 DELAWARE AVE MIDTHUM KATHLEEN ANN 2320 E I ST MIDURA DANIEL WALTER 5320 12TH AVE S MIELKE DALE EDWARD  MIELKE LOWELL OMAR 3223 FILLMORE ST NE MIELKE PETER HERMAN 628 ERIE ST SE MIELKE RAYMOND WALTER GAY HALL MIELKE RICHARD LEE 1210 RANDOLPH AVE MIELS THOMAS RICHARD 2173 ST CLAIR AVE MIER DONALD KEITH  MIER LINDA ONTECO  MIERNICKI MICHAEL STEP 2768 WELLINGTON ST MIES THOMAS PASCHAL  MIESBAUER JAM MARY 1140 50TH AVE NE MIEST GARY GLENN  MIETTINEN OLLI SAKARI  MIGATZ MICHAEL EDWARD  MIHALCHICK BARBARA ANN 3539 TAYLOR ST NE MIHALCHICK CASANDRA MA 3910 WASHBURN AVE NO MIHM CHERYL LOUISE 5050 RUSSELL AVE NO MIHM DOUGLAS GENE 428 N 21ST AVE E MIHM GEORGE MICHAEL 1677 CARL ST MIHM JOHN ANDREWS 1627 CARL ST MIKAN EDWARD TERRY FRONTIER HALL MIKAN GEORGE LAWRENCE 1011 4TH ST SE MIKE JOHN JOSEPH  MIKEL DOUGLAS PETER TERRITORIAL HALL MIKKELSEN CELIA JANE 711 15TH AVE SE MIKKELSON BRIAN LEE 4709 UTAH AVE NO MIKKELSON JEFFREY ALLE 10354 GRAND AVE SO MIKKELSON SUSAN KAY 5863 BLAISDELL MIKLASEVICS GEORGE E 2111 E 33RD ST MIKLE DAVID EDWARD 937 JAMES AVE MIKOLICH CHARLES ANTHO 6393 HIGHWAY 65 NE MIKRUT MARGUERITE ANN 311 S 60TH AVE W MIKSICH JOHN MICHAEL 212 WALNUT ST SE MIKUCKI JULIE ALICE 801 SO MEADOW LN MIKULECKY GARY ANDERSO 1208 7TH ST S  MIKUNDA RICHARD STEPHE 6920 LOGAN SO MILANOVICH KATHRYN THE 68 NURS  MILAVETZ JUDY COMSTOCK HALL MILBECK ARDYCE MARY  MILBERT MARCIA LOU 708 5TH ST SE MILBERT MICHAEL CHARLE 7244 15 AVE SO MILBRADT LINDA JOSEPHI SANFORD HALL MILBRATH DAVID EDWIN 2265 SNELLING AVE NO MILBRATH DEAN STANFORD 3789 HWY 194 MILBURN MICHAEL ROBERT 2229 COMO AVE MILBURN STEPHEN ALLEN 2229 COMO AVE MILDENBERGER JOSEPH JA 5860 WENTWORTH AVE SO MILDON KERRY RANDAL 7220 QUEEN AVE SO MILEK PERRY OTTO 1300 POWDERHORN MILER DANIEL ROSS 1565 LAUREL MILES CHARLES WINTHROP  MILES DANIEL JOHN 5657 43 AVE SO MILES DIANA BRUCE 136 20TH AVE NO MILES GARY GARLAND TORRANCE HALL 232 MILES JAMES HOWARD 421 CEDAR AVE SO MILES LILLIAN PAIGE 415 4TH ST SE MILES ROBERT JOHN 5139 33RD AVE NO MILEY NANCY EILEEN 2183 ROSELAWN AVE MILGROM JACALYN 1040 13TH AVE SE MILICH DAVID MICHAEL 2421 CHAMBERSBURG MILJEVICH NICK  MILKOVICH GEORGE THOMA 5045 15TH AVE SO MILLAM CAROLE LYNN  MILLAM ELAINE R LARSEN 1990 OAK ST MILLAR SUZANNE RHOADS 101 GLEASON LAKE RD MILLARD GEORGE BENZ  MILLARD WILLIAM ELLSWO 1115 5TH ST SE MILLBEN STEPHEN MICHA FRONTIER HALL MILLER AARON PAUL  MILLER ABBY SUE  MILLER ALAN EDWARD TERRITORIAL HALL MILLER ANDREA S EURIST 52 GROVELAND TERR MILLER ANN MARIE JULIA 914 E 2ND ST MILLER ANNE THRESE 4482 N SNELLING MILLER BARBARA ANN 2067 CARTER AVE MILLER BARBARA BAILEY  MILLER BARBARA EUGENIA BOX 127 MILLER BARBARA FAYE 4803 7TH ST NE MILLER BERNETTE MARIE 5012 DUPONT SO MILLER BRONWYN CHERYL 700 10TH AVE SE MILLER BRUCE CLARK 1360 TERRACE DR MILLER BYRON KENNETH 1609 UNIVERSITY AVE SE MILLER CAROL ANN SANFORD HALL MILLER CAROL LEE 2906 N SNELLING MILLER CATHERINE MARY 4482 N SNELLING AVE MILLER CATHY ANN 915 6TH ST SE MILLER CHARLENE PEURA 2030 LAKEVIEW DR MILLER CHARLES WAYNE 1329 PACIFIC ST MILLER CHARLES WILLIAM 307 E 9TH MILLER CHERYL KAY PIONEER HALL  70 CLA 869-4029 RHF 68 NURS 68 ED MPL VIRGINIA 70 MORRS MONTEVIDEO 68 CLA FE1-4232 MPL SOUTH ST PAUL 70 CLA 866-6226 RHF RICHFIELD 71 CLA MPL REDWOOD FALLS 68 DENT 631-2644 STP DULUTH 71 DULTH 729-8046 DULUTH 68 GC 645-1121 STP ST PAUL 69 GC 645-1121 STP ST PAUL 68 GC 866-4472 MPL MINNEAPOLIS 71 CLA 866-2039 RHF RICHFIELD 68 GC PA1-1450 MPL MINNEAPOLIS 69 CLA 644-5129 STP ST PAUL 69 GC 71 CLA 724-8969 MPL MINNEAPOLIS 71 CLA 451-6658 SSP SOUTH ST PAUL 71 DULTH 724-9800 AITKIN 70 IT MPL MADISON WI 70 CLA MPL ST LOUIS PARK 70 IT 588-1471 GOV GOLDEN VALLEY 69 AGFHE 631-1685 ROV ROSEVILLE 70 CLA 332-1805 MPL MINNEAPOLIS 70 DULTH 722-6852 DULUTH 69 AGFHE EVELETH GRAD 825-2694 MPL 70 CLA WINONA 71 CLA 437-4971 HST AS AGFHE 473-3776 WAY GLADWING PA GRAD GRAD 339-2350 MPL AFTON WI 71 CLA MPL JACKSON MI GRAD 69 CLA 69 GC MPL CHESTNUT HIL MA 68 GC FR4-5172 MPL 71 DULTH 727-6636 LITTLE FALLS 70 CLA 633-1140 STP ST PAUL 68 ED 646-3970 STP LESUEUR GRAD 70 CLA MPP MAPLE PLAIN 69 GC 560-5056 CLH COLUMBIA HTS 71 CLA 823-3978 MPL MINNEAPOLIS 68 CLA 331-5842 MPL MINNEAPOLIS 68 CLA 633-0044 STP ST PAUL 71 CLA 331-1335 MPL LAKE PARK IA 71 CLA 864-4778 MPL GLENCOE 68 MORSC 922-6275 STP MINNEAPOLIS 71 CLA 633-1140 STP ST PAUL 71 CLA 941-1248 EDN EDINA GRAD 724-1740 DULUTH 68 AGFHE 771-6441 STP ST PAUL 68 MORRS 589-3319 DAWSON 69 CLA MPL WELLS
--

MILLER CHRISTINE LYNN 6024 ZENITH AVE SO MILLER CLARENCE ALPHON	70 ED EDN EDINA GRAD	927-9667	MILLER JANE LEE 1914 LINCOLN AVE MILLER JANET LYNN 1110 5TH ST SE MILLER JANET SUSAN PET 2075 AMES AVE MILLER JANICE DIANE 320 LAYMAN LANE MILLER JEFFREY HAROLD 2161 UPPER ST DENNIS MILLER JOADY ANN 3425 STINSON BLVD NE MILLER JOAN BARBARA 250 STONEBRIDGE MILLER JOAN LORRAINE 708 FIFTH ST SE MILLER JOANNE CARLSON 716 13TH AVE SE MILLER JOEL THOMAS	68 CLA STP ST PAUL GRAD MPL MORRIS 70 CLA 71 CLA 68 CLA STP ST PAUL 71 CLA 71 CLA 68 ED AS CLA 69 MORSC 69 GC SLP ST LOUIS PARK 69 IT MPL HIBBING 70 CLA STP ST PAUL 71 DULTH 70 CLA 71 CLA 69 BUS 69 GC 69 CLA SSP SOUTH ST PAUL 68 MORRS 71 PHARM 70 CLA 69 CLA 71 CLA 68 ED MPL MINNEAPOLIS GRAD MPL ST PAUL 71 CLA 71 CLA 70 CLA 70 CLA 69 MORRS 68 CLA 70 CLA 69 MORRS 68 CLA 71 CLA 71 CLA 68 ED 69 MORRS 68 CLA 69 MORRS 68 PH	699-7157 331-2175 735-1008 881-5141 699-9795 789-2696 698-6306 331-9725 MPL ROCHESTER MPL MINNEAPOLIS WHITE BEAR LAKE W6-7070 STP ST LOUIS PARK IT MPL HIBBING STP ST PAUL DULTH 624-3253 PROCTOR 935-6067 HOP HOPKINS 888-1211 BLT BLOOMINGTON 484-4765 ROY ROSEVILLE 927-8920 MPL MINNEAPOLIS 69 CLA SSP SOUTH ST PAUL 589-2345 LITCHFIELD 699-7157 STP ST PAUL 331-5890 MPL MINNEAPOLIS 331-3747 MPL ROCHESTER AGFHE 777-1128 MPW MAPLEWOOD 699-9123 STP ST PAUL 789-4237 MPL MINNEAPOLIS GRAD 339-0531 MPL ST PAUL 71 CLA MPL MINNEAPOLIS 771-9969 STP ST PAUL 71 CLA 426-3873 WTB WHITE BEAR LAKE 70 CLA MPL MINNEAPOLIS 69 MORRS JOHNSON 68 CLA 331-8532 MPL MINNEAPOLIS 70 LAW 544-6773 SLP NEW YORK NY GRAD 69 GC 338-9341 MPL AUSTIN 69 GC 771-9273 STP ST PAUL 70 CLA LRD HINCKLEY 69 CLA 488-3229 STP ST PAUL 68 CLA 926-3950 SLP ST LOUIS PARK GRAD 68 PH	70 LAW 824-4270 MPL COTTONWOOD 68 ED 338-1112 MPL MINNEAPOLIS 68 BUS 698-2335 STP ST PAUL 68 GC 222-0416 WSP WEST ST PAUL 68 IT 451-8104 SSP SOUTH ST PAUL 69 GC 68 NURS 68 ED 331-3387 MPL CHASKA 68 ED 646-4727 STP ST PAUL 71 IT MPL PINE ISLAND 70 CLA MPL GLENVIEW IL 70 CLA 922-9347 MPL MINNEAPOLIS 70 CLA 545-9012 GOV GOLDEN VALLEY 68 CLA 339-2376 MPL WACONIA GRAD 884-1737 BLT ST PAUL 68 DULTH PENASSE GRAD 70 CLA 774-5487 STP ST PAUL 70 CLA 421-6993 CNR COON RAPIDS 71 DENT ST PAUL 69 CLA 331-1114 MPL ST JAMES NY 68 GC 227-2096 WSP WEST ST PAUL 69 DULTH 865-6793 81WABIK 68 PH 69 MORRS MORRIS 69 CLA 745-0491 MPL MINNEAPOLIS GRAD 727-5379 DULUTH 68 ED 644-1248 STP ST PAUL AS ED GRAD MPL HARRISONBURG VA 68 AGFHE 645-6383 STP MONTGOMERY GRAD 377-9418 MPL LEE MA 70 CLA 338-4546 MPL RANDOLPH 68 MEDTC 338-5297 MPL OUTLOOK MT GRAD 721-7669 MPL 69 BUS 926-8568 SO MPL MINNEAPOLIS 68 GC 537-6909 BRP BROOKLYN PARK 70 CLA BENSON 69 DULTH 254-3000 CHISHOLM 69 GC 922-1149 MPL MINNEAPOLIS 71 CLA 474-6370 EXC EXCELSIOR 71 CLA MPL ELLENDALE 71 AGFHE GROVE CITY 71 CLA 473-6755 WAY WAYZATA 70 CLA 70 AGFHE 335-4762 70 CLA 451-0086 SSP SOUTH ST PAUL 70 CLA 545-9012 GOV GOLDEN VALLEY 68 IT LKL 71 AGFHE 757-4557 CNR HILLMAN 71 CLA 789-3125 MPL MINNEAPOLIS 70 AGFHE STP LESUEUR GRAD 721-7512 MPL MINNEAPOLIS 71 DULTH 724-9800 DEERWOOD 70 AGFHE 473-5594 WAY WAYZATA
MILLER CLIFFORD BION 4545 18TH AVE SO MILLER CORRIE DEE 2020 DOUGLAS DR MILLER CORTLAND RICHAR 1125 5TH ST SE MILLER CURTIS SMITH 321 GOLD ST MILLER CYNTHIA JANE 708 UNIVERSITY MILLER DALE PAUL P O BOX 1008 MILLER DANIEL HARVEY 1124 E 3RD ST MILLER DANIEL WILLIAM 2240 ENSIGN ST MILLER DAVID ERVIN 1403 NO HAMLINE MILLER DAVID JOHN 1849 PINEHURST AVE MILLER DAVID JOSEPH 325 SUNNYRIDGE LN MILLER DAVID STUART	69 CLA MPL 71 CLA GOV GOLDEN VALLEY 69 CLA MPL RICHFIELD GRAD 68 CLA MPL GROVE CITY 71 AGFHE STP MORRISTOWN AS DULTH 69 DULTH 70 CLA 68 BUS 68 IT GOV GOLDEN VALLEY GRAD	722-9353 544-3211 331-2792 724-3681 727-3344 646-4727 698-2335 374-3340 374-3340 935-3683 SLP ST LOUIS PARK 68 AGFHE 644-7974 ROV ROSEVILLE 69 GC 332-3854 MPL 922-5790 SLP ST LOUIS PARK GRAD 70 AGFHE GRAD 333-6072 MPL NEW YORK NY GRAD MPL GRAD 336-3479 MPL TAMPA FL 71 IT	MILLER JOHN ALLEN 3550 FRANCE SO MILLER JOHN EDWARD PIONEER HALL MILLER JOHN FREDERICK 1191 CALIFORNIA DR MILLER JOHN GRAHAM 211 1ST ST MILLER JOHN MICHAEL 3512 HOPKINS CROSSROAD MILLER JOHN MICHAEL 10007 XERES AVE SO MILLER JOHN PAUL 2778 LAKEVIEW AVE MILLER JOHN PETER 6213 CHOWEN AVE SO MILLER JOSEPH GEORGE 214 E MAC ARTHUR ST MILLER JUDY KATHLEEN GAY HALL MILLER JULIE ANN 1914 LINCOLN AVE MILLER KAREN ANNA 814 6TH ST SE MILLER KAREN SUE 316 12 ST SE MILLER KATHERINE AUDRE 1890 DIETER ST MILLER KATHLEEN ANN 1872 GRAND AVE MILLER KATHLEEN KRAEME 1838 HAYES ST NE MILLER KAY FRANCES POWELL HALL MILLER KENNETH BUDD 515 9TH AVE SE MILLER KENNETH RAY 1151 KENNAWD MILLER KENT DAVID JR 3840 E CD LINE RD MILLER LAIRD LEE 716 13 AVE SE MILLER LARRY DEAN 704 E 7TH ST MILLER LARRY GENE 2706 ESSEX ST SE MILLER LENORE LAST 2049 UTAH AVE S MILLER LEON KENNETH	69 GC 69 GC 69 CLA SSP SOUTH ST PAUL 68 MORRS 71 PHARM 70 CLA 69 CLA 71 CLA 68 ED MPL MINNEAPOLIS GRAD MPL ST PAUL 71 CLA MPL MINNEAPOLIS 771-9969 STP ST PAUL 71 CLA 426-3873 WTB WHITE BEAR LAKE 70 CLA MPL MINNEAPOLIS 69 MORRS JOHNSON 68 CLA 331-8532 MPL MINNEAPOLIS 70 LAW 544-6773 SLP NEW YORK NY GRAD 69 GC 338-9341 MPL AUSTIN 69 GC 771-9273 STP ST PAUL 70 CLA LRD HINCKLEY 69 CLA 488-3229 STP ST PAUL 68 CLA 926-3950 SLP ST LOUIS PARK GRAD 68 PH	MILLER DEBORAH KATHLEE 3024 AQUILA AVE SO MILLER DELBERT EVERETT 320 LAYMAN LANE MILLER DONALD PAUL 1842 RYAN MILLER ELIZABETH JEAN 1941 LAUREL MILLER ELIZABETH SCHMI 720 S 26TH ST MILLER ELLIOT LEWIS 2510 MONTEREY AVE SO MILLER ESTHER J MILLER EUGENE EDWARD MILLER FLOYD JOHN 1816 7TH ST SO MILLER FREDERIC HUNTING 66 23RD AVE SE MILLER FREDERICK CARL 1911 7TH ST SO MILLER GARY FREDERICK MILLER GARY JAMES 418 21ST AVE SO MILLER GARY LEES MILLER GARY MICHAEL 1711 UNIVERSITY AVE SE MILLER GARY THOMAS BAILEY HALL MILLER GEORGE ERNEST 1715 THOMAS AVE NO MILLER GERALD JOSEPH 7644 OAKLAND AVE SO MILLER GERALD MARTIN 316 4TH ST SE MILLER GLENN EDWIN 115 LA GRAND HOTEL MILLER GLENN EVAN 11304 RALEIGH CT MILLER GLENN LOREN 4300 110TH W MILLER GLENN WILLIAM 1722 PENN MILLER GLORIA RUTH 4244 5TH ST NE MILLER GORDON BERNARD 2300 GARFIELD ST NE MILLER GRANT DURWARD 565 DAYTON AVE MILLER HARRIS EDGAR MILLER HERBERT BERNETT 717 UNIVERSITY AVE SE MILLER HORACE GEORGE 2 11304 RALEIGH CT MILLER HUGO EUGENE 4550 CENTRAL AV NE MILLER IRA DAVID MILLER JAMES ANDERS 1137 BRAINERD AVE MILLER JAMES DALE MILLER JAMES DAVID 4620 TOWER ST MILLER JAMES DELMAR 1424 33RD ST W MILLER JAMES EDWIN 2111 21ST AVE SO MILLER JAMES FRANKLIN 1667 73RD AVE NE MILLER JAMES LEROY 257 BELDEN BLVD MILLER JAMES STEVEN 4222 BASSWOOD RD MILLER JAN ALEXIS 2034 GREENBRIER MILLER JANE EDWARDS 702 SYCAMORE	70 CLA SLP ST LOUIS PARK 68 AGFHE 70 CLA ROV ROSEVILLE 69 GC 332-3854 MPL 922-5790 SLP ST LOUIS PARK GRAD 70 AGFHE GRAD 333-6072 MPL NEW YORK NY GRAD MPL GRAD 336-3479 MPL TAMPA FL 71 IT 70 MED 335-1917 MPL BLOOMINGTON AS IT GLENCOE 70 CLA 331-7858 MPL FERGUS FALLS 71 AGFHE 238-2946 STP PLATO 71 MED 522-4680 MPL MINNEAPOLIS GRAD 866-1144 RHF AUSTIN 70 CLA 338-5949 MPL MINNEAPOLIS 68 MORRS 589-3322 SEBEKA 70 CLA 890-5790 70 CLA 888-6701 BLT BLOOMINGTON 71 CLA MPL MINNEAPOLIS 68 CLA 788-3747 CLH COLUMBIA HTS AS ED 789-0354 MPL JAMESTOWN NY 68 MED STP ST PAUL GRAD 68 CLA 333-6946 MPL HDPKINS 68 DENT. 890-5790 70 AGFHE 788-3558 HLT MINNEAPOLIS GRAD 70 DULTH 724-7121 DULUTH GRAD 71 CLA 920-2798 EDN EDINA 69 MED 822-7719 MPL OWATONNA 68 IT 338-5954 MPL PROCTOR 69 ED 786-2273 HOP PIPESTONE AS ED 459-5140 SPP 68 BUS 920-3535 MPL MINNEAPOLIS 71 CLA 774-1584 STP ST PAUL AS ED 425-6800 RVF





MOBERG CHRISTINE JULIA 5829 ABBOTT AVE SO MOBERG MARK THOMAS 325 HARVARD ST SE MOBERG PATRICIA TOBIN 2230 ZANE AVE N MOBERG PAUL AUGUST 3204 WENDHURST AVE MOBERG RICHARD ALLEN 4824 W 40TH LN MOBERG ROBERT JOHN 1284 MAYWOOD MOBERG ROGER KENNETH 221 W LARPEUR MOBERG WILLIAM MICHAEL 1478 BRANSTON MOBRATEN DAVID LELAND 1233 ROSE VISTA CT MOGIO MYROSLAVA 326 QUINCY ST NE MOCK JAMES ALVIN 1316 5TH ST SE MODEAN LARRY HAROLD 1991 KNAPP MODEN STEPHAN JOHN 5812 NEWTON AVE SO MODY RAGHUVIR JAGMOHAN	71 CLA 922-9033 EDN EDINA 71 MED MPL MINNEAPOLIS AS CLA 545-3191 GOV GOLDEN VALLEY 70 CLA 781-0471 STA ST ANTHONY GRAD 920-2134 SLP MINNEAPOLIS 70 CLA 489-7255 STP ST PAUL 69 BUS ROV MINNEAPOLIS 69 AGFHE MPL CLINTON 70 AGFHE STP FERGUS FALLS 68 GC 333-0026 MPL MINNEAPOLIS 70 CLA 338-9341 MPL HAWLEY GRAD STP 70 CLA 926-9778 MPL MINNEAPOLIS GRAD	MOEN JAMES MARCUS 1134 14TH AVE SE MOEN JOANNE HANSON RR 5 MOEN PETER ERNEST 2716 HENNEPIN AVE MOEN ROSS EARL 2128 W 105TH ST MOEN SELMER ORLEAN 11335 12TH AVE NO MOEN STEVEN MICHAEL 6024 BETHIA LANE MOEN WAYNE LEROY 5940 4TH ST NE MOENING JOAN ELLEN 1109 5TH ST SE MOERKE DIANE KAY P O 678 MOES NANCY JEAN 1754 EAST 6TH ST MOESLER HEINZ EMIL	AS BUS 331-9182 MPL MASON CITY IA 68 ED 421-0781 ANK 70 CLA 824-9019 MPL MINNEAPOLIS 69 CLA 881-8181 BLT BLOOMINGTON GRAD 544-3466 MPL RUGBY ND 71 CLA 537-1744 BRP BROOKLYN PARK 68 IT 560-7278 FRD GREEN ACRES WA 69 ED MPL 68 MORRS 246-2196 DOMNELLY 71 CLA 774-4825 STP ST PAUL 70 AGFHE 71 MED 331-1839 MPL LINGCOLN NB 69 IT 70 CLA 941-1345 EDN EDINA GRAD 70 CLA 645-4783 ROV ROSEVILLE 68 GC HOLLAND 70 CLA 777-3627 STP ST PAUL 69 CLA 929-0535 SLP ST LOUIS PARK 69 CLA 929-0535 SLP ST LOUIS PARK 68 BUS MPL 68 AGFHE 331-5879 71 MORRS 589-3616 MPL 69 ED 699-4558 STP ST PAUL 70 CLA 698-9122 STP ST PAUL 70 CLA STP ST PAUL 69 IT VIRGINIA 70 IT 489-1257 STP ST PAUL GRAD 69 DULTH 525-4773 DULUTH GRAD AS ED 784-9618 SKP 71 CLA 561-4018 BRC BROOKLYN CENTER 70 CLA 529-8782 MPL MINNEAPOLIS 71 DULTH 724-9813 MATED CA 71 CLA 544-1177 MTV MINNETONKA 68 GC GRAD 633-3725 ANH EDINA GRAD 484-7351 STP ONAMIA 69 ED 869-8772 RHF RICHFIELD 70 IT 866-6539 RHF LANDER WY 69 GC 478-6500 HAM HAMEL 68 CLA 70 CLA 332-4984 MPL MINNEAPOLIS 71 CLA 929-1245 SLP ST LOUIS PARK 70 LAW 788-3056 CLH DULUTH 71 DULTH 724-5920 DULUTH 70 DULTH 724-5665 DULUTH 70 DULTH 525-3948 DULUTH 70 DULTH DULUTH 71 CLA 545-8566 SLP ST LOUIS PARK 68 ED 332-4803 MPL RUSH CITY 70 DULTH 728-1710 NORTH BRANCH 70 MED 331-1839 MPL MILAN 71 CLA 339-0931 MPL MINNEAPOLIS	MOLDESTAD JON PETER 3004 OTTAWA AVE S MOLDESTAD SUSAN LYNN SANFORD MOLDESTAD WILLIAM HAR 71 IT MOLENDA CYNTHIA ALEXAN 410 MCGONAGLE ST MOLGAARD LELAND EARL 2055 KNAPP MOLIN THOMAS ARVID 1619 CARL 1B MOLIN THOMAS WAYNE FRONTIER HALL MOLINA JOSE ERNESTO MOLINE ARLETT BORGESON MOLINE JAMES CLAIRE 7032 3RD AVE SO MOLINE JANICE RAE 3540 MAJOR AVE NO MOLINE JULIE JO 4450 BEARD AVE SO MOLINE LOIS KAY CONSTOCK HALL MOLINE ROBERT TIMOTHY MOLINE THOMAS KENNETH 3537 45TH AVE SO MOLINE TIMOTHY WALTER 346 N CLEVELAND MOLITOR DANIEL JOSEPH 5533 1ST AVE SO MOLL DEAN ERVIN 1505 N CLEVELAND AVE MOLL DENNIS BRIAN MOLL DIANE ELIZABETH PIONEER COURT MOLL DONN ARTHUR 1744 HEWITT AVE MOLL JUDITH ANN 329 10TH AVE SE MOLL LINDA MARGARET 708 UNIV AVE SE MOLL RICHARD ALAN TERRITORIAL HALL MOLL STEVEN ALLAN PIONEER HALL MOLL THOMAS OLNEY MOLLEN JUDITH EILEEN 415 DECATUR AVE N MOLLEN KATHLEEN BERNAD 8913 WALLY DR MOLLENHAUER RITA ANN MOLLER JOELLE LATHROP MOLLER KARLIND THEODOR 803 W MARYLAND MOLLER SUSAN FEHR MARY 803 W MARYLAND MOLLNER ROBERT PAUL 382 ARBOR ST MOLLOY KATHLEEN MARGAR 6633 ELLIOT AVE S MOLONEY DONALD MOLTER MARY RAE 1026 5TH ST SE MOLUNBY JEROME DONALD 4528 WASHBURN AVE SO MOMMSEN BARRY WOOD 989 WATSON AVE MOMSEN WILLIAM ELI MONAGHAN MICHAEL FRAN 2105 E SUPERIOR ST MONAHAN DONALD RAYMOND MONAHAN JAMES LESLIE MONAHAN PAUL PHILIP 5700 W 68TH ST MONAHAN ROBERT HUGH 3 2132 CARTER MONAT JONATHAN S 508 BUSINESS ADMIN MONCADA CORINNA RITA 3716 HARRIET AVE S MONDALE ROGER ALAN 2139 JEFFERSON AVE MONDO JAMES GUSTAVE 1576 PORTLAND MONDO RONALD RAYMOND 1883 E HOYT MONDOOR CYNTHIA JEANNE 1000 UNIVERSITY SE MONETTE MARY HELBN 618 ND LEXINGTON MONEY ELVA JOAN PONELL HALL MONGAN JANET ELAINE 7039 FIRST AVE SO MONICO ROBERT L 2089 CARTER AVE MONIGOLD MICHELE MARIE 2205 RADATZ	70 CLA WA6-7201 SLP ST LOUIS PARK 71 CLA MPL REDWOOD FALLS 71 IT 71 DULTH 626-2054 DULUTH GRAD 646-3766 STP ALTA ID 68 DENT 645-6819 STP MONTEVIDEO 71 IT MPL SIOUX FALLS SD GRAD GRAD 70 CLA 869-4695 RHF RICHFIELD 71 CLA 588-0189 MPL MINNEAPOLIS 71 AGFHE 922-6065 MPL MINNEAPOLIS 70 CLA MPL DULUTH GRAD 70 CLA 729-9454 MPL MINNEAPOLIS 68 GC 644-2769 STP ST PAUL 68 GC 825-6221 MPL MINNEAPOLIS 69 AGFHE 646-3196 STP SLEEPY EYE 71 IT 71 CLA MPL WAVERLY 70 VET M 646-5013 STP SLEEPY EYE 68 CLA 333-0389 MPL ST PAUL 70 CLA 331-7560 MPL WAVERLY 70 CLA MPL BATTLE LAKE 68 IT MPL SLEEPY EYE 71 IT 71 CLA 545-6256 GOV GOLDEN VALLEY 70 CLA 545-7915 GOV GOLDEN VALLEY 70 CLA FARIBAULT AS AGFHE GRAD 488-8857 STP CHISAGO CITY AS ED 488-8859 STP ST PAUL 71 CLA STP ST PAUL 69 CLA 866-6518 RHF RICHFIELD GRAD 70 CLA MPL MARSHALL 70 CLA 926-6659 MPL MINNEAPOLIS 69 GC 225-8339 STP ST PAUL 71 IT 68 DULTH 724-6104 ORAGE AK 70 IT 70 CLA 70 CLA 941-3253 EDN EDINA 70 IT 645-2316 STP ST PAUL GRAD 373-5737 MPL ND HOLLYWOOD CA GRAD 825-1172 MPL CUERNAVACA 70 DENT 699-1962 STP ST PAUL 70 CLA 646-3531 STP 68 GC 776-8948 STP ST PAUL 71 CLA MPL WHITE BEAR LAKE 70 CLA 645-6773 STP ST PAUL 68 DENNY 339-0531 MPL WOLF PT MT 70 CLA 866-9045 RHF RICHFIELD 71 VET M STP PARK RAPIDS 69 ED 777-7867 MPW MAPLEWOOD
--	---	--	---	---	---

MONK ROBERT CARL 841 HAGUE AVE MONKKNONEN ERIC HENRY 7 BARTON AVE SE MONKKNONEN LISA KATHERI 1935 AQUILA AVE NO MONKKNONEN MARTA LOUISE 1316 7TH ST SE MONNENS JOHN LEE FRANC	68 CLA 224-9203 STP ST PAUL GRAD 332-5980 MPL GOLDEN VALLEY 70 CLA 544-2141 GDV GOLDEN VALLEY 68 CLA 331-1491 MPL GOLDEN VALLEY 71 IT SHAKOPEE 71 MORRS 589-3203 CLINTON 68 GC 888-0266 BLT BLOOMINGTON 71 CLA 224-7278 STP ST PAUL 68 DULTH 525-1636 DULUTH 71 CLA 938-1370 SLP ST LOUIS PARK 71 DULTH 525-1636 DULUTH GRAD 529-6087 MPL LONG BEACH CA 69 CLA 338-0389 MPL WADENA 70 CLA 473-8308 LCL LONG LAKE 70 DULTH 525-1636 DULUTH 71 DULTH 724-0686 DULUTH GRAD 68 ED 781-8619 STA ST ANTHONY 68 MED STP 70 DULTH 722-9605 TOFTE 68 AGFHE MARKVILLE GRAD 721-5874 MPL SPRING VALLEY GRAD 561-3872 BRP MINNEAPOLIS 69 VET M 455-8128 SSP AGUSTA WI 69 ED 739-9234 STP ST PAUL 70 CLA 922-1465 MINNEAPOLIS 70 CLA 373-6988 MPL LESUEUR 71 IT 257-7575 MPL LINDSTROM GRAD 331-2525 MPL ST IGNACE MI 71 CLA MPL 71 DULTH 727-6636 TWO HARBORS 71 CLA 825-6392 STP ST PAUL 68 BUS 331-3432 MPL MINNEAPOLIS 71 CLA 784-5343 MDV MOUNDS VIEW 68 ED 784-5343 MDV MOUNDS VIEW GRAD	MONTGOMERY SHARDN ANN 137 OAK ST MONTGOMERY THOMAS DALE 2160 W COUNTY RD D MONTGOMERY THOMAS JAME 4107 YORK AVE S MONTGOMERY WANDA LUCIL BAILEY HALL MONTGOMERY WILLIAM CHA 1881 SARGENT AVE MONTGOMERY NANETTE EL 3 MONTZKA JAMES DAVID 1824 6TH ST SO MOO JANICE NELSON ANN 1233 ROSE VISTA CT MOO-E NAN ELIZABETH SANFORD HALL MOODIE GREGORY BRUCE 401 WEST 95TH ST MOODY CAROL SCHOLTZ LE 1227 FOURTH ST SE MOODY DENNIS WADE JR 1227 4TH ST SE MOODY MARTIN DAVID 2008 RAMLOW PLACE MOODY MELODY HENRIKSEN 988 CROMWELL MOODY NORMAN ROY MOODERS DAVID KENDALL 1125 5TH ST SE MOODERS JOANN 3452 ZEIG AVE NO MOON CRAIG DWIGHT 2901 JAMES AVE SO MOON GREGORY OWEN 5106 42 AVE S MOON JOHN WARREN 2027 SHERIDAN AVE NO MOON LARRY KENT 4115 ZENITH S MOON MARY ELIZABETH 5517 BRYANT S MOONAN WILLARD JAMES MOONEY COLLEEN PATRICI 1750 ELEANOR MOONEY DEAN LOWELL RT 2 BOX 193 MOONEY JOAN MARGARET MOONEY JOANNE FRANCES 545 SUMMIT AVE MOONEY JOHN DANIEL 1986 LEXINGTON N MOONEY KENNETH MICHAEL 912 25TH AVE SO MOONEY MOLLY ANNE 732 1ST AVE S MOONEY RAYMOND MARK 1862 FERONIA AVE MOOR VICTORIA MARGARET 2366 HILLCOMBE AVE MOORE ALAN ARTHUR 3200 DIAMOND 8 TERR MOORE ALFRED CLAY 7429 W LAKE ST MOORE ALLAN BRUCE 1206 5TH ST SE MOORE ANN MARIE 25 WOODLAND RD MOORE ANTHONY JOSEPH 1803 ASHLAND AVE MOORE CHARLES THOMAS 625 E 18TH ST MOORE DAVID CHARLES 6237 PLEASANT AVE SO MOORE DENNIS CASEY 1785 MCKNIGHT RD MOORE DOUGLAS BOWIE 617 9TH AVE SO MOORE DOUGLAS CLIFTON 7950 RED OAK DRIVE MOORE DOUGLAS FILIIBRO BREWSTER HALL MOORE DOUGLAS ROBERT 6410 11TH AVE S MOORE EDWARD FRANCIS MOORE ELAINE TRYGESTAD 1235 GIBBS MOORE ELIZABETH IRENE 2017 GARFIELD MOORE ERLE PATRICK BOX 4087 UNIVERSITY STA MOORE EUGENE FRANCIS 2128 FRY ST APT 11 MOORE GEORGE WILDE 1523 PIONEER HALL MOORE GLEN EUGENE 4410 HODGSON RD MOORE GLENN DELTON 4007 61ST AVE NO MOORE JAMES PAUL 1125 5TH ST SE MOORE JEFFREY CLARK 5844 QUEEN AVE SO MOORE JERRY ALEXANDER 1601 WOODLAND AVE	69 DULTH 624-2229 PROCTOR 70 IT 633-5755 NWB ST CROIX VAL 70 CLA 922-6921 MPL MINNEAPOLIS GRAD 644-1781 STP BLUFFTON OH 71 CLA 698-6735 STP ST PAUL 71 DULTH DULUTH 68 ED 338-4363 MPL ST PAUL 68 ED 646-0311 ROV ST LOUIS PARK 71 CLA MPL ROCHESTER 69 GC 888-5719 BLT BLOOMINGTON 68 ED 331-3663 MPL CHARLOTTE NC 68 MORSC MPL MT AIRY NC 69 IT 698-8737 STP ST PAUL 69 ED 645-5669 STP COEUR DALENE 70 AGFHE 645-2100 FLH FALCON HEIGHTS 70 CLA 331-2792 MPL ROBBINSDALE 71 AGFHE 588-1470 ROB ROBBINSDALE 68 CLA 825-9891 MPL MINNEAPOLIS 69 ED 722-6631 MPL MINNEAPOLIS 70 ED 521-7509 MPL MINNEAPOLIS 70 CLA 922-3430 MPL MINNEAPOLIS 70 CLA TA5-4272 MPL MINNEAPOLIS GRAD 71 CLA 698-1958 STP ST PAUL 68 ED 479-2263 MPP MAPLE PLAIN GRAD 70 CLA 225-6226 STP ST PAUL 68 GC 489-2887 ROV ROSEVILLE 70 CLA 339-3508 MPL AGUSTA GA 70 CLA 455-5666 SSP SOUTH ST PAUL 70 CLA 644-9066 STP MAPLE LAKE 68 CLA 646-4353 STP ST PAUL AS IT 788-6194 MPL WICHITA KS 71 CLA SLP ST LOUIS PARK 70 CLA 331-5941 MPL WILLIAMSVILL 70 CLA WA6-9566 EDN EDINA 71 CLA 644-8450 STP ST PAUL 70 CLA 332-7780 MPL EDINA GRAD 866-2936 RHF OCEANSIDE CA 71 CLA 777-6430 STP ST PAUL 68 IT MPL ST PAUL 69 CLA 504-4365 MPL MINNEAPOLIS 70 AGFHE 647-3724 STP AYER MA 71 IT 866-0539 RHF RIGHFIELD 68 ED 68 AGFHE 645-6970 STP GRAD 339-1068 MPL ST PAUL 68 CLA 68 AGFHE 631-2750 ROV NORTHFIELD 68 CLA 373-6288 MPL MINNETONKA 69 GC 484-6355 SHV SHOREVIEW GRAD 487-0673 BRC CLAYTON WI 70 CLA 331-2792 MPL RICHFIELD 70 CLA 922-3045 MPL MINNEAPOLIS 68 DULTH 724-8195 INGTON D. C. DC	MOORE JOHN DAVID 3712 PILLSBURY AVE S MOORE JOSEPH PATRICK WI 2108 24TH AV S MOORE JOYCE MAE BURNSIDE HALL 131 MOORE KATHLEEN HELEN 4204 RUSSELL AVE N MOORE KATHLEEN MARY 507 22ND AVE W MOORE KELLY RAYMOND 1349 UPTON AVE NO MOORE LAURIE ANN SANFORD HALL MOORE LORRAINE OLSON E MOORE MARIE HIGBEE MAG 1754 LYDIA MOORE MARILYN KAYE 948 W SHERREN ST MOORE MARJORIE MAY ELL 15 BARTON AVE SE MOORE MAUREEN MARILYN 1915 SHERIDAN AVE MOORE MICHAEL GLENN 3244 FOXBORO LANE MOORE PATRICIA MAXINE ID 2012 14TH AVE SO MOORE PETER JAMES 1785 MCKNIGHT ROAD MOORE PLOUIS JR 3308 4TH AVE SO MOORE RICHARD ALLEN MOORE RICHARD BEN MOORE RICHARD DEAN 505 RIVER PKWY MOORE RICKEY LEE 300 W 8TH ST MOORE ROBERT M JR 1010 15TH AVE SE MOORE RONALD RAY 6 IVY LANE MOORE SHAREN LEE SANFORD HALL MOORE SUSAN PIONEER COURT MOORE THOMAS MICHAEL 2110 PARK AVE SO MOORE THOMAS OWEN 1911 SHERIDAN MOORE TIMOTHY DONALD 2620 PILLSBURY AVE SO MOORE VAUGHN CLAYTON MOORE WARREN ALBERT JR MOORE WAYNE VIRGIL 2024 COMMONWEALTH MOORE WILLIAM EDWARD MOORE WILLIAM GEORGE 2612 2 AVE MOORE WILLIAM GORDON 2501 LOWRY AVE NE MOORE WILLIAM MICHAEL 12 MERILANE MOORE WILLIAM ROBERT NY 5333 DUPONT AV S MOORHEAD JANIS MARIE 1504 S WILSHIRE DR MOORHEAD JOHN KELLY 6701 WEST TRAIL MOOS LAUREN LEE MOOS REBECCA LOUISE 815 13TH AVE SE 309 MOOS VIRGINIA KATHLEEN SANFORD HALL MOOSMANN HELEN ESTELLE 3528 THOMAS NO MOOTY MARCIA ANN MORACK PATRICIA MARIE 815 13TH AVE SE MORAD ABDELREHIM MOHAM MORALES BOBBIO JOSE LA MORALESZUNIGA ALFONSO MORAN ALLAN ALDEN 5014 SHORELINE DR MORAN DEBRA KATHERINE 1220 E 2 ST MORAN SALVADOR LOUIS 623 LAUREL AVE MORAN THOMAS JAMES 1747 EUSTIS MORANCEY JOSEPH S 2566 1ST MORAWETZ DOR9NA CRISTI 4301 E LAKE HARRIET BL MORAWSKI SARA HANSON L 8523 DAVENPORT NE MORBERG KEITH ROBERT 2101 3RD AVE SO MORE JOAN ELIZABETH	69 CLA 822-4344 MPL MINNEAPOLIS 71 MED 332-3781 MPL MINNEAPOLIS GRAD 724-9914 MONT TX 68 CLA 529-0188 MPL MINNEAPOLIS 70 DULTH 727-1356 DULUTH AS GC MPL CHICAGO IL 70 CLA MPL WILLIAMSON NY GRAD AS CLA 633-6215 ROV 70 CLA 489-6589 ROV ROSEVILLE 70 CLA 336-3596 MPL 69 GC 699-7281 STP ST PAUL 70 CLA 739-0601 STP ST PAUL 69 ED 338-8118 MPL MINNEAPOLIS 71 CLA 777-6430 MPW MAPLEWOOD 69 CLA 742-7042 MPL MINNEAPOLIS 71 CLA GRAD 71 IT 421-5292 CHM CHAMPLIN 71 MORRS 589-4444 MINNEAPOLIS 69 LAW 331-5818 MPL MINNEAPOLIS GRAD 71 CLA 373-7585 MPL BUFFALO 70 CLA 886-3262 MPL WATERTOWN SD AS BUS MPL WEBSTER CITY IA 69 GC 698-2873 STP ST PAUL 68 CLA 822-7709 MPL COLUMBIA HTS GRAD 71 IT GRAD 645-4408 STP GRAD 70 CLA 579-8002 MPL MINNEAPOLIS 69 CLA 789-0150 MPL LESUEUR 68 CLA 929-3942 EDN EDINA 69 GC 823-7572 MPL 70 CLA 545-8753 MTV MINNETONKA 68 GC 941-4240 EDN EDINA 68 BUS 69 CLA 331-3824 MPL ST CLOUD 71 CLA 473-3278 MPL WAYZATA 70 CLA 521-2775 MPL MINNEAPOLIS 70 CLA GRAD MPL NEW LONDON WI GRAD 69 IT GRAD 68 GC 472-3497 MND ST LOUIS PARK 71 DULTH 724-5916 DULUTH 71 CLA STP WEST ST PAUL GRAD STP 69 GC 429-7281 6K NTB WHITE BEAR LAKE 70 CLA 824-1189 MPL 68 ED 786-1749 MPL NEW BRIGHTON 68 IT MPL DETROIT LAKES 70 CLA
---	--	--	--	---	---















NELSON LINDA LOU 666 SURREY AVE  
 NELSON LINDA MARIE 227 N 21ST AVE E  
 NELSON LINDA SUE 9801 ELLIOT AVE SO  
 NELSON LINDA YVONNE 5711 35TH AVE S  
 NELSON LORE 1132 BOWDOIN  
 NELSON LOREN DONALD 2145 COLUMBUS AVE  
 NELSON LOYAL DEAN 808 4TH ST SE  
 NELSON LULU JEAN 1318 7TH ST SE  
 NELSON LYNETTE KAY 1012 8TH ST SE  
 NELSON M VALYS 1211 4TH AVE N  
 NELSON MARCIA ANN 3733 26 AVE SO  
 NELSON MARCIA ANN 2527 MCKINLEY ST NE  
 NELSON MARGA-ET EVELYN 1015 ESSEX ST SE 216  
 NELSON MARGARET JEAN 3018 ALABAMA AVE SO  
 NELSON MARGARET ZEILOT 2929 LA BORE RD  
 NELSON MARIANN LOUISE 1104 WINNETKA N  
 NELSON MARILYN DELIGHT 530 E 4TH  
 NELSON MARILYN JEAN 5222 DUPONT NO  
 NELSON MARILYN MARCIA 1516 QUEBEC AVE NO  
 NELSON MARILYN MILDRED 3825 REGENT AVE N  
 NELSON MARION TIEDE DO 1916 10TH AVE SO  
 NELSON MARK AUSTIN 5925 HALIFAX AVE SO  
 NELSON MARK JORDAN 112 E LAWSON  
 NELSON MARK ROBERT

69 GC 771-1527  
 STP ST PAUL  
 70 DULTH ST PAUL  
 71 CLA 888-9859  
 BLT BLOOMINGTON  
 70 CLA 724-6082  
 MPL MINNEAPOLIS  
 69 GC 699-1435  
 STP ST PAUL  
 70 DULTH MAHTOWA  
 68 GC 336-1326  
 MPL MINNEAPOLIS  
 68 ED 331-9731  
 MPL MINNEAPOLIS  
 68 ED 331-3730  
 MPL MINNEAPOLIS  
 68 GC 374-3430  
 MPL  
 70 CLA 722-0407  
 MPL MINNEAPOLIS  
 68 GC 789-7319  
 MPL MINNEAPOLIS  
 70 ED 331-6212  
 MPL FRAZEE  
 70 CLA 929-9473  
 SLP ST LOUIS PARK  
 68 ED 484-2811  
 LTC  
 71 CLA 545-7835  
 GOV GOLDEN VALLEY  
 70 MORRS OAK PARK  
 71 CLA 522-2403  
 MPL MINNEAPOLIS  
 71 CLA 545-7092  
 GOV GOLDEN VALLEY  
 70 CLA KE7-4015  
 ROB ROBBINSDALE  
 68 CLA 339-4754  
 MPL LE CENTER  
 70 CLA 922-2957  
 EDN EDINA  
 69 GC 227-5563  
 STP ST PAUL  
 70 AGFHE

68 AGFHE 777-1857  
 WTB  
 71 CLA  
 68 ED 336-1000  
 MPL STACY  
 69 CLA 881-6388  
 BLT BLOOMINGTON  
 69 CLA 336-5206  
 MPL KAILUA HI  
 70 IT 331-6400  
 MPL TRIMONT  
 70 DULTH 724-9800  
 ST LOUIS PARK  
 68 ED 335-6192  
 MPL FT LEONWOOD MO  
 70 CLA 927-5544  
 MPL MINNEAPOLIS  
 70 CLA 729-0523  
 MPL MINNEAPOLIS  
 71 CLA  
 MPL BATTLE LAKE  
 69 MORRS WEST COVINA CA  
 68 BUS

70 CLA 776-7413  
 STP ST PAUL  
 70 CLA 373-6716  
 MPL WINDOM  
 70 CLA  
 MPL ZUMBROTA  
 68 DULTH 628-1115  
 DULUTH  
 68 IT

70 CLA 722-2127  
 MPL MINNEAPOLIS  
 GRAD  
 STP PHILIP SD  
 70 CLA 332-4077  
 MPL BLOOMINGTON  
 GRAD 336-1166  
 MPL ST PAUL  
 69 GC 588-2457  
 GOV GOLDEN VALLEY  
 68 GC 377-7494  
 GOV  
 68 GC 489-7566  
 STP ST PAUL  
 GRAD

71 AGFHE  
 STP BLOOMING PR  
 68 CLA 789-5500  
 MPL MINNEAPOLIS

NELSON PAUL EDWARD 1085 14TH AVE SE  
 NELSON PAUL TIMOTHY 1815 UNIV AVE SE  
 NELSON PAULA ROGNLEY 603 CAMDEN  
 NELSON PEGGY DIANE 809 5TH AVE SE  
 NELSON PERRY MICHAEL TERRITORIAL HALL  
 NELSON PETER ALLEN 934 W NEVADA  
 NELSON PETER CHARLES 4004 CEDAR AVE SO  
 NELSON PHYLLIS EVA 613 ERIE ST SE  
 NELSON PHYLLIS HARLIEN 649 ERIE ST SE  
 NELSON PHYLLIS JEAN 1122 COMO SE APT 3  
 NELSON RALPH ERICK JR 204 NO MCCARRONS BLVD  
 NELSON RANDALL ARTHUR 2115 W 105TH ST  
 NELSON REBECCA JANE 4633 COLFAX AVE SO  
 NELSON RENEE JERI 3527 NO 3RD ST  
 NELSON RHODA JOY 1315 OLSON HWY  
 NELSON RICHARD ALEXAND 4102 W 6 ST  
 NELSON RICHARD ALTON FRONTIER HALL  
 NELSON RICHARD ALVIN

GRAD 331-3810  
 MPL SLAYTON  
 69 CLA 331-5988  
 MPL WAMPETON ND  
 AS MORRS HILL CITY  
 70 CLA 336-2500  
 MPL DAWSON  
 70 ED  
 MPL AUSTIN  
 69 GC 489-7509  
 STP ST PAUL  
 69 GC 721-1072  
 MPL MINNEAPOLIS  
 68 MEDTC 331-3642  
 MPL RANDOLPH  
 69 ED FEL-4309  
 MPL MINNEAPOLIS  
 70 CLA 537-4015  
 MPL MINNEAPOLIS  
 68 MED 488-0129  
 ROV SISSETON SD  
 70 CLA 881-7123  
 BLT BLOOMINGTON  
 69 ED 822-3277  
 MPL NORTHBROOK IL  
 71 CLA 522-5359  
 MPL MINNEAPOLIS  
 GRAD 377-4991  
 MPL  
 71 DULTH 624-3583  
 DULUTH  
 71 CLA  
 MPL ST JAMES  
 70 AGFHE

70 CLA  
 MPL SOUDAN  
 69 IT 373-6557  
 MPL FOSSTON  
 GRAD  
 MPL  
 69 GC 588-0352  
 ROB RICHFIELD  
 71 DENT 377-5050  
 MPL WILLMAR  
 68 CLA  
 MPL KUALA LUMPUR  
 69 IT  
 MPL AUSTIN  
 69 ED 935-7270  
 HOP  
 70 DENT 646-3329  
 STP ST PAUL  
 71 IT 881-8027  
 BLT BLOOMINGTON  
 68 BUS 941-2027  
 EDN EDINA  
 70 DULTH  
 70 DULTH 525-3532  
 DULUTH  
 69 GC 373-6951  
 MPL GRAND FORKS ND  
 GRAD

68 GC 888-5278  
 BLT BLOOMINGTON  
 70 CLA  
 70 CLA 331-4202  
 MPL MINNEAPOLIS  
 70 MORRS LITCHFIELD  
 69 DENT 646-0836  
 ROV ST PAUL  
 68 GC HU9-1581  
 STP ST PAUL  
 GRAD 644-7088  
 STP RAKE IA  
 70 CLA 336-5206  
 MPL BUFFALO NY  
 69 GC 929-7222  
 SLP ST LOUIS PARK  
 70 CLA  
 MPL PINE CITY  
 70 CLA 869-8804  
 RHF RICHFIELD  
 AS ED

GRAD 373-2790  
 MPL ROSEAU  
 70 MED 338-7276  
 MPL ROCHESTER  
 71 VET M  
 STP HILLS  
 AS CLA

GRAD 724-3578  
 MPL MINNEAPOLIS  
 68 IT 560-6884  
 FRD MINNEAPOLIS  
 AS CLA 429-9667  
 WTB W HARTFORD CT  
 70 AGFHE 473-8255  
 WAY  
 71 CLA 529-4855  
 MPL MINNEAPOLIS  
 71 CLA 920-6598  
 EDN EDINA

NELSON SANDRA JEAN 1129 6TH ST SE  
 NELSON SANDRA LEE BURNTSIDE 135  
 NELSON SCOTT KENNETH 4021 13TH AVE SO  
 NELSON SCOTT WESLEY 2231 KELLY AVE  
 NELSON SHARON JOY 4713 ARROWHEAD RD  
 NELSON SHARON LYNN 203 NORTON ST  
 NELSON SHARON PETERSON 8621 QUEEN SO  
 NELSON SHEILA SUE 2405 W 6 ST  
 NELSON SHERWOOD ALBERT 3215 37 AVE SO  
 NELSON SHIRLEY JUNE 900 25TH ST W  
 NELSON SIDNEY B

GRAD 331-6010  
 MPL EGGERTSVILLE NY  
 71 DULTH 724-9873  
 RANDALL  
 68 CLA 822-7742  
 MPL WILLMAR  
 71 DULTH 819-5215  
 CLOQUET  
 70 DULTH 725-5949  
 MINNEAPOLIS  
 69 DULTH 728-2056  
 DULUTH  
 70 CLA 881-4017  
 BLT BLOOMINGTON  
 71 DULTH 722-5703  
 DULUTH  
 68 CLA  
 MPL MINNEAPOLIS  
 70 CLA 374-3673  
 MPL PIPESTONE  
 GRAD

70 CLA 926-3396  
 MPL MINNEAPOLIS  
 71 AGFHE  
 SPICER  
 70 IT  
 MPL ALBORN  
 GRAD 331-5858  
 MPL RICHFIELD  
 71 MED 824-4874  
 MPL MINNEAPOLIS  
 70 LAW 488-1294  
 STP ST PAUL  
 70 CLA 644-6589  
 STP ST PAUL  
 68 CLA 825-6282  
 MPL ALBERT LEA  
 68 GC

GRAD 331-7961  
 MPL  
 70 DULTH 727-5989  
 BIVABIK  
 68 ED 377-3343  
 MPL MINNEAPOLIS  
 70 IT

70 CLA  
 69 CLA 331-0531  
 MPL MINNEAPOLIS  
 69 GC 866-6965  
 MPL MINNEAPOLIS  
 70 AGFHE 774-2957  
 MPW MAPLEWOOD  
 70 CLA 866-2213  
 MPL MINNEAPOLIS  
 70 CLA  
 MPL RED WING  
 70 CLA 881-8027  
 BLT BLOOMINGTON  
 71 CLA 920-6419  
 EDN EDINA  
 GRAD 331-1824  
 MPL FALCON HEIGHTS  
 68 DULTH  
 GRAND MARAIS  
 70 CLA 537-7586  
 ROB ROBBINSDALE  
 GRAD

68 IT 929-4193  
 SLP ST LOUIS PARK  
 68 GC 644-6589  
 STP ST PAUL  
 70 CLA 537-7733  
 CYT CRYSTAL  
 AS CLA 331-4202  
 MPL MINNEAPOLIS  
 68 GC 724-3912  
 MPL MINNEAPOLIS  
 71 IT 421-1503  
 ANK ANOKA  
 69 GC 226-5515  
 STP ST PAUL  
 71 CLA 771-7168  
 STP ST PAUL  
 70 CLA 729-8571  
 MPL MINNEAPOLIS  
 69 ED 377-2241  
 MPL MINNEAPOLIS  
 GRAD

70 DULTH 724-7334  
 DULUTH  
 70 CLA  
 MPL FAIRMONT  
 70 CLA 776-6916  
 STP ST PAUL  
 70 IT 331-1548  
 MPL BRAHAM  
 71 CLA  
 MPL ATWATER  
 71 CLA  
 MPL FINLAYSON  
 GRAD 644-2364  
 STP  
 70 CLA 588-5792  
 ROB ROBBINSDALE

NELSON WILLIAM CREW 69 CLA 544-1791  
1821 INDEPENDENCE AVE S SLP ST LOUIS PARK  
NELSON WILLIAM DAVID J 71 CLA  
47 E WENTWORTH CT MPL MINNEAPOLIS  
NELSON WILLIAM JOHN 71 PHARM  
PIONEER HALL MPL WELLS  
NEMANIC JOHN TODD 69 CLA  
GILBERT  
NEMANICH GEORGE JOHN GRAD  
NEMANICH JEROME F 68 ED  
SOUDAN  
NEMEC JOSEPH DENNIS GRAD  
2617 MONROE ST NE MPL ASHLAND WI  
NEMER CANDICE 70 CLA 699-0348  
1383 ELEANOR AVE STP ST PAUL  
NEMER FREDERIC DAVID 70 MED  
3820 ABBOTT AVE SO  
NEMER NANCY LOUISE 69 CLA 922-1065  
3820 ABBOTT S MPL MINNEAPOLIS  
NEMES JOHN DALE 68 GC 544-6244  
111 CITY VIEW DR SO MTV MOUND  
NEMETZ RICHARD JAMES 70 CLA 644-9238  
1703 TAYLOR STP ST PAUL  
NENGAR NOREEN SUSAN 69 DULTH  
711 E 7 ST EVELETH  
NEMITZ NANCY LEE 70 ED  
COMSTOCK HALL MPL OLIVIA  
NEMMERS CHRISTINE ANN 68 ED  
NEMZEK JAMES CHRISTOPH 71 CLA 866-6883  
6705 VINCENT AVE SO RHF RICHFIELD  
NENPL PATRICIA MCVETTI GRAD 699-1287  
1365 W MAYNARD DR STP ANCHORAGE AK  
NEPRUDE ELIZABETH M 69 ED 822-3315  
2712 HUMBOLDT SO MPL MINNEAPOLIS  
NEPSHA KATHLEEN 69 ED 781-1227  
705 22ND AVE NE MPL MINNEAPOLIS  
NERBURN KENT MICHAEL 68 CLA 331-3432  
1115 5TH ST SE MPL MINNETONKA  
NEREM RICHARD LYLE 71 AGFHE  
NEREN HARRIET LOVE AS ED  
NEREN HOWARD ALLAN 68 CLA 698-1168  
171 SO CLEVELAND STP ST PAUL  
NEREN JUDITH ANN 71 CLA  
171 S CLEVELAND STP ST PAUL  
NEREN MICHAEL IAN 68 CLA  
2040 JULIET STP ST PAUL  
NERESON GARY LAMONT 69 IT 331-7931  
515 10TH AVE SE MPL THF RIVER FALLS  
NERHAUGEN JILLAIN POR 70 DULTH  
ST PAUL  
NERHEIM ALAN LEIF 69 GC 633-4578  
678 3RD AVE NE NMB NEW BRIGHTON  
NERISON BETH CALDWELL 71 CLA  
COMSTOCK HALL MPL MONTEVIDEO  
NEROETHIN PAUL WARD 71 MED 331-1839  
317 UNION ST SE MPL MINNEAPOLIS  
NERSTAD DARREL OLIN 69 PHARM 331-5780  
1315 7TH ST SE MPL  
NESBITT GLENDA LEE 68 ED 336-2727  
325 6TH AVE SE MPL PINE ISLAND  
NESBITT JACQUELINE KAY 68 CLA 944-2569  
9414 E BUSH LK RD BLT BLOOMINGTON  
NESBITT NOREEN GOODY 68 ED 454-1586  
11019 SCHOOLCRAFT BUR BURNSVILLE  
NESETH LAVAINE BRUCE 71 CLA  
FRONTIER HALL MPL KENYON  
NESHEIM JEAN ELIZABETH 69 DULTH 728-4350  
1531 E 4TH ST BRAINERD  
NESHEIM JUDITH ELLEN 71 CLA  
SANFORD HALL MPL BRANCH  
NESHEIM MICHAEL ERNEST 68 CLA 331-3632  
818 10TH AVE SE MPL BLUE EARTH  
NESHEIM SUSAN MARTHA 71 CLA 888-0326  
11011 RUSSELL AVE SO BLT BLOOMINGTON  
NESS ALICE OLENA 70 DULTH 525-4242  
5227 JUNIATA ST DULUTH  
NESS ALLAN LOUIS 70 CLA 722-4721  
3957 27TH AVE SO MPL MINNEAPOLIS  
NESS BARBARA MARIE 70 AGFHE 722-4721  
3952 27TH AVE SO MPL MINNEAPOLIS  
NESS BARRY WILTON 70 CLA 588-5965  
3431 TERRACE LANE GDV GOLDEN VALLEY  
NESS DARWIN DELBERT GRAD  
NESS DOUGLAS JAMES GRAD  
NESS DUANE ARTHUR 71 CLA 588-1889  
3716 REGENT NO ROB ROBBINSDALE  
NESS GLORIA JEAN 69 CLA  
NESS JAMES ALAN 71 CLA 777-7516  
2633 NO 3RD NSP NORTH ST PAUL  
NESS MANDA ANN 71 DULTH 724-9914  
BURNSIDE 101 ROCHESTER  
NESS MICHAEL ARNEY 70 CLA 338-3439  
521 4TH ST SE MPL MINNEAPOLIS  
NESS MICHAEL JOHN 68 GC 226-1233  
543 OAKLAND STP ST PAUL  
NESS MICHAEL RALPH 70 CLA 331-6400  
233 FRONTIER HALL MPL HECTOR  
NESS PHILIP ALLEN 70 AGFHE  
BAILEY HALL STP ALBERT LEA  
NESS VERN BROCK 70 CLA 735-0079  
799 LAKE ST STP ST PAUL  
NESSE ANTON STEPHEN GRAD 888-6901  
8345 KNOX AVE SO BLT JORDAN

NETKO SYLVIA ANN 71 CLA 784-2588  
725 80TH AVE NE SKP SPRING LAKE PK  
NETKOW GERALDINE MARIE 71 CLA 788-5162  
4010 RESERVOIR BLVD CLH COLUMBIA HTS  
NETKOW HAROLD HERBERT 68 CLA 788-4334  
1912 42ND AVE NE CLH COLUMBIA HTS  
NETT BARBARA ANN 70 CLA 644-4047  
1364 ASBURY STP ST PAUL  
NETTEBERG VERONICA J 68 AGFHE 724-8109  
2717 BLOOMINGTON AVE SO MPL BETHEL  
NETTESTAD EDWARD BENNI 71 CLA 695-5571  
FRONTIER HALL MPL BROWNS VALLEY  
NETTLETON JAMES WARNER GRAD 645-5039  
1855 MALVERN ST STP ALBERT LEA  
NETNAL EARL TOM JR 70 CLA 537-7951  
6000 HALIFAX PL BRC BROOKLYN CENTER  
NETZEL MICHAEL LEE 71 DULTH 727-2568  
2225 W 24TH ST DULUTH  
NETZMAN STEVEN AARON 70 CLA 226-4005  
946 LAUREL AVE STP ST PAUL  
NEUBAUER KENNETH ROBER 71 IT 776-2035  
1444 HAZEL ST STP ST PAUL  
NEUBECK DEBORAH KAHN GRAD 822-4140  
3044 HUMBOLDT SO MPL MINNEAPOLIS  
NEUBECK EVA JANET 69 CLA 645-9751  
1465 RAYMOND STP ST PAUL  
NEUBECK PETER JOSHUA 70 CLA 645-9751  
1465 RAYMOND STP ST PAUL  
NEUBECK RALPH JOSEPH GRAD 822-4140  
3044 HUMBOLDT AVE SO MPL ST PAUL  
NEUDAMM HERBERT KENNET 69 AGFHE 633-0640  
2984 N CLEVELAND ROV ROSEVILLE  
NEUDAMM JEFFREY CHARLE 69 GC 699-9176  
1446 STANFORD STP ST PAUL  
NEUDAUER ROSEMARY THER 68 ED  
1036 CUMBERLAND STP ST PAUL  
NEUJAHN WILLIAM FRANK 68 GC 489-7855  
1526 MAYWOOD STP ST PAUL  
NEUMAN BILL EUGENE 68 CLA 331-1507  
1103 5TH ST SE MPL MINNEAPOLIS  
NEUMAN BRUCE JAN 70 CLA 824-7783  
4017 ELLIOT AVE SO MPL MINNEAPOLIS  
NEUMAN HENRY ISAAC 70 CLA 544-1717  
14 WESTERN TERRACE GDV GOLDEN VALLEY  
NEUMAN LARRY DONALD 71 IT 789-8762  
2746 HAYES ST NE MPL MINNEAPOLIS  
NEUMAN RICHARD PAUL 71 IT 869-4776  
7500 5TH AVE SO RHF RICHFIELD  
NEUMANN DONALD FREDERI 69 MORRS 589-3669  
303 E 5TH ST REDWOOD FALLS  
NEUMANN DONNA KAY 71 CLA 776-3194  
1443 E MARYLAND AVE STP ST PAUL  
NEUMANN GARY FRANK 68 AGFHE  
2280 PRISCILLA STP DOVER  
NEUMANN KAREN ANN AS BUS 521-6046  
212 23RD AVE NO MPL MINNEAPOLIS  
NEUMANN LOUISE ANN 71 CLA  
SANFORD HALL MPL AMMANDALE  
NEUMANN RICHARD WILLIA GRAD  
NEUMANN ROLAND F 70 CLA 929-0808  
14 PADDOCK RD EDN EDINA  
NEUMANN VOLKER SIEGHAR 71 IT 781-3917  
1315 MADISON ST NE MPL MINNEAPOLIS  
NEUMEIER MARY ALICE 71 CLA  
SANFORD HALL MPL STILLWATER  
NEUMEIER NANCY 70 CLA  
314 10TH AVE SE MPL STILLWATER  
NEUNTSINGER JOHN PAUL 70 MORRS  
FRANKLIN  
NEURAUTER MARK ALAN 71 IT 776-2648  
722 E ORANGE AVE STP STILLWATER  
NEUTZLING LINDA LOUISE 71 CLA 339-0931  
SANFORD HALL MPL ST CLOUD  
NEUTZLING THOMAS GERAL 68 ED 338-3618  
407 7TH ST SE MPL ST CLOUD  
NEVALAINEN DAVID ERIC GRAD  
NEVE CHARLES RAY 71 CLA 822-0406  
5137 12TH AVE SO MPL MINNEAPOLIS

NEVEAU DUANE EUGENE 69 DULTH 727-1776  
119 MAPLE GROVE RD DULUTH  
NEVERS LAURIE JEAN 69 CLA 332-8516  
323 TENTH AVE SE MPL DULUTH  
NEVILLE KIT BARR 70 CLA  
425 ERIE PLAZA 3D MPL ST CHARLES  
NEVILLE WILLIAM JAMES GRAD  
NEVIN MARILYN CARYL 70 ED  
NEVISON JAMES BURNARD 71 CLA 529-1027  
4929 DUPONT NO MPL MINNEAPOLIS  
NEVONEN MARVIN GENE 69 BIOC 336-3146  
327 SE 3RD AVE MPL NEW YORK MILLS  
NEWBERG ARTHUR LEE 71 CLA 729-9229  
4225 22ND AVE SO MPL MINNEAPOLIS  
NEWBOLD FRED RUSSELL GRAD 722-1303  
2813 CEDAR AVE MPL  
NEWBY JAY CARLTON 70 CLA  
TERRITORIAL HALL MPL CLOQUET  
NEWCOMB THOMAS WAYNE 70 CLA 699-2162  
1373 BAYARD AVE STP ST PAUL  
NEWELL DAVID MERRITT 68 IT 560-3332  
5347 4TH ST NE EL PASO TX  
NEWELL DONALD RAY 70 CLA  
1055 VAN SLYKE STP ST PAUL  
NEWELL ELIZABETH BATTI 69 CLA FR4-5604  
2010 JAMES SO MPL  
NEWELL JAMES DOUGLAS 71 CLA  
FRONTIER HALL MPL BILLINGS MT  
NEWELL JEFFREY MOINE 69 ED 247-5138  
PIONEER HALL MPL TYLER  
NEWELL KAREN DIANE 68 ED 489-2918  
1055 VAN SLYKE STP ST PAUL  
NEWELL KATHLEEN JANG 68 DENNY 631-2378  
COMSTOCK HALL MPL WADEN  
NEWELL WILLIAM CHARLES 68 CLA 338-9015  
1906 S 6TH ST MPL WHITE BEAR LAKE  
NEWGARD ROBERT DAVID 70 CLA 724-9445  
3212 23 AVE SO MPL MINNEAPOLIS  
NEWGREN RICHARD ALLEN 69 LAW  
3608 MINNEAPOLIS AVE SO MPL DULUTH  
NEWHOUSE ERIK CHARLBS 71 CLA  
TERRITORIAL HALL MPL MINNEAPOLIS  
NEWHOUSE LINDA FLORENC 68 CLA  
424 E COMSTOCK HALL MPL ROCHESTER  
NEWINSKI VICTOR JOHN 68 BUE  
NEWLANDER LOIS JEAN 71 DULTH 724-9914  
BURNSIDE HALL 122 CLOQUET  
NEWMAN BONNIE JO 68 ED 699-7641  
2151 PINEMURST STP ST PAUL  
NEWMAN CHARLES JEREMY 68 ED 926-7595  
3641 ABBOTT AVE SO MPL MINNEAPOLIS  
NEWMAN COURTLAND EDWAR GRAD 920-3717  
3400 W CALHOUN BLVD SO MPL MINNEAPOLIS  
NEWMAN GARY MIRAN 71 VET M  
BREWSTER HALL STP KANDIYOHI  
NEWMAN GLORIA BRUDEN 68 ED 633-1448  
4051 VALENTINE CT ANH  
NEWMAN GRAYDON KEITH 68 GC 484-4810  
2622 FISK ROV ROSEVILLE  
NEWMAN HUGH J 68 GC 922-8162  
2745 SALEM AVE SLP ST LOUIS PARK  
NEWMAN JAMES BERNARD 69 DULTH  
EVELETH GRAD  
NEWMAN JAMES LAURENCE GRAD  
NEWMAN LARRY BURNETT GRAD 331-1452  
1409 COMO AVE SE MPL CAYUGA NY  
NEWMAN MARC ERIC 68 DULTH 728-4687  
1500 E SKYLINE PKWY EVELETH  
NEWMAN REX LEE 71 IT 920-1484  
4360 MACKAY AVE SLP ST LOUIS PARK  
NEWMAN RICHARD CHARLES 70 CLA 699-7641  
2151 PINEMURST STP ST PAUL  
NEWMAN ROBERT EUGENE GRAD 633-3873  
288 WINDSOR LN NMB NEW BRIGHTON  
NEWMAN SUSAN POTTER FL GRAD 331-1452  
1409 COMO AVE SE MPL HOMER NY  
NEWMAN THOMAS MAX 69 BUS 698-2202  
662 HT CURVE BLVD STP ST PAUL  
NEWMANN ALBERT THEODOR 70 CLA 545-0545  
5825 WESTBROOK RD GDV GOLDEN VALLEY  
NEWMANN THOMAS SCOTT 70 CLA  
3945 ABBOTT AVE SO MPL  
NEUQUIST JULIE KAY 69 ED  
NEUQUIST RONALD EDWARD 69 GC 781-4908  
3150 HAYES NE MPL MINNEAPOLIS  
NEWSOME PAMELA ELIZABE 68 CLA 745-4868  
3249 HOLMES SO MPL MINNEAPOLIS  
NEWSTROM JEFFREY RAYMO 68 GC 866-4166  
6101 3RD AVE SO MPL MINNEAPOLIS  
NEWSTROM JOHN NORMAN GRAD  
NEWSTROM JOHN WALDENAR GRAD  
NEWSTROM RICHARD NORMA 68 GC 866-4166  
6101 THIRD AVE SO MPL MINNEAPOLIS  
NEWTON CHARLES DAVID 68 VET M 646-3985  
1520 RAYMOND ROV MINNEAPOLIS  
NEWTON DAVID JAMES 68 PH 644-0791  
2029 BREWSTER ST ANN ARBOR MI  
NEWTON HAROLD EDWIN 68 CLA 331-3749  
510 12TH AVE SE MPL HAWLEY  
NEWTON KURT NEIL 69 PT  
PIONEER HALL MPL GRAND RAPIDS  
NEY JOHN EDWARD 70 CLA FR7-4936  
1925 PENN AVE SO MPL MINNEAPOLIS

NEY JOHN JAMES 2400 LARPEUR AVE NEZNIK HOLLIS ANGEL 4608 DOUGLAS DR NG ALICE LUN NGAI HA 2427 E FRANKLIN AVE NG TSUN KEY	GRAD STP KENOSHA WI 71 CLA KEY-8569 CYT CRYSTAL GRAD MPL HONG KONG 68 ED	NIEBAUER CHARLES PAUL 2019 E 1ST ST NIEBUHR DEANNA ROSE 1988 BREWSTER ST APT104 NIEBUHR FREDERICK WIL TERRITORIAL HALL NIEDENFUER JERILEE A 600 UNIVERSITY AVE SE NIEDERLOH CHARLES FRBD	68 DULTH 724-2946 LIPS WI GRAD 645-2450 STP 71 IT MPL ALBERT LEA 71 CLA 338-3169 MPL MERRIFIELD 69 IT	NIES GERALD LAWRENCE 26 INNER DRIVE NIESS DANIEL GEORGE 3913 MORNINGSIDE RD NIETZ DAVID ARNOLD CENTENNIAL HALL NIETZ LINDA MARIE 67 W JESSAMINE NIETZ MICHELLE ANNE 1015 ESSEX SE NIGHTENGALE MARY ANN 519 10TH AVE SE NIHART RUTH JEAN COMSTOCK HALL NIKKO GEORGE HENRY JR 1423 BREA AVE NIKODYM GREGORY ALAN GRIGGS HALL B113 NIKUNEN DIANE MARIE 1801 E 6TH ST NILAN MICHAEL THOMAS 1821 UNIVERSITY SE NILES ANN ALMQUIST 208 COLLEGE NILES BARBARA JEAN 1012 5 ST SE NILES CAROLYN FAYE 9442 STANLEY AVE SO NILLS SAUNDRA D 415 ERIE ST SE NILSEN GLEN CURTIS 1124 HALL AVE NILSEN JAM 2130 MILLER TRK HWY NILSESTUEN KENNETH ROB 3025 JERSEY AVE S NILSON JOHN VERNON 209 HERMAN CT NILSSON BENGT ERIC	GRAD 699-9503 STP ST PAUL 68 CLA 926-2109 EDN EDINA 68 CLA MPL ROCHESTER 70 CLA 488-5618 STP ST PAUL 69 CLA 289-5068 MPL ROCHESTER 68 CLA 331-3523 MPL WADENA 69 CLA 333-2161 MPL LAKB CITY 70 CLA 645-1885 STP WILLOW RIVER 71 DULTH 724-9816 MORA 68 DULTH 728-3759 TOWER 70 CLA MPL AUSTIN GRAD 68 CLA MPL MINNEAPOLIS 71 CLA 881-7183 BLT BLOOMINGTON 69 ED MPL ROCHESTER 70 CLA 226-4964 WSP WEST ST PAUL AS DULTH 722-7148 DULUTH 70 CLA 929-3753 SLP ST LOUIS PARK 71 CLA 935-1809 HOP HOPKINS GRAD 71 DENT 884-2846 BLT BLOOMINGTON 69 GC 920-2055 SLP ST LOUIS PARK 69 ED 529-7921 MPL MINNEAPOLIS 69 CLA 331-7940 MPL ST PAUL 68 MEDTC 331-4247 MPL CHEYENNE WY 71 CLA 543-1095 60V GOLDEN VALLEY 70 IT
NGO CHARLES C M 730 NO FAIRVIEW NGUYEN NGA	AS IT STP GRAD HUE	NIEDERMEIER JANICE MAR 6409 COLONY WAY NIEDERINGHAUS ROBERT DA 2916 9TH ST SE NIEHAUS JAMES ROBERT DEPT OF GEOLOGY NIELAND BETH ANN 1787 FULHAM ST NIELING LINDA JEANNE 2627 XERES AVE NO NIELSEN -OBERT WAYNE TERRITORIAL HALL NIELSEN ANDRES HARBO J 4500 ORCHARD AVE N NIELSEN BRUCE VICTOR FRONTIER HALL NIELSEN CANDACE JEAN COMSTOCK HALL NIELSEN DALE STANLEY 592 E NEVADA AVE NIELSEN DAVID ALBERT 306 RIDGEWOOD NIELSEN DENNIS HAROLD 1264 N SHELLE NIELSEN DIANE A 3732 CEDAR AVE SO NIELSEN GREGORY A 1401 6TH ST SE NIELSEN JAMES MAURICE	71 CLA EDN EDINA 68 MED 339-2675 MPL MOBRIDGE SD GRAD MPL GRASS VALL CA 69 AGFHE 645-9771 STP ARLINGTON 70 IT 588-2582 ROB ROBBINSDALE 71 IT MPL SHAKOPBE 69 IT 537-7480 ROB VIENNA VA 71 IT MPL ORLEANS 69 CLA MPL ROCHESTER 71 AGFHE 771-1180 STP ST PAUL 70 DULTH 879-7980 CLOQUET 68 IT 646-2477 STP ST PAUL 71 CLA 723-3894 MPL MINNEAPOLIS 70 CLA 473-6073 MPL WAYZATA 70 CLA 474-4415 EXCELSIOR 71 CLA 313-6320 MPL EXCELSIOR AS BUS	NILSSON DENNIS ELOP 9245 NICOLLET AVE SO NILVA ALEXIS LAURIE 3541 GLENHURST AVE NIMAN ELAINE CAROL 1423 SHERIDAN AVE NO NIMLOS JOHN EDWARD 1405 5TH ST SE NIMMO LYNN NORA 520 HURON ST SE NIMS RONALD LEROY 1909 INDEPENDENCE NO NIMSGER JAMES RICHARD	70 DENT 884-2846 BLT BLOOMINGTON 69 GC 920-2055 SLP ST LOUIS PARK 69 ED 529-7921 MPL MINNEAPOLIS 69 CLA 331-7940 MPL ST PAUL 68 MEDTC 331-4247 MPL CHEYENNE WY 71 CLA 543-1095 60V GOLDEN VALLEY 70 IT
NICHOLS HAROLD LYNN 337 5TH AVE NO NICHOLS JAMES WILLIAM	68 GC WEB-8557 HOP HOPKINS 68 MORRS VERDI	NIELSEN KATHLEEN MARY 1115 MAGNOLIA LN NIELSEN CELIA ELNDRA 1201 WOODLAND AVE NIELSEN MARY ELLEN POMELL HALL NIELSEN MILO ALFRED	71 CLA 545-5039 MPL MINNEAPOLIS 68 DULTH 728-1577 WILLOW RIVER 71 CLA 373-6320 MPL ST PAUL GRAD 69 CLA 941-1849 EDN EDINA 68 ED 771-1780 STP ST PAUL GRAD GRAD	NINEFELDT JAMES PAUL	71 DULTH BARNUM GRAD SLP ST LOUIS PARK GRAD 373-7133 MPL CHIBA 70 DULTH ST PAUL 70 DULTH 724-6295 DULUTH 68 DULTH 724-6295 DULUTH GRAD 339-4796 MPL W LOS ANGELS CA 70 CLA 331-9748 MPL ST PAUL 71 IT 484-9498 MPL ST PAUL 69 GC 699-2460 STP ST PAUL 71 CLA 588-1742 MPL MINNEAPOLIS 68 OT 339-6651 MPL HONOLULU HI 68 ED 777-1166 NSP NORTH ST PAUL 70 CLA 777-1166 NSP NORTH ST PAUL 70 DULTH VIRGINIA
NICHOLS JOHN ARTHUR 501 4TH ST SE NICHOLS KAREN BROOKE 3025 GLENDEN TERR NICHOLS KATHLEEN MARIE 7524 17TH AVE SO NICHOLS MARK DOUGLAS 6949 HICKORY DR NICHOLS MARY EILEEN 4553 ELLERDALE NICHOLS PAUL LESLIE 722 10TH ST SO NICHOLS ROBERT MICHAEL 103 W 4TH ST P O 844 NICHOLS SANDRA LEE 4423 PLEASANT SO NICHOLS TERRANCE THOMA TERRITORIAL HALL NICHOLS WILLIAM KENNET 616 ONTARIO ST SE NICHOLSON CARY LOUISE 4915 COLFAX AVE SO NICHOLSON DONALD MURDO 4915 COLFAX AVE SO NICHOLSON FRED JAMES 1632 COMO AVE NICHOLSON MERLE A 16201 HILLTOP RD NICHOLSON ROBERT CHARL	GRAD MPL CUYAHOGA FLS OH 69 GC 588-8997 ROB ROBBINSDALE 69 IT 866-5756 RMF RICHFIELD 69 IT 784-7998 FRD FRIDLEY 71 CLA 935-3745 MTV MINNETONKA GRAD MPL SANDUSKY OH 70 MORRS VERDI 71 CLA 825-4049 MPL MINNEAPOLIS 71 CLA MPL WALKER GRAD 331-3685 MPL KENT WA 70 NURS 822-1607 MPL MINNEAPOLIS 68 BUS 822-1607 MPL MINNEAPOLIS 68 CLA 645-8962 MPL ST PETER GRAD 941-1013 EDP 69 BUS	NIELSEN STEPHANIE BLAI 1908 SE COMO NIELSEN STEVEN JEROME 1009 SUMTER AVE NO NIELSEN STUART ALLEN 1423 WASHINGTON AVE SO NIELSON GREGG RICHARD ROOM 212 PINE HALL NIEMAN JAMES DOUGLAS 925 FREMONT NIEMANN BARBARA JEAN 5501 GARFIELD SO NIEMEYER NANCY ANN 1364 SUMMIT AVE NIEMI BILL HOWARD CENTENNIAL HALL NIEMI CAROL JEAN 815 BIRCH ST NIEMI CAROL LILLIAN 2019 E 2ND ST NIEMI CONSTANCE MARIE 1015 ESSEX ST SE NIEMI JACK MEREDITH 24 W HARVEY ST NIEMI JEAN ELIZABETH COMSTOCK HALL NIEMI MICHAEL LYNN 729 8TH AVE SE NIEMI PAULA JEAN 211 SO MAIN AURORA NIEMI SANDRA KAY 528 SE ONTARIO NIEMI SANDRA MARGARET 3435 MC KINLEY ST NE NIENINEN THOMAS TOIVO	69 CLA 941-1849 EDN EDINA 68 ED 771-1780 STP ST PAUL GRAD GRAD 69 GC 71 CLA 331-9994 MPL MINNEAPOLIS 71 DENT 549-7794 GOV GOLDEN VALLEY 69 CLA 333-7480 MPL MINNEAPOLIS 70 MORRS WHEATON 68 GC STP ST PAUL 68 GC 825-0271 MPL MINNEAPOLIS 68 ED 698-9661 STP ST PAUL 69 IT MPL BIWABIK 71 DULTH CLOQUET 70 DULTH IRON JUNCTION 68 ED 331-6212 MPL EMBARRASS 69 DULTH ELY 69 ED 373-7371 MPL EVELETH 70 IT MPL CLOQUET 69 DULTH 229-6020 AURORA 70 MED 331-1419 MPL STAPLES 70 CLA 781-1781 MPL MINNEAPOLIS 70 IT	NINNO ALFREDO FLUCK 6801 MEADOWBROOK BLVD NINOMIYA YUKO COMSTOCK HALL NIPPERT CARL LOUIS JR	71 DULTH BARNUM GRAD SLP ST LOUIS PARK GRAD 373-7133 MPL CHIBA 70 DULTH ST PAUL 70 DULTH 724-6295 DULUTH 68 DULTH 724-6295 DULUTH GRAD 339-4796 MPL W LOS ANGELS CA 70 CLA 331-9748 MPL ST PAUL 71 IT 484-9498 MPL ST PAUL 69 GC 699-2460 STP ST PAUL 71 CLA 588-1742 MPL MINNEAPOLIS 68 OT 339-6651 MPL HONOLULU HI 68 ED 777-1166 NSP NORTH ST PAUL 70 CLA 777-1166 NSP NORTH ST PAUL 70 DULTH VIRGINIA
NICKEL BETTY JEAN 914 E 2ND NICKEL LORNA MAE 1398 MIDWAY PKWY NICKELS CAMERON CHARLE 2297 STANDISH NICKERSON DONNA HYATT 3601 MAPLEWOOD DR NE NICKERSON WILLIAM JORD GRIGGS HALL C217 NICKLOW ANTHONY GEORGE 4644 ALDRICH S NICKOLAY LAWRENCE RAY 1064 SO ROBERT NICOL BRIAN FRANCIS	69 CLA MPL MOUNTAIN LAKE 71 DULTH 727-6636 DULUTH 69 NURS 644-5549 STP MOUNTAIN LAKE GRAD STP GRAD 789-3671 STA 71 DULTH 724-9813 WAYZATA 70 CLA TAZ-4862 MPL MINNEAPOLIS 71 CLA 222-6081 WSP WEST ST PAUL 68 ED	NIENABER DANIEL CHARLE 1641 ROSS AVE NIENABER HARRY ALLEN 3915 39TH AVE SO NIENKERK LARRY LYNN 2323 CLINTON AVE SO NIER KEITH ALFRED 2279 HOYT AVE W NIERENGARTEN BARBARA J COMSTOCK HALL NIERENGARTEN JOAN BLAM 2503 BRIGHTON AVE NE	69 BUS 771-0389 STP ST PAUL 68 BUS 724-5518 MPL 71 CLA 338-7264 MPL MINNEAPOLIS 68 CLA 645-5074 FLM FALCON HEIGHTS GRAD MPL NEW ULM 70 CLA 789-8190 MPL MINNEAPOLIS	NISS DAVID FRUEN 708 5TH ST SE NIST JOHN ALAN 1125 5TH ST SE NIST ROBERT STONE 10346 MISSISSIPPI BRVD NISTLER MARGARET JOANN 1708 ARROWHEAD RD	69 IT 331-9785 MPL LANE SD 68 CLA 331-2792 MPL MINNEAPOLIS 68 IT 421-8234 MPL MINNEAPOLIS 71 DULTH 724-8075
NICOL SUSAN ELIZABETH 707 5TH ST SE NICOLAI PHILLIP JON 1721 UNIVERSITY AVE SE NICOLAY NICKOLAS WALTE 3624 11TH AVE SO NICOLETTE CHARLES CARE 4144 QUINCY ST NE NICOLSON JOHN ALEXANDE	GRAD 331-1656 MPL BRIARCLIFF M NY 68 ED 331-1708 MPL HECTOR 69 CLA 722-7483 MPL MINNEAPOLIS GRAD 788-7916 MPL GRAD	NIEBAUER DANIEL CHARLE 1641 ROSS AVE NIENABER HARRY ALLEN 3915 39TH AVE SO NIENKERK LARRY LYNN 2323 CLINTON AVE SO NIER KEITH ALFRED 2279 HOYT AVE W NIERENGARTEN BARBARA J COMSTOCK HALL NIERENGARTEN JOAN BLAM 2503 BRIGHTON AVE NE	69 BUS 771-0389 STP ST PAUL 68 BUS 724-5518 MPL 71 CLA 338-7264 MPL MINNEAPOLIS 68 CLA 645-5074 FLM FALCON HEIGHTS GRAD MPL NEW ULM 70 CLA 789-8190 MPL MINNEAPOLIS	NISS DAVID FRUEN 708 5TH ST SE NIST JOHN ALAN 1125 5TH ST SE NIST ROBERT STONE 10346 MISSISSIPPI BRVD NISTLER MARGARET JOANN 1708 ARROWHEAD RD	69 IT 331-9785 MPL LANE SD 68 CLA 331-2792 MPL MINNEAPOLIS 68 IT 421-8234 MPL MINNEAPOLIS 71 DULTH 724-8075

MISULA JACK THOMAS 330 16TH AVE E SOUTH ST NITZ DAVID ALLEN 3625 FAIRLAWN DR NITZ DENNIS HARRY 1212 LAURIE ROAD W NITZ LARRY ALLAN 509 2ND ST SO NITZ ROMA L K 2310 DOUGLAS DR NIX ANDREA MARIE 518 ONTARIO ST SE NIX LINDA JOYCE 631 DNT ST SE NIX ROY GERALD 631 ONTARIO ST SE NIXON CHARLES THOMAS 1904 15TH AVE SO NIXON DAVID HERBERT 4222 WENTWORTH AVE S NIXON JAMES FRED	68 DULTH VIRGINIA 68 CLA 473-7997 MTV ST LOUIS PARK 70 CLA 489-2452 STP ST PAUL 71 CLA 938-9538 HOP HOPKINS 69 CLA L14-4301 GDV GOLDEN VALLEY GRAD 331-8557 MPL BOVEY AS CLA MPL GALETON CO GRAD MPL GOLDEN CA 69 CLA MPL WINONA 70 CLA 823-4962 MPL MINNEAPOLIS GRAD	NONNEMACHER THOMAS HEM 1207 W SKILLMAN AVE NONNEMACHER VINCENT 1207 W SKILLMAN NOONAN SARAH JOHANNA 3720 XERXES AVE NO NDPONE BEVERLY ANN 306 E COMSTOCK HALL NORAN WILLIAM HAROLD 4502 GOLF TERRACE NORBACK BRUCE ALLAN 317 SE UNION ST NORBACK DAVID CHARLES 832 22ND AVE NORBERG CARL E 438 PORTLAND NORBERG DANNY LEROY NORBERG MARILYN JUNE 1717 E 1ST ST NORBERG MARVEL JERINE 1122 COMO AVE SE NORBERG WILLIAM ARNOLD 2223 36 1/2 ST NORBLUM MARY LEE 1000 5TH ST SE NORBURY GERALD EUGENE 2804 NEVADA AVE S NORBY CHARLES ALBERT 1441 PIONEER HALL NORBY DIANNE LORRAINE 2700 30TH AVE NE NORBY JOHN CLIFFORD TERRITORIAL HALL NORBY KATHERINE ANNE PIONEER COURT NORBY LEROY RICHARD 5430 PENN AVE SO NORBY LOIS KRUSCHKE 1010 PUGHKEEPSIE AVE NORBY MARRIE BARBARA 4646 GARFIELD AVE SO NORCROSS JAMES CORNELI 312 HARVARD ST SE NORD BERYL ANNETTE 6824 KNOLL ST NORD DENNIS ALTON	70 AGPHE 488-8584 ROY ROSEVILLE 69 AGPHE 488-8584 ROY ROSEVILLE 70 CLA 529-6228 MPL MINNEAPOLIS 69 CLA 331-2161 MPL WHITE BEAR LAKE 68 MED 922-0347 EDN EDINA 69 MED 331-1839 MPL EDINA 70 CLA 633-4318 MPL MINNEAPOLIS GRAD 225-9243 STP BRUCE CRSG NG MI 70 CLA 396-2484 BRAHAM 68 DULTH 728-4790 BARNUM 68 CLA 331-6531 MPL BARNUM 68 BUS 721-1471 MPL BATTLE LAKE 68 ED 336-4373 MPL LITCHFIELD GRAD W49-0193 SLP ST LOUIS PARK 68 CLA 373-6277 MPL GRANDFORKS ND 69 ED 781-9187 STA ST ANTHONY 69 GC MPL NEW CANAAN CT 69 PT MPL LEAWOOD KS 70 CLA 920-5691 MPL AS MORRS 589-4102 MORRIS 70 CLA 825-6052 MPL JACKSONVILLE 69 CLA 331-4125 MPL MILACA 70 CLA 545-1224 GDV GOLDEN VALLEY 69 GC 835-7709 BLACKDUCK 69 CLA 545-9618 SLP ST LOUIS PARK 71 DENT MPL GRAND FORKS ND 71 CLA 922-2387 EDN EDINA 68 DENHY 333-0389 MPL GRAND FORKS ND 68 ED 777-4213 NSP NORTH ST PAUL 70 LAW 888-4872 BLT BLOOMINGTON 69 IT MPL OLIVIA 69 CLA MPL HENNING 68 GC 789-3426 MPL MINNEAPOLIS 68 ED 579-5528 MPL MINNEAPOLIS 71 CLA 789-6388 MPL MINNEAPOLIS 71 DULTH 728-1105 DULUTH 70 CLA 822-8515 MPL MINNEAPOLIS 68 CLA 374-2421 MPL MINNEAPOLIS 68 IT 71 CLA MND MOUND 69 GC 788-2800 MPL MINNEAPOLIS 70 MORRS 842-4801 BENSON GRAD 332-6254 MPL WINDOM 71 CLA MPL FAIRMONT 68 DULTH PEQUOT LAKES 71 CLA 521-7390 MPL MINNEAPOLIS 69 DULTH 624-9203 DULUTH 70 CLA 888-2130 BLT BLOOMINGTON 70 CLA 941-2626 MPL EDINA 70 IT 70 DULTH 624-9203 DULUTH 69 IT 645-2089 STP WORTHINGTON 71 CLA 869-2543 MPL MINNEAPOLIS 68 GC 774-2939 STP NORTH ST PAUL 68 MORRS WAMPETON ND	NORDGAARD KEITH DOUGLA AS EO NORDGREN JAMES ALFRED GRAD NORDGREN THOMAS PALMER 70 CLA 784-0202 1750 BRONSON DR MPL MINNEAPOLIS NORDHOLM DENNIS LEE 71 CLA 724-8190 3128 E 36TH ST MPL MINNEAPOLIS 70 CLA MPL EXCELSIOR NORDIN DAVID RAYMOND 70 CLA 722-8559 3604 LONGFELLOW AVB MPL MINNEAPOLIS NORDIN HAROLD CARL 68 DULTH 724-9823 GRIGGS HALL A111 HIBBING NORDIN JANICE MARIE 68 AGFHE 331-7012 915 22ND AVE SE MPL CLEARBROOK 68 ED MPL OHATONNA NORDIN MARY ELIZABETH 71 DULTH 724-4849 1521 E 4 ST DULUTH NORDIN PHILLIP DUANG 70 AGFHE 724-6245 4811 34 AVE SO MPL MINNEAPOLIS NORDIN WILBERT MICHAEL 68 GC 822-3874 3908 PARK AVE MPL 70 CLA 331-2394 NORDINE ANNETTE MARIE 70 CLA 331-2394 520 WASHINGTON AVE SE MPL ST CLOUD NORLAND ELIZABETH ANN 68 DULTH 865-6763 113 1 AVE N BOX 262 BITWABIK GRAD NORDLING DENISE VIRGIN 71 DULTH 724-9863 GRIGGS HALL M217 HALLOCK NORDLING GALE KENNETH 71 IT FRONTIER HALL MPL HALLOCK NORDLUND KELLY JOEL 70 AGFHE	69 AGFHE 646-3196 STP CLEARBROOK 69 NURS 429-2995 WTB WHITE BEAR LAKE 71 CLA 724-3554 MPL MINNEAPOLIS 69 GC RHF RICHFIELD 68 ED 869-9595 RHF RICHFIELD 69 DULTH MCGREGOR GRAD MPL MINNEAPOLIS 68 DULTH 724-4566 DULUTH 70 CLA 929-6920 2833 LOUISIANA AVE SO SLP ST LOUIS PARK 69 AGFHE W42-1622 SLP ST LOUIS PARK 71 CLA 881-4442 BLT BLOOMINGTON 69 DULTH 724-7028 DULUTH 70 AGFHE 522-9052 MPL MINNEAPOLIS 69 GC 824-5516 MPL MINNEAPOLIS 70 DULTH 724-4566 DULUTH 68 ED 729-5786 MPL MINNEAPOLIS 69 ED 926-0777 SLP ST LOUIS PARK 71 MORRS 589-3121 MINNEAPOLIS 69 GC 824-5516 MPL MINNEAPOLIS 70 DULTH 245-2767 SANDSTONE 71 CLA 822-8664 MPL PINE CITY 69 CLA	71 DULTH 727-5201 DULUTH 70 NURS 339-0531 MPL MORRISTOWN 69 DULTH 724-6194 DULUTH 70 CLA 455-9572 ING INVER GROVE 70 CLA 824-2995 MPL MINNEAPOLIS GRAD 333-3897 MPL PINE CITY 68 ED 488-8401 ROY ROSEVILLE 68 CLA 588-3358 ROB ROBBINSDALE 70 MED 331-8237 MPL MOOSE LAKE 71 CLA 489-9231 STP ST PAUL 68 AGFHE 698-8975 STP CHISAGO CITY 70 AGFHE 545-9232 GDV GOLDEN VALLEY 69 DULTH HIBBING NOREUS WILLIAM ROBERTS 68 BUS 1129 UNIVERSITY AVE SE MPL CLOQUET NORGAARD KATHERINE BLL 70 CLA 633-4695 1380 TERRACE DR ROY ROSEVILLE
--	---	--	--	--	--	--

NORGREN BARBARA JEAN 5301 IVANHOE ST NORGREN DIANE GENEVIEV 5204 JAMES AVE SO NORGREN JOHN CHARLES 5024 CAMDEN AVE NO NORGREN LARRY ALLAN 3806 STINSON BLVD NORHA MARY ELAINE 4545 MIDWAY RD NORINE GARY LOWELL 923 21ST AVE SO NORLAND LINDA LOU	70 DULTH 525-2874 DULUTH 70 AGFHE 922-8870 MPL MINNEAPOLIS 70 CLA 521-0597 MPL MINNEAPOLIS 69 CLA CLH FERGUS FALLS 69 DULTH 729-8889 69 BUS 338-3734 MPL PENNOCK 69 GC	NORTHFIELD JEFFREY WAY 6938 4TH AVE SO NORTHROP DAN ARTHUR 1395 MARYLAND AVE NORTHROP ALICE CLARA 3912 17TH AVE SO NORTON ALAN JOE 3105 115TH AVE NORTON BETTY LOU RT 4 BOX 529A NORTON C WILLIAM 4848 EMERSON AVE SO NORTON CHARLES LOONIS 160 FT SNELLING NORTON DANIEL TERRENCE	71 CLA 869-1059 RHF RICHFIELD 68 GC 774-0736 STP ST PAUL 71 CLA 722-5915 MPL MINNEAPOLIS 71 CLA 421-1326 CNR COOM RAPIDS 71 DULTH 728-1391 DULUTH 71 CLA 825-5298 MPL MINNEAPOLIS 68 LAW PA1-4917 STP ST PAUL 69 GC	NOVAK ROBERT CHARLES 931 SIMS AVE NOVAK ROBERT WENCELL P O 487 NOVAK ROGER ALAN 901 E RIVER ROAD SE NOVAK SANDRA LYNN 2634 HOWARD ST NE NOVECKI HELMUT KARL 123 SUMMIT AVE #26 NOVICH LESLEY SUE 9211 OLSON HWY NOVICH SHIRLEY 5211 OLSON HWY NOVICK EDWARD MARSHALL	71 IT 771-4389 STP ST PAUL 70 MORRS EMILY 69 DENT 331-1801 MPL ST PAUL 71 CLA 789-5979 MPL MINNEAPOLIS 69 GC 226-1286 STP ST PAUL 71 CLA 544-4746 GOV GOLDEN VALLEY AS CLA GOV 68 BUS
NORLIN WILLIAM THOMAS 5605 32 AVE SO NORLING CARROLL DAVID 6228 PLEASANT AVE SO NORLING PATRICIA JUNE 101 E 98TH ST NORMAN ALFRED LORN 2006 PARK AVE NORMAN ANN CHRISTINE 4315 GLADSTONE ST NORMAN ANN GREGOR CHRI 979 14TH AVE SE NORMAN BRUCE STANLEY 4640 PORTLAND AVE SO NORMAN ELIZABETH ANNE 2401 W 105TH ST NORMAN JAMES CHARLES 3927 HAYES ST NE NORMAN JAMES HARLOW 2212 W 8TH ST NORMAN JAMES MICHAEL 2214 E 3RD ST NORMAN JAMES PETER	71 CLA 729-9485 MPL MINNEAPOLIS GRAD UN9-5140 RHF 70 CLA 881-5091 BLT BLOOMINGTON GRAD MPL W VANCOUVER 71 DULTH 525-5093 DULUTH AS CLA 331-7140 MPL MINNEAPOLIS 69 GC 822-0590 MPL MINNEAPOLIS 69 ED 881-8827 BLT 71 CLA CLH COLUMBIA HTS AS DULTH 722-4364 DULUTH 68 DULTH 724-2555 DULUTH AS ED	NORTON DAVID PAUL NORTON DON EVAN JR NORTON JAMES MAXFIELD 160 FORT SNELLING NORTON MARK GEORGE 1251 NORTON AVE NORTON MICHAEL JOH 117 WILDWOOD AVE NORTON RICHARD ERIC FRONTIER NORTON WILLIAM ELLIOT 3940 NATCHEZ NORVITCH LYNDY FERN 219 W KENT RD NORWICH ELLEN ANN 7225 MONARDO LN NORWOOD ARLA MAE 114 E 9 ST NOSAN RICHARD DALE PIONEER HALL NOSANOW BARBARA FIELD 1140 WASHBURN AVE SO NOSCO DARLENE ESTHER 3412 PARK TERRACE NOSCO ROSEALYN ANNE 3412 PARK TERR NOSEK DEAN ARTHUR 5525 HIGHLAND ST NOSER GARY ALLAN 327 UNIVERSITY AVE SE NOSKA JAMES MICHAEL IA	71 CLA 922-7246 NORTH BRANCH GRAD 71 IT 721-4917 STP ST PAUL 69 CLA 784-2482 FRD FRIDLEY 70 CLA 426-2540 HTB WHITE BEAR LAKE 71 IT 257-8154 MPL LINDSTROM 68 GC 926-0872 SLP ST LOUIS PARK 71 DULTH 728-1596 DULUTH 69 GC 922-7649 EDN EDINA 71 DULTH BRAINERD 69 IT 258-3754 MPL BUHL AS CLA 374-5385 MPL 71 AGFHE 729-2209 MPL MINNEAPOLIS 70 CLA 729-2209 MPL MINNEAPOLIS 69 DULTH 624-5610 DULUTH 70 CLA MPL ROCHESTER 71 IT	NOVICK GAYLE LINDA 1731 STANFORD AVE NOVOSEL STEVEN JOSEPH 376 NO CLEVELAND AVE NOVOTNEY MARTLYN BARBA 3537 ZINMAN SO NOVOTNY DENNIS GARY 500 11TH AVE SO NOVOTNY HENRY MARTIN NOVOTNY MARVIN JOHN 2620 CEDAR AVE SO NOVOTNY MARY ELLEN NOVOTNY MICHAEL PATRIC FRONTIER HALL NOVOTNY RAYMOND LEO 25 5TH ST NW NOVOTNY ROSELYN MARY 217 RIDGWOOD AV NOWAK BARBARA CAROLB 600 UNIVERSITY AVE SE NOWAK DAVID MARTIN 2735 TAYLOR ST NE NOWAK DAVID MICHAEL 613 1/2 E 5TH ST NOWAK DIETER	70 CLA 699-7996 STP ST PAUL 68 ED 646-7697 STP ELY 70 CLA 938-8161 SLP ST LOUIS PARK 69 CLA GL5-8459 SSP SOUTH ST PAUL AS ED 70 CLA 724-3814 MPL JORDAN 69 CLA 71 CLA C03-2293 MPL CANNON FALLS 69 CLA 425-3047 OSO CANNON FALLS 69 ED 338-8095 MPL MINNEAPOLIS AS CLA 335-7388 MPL SPOKANE WA AS GC 781-9717 MPL 69 DULTH 727-6481 DULUTH GRAD 69 BUS
NORMAN NORBERT JOHN 316 W DWATONNA ST NORMAN SUZANNE JUDITH 2714 VINCENT AVE NO NORMOYLE ROBERT LOUIS 1315 7TH ST SE NORQUIST CHERYL LOUISE 3440 32ND AVE SO NORQUIST JOSEPH SPENCE 3938 STEVENS AVE SO NORREGAARD KRISTIN HEL 1115 26 EMERSON W NORREGAARD DARRELL ANDRE 9655 GRAND AVE SO NORREGAARD RAYMOND ARTHU 1875 GLENPAUL RD NORREGAARD YVONNE MARLEN 1313 6TH ST SE NORRIS ERIC RANDOLPH 4038 3RD AVE SO NORRIS JOHN EUGENE 1475 CLEVELAND AVE N NORRIS JOHN WILEY 1815 UNIVERSITY AVE SE NORRIS MARGO PINNEY JE 65 104TH AVE NW NORRIS MARY ELIZABETH 519 3RD AVE SE NORRIS WAYNE ARNOLD	70 DULTH 724-5729 DULUTH 69 ED 529-3939 MPL MINNEAPOLIS GRAD 331-5780 MPL HUNTINGTON S 68 ED 729-3967 MPL MINNEAPOLIS 69 VET H 824-9549 MPL MINNEAPOLIS 69 GC 445-2780 MPL SHAKOPEE 70 CLA 888-5948 BLT BLOOMINGTON 71 AGFHE 633-2391 COURTLAND 69 ED 338-9610 MPL CLOQUET 70 CLA 825-5764 MPL MINNEAPOLIS 71 AGFHE 645-8231 NSP NELSON 70 CLA 331-3564 MPL BRAINERD AS ED 757-4828 CNR 70 CLA MPL BELGRADE 71 IT	NOST BONNIE ELAINE 2213 FREMONT NOTARO DAVID MARTIN 4036 HUMBOLDT AVE NO NOTHMAGEL ERVIN EDWARD 70 CLA NY 7509 LYNDALD AVE SO NOTHMAGEL JAMES GEORGE 3001 E OLD SHAKOPEE RD NOTHMAGEL MONICA ANN 3001 E OLD SHAKOPEE RD NOTSCH JOHN CHARLES 2942 MC KINLEY ST NOTSKE ROBERT NORMAN	69 DULTH AURORA 71 CLA 735-3309 STP ST PAUL 68 GC 521-8789 MPL MINNEAPOLIS 70 CLA RHF BLOOMINGTON 71 CLA 888-5727 BLT BLOOMINGTON 69 CLA 888-5727 BLT BLOOMINGTON 69 CLA ST1-7719 MPL MINNEAPOLIS GRAD GRAD 926-3094 MPL 68 CLA 929-2260 SLP ST LOUIS PARK 71 CLA 331-7935 MPL ROCHESTER NY 69 CLA 331-7935 MPL ROCHESTER NY 71 MED 645-1025 STP NEW YORK MILLS 71 IT PA2-6056 MPL MINNEAPOLIS 68 CLA 922-1810 MPL MINNEAPOLIS 70 DULTH 722-0762 DULUTH 68 PHARM 331-5829 MPL 68 AGFHE NEW PRAGUE 71 CLA 339-0931 MPL NEW ULM 68 IT 378-5235 MPL VIRGINIA 69 IT MPL GILBERT 68 DULTH KEEWATIN 68 IT 373-6285 MPL VIRGINIA 70 CLA 488-2262 STP ST PAUL 71 CLA 537-8073 ROB ROBBINSDALE 69 AGFHE 331-5829 MPL MOOSE LAKE 70 CLA 437-4092 HST HASTINGS 69 LAW 644-6782 STP ST PAUL 68 ED	NOYES BRUCE ALBERT 1484 IGLEHART NOYES HAROLD JAMES NOYES RONALD RALPH 3541 BENJAMIN ST NE NOZAL GLORIA KATHLEEN COMSTOCK U OF M NDS BRYAN DALE 2044 BREWSTER NUBSON RICHARD CHARLES 12708 WAYZATA BLVD NUCKOLS TROY E NUDELL ELLIOTT BERNARD 2115 VINCENT NO NUDELL SUSAN JO 3228 HOLMES SO NUEBEL MARY KATHRYN 500 ESSEX SE NUECHTERLEIN KBITH HER 1224 HUBBARD NUERNBERGER EDWIN PHIL 309 4TH ST SE NUGENT JACK EARL NUGENT NANCY LEE 4456 PORTLAND AVE SO NUMMEDAL KJELL 840 18TH AVE SE NUMMEDAL SUSAN GORDON 840 18TH AVE SE NUNESS ALBERT FRONTIER HALL NUNEZ SUSANA NAVARRETE 2220 PLEASANT SO NUNGESSER BEVERLY JEAN 5430 THREE POINTS BLVD NUNN MARTHA REBECCA POWELL HALL NUNN NANCY HUNTER LEE 1609 WOODBRIDGE NUNN ROGER GARY 5609 GATE PARK RD	69 AGFHE 645-2278 STP WELLS 71 IT 225-5426 STP ST PAUL 68 IT 473-6040 WAY WAYZATA 69 CLA 331-1424 MPL WAYZATA 69 IT 331-7916 MPL MINNEAPOLIS 70 CLA 338-2233 MPL 68 ED 338-2269 MPL MINNEAPOLIS 68 LAW 338-1079 MPL MINNEAPOLIS 71 CLA 545-5369 SLP ST LOUIS PARK 69 GC 69 CLA 645-7353 STP ST PAUL 70 DULTH HINCKLEY AS GC 781-9604 MPL 69 ED 373-7184 MPL VIRGINIA GRAD 644-0600 STP EUREKA IL 68 GC 544-5687 MTV GRAD 70 VET M 521-7192 MPL MINNEAPOLIS AS ED 825-4850 MPL MINNEAPOLIS 68 DENHY 331-0531 MPL ST PAUL 70 CLA 645-2553 STP ST PAUL GRAD 336-4009 MPL EDWARDSVILLE IL AS GC 69 GC TA5-7818 MPL MINNEAPOLIS GRAD 331-0959 MPL NORWAY GRAD 331-6959 MPL WALNUT CREEK CA 69 ED MPL HAYWOOD IL GRAD 71 CLA 472-1141 MND MOUND 70 CLA 339-0531 MPL CHAMPLIN 68 ED 488-0749 STP ST PAUL 71 CLA 929-2268 EDN EDINA
NORTHY KAREN LYNN 5436 34TH AVE SO	70 CLA PA4-4168 MPL MINNEAPOLIS	NOVAK PATRICK JOSEPH 809 MARSHALL ST NE	69 CLA FE8-1792 MPL APD NY		



OCHU JEANNE ANNE 68 ED 789-2112  
3480 GARFIELD ST NE MPL MINNEAPOLIS

OCONNELL BEVERLY JEAN 71 AGFHE 781-2124  
684 37TH AVE NE MPL MINNEAPOLIS

OCONNELL CHRISTINE RUT 71 CLA 781-2127  
3012 ARMOUR TERRACE MTV MINNETONKA

OCONNELL DANIEL JOHN 71 CLA  
1229 7TH ST SE MPL CHIPPEWA FL S WI

OCONNELL GLORIA L 70 CLA 699-9636  
1497 FAIRMOUNT STP ST PAUL

OCONNELL JAMES JOSEPH 70 DULTH 729-8933  
RT 2 BOX 278 CLOQUET

OCONNELL JAMES STEVEN 68 BUS

OCONNELL MARVIN JOSEPH 70 VET M 644-1649  
2111 GORDON AVE STP WAUBUN

OCONNELL MICHAEL JOHN 69 MED 336-7947  
57 MELBOURNE AVE SE MPL HOPKINS

OCONNELL NANCY JO 71 CLA  
1894 SELBY STP ST PAUL

OCONNELL TERENCE EDWA 69 BUS 929-2722  
2624 GEORGIA AVE SO SLP MINNEAPOLIS

OCONNELL THOMAS RICHAR 69 BUS  
1497 FAIRMOUNT ST STP ST PAUL

OCONNELL THOMAS RICHAR 70 CLA 938-1367  
1517 PRESTON LANE HOP HOPKINS

OCONNOR CHARLES DENNIS 69 GC 929-6468  
3021 PENNSYLVANIA S SLP ST LOUIS PARK

OCONNOR DAVID EDWARD 69 GRAD 888-0577  
10049 IRWIN RD BLT

OCONNOR DAVID MICHAEL 70 CLA 771-7620  
1980 E ORANGE STP ST PAUL

OCONNOR EDWARD JOHN 69 CLA 721-7043  
4323 MINNEHABA AVE MPL MINNEAPOLIS

OCONNOR ELLEN LOUISE 70 CLA  
427 15 AVE SE MPL MINNEAPOLIS

OCONNOR GARY MICHAEL 68 CLA 646-5504  
823 FRY ST STP MINNEAPOLIS

OCONNOR HELEN GOLTZ 68 GRAD

OCONNOR JAMES FRANCIS 68 GRAD

OCONNOR JAMES FRANCIS 69 MORSC  
2648 W BROADWAY MPL BRATTLEBORO VT

OCONNOR JAMES PATRICK 68 IT 929-1502  
3036 JERSEY AVE SO SLP ST LOUIS PARK

OCONNOR JUSTINE FOOTE 69 AS CLA 633-4212  
1970 STOME AVE ANH

OCONNOR MARGARET ANN 68 ED 771-7620  
1980 E ORANGE AVE STP ST PAUL

OCONNOR MARY ELIZABETH 69 NURS 699-7656  
314 10TH AVE SE MPL ST PAUL

OCONNOR MICHAEL JOHN 71 CLA 929-3415  
4071 BROOKSIDE AVE SLP ST LOUIS PARK

OCONNOR MICHAEL THOMAS 68 CLA 646-0079  
1170 CHARLES AVE STP ST PAUL

OCONNOR ROBERT MICHAEL 71 IT 881-5747  
8424 CLINTON AVE S BLT BLOOMINGTON

OCONNOR THOMAS JAMES 70 CLA 442-2962  
WACONIA

OCONNOR THOMAS PATRICK 70 CLA 735-2746  
2165 NORTONIA AVE STP ST PAUL

OCONNOR WILLIAM CHARLE 68 GRAD

ODAIR JERRY PATRICK 70 CLA 533-7438  
3836 TOLEDD AVE N ROB ROBBINSDALE

ODBERG SUSAN IRENE 68 DULTH 727-2768  
340 GILEAD ST DULUTH

ODDAN LINDA ANN 68 MORRS 589-4693  
SPOONER HALL MILAN

ODDAN OLIVER WENDELL 68 MORRS  
408 E 2ND ST MILAN

ODDAN STEPHEN THOMAS 70 MORRS 589-2354  
408 E 2ND ST MILAN

ODDEN JAMES RICHARD 71 MORRS 589-3203  
PINE HALL BENSON

ODDEN STEPHEN PAUL 71 CLA 938-3607  
6016 WALNUT DR EDN EDINA

ODDEN TERESA ANN 70 CLA 333-8086  
1807 WASHINGTON AVE SOD MPL MINNEAPOLIS

ODDO ROBERT JAMES 69 IT 335-6494  
HOTEL PKWY MPL CHISHOLM

ODE WAYNE PAUL 71 VET M  
2116 COMO AVE STP LANESBORO

ODEA DANIEL FARNHAM 69 ED 777-4276  
1995 RADATZ AVE MPN MAPLEWOOD

ODEA ROBERT FRANCIS JR 71 MED 331-2834  
512 DELAWARE ST SE MPL ST PAUL

ODEGAARD BRUCE HAROLD 70 IT  
TERRITORIAL HALL MPL HUTCHINSON

ODEGAARD DANIEL OWEN 70 CLA 529-3700  
3311 VINCENT AVE NO MPL MINNEAPOLIS

ODEGAARD LESTER BRUCE 70 IT  
PIONEER HALL MPL NERSTRAND

ODEGAARD MARY KATHLEEN 69 AS GC 335-5765  
3125 27TH AVE MPL MINNEAPOLIS

ODEGAARD RALPH MAYNARD 69 GC 929-4978  
6009 HAMILTON ST SLP ST LOUIS PARK

ODEGAARD WAYNE MARLOW 69 AGFHE  
ANDREW HOUSE MPL CROOKSTON

ODEGARD STEPHEN JAMES 68 CLA 441-6800  
428 4TH ST SE HAL PRINCETON

ODEGARDEN JEAN LOUISE 70 CLA 331-2468  
810 8TH ST SE MPL CHATFIELD

ODELL FRANK DARREL 68 MORRS

ODELL JACK DAVID 70 CLA 771-7665  
339 E JESSAMINE STP ST PAUL

ODELL LIZABETH RUTH 69 ED 789-2254  
3506 ULYSSES ST NE MPL MINNEAPOLIS

ODELL LOREN HARRY 70 CLA 929-8291  
2817 MARYLAND AVE SO SLP

ODELL THOMAS TURNER 69 GRAD 929-1835  
5801 NORTHWOOD DR EDN EDINA

ODEN DALE JOHN 69 IT 338-9341  
1316 5TH ST SE MPL HOPKINS

ODEN MARIT ELIZABETH 69 MEDTC

ODENTAL ROSEMARY ANN 69 GRAD 373-7115  
COMSTOCK HALL MPL STATEN ISL NY

ODERMANN JACQUELINE AN 71 CLA  
411 SANFORD MPL PLAINVIEW

ODESSKY JUDITH RAE 70 CLA 529-1391  
1653 PENN NO MPL MINNEAPOLIS

ODETTE THOMAS ERNEST 68 DULTH 728-2287  
1915 E 4TH ST MINNEAPOLIS

ODIO EDUARDO E 69 AS DENT 699-3140  
1338 W MAYNARD STP MIAMI CO

ODIO ELIAS FERNANDO 68 DENT 699-2031  
1338 W MAYNARD DR STP MIAMI FL

ODIO FERNANDO 71 CLA 699-2031  
1338 W MAYNARD DR STP ST PAUL

ODLAND CYNTHIA MARIE 68 ED  
1026 5TH ST SE MPL

ODLAND DOROTHY VOLLOM 69 GRAD 377-9141  
21 SHERIDAN AVE SO MPL ELY

ODLAUG DAVID JOHN 70 LAW 698-5996  
272 WOODLAWN STP ST PAUL

ODNE PATRICIA HAUGE JE 68 ED 777-1194  
2147 BURKE AVE E NSP

ODONNELL COLLEEN RITA 68 GC 926-7159  
3851 BEARD AVE SO MPL MINNEAPOLIS

ODONNELL JAMES FRANCIS 70 CLA 724-0650  
545 MIRIAM MEV MIESVILLE

ODONNELL JAMES PATRICK 68 CLA  
1282 BLAIR STP EVANSTON IL

ODONNELL MARGARET ANN 71 CLA  
SANDFORD HALL MPL EVANSTON IL

ODONNELL MICHAEL FRANC 69 DULTH 722-8488  
23 E 8TH ST DULUTH

ODONNELL MICHAEL JOHN 71 CLA  
810 8TH ST SE MPL FOREST LAKE

ODONNELL MICHAEL THOMA 71 IT 784-6531  
1240 80TH AVE NE SKP SPRING LAKE PK

ODONNELL MICHAEL WILLI 71 CLA 825-5669  
4922 ALDRICH SO MPL MINNEAPOLIS

ODONNELL THOMAS ANTHON 69 CLA  
810 8TH ST SE MPL FOREST LAKE

ODONOVICH LAURIE LEE 69 AGFHE 646-4222  
1387 CLEVELAND AVE STP CROSSBY

ODOGHERTY PATRICK AQU 68 ED 825-7612  
5015 GLADSTONE AVE SO MPL MINNEAPOLIS

ODOWD JACQUELYN JOY 70 CLA 922-1980  
5615 BROOKVIEW AVE EDN EDINA

ODREN RUTH ANN 69 GRAD 331-9065  
1086 16TH AVE SE MPL DUNN CTR ND

ODEHLER RONALD IRVING 71 CLA 336-4836  
1810 11TH AVE SO MPL MILWAUKEE WI

ODEHLKE JOHN ARTHUR 68 CLA 331-7929  
1102 18TH AVE NE MPL NEENAH WI

DELFEKE RICHARD HAROLD 71 CLA  
FRONTIER HALL MPL GLENCOE

DELIEN CARL GEORGE 68 MED 331-5225  
885 23RD AVE SE MPL WASECA

DELIEN RICHARD JOHN 68 CLA 373-6272  
PIONEER HALL MPL WASECA

DELSCHLAEGER DUANE ROY 69 GRAD

DELTIENBRUNS DENNIS WA 70 AGFHE 646-4790  
2060 CARTER AVE STP CLAREMONT

DERTEL RICHARD REINHAR 71 IT 929-7210  
5904 BERNARD PL EDN EDINA

DESTEMER GREGORIO ADAN 69 GRAD

DESTREICH DENNIS JOHN 68 GC 941-3538  
5125 MEADOW RIDGE EDN EDINA

DESTREICH JEFFREY NILS 69 CLA 331-3591  
813 DELAWARE SE MPL WHITE BEAR LAKE

OFALLON RICHARD GERALD 71 CLA 545-8723  
1220 OAKVIEW LANE PLY PLYMOUTH

OFFERDAHL STEVEN RAY 70 CLA  
2417 PLEASANT AVE S MPL BENSON

OFFERMAN CARINJO THERE 71 CLA 588-5044  
2220 LEGEND DR GOV GOLDEN VALLEY

OFFERMAN JAMES MICHAEL 71 CLA 426-2790  
53 GLENEDGE RD WTB WHITE BEAR LAKE

OFFERMAN JOHN DOUGLAS 68 CLA 331-5986  
1815 UNIVERSITY AVE SE DLW DELWOOD

OFFICER ROBERT SPENCER 71 CLA

OFSTAD EDWARD NORMAN J 71 DULTH  
705 9 AVE E ORR

OFSTAD SUSAN ANNETTE 71 DULTH 724-8973  
BURNTSIDE HALL 125 RICHFIELD

OFSTHUN STEPHANIE 70 CLA  
MILWAUKEE WI

OFSTIE GARY STEVEN 69 CLA 333-5073  
2418 BUTLER PLACE MPL ZUMBROTA

OFTELIE ROBERT STANLEY 71 CLA 326-3236  
GRAND RAPIDS

OFTOS ROBERT EARL 69 CLA 869-3590  
6128 13TH AVE S MPL MINNEAPOLIS

OGANEKU AMY 68 BIOSC  
POWELL HALL MPL HONOLULU HI

OGAMA JUNKO 69 GRAD 333-2161  
COMSTOCK HALL MPL SHIGA KEN

OGDAHL ROBERT ALLEN 68 CLA 331-7858  
1711 UNIVERSITY AVE SE MPL GLENWOOD

OGDEN KENNETH JAMES 70 CLA 866-8216  
6725 PILLSBURY AVE SO RMF RICHFIELD

OGG THERESE PAULETTE 70 MORRS  
P O 53 NORCROSS

OGILVIE WILLIAM IRVING 69 ED 645-8767  
1422 SHRYVER AVE W ROY ROSEVILLE

OGIST JUBE OLAWUMI 71 CLA 338-0218  
928 UNIVERSITY NE MPL SURULERE

OGLAND VANETTA SUYDAM 69 GRAD

OGLE SHERMAN FRANK 70 MED 339-7421  
10519 CENTENNIAL HALL MPL ST PETER

OGLESBY ARTHUR GENE 71 IT 289-2245  
TERRITORIAL MPL APPLETON

OGNANOVICH SUSAN KAY 69 GC 698-2334  
1824 WORDSWORTH STP ST PAUL

OGRAHY LILLA RUTH 70 MED 742-6186  
4839 THIRD AVE SO MPL MINNEAPOLIS

OGRAHY LOWELL ALEXANDE 68 IT

OGREN DENNIS HOWARD 69 MORRS  
BELLINGHAM

OGREN DONALD CARL 70 DULTH 724-2330  
1009 GRANDVIEW AVE CLOQUET

OGREN DOUGLAS LEB 68 BU 222-1001  
6 DORSET RD MEV MIESVILLE

OGREN JAMES CARL 68 GC 537-9521  
4511 COLORADO AVE N CYT CRYSTAL

OGREN MERRIE ESTHER 69 AGFHE 823-8973  
3448 EMERSON AVE SO MPL MINNEAPOLIS

OGREN RAYMOND JOSEPH 68 GC 771-8062  
1077 EARL STP ST PAUL

OGREN ROBERT SIGRUD 71 IT 823-8973  
3448 EMERSON AVE S MPL MINNEAPOLIS

OGREN ROBERT WILLIAM J 68 CLA 537-9521  
4511 COLORADO AVE NO CYT CRYSTAL

OGREN SUSAN ONA 69 CLA 335-7808  
915 UNIV AVE SE MPL MINNEAPOLIS

OGREN SUZANNE MARIE 69 CLA 335-5093  
801 20TH AVE S MPL WEST ST PAUL

OGROSKY BRADLEY ROBERT 70 IT 633-2264  
980 CRESSNA DR NWB ROCHESTER

OGUAMANAM CLETUS ONYEA 69 GRAD 333-8392  
2217 RIVERSIDE AVE SO MPL DNITSHA

OH KIE PYUNG 69 GRAD

OH SEAMHA 69 GRAD 373-7124  
COMSTOCK HALL MPL SEDUL

OH SUNGMIE 69 GRAD 331-6533  
1123 6TH ST SE MPL

OHALLORAN GLORIA JEAN 70 CLA  
1094 25TH AVE SE MPL OLIVIA

OHALLORAN LAWRENCE WIL 70 DENT 331-1324  
814 ESSEX SE MPL STEWARTVILLE

OHANLON WILLIAM J 69 GRAD 922-8514  
5741 VINCENT AVE S MPL MINNEAPOLIS

OHANLON WYM WILLOW 71 CLA

OHARA JAMES ARTHUR 68 IT

OHARA JAMES PATRICK 70 CLA 224-1706  
1106 DELAWARE/ STP ST PAUL

OHDE SHARON LOUISE 69 GRAD 333-2161  
COMSTOCK HALL CAMPUS MPL CARROLL IA

OHEHR JOHN RICHARD 71 DULTH 724-2208  
1822 EILEEN AVE DULUTH

OHEHR MARY SUSAN 68 DULTH  
1822 EILEEN AVE DULUTH

OHERON JEANNE CAMPBELL 69 ED

OHLAND KARON JBWEL 70 NURS  
GIBBON

OHLSON LINDA KAREN 71 CLA 633-1551  
1877 W CO RD D ANH ARDEN HILLS

OHLUND DENNIS BRUCE 69 DULTH  
WHITE BEAR LAKE

OHLY SALLY HERTOQS 70 AGFHE  
11934 HILLOWAY RD MTV

OHMAN JON GREGORY 69 IT  
1461 WYNE AVE STP GILBERT

OHMAN THOMAS JAMES 68 IT 588-4885  
3500 QUAIL AVE ROB ROBBINSDALE

OHMANN REINHARDT GEORG 69 GC 454-6710  
FRONTIER HALL MPL ROSEMOUNT

OHNESORGE JAMES PAUL 69 GRAD 786-3028  
6690 LUCIA LN FRD FT WAYNE IN

OHNSTAD JAMES NEIL 69 ED  
PIONEER HALL MPL FARIBAULT

OHR MICHAEL JOHN 70 CLA 488-9619  
1403 RICE ST APT 2 STP ST PAUL

OHRN STEVEN GREGORY 68 CLA 822-8620  
5100 PORTLAND AVE SO MPL MINNEAPOLIS

OHSHIMA SHIGEO 69 GRAD 331-1644  
1121 8TH ST SE MPL YONOHAMA

OIAN ROBERT ROY 69 CLA 521-4116  
3919 FREMONT AVE NO MPL MINNEAPOLIS

OIE MARK PETER 68 DULTH 724-0666  
2228 WAVERLY AVE DULUTH

OINES DONALD WARREN 69 GRAD

OJAKANGAS MARILYN JBAN 70 DULTH 724-6487  
421 N 23RD AVE E HIBBING

OJALA DAVID FRBD 68 PHARM

OJALA DEANN MAE 69 DULTH  
2331 E 5 ST ELY

OJALA ELIZABETH ANN 68 NURS 331-6813  
520 HURON ST SE MPL ST PAUL

OJALA RICHARD ERNEST 71 DULTH 879-8919  
326 19 CLOQUET

OJANPERA CAROL MARIB 69 DULTH  
7801 E 6TH ST INVER GROVE

DJARD DONALD WILLIAM 722 N 18TH AVE E DJARD STEVEN HOWARD BX 34 KNIFE RIVER DJHA RASH BEHARI 1084 15TH AVE SE OJILE FREDERICK JOHN 2722 BUCHANAN ST NE OJILE TIMOTHY PAUL 2722 BUCHANAN ST NE OKADA TONI DENISE 605 OAK ST SE OKAN GLENN CHRIST JR	68 DULTH 724-8474 DULUTH 68 DULTH 536-2233 KNIFE RIVER GRAD MPL JAMSHEDPUE 70 LAW 789-6778 MPL MINNEAPOLIS 70 CLA 789-6778 MPL MINNEAPOLIS 68 MEDTC 331-4639 MPL MINNEAPOLIS 70 IT	OLEARY JOHN PATRICK GRAD OLEARY KEVIN GEAN 71 CLA MPL REDWOOD FALLS 70 CLA 331-7516 MPL WHITE BEAR LAKE 68 BUS 331-7929 MPL VIRGINIA 68 GC 920-3342 SLP KIMBALL 69 IT 935-7587 MTV MINNETONKA GRAD OLEARY THEODORE HOLMES 71 CLA 935-7587 HOP HOPKINS GRAD MPL DICKSON CITY PA 70 IT 784-3739 NWB 69 GC 739-9657 STP ST PAUL 69 DULTH 724-8646 ASKOV 71 CLA 896-4491 MPL HUTCHINSON 68 AGFHE 488-1043 STP BROOKSTON 69 CLA MPL NORTHFIELD 71 CLA 645-4787 MPL NORTHFIELD 68 IT 484-5789 SHV SHOREVIEW 71 CLA 823-8429 MPL MINNEAPOLIS 70 IT 373-6444 MPL HIBBING 68 ED 484-5784 ROY ROSEVILLE GRAD 69 GC 825-9638 MPL MINNEAPOLIS 70 CLA MPL ST CLOUD 70 CLA MPL MINNEAPOLIS 71 CLA 777-6798 NSP NORTH ST PAUL GRAD 331-2125 MPL NORTH ST PAUL 70 CLA 926-3146 MPL MINNEAPOLIS 70 AGFHE 333-2161 MPL ANOKA 69 CLA 338-2448 MPL WHITE BEAR LAKE GRAD 646-8558 STP GRAD 69 DENNY 333-7285 MPL MOORHEAD 70 CLA 529-0000 MPL MINNEAPOLIS 68 IT WE5-1223 EDN EDINA 70 CLA 429-9194 WTB WHITE BEAR LAKE AS GC 935-6698 HOP HOPKINS 71 IT 784-7348 SKP SPRING LAKE PK 69 DULTH 724-9802 WADENA 69 CLA MPL VIRGINIA 70 MED 331-1744 MPL ZIM 68 CLA 331-5348 MPL JAMESVILLE GRAD 646-3695 STP MINNEAPOLIS 71 AGFHE 633-9657 NWB NEW BRIGHTON 70 DULTH 727-2626 DULUTH 71 IT 68 GC 373-6842 MPL FREEPORT 71 DULTH 724-9852 MINNETONKA GRAD 69 PT 331-2121 MPL PETERSON 70 AGFHE 71 CLA MPL ROCHESTER 68 CLA 789-6618 MPL MINNEAPOLIS 68 LAW 721-7659 MPL ROCHESTER GRAD 71 CLA 776-7773 STP ST PAUL	OLSEN BARBARA DARE 68 CLA 331-5019 708 UNIVERSITY AVE SE MPL OLSEN BERNARD MARTIN GRAD 339-7421 CENTENNIAL HALL MPL STATEN ISL NY OLSEN BEVERLY ANN 70 CLA 644-1395 32 N MISSISSIPPI RIV BL STP ST PAUL OLSEN BONNIE LBE 69 GC 866-6589 6408 THOMAS SO RHF RICHFIELD OLSEN BRUCE MICHAEL 70 CLA OLSEN BRUCE PAUL 70 CLA 331-1768 1219 UNIVERSITY AVE SE MPL ALBERT LEA OLSEN CAROL MARIE 69 MORRS CAMDEN HALL WESTBROOK OLSEN CHRISTINE ANN 70 DULTH 724-9869 GRIGGS HALL M311 ETTE MI OLSEN CLAIRE LOUISE 68 CLA 537-8570 3801 VERA CRUZ AVE N ROB ROBBINSDALE OLSEN DALE ROGER 69 IT 338-0224 1914 22ND ST E MPL AITKIN OLSEN DAVID ERIC 68 ED 729-6083 4124 26TH AVE SO MPL MINNEAPOLIS OLSEN DAVID KURT GRAD 1270 TAYLOR AVE STP ST PAUL OLSEN DEBORA JEAN 71 CLA 771-4532 486 E ARLINGTON STP ST PAUL OLSEN DIANE KAY 71 CLA 729-6083 4124 26TH AVE SO MPL MINNEAPOLIS OLSEN DIANE LYNN 70 CLA 441 E COMSTOCK MPL COON RAPIDS OLSEN DONNA MARIE 69 GC 926-7014 5237 CHOWEN AVE SO MPL MINNEAPOLIS OLSEN DUANE ROBERT 71 IT OLSEN EDWARD LLOYD 70 CLA 331-6862 716 5TH AVE SE MPL OLSEN GAIL CHERIE 71 CLA 544-2350 8250 23RD AVE NO GDV GOLDEN VALLEY OLSEN GARY DALE 70 DULTH TOFTE OLSEN GERALD DENNIS 71 CLA FRONTIER HALL MPL AITKIN OLSEN GLEN JOHN 71 CLA 922-5953 5649 PENN SO MPL MINNEAPOLIS OLSEN GREGORY PAUL 71 CLA 757-1839 9930 PALM ST NW CNR COON RAPIDS OLSEN IRVING WALTER 70 CLA 722-8886 3340 40TH AVE SO MPL MINNEAPOLIS GRAD OLSEN JAMES HARRY OLSEN JANET GEORGIA 71 MORRS GAY HALL DONNELLY OLSEN JANET MARIE 68 CLA OLSEN JANICE MARGARET GRAD 537-8570 3801 VERA CRUZ AVE NO ROB ROBBINSDALE OLSEN JEANNE CAROLYN 68 MEDTC 824-6724 MPL MINNEAPOLIS OLSEN JILLIANE KAY 70 CLA 776-7773 1287 BIRMINGHAM ST STP ST PAUL OLSEN KAREN ANN GRAD 722-2776 1527 E 39TH ST MPL RHINELANDER HI OLSEN KAREN BETH 71 CLA 373-6115 642 PIONEER COURT MPL HAMEL OLSEN KAREN JOY 70 AGFHE 822-6031 5828 NICOLLET AVE MPL FAIRVIEW SD OLSEN KATHERINE MARIE 69 ED OLSEN KENNETH DOUGLAS 68 GC OLSEN MARGARET ANNE 70 LAW 645-9241 BAILEY HALL STP CHICAGO IL OLSEN MARYANN PARKER 70 CLA 927-9380 6328 BARRIE RD MPL MINNEAPOLIS OLSEN NANCY JO 69 ED GRAND RAPIDS OLSEN PAMELA JOANNE 70 CLA 789-2379 2938 BENJAMIN MPL MINNEAPOLIS OLSEN RANDALL WILLARD 68 CLA OLSEN RICHARD DALE 71 MED 331-1608 640 ONTARIO ST SE MPL MONTEVIDEO OLSEN RICHARD WALLACE GRAD OLSEN ROBERT ALLEN 69 IT 332-1790 305 940 FRANKLIN TERR E STP EXCLBSIOR OLSEN ROBERT MARTIN 71 DULTH 2409 JEFFERSON ST DULUTH OLSEN ROGER JOHN 71 IT 473-1892 BOX 24 LOL ST LOUIS PARK OLSEN SCOTT ANTHONY 71 CLA ELK RIVER OLSEN SHARON LYNN 69 NURS 166 POWELL HALL MPL WILLMAR OLSEN STEPHEN BRADLEY 71 CLA 588-8593 4533 BEARD AVE NO ROB ROBBINSDALE OLSEN STEPHEN CHARLES 71 MORRS 589-3121 BLAKELY HALL MONTEVIDEO OLSEN THOMAS TERRI 71 DULTH 4019 TRINITY RD DULUTH OLSEN WILLIAM GEORGE 71 DULTH 727-5390 4005 HAINES RD DULUTH OLSGARD EDWARD CHARLES 68 CLA FR6-7191 2000 SEABURY AVE SO MPL MINNEAPOLIS OLSGARD ROBERT CLARENC 70 CLA 336-7191 2000 SEABURY MPL MINNEAPOLIS OLSON A JOHN 69 IT OLSON ALAN DUANE 69 VET M 484-2425 ROY MINNEAPOLIS
--	--	---	---



OLSON ALAN FRANKLIN 68 IT 331-6328 OLSON CYNTHIA JOANNE 71 CLA 789-2854 OLSON EUGENE EDWARD GRAD  
 812 7TH ST SE ST ANTHONY  
 OLSON ALAN FREDERICK 70 CLA 560-5783 OLSON CYNTHIA LEE 71 CLA 698-1981 OLSON EUGENE ERIC 68 MORRS  
 530 CHERI CIRCLE FRD FRIDLEY STP WILLMAR BOX 57 CYRUS  
 OLSON ALAN HARVEY AS CLA OLSON DALE PATRICK 70 CLA 331-3152 OLSON FRANCES AVONNB GRAD 333-8047  
 OLSON ALAN KEITH 71 CLA 489-5867 OLSON MIRACLE LANE 70 CLA 331-3152 OLSON FRANK BERNARD MPL GRAND MOUND IA  
 921 W ARLINGTON STP ST PAUL 70 IT 866-6108 OLSON GALE BERG C 70 DULTH 624-3556  
 OLSON ALAN PAUL RHF RICHFIELD 71 DULTH 729-8591 OLSON TOWER AVE 68 DULTH 394-4526  
 6327 18TH AVE SO OLSON DANELLE MARIE 69 DULTH 728-4296 OLSON GARON EUGENE 70 CLA 522-2832  
 OLSON ALETHA LUELLA 4689 HERMANTOWN RD OLSON DANIEL CLIFFORD BAILEY HALL 3226 COLFAX AVE NO MPL MINNEAPOLIS  
 OLSON ALLAN DUDLEY 69 DENT 561-6389 OLSON DANIEL NORMAN 71 CLA 724-9159  
 7112 RIVERDALE RD NO BRC BROOKLYN CENTER OLSON DARRREL WAYNE 3208 33RD AVE SO MPL MINNEAPOLIS  
 OLSON ANDREA LOUISE 68 CLA 331-7008 OLSON DAVID BRUCE 69 IT 373-6203 OLSON GARY MICHAEL 69 IT  
 713 15TH AVE SE MPL MASON CITY IA OLSON DARRREL WAYNE 69 CLA 331-1507 OLSON GARY PAUL 68 GC  
 OLSON ANDREW KENT 70 MORRS OLSON DAVID BRUCE 68 GC 777-3963 OLSON GARY STEVEN 69 AGFHE 869-3446  
 300 W 8TH CLINTON OLSON DARRREL LEE 68 GC 777-3963 OLSON GARY WALLACE 69 GC  
 OLSON ANTHONY PAUL 69 DULTH 834-4321 OLSON DARRREL LEE 68 GC 935-4307 OLSON GARY WALLACE 69 GC  
 622 11TH AVE TWO HARBORS OLSON DARRREL LEE 68 GC 935-4307 OLSON HARRIET AVE SO RHF RICHFIELD  
 OLSON ARCHIE HAGEN TERRITORIAL HALL OLSON DAVID BRUCE 71 CLA 869-0356 OLSON GARY WYMAN 69 IT 881-6307  
 OLSON ARDIS LEE 69 BIOSC 331-5270 OLSON DAVID BRUCE 68 GC 935-4307 OLSON GARY WYMAN 69 IT 881-6307  
 1015 ESSEX ST SE A 316 MPL DETROIT LAKES OLSON DAVID BRUCE 68 GC 935-4307 OLSON GARY WYMAN 69 IT 881-6307  
 OLSON ARDYCE LAVONNE 70 CLA 459-4810 OLSON DAVID EDWIN OLSON GENE CRAIG 8735 PORTLAND AVE SO BLT BLOOMINGTON  
 6217 HILLSIDE LANE SLP ST LOUIS PARK OLSON DAVID EDWIN 71 MED 331-1839 OLSON GENE CRAIG 70 CLA 537-1469  
 OLSON ARLAINE ALBERTA 69 ED 432-7098 OLSON DAVID EILER OLSON GENE CRAIG 71 IT 771-4775  
 121 WALNUT CIRCLE ROS ROSEMOUNT OLSON DAVID EILER 71 CLA 1541 ATLANTIC OLSON GENE HENRY 71 IT 771-4775  
 OLSON ARLEN BENNETT AS ED OLSON DAVID GRANT OLSON GENE HENRY 71 IT 771-4775  
 500 DELAWARE ST SE OLSON DAVID GRANT 71 MED 331-1052 OLSON GENE RUSSELL 71 AGFHE 71 AGFHE  
 OLSON ARLENE HARRIET 69 AGFHE 646-5103 OLSON DAVID HAROLD 71 IT 424-9640 OLSON BAILEY HALL STP LAKE CITY  
 1403 CLEVELAND N STP ALEXANDRIA 69 IT 424-9640 OLSON BAILEY HALL STP LAKE CITY 69 IT  
 OLSON ARNOLD EVERETT GRAD OLSON DAVID HAROLD 71 IT 424-9640 OLSON BAILEY HALL STP LAKE CITY 69 IT  
 OLSON AUDREY JEAN 71 MORRS 589-4693 OLSON DAVID HAROLD 71 IT 424-9640 OLSON BAILEY HALL STP LAKE CITY 69 IT  
 SPOONER HALL RAYMOND OLSON DAVID JOHN 71 IT 424-9640 OLSON BAILEY HALL STP LAKE CITY 69 IT  
 OLSON BARBARA ANN 69 NURS 929-6648 OLSON DAVID JOHN 68 GC 824-1852 OLSON BAILEY HALL STP LAKE CITY 69 IT  
 5210 GRANDVIEW LANE EDN EDINA OLSON DAVID JOHN 68 GC 824-1852 OLSON BAILEY HALL STP LAKE CITY 69 IT  
 OLSON BARBARA BLOODGETT 68 ED 338-8023 OLSON DAVID JOHN 68 GC 824-1852 OLSON BAILEY HALL STP LAKE CITY 69 IT  
 718 4TH ST SE MPL MINNEAPOLIS OLSON DAVID JOHN 68 GC 824-1852 OLSON BAILEY HALL STP LAKE CITY 69 IT  
 OLSON BARBARA LYNN 71 MORRS OLSON DAVID JOHN 68 GC 824-1852 OLSON BAILEY HALL STP LAKE CITY 69 IT  
 GAY HALL PEQUOT LAKES OLSON DAVID JOHN 68 GC 824-1852 OLSON BAILEY HALL STP LAKE CITY 69 IT  
 OLSON BEVERLY ANN 70 DULTH 628-1869 OLSON DAVID JOHN 68 GC 824-1852 OLSON BAILEY HALL STP LAKE CITY 69 IT  
 KK19 W 8TH ST DULUTH OLSON DAVID JOHN 68 GC 824-1852 OLSON BAILEY HALL STP LAKE CITY 69 IT  
 OLSON BEVERLY JEAN 71 CLA 722-1818 OLSON DAVID JOHN 68 GC 824-1852 OLSON BAILEY HALL STP LAKE CITY 69 IT  
 2220 27TH AVE SO MPL MINNEAPOLIS OLSON DAVID JOHN 68 GC 824-1852 OLSON BAILEY HALL STP LAKE CITY 69 IT  
 OLSON BEVERLY KAY 68 GC 338-5434 OLSON DAVID JOHN 68 GC 824-1852 OLSON BAILEY HALL STP LAKE CITY 69 IT  
 309 8TH ST SE MPL AITKIN OLSON DAVID JOHN 68 GC 824-1852 OLSON BAILEY HALL STP LAKE CITY 69 IT  
 OLSON BRADLEY KENT 68 CLA 869-9108 OLSON DAVID JOHN 68 GC 824-1852 OLSON BAILEY HALL STP LAKE CITY 69 IT  
 7127 LOGAN RHF RICHFIELD OLSON DAVID JOHN 68 GC 824-1852 OLSON BAILEY HALL STP LAKE CITY 69 IT  
 OLSON BRENT EDWARD 71 DULTH 724-5927 OLSON DAVID JOHN 68 GC 824-1852 OLSON BAILEY HALL STP LAKE CITY 69 IT  
 133 E BUFFALO ST DULUTH OLSON DAVID JOHN 68 GC 824-1852 OLSON BAILEY HALL STP LAKE CITY 69 IT  
 OLSON BRIAN THOMAS 69 CLA 333-1918 OLSON DAVID JOHN 68 GC 824-1852 OLSON BAILEY HALL STP LAKE CITY 69 IT  
 14 E FRANKLIN MPL NEW LONDON OLSON DAVID JOHN 68 GC 824-1852 OLSON BAILEY HALL STP LAKE CITY 69 IT  
 OLSON BRUCE DAVID 69 CLA OLSON DAVID JOHN 68 GC 824-1852 OLSON BAILEY HALL STP LAKE CITY 69 IT  
 1 GATEWAY CENTER BOX 213 MPL MOUND OLSON DAVID JOHN 68 GC 824-1852 OLSON BAILEY HALL STP LAKE CITY 69 IT  
 OLSON BRUCE RAYMOND 68 DULTH 834-2535 OLSON DAVID JOHN 68 GC 824-1852 OLSON BAILEY HALL STP LAKE CITY 69 IT  
 831 9TH AVE TWO HARBORS OLSON DAVID JOHN 68 GC 824-1852 OLSON BAILEY HALL STP LAKE CITY 69 IT  
 OLSON BRUCE WILLIAM 68 CLA OLSON DAVID JOHN 68 GC 824-1852 OLSON BAILEY HALL STP LAKE CITY 69 IT  
 815 13TH AVE SE MPL ROCKFORD IL OLSON DAVID JOHN 68 GC 824-1852 OLSON BAILEY HALL STP LAKE CITY 69 IT  
 OLSON BURTON KARL 71 CLA 721-1492 OLSON DAVID JOHN 68 GC 824-1852 OLSON BAILEY HALL STP LAKE CITY 69 IT  
 3153 23 AVE SO MPL MINNEAPOLIS OLSON DAVID JOHN 68 GC 824-1852 OLSON BAILEY HALL STP LAKE CITY 69 IT  
 OLSON CAMILLA RUTH 70 DULTH 724-2922 OLSON DAVID JOHN 68 GC 824-1852 OLSON BAILEY HALL STP LAKE CITY 69 IT  
 31 W KENT ROAD DULUTH OLSON DAVID JOHN 68 GC 824-1852 OLSON BAILEY HALL STP LAKE CITY 69 IT  
 OLSON CANDACE JEAN 69 DULTH 624-1423 OLSON DAVID JOHN 68 GC 824-1852 OLSON BAILEY HALL STP LAKE CITY 69 IT  
 4118 W 6TH ST DULUTH OLSON DAVID JOHN 68 GC 824-1852 OLSON BAILEY HALL STP LAKE CITY 69 IT  
 OLSON CANDICE JOY 71 DULTH OLSON DAVID JOHN 68 GC 824-1852 OLSON BAILEY HALL STP LAKE CITY 69 IT  
 GRIGGS HALL N214 MINNEAPOLIS OLSON DAVID JOHN 68 GC 824-1852 OLSON BAILEY HALL STP LAKE CITY 69 IT  
 OLSON CARL ANDREW 70 AGFHE 488-9481 OLSON DAVID JOHN 68 GC 824-1852 OLSON BAILEY HALL STP LAKE CITY 69 IT  
 1345 FARRINGTON ST STP WILLIAMS OLSON DAVID JOHN 68 GC 824-1852 OLSON BAILEY HALL STP LAKE CITY 69 IT  
 OLSON CARL EDWARD JR 69 GC 644-2875 OLSON DAVID JOHN 68 GC 824-1852 OLSON BAILEY HALL STP LAKE CITY 69 IT  
 1729 W MINNEHAMA AVE STP ST PAUL OLSON DAVID JOHN 68 GC 824-1852 OLSON BAILEY HALL STP LAKE CITY 69 IT  
 OLSON CARLA LOUISE 71 AGFHE OLSON DAVID JOHN 68 GC 824-1852 OLSON BAILEY HALL STP LAKE CITY 69 IT  
 BAILEY HALL STP ZIMMERMAN OLSON DAVID JOHN 68 GC 824-1852 OLSON BAILEY HALL STP LAKE CITY 69 IT  
 OLSON CARLEEN RAE 68 ED 724-6102 OLSON DAVID JOHN 68 GC 824-1852 OLSON BAILEY HALL STP LAKE CITY 69 IT  
 5617 32ND AVE SO MPL MINNEAPOLIS OLSON DAVID JOHN 68 GC 824-1852 OLSON BAILEY HALL STP LAKE CITY 69 IT  
 OLSON CARMEN LOUISE LA GRAD 336-3908 OLSON DAVID JOHN 68 GC 824-1852 OLSON BAILEY HALL STP LAKE CITY 69 IT  
 73 BEDFORD ST SE MPL OLSON DAVID JOHN 68 GC 824-1852 OLSON BAILEY HALL STP LAKE CITY 69 IT  
 OLSON CAROL ANNE 70 CLA 972-4810 OLSON DAVID JOHN 68 GC 824-1852 OLSON BAILEY HALL STP LAKE CITY 69 IT  
 RT 1 BOX 335 MND MOUND OLSON DAVID JOHN 68 GC 824-1852 OLSON BAILEY HALL STP LAKE CITY 69 IT  
 OLSON CAROL ELIZABETH GRAD OLSON DAVID JOHN 68 GC 824-1852 OLSON BAILEY HALL STP LAKE CITY 69 IT  
 2115 E RIVER TERRACE MPL OLSON DAVID JOHN 68 GC 824-1852 OLSON BAILEY HALL STP LAKE CITY 69 IT  
 OLSON CAROL LUCILLE 70 DULTH OLSON DAVID JOHN 68 GC 824-1852 OLSON BAILEY HALL STP LAKE CITY 69 IT  
 GRIGGS HALL N214 CARLTON OLSON DAVID JOHN 68 GC 824-1852 OLSON BAILEY HALL STP LAKE CITY 69 IT  
 OLSON CAROL LYNN 68 DULTH 525-1100 OLSON DAVID JOHN 68 GC 824-1852 OLSON BAILEY HALL STP LAKE CITY 69 IT  
 5001 PEABODY ST DULUTH OLSON DAVID JOHN 68 GC 824-1852 OLSON BAILEY HALL STP LAKE CITY 69 IT  
 OLSON CATHERINE LYNN 69 CLA 333-0389 OLSON DAVID JOHN 68 GC 824-1852 OLSON BAILEY HALL STP LAKE CITY 69 IT  
 329 10TH AVE SE MPL MARSHALL OLSON DAVID JOHN 68 GC 824-1852 OLSON BAILEY HALL STP LAKE CITY 69 IT  
 OLSON CHARLES DENNIS 69 IT OLSON DAVID JOHN 68 GC 824-1852 OLSON BAILEY HALL STP LAKE CITY 69 IT  
 OLSON CHARLES LOUIS 70 DULTH OLSON DAVID JOHN 68 GC 824-1852 OLSON BAILEY HALL STP LAKE CITY 69 IT  
 2232 E 1ST ST INTERNAT FALLS OLSON DAVID JOHN 68 GC 824-1852 OLSON BAILEY HALL STP LAKE CITY 69 IT  
 OLSON CHARLES RUSSELL 71 DULTH 624-4169 OLSON DAVID JOHN 68 GC 824-1852 OLSON BAILEY HALL STP LAKE CITY 69 IT  
 917 N CENTRAL AVE DULUTH OLSON DAVID JOHN 68 GC 824-1852 OLSON BAILEY HALL STP LAKE CITY 69 IT  
 OLSON CHARLOTTE MARY 71 CLA OLSON DAVID JOHN 68 GC 824-1852 OLSON BAILEY HALL STP LAKE CITY 69 IT  
 SANFORD HALL MPL STILLWATER OLSON DAVID JOHN 68 GC 824-1852 OLSON BAILEY HALL STP LAKE CITY 69 IT  
 OLSON CHERYL ANN 68 ED 631-0624 OLSON DAVID JOHN 68 GC 824-1852 OLSON BAILEY HALL STP LAKE CITY 69 IT  
 1441 W ELDRIDGE ROV ROSEVILLE OLSON DAVID JOHN 68 GC 824-1852 OLSON BAILEY HALL STP LAKE CITY 69 IT  
 OLSON CHRISTINE MARTHA 71 CLA 643-6206 OLSON DAVID JOHN 68 GC 824-1852 OLSON BAILEY HALL STP LAKE CITY 69 IT  
 1687 W LARPENTEUR FLH FALCON HEIGHTS OLSON DAVID JOHN 68 GC 824-1852 OLSON BAILEY HALL STP LAKE CITY 69 IT  
 OLSON CLAUDIA JEAN 71 DULTH 628-1869 OLSON DAVID JOHN 68 GC 824-1852 OLSON BAILEY HALL STP LAKE CITY 69 IT  
 5529 W 8TH ST DULUTH OLSON DAVID JOHN 68 GC 824-1852 OLSON BAILEY HALL STP LAKE CITY 69 IT  
 OLSON CLIFFORD LARRY 68 IT 338-8023 OLSON DAVID JOHN 68 GC 824-1852 OLSON BAILEY HALL STP LAKE CITY 69 IT  
 718 4TH ST SE MPL ST PAUL OLSON DAVID JOHN 68 GC 824-1852 OLSON BAILEY HALL STP LAKE CITY 69 IT  
 OLSON CONNIE SUE 69 PT 643-5066 OLSON DAVID JOHN 68 GC 824-1852 OLSON BAILEY HALL STP LAKE CITY 69 IT  
 DENNISON OLSON DAVID JOHN 68 GC 824-1852 OLSON BAILEY HALL STP LAKE CITY 69 IT  
 OLSON CURTIS EDWARD 69 CLA 377-4989 OLSON DAVID JOHN 68 GC 824-1852 OLSON BAILEY HALL STP LAKE CITY 69 IT  
 4450 TYRDL CREST GDV GOLDEN VALLEY OLSON DAVID JOHN 68 GC 824-1852 OLSON BAILEY HALL STP LAKE CITY 69 IT  
 OLSON CYNTHIA 71 CLA 455-9579 OLSON DAVID JOHN 68 GC 824-1852 OLSON BAILEY HALL STP LAKE CITY 69 IT  
 205 OAKVIEW RD WSP WEST ST PAUL OLSON DAVID JOHN 68 GC 824-1852 OLSON BAILEY HALL STP LAKE CITY 69 IT

OLSON JOHN OTTO 407 7TH ST SE OLSON JOHN RAYMOND 1820 PARK OLSON JOHN RICHARD 208 5TH AVE NE OLSON JOHN TIMOTHY 1780 N SMELLING OLSON JUDITH ANN BURNTSIDE HALL 151 OLSON JUDITH JACOBSON 738 FOREST DALE RD OLSON JULIANN LOUISE POWELL HALL OLSON KAREN ANNE 31 W KENT RD OLSON KAREN GENEVIEVE 1308 E 24TH ST OLSON KAREN KAY 407 7TH ST SE OLSON KATHERINE LOUISE 315 10TH AVE NE OLSON KATHLEEN ANN 324 13TH AVE SE OLSON KATHLEEN ANN 902 FRANKLIN TERR OLSON KATHLEEN ANN 6729 PILLSBURY OLSON KATHLEEN JANE 1631 CARL ST APT 4 OLSON KATHLEEN MARIE 4828 HARRIET AVE SO OLSON KATHLEEN MARY 555 CHAPMAN AVE OLSON KATHRYN JO GRIGGS HALL 1114 OLSON KATHRYN WELLINGT 407 7TH ST SE OLSON KATHY RUTH 4401 32ND AVE SO OLSON KENNETH ALFRED 2111 21ST AVE SO OLSON KENNETH MELROY 1393 NO CLEVELAND AVE OLSON KENNETH MICHAEL RT 1 OLSON KERRY BRUCE 1126 5TH ST SE OLSON LARRY BERTIL 2417 SO FREMONT OLSON LARRY EUGENE	GRAD 339-6441 MPL WINNIPEG 70 CLA MPL MINNEAPOLIS 71 CLA 425-3345 OSO OSSED 68 CLA 644-7374 FLH FALCON HEIGHTS 71 DULTH 724-9814 ST LOUIS PARK 71 CLA 633-6188 NMB NEW BRIGHTON 69 NURS MPL OSTRANDER 68 DULTH DULUTH 68 ED 721-7656 MPL BLOOMINGTON 69 CLA MPL LAKE LILLIAN 70 CLA 374-2593 MPL MINNEAPOLIS 70 CLA MPL CAMBRIDGE 69 AGFHE 338-1642 MPL MINNEAPOLIS 68 GC 869-0260 RHF RICHFIELD 68 ED 645-1327 STP ST PAUL 69 GC 823-1422 MPL MINNEAPOLIS 71 CLA 739-0066 STP ST PAUL 70 DULTH 724-9818 EFFIE GRAD 339-6441 MPL DULUTH 71 CLA 722-5922 MPL COKATO GRAD 338-5756 MPL WHALAN 69 AGFHE 644-1289 STP ZUMBROTA 71 MORRS 795-2752 MORRIS 69 LAW 331-1575 MPL WILLMAR 70 CLA 377-7416 MPL MINNEAPOLIS 69 AGFHE 71 DULTH 834-6072 TWO HARBORS 68 ED MPL 68 AGFHE 784-0017 NMB MARBLE GRAD 646-5585 STP CANNON FALLS 68 GC 729-8290 MPL MINNEAPOLIS 71 CLA 644-4038 STP 69 PHARM 561-4289 BRP DULUTH 68 BUS 560-7419 SUPERIOR WI 70 DULTH ST PAUL 68 ED 331-3409 MPL FERGUS FALLS 69 CLA 721-1013 MPL 70 CLA 771-2196 STP ST PAUL 69 IT 331-7931 MPL INTERNAT FALLS 71 CLA 866-4852 RHF RICHFIELD 69 GC 866-2355 MPL MINNEAPOLIS 71 CLA 225-7606 MSP WEST ST PAUL 71 CLA STP ST PAUL 71 CLA 377-7016 MPL MINNEAPOLIS 68 CLA 331-3495 MPL FARIBAULT 70 CLA WAY WAYZATA 70 MORRS CYRUS 69 DENNY 774-3521 STP ST PAUL AS ED	OLSON LYNNEA ANN 205 6TH ST NW OLSON MAGNE BERNARD OLSON MANLEY ELMER OLSON MARCIA BARBARA 1210 RHODE ISLAND OLSON MARCIA HUMPHREY OLSON MARCIA KAY 715 UNIVERSITY SE OLSON MARGARET ANN 309 8TH ST SE OLSON MARGARET GWENDOL 722 RAMSEY NO OLSON MARILYN MABEL 902 FRANKLIN TER OLSON MARK ALAN 3415 N WASHINGTON AVE OLSON MARK EMMANUEL 1128 88TH AVE W OLSON MARK LYNN 3310 CENTENNIAL HALL OLSON MARVIN GERON 2130 MILLER TRUNK HSY OLSON MARY ALICE CAMDEN HALL OLSON MARY FOSTER EVEL 2721 GOLDEN VALLEY RD OLSON MARY KATHLEEN 1934 ALDRICH AVE SO OLSON MAUREEN KAY 4006 E 36TH ST OLSON MERVYN LEROY 5617 32ND AVE SO OLSON MICHAEL EUGENE 6 333 TERRITORIAL HALL OLSON MICHAEL JAMES UNIVERSITY AVE SE OLSON MICHAEL RICHARD OLSON MURIEL MURPHY 441 SO CRETIN AVE OLSON NANCY ANN 4006 36TH ST E OLSON NANCY ANNE 3849 CEDAR AVE SO OLSON NANCY ELIZABETH 1720 ROLLINS AV SE OLSON NANCY JEANNE 6015 GARDENA CIRCLE OLSON NEIL HENRY 1312 E 28TH ST OLSON NORMAN JAMES 3153 DUVAL OLSON PAMELA EILEEN OLSON PATRICIA ANN 5319 45TH AVE N OLSON PATRICIA HELEN 1047 13TH AVE SE OLSON PATRICIA LOUISE 1545 BARCLAY ST OLSON PATRICIA LYNN SPOONER HALL OLSON PATRICIA MARY STANLEY RD PO BX 66 OLSON PATRICIA MARY 229 3RD AVE SE OLSON PATRICK STEVEN RT 1 BOX 394 OLSON PAUL ALLEN 2024 COMMONWEALTH AVE OLSON PAUL DOUGLAS 1642 EUSTIS OLSON PAUL ELMER OLSON PAUL RICHARD PINE HALL OLSON PEDER JAMES 7401 PORTLAND AVE SO OLSON PETER ALLAN 615 E VIKING DRIVE OLSON PETER CARLTON 5921 11TH AVE SO OLSON PETER RALPH 520 WASHINGTON AVE SE OLSON PHYLLIS ANN 3332 32ND AVE SO OLSON RAYMOND CHASE 7112 RIVERDALE RD OLSON RENAE LOUISE 8401 E RIVER ROAD OLSON RICHARD ALAN 7609 PORTLAND AVE SO OLSON RICHARD ALFRED OLSON RICHARD BRYAN CENTENNIAL HALL OLSON RICHARD CARL 1398 BLAIR AVE OLSON RICHARD DAVID OLSON RICHARD DUANE 3214 FRANCE NO OLSON RICHARD DWIGHT 722 7TH ST SE OLSON RICHARD GAYLORD 1013 E 2ND ST	70 CLA 633-1181 NMB NEW BRIGHTON GRAD 70 CLA 545-6632 GDV GOLDEN VALLEY GRAD 70 CLA MPL MILAN 70 CLA 338-5434 MPL AITKIN 68 GC 693-8048 LITCHFIELD 69 GC 338-1642 MPL MINNEAPOLIS 70 MED 529-0138 MPL MINNEAPOLIS 70 DULTH 626-1157 DULUTH 69 IT 339-7421 MPL RED WING 68 DULTH 722-2189 DULUTH 71 MORRS 589-1030 STARBUCK 68 CLA 522-8988 MPL ROBBINSDALE 71 CLA MPL OSAKIS 70 ED 722-7139 MPL MINNEAPOLIS 68 CLA 644-6102 MPL MINNEAPOLIS 71 IT 373-6519 MPL LITCHFIELD 70 CLA MPL HALLOCK 68 GC GRAD 699-2408 STP 71 CLA 722-7139 MPL MINNEAPOLIS 70 CLA 729-2511 MPL MINNEAPOLIS 71 CLA 331-1080 MPL MINNEAPOLIS 70 CLA 788-7323 FRD FRIELEY 69 CLA 721-3054 MPL MINNEAPOLIS 70 CLA 739-7572 STP ST PAUL 70 AGFHE 70 CLA 537-1406 ROB ROBBINSDALE 71 CLA 331-6384 MPL BRAHAM 70 CLA 774-3780 STP ST PAUL 71 MORRS ZIMMERMAN 69 DULTH 834-3071 STRATHCONA 70 CLA 338-1729 MPL MINNEAPOLIS 71 DULTH 384-4412 CARLTON GRAD 645-8385 STP BECKER 70 IT STP GARFIELD 71 AGFHE 71 MORRS 589-3203 71 AGFHE 866-7434 RHF RICHFIELD 69 VET M 484-2834 STP ST PAUL 71 IT 866-1013 MPL MINNEAPOLIS 69 MED 331-8997 MPL DULUTH 68 ED 644-5527 MPL MINNEAPOLIS 70 CLA 561-6389 BRC BROOKLYN CENTER 70 AGFHE 784-6935 CNR COOM RAPIDS 71 IT 866-3708 RHF RICHFIELD GRAD 69 IT MPL MORA 69 GC 646-1697 STP ST PAUL GRAD 71 CLA 588-5497 ROB ROBBINSDALE 68 IT 331-7662 MPL BENSON 68 DULTH 728-2736 ST LOUIS PARK	OLSON RICHARD GLENN 2721 GOLDED VALLEY RD OLSON RICHARD HELMER 3716 18TH AVE SO OLSON RICHARD JAMES OLSON RICHARD JOHN 311 WALNUT ST SE OLSON RICHARD MICHAEL CENTENNIAL HALL OLSON RICHARD TOWLEY OLSON ROBERT ALLEN RT 4 OLSON ROBERT CARL MART 4752 16TH AVE SO OLSON ROBERT EDWARD OLSON ROBERT JAMES 309 6TH ST SE OLSON ROBERT LEE 1830 DUNEDIN OLSON ROBERT LEE BREWSTER HALL OLSON ROBERT MICHAEL 3009 SILVER LAKE RD OLSON ROBERT WAYNE 2620 PILLSBURY AVE SO OLSON ROBERT WILLIAM 94211 46TH AVE SO OLSON ROGER CHARLES R 2 OLSON ROGER HARRY 3414 GRAND AVE SO OLSON ROGER THEODORE PIONEER HALL OLSON ROGER WESLEY OLSON ROLAND OLIVER OLSON ROLF THOMAS A 3453 16TH AVE SO OLSON RONALD ALLEN 8236 14TH AVE S OLSON RONALD JAMES TORRANCE HALL 248 OLSON SANDRA ANN 3920 28TH AVE SO OLSON SANDRA SUSAN 4617 14TH AVE SO OLSON SHARON LEE 2517 7TH ST SO OLSON SHARON MARIE 914 E 2 ST OLSON SHEILA LEAF OLSON SHIRLEY GAIL KAR OLSON SHIRLEY MAE 603 N 60TH AVE W OLSON STANLEY WARREN 6420 VINCENT AVE SO OLSON STEPHEN CHRISTOP 534 E 5TH ST OLSON STEPHEN EDWARD 1755 HILLWOOD OLSON STEPHEN GLENN 4TH ST SE OLSON STEVE RICHARD 6333 CLINTON AVE SO OLSON STEVEN GORDON 6108 EWING AVE SO OLSON SUE ELLEN SANFORD HALL OLSON SUSAN CHARLOTTE 1051 12TH AVE SE OLSON SUSAN FAYE 2067 CARTER AVE OLSON SUSAN KAY 1805 EMERSON AVE SO OLSON SUSAN LAUREL LUC 4030 15TH AVE SO OLSON SUSAN LEB 3017 3RD AVE SO OLSON SUSAN LEE GAY HALL OLSON SUSAN LINDA 2405 HUMBOLDT AVE SO OLSON SUSAN RAE SPOONER HALL OLSON SUSAN WILLIAMS C 2930 MILLER TRUNK OLSON SUZANNE G PIONEER HALL OLSON SUZANNE MARIE 6633 COLUMBUS AVE OLSON TAMARA JEAN PIONEER COURT OLSON TERRY W 1415 C KINGSVIEW LN N OLSON THERESA JEANWB OLSON THOMAS ALLEN 5525 13TH AVE SO OLSON THOMAS ANTHONY 1310 E 4 ST OLSON THOMAS CARL OLSON THOMAS DOUGLAS TERRITORIAL HALL	69 IT 522-8988 MPL MINNEAPOLIS 70 MED 722-5930 MPL MINNEAPOLIS 68 DULTH EVELETH 70 CLA 331-2137 MPL ANOKA 69 IT 865-6426 MPL BINABIK GRAD 71 IT 436-7444 LSC SUPERIOR WI 68 MED MPL MINNEAPOLIS GRAD 68 DENT MPL LITCHFIELD GRAD 724-5817 HOYT LAKES 71 AGFHE 697-3712 STP BETHEL 69 CLA 781-4515 STA ST ANTHONY 68 GC 824-2063 MPL REVERE 68 CLA FEB-1642 MPL GRAD 425-2061 OSO 69 GC 827-4469 MPL GRAD MPL WHITE BEAR LAKE GRAD 69 BUS 71 DENT MPL MINNEAPOLIS 70 CLA 888-7803 BLT BLOOMINGTON 71 DULTH 724-9800 ROBBINSDALE 70 CLA 729-2252 MPL MINNEAPOLIS 68 ED 823-7470 MPL MINNEAPOLIS 70 CLA MPL PAYNESVILLE 71 DULTH 727-6636 TWO HARBORS GRAD 70 AGFHE 71 DULTH 628-1851 DULUTH 71 CLA 869-0353 RHF RICHFIELD 69 MORRS MINNEAPOLIS 69 IT 633-4519 ROV ROSEVILLE 70 CLA MPL MARSHALL 70 IT 866-9540 RHF RICHFIELD 69 GC 927-6742 EDN EDINA 69 GC MPL MOOSE LAKE 69 CLA 331-2798 MPL WEST CONCORD 69 AGFHE 646-3970 STP WORTHINGTON 70 CLA 377-8279 MPL MINNEAPOLIS AS CLA 823-6043 MPL MINNEAPOLIS AS CLA 822-1839 MPL INVER GROVE 71 MORRS MILAN 69 GC 377-6120 MPL MINNEAPOLIS 71 MORRS 589-4693 KILLIHER 69 DULTH 727-4897 DULUTH 71 CLA MPL ALBERT LEA 71 CLA 869-7965 RHF RICHFIELD 70 CLA MPL HENDRICKS 71 CLA 473-7290 WAY WAYZATA 71 CLA 373-7411 ALBERT LEA 68 GC 823-7431 MPL MINNEAPOLIS 70 DULTH E GRAND FORKS 70 AGFHE 71 CLA MPL ALEXANDRIA
---	---	---	--	---	--



ORNING KAREN LEE OLSON 70 CLA 645-2547  
1707 LINDIE ST NO FLH FALCON HEIGHTS  
ORNING LANNY CARLTON GRAD 560-2958  
623 51ST AVE NE CLH HAYFIELD  
ORNSTEIN DAVID RICHARD 70 LAW 929-1519  
2654 ALABAMA AVE SLP ST LOUIS PARK  
DROPIIIA QUINTIN FORTI GRAD

OROURKE ANN MARIE GRAD  
344 E FRANKLIN AVE MPL  
OROURKE ANNE MARY 70 CLA 822-6379  
425 UNIVERSITY AVE SE MPL MINNEAPOLIS  
OROURKE MICHAEL JAMES 70 LAW 331-1114  
1617 UNIVERSITY AVE SE MPL MINNEAPOLIS  
OROURKE PATRICK MICHAEL 71 CLA 533-3193  
4031 ORCHARD ROB ROBBINSDALE  
OROURKE PEGGY MARIE 69 DULTH 525-1446  
4929 GLENDALE ST DULUTH  
OROURKE ROBERT ALPHONS AS ED

OROURKE TIMOTHY MICHAEL 70 CLA 781-2599  
3346 PIERCE ST NE MPL MINNEAPOLIS  
OROURKE WILLIAM JAMES 70 CLA 789-0301  
3500 ROOSEVELT ST NE MPL MINNEAPOLIS  
OROZCO SR LUZ MARIA GRAD 373-7394  
COMSTOCK HALL MPL OTTUMWA IA  
ORR CAROL ALISON 68 CLA  
15 SEYMOUR SE MPL MINNEAPOLIS  
ORR ERNEST WATSON GRAD

ORR MICHAEL WILLIAM 69 CLA 690-1358  
1947 GRAND AVE STP ST PAUL  
ORR PETER ALLEN 70 AGFHE 488-0403  
1144 DIONNE ST ROV HOUSTON  
ORRED BURTON HOWARD 71 CLA  
232 W FRANKLIN AVE MPL NEW ZEALAND  
ORREN JEFFREY LEE 71 CLA 699-9523  
1703 BOHLAND STP ST PAUL  
ORRIE PEARL LADEEN MAR AS GC  
3112 GRAND AVE MPL  
ORROCK MARGARET F GRAD

ORSEN ALLAN WAYNE 69 IT MINNEOTA

ORSDON RONALD DEAN 70 IT 339-7421  
CENTENNIAL HALL MPL NEW LONDON  
ORSTAD ROGER RICHARD 70 CLA 533-3602  
4560 HALIFAX AVE NO ROB ROBBINSDALE  
ORTGIESEN CHERYL COLLE 70 CLA 784-1997  
6824 FAIRCHILD AVE MPL MINNEAPOLIS  
ORTH EARL JOSEPH JR GRAD

ORTH GERALD LEO 68 GC 698-8088  
2165 LINCOLN STP ST PAUL  
ORTH GREGORY THOMAS 69 CLA 776-6541  
1666 N HAZEL STP ST PAUL  
ORTH ROBERT JAMES 69 LAW  
2188 N OXFORD ROV ROSEVILLE  
ORTH THOMAS JAMES 68 CLA  
PIONEER HALL MPL REDWOOD FALLS  
ORTH THOMAS VINCENT 71 CLA 935-3669  
MPL MINNETONKA  
GRAD 645-4960  
LKD LAUDERDALE  
ORTHOEFER JOSEPH EDWARD 71 CLA 866-4524  
1797 FULHAM MPL MINNEAPOLIS  
ORTLOFF PATRICIA ANN 70 DULTH 834-4393  
6105 4TH AVE SO LARSMONT  
ORTMAN DAVID RUSSELL 71 CLA 941-1381  
BX 51 LARSMONT EDN EDINA  
ORTMAN ELISE ANN 71 DULTH 834-4785  
6905 ANTRIM RD LARSMONT  
ORTMAN LORRAINE KAY 71 AGFHE 521-5235  
BOX 58 MPL MINNEAPOLIS  
ORTON DAVID GREGORY 68 CLA 869-4662  
1013 14TH AVE NO RHF RICHFIELD  
ORVEDAHL JANET ANN GRAD  
6713 13 AVE SO  
ORVIS CHARLES CURTIS 69 AGFHE 645-6316  
2026 COMD AVE SE STP PENCER  
ORVIS CHERYL LOUISE 70 CLA 489-1421  
2030 BREWSTER MPL  
OSADCHUK ROSALIND MARI 68 ED 938-9070  
1122 MATILDA ST MTV MINNETONKA  
OSADCKY BARBARA SUE 69 IT 938-9386  
4554 GAYWOOD DR MTV  
OSBERG ALLEN IRVING 70 CLA 881-7015  
5125 HOLIDAY RD BLT BLOOMINGTON  
OSBERG MARGERY GALE 70 CLA 545-7630  
9030 CHICAGO AVE SO SLP ST LOUIS PARK  
OSBERG ROBERTA LYNN 70 MED 331-8237  
2211 LOUISIANA AVE SO MPL ROCHESTER  
OSBORN MICHAEL JOSEPH 70 CLA 331-8382  
631 OAK ST SE MPL LESUEUR  
OSBORN SCOTT CHARLES 68 AGFHE  
1227 4TH ST SE MPL CLOQUET  
OSBORN THOMAS CHARLES 69 AGFHE 331-6630  
319 8TH ST SE GRAD  
OSBORNE DAVID MPL  
425 ERIE ST SE GRAD  
OSBORNE PETER JOHN KEV

OSE JANET ARLENE AS PH 331-8709  
1409 COMD AVE SE MPL PT ANGELES WA  
OSE KATHRYN LOUISE 70 CLA 927-8081  
3900 UPTON AVE SO MPL THF RIVER FALLS  
OSEKOWSKY JAMES DENIS 68 GC 824-8658  
709 WEST 38TH ST MPL MINNEAPOLIS  
OSENDORF DAVID JOSEPH 70 CLA 222-2063  
955 FELIX ST WSP WEST ST PAUL  
OSGOOD PAMELA RAE 71 CLA 545-6958  
2642 W CEDAR CREST ROAD MTV MINNETONKA

OSHAUGHNESSY COLLEEN A 68 GC 699-9050  
2014 JULIET AVE STP ST PAUL  
OSHAUGHNESSY KATHLEEN 70 CLA 331-1381  
1121 5TH ST SE MPL ROCHESTER  
OSHAUGHNESSY MAUREEN 71 CLA  
1034 OHIO WSP WEST ST PAUL  
OSHEA JAMES BARTON 69 GC 825-5117  
4737 11TH AVE SO MPL MINNEAPOLIS  
OSHEA JOANNE 71 DULTH  
914 E 2ND ST BAGLEY  
OSHIMA KEVIN JOHN 69 GC 927-5168  
4829 XERXES SD MPL MINNEAPOLIS  
OSIER JANICE MARIE 71 CLA 866-8944  
6528 GIRARD AVE SO RHF RICHFIELD  
OSLAND ASBJORN 71 CLA 784-4895  
7345 HAYES ST FRD FRIDLEY  
OSLAND GARY JAMES 69 CLA 373-6264  
PIONEER HALL RM 1421 MPL AUSTIN  
OSLAND MARI 68 OT 784-4895  
7345 HAYES ST FRD FRIDLEY  
OSLAND MARGARET ANN 71 DULTH 525-3309  
5402 JUNIATA ST DULUTH  
OSLAND STUART HAROLD 70 CLA 699-9668  
1442 STANFORD AVE STP ST PAUL  
OSMAN NANCY MARIE 70 CLA 869-3632  
6629 VINCENT SO RHF RICHFIELD  
OSMAN PEDRO FAROUK 70 CLA 224-3996  
636 GRAND AVE STP BRAZIL  
OSMAN SUSAN EVE 70 CLA  
5101 JAMES AVE SO MPL MINNEAPOLIS  
OSMONDSON JUDITH MARIE 68 AGFHE 644-7198  
1530 CONCORDIA AVE STP HOPKINS  
OSMONDSON HAROLD OMAR 69 IT

OSOJNICKI JOHN ROBERT 68 DULTH 727-5443  
2529 HAGBERG ST DULUTH  
OSOJNICKI MARK COMSTOC 71 IT

OSOJNICKI WILLIAM JAMES 71 DULTH 727-5443  
2529 HAGBERG ST DULUTH  
OSOWSKI JOSEPH DAVID 68 CLA  
2244 PIKE LAKE DR NWB CIRCLE PINES  
OSSANNA MICHAEL PHILLI 68 GC  
6408 ROWLAND RD HOP HOPKINS  
OSSMAN PAUL MALCOLM 68 MED 331-1329  
325 HARVARD ST SE MPL ST PAUL  
OST MARY ANN GRAD 938-4546  
2926 TEXAS AVE SO MPL MINNEAPOLIS  
OST SUSAN ALETHA 70 DULTH 525-3008  
1529 N 51ST AVE E DULUTH  
OST WAYNE ALVIN GRAD 333-8733  
328 4TH ST SE MPL MONTEVIDEO  
OSTAPENKO OLGA 71 CLA KE7-0651  
3131 VERA CRUZ ROB ROBBINSDALE  
OSTBERG GARY WILLIAM 68 GC 941-3740  
6344 WILRYAN AVE SO EDM EDINA  
OSTBERG JOHN JEFFREY 71 CLA 429-4251  
5590 W BALD EAGLE MTB WHITE BEAR LAKE  
OSTBY PATRICIA LOUANNE 70 CLA 721-4234  
3646 19TH AVE SO MPL MINNEAPOLIS  
OSTBY SHEILA MARGARET 70 CLA 729-2939  
2937 38TH AVE SO MPL MINNEAPOLIS  
OSTBY SHERYL CORRIANE 71 CLA 721-4234  
3646 19 AVE SO MPL MINNEAPOLIS  
OSTEN EVARISTE FRANCHE 69 ED 774-2570  
1259 MCLEAN AVE STP ST PAUL  
OSTENBERG ROBERT DALE 70 DULTH 525-1152  
4532 JAY ST DULUTH  
OSTENSEN KARI JOAN 69 CLA  
PIONEER HALL MPL ROCKY POINT NY  
OSTENSO ZED ERIC 69 GC  
FRONTIER HALL MPL EAU CLAIRE WI  
OSTERBAUER MARY JANE 71 DENNY 429-7036  
1023 5TH ST MTB WHITE BEAR LAKE  
OSTERBAUER SHARON LYNN 70 CLA 339-0531  
POWELL HALL MPL MINNEAPOLIS  
OSTERBERG HAROLD EDWARD 69 GC 537-4684  
4318 HAMPSHIRE AVE NO CYT CRYSTAL  
OSTERBERG LAUREL GAY 70 CLA 331-8854  
943 17TH AVE SE MPL MINNEAPOLIS  
OSTERBERG PAUL ROBERT 71 CLA  
TERRITORIAL HALL MPL ALEXANDRIA  
OSTERBERG RICHARD TIMM 71 CLA  
TERRITORIAL HALL MPL WHEELING IL  
OSTERBERG SPENCER KING 70 CLA  
4915 EMERSON AVE NO MPL MINNEAPOLIS  
OSTERGREN ROBERT CLIFF 70 CLA 488-1306  
1137 RYAN AVE W ROV ROSEVILLE  
OSTERGREN ROGER PAUL 68 GC 631-0483  
2002 EDGERTON ST MPH  
OSTERHAUS CHERYLE LEE 70 CLA 373-6084  
424 PIONEER COURT MPL ALEXANDRIA  
OSTERKAMP JUDY LEA 69 GC 454-3595  
2804 LEXINGTON AVE SO WSP WEST ST PAUL  
OSTERLUND PAUL ALLEN 70 CLA 722-0155  
4143 30TH AVE SO MPL MINNEAPOLIS  
OSTERMAN EDWARD 68 VET M 645-6975  
2054 BREWSTER ST STP BROOKLYN NY  
OSTERMANN ROBERT JOHN 70 IT  
700 UNIVERSITY AVE SE MPL FRAZEE  
OSTERN DIANA LEA 71 CLA  
SANFORD HALL MPL PRESTON  
OSTERREICH MICHAEL FRED 70 CLA 537-3384  
7940 60 1/2 AVE NWH NEW HOPE  
OSTFIELD JOHN NED 70 CLA 522-4832  
1210 MORGAN AVE MPL MINNEAPOLIS  
OSTGULEN RICKEY COLE 71 IT  
FRONTIER HALL MPL HOWARD LAKE  
OSTIN SHARON DEBRA 69 CLA  
982 15TH AVE SE MPL WMINNEPIG MAN

OSTLUND DAVID GEORGE 68 CLA 926-1946  
6433 NORMANDALE RD EDN EDINA  
OSTLUND DAVID WALLACE 69 CLA 421-3965  
2717 5TH AVE N ANK ANOKA  
OSTLUND LORIE ANN 68 GC 938-4159  
3723 SUMNER AVE SLP ST LOUIS PARK  
OSTLUND PATRICIA LYNN 71 CLA 724-9456  
3605 36 AVE SO MPL MINNEAPOLIS  
OSTLUND SUSAN JANE 68 GC 545-2332  
5708 HOPEWOOD LANE NWH NEW HOPE  
OSTMAN DEVONNE JUDY 69 MEDTC  
3755 FREMONT NO MPL EDEN PRAIRIE  
OSTMAN GAY JOELLYN 70 CLA 938-7905  
5613 COUNTY RD 18 SO EDM EDINA  
OSTMAN KAREN JOY 70 CLA 929-3559  
5917 OLINGER RD EDM EDINA  
OSTMOE MARTHA JANE 70 DULTH 728-1698  
523 WOODLAND AVE MILACA  
OSTMOE MARY MARGARET 70 DULTH 728-1698  
523 WOODLAND AVE MILACA  
OSTMOE NANCY ANN 69 ED 522-1796  
3755 FREMONT NO MPL MINNEAPOLIS  
OSTMOE PAUL DAVID 70 CLA 983-3540  
160 7TH AVE SE MILACA  
OSTRANDER MARGARET ANN 70 DULTH 724-7475  
1207 MPLS AVE DULUTH  
OSTREIM DAVID MELVIN 70 CLA 588-1885  
2913 ORCHARD AVE N GOV GOLDEN VALLEY  
OSTREM MARLYS ARLENE 70 CLA 722-0881  
3896 24TH AVES O MPL MINNEAPOLIS  
OSTREM THEODORE LYNN 71 DENT  
CENTENNIAL HALL MPL MOORHEAD  
OSTRIN GARY PHILLIP 68 GC 920-1739  
4516 HWY 7 MPL MINNEAPOLIS  
OSTROM A JEROME AS AGFHE

OSTROM ELEANORE SELAND AS ED

OSTROM GARY NEIL 71 DULTH  
BRAHAM  
OSTROM LINDA JEANNE 71 DULTH 724-9914  
BURNTSIDE HALL 101 MINNEAPOLIS  
OSTROM STEVEN MICHAEL 71 IT 533-8151  
4100 JERSEY AVE NO CYT CRYSTAL  
OSTROOT SUSAN MARGARET GRAD 373-6073  
PIONEER CT MPL MINNEAPOLIS  
OSTROSKA GEORGE FRANK 68 CLA  
500 7TH ST SE MPL REDWOOD CITY CA  
OSTROUSHKO JURJ 69 GC 332-7732  
711 ADAMS ST NE MPL MINNEAPOLIS  
OSTROUSHKO LUOMILLA 70 CLA 332-7732  
711 ADAMS ST NE MPL MINNEAPOLIS  
OSTROW RONALD STEVEN 71 CLA 588-2650  
4901 ST CROIX AVE MPL MINNEAPOLIS  
OSTROWSKI KAREN MARIE 71 CLA 646-1017  
1630 LAUREL AVE STP ST PAUL  
OSTRY MICHAEL EDWARD 71 AGFHE 331-1472  
844 19TH AVE SE MPL MINNEAPOLIS  
OSTVIG MARTIN C JR 69 ED 331-4815  
MAPLE PLAIN

OSTWALD MELVIN GEORGE 69 CLA 823-0289  
2901 KNOX AVE SO MPL LAKEFIELD  
OSULLIVAN JOHN MICHAEL 69 GC 377-2267  
2507 BURNHAM RD MPL MINNEAPOLIS  
OSWALD BRUCE ELLIOTT 71 IT 776-5320  
1965 ENGLISH ST MPH MAPLEWOOD  
OSWALD ELIZABETH LOU 71 DULTH 724-8318  
1911 E 6TH ST DULUTH  
OSWALD ROBERT CLEMENT GRAD

OSWALD SUSAN MARY 68 DULTH 724-8318  
1911 E 6TH ST DULUTH  
OSWOLD ROBERT OSCAR 71 DULTH 879-7437  
737 22ND ST CLOQUET  
OTAVA JOHN DAVID 70 DULTH  
MOUNTAIN IRON  
GRAD  
OTHMER HANS GEORGE MPL WOODLAND MI  
BOX 46 DEPT CHEM ENG 71 CLA 929-7423  
OTIS LINDA LOUISE SLP ST LOUIS PARK  
3293 EDGEWOOD AVE SO GRAD 484-6400  
OTTOLE JAMES BERNARD SLP  
4145 REILAND LANE  
OTOS NANCY ANN 68 DULTH 724-8316  
316 N 15TH AVE B HUTCHINSON  
OTT JACK ARTHUR GRAD

OTT MARJORIE ANN 70 CLA 331-3668  
505 15TH AVE SE MPL COLUMBIA HTS  
OTTAWAY CHIPPOD ALLAN GRAD  
1028 UNIVERSITY AVE SE MPL TORONTO  
OTTE ARLAND WAYNE GRAD 331-6067  
1307 BROOK AVE SE MPL  
OTTE CAROLE IRBNE 69 CLA  
2119 9TH ST SO MPL NEW BRIGHTON  
OTTE DOUGLAS CHARLES 68 CLA 786-3076  
3851 MINUTEMAN LA N NWB  
OTTE GLENN CARL 70 CLA 784-3466  
9010 HWY 8 LEX LEXINGTON  
OTTE NANCY LEE 70 CLA 786-3076  
3851 MINUTEMAN LN NWB NEW BRIGHTON  
OTTEN LINDA VIRGINIA 70 CLA 645-5354  
1623 CARL ST APT 15 STP HOPKINS  
OTTENBACHER BONNIE DEE GRAD 331-4232  
708 5TH ST SE MPL ABERDEEN SD  
OTTENSTROER DUANE LEO 68 BUS 338-2419  
329 MONROE NE MPL ANOKA  
OTTENHOLT DANIEL ERICK 70 MORRS 589-2354  
408 E 2ND ST  
OTTENHOLT SUSAN LUCILLE 68 MORRS 589-4693  
SPOONER HALL

OTTERLEI JOHN 6229 MALONEY AVE OTTERNESS DALE HOWARD 6836 HARRIET AVE OTTERNESS JOHN WILLIAM 4503 ARDEN AVE OTTERSON DAVID JOHN 704 SLATE ST OTTESON BARBARA JO 1758 HEWITT OTTESON GENE CHARLES PIONEER HALL OTTESON ORLO JAMES 1403 4TH ST SE OTTING SR M AGNES	70 IT 935-4165 HOP HOPKINS 70 IT 869-2936 RHF RICHFIELD 68 CLA 926-1316 EDN EDINA 68 DULTH 879-7160 CLOQUET 68 ED 646-5448 STP ST PAUL 69 CLA MPL GLENCOE AS CLA 332-9509 MPL WATERLOO IA 68 PH	OVerson THEODORE JOHN 4640 34TH AVE SO OVICK JOYCE EVELYN 1828 E SUPERIOR ST OVIK GREGORY PHILIP 301 105TH AVE NE OVSHAK LARRY JOHN 4217 ZENITH AVE NO OWEISS IBRAHIM MOHAMED	71 CLA 722-5936 MPL MINNEAPOLIS 68 DULTH VIRGINIA 69 BUS 757-2853 BLA BLAINE 70 IT 588-7221 MPL MINNEAPOLIS GRAD	PADDEN KATHLEEN PATRIC 71 CLA 926-1283 MINNEAPOLIS PADDEN VIRGINIA MARY 71 CLA PADDOCK BRUCE GEORGE 70 PHARM DULUTH PADEL FORD HAROLD EDWAR GRAD 645-5918 STP PADEL FORD ROBERT EDWAR 70 DULTH ST PAUL GRAD	PAADMANABHAM ARIMILLI A GRAD 825-1189 4421 DUPONT AVE S MPL BHIMAVARAM PADULA KATHLEEN MARIE 70 CLA 781-4471 1416 UNIVERSITY AVE NE MPL MINNEAPOLIS PAETZEL HENRY DENNIS 68 BUS 459-1474 1301 3RD ST SPP ST PAUL PARK PAETZEL KENNETH ELMER 68 IT 331-5410 615 6TH ST SE MPL LINDSTROM PAETZNICK RONALD WAYNE 71 CLA 521-7929 4422 PENN AVE NO MPL MINNEAPOLIS PAEZ LUPE MICHAEL 68 CLA 2983 SO HUTCHINSON ING INVER GROVE PAFIOU CYNTHIA LOUIS 68 GC 869-4691 7538 COLUMBUS AVE SO RHF RICHFIELD PAGE ALAN GREGORY 71 CLA 331-6400 FRONTIER HALL MPL EDINA PAGE CHRISTOPHER HEADL GRAD 645-3316 1535 BRANSTON STP ST PAUL PAGE CYNTHIA DIANE 70 CLA 333-4527 316 10TH AVE SE MPL HAMOVER PAGE DOUGLAS WALTER 70 CLA 926-2201 MPL MINNEAPOLIS PAGE HARRY LEROY JR 69 ED 433-6078 FRONTIER HALL MPL AUSTIN PAGE JACQUELINE EHARDT AS ED
OTTINGER PAUL ROBERT 2230 VERMILION RD OTTO ARTHUR JOHN 2392 LARPEUTURE AVE OTTO C GREGORY 855 ST CLAIR OTTO DAVID STANLEY 9101 PENN AVE SO OTTO DENNIS JOSEPH 1324 IRVING AVE N OTTO FRANCIS EDWARD 2411 PLEASANT AVE SO OTTO JAMES LYLE 3990 BRUNSWICK AVE SO OTTO JANICE LYNN 2322 GORDON AVE OTTO JEFFREY STEWART TERRITORIAL OTTO KATHY JANE 6042 BLAISDELL SO OTTO LOIS CATHERINE 2232 GORDON OTTO RICHARD KARL 946 15TH AVE SE OTTO S JAMES 7207 LYNDALE OTTO SHERMAN HENRY 2721 GOLDEN VALLEY RD OTTO TERRY LYNN 1414 6TH ST SE OTTO WILLIAM WALTER 2474 ARONA ST OTTOSON JUOITH MARILYN 4316 43RD AVE SO OTTUM ANDREA JOYCE COMSTOCK HALL OU SHINGI 1300 5TH ST SE OUAL ROBERT DOUGLAS 1411 E 99TH ST OUELLETTE FRANCES GENE 237 VERNON OUKROP KATHY LYNN 4901 CULVER RD OURADNIK NANCY ANN 88 ARTHUR AVE SE OUSE DAVID JOHN 725 W 5 ST OUSE MARTIN STEEN 725 W 5TH ST OUTWATER FRANCES 2101 ELLIOT AVE SO OUTWATER RICHARD ALLAN 2101 ELLIOT AVE SO OVERBACH JOHN HARVEY 1759 7TH ST SW OVERBY ARTHUR ANDREW 1361 N CLEVELAND AVE OVERBY PHILIP GORDON 4320 MINNETONKA BLVD OVERBY ROBERT LEE 2051 NOKOMIS OVERCASH MICHAEL RAY 1833 FRANKLIN ST SE OVERCOTT ARTHUR MELVIN 549 ERIE ST SE OVERGAARD GARY ALLEN 70 MORRS GLENWOOD OVERGAARD WILLARD MICH GRAD	69 DULTH 724-6472 DULUTH 68 AGFHE STP ST PAUL 71 AGFHE 227-3992 STP ST PAUL 68 BUS 888-7464 BLT REDWOOD FALLS 71 CLA 529-8964 MPL MINNEAPOLIS 68 GC 332-2122 MPL LESTER PRAIRIE 70 CLA SLP ST LOUIS PARK 71 CLA 644-3122 STP DAWSON 71 IT MPL 68 GC 869-6031 MPL MINNEAPOLIS 70 CLA 644-3122 STP DAWSON 71 CLA MPL WHEATON 68 GC 869-7158 RHF RICHFIELD 71 CLA 521-5383 N MPL MINNEAPOLIS 70 CLA 331-9204 MPL REDWOOD FALLS 70 CLA 633-6959 ROV ROSEVILLE 68 NURS 724-2503 MPL MINNEAPOLIS 70 CLA 373-7278 MPL MARSHALL GRAD MPL TSOYIN GRAD 888-9825 EDN EDINA 70 AGFHE 699-1937 STP ST PAUL 70 ED 588-3683 GOV GOLDEN VALLEY GRAD 338-1524 MPL 71 DULTH 722-4413 DULUTH 69 DULTH 722-4913 DULUTH GRAD MPL MAGALIA CA GRAD MPL ENCINO CA 70 CLA 282-2619 ROCHESTER 68 VET M STP WOLVERTON GRAD 926-6121 MPL 71 CLA 735-1005 STP ST PAUL GRAD 338-4037 MPL MEDIA PA 70 CLA MPL 70 MORRS GLENWOOD GRAD	OWEN CHARLES FRANCIS GRAD OWEN KATHRYN LOUISE 3435 COLFAX AVE S OWEN MARGARET ELIZABET 311 10TH AVE SE OWEN MARTHA ELIZABETH 329 10TH AVE SE OWEN MARYLOU 1485 NO PASCAL OWEN NANCY ANNE 701 E 77TH ST OWEN SALLY OGDahl OWEN WILLIS LYSLE JR 2500 COMO SE OWENS BRUCE JAMES 1829 UNIVERSITY AVE SE OWENS DALE ROBERT TERRITORIAL HALL OWENS FREDRIC NEWELL 6425 GIRARD N OWENS JEFFREY KENNETH OWENS MARK ARTHUR RT 7 BOX 835 OWENS ROBERT GENE OWENS ROBERT JOHN FRONTIER HALL OWENS SALLY MORLEY 1026 SE 5TH ST OWENS SUSAN JAYNE GAY HALL OWINGS RICHARD KENNETH 665 E VIKING DR OXBERRY GWEN CAVANAUGH 2136 VICTORY MEM DR OXBORROW GORDON SQUIRE 995 LYNDE DR OXELSON ERIC CARL 3122 4TH ST SE OXMAN KAREN ANN 3730 GLENHURST AVE SO OXTON DWIGHT JEROME OYANAGI KENJI OYLER WILLIAM ELLSWORT OYSTER RUSSELL LEE 2713 18TH AVE SO OYSTER SUE ELLEN 1399 N CLEVELAND AVE OZARK JOAN MARY OZARK TIMOTHY KEVIN 4945 BRYANT AVE SO OZOLINS SULAMIT ILSE 2836 41ST AVE SO OZOLS ILGA ZELMA 3336 24TH AVE S OZWOELD ROBERT LEON 1400 UNITY AVE NO PAAJANEN GEORGE ELMER 8911 TYLER ST NE PAAP BEVERLY MAE 213 E MYRTLE ST PAAPE EMIL E 2640 10TH AVE SO PAAYOLA DENNIS EMIL 1701 ARROWHEAD ROAD PAAYOLA ROGER CARL 2130 MILLER TRNK PABST WARREN IRVING 1345 N FARRINGTON PACE MARVIN M 1623 CARL ST PACHL BARBARA JEAN 1762 E HOYT AVE PACINI ANITA JOANNE 917 22ND AVE SE PACIOTTI BARBARA ANN SANFORD HALL PACIOTTI PAMELA PORTIA PACK KENNETH DAVID TRENTON NJ PACKA BONNIE LOUISE 68 CLA PACKARD ROBERT GEORGE 5917 COLUMBUS AVE SO PACKEE EDMOND CHARLES PACKWOOD WILLIAM THEOD 1405 6TH ST SE PACYGA NANCY ANN 810 5TH ST NE PACZKOWSKI MARGARET AM 71 CLA ALBERT LEA	69 LAW 373-6793 MPL BLUE EARTH 68 NURS 335-4196 MPL ST PAUL 71 MORRS OSAKIS 71 CLA 484-4756 LTC LITTLE CANADA 71 CLA JAZ-7711 MPL AS PH FRD SALT LKE CTY UT GRAD 331-4022 MPL PARADISE CA 71 CLA 920-1487 SLP ST LOUIS PARK 69 BUS GRAD GRAD 69 IT 722-7912 MPL HEWITT 68 AGFHE 645-1835 STP HEWITT 68 ED 71 CLA 827-3181 MPL MINNEAPOLIS GRAD 722-7970 MPL 69 CLA PA9-8212 MPL MINNEAPOLIS 68 CLA 588-6410 GDV GOLDEN VALLEY 71 CLA 784-2399 MPL MINNEAPOLIS 68 DULTH 727-1606 DULUTH AS CLA MPL WINONA 71 DULTH 724-3907 DULUTH 69 DULTH 727-3846 NEW YORK MILLS 69 ED 784-8039 STP GRAD 645-7669 STP 69 CLA 771-8470 STP ST PAUL 71 CLA 331-3543 MPL 71 CLA MPL ALEXANDRIA 68 CLA GRAD TRENTON NJ 68 CLA AS CLA 866-2646 MPL MINNEAPOLIS GRAD GRAD 331-5050 MPL SHREVEPORT LA 70 CLA MPL MINNEAPOLIS 71 CLA ALBERT LEA	PADEN DONALD THOMAS GRAD PADMANABHAM ARIMILLI A 4421 DUPONT AVE S PADULA KATHLEEN MARIE 70 CLA 781-4471 1416 UNIVERSITY AVE NE MPL MINNEAPOLIS PAETZEL HENRY DENNIS 68 BUS 459-1474 1301 3RD ST SPP ST PAUL PARK PAETZEL KENNETH ELMER 68 IT 331-5410 615 6TH ST SE MPL LINDSTROM PAETZNICK RONALD WAYNE 71 CLA 521-7929 4422 PENN AVE NO MPL MINNEAPOLIS PAEZ LUPE MICHAEL 68 CLA 2983 SO HUTCHINSON ING INVER GROVE PAFIOU CYNTHIA LOUIS 68 GC 869-4691 7538 COLUMBUS AVE SO RHF RICHFIELD PAGE ALAN GREGORY 71 CLA 331-6400 FRONTIER HALL MPL EDINA PAGE CHRISTOPHER HEADL GRAD 645-3316 1535 BRANSTON STP ST PAUL PAGE CYNTHIA DIANE 70 CLA 333-4527 316 10TH AVE SE MPL HAMOVER PAGE DOUGLAS WALTER 70 CLA 926-2201 MPL MINNEAPOLIS PAGE HARRY LEROY JR 69 ED 433-6078 FRONTIER HALL MPL AUSTIN PAGE JACQUELINE EHARDT AS ED	69 CLA 866-9817 RHF RICHFIELD 69 CLA 374-1568 MPL PITTSBURGH PA 71 CLA 429-3650 MTB WHITE BEAR LAKE 71 CLA STP ST PAUL AS CLA EXC GRAD 374-1568 MPL WHITE BEAR LAKE 68 CLA 521-0043 MPL MINNEAPOLIS 69 CLA MPL ST THOMAS 70 CLA 545-7219 MTB MINNETONKA BCH 70 CLA 822-6196 MPL MINNEAPOLIS 70 CLA 338-5998 MPL ST PAUL 69 GC 941-2212 EDN EDINA 69 CLA 825-9768 MPL MINNEAPOLIS 69 CLA 739-9417 GRAD 71 CLA MPL MAPLE PLAIN 68 GC 226-2854 STP ST PAUL 70 ED 71 CLA 781-1443 MPL MINNEAPOLIS GRAD 789-8066 2701 31 1/2 AVE NE STA ST ANTHONY 70 CLA 645-1205 STP HADLEY 70 IT MPL PITTSBURGH PA GRAD 69 ED 373-6078 MPL MAPLE PLAIN 71 CLA 560-4415 MPL MINNEAPOLIS 70 CLA BRANCH 69 AGFHE BRAINERO 70 CLA MPL 814 8TH ST SE MPL PAKALNS GUNTA VENTERIS 70 PHARM 335-8286 MPL ST PAUL 68 IT 825-8186 PARARINEN JON DAVID MI MPL IRONTON 3040 DUPONT AVE S 71 IT 690-2171 STP ST PAUL 68 ED 645-7475 STP 71 CLA 521-5793 MPL MINNEAPOLIS 69 IT 645-7246 STP FARIBAULT 69 GC 789-5585 STA ST ANTHONY GRAD 339-7421 MPL BERWYN IL

PALAZZARI PETER GUST PIONEER HALL PALAZZARI PHILIP MARIO 516 5TH ST SE PALAZZARI SUSAN JEAN SANFORD HALL PALEEN ROBERT ALLEN 5141 OAKLAND AVE SO PALERMO DANIEL JEROME CENT HALL PALERMO DAVID WARREN ELEC ENG DEPT PALFE GREGORY ANDREW 1859 FLANDRAU PALIN PEARL ANN 926 E 1ST ST PALIN PERRY JAMES RT 1 BOX 44 PALINAL RAMESH CHANDRA 965 14TH AV SE PALKOWSKI GERALD THOMA 3358 STINSON BLVD PALKOWSKI KAREN LOUISE 3546 BUCHANAN ST NE PALLANCH BONNIE JEAN 1415 5TH ST SE PALLAS CATHY JEAN 924 CHIPPEWA AVE PALM LINDA JEANNE 2634 NE MONROE ST PALM MARY BETH 3832 DREW AVE SO PALM MARY JANE	68 BUS MPL EVELETH 69 BUS MPL EVELETH 71 ED MPL EVELETH 70 CLA 822-4640 MPL MINNEAPOLIS 68 GC FE9-7421 MPL MORA GRAD 373-5031 MPL MORA 68 CLA 777-7358 MPH MAPLEWOOD 68 DULTH 728-4762 TWO HARBORS 71 DULTH TWO HARBORS GRAD 331-5144 MPL KAKORE 71 IT 781-4255 MPL MINNEAPOLIS 70 CLA 789-1632 MPL MINNEAPOLIS 70 CLA 331-8505 MPL MINNEAPOLIS 69 GC 222-4594 STP ST PAUL 68 ED 781-7070 MPL MINNEAPOLIS 71 CLA 922-4113 MPL MINNEAPOLIS 68 PT	PALM PATRICIA MARY 3832 DREW AVE SO PALM PER MAGNUS 1807 WASHINGTON AVE SO PALM RISA KAHN ILEEN 2675 PERRY AVE NO PALM SHARON LOIS 2297 STANDISH ST PALME DAROLD BRUCE 1807 STILLWATER AVE PALME- PAMELA ANN 1026 5TH ST SE PALMEN GRETCHEN MARY PIONEER COURT PALMER ANN VICTORIA 1535 GOODRICH AVE PALMER BRUCE WILLIAM 327 MONROE ST PALMER CONSTANCE ANNE 6009 BEARD AVE SO PALMER DAVID HADLEY 1627 CARL ST PALMER DOUGLAS ALAN 1317 SIXTH ST SE PALMER DOUGLAS KEITH 3044 EDGEWOOD AVE S PALMER ELIZABETH JOAN 1535 GOODRICH AVE PALMER GARY BRADFORD	70 PHARM 922-4113 MPL MINNEAPOLIS 69 CLA MPL MINNEAPOLIS GRAD 588-6245 GDV 68 CLA 645-9798 STP GROVE CITY 69 CLA STP ST PAUL 68 AGFHE 335-4196 MPL EDINA 71 CLA MPL WABASHA 70 CLA 698-2513 STP ST PAUL 69 GC ANK ANOKA 71 CLA 926-8319 MPL MINNEAPOLIS 71 MED 645-2150 STP BLACKDUCK 68 CLA 332-9919 MPL ST PAUL 70 CLA 929-3979 SLP ST LOUIS PARK 70 CLA 698-2513 STP ST PAUL GRAD	PALMER JANICE CAROL 3044 EDGEWOOD AVE SO PALMER JEFFREY HARTWEL 5229 28 AVE SO PALMER JOHN BRODERICK 1535 GOODRICH PALMER JOYCE IOLA FOR 1179 CALIFORNIA DR PALMER LAURIE GWEN 4121 SHERIDAN AVE PALMER LORIANNE 509 7TH AVE SE PALMER LOUIS T 1179 CALIFORNIA DR PALMER MICHAEL DON 1327 7TH ST SE PALMER MICHAEL NOLL 2729 N GRIGGS PALMER NANCY LOU 4845 2ND AVE SO PALMER NANCY MARGARET CLAYTON GAY HALL PALMER NAOMI ANN 1026 5TH ST SE PALMER RICHARD ALLEN 1627 CARL ST PALMER ROBERT BREWSTER	71 CLA 929-3979 SLP ST LOUIS PARK 68 GC 724-4674 MPL MINNEAPOLIS 69 ED 698-2513 STP ST PAUL 68 CLA 489-5050 ROV ROSEVILLE 71 CLA 926-2911 MPL MINNEAPOLIS 69 ED 331-8810 MPL MINNETONKA GRAD 489-5050 STP 69 CLA MPL ALBERT LEA 70 IT 484-3869 STP ST PAUL 69 DENNY 822-5897 MPL MINNEAPOLIS 71 MORRS 699-6744 ST PAUL 69 NURS 335-4196 MPL MINNEAPOLIS GRAD 645-2150 STP BLACKDUCK 70 IT	PALMER ROBERT HUDSON 4136 QUEEN SO PALMER ROBERT IRVING J	68 GC 920-5499 MPL MINNEAPOLIS 68 CLA	PALMER ROBERTA ANN 4141 HARRIET SO PALMER ROGER DALE RT 1 BOX 207 PALMER SANDRA RAE CONSTOCK HALL PALMER SUSAN LEE 718 UNIVERSITY AVE SE PALMER TERENCE JEROME 1301 FARRINGTON PALMER TIMOTHY TROM 9120 COLFAX AVE SO PALMER WESLEY EARL RT 1 BOX 207	69 GC 824-2134 MPL MINNEAPOLIS 71 CLA 472-3129 MND MOUND 69 ED MPL ROCHESTER 69 ED MPL ST PAUL 71 IT 488-3358 STP ST PAUL GRAD 888-4860 BLT ALBERT LEA 70 CLA 472-3129 MND MOUND	PALMER WILLIAM HENRY 3 68 PH PALMER WILLIAM JOHN 4845 2ND AVE SO PALMER WILLIAM THOMAS 4437 WASHBURN AVE SO PALMERSTON DENNIS CARL 821 5TH ST SE PALMGREN ANN ELIZABETH 1651 SAUNDERS AVE PALMGREN CHARLES LYNN 4141 W OLD SHAKOPEE RD PALMQUIST JEANINE MARI 3358 ULYSSES ST NE PALMQUIST NEIL THOMAS 1800 ARTHUR NE PALMQUIST ROGER KENNET 409 UNIVERSITY AVE SE PALMQUIST WILLIAM LOUI 3627 2ND ST NE PALMSTEIN MARY SUE 244 E ANOKA ST PALOKANGAS DENNIS DEAN 109 11ST SO PALOSAARI RONALD GERAL 6817 39TH AVE NO PALOVAARA MARY JEAN 1611 WAVERLY PALTIAN WILLIAM WALKER 2400 OAKLAND AVE PALUBICKI STEPHEN JOHN 655 W LARPENITEUR PALUMBO DANIEL PATRICK 57 E BAKER ST PALYVOS GRACE ANN 1904 DUPONT AVE SO PALYVOS JOHN ANGELOS 425 ERIE SE PAMPY EDNA THERESA SPOONER HALL PAN SUSHU	71 IT 822-5897 MPL MINNEAPOLIS 69 GC MPL MINNEAPOLIS 68 IT MPL MANKATO 68 GC 698-2959 STP ST PAUL 68 CLA BLT MADISON 70 CLA 789-2298 MPL MINNEAPOLIS 68 GC 781-0086 MPL 70 CLA 338-5574 MPL LAKE ELMO 68 IT 781-6305 MPL LONG PRAIRIE 71 DULTH 724-6048 DULUTH 69 DULTH 749-2857 VIRGINIA GRAD 537-5370 MPL 68 DULTH 724-4775 EVELETH 70 DULTH 724-2668 DULUTH GRAD ROV WINONA 71 CLA 224-2405 STP ST PAUL 71 CLA 377-2359 MPL MINNEAPOLIS GRAD 331-4102 MPL GREECE 70 MORRS 589-4693 BROWERVILLE GRAD	PANAYIDES CHARLES LEON CENTENNIAL HALL PANDEY HAMESH CHANDRA PLANT PATHOLOG DEPT PANDYA NEETI LALIT	GRAD MPL ENGLAND GRAD STP LUCKNOW GRAD	PANFIL THOMAS CHARLES 1015 ESSEX ST SE PANGELL RICHARD JOHN 7208 SHERIDAN PANGRAC ARDYCE OLGA HO 10913 WAYZATA BLVD PANICHI JOSEPH PETER 727 E 3 ST PANIGRAHY BRUNDEAN	70 IT MPL VIRGINIA 68 IT 869-7088 RMF RICHFIELD 69 CLA MTV MINNETONKA 69 DULTH 263-6316 HIBBING GRAD	PANK MAIA 722 EAST 26TH ST PANKAKE JON ALAN 729 8TH AVE SE PANKAKE MARCIA JEAN LA 729 8TH AVE SE PANKIW MIRA ANNA 1335 MADISON ST NE PANKONIN DAVID ALAN GAY HALL PANKONIN DAVID I 1770 LYDIA AVE PANKONIN JANET MARTHA 2392 DOSWELL PANKOW DAVID HERBERT 621 11TH AVE SE PANKOW DERRILL MARTIN	GRAD 336-1131 MPL MINNEAPOLIS GRAD 331-2551 MPL DASSEL GRAD 331-2551 MPL OSSEO 70 PHARM 781-7825 MPL MINNEAPOLIS 71 MORRS SANBORN AS BUS 633-1018 68 GC 646-3160 STP ST PAUL 68 IT 331-3021 MPL FARIBAULT GRAD	PANKRATZ BERNICE RUBY 1398 MIDWAY PKWY PANNEN DONALD EARL CENTENNIAL HALL PANNING LAWRENCE HAROL 2085 BUFORD PANNING WAYNE PAUL 4705 35TH AVE SO PANNUK BRADLEY LEROY 8401 FREMONT SO PANOU GEORGE 1202 FIFIELD ST PANT DURGA 1023 12TH AVE SE PANTERA MICHAEL JOHN 1175 POLK PLACE NE PANTSARI LARRY JAMES 7418 PILLSBURY AVE PANTULU GUMMULURU VENK	70 CLA 644-5549 STP MOUNTAIN LAKE GRAD 373-3962 MPL VICTORIA TX 68 AGFHE 646-7017 STP GRAD 729-7772 MPL ROCHESTER 69 CLA 888-2597 BLT BLOOMINGTON GRAD 645-8097 STP GREECE GRAD 331-9392 MPL 69 GC 788-8145 CLH COLUMBIA HTS 71 CLA 869-4439 RMF RICHFIELD GRAD	PANUSHKA CAROLINE BERR 519 FRONTENAC PL PANUSHKA KIM LISA 314 10TH AVE SE PANZER CHARLES ROGER 6925 13TH AVE SO PAPAIC RUDDOLPH JOSEPH 319 8TH ST SE PAPANASTASSIOU DEMETRI	AS CLA 646-4379 STP 70 CLA 333-4527 MPL ST PAUL 71 AGFHE 869-7668 RMF RICHFIELD 70 IT MPL VIRGINIA GRAD	PAPELEUX CHARLES BARRY 3680 MILTON PAPELEUX JOHN LAWRENCE 3680 N MILTON	69 IT 484-3831 STP ST PAUL 71 CLA 484-3831 SHV SHOREVIEW	PAPER RICHARD SAMUEL 311 11TH AVE SE PAPERMASTER CAROL 2730 GLENMURST AV SO PAPIKE PATRICIA JUNE 425 ERIE SE PAPILLON SCOTT JAMES 500 53 1/2 AVE NE PAPLOW SHIRLEY ANN 708 5TH ST SE PAPPAS EDWARD RAYMOND 4817 PEABODY ST PAPPAS GEORGIANA KAY 4904 3RD AVE SO PAPPAS TERRY WAYNE 1547 E 33RD ST PAPRA DEANA DRE JANE 2101 FRANKLIN AVE SE PAPRA JAN GUNTHER 2101 FRANKLIN AVE SE PAQUETTE FRANCIS JOHN FRONTIER HALL PAQUETTE MARILYN BRINK	70 CLA 333-6927 MPL WAORNA 71 CLA 920-1246 SLP ST LOUIS PARK 69 ED MPL EVELETH 71 CLA 560-5517 CLH COLUMBIA HTS 70 CLA MPL DUNDEE 69 DULTH 525-4306 DULUTH 69 GC 822-1345 MPL MINNEAPOLIS 70 CLA 724-4798 MPL AUSTIN 69 CLA 333-3822 MPL MINNEAPOLIS 68 CLA 333-3822 MPL TEANECK NJ 71 CLA 394-7459 MPL SUPERIOR WI 68 NURS	PAQUETTE ROBERT JOHN 19 E MULBERRY PAQUETTE SUZANNE MARIE 3558 2 1/2 ST NE PAQUETTE THERESE MARIE 2716 29TH AVE NE PAQUETTE THOMAS HENRY 965 BAYLESS AVE PAQUIN JEROME FREDRICK 305 OAKCREST PARADEE RONALD DENNIS FRONTIER HALL PARADIS EDWARD EUGENE 215 THOMAS AVE SO PARADISE LAWRENCE PATR 454 MICHIGAN PARADISE NORMAN FRANCI 3256 FRANCE AVE NO PARADISE RICHARD JOHN 454 MICHIGAN ST PARADY BODD KNUTH 6609 37TH AVE NO PARE SR M PAOLA	70 DULTH 722-1914 SAGINAW 68 ED 781-4781 MPL MINNEAPOLIS 71 CLA 789-2148 ST ANTHONY 69 GC 646-5529 STP ST PAUL 68 CLA 633-4399 ROV ROSEVILLE 71 CLA MPL NEW LONDON GRAD 377-0984 MPL MINNEAPOLIS 68 GC STP ST PAUL GRAD 588-0225 ROB MINNEAPOLIS 68 ED 224-0408 STP ST PAUL 68 CLA 533-8700 CYT CRYSTAL AS ED	PARENDO DENNIS CARL 6003 TACONY ST PARENT DALE GREGORY 2327 HOLLOWAY AVE PARENT KEVIN	70 DULTH 624-2855 DULUTH GRAD 777-8024 NSP GRAD	PARENT MARCILE KATHERI ST CLOUD	68 CLA ST CLOUD	PARENTEAU TRUDGE CLAIR 621 S WARWICK ST PARHAM JANICE JEAN 314 10TH AVE SE PARIANA JANIS MARY	71 CLA STP ST PAUL 71 MED 333-4527 MPL ST PAUL 71 CLA 776-8443 ST PAUL	PARIN LYLE WILBERT 22 BALD EAGLE AVE PARISEAU GREGORY FRANC	69 GC 429-9525 MTB WHITE BEAR LAKE 70 AGFHE	PARISEAU MARK DAVID 1983 BUSH AVE PARISH JANE AUDREY 2565 VALE CREST PARISH TOMMIE WAYNE 616 7TH AVE SO PARIZEK BRUCE	71 CLA 735-2459 STP ST PAUL 71 CLA GDV GOLDEN VALLEY 70 CLA 938-6911 HOP HORICON WI 68 IT	PARK CHULL GRAD	PARK CHUNG YI 69 MEDTC	PARK HAN SHIK 2384 LARPENITEUR AVE PARK HYD GUBEN BREWSTER HALL PARK SONG BAI	GRAD STP GRAD 647-3767 STP SEOUL GRAD	PARK WARREN ALEXANDER 1610 5TH ST S PARK WAYNE RICHARD 986 15TH AVE SE PARK WON HOON 421 CEDAR AVE SO PARK WON JOON 1021 22ND ST PARK YAUNGJA	68 CLA 333-1804 MPL MINNEAPOLIS GRAD 331-5713 MPL LARGO FL GRAD 336-9784 MPL SEOUL GRAD 336-2185 MPL SEOUL GRAD	PARK YOUNG JA MILLARD HALL PARK YUNG CHUL	GRAD MPL SEOUL GRAD	PARKE MICHAEL LENDROTH 15025 CHERRY LANE PARKER BRUCE ALLEN 3337 FRANCE NO PARKER CHARLES REED 2526 BUCHANAN ST PARKER DANIEL	70 CLA 935-4235 MTV MINNETONKA 71 IT 588-1449 ROB ROBBINSDALE 69 CLA 789-6177 MPL MINNEAPOLIS 71 IT MPL SEBEKA 70 MED 331-8687 MPL BLOOMINGTON IL 71 CLA 771-8554 STP ST PAUL	PARKER FRANK LOUIS 631 OAK ST SE PARKER JANE SUE 1092 E HAWTHORNE
---	---	---	--	--	---	---	---	--	---	---	--	---	--	--	--	---	---	---	---	---	---	--	---	---	---	---	---	---	---	------------------------------------	--------------------	---	---	---	---	---	---	--------------------	---------------------------	---	---	---	---	---	---------------------------	---	--	--

PARKER JEFFREY DAVID 1112 WASHBURN AVE SO PARKER JULIAN A 515 DELAWARE ST SE PARKER MARY JO BURNTSIDE MALL 145 PARKER OWEN WILLIAM 3 5101 QUEEN S PARKER ROBERT DAVIS RI CENTENNIAL HALL PARKER VIRGINIA LYNN 1387 CLEVELAND PARKER WENDY SUE	70 IT 377-8029 MPL MINNEAPOLIS GRAD 331-6825 MPL 71 DULTH 724-9814 BLACKDUCK 69 GC 926-7828 MPL MINNEAPOLIS GRAD 339-7421 MPL HONOLULU HI 70 CLA 644-4222 STP GRANDY AS GC	PASKE LOUISE BOYUM M 5605 KELLOGG PLACE PASKE RICHARD CHARLES 1206 5TH ST SE PASKEWITZ DANIEL FRANK 901 WASHINGTON AVE SE PASKEWITZ DONALD PETER 2124 W HOYT AVE PASKVAN DOROTHY DIANE COMSTOCK HALL PASKVAN PATRICIA ANN 330 NW 4TH ST PASKVAN RAYMOND FRANK	AS ED 926-9280 EDM 70 CLA 331-5941 MPL EDINA GRAD 331-2133 MPL ST PAUL 70 CLA 644-9323 STP ST PAUL 70 CLA MPL CHISHOLM 68 OT CL4-3123 GRAD	PATTEN SHARON KAY 2017 GARFIELD AVE SO PATTEN THOMAS MICHAEL 1118 E 5TH ST PATTERSON ARTHUR EDWAR 406 N 59TH AVE W PATTERSON DAVID ROBERT PATTERSON HARRY LEWIS 947 17TH AVE SE PATTERSON JODY MAUREEN 547 SO WARWICK PATTERSON KENNETH WILL 1014 N 24TH AVE W PATTERSON MARIE STANG 9157 TOLEDO RD PATTERSON MARSHA RAE 7526 WENTWORTH AVE S PATTERSON MARY ANN	GRAD 339-1067 MPL WASECA 69 DULTH 724-3645 DULUTH 70 DULTH 624-5942 DULUTH 70 DULTH ROCHESTER GRAD 331-9122 MPL COLUMBUS OH 71 CLA 699-2891 STP ST PAUL 68 DULTH 722-1595 DULUTH 69 ED 888-1041 BLT BLOOMINGTON 68 ED 866-5690 RHF RICHFIELD 71 CLA MPL WESTBROOK 69 MORSC 331-1369 MPL GOTHENBURG NB AS DULTH 624-6942 DULUTH 71 DULTH 624-2929 PROCTOR 71 CLA WSP WEST ST PAUL GRAD 646-5017 STP WESTBROOK PATTENSON THOMAS EDWAR P D BOX 1113 HAMLINE U PATTERSON THOMAS HOWAR 6515 STEVENS AVE RHF RICHFIELD 68 CLA 451-3358 MPL ST PAUL GRAD 429-5954 MPL WHITE BEAR LAKE 70 IT 633-6592 MPL BIWABIK 71 CLA 663-5805 MPL MINNEAPOLIS 70 DULTH STAPLES GRAD 588-9429 GDV 69 ED 861-2421 RHF 70 DULTH 624-5059 DULUTH 69 MORRS MARIETTA 70 DULTH EVELETH 70 CLA 823-5134 MPL MINNEAPOLIS 70 AGFHE 774-4438 STP ST PAUL 70 CLA 699-4730 STP ST PAUL 69 MORRS 589-4833 APPLETON 68 BUS
PARKER WILLIAM ARTHUR 3500 MCNAIR DR PARKHURST ANN LYNN 1327 7TH ST SE PARKHURST STEPHEN DAVI TORRENCE HALL 122 PARKIN JAMES WILLIAM 401 UNIV AVE SE PARKINSON LAYCE WAYNEE 301 12TH AVE SO PARKINSON RICHARD JOHN 312 WARWICK PARKOS WILLIAM GEORGE 6008 LONDON RD PARKS CONSTANCE LOU COMSTOCK HALL PARKS DARRYL DEE 908 SPRING LAKE RD PARKS DAVID ARTHUR 6718 2ND AVE SO PARKS DONALD JAMES CENTENNIAL HALL PARLIAMENT STEPHEN BRA	71 CLA 588-2936 ROB ROBBINSDALE 69 ED MPL STILLWATER 71 DULTH 724-9841 STILLWATER 69 DENT 338-2021 MPL CLAREMONT SD 69 CLA 455-9470 SSP SOUTH ST PAUL 69 GC 698-7629 STP ST PAUL GRAD 70 CLA 674-2492 MPL VERNON CENTER 70 DULTH 879-5247 CLOQUET 68 GC 866-8650 RHF RICHFIELD GRAD 339-7421 MPL DENVER CO GRAD	PASSA DENNIS RAY BAILEY HALL PASSE JAMES RICHARD PASSI LYNN LAITALA MAR 3201 4TH ST SE PASSON MILTON NATHAN 1037 THOMAS SO PASSON SUSAN RAE SANFORD HALL PAST LINDA DIANE 4913 ZEALAND AVE NO PASTERNAK ANM ELIZAB 2818 E 1ST ST PASTIKA JUDY MARGARET 404 DALEWOOD AVE PASTIKA PETER LANTZ GRIGGS HALL C317 PASTIKA ROLAND BRADLE 404 DALEWOOD AVE PASTOR HARLAN ALLAN 687 SUMMER ST PASTRANA JOSE M INST OF MINERAL & METAL PASWALK SHARON KAYE 527 DAK ST PATCHEN ROBERT JOHN 740 MADISON ST PATCHET STEVEN CARL 1771 BRUCE AVE PATCHIN GORDON R 1620 NILES AVE PATE DENNIS JAMES BAILEY HALL PATE RANDOLPH LEWIS 2825 NO PASCAL PATE WILLIAM ANTHONY	70 AGFHE STP THF RIVER FALLS 68 IT 68 CLA 331-9210 MPL MINNEAPOLIS 68 PHARM 377-5264 MPL MINNEAPOLIS 69 GC 373-6644 MPL DULUTH 68 CLA 533-3581 NHV NEW HOPE 70 DULTH 728-1738 DULUTH 70 DULTH 879-8788 CLINTON 70 DULTH 724-9880 BABBITT 68 DULTH 879-7877 CLOQUET 69 GC 698-6617 STP ST PAUL GRAD MPL BOLIVIA 68 CLA 331-7232 MPL WINONA 69 CLA 421-4537 ANK ANOKA 70 CLA 633-4218 ROV ROSEVILLE 71 CLA 699-9615 STP ST PAUL 71 AGFHE STP KILKENNY 71 CLA 633-7126 STP ST PAUL AS CLA	PATTISON MARTHIA MAY BOX 113 PATTISON NANCY JEAN 2714 E 1ST ST PATTOCK FLORENCE MARIE 1141 TOLEDO AVE NO PATTY CAROLYN REAVIS A 710 E 78TH ST PATULLO THOMAS NICK 215 S 62 AVE W PATZER STANLEY LEE MORRIS TRAILER CT 19 PAUCHNIK MARGERY ANN	71 CLA 69 MORSC 331-1369 MPL GOTHENBURG NB AS DULTH 624-6942 DULUTH 71 DULTH 624-2929 PROCTOR 71 CLA WSP WEST ST PAUL GRAD 646-5017 STP WESTBROOK PATTERSON THOMAS HOWAR 71 AGFHE 866-5872 RHF RICHFIELD 68 CLA 451-3358 MPL ST PAUL GRAD 429-5954 MPL WHITE BEAR LAKE 70 IT 633-6592 MPL BIWABIK 71 CLA 663-5805 MPL MINNEAPOLIS 70 DULTH STAPLES GRAD 588-9429 GDV 69 ED 861-2421 RHF 70 DULTH 624-5059 DULUTH 69 MORRS MARIETTA 70 DULTH EVELETH 70 CLA 823-5134 MPL MINNEAPOLIS 70 AGFHE 774-4438 STP ST PAUL 70 CLA 699-4730 STP ST PAUL 69 MORRS 589-4833 APPLETON 68 BUS
PARLIN NANCY CATHERINE 2120 CLINTON AVE SO PARLIN PATRICIA MARY 1507 KALTERN LANE PARMET HERBERT 3033 KYLON AVE SO PARMET HOWARD 3033 KYLON AVE SO PARNELL PATRICK WILLIA 1516 COMO AVE PARO SHERA LYNN BURNTSIDE HALL 162 PARON FRANCIS JOHN 814 ESSEX AVE SE PARR KENNETH RICHARD 316 SO HAMLINE AVE PARRANTO ROBERT J 1324 JAMES PARRANTO ROSALIE RENEE 1324 JAMES AVE PARRILL NANCY LYNN 3212 EDGEMERE NE PARRISH RONALD JOSEPH 716 37TH AVE NE PARSON ALLEN HENRY 621 ANDERSON RD PARSON COLLEEN MARIE 1169 REANEY AVE PARSON JUDY LEE 1408 HYTHE ST PARSON KATHY ANN 3701 54TH AVE NO PARSON RICHARD JOHN 2223 W 24TH ST PARSON THOMAS LYNN 619 WINNIPEG AVE PARSON TYRA ANN BENDEK	GRAD 332-1033 MPL GRAD FR7-3157 GDV GOLDEN VALLEY 68 ED 935-9238 SLP ST LOUIS PARK 68 CLA 935-9238 SLP ST LOUIS PARK 69 GC 644-6454 STP ST PAUL 71 DULTH 724-9896 SILVER BAY 71 DENT MPL SHAKOPEE 70 CLA 699-6503 STP ST PAUL 68 GC 699-0183 STP ST PAUL 69 ED 699-0183 STP ST PAUL 70 CLA 789-9631 STA ST ANTHONY 70 CLA 789-3000 MPL MINNEAPOLIS 69 DULTH 727-3335 DULUTH 68 GC 776-9905 STP ST PAUL 68 AGFHE 644-3267 STP ELBON LAKE 71 AGFHE 537-2961 BRC BROOKLYN CENTER 68 DULTH 722-6257 DULUTH 70 DULTH 722-0914 DULUTH 68 ED 829-8904 BRAINERD 68 ED 824-4965 MPL MINNEAPOLIS 70 CLA 373-6083 MPL DELANO 69 CLA 529-6147 MPL MINNEAPOLIS 70 CLA 822-7583 MPL MINNEAPOLIS 70 AGFHE 929-9565 EDN EDINA 68 LAW MPL NAPERVILLE IL 69 DENT 633-7793 NMB ST PAUL 70 CLA 471-9545 LOL 70 DULTH 727-3802 DULUTH 69 DULTH 724-7284 FINLAYSON 70 CLA 788-2565 CLH COLUMBIA HTS 68 IT 331-3749 MPL MADISON WI 69 AGFHE 645-8787 STP HOFFMAN GRAD MPL FARIBAULT GRAD	PATEL CHANDRAKANT SOMA 321 OAK ST PATEL PRADYUMAN R PATEL VITHTHALBHAI U 501 ONTARIO SE PATENAUE DANIEL PETER 117 ARTHUR AVE SE PATENAUE DOREEN SUSAN 52 SO 10TH ST PATER JEANEEN CAROL COMSTOCK HALL PATER LOWELL LYNN TERRITORIAL HALL PATERAKI CATHERINE 1011 ARROWHEAD RD PATH JANET LORRAINE 401 13TH AVE SO PATH LYNN MARIE 401 13TH AVE SO PATH MICHAEL GEORGE 2609 16TH AVE SO PATIENT GREGORY MELLO 427 S WABASHA PATINEAU JOANN KAY SANFORD HALL PATKA JAMES BENEDICT 1623 CARL ST PATKA NANCY LINDORFER 1623 CARL ST PATNODE TERRANCE JAMES 2327 SHERIDAN AVE NO PATOILE FRANCIS JOSEPH PATOILE JOHN RAYMOND 1654 N HAMLINE PATOSKI CHRISTINA VICT 319 12TH AVE SE PATRIAS DENNIS JOHN 1609 E 28 ST PATRICK DENNIS BARTLET 6739 IRVING SO PATRICK RALPH LEON 2904 EUCLID PLACE PATRICK TERRY DEAN 1718 E 3RD ST PATRIN JEROLD FRANCIS	GRAD 331-3876 MPL KHAMGAON GRAD 71 MED 331-7149 MPL NORTHFIELD AS CLA 336-5001 MPL LAKEVILLE 71 CLA 339-0063 MPL RED LAKE FALLS 70 CLA MPL WALTHAM 71 IT 373-6610 MPL WALTHAM 71 DULTH 728-2848 GREECE 71 CLA 451-8816 SSP SOUTH ST PAUL 69 DENNY 451-8816 SSP SOUTH ST PAUL 68 DENT 722-0725 MPL SOUTH ST PAUL 70 CLA 224-1092 STP ST PAUL 69 CLA MPL INTERNAT FALLS 71 MED 646-8317 STP VIRGINIA GRAD 646-8317 STP WEST ST PAUL 71 AGFHE MPL MINNEAPOLIS 69 IT 71 CLA HU9-1485 STP ST PAUL 70 CLA 331-6146 MPL EDINA 68 GC 722-7101 MPL MINNEAPOLIS 70 CLA 869-4400 RHF RICHFIELD 70 IT 374-4418 MPL 69 DULTH BRAINERD 68 IT GRAD	PAUKNER DIANE ELYNNE 4737 PLEASANT PAUL ARNOLD LAWRENCE 1491 HUDSON RD PAUL DEBORAH ANN 1416 ST CLAIR PAUL DENNIS ALBERT PAUL GARY MARTIN PAUL GERALD JOHN 600 27 AVE SO PAUL GREG LEE PAUL HARBHAJAN SINGH PAUL JAMES ELIAS 3637 ROBIN LN PAUL JEAN MIRIAM PAUL JOEL MURRAY 2007 ITASCA AVE PAUL MARGARET FLAGG JA 600 27TH AVE SO PAUL PHYLLIS ELAINE MA 3401 MEDICINE LAKE BLVD PAUL RICHARD JOSEPH 1416 ST CLAIR AVE PAULANA RICHARD JOHN 1227 4TH ST SE PAULAK DAVID JAMES 7333 WENTWORTH AVE SO PAULFRANZ LYNN CAROL 3851 WASHBURN AVE NO PAULING CRAIG JOSEPH 1199 CHARLES AVE PAULL NANCY BETH 1121 UNIVERSITY AVE SE PAULS DAVID L 615 5TH AVE SE PAULSEN CHARLOTTE ANN 6528 CHEROKEE TRAIL PAULSEN DIANE MARIE 4151 OTTAWA AVE SO PAULSEN ERIC LOUIS 305C LANEWOOD NO PAULSEN JAMES HAROLD 925 6TH ST SE PAULSEN KENT AULEM	70 CLA 823-5134 MPL MINNEAPOLIS 70 AGFHE 774-4438 STP ST PAUL 70 CLA 699-4730 STP ST PAUL 69 MORRS 589-4833 APPLETON 68 BUS 68 CLA 339-4092 MPL SAUK CENTRE 68 GC GRAD 71 CLA 938-1179 HOP HOPKINS GRAD 68 CLA 699-9878 STP ST PAUL 68 CLA 339-4092 MPL MINNEAPOLIS GRAD 71 CLA 698-8019 STP ST PAUL 70 CLA 331-3152 MPL ROBBINSDALE 71 CLA 869-1879 RHF RICHFIELD 70 CLA 529-5695 MPL MINNEAPOLIS 70 CLA 644-8440 STP ST PAUL 70 CLA 331-7935 MPL DULUTH GRAD 338-1528 MPL DALLAS OR 71 CLA EDN EDINA 69 ED 922-0796 SLP ST LOUIS PARK 70 CLA 473-8377 MPL MINNEAPOLIS 68 LAW 338-9752 MPL MANKATO 70 IT GRAD 374-5841 MPL 70 CLA 881-8468 MPL BLOOMINGTON 70 IT MPL ROUND LAKE 70 VET M 645-2278 STP
PASCOE MORGAN RANDOLPH 7501 LYNDAL AVE S PASH STEPHANIE JO 1696 ST CLAIR AVE	GRAD 866-4571 RHF EDINA 69 CLA 698-2901 STP ST PAUL	PATTEE ANN MICHELE 5129 MINNAQUA DR PATTEE JOHN ROBERT 5129 MINNAQUA AVE NO PATTEN CHARLES ADRIAN 1921 GREYSOLON RD PATTEN GEORGE LEONARD 313 VINCENT AVE NO	70 CLA 588-9043 GDV GOLDEN VALLEY 71 CLA 588-9043 GDV GOLDEN VALLEY AS DULTH 728-4682 RSVILLE OH GRAD MPL	PAULSEN MARIAN TROUTEN 2405 N 22ND PAULSEN NANCY LOUISE 209 15TH ST E PAULSEN VICTOR KARL 315 19TH AVE SE PAULSON ARLAN PEARY 1623 CARL ST	GRAD 374-5841 MPL 70 CLA 881-8468 MPL BLOOMINGTON 70 IT MPL ROUND LAKE 70 VET M 645-2278 STP

PAULSON BRUCE ALAN AS CLA 699-4496  
2294 STANFORD CT STP ST PAUL  
PAULSON BRUCE ANTHONY 70 IT  
PIONEER HALL MPL DWATONNA  
PAULSON CAROL JEAN 70 CLA 522-1056  
4610 QUEEN AVE N MPL MINNEAPOLIS  
PAULSON DALE GEHARD AS CLA 336-1118  
712 14TH ST MPL  
PAULSON DANIEL ROBERT 71 CLA 227-6270  
1258 MAC ARTHUR WSP WEST ST PAUL  
PAULSON DAVID EVERETT 71 CLA 781-1678  
3515 3RD ST NE MPL MINNEAPOLIS  
PAULSON DOUGLAS JAMES 71 IT 755-1089  
11501 KUMQUAT ST NW CNR COON RAPIDS  
PAULSON DUANE LEON 70 LAW 789-8466  
3432 CLEVELAND ST MPL MINNEAPOLIS  
PAULSON ETHEL MOBROTEN AS CLA 699-4496  
2294 STANFORD CT STP  
PAULSON FRANKIE MAE NI 68 CLA  
521 3RD ST NW  
PAULSON GARY RAYMOND 68 IT 777-6209  
2582 SHORE DR STP ZUMBROTA  
PAULSON GARY WARD 68 GRAD 781-1437  
3533 ARCHITECT AVE NE MPL MINNEAPOLIS  
PAULSON GERALD JAMES 70 IT 537-2907  
6001 69TH AVE N MPL MINNEAPOLIS  
PAULSON JAMES DONALD 69 BUS 373-6509  
6 323 TERRITORIAL HALL MPL SLEEPY EYE  
PAULSON JANICE ANN 69 NURS 331-2474  
621 15TH AVE SE MPL ANOKA  
PAULSON JEFFREY PETER 70 IT  
  
PAULSON JEROME THORFI 69 IT 338-2166  
2020 8TH ST SO MPL CLITHERALL  
PAULSON JOAN MARIE 70 NURS  
POWELL HALL MPL SUNBERG  
PAULSON JOHN RONALD 71 CLA 533-7102  
6804 LOMBARLY LN CVT CRYSTAL  
PAULSON JOHN WILLIAM 70 CLA 929-1270  
5276 LOCHLOY DR EDN EDINA  
PAULSON JON CRAIG 71 DENT 869-7126  
901 E RIVER ROAD MPL RICHFIELD  
PAULSON JON JEREMY 70 VET M 644-1649  
2111 GORDON AVE STP HILLTOP  
PAULSON JON LUVERNE 68 BUS 784-4987  
140 117TH AVE NE MPL MINNEAPOLIS  
PAULSON JUOY ALINA 69 ED 529-2057  
2327 ALDRICH AVE NO MPL MINNEAPOLIS  
PAULSON LEA ELLEN 71 CLA 938-3684  
12922 MELODY LN MTV MINNETONKA  
PAULSON LYNETTE SUSAN 69 GC  
  
PAULSON MARY LOUISE 69 CLA 442-9328  
3816 CHOWEN AVE S MPL MINNEAPOLIS  
PAULSON PATRICIA MARLE 68 CLA 929-1270  
5276 LOCHLOY EDN EDINA  
PAULSON PAUL FREDERICK 71 CLA  
ANOKA  
PAULSON ROBERT JOE 71 MORRS  
MERCHANTS HOTEL ORTONVILLE  
PAULSON ROGER ALAN GRAD 633-8633  
1038 ROBIN LANE NMB MONTEVIDEO  
PAULSON ROGER FRANK 68 CLA 488-9416  
166 NO MCCARRONS BLVD ROV ST PAUL  
PAULSON RONALD FREDERI GRAD 722-6840  
2916 36TH AVE SO MPL JACKSON  
PAULSON SHARON HILLER GRAD 644-3473  
2322 LONG AVE STP UPLAND CA  
PAULSON TERENCE RANDOL 71 CLA 721-3632  
3126 58 ST E MPL MINNEAPOLIS  
PAULSON TWYLA ANN 70 NURS FE9-0931  
SANFORD HALL MPL WALTERS  
PAULSON VICKI LEA 70 CLA  
COMSTOCK HALL  
PAUL BARBARA MARIE 69 DULTH 624-7094  
311 NO 60TH AVE W DULUTH  
PAUL BOYD ROBERT 71 IT  
  
PAULU GARY RICHARD 69 IT 488-7505  
1431 NO AVON ST STP ST PAUL  
PAULU SARAH LEITH 70 CLA 338-0470  
521 19TH AVE SO MPL MINNEAPOLIS  
PAULUCCI MICHAEL JEND AS DULTH RA8-2013  
6 MINNEAPOLIS DULUTH  
PAULUK CYNTHIA DOROTHY 70 AGFHE 647-9870  
1531 CARL ST STP EDEN PRAIRIE  
PAULUK DANIEL JOEL 71 AGFHE 722-5622  
3251 40TH AVE SO MPL MINNEAPOLIS  
PAULUS BRUCE CARL 70 CLA 451-3147  
108 21ST AVE NO SSP SOUTH ST PAUL  
PAULUS CHARLES ANDREW 70 CLA TA2-2044  
4826 PLEASANT AVE SO MPL MINNEAPOLIS  
PAULUS DONALD GARY 69 BUS 588-0442  
1444 TOLEDO NO MPL MINNEAPOLIS  
PAURUS SUSAN MARIE 71 CLA 521-6219  
5138 XERXES AVE NO MPL MINNEAPOLIS  
PAUTZ DONALD GLOVER 70 CLA 645-2050  
1660 SHEDON ST STP ST PAUL  
PAVEK DAVID CHRISTIAN 68 IT 938-5942  
243 BLAKE RD HOP HOPKINS  
PAVEK PATTI LU 68 CLA 331-3398  
25 SEYMOUR AVE SE MPL INTERNAT FALLS  
PAVEK STEPHEN JAMES 69 GC 823-8087  
4825 13TH AVE SO MPL MINNEAPOLIS  
PAVEK WILLIAM MARK 70 CLA 645-3850  
2230 CARTER AVE STP ST PAUL  
PAVELKA JOHN ADELBERT 71 CLA  
HINCKLEY  
  
PAVLICH WERNER 70 CLA  
814 8TH ST SE MPL MINNEAPOLIS  
  
PAVULS MARINA RENATE 68 MEDTC 377-3997  
2644 COLFAX AVE S MPL MINNEAPOLIS  
PAWLACYN CATHERINE FRAN AS CLA 262-3766  
431 PORTLAND AVE STP ST PAUL  
PAWLOWSKI WILLIAM JAME 71 MORRS  
GAY HALL PERHAM  
PAYANT JAMES MICHAEL 70 CLA  
PIONEER HALL MPL WINDOM  
PAYDEN KEITH DUNCAN 69 IT 545-9437  
8924 CEDAR LK RD SLP ST LOUIS PARK  
PAYETTE GERALD WILLIAM 68 DULTH  
16 SO 58TH AVE E DULUTH  
PAYMAR FRIEDA FINEGOLD AS DULTH 724-6504  
223 MYGATT DULUTH  
PAYMAR WENDIE ANNE 71 CLA 699-7492  
1975 BAYARD AVE STP ST PAUL  
PAYMENT JOANN VIRGINE 71 DULTH 834-3110  
PO BOX 44 TWO HARBORS  
PAYNE CHARLES WESLEY 69 GC 339-3312  
915 CHICAGO AVE SO MPL MINNEAPOLIS  
PAYNE DIANE MCCLEARY L GRAD  
1365 EUSTIS STP ST PAUL  
PAYNE EDWARD JAMES GRAD 544-4673  
8005 JONELLEN LANE GOV GOLDEN VALLEY  
PAYNE GREGORY ALLEN 70 AGFHE 647-3712  
BREWSTER HALL STP MONTEVIDEO  
PAYNE GREIG MARVIN 71 CLA  
FRONTIER HALL MPL LAKELAND  
PAYNE JOHN HOWARD 70 IT  
1308 CENTENNIAL MPL ROCHESTER  
PAYNE JUDITH CAROLYN 70 CLA 521-1639  
4030 NO RUSSELL MPL MINNEAPOLIS  
PAYNE ROBERT LYNN 68 IT  
2112 DUPONT AVE SO MPL ROCHESTER  
PAYTON REBECCA JEAN 71 CLA 333-2161  
COMSTOCK HALL MPL SLAYTON  
PAYTON SUSAN ELIZABETH 68 ED 338-1224  
1212 7TH ST S MPL SLAYTON  
PAZANDAK CAROL HENDRIC GRAD  
  
PAZANDAK LOIS LOUISE 69 CLA 545-8921  
2971 SUMTER AVE NO CVT CRYSTAL  
PEABODY ALAN WOODWARD GRAD  
  
PEABODY LAVONA ELAINE 70 CLA  
SANFORD HALL MPL AURORA CO  
PEABODY NANCY JILL 69 ED 926-7197  
4100 ZENITH AVE SO MPL MINNEAPOLIS  
PEABODY STEVEN ROSS 69 GC 869-9414  
7432 UPSON SO RHF RICHFIELD  
PEACH DOUGLAS FREDERIC 68 GC 377-8093  
2546 DUPONT SO MPL  
PEACH GARY RAYMOND 70 IT 866-9562  
6600 COLUMBUS AVE SO RHF RICHFIELD  
PEACH LINDA JANE 71 CLA 561-2166  
7207 NOBLE AVE NO BRC BROOKLYN CENTER  
PEACH MARLIN JOHN 70 DENT 331-1801  
901 E RIVER RD SE MPL DENT  
PEACH SUSAN JOAN 71 CLA  
8716 CREST RD BLT MILACA  
PEACOCK DALLAS BENJAMI 69 IT 377-8731  
2024 PENN AVE SO MPL MILTONA  
PEACOCK SHIRLEY ANN 71 CLA  
801 UNIVERSITY AVE SE MPL MINNEAPOLIS  
PEAKE GRANT BASIL 68 GC 222-4952  
809 DAYTON AVE STP ST PAUL  
PEAKE NANCY MARION 70 AGFHE 781-1496  
1926 ST ANTHONY BLVD NE MPL MINNEAPOLIS  
PEARCE JOHN THOMAS 71 DULTH 724-2789  
2101 E 5 ST DULUTH  
PEARL DANIEL GRAD  
  
PEARLMAN GAIL HARRIET 68 CLA  
  
PEARSALL JOHN CHARLES 70 CLA  
VIRGINIA  
PEARSON ALBERTA RUTH 68 ED 645-7947  
1663 VAN BUREN STP ST PAUL  
PEARSON BARBARA ANN AS CLA 451-0590  
648 4TH AVE SO SSP SOUTH ST PAUL  
PEARSON BLAINE ELDON 69 DULTH  
RT 1 BX 286 CARLTON  
PEARSON BRUCE LEE 69 GC 426-3160  
205 WILWOOD AVE WTB WHITE BEAR LAKE  
PEARSON BRUCE MILTON 68 CLA 631-2012  
2225 NO SNEILING AVE ROV AITKIN  
PEARSON CANDICE JEANNE 69 ED 729-7407  
3432 16TH AVE SO MPL MINNEAPOLIS  
PEARSON CAROLE LINDA 69 MEDTC 373-7149  
W139 COMSTOCK HALL MPL INTERNAT FALLS  
PEARSON DANIEL LYNN 69 CLA 339-7421  
CENTENNIAL HALL  
PEARSON DIANE LEE 68 DULTH 727-5961  
4317 UGSTAT RD DULUTH  
PEARSON DOUGLAS ELWOOD 70 IT 645-5317  
566 DESNOYER AVE STP ST PAUL  
PEARSON FLOYD HILDING GRAD  
  
PEARSON FORD GREGORY 70 CLA KE7-1711  
4308 43RD AVE NO MPL MINNEAPOLIS  
PEARSON GERALD ALBERT 71 CLA  
787 CROMWELL STP ST PAUL  
PEARSON GERALD ALLEN GRAD 929-1491  
2704 LOUISIANA CT SLP VIBURG SD  
PEARSON HAROLD VICTOR 71 MED 522-2932  
821 LOWRY NO MPL DARWIN  
PEARSON HELEN MARIE GRAD  
  
PEARSON JACQUELYNNE BU 69 CLA 561-3465  
7709 NO SIERRA PKWY BRP BROOKLYN PARK  
  
PEARSON JAMES CRAIG 70 CLA  
  
PEARSON JANE MARGARET 71 CLA 722-1882  
5117 18TH AVE SO MPL MINNEAPOLIS  
PEARSON JANET FAYE 71 DULTH 722-6512  
1115 LAKE AVE SO DULUTH  
PEARSON JEAN ELLEN 71 CLA 866-8885  
6604 5TH AVE SO RHF RICHFIELD  
PEARSON JEFFREY EDWARD 69 GC 926-9302  
4544 MEADOW RD EDN EDINA  
PEARSON JEFFREY LYNN GRAD  
  
PEARSON JENNIFER MARY 69 DULTH 724-1858  
201 E BUFFALO ST DULUTH  
PEARSON JOAN MARIE 71 DULTH  
914C 2ND ST E WI  
PEARSON JOANNE MARGARE AS CLA 331-3045  
614 HURON ST SE MPL SHAKOPEE  
PEARSON JUDITH HARVEY 68 ED  
VIRGINIA  
PEARSON KAREN MINETTE 68 DULTH 624-1607  
2812 W 1ST ST DULUTH  
PEARSON KATRLIEN BACIG 68 ED 421-8475  
BOX 353 CHM ST PAUL  
PEARSON KATHRYN LYNN 69 NURS 339-0531  
226 POWELL HALL MPL ST CLOUD  
PEARSON KEITH CONRAD 70 PHARM 429-7361  
3910 STOCKDALE DR WTB WHITE BEAR LAKE  
PEARSON KEITH EDWARD 70 CLA 781-8725  
3412 HARDING ST STA ST ANTHONY  
PEARSON KENNETH DAVID 71 DULTH 525-5560  
5417 ONEIDA ST DULUTH  
PEARSON KENNETH LEROY 69 AGFHE 631-2736  
1615 NO ELDRIDGE AVE STP CAMBRIDGE  
PEARSON LAURELLE KAY AS ED  
  
PEARSON LEON CHARLES 68 IT  
CENTENIAL HALL MPL BENSON  
PEARSON LINDA JEANNE 69 CLA 331-1623  
612 10TH AVE SE MPL RICHFIELD  
PEARSON LINDA LOU 70 CLA  
  
PEARSON LLOYD VERNON 69 DENT 332-1639  
513 ONTARIO ST SE MPL BETHEL  
PEARSON LOWELL KURTIS 71 CLA  
TERRITORIAL HALL MPL LITCHFIELD  
PEARSON MARGIE ANN 69 GC 331-4232  
708 5TH AVE SE MPL MOUND  
PEARSON MARY CHRISTINE GRAD  
516 3RD AVE SE MPL OKLAHOMA CTY OK  
PEARSON MARY ELIZABETH 68 CLA 473-5237  
1301 7TH ST SE MPL WAYZATA  
PEARSON MARY HUGUS JEA 68 ED WEB-2945  
3514 WOODY LANE HOP  
PEARSON MARY KAY 68 CLA 333-7285  
301 10TH AVE SE MPL DETROIT LAKES  
PEARSON PAUL DAVID GRAD 561-7281  
1308 69TH AVE N BRC  
PEARSON PAULA JEANNE 70 DULTH  
CLOQUET  
  
PEARSON PHILIP ROBERT 69 GC 722-8095  
5648 41ST AVE SO MPL MINNEAPOLIS  
PEARSON REBECCA JEAN 69 ED 888-3117  
10916 SHERIDAN AVE SO BLT BLOOMINGTON  
PEARSON RICHARD BRUCE GRAD 788-8982  
3800 MACALASTER DR NE STA  
PEARSON RICHARD JOHN 68 AGFHE  
  
PEARSON RICHARD PETER 69 LAW  
1930 IGLEHART AVE STP WILLMAR  
PEARSON ROGER PAUL 69 GC 827-1823  
5632 BLOOMINGTON MPL MINNEAPOLIS  
PEARSON RONALD JOHN 68 GC  
  
PEARSON SANDRA KAY 71 CLA 452-1629  
2220 PILOT KNOB RD STP ST PAUL  
PEARSON SHERYL KAY 68 AGFHE 645-9241  
BAILEY HALL STP LITCHFIELD  
PEARSON STEVE RAYMOND 71 IT 560-1688  
375 67TH AVE NE FRD FRIDLEY  
PEARSON SUE BOUTIN 69 GC 926-9302  
SANFORD HALL MPL MINNEAPOLIS  
PEARSON THEODORA BEDNA 68 ED 339-3159  
2417 LYNDALE SO MPL MINNEAPOLIS  
PEARSON WALLACE DALE 68 IT 825-1646  
4840 5TH AVE SO MPL MINNEAPOLIS  
PEARSON WAYNE CLIFFORD 68 DULTH 727-4430  
5915 HAINES RD DULUTH  
PEARSON WILLIAM GEORGE 68 IT 429-7361  
3910 STOCKDALE DR STP ST PAUL  
PEARSON YVONNE ELAINE 70 CLA  
RT 1  
PEASE CRESS LEIGH 69 IT 588-7767  
3009 CHOWEN AVE NO ROB ROBBINSDALE  
PEASE DAVID STANLEY 70 MORRS 589-3203  
PINE HALL ATWATER  
PEASE GREGORY JONATHAN 69 CLA  
2601 FREMONT SO MPL MINNEAPOLIS  
PEASE NICKY JAMES 68 MORSC 823-7264  
2730 HENNEPIN AVE S MPL OSAKIS  
PEASE TIMOTHY JOSEPH 70 CLA 633-7088  
2801 14TH ST NW NWB NEW BRIGHTON  
REASLEY DAVID THRODRE 71 CLA 633-1367  
2929 N HARLINE AVE ROV ROSEVILLE  
PEAVEY HARJORIE ANN 70 AGFHE 333-4527  
314 SE 10TH AVE MPL FARBIBAUT  
PECHA DARLENE ROSE 69 DULTH 728-4101  
115 E ARTAVIA ST SOUDAN  
PECK ALISON JANE 68 DULTH 525-2030  
4302 ROBINSON ST DULUTH



PECK CAROL N	AS ED				
PECK CAROLYN JEAN	70 CLA	722-7482			
3149 45TH AVE SO		MPL MINNEAPOLIS			
PECK IRENE MATTSON A	68 MORRS				
		HERMAN			
PECK MICHAEL JOHN	68 GC				
PECK MICHAEL TERRY	68 CLA	222-3559			
676 GODDRICH AVE		STP ST PAUL			
PECK ROBERT STEPHEN	69 IT				
940 FRANKLIN TERR		MPL MANITOWOC WI			
PECK TERRY DALE	68 GC	824-4425			
5026 NICOLLET SO		MPL MINNEAPOLIS			
PECK THOMAS RICHARD	71 IT				
TERRITORIAL HALL		MPL WORTHINGTON			
PECK WANDA	71 AGFHE	644-2031			
2248 CARTER AVE		STP MINNETONKA			
PEDELISKI ALINA SCHARR	70 AGFHE	645-1165			
1855 W LARPENDEUR		FLH			
PEDELY CAROL LOUISE	70 AGFHE	339-0531			
POWELL HALL		MPL MADEIRA			
PEDERSEN BJARNE HERMOD	68 GC	335-6077			
129 4TH ST SE		MPL MINNEAPOLIS			
PEDERSEN BRUCE JOHN	69 CLA	722-4302			
5428 28TH AVE SO		MPL MINNEAPOLIS			
PEDERSEN DAVID ARTHUR	69 GC	722-4302			
5428 28TH AVE SO		MPL MINNEAPOLIS			
PEDERSEN DEAN RUSSELL	70 IT	699-8747			
2033 KNAPP		STP HARLAN IA			
PEDERSEN DONALD EDWARD	70 IT	699-8747			
2131 JUNO		STP ST PAUL			
PEDERSEN ELWOOD CHRIST	68 GC	FR7-7971			
1820 IRVING S		MPL MINNEAPOLIS			
PEDERSEN JAMES PHILIP	68 CLA	VA9-4275			
3806 UPTON AVE ND		MPL MINNEAPOLIS			
PEDERSEN JANE PATRICIA	71 CLA	455-5473			
155 11 AVE SO		SSP SOUTH ST PAUL			
PEDERSEN JOHN RANDOLPH		GRAD			
PEDERSEN JOYCE ANN	71 CLA	822-5834			
3525 COLUMBUS AVE SO		MPL MINNEAPOLIS			
PEDERSEN KATHRYN ANNE	69 ED	881-8133			
1000 5TH ST SE		MPL BLOOMINGTON			
PEDERSEN KENNETH GEORG	68 GC	881-8138			
10201 E BLOOM FRWY		BLT BLOOMINGTON			
PEDERSEN MARY KAY	69 DULTH	724-0964			
2419 E 2ND ST		DULUTH			
PEDERSEN NANCY MARIE	69 GC	722-4302			
5428 28TH AVE SO		MPL MINNEAPOLIS			
PEDERSEN ROBERT CHARLE	68 GC	721-3477			
5543 28TH AVE SO		MPL			
PEDERSEN STEVEN WAYNE	69 CLA	331-7644			
1829 UNIVERSITY SE		MPL AITKIN			
PEDERSON CAROL ANN	71 AGFHE				
BAILEY HALL		STP AMBOY			
PEDERSON CHARLES EDWAR	69 CLA	724-6813			
3306 MINNEHAWA AVE SO		MPL HARMONY			
PEDERSON CLIFTON MERLY	70 CLA	729-1917			
5316 47TH AVE SO		MPL MINNEAPOLIS			
PEDERSON DAVID JOHN	70 CLA				
1725 UNIVERSITY SE		MPL HASTINGS			
PEDERSON DAVID ROBERT	69 PHARM	331-2314			
805 E RIVER RD		MPL DULUTH			
PEDERSON DAV9D LEE		GRAD 331-8688			
1414 6TH ST SE		MPL SCARVILLE IA			
PEDERSON DENNIS CLAIRE	71 IT				
FRONTIER HALL		MPL MONTEVIDEO			
PEDERSON DENNIS DEAN	69 MORRS	842-6661			
608 12TH ST N		BENSON			
PEDERSON DIANE LOUISE		GRAD 331-8688			
1414 6TH ST SE		MPL BRIGELYN			
PEDERSON DOROTHY ASLAK	AS MORRS	843-2663			
RT BOX 158		STARBUCK			
PEDERSON DOUGLAS ROGER	70 DULTH	724-6456			
17 N 18TH AVE E		ALEXANDRIA			
PEDERSON GARY JAMES	69 DULTH	724-6030			
2307 E SUPERIOR ST		BENSON			
PEDERSON GARY THEODORE	68 DENT	PA2-1886			
3026 39TH AVE SO		MPL MINNEAPOLIS			
PEDERSON GARY WAYNE	70 CLA	729-7242			
3314 15TH AVE SO		MPL MINNEAPOLIS			
PEDERSON JANET MARIE	71 AGFHE	824-0306			
3210 CHICAGO AVE SO		MPL HECTOR			
PEDERSON JEFFERY GUNNA	71 CLA				
		MPL HALLOCK			
PEDERSON KAREN ELLEN	71 DULTH	628-1760			
705 S JGSTAD RD		PROCTOR			
PEDERSON KAREN LESLIE	71 CLA	938-6448			
4446 GAYWOOD DR		HOP HOPKINS			
PEDERSON KATHLEEN SUSAN	71 DULTH	724-8400			
1332 E 6TH ST		GRAND MARAIS			
PEDERSON KEITH DUANE	69 DULTH				
BEARDSLEY		BEARDSLEY			
PEDERSON KENNETH WAYNE	69 DULTH				
1419 WAVERLY		HASTINGS			
PEDERSON LEROY JAMES	AS AGFHE	646-0600			
2309 PRISCILLA ST		STP			
PEDERSON MARGARET MOLB		GRAD 338-7083			
2320 BUTLER PLACE		MPL			
PEDERSON MERRILEE	68 OT	588-2468			
2720 FRANCE ND		ROB ROBBINSDALE			
PEDERSON HICKEY RAY	70 CLA	788-2918			
4550 CENTRAL		CLH MINNEAPOLIS			
PEDERSON PATRICIA ANN	69 AGFHE	338-3341			
318 8TH AVE SE APT 106		MPL ST PAUL			
PEDERSON PAUL DANIEL	AS PH				
1920 SHRYER W		ROV MINNEAPOLIS			
PEDERSON PEDER LANCE	70 DULTH				
202 LEWIS ST		DENT			
PEDERSON RANDALL STEPH	71 CLA	722-0541			
3953 23RD AVE SO		MPL MINNEAPOLIS			
PEDERSON RITA CHRISTIA	70 MORRS	634-3180			
110 SE 6TH ST		GLENWOOD			
PEDERSON RONALD ALAN	71 CLA				
TERRITORIAL HALL		MPL ORTONVILLE			
PEDERSON RONALD GENE	70 CLA	432-5445			
200 WALNUT LANE		ROS ROSEMOUNT			
PEDERSON RUTH LOUISE	68 ED	339-0531			
POWELL HALL		MPL MCINTOSH			
PEDERSON TERENCE RANDA	69 GC	771-7353			
1156 PACIFIC ST		STP ST PAUL			
PEDERSON WAYNE ALLAN	69 CLA				
1321 6TH ST SE		MPL FERTILE			
PEDGINSKI JAMES JOSEPH	69 IT	735-8362			
CENTENNIAL HALL		MPL MOUNTAIN IRON			
PEDNEAU KATHRYN ANN	68 AGFHE				
PEEK CAROL JOAN	69 DULTH	728-1439			
RT 4 BOX 562A		DULUTH			
PEEK DIANNE SUSAN	70 DULTH	724-5377			
912 N 10TH AVE E		AITKIN			
PEEK ROLAND MANLEY		GRAD			
PEER THOMAS BRUCE	71 DULTH	525-3106			
4822 OAKLEY ST		DULUTH			
PEPPER GEORGE EDWIN	71 CLA	824-3563			
2809 IRVING AVE SO		MPL MINNEAPOLIS			
PEPPER JEAN ELOISE	69 ED	429-7570			
		MPL WHITE BEAR LAKE			
PEPPER JOHN CARLETON	69 IT	TA4-3563			
2809 IRVING SO		MPL MINNEAPOLIS			
PEGELOW CHARLES HENRY	70 MED	331-8237			
631 OAK ST SE		MPL SACRED HEART			
PEGG ROGER CHARLES	70 AGFHE	TA9-3265			
3947 4TH ST N		MPL MINNEAPOLIS			
PEGORS DOUGLAS EARL	70 IT	881-8976			
8921 15TH AVE SO		BLT BLOOMINGTON			
PEHL RALPH RODNEY	68 DULTH	722-1385			
3821 STEBNER RD		DULUTH			
PEHL ROGER RUSSELL	69 DULTH	722-4385			
3821 STEBNER RD		DULUTH			
PEHLING CYNTHIA SUE	71 CLA	560-4772			
5231 7TH ST SE		CLH COLUMBIA HTS			
PEHRSON DAVID WADE	68 BUS	588-6865			
3606 ABBOTT AVE ND		ROB ROBBINSDALE			
PEHRSON PATRICIA ANN	69 AGFHE	869-9184			
7530 OLIVER AVE SO		RHF RICHFIELD			
PEICKERT LEROY MARVIN	70 CLA				
1217 FIFIELD ST		STP WHEATON			
PEIFFER ROBERT LOUIS J	71 VET M	947-4356			
BREWSTER HALL		STP EDINA			
PEIK MARNA LOUISE	70 CLA				
401 11TH AVE SE		MPL MINNEAPOLIS			
PEIJPPO JOANNE MARGARET	70 DULTH	724-9832			
GRIGGS HALL N116		FLOODWOOD			
PEISERICH RICHARD PAUL		GRAD			
PEISERT ARTHUR FRANK	69 IT	771-9732			
1713 E IVY		STP ST PAUL			
PEISSIG ARLAN HARRY	69 GC	739-1762			
953 N CENTURY AVE		MPW MINNEAPOLIS			
PEKAREK EUGENE ANTHONY	70 IT	373-6641			
2-182 TERRITORIAL HALL		MPL ROYALTON			
PEKAREK KENNETH DUWAYN	69 CLA	771-4420			
260 N PT DOUGLAS RD		STP ST PAUL			
PEKAREK ROGER WILLIAM	70 IT	331-2920			
1015 23RD AVE SE		MPL ROYALTON			
PELCL GARY LEE	70 CLA	938-3007			
701 15TH AVE SE		MPL HOPKINS			
PELECIS RODITE ILZE	70 CLA	824-6600			
5308 11TH AVE SO		MPL MINNEAPOLIS			
PELHAM JILL CAROL	69 ED	561-3028			
1203 77TH AVE ND		MPL MINNEAPOLIS			
PELLISSIER JAMES LYNN	68 ED				
CENTENNIAL HALL		MPL ST CLOUD			
PELKEY DONALD HERBERT	68 CLA	825-7738			
3716 GARFIELD AVE SO		MPL			
PELL THOMAS MICHAEL JR		GRAD			
PELLER LAVONNE MAE	68 ED	646-5045			
1628 DAYTON AVE		STP ST PAUL			
PELLER MARGARET ANNE	70 CLA				
325 6TH AVE SE		MPL EXCELSIOR			
PELLETIER MARC ACKER	69 CLA	633-2755			
2910 SHELDON AVE N		ROV ROSEVILLE			
PELLETIER RENE WILLIAM		GRAD			
PELLETT CHERYL LYLENE	69 DENHY				
SANFORD HALL		MPL GREAT FALLS MT			
PELLIKA RICHARD JOHN	69 CLA	824-0240			
2525 PILLSBURY AVE SO		MPL CHISHOLM			
PELLMAN CHARLENE KAY	71 DULTH	728-7868			
1236 BRAINERD AVE		TWO HARBORS			
PELLMAN JAMES CARL	69 DULTH	728-1678			
1204 KENWOOD AVE		TWO HARBORS			
PELLMAN LORA LEE	70 DULTH	728-4348			
1801 E 6TH ST		TWO HARBORS			
PELO DANNY CRAIG	69 CLA				
PELOFSKE GERALD WILLIA	70 DULTH	879-7257			
511 SLATE ST		CLOQUET			
PELOFSKE SUZZANE MAE	71 DULTH	722-4853			
1018 N 5 AVE E		FLOODWOOD			
PELOQUIN THOMAS CARM	71 DULTH	724-9849			
GRIGGS HALL C315		ELK RIVER			
PELOWSKI ALLAN LEROY	68 CLA				
CENTENNIAL HALL		MPL ROSEAU			
PELOZA CASIMIR CHARLES	70 CLA	888-0363			
10550 LYNDAL AVE SO		BLT NEW BRIGHTON			
PELTEKOS DIANE MATHILD	70 CLA				
PELTIER ARCHIE RAYMOND	70 CLA	429-7619			
921 4TH ST		STP ST PAUL			
PELTIER GEORGE ANTHONY	69 CLA	771-1009			
746 E HYACINTH AVE		STP ST PAUL			
PELTIER ROGER THOMAS	69 IT	633-1888			
1469 LONG LAKE RD		NWB NEW BRIGHTON			
PELTIER RONALD JAMES	71 CLA	771-1009			
746 E HYACINTH		STP ST PAUL			
PELTIER WILLIAM FRANCI	68 GC	645-3390			
1398 BREDA		STP			
PELTO JEAN STRUTHERS	AS ED				
PELTO MICHAEL WARREN	68 DULTH	724-1328			
1724 E 8TH ST		ELY			
PELTO RICHARD DEVIN	69 DULTH	722-0107			
123 N 26TH AVE W		DULUTH			
PELTON GREGORY ALAN					

PEPLINSKI MARY ELIZABE 71 DULTH 525-1374 5731 GLENWOOD ST DULUTH	PERRIN BRUCE ALAN 71 CLA 474-9494 RT 4 SUNRISE HILLS EXC EXCELSIOR	PERTTULA KATHLEEN JUNT 68 DULTH 879-3853 BOX 333 ESKO
PEPLINSKI RAYMOND MICH 69 DULTH 525-1374 5731 GLENWOOD ST DULUTH	PERRIN DUANE ALLEN 525 UNIVERSITY AVE SE MPL	PERUSHEK LUDWIG JOHN 70 DULTH 525-1784 ROUTE 3 BOX 665 DULUTH
PEPLINSKI THOMAS PETER 69 ED 774-3995 1188 C HAZELWOOD STP ST PAUL	PERRIN JOHN DOUGLAS GRIGGS HALL C313 ST PAUL	PESCI MICHAEL LINDEN 1507 80TH ST E BLT ST PAUL
PEPLINSKI TIMOTHY PAUL 68 CLA 774-3995 1188 C HAZELWOOD STP ST PAUL	PERRIN KATHRYN KORTSCH 525 UNIVERSITY AVE SE AS CLA 335-3421	PESCI PATRICIA SUZANNE 1507 E 80TH ST BLT TULSA OK
PEPPARD DAVID GORDON 70 CLA 926-8747 4145 TOLEDO AVE S SLP ST LOUIS PARK	PERRIN RICHARD PAUL 633 LINCOLN STP ST PAUL	PESEK RONALD WILLIAM 70 AGFHE 645-7608 1623 CARL ST APT 8B STP TAUNTON
PEPPEL JEFFREY JOHN 70 IT 501 5TH ST SE MPL HECTOR	PERRINE CHARLES JOHN 5929 PENN AVE SO MPL MINNEAPOLIS	PESEK WILLIAM BENEDICT 68 AGFHE 645-9970 2232 HILLSIDE AVE STP MINNEOTA
PERAZZO PATRICIA VERON 70 CLA 377-9732 2617 FREMONT AVE SO MPL ARGENTINA	PERRINE RICHARD LEE DETROIT LAKES 70 CLA 847-5863	PESHECK LINDA LEE 69 DULTH 724-2297 1718 E 8TH ST ASKOV
PERBIX LUCIA ADELE 70 CLA 941-3611 6421 MILDRED AVE EDN EDINA	PERRIZO THOMAS JOHN 2417 PLEASANT AVE SO MPL BENSON	PESHECK PETER SCOTT 68 DULTH 724-3198 922 CHESTER PARK DR ASKOV
PERBIX ROBERT AUSTIN 69 IT 941-3611 6421 MILDRED AVE EDN	PERRIZO WILLIAM KNUTE 201 MELBORNE SE MPL NORWOOD	PESHINA SHIRLEY MAE 68 CLA 331-6157 618 15TH AVE SE MPL MINNEAPOLIS
PERCIVAL CHARLES THOMA 69 CLA 929-4473 2816 ALABAMA AVE SLP ST LOUIS PARK	PERRON MARY MARGARET PIONEER COURT 68 GC	PESOLA CAROL K POHJOLA 68 ED 633-5369 3281 NW 16TH ST NWB
PERCIVAL PATRICIA MARI 70 CLA 339-0531 POWELL HALL MPL SEBEKA	PERRONE JOHN JOSEPH CENTENNIAL HALL MPL HAVERHILL MA	PESTORIOUS ROGER JAMES 69 AGFHE ALBERT LEA
PERELSTEIN ELIZABETH A 70 CLA 699-2961 1687 HIGHLAND PKWY STP ST PAUL	PERROZZI GAIL SUSAN 4007 SHORELINE DR 71 CLA 784-7434	PETAJA EILEEN MAE 70 DULTH 728-1058 RT 4 BX 519 DULUTH
PEREY DANIEL YVES EMIL 70 AGFHE 827-1874 3357 IRVING SO MPL	PERRUZZI KAREN JEAN 8043 WASH ST NE MPL MINNEAPOLIS	PETEFISH LARRY EVERETT 69 AGFHE
PERHAI RONALD ALAN 71 CLA FRONTIER HALL MPL HASTINGS	PERRY ALAN ROY 4412 CHOWEN SO MPL MINNEAPOLIS	PETEFISH RICHARD DARWI 71 AGFHE 374-6866 BAILY STP DODGE CENTER
PERIA JOY THERESA 71 CLA 935-1331 5932 TAMARAC AVE EDN EDINA	PERRY BARBARA ELAINE 69 BUS	PETER CARROLL EUGENE GRAD
PERINBANAYAGAM ROBERT GRAD	PERRY DAVID JOHN 23 1/2 E ROSE AVE STP ST PAUL	PETER ELIZABETH FRANCE 69 GC 699-6871 1720 COLVIN STP ST PAUL
PERKINS BRUCE CHARLES 69 BUS 645-6851 2203 W HOYT AVE STP ST PAUL	PERRY DAVID MARTIN 1475 WYNNIE AVE STP DES MOINES IA	PETER SARAH JEAN 70 CLA 834 THORNTON SE MPL CANNON FALLS
PERKINS CHERYL MARIE 71 CLA 529-2239 1218 QUEEN AVE NO MPL MINNEAPOLIS	PERRY DENISE CAROLINE 3027 36TH AVE SO MPL MINNEAPOLIS	PETERBURS LOREN JOSEPH GRAD
PERKINS CONNIE BELLE 68 GC 724-9057 3132 39TH AVE SO MPL MINNEAPOLIS	PERRY DOUGLAS DUANE 2826 GIRARD AVE NO MPL MINNEAPOLIS	PETERKA MARGIE MARIE 71 DULTH 727-6637 914 E 2 ST COOK
PERKINS DAVID EUGENE 69 IT CENTENIAL HALL MPL ST CLOUD	PERRY EARL ARTHUR 70 DULTH	PETERKA MARK JOSEPH 71 IT MPL AURORA
PERKINS DAVID EUGENE 68 GC 331-4959 615 15TH AVE SE MPL MINNEAPOLIS	PERRY EDWIN MURRAY 1921 CARROLL AVE STP MOSSLEY	PETERKA MARY JO 70 CLA 699-3037 1914 ROME AVE STP ST PAUL
PERKINS DONNA LEE 70 AGFHE	PERRY ELAINE KRISTEN 1674 STANFORD AVE STP ST PAUL	PETERKA RICHARD EMIL 71 IT BAILEY HALL STP MONTGOMERY
PERKINS ELAINE GERTRUD AS ED	PERRY ELIZABETH HALL 68 GC	PETERMAN ALAN LEW 70 IT 544-1841 9311 W FRANKLIN AVE SLP ST LOUIS PARK
PERKINS ELIZABETH BLY 70 CLA 938-6949 14003 ROYAL COURT MTV MINNETONKA	PERRY JACKQUILINE MARI 69 GC	PETERS BERNARD ALBERT 150 S FAIRVIEW WSP ST PAUL
PERKINS GARFIELD GRANT 69 GC 3132 39TH AVE SO MPL MINNEAPOLIS	PERRY JAMES HUGH 5 BROOK APPLETON	PETERS CARL BRICKER 810 HALLAM MAH
PERKINS GAYLE ELAINE 69 CLA 529-4720 1218 QUEEN AVE NO MPL MINNEAPOLIS	PERRY JAMES SCOTT CENTENNIAL HALL MPL SHAKOPEE	PETERS CAROL JEAN 71 AGFHE 774-9814 1622 CHAMBER ST STP ST PAUL
PERKINS GAYLE ELAINE 69 CLA 529-4720 1218 QUEEN AVE NO MPL MINNEAPOLIS	PERRY JOANNE MARGARET 801 UNIVERSITY AVE SE MPL MINNEAPOLIS	PETERS GEORGE THOMAS 620 MADISON ST NE MPL
PERKINS GERALD FRANK 71 CLA 331-1067 318 LINCOLN ST NE MPL ROCHESTER	PERRY JONATHAN WORDEN CENTENNIAL HALL MPL CALDWELL ID	PETERS GERALD DONAVON 68 IT 646-8279 2030 BREWSTER STP MINNEAPOLIS
PERKINS LINDA CAROL 71 CLA 822-5907 5025 ALDRICH AVE SO MPL MINNEAPOLIS	PERRY LOWELL EVERETT 2128 FRY ST STP ST CLOUD	PETERS GREGORY JOSEPH 69 GC 645-1068 STP ST PAUL
PERKINS MARYLYN THACKE 68 CLA RT 1 BOX 631 EXC	PERRY MARCIA K 708 5TH ST SE MPL SHAKOPEE	PETERS JOHN DAVID AS PH
PERKINS MICHAEL JAMES 68 CLA 331-9403 1724 ROLLINS AVE SE MPL HOPKINS	PERRY MARTHA MARY 331 LONGVIEW TERR MPL MINNEAPOLIS	PETERS JOHN RICHARD 69 IT 771-7365 968 E ORANGE AVE STP ST PAUL
PERKINS MICHELE EDNA 71 CLA 824-6141 4337 DUPONT SO MPL MINNEAPOLIS	PERRY MAUREEN JUDITH 4025 ERIE ST SE MPL ALBERT LEA	PETERS JOSEPH EDWARD 71 CLA 724-3209 5624 36TH AVE SO MPL MINNEAPOLIS
PERKINS OBION AS GC 1349 UPTON AVE NO MPL CHICAGO IL	PERRY MICHAEL FRANK 5636 IRVING MPL MINNEAPOLIS	PETERS JOYCE ANN 71 CLA 224-6180 864 SUMMIT STP ST PAUL
PERKINS REBECCA JEAN 70 CLA 331-3076 305 WALNUT ST MPL HOPKINS	PERRY RICHARD LOUIS 331 LONGVIEW TERR MPL MINNEAPOLIS	PETERS KEITH WILLIAM 68 GC 455-5453 4055 59TH ST E ING INVER GROVE
PERKINS ROBERT ALLEN 71 CLA FRONTIER MPL MINNETONKA	PERRY RICHARD LOYD 3116 FLORIDA AVE SO SLP ST LOUIS PARK	PETERS LOUIS HENRY GRAD
PERKINS ROBERT DALE 69 IT 1015 ESSEX SE MPL DULUTH	PERRY SUSAN MARIE 5100 VALLEY VIEW RD EDN EDINA	PETERS MARK STEPHEN 70 CLA 588-8650 4317 ZENITH AVE NO ROB ROBBINSDALE
PERKINS RUTHANNE 70 AGFHE 698-5052 1897 WORDSWORTH AVE STP ST PAUL	PERSCH MABEL HOGBERG M 4625 W 5TH ST DULUTH	PETERS MARY MARGARET POWELL HALL MPL WHITE BEAR LAKE
PERKINS SUSAN JANE 70 CLA 226-8143 680 ARCADIA STP ST PAUL	PERSCHAU DANIEL FREDRI GLENVIEW WOODS 70 CLA	PETERS RICHARD EMIL 70 CLA 774-9814 1622 CHAMBER ST STP ST PAUL
PERKINS SUSAN JILL 71 DULTH 724-9873 BURNTSIDE HALL 121 NASHWAUK	PERSCHAU RICHARD ALAN 403 LAKE ST EXC GLENCOE	PETERS ROBERT ALAN 69 CLA 774-9814 1622 CHAMBER ST STP ST PAUL
PERKINS THOMAS RAYMOND 71 IT TERRITORIAL HALL MPL RED WING	PERSCHAUW DANIEL FREDRI GLENVIEW WOODS 70 CLA	PETERS ROBERT DARVIN 68 VET M 644-0987 1203 FIFIELD STP ST ANSGAR IL
PERKOVICH PAULA ELAINE 70 DULTH 724-9978 GRIGGS HALL K212 CHISHOLM	PERSCHAUW RICHARD ALAN 403 LAKE ST EXC GLENCOE	PETERS WILLIAM HAROLD 68 GC PA2-7263 3222 17TH AVE SO MPL MINNEAPOLIS
PERKOVICH PAULETTE EIR 70 DULTH 724-9978 GRIGGS HALL K212 CHISHOLM	PERSCHMANN ROBERT HENR 8009 14TH AVE SO BLT BLOOMINGTON	PETERSBURG SANDRA JANE GRAD
PERL ROBBIE NAN 71 CLA 926-4188 2240 DREW AVE S SLP ST LOUIS PARK	PERSCHMANN THOMAS ALLE 8009 14TH AVE SO BLT BLOOMINGTON	PETERSEN ARLENE KAREN 71 CLA 1844 CARL ST LRD LAUDERDALE
PERLICH DAVID GORDON 68 GC 699-4785 1362 GOODRICH STP ST PAUL	PERSINGER MARY JANE 923 21ST AVE SO MPL FAIRMONT	PETERSEN BRUCE L 71 CLA 3045 SHOREWOOD LANE STP ST PAUL
PERLICH JAMES ROBERT 68 IT 489-5802 1038 W MONTANA STP ST PAUL	PERSON ANNETTE 4601 30TH AVE SO MPL MINNEAPOLIS	PETERSEN CARLENE ANN 71 DULTH 724-9914 BURNTSIDE HALL 112 KNIFE RIVER
PERLICK DOUGLAS BERNAR AS IT	PERSON JENNIFER JO 3407 JAMES NO MPL MINNEAPOLIS	PETERSEN CHARLES MONTE 69 BUS 579-9695 2922 ARMOUR TER STA ST ANTHONY
PERLMAN EDWARD HENRY AS GC 544-5730 7909 W 26TH ST SLP	PERSON MARYLYN DIANE 6012 ALDRICH NO MPL MINNEAPOLIS	PETERSEN CHERYL MAUREE 71 CLA 488-5703 1780 ADDLPHUS AVE ROV ROSEVILLE
PERLMAN STEPHEN MAX 68 CLA 825-7112 5057 GLADSTONE AVE SO MPL MINNEAPOLIS	PERSON PEGGY LYNN 1764 E IVY AVE STP ST PAUL	PETERSEN CONSTANCE DIA 71 CLA 454-1053 ROSEMOUNT
PERLMAN STEVEN RAY 69 BUS	PERSON RICHARD ARTHUR 4201 WEBSTER AVE SLP ST LOUIS PARK	PETERSEN CORRINE BECKM 68 ED 459-3643 6817 HILLSIDE LANE SPP
PERMAN BRUCE DAVID 69 GC 2108 CLINTON AVE SO MPL ZIMMERMAN	PERSON ROBERT CHARLES 8901 CEDAR AVE MPL BLOOMINGTON	PETERSEN DANE BRYAN 70 CLA
PERMUT CALVIN FRED 69 CLA 529-6908 1205 LOGAN NO MPL MINNEAPOLIS	PERSON RONALD ALLEN 9706 14 AVE SO AGFHE TUI-8361	PETERSEN DOROTHY LEONE 70 CLA 789-9695 2922 ARMOUR TER NE STA ST ANTHONY
PERNULA JUDITH RENELL 71 CLA 545-6750 2549 CEDAR CROWN DRIVE HOP HOPKINS	PERSONEN ROBERT GERALD FRONTIER HALL MPL KALISPELL MT	PETERSEN ELSIE BAADSGA 68 ED 784-9195 BOX 1 CRP
PERRAUD MICHAEL EDWAR 68 CLA MPL	PERSONS JAMES GEORGE 27 E 6TH ST DULUTH	PETERSEN ERNEST HOWARD 68 AGFHE 646-4780 2060 CARTER AVE STP RUSH CITY
PERRAULT STEPHEN MARK 71 CLA 484-5286 329 LILAC LANE SHV SHOREVIEW	PERSONS SHIRLEY JEANNE 612 10TH AVE SE MPL ST CHARLES	PETERSEN GARY LEE 69 CLA 373-6509 6 323 TERRITORIAL HALL MPL SLBEPY EYE
PERRELLI W VINCENT 68 MED 690-1179 2171 GRAND AVE STP	PERSSON CURTIS EDWARD 2947 BROOK ST NSP NORTH ST PAUL	
PERRETEN MICHAEL JONAT 69 CLA 331-7673 814 8TH ST SE MPL NELSON	PERSSON MICHAEL ALLEN 115 MINNEAPOLIS AVE CHISHOLM	
	PERTLER GARY DUANE 265 NORTHDAL BLVD NW GRAD 757-4908 CNR CLOQUET	

PETERSEN GERALD ROBERT 68 ED 451-7091  
240 9TH AVE SO SSP SOUTH ST PAUL  
PETERSEN HARLAN DENNIS GRAD 645-3527  
1486 W LARPEUR FLH LUCK WI  
PETERSEN JAN FAREL ILL 71 DULTH 724-9813  
GRIGGS HALL C211 SILVER BAY  
PETERSEN JANICE MARIE 70 CLA 545-7707  
11021 HILLSIDE LANE MTV MINNETONKA  
PETERSEN JANNA MARIE 68 GC 935-1878  
5200 WILLISTON RD MTV MINNETONKA  
PETERSEN JEAN ANGELA 69 GC

PETERSEN JEAN MARIE 71 DULTH 525-1375  
4320 PITT ST DULUTH  
PETERSEN JEAN PAIGE 69 ED 335-4196  
1026 5TH ST SE MPL ST PAUL  
PETERSEN JERRY ROBERT 71 MED 331-2626  
837 23RD AVE SE MPL MINNEAPOLIS  
PETERSEN JOHN FREDRIC 68 VET M 724-3038  
3665 34TH AVE SO MPL MINNEAPOLIS  
PETERSEN KARL M 70 CLA MINNEAPOLIS

PETERSEN KATHLEEN JO 71 CLA 890-4423  
1556 CIRCLE DR  
PETERSEN KATHRYN ANNE 71 CLA 225-7090  
161 W KING ST STP ST PAUL  
PETERSEN KRISTIN ELIZA 69 GC 454-4262  
2871 HIGHVIEW TERRACE STP ST PAUL  
PETERSEN LARRY STEVEN 69 IT  
1327 7TH ST SE MPL ALBERT LEA  
PETERSEN LELAND ROBERT 71 CLA 869-4085  
6636 VINCENT AVE SO RHF RICHFIELD  
PETERSEN LINDA LOU 70 CLA 789-1268  
687 24TH AVE NE MPL MARSHALL  
PETERSEN LINDA MARIE 70 CLA 929-4109  
5912 CODE AVE SO EDM EDINA  
PETERSEN MARGARET SUSAN 68 GC 521-4034  
1315 17TH AVE NO MPL MINNEAPOLIS  
PETERSEN MORRIS EUGENE 70 MORRS 589-1922  
803 OREGON AVE

PETERSEN NANCY ELIZABE 71 CLA 646-0656  
1665 DAYTON AVE STP ST PAUL  
PETERSEN PAMELA JEANNE 68 ED WA6-0371  
5816 SHERIDAN SO MPL MINNEAPOLIS  
PETERSEN ROSS TERRILL 68 CLA 822-9390  
3116 GIRARD AVE S MPL MINNEAPOLIS  
PETERSEN SCOTT CHARLES 71 CLA 225-7792  
1084 ST CLAIR STP ST PAUL  
PETERSEN STEPHANIE LYN 71 CLA  
18800 LYNDALE LKV MINNEAPOLIS  
PETERSEN STEPHEN HENRY 70 CLA 451-8578  
427 17TH AVE NO SSP SOUTH ST PAUL  
PETERSEN SUZANNE MARIE 69 CLA 331-4529  
810 8TH ST SE MPL MINNEAPOLIS  
PETERSEN THOMAS DAVID 70 CLA 929-3539  
2809 COLORADO SLP ST LOUIS PARK  
PETERSEN WESLEY PAUL GRAD 331-4232  
708 5TH ST SE MPL BOZEMAN MT  
PETERSEN WILLIAM EDWARD 70 DENT 225-7792  
1084 ST CLAIR STP ST PAUL  
PETERSEN ALAN LEE 70 DULTH 724-8959  
517 NO 17TH AVE E DULUTH  
PETERSEN ALAN STEWART 71 IT  
1107 7TH ST SE MPL LINDSTROM  
PETERSEN ALLAN CARL 68 VET M 645-8713  
1361 CLEVELAND AVE STP BRANDON  
PETERSEN ALLEN LELAND 70 MED 331-1369  
632 ONTARIO ST SE MPL MINNEAPOLIS  
PETERSEN ALLEN WILLARD 68 DULTH 724-0696  
108 MORLEY PKWY DULUTH  
PETERSEN ANDREW ALBERT 69 VET M 646-3196  
1505 CLEVELAND AVE N STP HUNTER ND  
PETERSEN ANN ELIZABETH 69 ED  
4804 COLUMBUS MPL MINNEAPOLIS  
PETERSEN ARMAND GENE 70 IT 332-5076  
2000 SHARON AVE SE MPL  
PETERSEN BARBARA ANN 70 CLA 335-7172  
2022 SO 5TH ST MPL ST PAUL  
PETERSEN BARBARA ANN 71 DULTH 724-9938  
GRIGGS HALL L314 INTERNAT FALLS  
PETERSEN BARBARA JEAN 70 AGFHE 722-2124  
3512 46TH AVE SO MPL MINNEAPOLIS  
PETERSEN BARBARA JO 69 DENNY 771-9253  
1951 W KENNWOOD DR MPW MAPLEWOOD  
PETERSEN BARBARA MARIE 68 ED UN9-6018  
2010 S 7TH ST MPL MINNEAPOLIS  
PETERSEN BARBARA PEARS 71 DULTH 724-8931  
2025 E 8 ST DULUTH  
PETERSEN BARRY LEE 69 DULTH 724-6693  
901 GRANDVIEW AVE GRAND RAPIDS  
PETERSEN BARRY LEE 68 CLA 745-5884  
3141 COLFAX AVE SO MPL MINNEAPOLIS  
PETERSEN BETTE LOU 70 DULTH 722-6923  
226 W ORANGE ST DULUTH  
PETERSEN BONITA CATHER 71 DULTH 727-6636  
914 E 2ND ST DULUTH  
PETERSEN BONNIE JOANNE 71 DULTH 624-7113  
9107 SKYLINE PKWY DULUTH  
PETERSEN BONNIE MARIE 70 NURS 735-2160  
820 LAKE ST STP ST PAUL  
PETERSEN BRADFORD JOHN 69 IT 938-7819  
11831 PHEASANT LN MTV MINNETONKA  
PETERSEN BRADLEY CHARL 71 CLA 336-4133  
1527 E RIVER TERR SE MPL MINNEAPOLIS  
PETERSEN BRADLEY JON 69 GC 881-7246  
9113 EMERSON AVE SO BLT BLOOMINGTON  
PETERSEN BRIAN LEE 71 DULTH  
2001 E 4TH ST FINLAYSON  
PETERSEN BRUCE ALAN 71 IT PA2-0694  
4344 28TH AVE SO MPL MINNEAPOLIS

PETERSON BRUCE ATTREE 71 MED  
CENTENNIAL HALL MPL WARREN  
PETERSON BRUCE CLARK 71 CLA 537-6058  
3700 ZANE AVE N CYT CRYSTAL  
PETERSON BRUCE DAVID 69 DULTH  
2309 E 1ST ST VIRGINIA  
PETERSON BRUCE DENNIS 70 GC 722-2293  
4049 16TH AVE SO MPL MINNEAPOLIS  
PETERSON BRUCE LIND 70 AGFHE  
1043 SHERREN W ROV ROSEVILLE  
PETERSON BRUCE RICHARD 69 GC 742-7324  
4100 HARRIET MPL MINNEAPOLIS  
PETERSON CANDACE LEE 69 NURS

PETERSON CARL MAGNUS GRAD

PETERSON CAROL ELIZABE 71 CLA 579-4567  
3430 BELDEN DR STA ST ANTHONY  
PETERSON CAROL JEAN 69 CLA 331-3944  
708 UNIV AVE SE MPL MINNEAPOLIS  
PETERSON CAROL JEAN 71 CLA 735-2768  
1885 E MINNEHAHA AVE STP NEW RICHMOND WI  
PETERSON CAROL LYNN 69 PT 331-5635  
612 10TH AVE SE MPL WHITE BEAR LAKE  
PETERSON CAROL MARIE 70 CLA 722-9742  
3113 14 AVE SO MPL MINNEAPOLIS  
PETERSON CAROL RAE 70 CLA 331-2618  
330 11TH AVE SE MPL MINNEAPOLIS  
PETERSON CAROL WILLTS GRAD  
940 FRANKLIN TERR S MPL MINNEAPOLIS  
PETERSON CARROLL THEOD 68 GC 781-7746  
3435 TYLER ST MPL MINNEAPOLIS  
PETERSON CATHERINE ANN 71 CLA 644-5641  
1665 BLAIR AVE STP ST PAUL  
PETERSON CATHERINE JEA 71 DULTH 724-4392  
422 MARYLAND ST DULUTH  
PETERSON CATHERINE LEE 70 CLA 373-7123  
141 E COMSTOCK HALL MPL WINONA  
PETERSON CATHERINE VAL 68 CLA  
2545 FILLMORE NE MPL MINNEAPOLIS  
PETERSON CHARLES ALBER 70 DULTH 525-2595  
5118 ONEIDA ST DULUTH  
PETERSON CHARLES BOYD 69 CLA  
2615 PIERCE ST NE MPL  
PETERSON CHARLES DAVID 70 IT  
298 RUTH ST STP STILLWATER  
PETERSON CHARLES EDWIN 68 BUS 823-2493  
4630 BLAISDELL S MPL RUSH CITY  
PETERSON CHARLES WILLI AS ED

PETERSON CHARLOTT MARI 70 CLA 561-4328  
5836 N JAMES BRC BROOKLYN CENTER  
PETERSON CHRISTIAN NEI 68 MORRS  
RT 1 NORTH HWY 59 ASHBY  
PETERSON CHRISTINE ELL 68 MEDTC 374-4430  
300 WESTWOOD DR NO GDV GOLDEN VALLEY  
PETERSON CHRISTOPHER P 70 CLA 698-7747  
1934 SHERIDAN AVE STP ST PAUL  
PETERSON CLARK CHARLES 68 GC  
TERRITORIAL HALL MPL MINCKLEY  
PETERSON CORRINE GRACE 70 CLA 824-1788  
3937 ELLIOT AVE SO MPL MINNEAPOLIS  
PETERSON COURTNEY DALE GRAD 339-4320  
912 22ND AVE S MPL CANBY  
PETERSON CRAIG ALBERT 69 DENT 646-3663  
1619 CARL ST LRD MOOSE LAKE  
PETERSON CRAIG ALGENE 69 MORSC 339-7421  
CENTENNIAL HALL MPL WILLMAR  
PETERSON CRAIG CHARLES 68 GC 771-1325  
ST PAUL  
PETERSON CRAIG ROGER 68 GC 742-7324  
4100 HARRIET MPL MINNEAPOLIS  
PETERSON CURTIS EDWARD 70 CLA  
1505 CLEVELAND STP ST PAUL  
PETERSON CURTIS IRA AS BUS 938-2505  
6021 IDYLWOOD DR EDN EDINA  
PETERSON CYNTHIA JANE 70 CLA 331-6848  
814 SE 8TH ST MPL MINNEAPOLIS  
PETERSON DALE ARTHUR GRAD

PETERSON DALE CARL 69 GC 545-7196  
2001 HOPKINS CROSS RD MTV MINNETONKA  
PETERSON DALE ROBERT 68 DENT  
6116 LYNDALE AVE SO MPL MINNEAPOLIS  
PETERSON DALE WESTON 68 AGFHE 729-0460  
2220 42ND ST E MPL MINNEAPOLIS  
PETERSON DALE WILLIAM GRAD

PETERSON DANIEL EVAN 69 IT 644-7529  
2258 COMMONWEALTH AVE STP WASECA  
PETERSON DARCY LYNN 69 CLA  
2019 21ST AVE S MPL CULBERTSON MT  
PETERSON DARCY RICHARD 68 CLA  
3700 E MINNEHAHA PKWY MPL  
PETERSON DARLENE ANNA 71 DULTH 722-8562  
2302 MINN AVE DULUTH  
PETERSON DARWIN RAY 70 IT

PETERSON DAVID ALLEN 70 CLA  
TERRITORIAL HALL MPL EDEN PRAIRIE  
PETERSON DAVID ARTHUR 71 CLA 774-2951  
843 E COTTAGE AVE STP ST PAUL  
PETERSON DAVID CHARLES 71 AGFHE 724-9431  
4125 LONGFELLOW AVE SO MPL MINNEAPOLIS  
PETERSON DAVID CHARLES 70 LAW  
1108 8TH ST SE MPL FERGUS FALLS  
PETERSON DAVID EDWIN 71 AGFHE  
1192 COFFEY HALL STP CLEAR LAKE  
PETERSON DAVID GEORGE 68 BUS 869-7331  
6344 THOMAS AVE SO RHF RICHFIELD

PETERSON DAVID JAMES 70 CLA  
PIONEER HALL ESSEX ST MPL BRANCH  
PETERSON DAVID JOHN 69 CLA 929-7067  
6121 CODE AVE MPL MINNEAPOLIS  
PETERSON DAVID JOHN 69 GC JA9-4460  
1113 35TH AVE NO MPL MINNEAPOLIS  
PETERSON DAVID LAWRENC 68 GC 941-1611  
6400 TINGDALE AVE S EDN EDINA  
PETERSON DAVID LEE 69 DULTH 525-2040  
5012 GLENWOOD ST DULUTH  
PETERSON DAVID LOWELL 71 CLA 824-1791  
610 W MAHA PKWY MPL MINNEAPOLIS  
PETERSON DAVID NORMAN 70 DENT 331-7933  
1004 7TH ST SE MPL ERSKINE  
PETERSON DAVID REYNOIR 70 CLA 774-4519  
1118 BARCLAY STP WILLMAR  
PETERSON DAVID RICHARD 70 DULTH 879-9474  
1535 AVE C CLOQUET  
PETERSON DAVID ROBERT GRAD 331-8013  
1127 4TH ST SE MPL  
PETERSON DAVID SCOTT 71 DULTH 724-9880  
GRIGGS HALL C317 WINDOM  
PETERSON DAVID TODD 71 CLA 588-2563  
2625 PARKVIEW BLVD ROB ROBBINSDALE  
PETERSON DEAN ARNOLD AS CLA 824-7739  
4935 CHICAGO AVE MPL MINNEAPOLIS  
PETERSON DEAN FREDRICK 71 CLA  
WASECA  
PETERSON DEAN ROBERT 68 IT 331-7422  
406 13TH AVE SE MPL PINE RIVER  
PETERSON DEBORA KAY 71 DULTH  
BURNSIDE HALL EDINA  
PETERSON DEBORAH LYNN 70 CLA 699-1792  
1681 NILES AVE STP ST PAUL  
PETERSON DELWIN PHILIP 69 IT 333-8661  
1129 UNIV AVE SE MPL LINDSTROM  
PETERSON DENNIS KARL GRAD 777-4716  
2425 SUMAC LN NSP NORTH ST PAUL  
PETERSON DENNIS LEE 71 CLA 521-8438  
710 UPTON AVE NO MPL MINNEAPOLIS  
PETERSON DENNIS MERCER 70 CLA 377-1316  
240 SHERIDAN AVE SO MPL MINNEAPOLIS  
PETERSON DENNIS RANDAL GRAD

PETERSON DENNIS RICHAR 70 DULTH 722-8505  
114 W 5TH DULUTH  
PETERSON DIANE LOUISE 70 DULTH 722-8987  
721 N 6TH AVE E CROMWELL  
PETERSON DIANE PATRICI 68 MORRS 589-4693  
SPOONER HALL ORTONVILLE  
PETERSON DIANE SHARON 71 DULTH 722-9159  
2101 W 6TH ST DULUTH  
PETERSON DIANNE EODYTHE 70 CLA  
409 UNIVERSITY AVE SE MPL WHITE BEAR LAKE  
PETERSON DIANNE LYNN 70 CLA  
PIONEER COURT MPL FERGUS FALLS  
PETERSON DONALD GORDON GRAD

PETERSON DONALD LENNAR 70 AGFHE  
607 20TH AVE MPL HUGO  
PETERSON DONALD RAMON 70 PHARM 529-8662  
816 47TH AVE NO MPL MINNEAPOLIS  
PETERSON DONALD THOMAS 70 DULTH 879-7039  
1502 HWY 33 CLOQUET  
PETERSON DOUGLAS ARTHU GRAD 884-1270  
2400 W 91ST ST BLT DULUTH  
PETERSON DOUGLAS HAROL 68 BUS 789-9240  
2535 QUINCY ST NE MPL MINNEAPOLIS  
PETERSON DOUGLAS JAMES 68 LAW 644-9971  
2002 KNAPP AVE STP DULUTH  
PETERSON DOUGLAS RAND 71 CLA  
5220 SHOREVIEW SO MPL MINNEAPOLIS  
PETERSON DOUGLAS WALLA 69 CLA

PETERSON DREW HAROLD 70 LAW  
2201 22ND AVE S MPL EDINA  
PETERSON DUANE LYLE 68 DULTH 727-3990  
219 N 2ND AVE E BRAINERD  
PETERSON DWIGHT HAROLD 70 CLA  
CENTENNIAL HALL MPL LITCHFIELD  
PETERSON ERIC THOMAS 70 CLA 333-8316  
516 5TH ST SE MPL MITCHELL SD  
PETERSON ERLING JOEL 69 IT 331-3433  
1115 5TH ST SE MPL DULUTH  
PETERSON GARRY FREEMAN 69 MED 646-8541  
1702 HAGUE AVE STP MINNEAPOLIS  
PETERSON GARY ALLAN 69 CLA WA6-0371  
5816 SHERIDAN AVE SO MPL  
PETERSON GARY ALLEN 70 MORRS 589-3203  
PINE HALL CLARISSA  
PETERSON GARY ALLEN 71 MORRS  
GLENWOOD  
PETERSON GARY CLARK 70 CLA 922-1914  
4745 HIBISCUS EDN EDINA  
PETERSON GARY LEE 68 GC PA2-7969  
5425 29TH AVE SO MPL MINNEAPOLIS  
PETERSON GARY MACLEOD 68 GC 744-7735  
3201 PORTLAND AVE SO MPL MINNEAPOLIS  
PETERSON GAY DIANNE 71 CLA 888-5340  
9215 NICOLLET BLT CULBERTSON MT  
PETERSON GENE HOWARD GRAD 339-7421  
CENTENNIAL HALL MPL WILLMAR  
PETERSON GEORGE MICHA 68 DULTH 834-2326  
1523 9TH AVE TWO HARBORS  
PETERSON GLENN CLAIR 69 BUS 739-0771  
16 2ND AVE STP ST PAUL  
PETERSON GLENN SCOTT 68 CLA

PETERSON GLORIA GENE 68 NURS 823-7762  
5519 CHICAGO AVE MPL TURLOCK CA

PETERSON GORDON CLINTO 69 GC

PETERSON GORDON DOUGLA 70 CLA 588-5356  
3639 LOGAN NO BRC BROOKLYN CENTER

PETERSON GORDON ENDCH 70 CLA 339-7421  
CENTENNIAL HALL MPL LITCHFIELD

PETERSON GORDON JOSEPH 69 DULTH 624-0347  
4728 W 6TH ST DULUTH

PETERSON GREG KERMIT 69 IT

PETERSON GREGG RUSSELL 68 GC 789-5166  
2223 STINSON BLVD MPL MINNEAPOLIS

PETERSON GREGORY ALAN 71 DULTH 722-6529  
3632 STEBNER RD DULUTH

PETERSON GREGORY CHARL 69 BUS  
1717 UNIVERSITY AV SE MPL GAYLORD

PETERSON GREGORY DAVID 71 CLA 822-8662  
5337 14TH AVE SO MPL MINNEAPOLIS

PETERSON GREGORY JAMES 71 MED 451-7252  
856 22ND AVE NO SSP SOUTH ST PAUL

PETERSON GREGORY KERMI 71 CLA 784-1223  
1731 HILLVIEW RD NMB NEW BRIGHTON

PETERSON GREGORY PAUL 70 CLA 922-7733  
5901 FAIRFAX AVE E EDN EDINA

PETERSON GUSTAF ELVIN 70 DULTH 525-3092  
5336 WYOMING ST DULUTH

PETERSON GUY DENNIS 71 CLA 755-3684  
11760 JUNIPER ST CNR COON RAPIDS

PETERSON H GEDFREY 69 CLA 646-4957  
1403 W IDAHO STP ST PAUL

PETERSON HAROLD CLAREN 70 IT  
1821 HAYES AVE NE MPL ISANTI

PETERSON HARRIET FLORE 68 CLA  
810 8TH ST SE MPL TRIMONT

PETERSON HARRY GILBERT 71 DULTH  
122 ARTAVIA GRAND MARAIS

PETERSON HELEN MARGARE 71 CLA 744-3759  
405 TARRYMORE AVE SO MPL MINNEAPOLIS

PETERSON HOWARD LINDSE 69 ED  
1701 MT CURVE MPL

PETERSON IRMA 69 AS CLA 521-3884  
WALTER LIBRARY MPL MINNEAPOLIS

PETERSON JACK CONRAD 69 DULTH 879-9008  
CLOQUET

PETERSON JACK RAYMOND 69 AS DULTH 722-2277  
2130 MILLER TRK LOT 212 DULUTH

PETERSON JACQUELINE LE 69 CLA  
WINONA

PETERSON JAMES CHARLES 71 AGFHE  
BAILEY HALL STP ROGERS

PETERSON JAMES DAVID 70 DULTH 728-2143  
130 LUZERNE RD DULUTH

PETERSON JAMES KENNETH 70 CLA 721-2053  
3208 43 AVE SO MPL MINNEAPOLIS

PETERSON JAMES LAVERN 68 GC

PETERSON JAMES LEONARD 69 IT FE5-0805  
2445 12TH AVE S MPL MINNEAPOLIS

PETERSON JAMES MILTON 71 DULTH 626-1554  
9318 ZIMMERLY DULUTH

PETERSON JAMES RICHARD 70 CLA 561-4271  
5835 ALDRICH AVE NO BRC BROOKLYN CENTER

PETERSON JAMES ROBERT 69 GRAD

PETERSON JAMES ROGER 70 GRAD  
2413 11TH AVE S MPL OMAHA NB

PETERSON JANE ECKERT E 69 MORRS 342-5350  
P O 57 GLENWOOD

PETERSON JANET CHRISTI 69 CLA 373-6135  
734 PIONEER COURT MPL STILLWATER

PETERSON JANET LORRAIN 69 GC 633-1599  
639 23RD NW NMB NEW BRIGHTON

PETERSON JANET LOUISE 71 DULTH 724-9896  
BURNTSIDE HALL 161 ST PAUL

PETERSON JANET RAE 71 CLA 336-1996  
2122 ELLIOT AVE SO MPL MINNEAPOLIS

PETERSON JANICE MAY 70 DULTH 628-1818  
3505 STEBNER RD DULUTH

PETERSON JAROLD EDDE 69 CLA FR4-4651  
437 N WESTWOOD DRIVE GDV GOLDEN VALLEY

PETERSON JAY ALLEN 71 CLA 522-5289  
1807 QUEEN AVE NO MPL MINNEAPOLIS

PETERSON JAY JOHN LEON 71 CLA BAYPORT

PETERSON JAY KEITH 70 LAW  
410 6TH ST SE MPL EDINA

PETERSON JAY ROGER 70 GRAD  
1502 E 3RD ST EYELETH

PETERSON JEAN ELIZABET 71 DULTH 722-8987  
721 N 6 AVE E CROMWELL

PETERSON JEAN ELLEN 69 DULTH 724-6576  
1631 E 3RD ST EYELETH

PETERSON JEAN MARIE 70 CLA 454-1581  
645 NO FREEMAN RD STP ST PAUL

PETERSON JEFFREY KUNZ 69 CLA 926-6142  
5250 PENN AVE SO MPL MINNEAPOLIS

PETERSON JEFFREY THOMA 71 IT

PETERSON JERALD WAYNE 71 IT 489-5317  
1043 SHERREN ST ROV ROSEVILLE

PETERSON JERELYN LESLI 68 AGFHE 537-5609  
6333 EDMONTON BLVD BRP BROOKLYN PARK

PETERSON JERINE ALICE 68 ED 488-1547  
981 W HOYT STP ST PAUL

PETERSON JEROME RAYMON 70 MED 339-2038  
1805 SE FRANKLIN AVE MPL ST PAUL

PETERSON JERRY WAYNE 69 BUS 646-8437  
1859 WALNUT ST LRD MILACA

PETERSON JEWELL RENEE 68 CLA 789-9530  
3047 CLEVELAND ST NE MPL MINNEAPOLIS

PETERSON JOAN KATHERIN 70 AGFHE 336-5288  
707 UNIVERSITY AVE SE MPL CLEAR LAKE

PETERSON JOAN KRISTIN 68 CLA 335-7808  
915 UNIVERSITY AVE SE MPL BLOOMING PR

PETERSON JOANNE MARGAR 71 CLA 377-7669  
1912 W 21ST ST MPL MINNEAPOLIS

PETERSON JOHN ALLEN 69 AS IT 421-8007  
11252 ARROWHEAD ST NW CNR RICHFIELD

PETERSON JOHN EDWARD 71 DULTH 879-9448  
1407 AVE C CLOQUET

PETERSON JOHN FIELDS 68 GC  
3840 5TH AVE SO MPL MINNEAPOLIS

PETERSON JOHN MICHAEL 70 DULTH 724-0122  
319 N 34TH AVE E DULUTH

PETERSON JOHN WESTLY 71 CLA 561-5540  
6201 BRYANT AVE NO BRC BROOKLYN CENTER

PETERSON JOLYON DAVID 69 GRAD

PETERSON JON RICHARD 68 IT 331-2770  
9 MALCOLM AVE SE MPL BAYPORT

PETERSON JOSEPH THOMAS 69 GRAD 633-1496  
3004 NO ARONA ROV NORTHFIELD

PETERSON JOYCE MARIE 70 CLA  
COMSTOCK HALL MPL GIBBON

PETERSON JUDITH ANN 68 GC 729-5275  
3344 46TH AVE SO MPL MINNEAPOLIS

PETERSON JUDITH BAKOS 69 AGFHE 441-1351  
617 GATES AVE

PETERSON JUDY ANN 68 ED 729-4430  
3325 46TH AVE SO MPL MINNEAPOLIS

PETERSON JUDY ANN 71 CLA 824-9775  
3700 PARK AVE MPL RED WING

PETERSON JUDY MARIE 68 CLA 338-9927  
1100 5TH ST SE MPL SOERVILLE

PETERSON JULIE ANN CLA 69 AS CLA 529-5755  
4140 IRVING AVE N MPL MINNEAPOLIS

PETERSON JULIE RUTH 70 DULTH 525-5669  
5422 ONEIDA ST DULUTH

PETERSON KATHLEEN ANN 70 DULTH 724-7383  
548 W WINONA DULUTH

PETERSON KATHLEEN ELAI 70 MORRS  
GAY HALL LAKE WILSON

PETERSON KATHRYN LOUIS 70 CLA  
320 16TH AVE SO MPL

PETERSON KATHY ANN 70 DULTH 722-4502  
2425 W SKYLINE PKWY DULUTH

PETERSON KAY DIANE 68 DULTH 724-9981  
GRIGGS HALL L 118 HOYT LAKES

PETERSON KAYANN 68 ED  
POWELL HALL MPL VIRGINIA

PETERSON KENNE JEAN 68 DULTH 628-1591  
10051 STARK RD DULUTH

PETERSON KENNETH ARTHU 70 CLA 881-4378  
9540 PARK AVE SO BLT BLOOMINGTON

PETERSON KENNETH FAY 70 CLA 771-7708  
1758 YORK AVE STP ST PAUL

PETERSON KENNETH RICHA 69 DULTH 626-1354  
93 AVE W DULUTH

PETERSON KENT RORRIE 70 IT 938-7416  
1405 5TH ST SE MPL VIENNA VA

PETERSON KRISTINE ANNE 71 MORRS 589-4693  
SPOONER HALL MINNEAPOLIS

PETERSON KURT CLARENCE 69 DULTH 353-7391  
FINLAND

PETERSON LANCE ROBERT 69 CLA 729-0264  
5116 NOKOMIS AVE SO MPL MINNEAPOLIS

PETERSON LARRY JAMES 68 GC 888-6228  
4700 W 112 ST BLT BLOOMINGTON

PETERSON LARRY JAMES 70 AGFHE 645-4241  
BAILEY HALL STP ANGUS

PETERSON LAWRENCE PETE 71 MED 537-6932  
6507 41ST AVE NO CVT CRYSTAL

PETERSON LAWRENCE RAY 69 GC 699-1034  
1426 JEFFERSON STP ST PAUL

PETERSON LEE HAROLD 70 CLA  
400 6TH AVE SE MPL HUTCHINSON

PETERSON LEE THOMAS 70 MORRS 589-3121  
BLAKELY HALL ROGERS

PETERSON LEEELLA SCHMI 71 MORRS  
RT 1 NORTH HWY 59 BATTLE LAKE

PETERSON LEONARD FRANK 70 IT  
1748 YORK AVE STP ST PAUL

PETERSON LEONARD JOSEF 68 CLA HU9-1515  
1421 SCHLETTI STP ST PAUL

PETERSON LESLEE ANN 68 DENHY 521-9496  
4559 VINCENT N MPL MINNEAPOLIS

PETERSON LESLEY CAROLI 69 LAW 699-2236  
2208 ELEANOR STP ST PAUL

PETERSON LESLIE DOUGLA 70 CLA  
1120 5TH AVE S ANK ANOKA

PETERSON LESLIE TYLER 69 GC 929-8645  
4039 YOSEMITE AVE SLP ST LOUIS PARK

PETERSON LILLY LORENTS 69 DULTH 722-3803  
3332 PIEDMONT AVE DULUTH

PETERSON LINDA ANN 69 DULTH 724-9981  
GRIGGS HALL L115 EDINA

PETERSON LINDA JO 71 CLA 722-2124  
3512 46 AVE SO MPL MINNEAPOLIS

PETERSON LINDA KAY 70 AGFHE 645-9241  
BAILEY HALL STP ST PAUL

PETERSON LINDA KAY 70 CLA  
SANFORD HALL MPL AITKIN

PETERSON LINDA LEE 71 DULTH 525-3508  
5345 LONDON RD WHITE BEAR LAKE

PETERSON LINDA LOUISE 69 MORRS 589-4693  
P O 712 UMM SPOONER LAKE WILSON

PETERSON LINDA LUCILLE 69 DULTH 724-8447  
324 W WABASHA DULUTH

PETERSON LINDA MARIE 69 CLA UA7-7552  
311 UNIVERSITY AVE SE MPL EDINA

PETERSON LINDA RUTH 69 ED 724-0968  
5240 32ND AVE S MPL MINNEAPOLIS

PETERSON LOIS MARGARET 69 ED 645-6579  
2351 CHILCOMBE AVE STP ST PAUL

PETERSON LOREN JON 70 CLA 488-8409  
985 SHERREN ROV ROSEVILLE

PETERSON LYNN CHRISTIA 70 AGFHE

PETERSON LYNN LOREEN 68 DULTH 728-4358  
1932 E SUPERIOR ST TOFTE

PETERSON LYNN REUBEN 68 AGFHE M15-8787  
1485 N CLEVELAND STP LINDSTROM

PETERSON LYNN RUSSELL 70 DULTH 624-4324  
205 N 38TH AVE W DULUTH

PETERSON LYNNE MARIE 71 CLA 825-5884  
3141 COLFAX SO MPL MINNEAPOLIS

PETERSON MALCOLM HAROL 71 CLA  
FRONTIER HALL MPL MINNEAPOLIS

PETERSON MARCIA JACOBS 68 ED 537-2041  
4150 REGENT NO ROB

PETERSON MARGARET LES 68 GC  
406 ERIE SE MPL WINONA

PETERSON MARGARET LOUI 68 ED 333-0297  
928 5TH ST SE MPL CROOKSTON

PETERSON MARILYN DIANN 68 ED 777-4716  
2425 SUMAC LANE NSP NORTH ST PAUL

PETERSON MARION IRENE 68 ED 633-1786  
1536 EDGEWATER AVE STP

PETERSON MARJORIE ELAI 70 CLA 331-1491  
1316 7TH ST SE MPL

PETERSON MARJORIE WEES 69 NURS 646-6492  
549 DESNOUER AVE STP

PETERSON MARK ALVIN 71 MORRS  
CLAYTON A GAY HALL MONTEVIDEO

PETERSON MARK CARL 70 CLA 331-5986  
1815 UNIVERSITY AVE SE MPL MINNETONKA

PETERSON MARK JOHN 68 GC 521-0084  
4567 VINCENT N MPL MINNEAPOLIS

PETERSON MARK PAUL 70 IT 373-6594  
426 TERRITORIAL MPL ST PAUL

PETERSON MARK WALTER 69 BUS 331-5941  
1206 SE 5TH ST MPL EDINA

PETERSON MARLENE RAE 71 CLA  
PIONEER COURT MPL WASECA

PETERSON MARSHA ANDERS 70 MORRS 795-2478  
RT 1 MORRIS

PETERSON MARY ANN 68 GC 789-4567  
3430 BELDEN DRIVE STA ST ANTHONY

PETERSON MARY ANN 71 DULTH 724-5185  
19 ARTAVIA GILBERT

PETERSON MARY IRENE 70 CLA  
COMSTOCK MPL MADISON

PETERSON MARY JOHANNA 71 CLA

PETERSON MARY KATHRYN 68 ED 331-3287  
720 6TH AVE SE MPL BLOOMING PR

PETERSON MARY LEE 70 CLA 331-6068  
603 OAK ST SE MPL INTERNAT FALLS

PETERSON MARY LOUISE 70 CLA  
606 E CHESTNUT REDWOOD FALLS

PETERSON MARYON LAFONT 68 DULTH  
5422 ONEIDA ST DULUTH

PETERSON MATTIE DEHAAN 69 AS CLA  
4370 WOODDALE AVE SLP

PETERSON MEREDITH ANN 71 CLA 526-3439  
PIONEER COURT MPL BLUE EARTH

PETERSON MERLE PATRICI 69 GRAD 373-3304  
230 PEIK HALL MPL WALKER

PETERSON MERLIN EVERAL 71 AGFHE  
BAILEY HALL STP LINDSTROM

PETERSON MICHAEL JOHN 70 DULTH 724-6917  
125 W ST MARIE ST INTERNAT FALLS

PETERSON MICHAEL LAVER 71 CLA 484-5227  
1150 W SEXTANT ST ROV ROSEVILLE

PETERSON MICHELLE RENA 69 ED 533-3495  
7240 60TH AVE NO MPL MINNEAPOLIS

PETERSON NANCY 69 ED 784-4902  
10501 XYLITE ST NE MPL MINNEAPOLIS

PETERSON NANCY GAY 71 CLA 588-2563  
2625 PARKVIEW BLVD ROV ROBBINSDALE

PETERSON NANCY KAY 69 ED 646-4179  
2269 HILLSIDE AVE STP ST PAUL

PETERSON NANCY LOUISE 69 CLA 521-6487  
2319 ALDRICH NO MPL MINNEAPOLIS

PETERSON NANCY LYNN 69 OT

PETERSON NANCY RAYE 68 GC 866-3713  
5731 CLINTON AVE SO MPL MINNEAPOLIS

PETERSON NAOMI IDA 68 AGFHE  
519 10TH AVE SE MPL NEMBERRY MI

PETERSON NELDA JOAN 69 CLA 331-1620  
312 WALNUT ST SE MPL HARMONY

PETERSON NORMAN ELLSWO 70 AGFHE 645-9503  
1231 ROSE VISTA CT ROV CHISAGO CITY

PETERSON NORMAN GENE 69 CLA 788-2630  
4556 MADISON ST NE CLH VIBORG SD

PETERSON ORIN MARTIN 69 IT

PETERSON PAMELA JO 71 CLA 881-8082  
8455 KELL AVE SO BLT BLOOMINGTON

PETERSON PAMELA JOY 71 CLA 421-3630  
2949 115TH AVE NW CNR COON RAPIDS

PETERSON PAMELA JOYCE 71 CLA  
425 UNIVERSITY AVE MPL HOPKINS

PETERSON PAMELA MARLTO 68 ED 784-0952  
7520 JACKSON ST NE FRD CAMBRIDGE

PETERSON PATRICIA ANN 71 CLA 588-5847  
2580 PERRY AVE NO GDV GOLDEN VALLEY

PETERSON PATRICIA GAIL 71 DULTH 724-8222  
802 N 19 AVE E KEEWATIN



PHELPS KAREN ANN AS CLA 698-9588  
 75 SO WHEELER STP ST PAUL  
 PHERNETTON RONALD ARVI 68 AGFHE 488-5139  
 85 W HOYT AVE STP ST PAUL  
 PHERSON CARL LENNIS GRAD 644-9402  
 1449 HYTHE ST GRD KASOTA  
 PHERSON JANET ANN RICH 69 ED 881-4205  
 1008 W 80 1/2 ST BLT GRAND RAPIDS  
 PHIFER STEVEN KURT 71 CLA 522-7467  
 3653 LOGAN AVE NO MPL MINNEAPOLIS  
 PHILBEN STEVEN EMMETT 68 ED 644-0247  
 2075 FEMPLE COURT STP ST PAUL  
 PHILBROOK BURNHAM JOHM 68 CLA 631-0411  
 1266 W CO RD B ROV ROSEVILLE  
 PHILION ROBERT ADRIAN 70 CLA  
 PIONEER HALL MPL REDWOOD FALLS  
 PHILIPH DENNIS LEE 71 MORRS  
 BLAKELY HALL  
 PHILIPPE LEO ISIDORE GRAD  
  
 PHILIPS CHARLES JOSEPH 70 DULTH 724-9893  
 VERMILION HALL 185 HIBBING  
 PHILIPS TERRY ALLAN 71 DULTH 724-9893  
 VERMILION HALL 185 HIBBING  
 PHILIPSON EUGENE GLENN AS IT 226-1918  
 232 W THOMPSON AVE STP SLEEPY EYE  
 PHILLIPICH EDITH ANNE 69 DULTH 724-9889  
 GRIGGS HALL N318 BIWABIK  
 PHILLIPPI DIANE MARIE 68 CLA 488-1853  
 700 COMO AVE 11 STP ST PAUL  
 PHILLIPPS STEPHEN PETE 70 CLA 881-1809  
 9713 OAKLAND AVE BLT BLOOMINGTON  
 PHILLIPS BARBARA ALICE 70 CLA 869-4201  
 5737 BLAISDELL AVE SO MPL MINNEAPOLIS  
 PHILLIPS DALE PATRYCE 70 CLA 459-3738  
 1636 STONE SPP ST PAUL PARK  
 PHILLIPS DARLENE VIOLE GRAD 484-4640  
 441 OAKCREST AVE ROV ROSEVILLE  
 PHILLIPS DAVID ALAN 71 IT 788-2210  
 1615 49TH AVE NE CLH COLUMBIA HTS  
 PHILLIPS DELBERT DARWA GRAD 533-4538  
 413 3RD AVE SE STEWARTVILLE  
 PHILLIPS EDWARD JAY GRAD  
 19 FIRST ST SO MPL MINNEAPOLIS  
 PHILLIPS GARY LEE GRAD 729-1008  
 2800 42ND AV S MPL MINNEAPOLIS  
 PHILLIPS GARY LEE 70 CLA 843-4435  
 HALLOCK  
 PHILLIPS JERRY DOUGLAS AS DULTH 263-6943  
 2608 3RD AVE E HIBBING  
 PHILLIPS JOHN GILBERT 70 IT 699-8173  
 1414 BERKELEY AVE STP ST PAUL  
 PHILLIPS LEONA CLAIRE 71 MED  
 515 DELAWARE SE MPL GRAND RAPIDS  
 PHILLIPS LLOYD GARRISO GRAD  
  
 PHILLIPS MARY QUILLIAM 70 CLA  
 EDINA  
 PHILLIPS NANCY LORENE 71 AGFHE  
 BAILEY HALL STP WHITE BEAR LAKE  
 PHILLIPS PATRICK JOSEF 70 DULTH 724-1633  
 2819 BRANCH DULUTH  
 PHILLIPS PAUL HARVEY 71 IT  
 TERRITORIAL HALL MPL ST PAUL PARK  
 PHILLIPS ROBERT CHARLE 68 CLA 331-1732  
 307 16TH AVE SE MPL NORTHBROOK IL  
 PHILLIPS SALLY JEAN 70 AGFHE 645-8297  
 1623 CARL ST STP MONTEVIDEO  
 PHILLIPS SUSAN HELEN 69 AGFHE  
  
 PHILLIPS THOMAS JOHN 70 CLA 825-0734  
 5732 DUPONT AVE SO MPL MINNEAPOLIS  
 PHILLIPS TRUDY BRAMBIL 68 ED  
 8851 GOODRICH SO BLT BLOOMINGTON  
 PHILLIPS VICKIE JEAN 69 ED 331-8748  
 1015 ESSEX ST SE MPL HARTLAND  
 PHILLIPS VICKY LYNN 71 CLA 331-6818  
 1128 6TH ST SE MPL ST PAUL  
 PHILLIPS WILLIAM CALVI GRAD  
  
 PHINNEY ARLENE HOLM AG 69 MORRS  
 6 HIGHLAND DRIVE COKATO  
 PHINNEY DOUGLAS LEROY GRAD 335-8135  
 400 6TH AVE SE MPL BOZEMAN MT  
 PHINNEY JAMES L 69 MORRS  
 P O 245 WOOD LAKE  
 PHIPPS SHARON MARIE 68 GC  
 2118 COMO AVE STP ST PAUL  
 PIASECKI EDWARD FELIX 71 DULTH 722-2340  
 105 E 5TH ST DULUTH  
 PIASECKI RICHARD BERNA 68 GC 777-1242  
 1803 MONN CT MTB WHITE BEAR LAKE  
 PIAZZA DAVID CHARLES 69 GC 374-4634  
 113 PARKVIEW TERRACE GOV GOLDEN VALLEY  
 PIAZZA NANCY JO 70 CLA 374-3177  
 113 PARKVIEW TERR GOV GOLDEN VALLEY  
 PICARD JEFFREY SCOTT 71 IT 436-7848  
 FRONTIER HALL MPL STILLWATER  
 PICCONATTO ALVIN HENRY 70 DULTH 724-5086  
 233 W WABASHA DULUTH  
 PICCONATTO EVELYN SUSAN 71 DULTH 724-5086  
 233 W WABASHA DULUTH  
 PICHELMAN FRANKLIN DAL 68 IT 421-6310  
 1096 132ND LN NE ANK ANOKA  
 PICHELMAN JUNELLA CHRI GRAD 784-4217  
 10107 COTTONWOOD ST NW CNR COON RAPIDS  
 PICHELMAN LYLE HERBERT 68 BUS 784-4217  
 10107 COTTONWOOD CNR COON RAPIDS  
 PICHNER JAMES RICHARD 70 IT 373-6992  
 405 FRONTIER HALL MPL OWATONNA

PINZKA DAVID WILLIAM	GRAD	PLASTER EDWARD JOHN	69 IT 426-2279	POAGE SUSAN KATHLEEN	70 NURS
PLOSKE DIANA JOY	69 CLA	117 BIRCH ST	MAH MAHOMEDI	PIONEER COURT	MPL CEDAR FALLS IA
1700 COMO AVE SE	MPL SANOSTONE	PLATE ROBERT HUGH	68 GC	POBLETE WILLIAM ROBERT	69 IT
PIOTROWSKI EDWARD MICH	68 GC	PLATH ALLAN RAY	68 CLA	814 8TH ST SE	MPL ROCHESTER
421 4TH AVE NE	MPL MINNEAPOLIS	PLATH CARL OREN JR	70 DULTH 722-1206	POBUL MARK	70 CLA
PIPAL DAVID EDWARD	69 CLA 722-8002	617 E 6TH ST	DULUTH	4515 POK ST NE	CLH COLUMBIA HTS
5549 36TH AVE SO	MPL FRESNO CA	PLATH DAVID ROBERT	71 AGFHE	POCHARDT LARRY ALLEN	68 DULTH 225-2214
PIPER EUGENE CARL	68 GC 451-1529	PLATH EDGAR TIMOTHY	68 GC 823-7704	219 ARLINGTON	HOYT LAKES
413 6TH AVE SO	SSP SOUTH ST PAUL	4756 ALDRICH AVE SO	MPL ALPHA	POCTA DUANE LAWRENCE	68 DULTH 724-4321
PIPER THOMAS JOHN	71 CLA	PLATH HELEN JACOBSON L	70 ED 823-7704	1703 E 3 ST APT 305	PINE CITY
FRONTIER HALL	MPL FARIBAUT	4756 ALDRICH AVE SO	MPL	POCTA ROGER WAYNE	68 IT 331-9741
PIPKORN HOWARD WILLIAM	68 IT 645-5957	PLATT ALBERT ARNOLD	68 PHARM 331-3277	701 15TH AVE SE	MPL PINE CITY
1757 N HAMLINE AVE	FLH FALCON HEIGHTS	861 24TH AVE SE	MPL ADA	POCZA ARPAD	68 IT
PIRI RONALD LEE	70 CLA	PLATT LAURA WINTER DEA	GRAD 226-7753		
2241 PIERCE ST NE	MPL MENAUGA	842 SUMMIT AVE	STP		
PIRIUS CAROL ANN	68 GC	PLATT SUZANNE COBB	GRAD 377-7069		
	RED WING	2001 W 21ST ST	MPL WORCESTER MA		
PIRIUS JAMES CLIFFORD	69 CLA	PLATZER STEVEN PETER	68 BUS 545-9105		
	RED WING	2201 ESSEX RD	MTV MINNETONKA		
PIRIUS RODGER PAUL	70 CLA	PLAUDA DANIEL DWIGHT	68 ED 729-5519		
2300 BRYANT AVE	MPL RED WING	3927 E 26TH ST	MPL MINNEAPOLIS		
PIRKL PAUL MARTIN	71 IT	PLEIMLING HELEN MAE	69 GC		
		COMSTOCK HALL	MPL INTERNAT FALLS		
PIRKOLA THOMAS OLIVER	71 DULTH 626-1349	PLESHA REBECCA JEAN	69 GC 771-7376		
9631 W SKYLINE	DULUTH	1726 E IOWA	STP ST PAUL		
PISHARODY RAGHAVAN KON	GRAD 331-3450	PLESHA SUZANNE CECILIA	69 ED		
CHEM DEPT U OF M	MPL	COMSTOCK	MPL HIBBING		
PISHNEY DONALD GEORGE	70 CLA	PLESUMS JOHN	70 IT 866-7253		
	SILVER LAKE	6701 VINCENT AVE S	RHF RICHFIELD		
PISTEL BARBARA DALE	70 DULTH 525-3783	PLETAN ROBERT LEROY	68 IT 631-2060		
4217 DODGE ST	DULUTH	1871 WALNUT ST	LRD WENDELL		
PISTNER BERNARD RICHA	70 DULTH	PLETCHER CLAUDIA JOY	70 DULTH 606-5472		
RT 3 BOX 615B	HEY NC	966 86TH AVE W	DULUTH		
PITEL RICHARD ALLEN	69 IT	PLETS JAMES HOMER	70 DENT 339-7421		
		CENTENNIAL HALL	MPL MINNEAPOLIS		
PITMAN CYNTHIA MORRIS	69 CLA 644-2426	PLETS VIRGINIA MARY	71 CLA 455-4334		
1681 TAYLOR AVE	STP WABAN MA	1950 BUTLER SO ST PAUL	SSP SOUTH ST PAUL		
PITMAN GREGORY HERBERT	GRAD 644-2426	PLETT DENISE AUGUSTA	70 MORRS		
1681 TAYLOR AVE	STP	GAY HALL	BRECKENRIDGE		
PITRA MARILYN LARSON H	AS ED	PLICE WILLIAM A	GRAD		
PITT GILBERT WILLIAM	70 CLA 331-6526	PLIHAL JANE ELLEN	GRAD		
1127 16 AVE SE	MPL MINNEAPOLIS	986 15TH AVE SE	MPL HUTCHINSON		
PITT RICHARD ALLAN	69 MORRS 269-7788	PLIHAL THOMAS LEROY	70 PHARM 722-8886		
401 E 7TH ST	MONTEVIDEO	3255 15TH AVE S	MPL HUTCHINSON		
PITTEL STUART	GRAD 339-1076	PLIML RICHARD FRANK	69 IT 338-3385		
530 4TH AVE SE	MPL MT LAWLAY	2401 CLINTON AVE SO	MPL COOK		
PITTELKOM ROGER ALLEN	69 CLA 645-2924	PLINTIE REGINA	68 GC 225-7524		
1119 RALEIGH ST	STP ST PAUL	881 LAUREL AVE	STP ST PAUL		
PITTELKOM STEPHEN PAUL	70 CLA 488-6892	PLINTE VALENTINA MARYA	69 GC 225-7524		
1255 N VICTORIA ST	STP ST PAUL	881 LAUREL AVE	STP ST PAUL		
PITTINGER JOHN BRUCE	GRAD 331-2727	PLITMAN JOHN MICHAEL	71 CLA 544-7520		
1408 5TH ST SE	MPL ALDAN PA	8335 PATSY LN	GOV GOLDEN VALLEY		
PITTMAN MARK RENDELL	71 CLA 698-6855	PLITMAN JUDY LYNNE	69 CLA 544-7469		
1661 PINEHURST	STP ST PAUL	8335 PATSY LANE	GOV GOLDEN VALLEY		
PITTS DAVID RILEY	68 PH 455-4474	PLITZWEIT JAMES ARTHU	68 CLA		
339 14TH AVE SO	SSP ST MARYS WV	1417 1ST AVE SO	MPL CALEDONIA		
PITTS PAUL RAYMOND	69 GC 333-5144	PLOCHER WYN LATCHAM AN	70 CLA 429-9478		
1505 WASHBURN NO	MPL	2562 SO SHORE BLVD	WTB WHITE BEAR LAKE		
PITTS RICHARD EDWIN	71 IT	PLOOF JANET KAY	70 CLA 825-7488		
		5243 12TH AVE SO	MPL MINNEAPOLIS		
PITTS ROGER PAUL	70 AGFHE 776-7460	PLOOF MARILYN JOANNE	69 OT 459-2409		
1467 N HAZEL	STP ST PAUL	380 GARWOOD	SPP ST PAUL PARK		
PITZEL DAVID GEORGE	70 CLA 451-2590	PLOOF MICHAEL JOSEPH	68 GC 561-1455		
451 E ROBRROSE	ING INVER GROVE	5918 ZENITH AVE NO	BRC BROOKLYN CENTER		
PITZELE SANDRA HOFFMAN	70 ED 935-8548	PLOOG FRANCIS WILLIAM	68 GC 824-7002		
641 7TH AVE SO	HOP	PL 3157 ELLIOT AVE S	MPL MINNEAPOLIS		
PITZL GERALD RUDOLPH	GRAD 698-9414	PLOOG RUTH EVELYN	70 CLA 869-7856		
1524 OSCEOLA AVE	STP DOWNERS GROV IL	6615 STEVENS AVE SO	RHF RICHFIELD		
PITZL JOAN MARIE	69 PT	PLOSS CRAIG RICHARD	71 CLA 225-3317		
	MANKATO	1304 DELAWARE AVE	WSP WEST ST PAUL		
PITZL JOHN FRANCIS	70 CLA 646-6446	PLDTNICK LINDA FAYE	70 CLA 935-4148		
1173 VAN BUREN AVE	STP ST PAUL	3100 VIRGINIA AVE SO	SLP ST LOUIS PARK		
PIVEC THOMAS MICHAEL	70 CLA	PLOURDE CHARLES GORDON	GRAD		
PIVERAL JUDITH IRENE	70 NURS 282-4356	PLOURDE FERDINAND JOSE	GRAD		
PIONEER HALL	MPL ROCHESTER				
PLACEK TERRY LEE	68 CLA 331-2745	PLOWMAN WILLIAM METCAL	GRAD		
329 OAK ST SE	MPL AUSTIN				
PLACHECKI ROBERT GEORG	GRAD 724-0222	PLUHM ELLEN ZEH	AS CLA		
1615 E 7TH ST	DULUTH	410 GROVELAND AVE	MPL BALLSTON LAK NY		
PLACK JERALYN JEAN	GRAD	PLUIMER MICHAEL JON	70 IT 331-3688		
		801 UNIVERSITY AVE SE	MPL MILACA		
PLADSEN PHYLLIS ROSE J	70 CLA 429-7377	PLUM DON PAUL	70 IT 941-3526		
2185 RANDY AVE	WTB WHITE BEAR LAKE	5925 ERIN TERRACE	EDM EDINA		
PLADSON WILLIAM HALE	AS CLA 823-6532	PLUMART PHILLIP EDMOND	GRAD		
1721 W LAKE ST	MPL GRAND FORKS ND				
PLAHN PAUL HENRY	68 IT 699-8092	PLUMB DAVID RICHARD	70 CLA 373-6613		
1400 ELEANOR	STP ST PAUL	446 TERRITORIAL HALL	MPL CALCUTTA		
PLAISANCE LINDA ANN	70 CLA	PLUMB DEBORAH ANDREA	71 CLA		
	FARIBAUT	SANFORD HALL	MPL LAKEVILLE		
PLAMANN JEANNE MARIE	68 GC 224-6026	PLUNKETT CHRISTOPHER R	71 CLA 484-9194		
4 DORSET RD	MEV MIESVILLE	3122 W OMASSO BLVD	ROV ROSEVILLE		
PLANER NORMAN GRAY	69 IT 336-3058	PLUNKETT JOHN JEROME	69 CLA 226-7960		
2104 22ND AVE S	MPL ANNANDALE	63 NO MILTON	STP ST PAUL		
PLANER SARAH JANE	69 CLA	PLUNKETT PATRICK JAMES	70 CLA 699-1879		
COMSTOCK HALL	MPL ANNANDALE	1466 LINCOLN AVE	STP ST PAUL		
PLANT GREGORY DOUGLAS	71 CLA 588-7317	PLUT JAMES FRANCIS	70 DULTH 724-9841		
3712 ZENITH NO	ROB ROBBINSDALE	TORRANCE HALL 117	IRONTON		
PLANT KAY MARIE	70 CLA 421-2779	PLUWAK TATIANA DARIA	69 BUS 339-2802		
1016 ADAMS	ANK ANOKA	638 MAIN ST NE	MPL MINNEAPOLIS		
PLANK LINDA ELEANOR	70 CLA 473-3215	PLYMAT WILLIAM NORTON	68 BUS		
1014 SE 4TH ST	MPL WAYZATA				
PLANTE BARBARA SUSAN S	AS ED 822-3512	PLYS CAROL ANN	71 DULTH 722-9313		
2637 LYNDALE AVE SO	MPL ALBERT LEA	2322 CHAMBERSBURG AVE			
PLANTIN THOMAS WILLARD	69 IT 537-7277	PLYS RONALD JAMES	70 DULTH 624-2142		
4343 43RD AVE N	MPL MINNEAPOLIS	18TH AVE E COLLEGE ST	DULUTH		
PLASCH PERRY CLARK	69 GC 869-7232				
7124 OAK GROVE BLVD	EDM EDINA				

POLANSKY ARLENE 71 CL 698-6956  
2057 JULIET AVE  
STP ST PAUL  
POLANSKY JANET MICHELL 68 CLA  
515 15TH AVE SE  
MPL OLIVIA  
PULDOSKI JOHN EDWARD 68 CLA  
1610 CLOQUET AVE  
GRAD CLOQUET  
POLESKY NANCY STALEY 71 CL  
207 W MINNEHAWA PKWY  
MPL  
POLLEZAYENKO HELEN 69 ED 332-1711  
413 SE 4TH ST  
MPL MINNEAPOLIS  
POLGA PETER JOSEPH 71 DULTH 724-9886  
VERMILION HALL 124  
CLOQUET  
POLGA THERESA MARIE 69 DULTH 724-5517  
421 NO 23RD AVE E  
CLOQUET  
POLICH DOUGLAS JAMES 70 CLA 374-3209  
1221 OLSON HWY  
MPL DEERWOOD  
POLICH LINDA JEANNE 71 DULTH 724-9896  
BURNSIDE HALL 171  
IRONTON  
POLICKA THEODORE LUCAS 71 DULTH 722-0773  
1208 BASSWOOD AVE  
DULUTH  
POLICONE THOMAS ANGELO 70 CLA  
POLIKOFF MARC DAVID 69 GC 922-7414  
3625 HUNTINGTON AVE  
SLP ST LOUIS PARK  
POLIVKA MARIE LOUISE 70 CLA  
3210 GIRARD SO  
MPL MINNEAPOLIS  
POLJACK STUART JAMES 71 MED 331-1319  
325 HARVARD SE  
MPL WINONA  
POLKEY FREDERICK WAYNE 69 GC 789-5018  
1710 4TH ST NE  
MPL MINNEAPOLIS  
POLKEY SUZANNE MARGARE 68 GC 579-5018  
1710 4TH ST NE  
MPL MINNEAPOLIS  
POLKINGHORNE ANN LOUIS 69 ED 724-1348  
3604 40TH AVE S  
MPL MINNEAPOLIS  
POLLACK JILL LYNN 70 CLA 938-7997  
417 HOLLYHOCK LN  
HOP HOPKINS  
POLLACK MARY JO 70 CLA 698-2616  
2110 HIGHLAND PKWY  
STP ST PAUL  
POLLAK BARBARA ANNE 68 DULTH 624-4345  
1308 CENTRAL AVE  
DULUTH  
POLLAK RICHARD RUDDLPH 70 DULTH 624-4345  
1308 N CENTRAL AVE  
DULUTH  
POLLAND ROBERT LEIGHTO 70 CLA 823-1564  
3204 ALDRICH SW  
MPL MINNEAPOLIS  
POLLARD CRAIG MICHAEL 71 CLA  
FRONTIER HALL  
MPL CLOQUET  
POLLARD LARRY CHARLES 71 PHARM  
4323 FRANCE AVE SO  
MPL MINNEAPOLIS  
POLLARD LINDA JEAN 71 DULTH 724-1710  
2708 BRANCH ST  
DULUTH  
POLLEY DARYL WILLIAM 69 GC 529-3497  
3845 LYNDAL AVE N  
MPL MINNEAPOLIS  
POLLEY DOUGLAS EUGENE 71 CL  
312 8TH ST SO  
GRAD  
POLLEY JANET ALLEN 71 CL  
2101 21ST AVE SO  
MPL  
POLLIN BRUCE T 71 IT  
416 8TH AVE SE  
MPL AUSTIN  
POLLMANN ROBERT ALLEN 69 IT 922-3176  
4214 ALDEN DRIVE  
EDN EDINA  
POLLNOD KATHLEEN MARIA 71 AGFHE 771-3565  
1032 MARGARET ST  
STP ST PAUL  
POLLNOW PAULINE ELLEN 68 GC 226-9329  
1094 ST CLAIR  
STP ST PAUL  
POLLOCK BRUCE VANBAALE 70 DULTH 724-9804  
GRIGES HALL A318  
MINNEAPOLIS  
POLLOCK CAROL HELEN 71 CLA 926-2543  
4602 DREXEL AVE  
EDN EDINA  
POLLOCK CORLISS WADEL 71 CLA 455-9442  
330 WESTVIEW DR  
WSP WEST ST PAUL  
POLLOCK DAVID GEORGE 68 BUS  
407 7TH ST SE  
MPL EVELETH  
POLLOCK JEROME PAUL 69 BUS  
ST CLOUD  
POLLOCK KATHRINE LOUIS 71 CLA 226-1360  
749 CHEROKEE  
STP ST PAUL  
POLLOCK STANLEY WELLS 71 CL  
413 CEDAR AVE  
GRAD 335-7194  
MPL LONGMONT CO  
POLLOCK WILLIAM GUY 69 IT 252-1443  
ST CLOUD  
POLNASZEK ERIC EDWARD 69 CLA 338-6018  
410 6TH ST SE APT 310  
MPL  
POLONY RONALD JAMES 69 GC 920-6359  
2521 W 40TH ST W  
MPL MINNEAPOLIS  
POLSFUSS TERRANCE ELLS 68 GC 699-9623  
1847 RANDOLPH AVE  
STP ST PAUL  
POLSKI BONNIE MAE 71 CL  
4606 CEDARWOOD RD  
GRAD 922-0549  
SLP ST LOUIS PARK  
POLSKI GREGG JAMES 69 GC 454-3635  
1642 LILAC LANE  
MEV HIESVILLE  
POLSKI ROBERT JOSEPH 71 CLA 698-6308  
1068 SO PRIOR  
STP ST PAUL  
POLSKI SHERYL LYNN 69 CLA 926-3248  
4200 WEST 25TH ST  
SLP ST LOUIS PARK  
POLSKI STEVEN LEE 70 CLA 922-0509  
4606 CEDARWOOD RD  
SLP ST LOUIS PARK  
POLSON KATHLEEN LYLA 71 CLA  
BRANCH  
POLSON PAUL DOUGLAS 70 CLA 645-2974  
1466 BROMPTON  
STP ST PAUL  
POLTA THOMAS ALFRED 71 MED  
PIONEER HALL  
MPL GRAND RAPIDS  
POLYMER JOHN JOSEPH 69 DULTH  
ELY  
POMERANTZ EVAN PHILLIP 69 GC 922-5343  
2531 MONTEREY AVE  
SLP ST LOUIS PARK  
POMERENKE DUMAYNE JOHN 70 AGFHE  
1469 CLEVELAND  
STP PARKERS PRAIRIE  
POMERENKE KENNETH DALE 71 PHARM 336-6471  
410 6TH ST SE  
MPL OKABENA  
POMERLEAU CRAIG ANTHON 68 GC 781-8879  
3357 BUCHANAN NE  
MPL MINNEAPOLIS  
POMERLEAU GARY EVERETT 69 GC 781-8879  
3357 BUCHANAN NE  
MPL MINNEAPOLIS  
POMEROY BENJAMIN ADAMS 69 AGFHE 644-8726  
1287 GIBBS AVE  
STP ST PAUL  
POMEROY CATHERINE ANN 68 ED 644-0944  
1443 RAYMOND AVE  
STP ST PAUL  
POMEROY KEM ALAN 68 ED 771-4716  
1065 DESOTO  
GRAD  
POMEROY MARGARET DAWN 70 CLA 644-0944  
1443 RAYMOND AVE  
STP ST PAUL  
POMEROY SHERWOOD ROBER 68 DENT 645-3876  
1158 FIFIELD  
STP ST PAUL  
POMIJE MARILYN MAE 69 ED 929-2506  
3157 JERSEY AVE  
SLP ST LOUIS PARK  
POMMERENING RANDALL RO 68 PHARM 454-6924  
1897 DELAWARE AVE  
MEV  
POMMERENKE JERRY DAVID 68 IT 336-2962  
2112 25TH AVE SO  
MPL BELGRADE  
POMMERVILLE GERALD ANT 69 DULTH 724-8236  
1819 GREYSOLON RD  
DULUTH  
POMORSKI PATRICIA ANN 70 CLA 771-4261  
972 E MAGNOLIA AVE  
STP ST PAUL  
POMPLUN DAVID JOHN 71 CLA 222-6960  
1243 OAKDALE AVE  
WSP WEST ST PAUL  
POMPLUN JAMES EDWIN 68 ED  
880 SO CLEVELAND  
STP ST PAUL  
POMRANTZ BRENDA JOY 69 GC  
NEWTON AVE SO  
MPL MINNEAPOLIS  
POMROY JON FREDERICK 71 IT 776-6548  
841 COOK  
STP ST PAUL  
POMROY MICHAEL FRANCIS 68 DULTH 724-6946  
725 10TH AVE E  
DULUTH  
PONATH JULIE SUSAN 71 CLA JAI-6592  
4035 QUEEN AVE NO  
MPL MINNEAPOLIS  
PONCIN ALLAN RICHARD 69 CLA 869-9074  
7221 GRAND AVE SO  
RMF RICHFIELD  
POND DONALD MARCUS 69 AGFHE 645-4357  
1407 PASCAL  
STP NORTHFIELD  
POND EDWARD AUGUSTINE 68 DULTH  
985 87TH AVE W  
DULUTH  
POND THOMAS FRANCIS JR 71 CL  
513 W REDWING ST  
GRAD 724-0476  
Y CT  
PONDER SHERYLL SUZANNE 71 CLA 225-3941  
337 SHERBURNE  
STP ST PAUL  
PONSFORD MARGARET KATH 68 CLA WA6-7209  
5433 NEWTON AVE SO  
MPL MINNEAPOLIS  
PONSOR VALERIE GRACE 70 CLA  
SANFORD HALL  
MPL MINNEAPOLIS  
PONSOR YVONNE HELEN 70 CLA 333-1861  
19 SO 1ST ST  
MPL  
PONTERIO JOHN JAMES 71 DENT  
CENTENNIAL HALL  
MPL SHAKOPEE  
PONTMAN STEVEN HAROLD 71 IT 484-1342  
TERRITORIAL HALL  
MPL ST PAUL  
PONTIUS JOANNE KAY 71 MORRS 589-1030  
CAMDEN HALL  
EAGLE BEND  
PONTIUS STEVEN RICHARD 70 DULTH 724-9886  
VERMILION HALL 173  
RICHFIELD  
PONTO BRIAN DEAN 71 CLA 724-0534  
3117 33RD AVE SO  
MPL MINNEAPOLIS  
PONTO RICHARD ALLEN 71 CLA 633-5243  
2001 12TH ST NW  
AS CLA  
POOCH STEVEN LARRY 71 AGFHE  
STP ST PAUL  
POOL MICHAEL ALLEN 70 CLA 646-3276  
1630 EUSTIS  
STP STOCKTON  
POOLE JAMES ROBINSON 71 CL  
6212 MILDRED AVE  
GRAD 929-9410  
MPL KENOSHA WI  
POOLE THOMAS GORDON 71 CLA 544-3026  
2865 QUEBEC AVE NO  
NMH NEW HOPE  
POOLER GLENN DAVID 71 CL  
GRAD  
POOLEY PHILIP EDWARD 71 CL  
10541 CENTENNIAL HALL  
GRAD 339-7421  
MPL GREENE IA  
POOLMAN EUGENE RICHARD 69 DULTH 722-3464  
218 E 4TH  
SEBEKA  
POON KOONYUI 71 CL  
3029 ALDRICH AVE SO  
GRAD  
POON SUETBIK HUI 71 CL  
GRAD  
POOT GAIL JEAN 69 CLA 929-6665  
2736 COLORADO AVE S  
SLP ST LOUIS PARK  
POPADICH BARBARA ANN 71 CL  
COMSTOCK HALL  
GRAD 373-7442  
MPL PLEASANTVILLE NJ  
POPE ANDREW TRACEY 71 CL  
479 18TH AVE SE  
GRAD 331-5880  
MPL GLOUCESTER MA  
POPE CAROL ANN 68 GC UN6-9956  
7020 LAKE SHORE DR  
RMF RICHFIELD  
POPE DAVID ARTHUR 68 MED 645-8908  
1225 GIBBS  
STP JASPER  
POPE GEORGE MICHAEL 70 MED 331-1369  
632 ONTARIO ST SE  
MPL SILVER BAY  
POPE NANCY CATHERINE 71 CLA 545-1244  
1830 FLAG AVE  
SLP ST LOUIS PARK  
POPE PATRICIA FAY 69 GC  
POPEHN SALLIE ALINE 70 CLA 339-2390  
612 27TH AVE SO  
MPL MINNEAPOLIS  
POPEK MICHAEL JOSEPH 69 GC 224-2943  
142 WESTCHESTER DR  
WSP WEST ST PAUL  
POPELKA MICHAEL JAMES 68 DULTH 741-0648  
714 12TH ST N  
VIRGINIA  
POPELKA PAUL RAYMOND 71 MORRS 699-9013  
BLAKELY HALL  
ST PAUL  
POPIELARZ DONALD THOMA 71 CL  
GRAD



POTEK NANCY LECHNYR 70 CLA 331-1910  
635 ONTARIO ST SE MPL MINNEAPOLIS  
POTHAST JAMES LYNN 70 AGFHE 484-1806  
3063 FARRINGTON CT STP OSAKIS  
POTOCNIK BARBARA JOAN 69 DULTH 724-5969  
1734 COLUMBUS AVE AURORA  
POTTER ANTONIA FLEAK 68 ED

POTTER CONNIE GAIL 71 DULTH 724-9896  
BURNSIDE HALL 165 SILVER BAY  
POTTER CYNTHIA ANN 70 CLA 333-6529  
315 10TH AVE SE MPL MORGAN  
POTTER JAMES ROGER 69 BUS

POTTER JANE CHRISTINE 69 CLA 823-6940  
2530 BLAISDELL S MPL MINNEAPOLIS  
POTTER JOAN ELIZABETH 71 CLA  
SANFORD HALL MPL RED WING  
POTTER LAURA LOUISE 69 CLA 823-6940  
2530 BLAISDELL SO MPL MINNEAPOLIS  
POTTER LINDA JANE 68 CLA 331-6521  
315 10TH AVE SE MPL LONG LAKE  
POTTER MOEL JR GRAD 333-2783  
208 5TH AVE SE MPL RUTLAND VT  
POTTER ROBERT WILKINS 69 CLA 926-5080  
5908 QUEEN AVE SO MPL MINNEAPOLIS  
POTTER SUSAN TERRY 71 CLA  
ANDREW HOUSE MPL MORGAN  
POTTHOFF GREGORY MASON 71 CLA 771-3735  
321 N PT DOUGLAS RD GRAD  
POTTON JAMES EDWARD STP ELBE WA  
1238 ROSE VISTA GRAD 786-4923  
POTTS LAWRENCE WALTER LEX BUFFALO NY  
8941 SYNDICATE AVE 70 AGFHE 529-2749  
POTYONDY JOHN PAUL MPL MINNEAPOLIS  
4811 FREMONT AVE NO MPL MINNEAPOLIS  
POTYONDY STEPHAN JOSEF 69 CLA 529-2749  
4811 FREMONT AVE N MPL MINNEAPOLIS  
POU EDELMIRA DE AS AGFHE  
2039 KNAPP DR STP ARGENTINA  
POU PEDRO GRAD

POUGIALES ANN MARGARET 70 LAW  
POWELL HALL MPL ROCHESTER  
POUGIALES RITA AGNES 70 CLA  
PIONEER COURT MPL ROCHESTER  
POULAKIS VICTORIA SUZA GRAD

POULSON CAROL ALICE 70 AGFHE

POUND MARLYS JOENE 68 GC  
1276 W HWY 36 ROV ROSEVILLE  
POUPARD DIANNE MARIE 70 DULTH 741-3257  
213 3RD ST SO VIRGINIA  
POVLACS JOYCE THERESA GRAD

POWELL DOUG ALAN 70 CLA 699-4424  
1585 PINEHURST AVE STP ST PAUL  
POWELL GAIL ANITA 71 CLA 824-7767  
2715 GIRARD AVE S MPL MINNEAPOLIS  
POWELL JENNIFER LYNNE 70 DULTH 728-4196  
128 N 36TH AVE E EDINA  
POWELL KENNETH GERARD 69 GC 588-5910  
4516 DREW AVE NO ROB ROBBINSDALE  
POWELL MARVIN ADELL JR GRAD

POWELL PATRICIA ANN 69 CLA  
SANFORD HALL MPL GRAND RAPIDS  
POWELL RAY IRWIN GRAD

POWELL REGINALD MCLELL 69 GC 331-6889  
1112 6TH ST SE MPL MINNEAPOLIS  
POWELL ROBERT KENT 69 GC 377-5509  
1519 NATCHEZ AVE SO MPL MINNEAPOLIS  
POWELL WILLIAM ROGERS 68 DENT 331-8379  
1697 FREY FLH MARSHALL  
POWER CHERYL JEAN 70 CLA 722-3839  
4046 39TH AVE SO  
POWER LYNETTE RENEE 71 MORRS 589-3363  
PARK VIEW HGTS MORRIS  
POWER MARGARET 69 GC 699-8012  
1801 GOODRICH AVE STP ST PAUL  
POWERS ALAN WILLIAM GRAD  
29 MELBOURNE AVE SE MPL E LONGMEADOW MA  
POWERS GEORGIANN ELIZA 70 CLA 926-8470  
2709 DREW AVE SO MPL MINNEAPOLIS  
POWERS GERALD LEONARD GRAD 336-4730  
718 VAN BUREN AVE NE MPL RANDALL  
POWERS JEANNE AUDREY AS CLA 339-7716  
122 W FRANKLIN MPL MANKATO  
POWERS JOHN MICHAEL 71 CLA 823-5930  
5024 HARRIET SO MPL MINNEAPOLIS  
POWERS JOHN THOMAS 71 CLA 645-3366  
110 NO CLEVELAND STP ST PAUL  
POWERS KATHRYN RUTH 69 CLA 331-6656  
1327 7TH ST SE MPL ST PAUL  
POWERS PAMELA ANN 71 CLA 724-7011  
5705 37TH AVE SO MPL MINNEAPOLIS  
POWERS PATRICIA MARY 70 CLA 645-7938  
1872 MARSHALL STP ST PAUL  
POWERS ROBERT DAVID 69 IT 451-3707  
FLEMING FIELD APTS SSS SOUTH ST PAUL  
POWLESS LINDA GRAHAM M GRAD  
2915 115 LANE NW CNR  
POWELL HENRY CLINTON 70 CLA  
8 392 TERRITORIAL HALL MPL ALBERT LEA  
POVLIO PATRICIA JEAN 69 NURS 339-0531  
POWELL HALL MPL SOUDAN  
POZNAVOVIC THOMAS EDWA 71 DULTH  
221 NORTON ST VIRGINIA

PRACHAR TERRY ERVIN 69 CLA  
MPL WILLOW RIVER  
PRAGER ROBERT ZANDER 71 CLA  
CENTENNIAL HALL MPL MINNEAPOLIS  
PRAHARAJ SARAT CHANDRA GRAD 339-7421  
CENTENNIAL HALL MPL DIST BALAJOR  
PRAHL LESLIE ERIC 70 PHARM 645-2109  
2116 COMO AVE STP LESUEUR  
PRAHL MARVIN EDWARD 70 IT  
1627 CARL ST STP WATERVILLE  
PRAHL ROBERT STEVEN 71 CLA  
TERRITORIAL HALL MPL RED WING  
PRAHL STEVEN WALTER 71 DULTH 729-7356  
3859 MILLER TRNK HWY DULUTH  
PRAIRIE DORIS EMMA 68 CLA  
1023 UNIVERSITY SE MPL MARSHALL  
PRAIRIE LOREN HILAIRE 71 MORRS 589-3121  
BLAKELY HALL MARSHALL  
PRAML JOSEPH PATRICK 69 CLA 331-5422  
64 ST MARYS AVE SE MPL  
PRAMODA MATURU KRISHNA GRAD

PRANICA VALERIE VAUX A 68 CLA  
511 UNIVERSITY AVE SE MPL MINNEAPOLIS  
PRANTNER MELVIN MARTIN 71 IT

PRASKY PETER VICTOR 68 GC JUB-9327  
4412 BEARD AVE N MPL MINNEAPOLIS  
PRASS JOAN LYNN 68 GC 529-3195  
1200 N QUEEN MPL MINNEAPOLIS  
PRATT CURTIS HAZEN GRAD

PRATT DESMOND MICHAEL 68 CLA 929-2382  
5241 RICHWOOD DR EDN EDINA  
PRATT DEVIN MARTIN 71 CLA 331-1723  
1623 UNIVERSITY AVE SE MPL ANOKA  
PRATT GEORGE JAMES JR 70 CLA 935-2825  
6216 SOUTH KNOLL DR EDN EDINA  
PRATT HARRIET JAFFRAY GRAD  
BOX 416 RT 3 WAY  
PRATT JAMES WARD GRAD M14-7846  
2470 COMO AVE STP SIOUX FALLS SD  
PRATT KATHLEEN MARY 71 ED 929-2382  
5241 RICHWOOD DR EDN EDINA  
PRATT MARY JOANNE 70 AGFHE 560-1811  
811 RICE CREEK TERRACE SAWYER  
PRATT MARY LEE 69 ED 225-3319  
929 LINWOOD AVE STP ST PAUL  
PRATT RANDALL ALLAN 68 ED 225-3319  
929 LINWOOD AVE STP ST PAUL  
PRATT RICHARD ALLEN 70 AGFHE 222-0861  
1128 LINCOLN AVE STP ST PAUL  
PRATT RICHARD LAWRENCE 71 CLA 560-1811  
811 RICE CREEK TER FRD FRIDLEY  
PRATT ROBERT JAMES 70 CLA 561-6413  
8132 XENIA AVE NO BRP BROOKLYN PARK  
PRATT RONALD EDWARD 70 AGFHE

PRATT SALLY BOURGOIS A GRAD

PRATT SUSAN KAY 70 AGFHE 333-7285  
311 10TH AVE SE MPL MINNETONKA  
PRATT VIRGINIA ANNE GRAD

PRATT WARREN ROBERT GRAD 426-2858  
ROUTE 3 STW  
PRATZNER FRANK CHARLES GRAD 331-4015  
1073 18TH AVE SE MPL  
PRAY CHRISTOPHER MARY 71 CLA 644-6948  
1311 SELBY AVE STP ST PAUL  
PRAZICH MICHAEL NICK 71 DENT FE1-1324  
814 ESSEX ST SE MPL COLERAINE  
PREBLE DAVID CRAIG 69 GC 888-4808  
10525 ZENITH AVE SO BLT BLOOMINGTON  
PREBLE MARILEE JANE 70 CLA

PREE SUSAN HELEN 68 AGFHE 474-7876  
RT 7 BOX 292 EXC EXCELSTOR  
PREHEIM EMMA JEAN AS CLA

PREIMESBERGER ERNEST 70 IT 632-8367  
FRONTIER HALL MPL LITTLE FALLS  
PREINER VALLI KAY 71 CLA 922-0986  
4934 CHOWEN AVE SO MPL MINNEAPOLIS  
PREISLER WILLIAM CHRIS 69 CLA  
632 ERIE ST SE MPL MINNEAPOLIS  
PREKKER DEAN LOUIS 70 CLA 781-8708  
3139 HAYES ST NE MPL MINNEAPOLIS  
PRELGO WILLIAM EDWARD 68 CLA 735-0486  
2018 MANITOU AVE STP ST PAUL  
PRELL HARLEY LERDY 68 MORSC 339-2429  
408 8TH ST SE MPL STILLWATER  
PRELL MARTHA PIERPONT 68 NURS 339-2429  
408 8TH ST SE MPL WHITE PINE MI  
PREMAK BUDD ALBERT LD 70 CLA 377-5888  
1700 KENWOOD PKWY MPL MINNEAPOLIS  
PRENDERGAST HARRY CLIF GRAD

PRENEVOST PATRICIA ZOE 70 CLA 781-9652  
2938 NE ULYSSES MPL MINNEAPOLIS  
PRENTICE RONALD L 71 CLA 588-1652  
3531 HALIFAX NO ROB ROBBINSDALE  
PRENTICE WALTER BENTON GRAD  
2089 CARROLL STP  
PRESCOTT CAROLE ANN 70 CLA  
PIONEER COURT MPL DULUTH  
PRESCOTT JEAN PORTA GRAD

PRESCOTT JON MICHAEL GRAD 633-0588  
393 OLD HWY 8 NWB KONAWA OK

PRESLIN MATHEW WILLIAM 71 DULTH 728-1667  
5527 W 8 ST DULUTH  
PRESS JOHN EDWARD 69 CLA  
GILBERT

PRESS SHARON ISABELLE 71 DULTH 724-0004  
814 N 19TH AVE B DULUTH  
PRESTEGAARD KRISTI JO 69 CLA 333-2675  
2019 S 21ST AVE MPL MINNEAPOLIS  
PRESTEGARD JEAN HELEN 70 CLA  
SANFORD HALL MPL  
PRESTEGARD LESLIE CHAR 71 CLA 881-7372  
8445 BLOOMINGTON AVE BLT BLOOMINGTON  
PRESTEMON JACK DAVID GRAD  
RT 7 BOX 676 EXC  
PRESTHOLDT DENNIS LEE GRAD

PRESTHOLDT PERRY HAROL GRAD

PRESTIN STEVEN JOHN 70 CLA 784-4060  
903 87TH LANE NW CNR COON RAPIDS  
PRESTIN WILLIAM HAROLD 69 CLA  
903 87TH LN NW CNR COON RAPIDS  
PRESTLY BARBARA RUTH 69 CLA 922-9541  
5845 BROOKVIEW AVE EDN EDINA  
PRESTON DAVID ALAN 69 ED  
WAYZATA

PRESTON DAVID JACK 69 IT

PRESTON JUDITH VICK AN AS ED 336-6574  
407 4TH ST SE MPL BLOOMINGTON  
PRESTON NANCY KERSLAKE AS CLA 426-2705  
170 WILDWOOD STP  
PRESTON PATRICK JAMES 69 GC TA3-2892  
5120 BLOOMINGTON AVE SO MPL MINNEAPOLIS  
PRESTON RALPH JAY 68 CLA 729-1441  
4032 20TH AVE SO MPL MINNEAPOLIS  
PRESTON RAY CHARLES 68 CLA 729-1441  
4032 20TH AVE SO MPL MINNEAPOLIS  
PRESTON RICHARD WALTER 70 CLA 881-4297  
111 W 80TH BLT BLOOMINGTON  
PRESTON ROBERT HUSETH 68 CLA 935-2004  
4603 ELLERDALE RD HOP HOPKINS  
PRESTWICH ROGER GRAD 339-3325  
911 21ST AVE SO MPL ENGLAND  
PRETTYMAN DONALD H GRAD  
1512 CO RD B MPW STAR CITY IN  
PREUS CHARLES LOUIS 68 CLA 529-4316  
2119 QUEEN AVE NO MPL MINNEAPOLIS  
PREUS RICHARD OTTO 70 CLA 926-5767  
5544 NEWTON AVE SO MPL MINNEAPOLIS  
PREUSS ROSALIE MARTHA 70 CLA 331-6898  
425 ERIE ST SE MPL RENVILLE  
PREVOSTVARGOS PEDRO MA GRAD

PREZALAR LORRAINE VERO 68 CLA 941-3534  
9290 SO HWY 169 EDP PACIFIC GROV CA  
PRIADKA MICHEL 68 GC 788-7897  
1903 42ND AVE NE CLH COLUMBIA HTS  
PRIADKA NICKOLAS 69 IT 788-7897  
1903 42ND AVE NE CLH COLUMBIA HTS  
PRIBNOW JOEL KEITH 70 CLA 869-3890  
6233 BRYANT AVE SO RHF RICHFIELD  
PRIBYL DOUGLAS WAYNE 71 CLA  
TERRITORIAL HALL MPL HUTCHINSON  
PRIBYL KATHRYN ANN 69 MEDTC 339-0531  
POWELL HALL MPL MAPLE LAKE  
PRIBYL MARIE THERESA 71 CLA 339-0531  
BOX 377 POWELL HALL MPL MAPLE LAKE  
PRIBYL MARY JANE 68 AGFHE 645-9241  
2168N BAILEY HALL STP MAPLE LAKE  
PRIBYL WALTER DODGE 70 CLA  
FRONTIER HALL MPL HERON LAKE  
PRICE ALAN ROGER GRAD

PRICE ARTHUR BLAINE 70 CLA 421-0472  
3209 SPRAGUE RD ANK ANOKA  
PRICE DARRELL MORLEY 69 CLA 722-8292  
5204 37TH AVE S MPL MINNEAPOLIS  
PRICE DEL FREDERICK 69 GC 336-8453  
502 2ND AVE SE MPL MINNEAPOLIS  
PRICE DONALD JAY 71 CLA  
TERRITORIAL HALL MPL RED WING  
PRICE JAMES CURTIS 69 DENT 373-6320  
1623 PIONEER HALL MPL WATERTOWN SD  
PRICE JAMES WENDELL 71 IT  
330 5TH AVE SE MPL CLOQUET  
PRICE JOEL DENNIS 70 CLA  
3853 BRYANT AVE SO MPL RICHFIELD  
PRICE JOSEPH MICHAEL 69 CLA 699-8348  
1272 ELEANOR STP ST PAUL  
PRICE LINDA MARIE 70 DULTH 525-5769  
4811 PUTT ST HINKLEY  
PRICE MARY ALBERTA MOS GRAD

PRICE MICHAEL JAMES 68 CLA 935-5344  
3663 ROBINWOOD TER HOP HOPKINS  
PRICE RICHARD JAMES 70 CLA 633-2067  
1677 GLENVIEW CT ANH ARDIN HILLS  
PRICE ROBERT HOWE GRAD 935-9805  
14408 MOONLIGHT HILL RD HTV  
PRICE STEVEN JAY 68 GC 336-8453  
502 2ND AVE SE MPL MINNEAPOLIS  
PRICE THOMAS STEPHEN GRAD 339-7421  
CENTENNIAL HALL MPL WABASSO  
PRICE WILLIAM BRADFORD 70 CLA 824-8087  
5109 EMERSON SO MPL MINNEAPOLIS  
PRICEJACKSON WILLIAM O 70 CLA  
874 HAGUE STP  
PRIDE EILEEN ELLEN 71 CLA 842-8885  
MPL BENSON





RAHN CURTIS HARRY 1931 JEFFERSON ST RAHN JOANN PAULETTE 335 PIONEER COURT RAICHE ELLEN LEE 113 NINTH AVE NE RAICHE RICHARD LLOYD 4037 COLFAX SO RAICHE WILLIAM LEIGHTO 4037 COLFAX RAIHALA WILLIAM LAWREN	AS DULTH 69 ED 373-6052 MPL BINGHAM LAKE 70 CLA 333-5856 MPL MINNEAPOLIS 69 GC 822-4126 MPL MINNEAPOLIS 68 GC 822-4126 MPL MINNEAPOLIS GRAD	RAMIREZ RAMONA 1543 YORK AVE RAMIREZDEUCAMARGO LUZ M	68 GC 774-8137 STP ST PAUL 68 CLA	RANK ELLIOT LOUIS 1650 THOMAS AVE NO RANK JANE BRADFORD ELI	70 CLA 522-7247 MPL MINNEAPOLIS GRAD
RATHILL DAN ALVIN 2531 E 3RD ST RATHMO RICHARD JOHN 3005 RESTORMEL ST RATNALDI FRANKLIN DELA	70 DULTH 724-5059 DULUTH 71 DULTH 624-3303 GRAD	RAMQUIST BARBARA WARRE 614 HURON ST SE RAMQUIST JOHN ALBERT 614 HURON ST SE RAMRAS SARAJANE HELEN 12 RIVER TERRACE COURTS RAMSAY JAMES STUART NB P O 11286 GAY HALL RAMSAY THOMAS EDWARD 276 ORNE RAMSDELL DIANNE MARIE BURNSTIDE HALL 176 RAMSELL MARJORIE LEE BURNSTIDE HALL 176 RAMSETH PHYLLIS GAIL 1666 SHERBURNE RAMSEY JAMES WOODSON	68 MEDTC 331-7220 MPL 68 CLA 331-7220 MPL ELY GRAD 336-7924 MPL ST PAUL 71 MORRS WARROAD 68 CLA 227-3714 WSP WEST ST PAUL 71 DULTH 724-9896 HINCKLEY 71 DULTH 724-9896 CAMBRIDGE 70 CLA STP ST PAUL GRAD	RANKILA GARY MICHAEL CENTENNIAL RANKIN RUTH ANN 2795 MARION RANKIN SUSAN CLAIRE 6424 VINCENT AVE SO RANKIN WILLIAM STEVENS	70 LAW MPL VIRGINIA 70 CLA 484-4905 ROV ROSEVILLE 70 CLA 869-1700 RHF RICHFIELD GRAD
RAITHBY GEORGE DOUGLAS RAITT MARY JENNIFER 5647 PILLSBURY AVE SO RAITZ KARL BENNETT 21 MELBOURNE RAIVO JANICE ANN 3421 23 AVE SO RAJ VARAD ANIL 1268 PAYNE AVE RAJACICH DONNA JEAN 1833 WOODLAND AVE RAJACICH KATHLEEN 2320 E 1 ST RAJACICH ROBERTA SANFORD HALL RAJALA MICHAEL JOHN 1807 WASHINGTON AVE SO RAJALA RANDOLPH BARTON 1717 UNIVERSITY AVE SE RAJENDER SUDHAKAR 2425 SHERIDAN AVE SO RAJPUT JENNY HOFFMAN L	70 DULTH 724-5059 DULUTH 71 DULTH 624-3303 GRAD GRAD 646-5319 STP ANOKA 69 PHARM 488-0794 STP HERON LAKE 71 CLA MPL NORTH PLATTE GRAD 335-5616 MPL WESTLAKE LA 71 AGFHE 445-1218 CHN CHANHASSEN 68 GC 825-7507 MPL MINNEAPOLIS 69 DULTH 724-1942 ESKO GRAD 69 UCOL 744-7442 MPL HINGHAM MA GRAD 336-0847 MPL HECTOR 70 CLA 729-4995 MPL MINNEAPOLIS 68 CLA 771-7580 STP 70 DULTH 728-1961 HOYT LAKES 70 DULTH NASHMAUK 70 CLA MPL VIRGINIA 69 CLA MPL PRINCETON 68 CLA MPL BIGFORK 68 GC 377-9078 MPL MINNEAPOLIS GRAD	RAMSEY JANET MCLENNAN RAMSEY THOMAS ERWIN 416 8TH AVE SE RAMSEY WILLIAM MILLER 1211 RALEIGH AVE RAMSEY WILLIAM SCOTT RANSLAND MARCIA AUSTIN 210 E ANOKA ST RANSLI NANCY JEANNE 2111 W 5TH ST RAMSPERGER FRANK ALBER 1201 5TH ST SE RAMSTAD BRUCE LEE 1032 GRANDVIEW AVE RAMSTAD CLIFFORD JOHN 4136 DVORAK RD RAMSTAD ERIC PAUL 4633 17TH AVE SO RAMSTAD JAMES MARVIN 1011 4TH ST SE RAMSTAD KAREN MARIE 4633 17 AVE SO RAMSTAD ROBERT JOHN	AS ED 68 CLA 338-3785 MPL WHITE BEAR LAKE 68 DENT 645-5389 STP MINNEAPOLIS GRAD 70 DULTH 724-0150 DULUTH 70 DULTH 722-2567 DULUTH GRAD 331-7941 MPL TORONTO 68 DULTH 724-4736 GRAND RAPIDS 69 CLA 935-5798 HOP HOPKINS 70 CLA 729-0953 MPL MINNEAPOLIS 68 CLA 336-9399 MPL JAMESTOWN ND 71 CLA 729-0953 MPL MINNEAPOLIS 68 GC	RANNEY DAVID JOHN TERRITORIAL HALL RANNEY THOMAS GEORGE RANNIKER JOLENE KAY 1705 E 8TH ST RANNIKER MARILYN MARIE 109 E NIAGARA ST RANSOM SHARON ANN 617 2ND ST NE RANSON KATHLEEN MARIE GAY HALL RANTA ARNOLD MARVIN GRIGGS HALL C312 RANTA CAROLYN DJANE 522 N 4TH AVE E RANTA DONALD WILHO RANTA MARLENE GLORIA N313 GRIGGS HALL RANTA ROBERT DENNIS 2915 ZENITH AVE NO RANTALA KATHLEEN LOUIS 1631 CARL ST RANTAPAA LARRY ARVID	69 GC 373-6631 MPL WHEATON 68 MORSC 68 DULTH 728-3231 EVELETH 71 DULTH 724-0008 DULUTH 68 CLA 425-3892 OSQ OSSEO 71 MORRS DENT 71 DULTH 724-9880 MAKINEN 68 DULTH 722-0001 HIBBING 70 DULTH 453-4495 BROOKSTON 70 DULTH 724-9869 MAKINEN GRAD 588-8123 ROB ROBBINSDALE 68 CLA 588-9510 STP MINNEAPOLIS AS ED GRAD 646-3044 STP 68 CLA MPL THF RIVER FALLS 71 CLA 777-4962 NSP NORTH ST PAUL GRAD 647-3535 STP ORISSA GRAD 822-1941 MPL NORTHWOOD IA GRAD AS DENT 822-4627 MPL GRAD MPL HASSAN GRAD 646-6414 STP LAUSYER 70 CLA MPL MINNEAPOLIS 69 VET H 789-0888 MPL MINNEAPOLIS 71 IT 824-4168 MPL MINNEAPOLIS 68 DULTH 724-5571 HIBBING GRAD 722-0985 DULUTH 68 ED 331-5049 MPL CLEVELAND 71 CLA 926-6973 SLP ST LOUIS PARK 70 CLA 588-4913 BRC BROOKLYN CENTER GRAD
RAKOR KAYE ELEANOR PVLIN TRLR HOUSE RALLS TERESA LEE 4000 24TH AVE SO RALPH JOHN ARTHUR 417 MURPHY ST RALSTON DOUGLAS EDMUND RALSTON DOUGLAS JAMES 14213 GLENRIDGE RD RALSTON NANCEE JAYNE COMSTOCK HALL RALSTON RAYMOND HAROLD 2309 E 1ST ST RALSTON ROGER ALAN RAMAKER DEEDRA ANN 6409 WENTWORTH RAMAKER RODNEY ALBERT 6409 WENTWORTH RAMANATHAN RAMACHANDRA RAMAPRIYAN HAMPAPURAM 514 14TH AVE SE RAMBECK CHARLES ARTHUR RAMBERG KRISTINE LOUIS 5906 GODDRICH AVE S RAMBERG ROBERT PADDOUK 3570 72ND ST E RAMBO STEVEN RONALD FRONTIER HALL RAMBOSEK JUNE ALICE 2002 N LEE RAMBOW RONNA LEONE SPOONER HALL RAMEE META BAILY HALL RAMES BARBARA WEIR LEW 4513 WASHBURN AVE SO RAMEY DEBORAH ANNE PIONEER HALL RAMEY EVELYN MARTINSON 2913 NOBLE RAMIN OPAL DYRSTAD 5225 E TWIN LAKE BLVD RAMIREZ DAVID JOSEPH 2024 16TH AVE SO RAMIREZ GARY JAMES 4016 23RD AVE SO RAMIREZ KATHLEEN MARIE 4016 23RD AVE S	68 ED 338-5429 MPL 70 MORRS 589-2639 MADISON 71 CLA 721-4146 MPL MINNEAPOLIS 68 GC 423-1349 RDS ROSEMOUNT GRAD GRAD 935-2578 MTV MINNETONKA 69 CLA MPL ROCHESTER 68 DULTH VIRGINIA 70 CLA VIRGINIA 71 AGFHE 869-0259 RHF RICHFIELD 68 CLA 869-0259 RHF RICHFIELD GRAD GRAD 331-9370 MPL BANGALORE GRAD 71 CLA 929-6027 SLP ST LOUIS PARK 71 CLA 451-0364 ING INVER GROVE 70 CLA MPL VERNON CENTER 68 CLA 771-9055 MPW MAPLEWOOD 70 MORRS 589-4693 RAYMOND 70 AGFHE 545-5123 STP ST LOUIS PARK AS CLA MPL 71 CLA MPL GERMANY 69 AGFHE 588-3294 GDV 70 CLA 537-1130 BRC 70 CLA MPL MINNEAPOLIS 68 GC MPL MINNEAPOLIS 68 GC 722-8028 MPL MINNEAPOLIS	RAND ROBERTA JEAN 525 UNIVERSITY SE RANDALL CASEY STEVEN 4505 EWING AVE SO RANDALL GYLES WADE 1100 JACK AVE SE RANDALL CMO JAMES RT 5 BOX 59 RANDALL LOU ELLEN 912 E 7TH ST RANDALL LYNN HARRIETT 340 LIECESTER RANDALL ROBERT KENT 806 W IDAHO AVE RANDALL SUSAN ANNE 319 OAK ST SE RANDELIN DALE RUSSELL 815 W PROSPECT RANGGAARD THOMAS EDWAR TERRITORIAL HALL 163 RANDLE GLADYS MARIE 610 EMERSON AVE N RANDLE ROBERT GEORGE 217 SO CEDAR LK RD RANDLE THOMAS VANE 3246 GIRARD AVE SO RANDOLPH JOHN 1404 W FRANKLIN AVE RANDOLPH JUDITH ANN 105 W ORANGE ST RANDOLPH PATRICIA JEAN 825 N 12TH AVE E RANDY ROCHELLE JUANITA 330 5TH AVE SE RANG EDWARD ROY 345 E 53RD RANHEIM PHILLIP JOHN RANK BENJAMIN HARVEY RANK ELLEN FRANCES 1721 BROOK AVE SE	68 CLA STP MINNEAPOLIS 68 CLA MPL HIGHLAND IN 69 ED 484-5327 MPW MAPLEWOOD 69 IT 521-0440 MPL MINNEAPOLIS 69 GC 338-2622 MPL 69 GC 926-7842 MPL MINNEAPOLIS GRAD 331-7391 MPL WANAMINGTO 68 GC 474-9737 EXC EXCELSIOR AS DULTH 724-1707 DULUTH 69 DULTH 724-4316 DULUTH 70 CLA 489-5557 STP ST PAUL 70 CLA MPL ST PAUL 71 DULTH 879-5791 CLOQUET 71 IT 373-6384 MPL GLENCOE AS GC 374-3677 MPL 71 CLA 374-1185 MPL DES MOINES IA 69 GC 822-3021 MPL DES MOINES IA 69 IT 377-0951 MPL MINNEAPOLIS 70 DULTH 722-0312 DULUTH 70 DULTH 728-1703 DULUTH 68 CLA MPL CHISHOLM GRAD 822-7850 MPL MILWAUKEE WI GRAD GRAD 71 CLA 331-7868 BLT BLOOMINGTON	RASCH CARROLL HERBERT RASCH JAMES WILLIAM 2036 CHAMBERS ST RASCHKA SUSAN JOANNE 5400 NEWTON AVE SO RASK ANDREA CHRISTINE RASK ANTHONY STEVEN 5311 15TH AVE SO RASK DEAN ROYAL 2908 BRYANT AVE SO RASK PAMELA ANN COMSTOCK HALL RASK RICKY KAY 2908 BRYANT AVE SO RASKE LELAND OWEN 2136 FRY RASMUSON MICHAEL ALAN 3407 ZARTHAN AVE RASMUSSEN CAROL SUE PIONEER COURT RASMUSSEN DAVID GEORGE 5703 23RD AVE SO RASMUSSEN DAVID PAUL 960 COBB RD RASMUSSEN GAIL MARIE 3229 34TH AVE S RASMUSSEN JAMES EARLE 4228 MORGAN SO RASMUSSEN JANE CLARB 2137 MPLS AVE SO RASMUSSEN JAYNE MELBONE 409 97TH AVE NW	GRAD 70 IT 484-4015 STP ST PAUL 68 ED 927-9653 MPL MINNEAPOLIS 69 ED ISANTI 70 CLA 823-2259 MPL MINNEAPOLIS GRAD 822-3803 MPL GRACEVILLE 70 CLA MPL HIBBING 69 CLA 822-3803 MPL WARREN MI 70 AGFHE STP RENVILLE 70 CLA 929-4108 SLP ST LOUIS PARK 71 CLA 739-7128 MPL ST PAUL 68 IT 944-9208 MPL MINNEAPOLIS 71 CLA 484-3082 SHV SHOREVILLE 70 CLA 729-1603 MPL MINNEAPOLIS 70 IT 869-4586 RHF RICHFIELD 69 ED 333-0943 MPL MINNEAPOLIS 70 CLA 784-8729 CNR COGN RAPIDS





REITER CURTIS EDWIN BAILEY HALL REITER DAVID EDWARD 1619 CARL ST REITER MARYJO JOAN 208 PLEASANT LN REITSMAN MICHAEL JAMES 2305 51ST AVE REITZ EMILY DOHERTY 59 MAPLE BEND DR REITZ LARRY GENE 3326 E LAKE ST REITZ MARCIA LYNN 1120 4TH ST SE REKDAHL ERIC KENT 3441 COLFAX AVE SO REKEDAL STEVEN ALAN 3516 25TH AVE SO REKOLA KATHLEEN SANDRA 5017 WYOMING ST REKOW MARLIN FRANCIS 600 CLEVELAND AVE RELF JANET LYNN SANFORD HALL RELLER CARL EDWARD 4919 ARLINGTON DR RELLER CARL RAYMOND JR	71 AGFHE 445-4449 STP SHAKOPEE 69 AGFHE 645-6311 STP OMATONNA 68 AGFHE 866-6605 RHF RICHFIELD 71 CLA MPL MINNEAPOLIS AS DULTH 71 IT 721-5470 MPL SHENANDDAH IA 70 CLA MPL ST CLOUD 68 IT 822-6446 MPL ST LOUIS PARK 68 CLA 724-1696 MPL HOWARD LAKE 68 DULTH 525-2071 70 DENT NWB MINNEAPOLIS 71 CLA 633-4246 MPL ST PAUL 71 IT WEB-1118 HOP HOPKINS GRAD	RENSLO PAUL DAVID 1998 BREWSTER ST RENSLOW MICHAEL EDWARD 3345 ALDRICH AVE N RENSTROM RICHARD SHELDO 4520 30TH AVE SO RENSTROM TERRI LYNN 1311 E MINNEHAMA RENTAS GEORGANNE CHARO 1023 12TH AVE SE RENTFROW NANCY RAE SANFORD HALL RENTZ STEPHEN BRUCE 104 COLUMBIA RENZ MICHAEL KENNETH 2604 SO 8TH ST RENZ ROBERT LEE 2 8443 4TH AVE SO REPASS MICHAEL JOHN 105 DEXTER HALL REPENSKY GREGORY ROY 410 N 77 AVE W REPETOWSKI DONALD JAME 830 24TH AVE SE REPETOWSKI EVELYN JANE 830 24TH AVE SE REPKIN ALLAN HARVEY 1225 ROSE VISTA CT REPS JILL MARIE SANFORD HALL REQUE FLORENCE HOLMES 218 E 2 ST REQUE SHERYL ANN 407 7TH ST SE RES ANGELICA PERRIS 2266 E MINNEHAMA RES ZANNIS GEORGE 3321 36TH AVE NE RESCH FRANK JOSEPH 1318 SPRING VALLEY RD RESCH GLENN ALLAN GRIGGS HALL B315 RESCH PATRICIA ANN 2308 WASHINGTON ND RESCH TIMOTHY MICHEL 2219 LINCOLN ST NE RESICK THOMAS MICHAEL 818 8TH ST SE APT 103 RESLER EDWARD CHARLES 1125 5TH ST SE RESNER SANDRA SUE 425 8TH AVE SE RESNICK JACK STEVEN 584 SNELLING AVE SO RESNICK JANE ELLEN 1903 PINEHURST RESSLER J DANIEL 1405 MADISON NE RESSLER JOHN WALTER 3516 46 AVE SO RESSLER THOMAS JAY 3516 46TH AVE SO RESTER STEPHEN 613 OAK ST SE RESURRECCION JOSEFINA	68 ED 644-8939 STP CALEDONIA 69 CLA 421-7159 ANK ANOKA 68 CLA 729-1022 MPL MINNEAPOLIS 71 CLA 774-2511 STP ST PAUL GRAD 331-9392 MPL MINNEAPOLIS 71 CLA 339-0931 MPL ST CHARLES 70 MORRS 589-1341 MORRIS 69 GC 339-3823 MPL MINNEAPOLIS 70 IT MPL MINNEAPOLIS GRAD 647-3328 STP WALLA WALLA WA 70 DULTH 624-0829 DULUTH 71 IT 331-1131 MPL MINNEAPOLIS 68 GC 331-1131 MPL MINNEAPOLIS GRAD 644-1736 STP CHICAGO IL 71 CLA MPL SPRING VALLEY 69 DULTH 724-8382 69 ED MPL REDWOOD FALLS 71 CLA STP 69 CLA MPL 71 CLA 588-3930 GDV GOLDEN VALLEY 71 DULTH 724-9856 71 AGFHE 529-0703 MPL MINNEAPOLIS 70 AGFHE MPL MINNEAPOLIS 68 CLA 331-9309 MPL ST JAMES 69 CLA 331-9191 MPL WHITE BEAR LAKE 68 CLA 331-1199 MPL SHAFER GRAD 699-6696 STP ST PAUL 71 CLA 699-6125 STP ST PAUL 70 ED 781-8245 MPL STILLWATER 68 IT 721-3626 MPL MINNEAPOLIS GRAD 721-3676 MPL MINNEAPOLIS GRAD 331-5951 MPL CLIFTON TX GRAD 70 CLA MPL ST CLOUD 69 IT 71 CLA 338-9341 MPL LE CENTER 68 IT 69 IT 451-3263 SSP SOUTH ST PAUL 68 GC 473-7144 LOL LONG LAKE 68 ED 645-1407 STP MORRIS 71 MORRS MORRIS 71 CLA 225-6800 STP ST PAUL 70 CLA 227-3942 STP ST PAUL 71 CLA 227-3942 STP ST PAUL 69 CLA 927-8041 MPL MINNEAPOLIS 69 CLA 927-8041 MPL JAMESVILLE WI 69 ED 823-8404 MPL MINNEAPOLIS 68 GC 474-9225 MPL EXCELSIOR 70 IT 645-3891 STP MAPLETON 69 ED 451-8790 SSP SOUTH ST PAUL 71 CLA 866-9558 RHF RICHFIELD 70 MED 331-1369 MPL MAZEPPA 69 CLA 888-3745 BLT BLOOMINGTON 71 AGFHE	REUVERS BARBARA ANN RT 1 REVANE BARBARA JANE BAILEY HALL REVESZ ERVIN 1521 UNIVERSITY AVE SE REVIER BONITA ROSE 70 CLA MAUBUN REVOR DENNIS JAMES 4456 30TH AVE SO REWAK WILLIAM JOHN 25 W ISLAND AVE REX EDGAR HOWARD JR 1613 WOODBRIDGE ST REYERSON MARIAN G REYES RONALD CLYDE 7427 OAKLAND AVE SO REYESTOLEDO ANA EUGENI 2020 22ND AVE SO REYNOLDS ALLAN JOSEPH 1898 EUSTIS ST REYNOLDS CHARLES ROBER 2521 W 70TH ST REYNOLDS CLYDE EDWARD 7960 DOANE TR SO REYNOLDS DOLORIS MARIE 321 N 46TH AVE W REYNOLDS DUANE ASHLEY 800 58TH AVE NO REYNOLDS HEMAN PERRY 707 5TH AVE SE REYNOLDS HENRY ARTHUR 647 BUCHANAN REYNOLDS JACQUELINE FR 1914 2ND AVE NO REYNOLDS JOAN IRENE 1631 CARL ST REYNOLDS KATHLEEN CGCI 3513 43RD AVE SO REYNOLDS LINDA SUE 1051 12TH AVE SE REYNOLDS LYLE CHARLES 3747 157TH AVE NW REYNOLDS WAYNE 315 UNIV SE REZNICK SHERYL TERRI 4331 25TH ST W RHEE HYUN KU 421 CEDAR AVE SO RHEE YIN SOG 1630 EUSTIS ST RHEINGANS CHARLES RICH	68 DENHY 645-5013 DUNDAS 71 CLA 938-4831 MTV MINNETONKA 70 CLA 336-9651 MPL MINNEAPOLIS 70 CLA MAUBUN 68 IT 724-0443 MPL MINNEAPOLIS GRAD 336-4671 MPL 70 LAW 488-3702 STP DEERFIELD IL AS GC 69 GC 869-4124 RHF RICHFIELD GRAD 338-8376 MPL CHILE 69 CLA STP ST PAUL 71 IT 866-8984 RHF RICHFIELD 70 CLA 451-1609 SSP SOUTH ST PAUL 71 DULTH 624-0528 DULUTH 71 CLA 561-3997 BRC BROOKLYN CENTER 69 CLA 331-3106 MPL LAKE OSWEGO OR 70 CLA 421-2359 ANK ANOKA 70 CLA 377-9580 MPL MINNEAPOLIS 70 CLA 646-0750 STP SKOKIE IL 68 CLA 729-0931 MPL MINNEAPOLIS 69 NURS 331-2798 MPL NORTFIELD 71 CLA HAI-1121 ANK ANOKA 70 CLA MPL MINNEAPOLIS 69 GC 922-3909 SLP ST LOUIS PARK GRAD 336-9784 MPL SEUL GRAD STP PUSAN 70 AGFHE 69 DULTH BUENA VISTA MOTEL RHINES MARTHA DUDLEY 1209D N 2 AVE E RHINES RAE ADELE 1209D N 2 AVE E RHOADES CHARLES ALFRED 9438 10TH AVE SO RHOADES TERRY GLENN 708 13TH AVE SE RHODES CHARLES SCHUMAN 1618 EUSTIS ST RHODES MAURICE JAMES 732 MARSHALL AVE RHODES STEPHEN ROBERTS 7 18TH AVE NO RHODES VIRGIL TERRANCE 9140 ALDRICH AVE SO RHODY LINDA WICKLANDER 4715 UNIVERSITY AVE NE RHOLL STEPHEN ARTHUR 4236 VINCENT AVE SO RHOLL VERNON OWEN 4236 VINCENT AVE SO RHUDE STEVEN ALLEN RHYMERS CRAIG ALLEN 5315 44TH AVE SO RIACH GERALD EDWARD RIBBLE NANCY LYNETTE 601 OAK ST SE RIBTICH LEWIS JAMES 519 3RD AVE SE RIBNICK JANICE LEE 2306 SUMTER AVE S RIBNICK JOHN JOSEPH 504 W FRANKLIN RICCELLI JO ANNE 4121 PERRY AVE NO RICCI DIANE CHRISTINE GRIGGS HALL K311 RICCI HARRY ANTHONY RICCI REBECCA ROCHELLE 4110 COOKE ST RICCI VICTOR JOSEPH 2407 N ST ALBANS RICCOBONO ANTHONY THOM BAILEY HALL RICE BARBARA MARIE 1320 7TH ST SE RICE GERALD DENNIS 4403 IRVING NO RICE HOWARD A RT 6 BOX 234	68 DENHY 645-5013 DUNDAS 71 CLA 938-4831 MTV MINNETONKA 70 CLA 336-9651 MPL MINNEAPOLIS 70 CLA MAUBUN 68 IT 724-0443 MPL MINNEAPOLIS GRAD 336-4671 MPL 70 LAW 488-3702 STP DEERFIELD IL AS GC 69 GC 869-4124 RHF RICHFIELD GRAD 338-8376 MPL CHILE 69 CLA STP ST PAUL 71 IT 866-8984 RHF RICHFIELD 70 CLA 451-1609 SSP SOUTH ST PAUL 71 DULTH 624-0528 DULUTH 71 CLA 561-3997 BRC BROOKLYN CENTER 69 CLA 331-3106 MPL LAKE OSWEGO OR 70 CLA 421-2359 ANK ANOKA 70 CLA 377-9580 MPL MINNEAPOLIS 70 CLA 646-0750 STP SKOKIE IL 68 CLA 729-0931 MPL MINNEAPOLIS 69 NURS 331-2798 MPL NORTFIELD 71 CLA HAI-1121 ANK ANOKA 70 CLA MPL MINNEAPOLIS 69 GC 922-3909 SLP ST LOUIS PARK GRAD 336-9784 MPL SEUL GRAD STP PUSAN 70 AGFHE 69 DULTH BUENA VISTA MOTEL RHINES MARTHA DUDLEY 1209D N 2 AVE E RHINES RAE ADELE 1209D N 2 AVE E RHOADES CHARLES ALFRED 9438 10TH AVE SO RHOADES TERRY GLENN 708 13TH AVE SE RHODES CHARLES SCHUMAN 1618 EUSTIS ST RHODES MAURICE JAMES 732 MARSHALL AVE RHODES STEPHEN ROBERTS 7 18TH AVE NO RHODES VIRGIL TERRANCE 9140 ALDRICH AVE SO RHODY LINDA WICKLANDER 4715 UNIVERSITY AVE NE RHOLL STEPHEN ARTHUR 4236 VINCENT AVE SO RHOLL VERNON OWEN 4236 VINCENT AVE SO RHUDE STEVEN ALLEN RHYMERS CRAIG ALLEN 5315 44TH AVE SO RIACH GERALD EDWARD RIBBLE NANCY LYNETTE 601 OAK ST SE RIBTICH LEWIS JAMES 519 3RD AVE SE RIBNICK JANICE LEE 2306 SUMTER AVE S RIBNICK JOHN JOSEPH 504 W FRANKLIN RICCELLI JO ANNE 4121 PERRY AVE NO RICCI DIANE CHRISTINE GRIGGS HALL K311 RICCI HARRY ANTHONY RICCI REBECCA ROCHELLE 4110 COOKE ST RICCI VICTOR JOSEPH 2407 N ST ALBANS RICCOBONO ANTHONY THOM BAILEY HALL RICE BARBARA MARIE 1320 7TH ST SE RICE GERALD DENNIS 4403 IRVING NO RICE HOWARD A RT 6 BOX 234
---	---	--	--	---	--	--





RILEY JOHN THOMAS 68 CLA F14-3489  
708 SO CEDAR LAKE RD  
RILEY KATHLEEN ANN 68 NURS 646-8857  
1847 NO PASCAL  
RILEY NICHOLAS HOWARD 70 DULTH  
BOX 604 BIWABIK

RILEY PATRICK GERALD 68 IT 225-4784  
544 PORTLAND AVE  
RILEY RUBY STEEN 69 GC 521-9574  
1316 DUPONT NO  
RILEY STEVEN WAHL 68 BUS 473-6023  
908 E SHADY LANE  
RILEY THOMAS NOLAN GRAD

RILEY TIMOTHY EDWARD 69 DULTH 729-7457  
2400 OAKLAND AVE  
RILEY WILLIAM PATRICK 70 CLA  
802 W MULBERRY STW STILLWATER

RILLING ROGER LEE 69 DULTH 724-6542  
912 WOODLAND AVE  
RINDELAUV STEPHANIE A 70 DULTH 724-9832  
GRIGGS HALL N113 HARSHALL

RINELL ROLAND JAMES 70 DULTH 722-8427  
6295 SWAN LAKE RD  
RINERSON DARRELL DEWAY 69 IT

RINEY RUBY MCLENDON GRAD 522-4068  
1611 PENN AVE NO  
RING DOUGLAS GRANT 69 BUS  
CENTENNIAL HALL  
RING JUANITA ANNE 70 CLA 938-9374  
14018 EXCELSIOR BLVD  
RING MARILYN LUCILLE 71 CLA  
SANDFORD HALL  
RING PATRICK EDMUND 70 CLA 588-7739  
3416 26 1/2 AVE NO  
RING SUSAN LOUISE 69 ED 941-1673  
5221 TIFTON DRIVE  
RING TERRY JUDITH 70 CLA 922-8359  
3430 W CALHOUN BLVD  
RINGBLOOM JANET KAY 70 CLA 926-0125  
5900 OAKLAWN  
RINGDAHL LEE RICHARD 68 DULTH 724-8862  
115 E BUFFALO ST  
RINGDAHL ROBERT ELLIS 70 DULTH 724-6722  
125 E BUFFALO ST  
RINGERUD CHET ALAN 69 CLA 929-1866  
5537 DUNDEE RD  
RINGHAM SANDRA LYNN 70 CLA 331-7269  
408 ERIE ST SE  
RINGHAM SUSAN JILL 70 CLA 331-5176  
708 UNIVERSITY AVE SE  
RINGOLD JOHN WILLIAM 68 PHARM 645-2824  
1697 N FRY  
RINGSRED MARGARET JO 69 DULTH 722-0915  
2929 LAKE AVE S  
RINGSRED MILA MATHESON AS DULTH 724-9202  
1002 GRANDVIEW AVE  
RINGSRED PATRICIA JEAN 70 DULTH 722-0915  
2929 LAKE AVE SO  
RINGSTROM BRUCE BERNAR 69 CLA 722-1716  
4826 32ND AVE SO  
RINGSTROM JOHN DENNIS 68 IT 561-5343  
3724 VIDLEY AVE NO  
RINGUETTE RICHARD PAUL 68 AGFHE 645-3853  
1230 GIBBS AVE COMM TER STP JAMESTOWN ND  
RINGWELSKI ELIZABETH M 71 CLA 789-6479  
3434 2 1/2 ST NE  
RINGWELSKI FRANK MAXIM AS IT

RINGWELSKI MARGARET MA 71 CLA 789-6479  
3434 2 1/2 ST NE  
RINKEY BENJAMIN SAMUEL 69 CLA 699-2359  
1290 S DAVERN  
RINKEY CHARLES 70 CLA 699-6476  
1770 HARTFORD  
RIPKEN STEVEN PHILIP 68 BUS  
1218 7 ST SO  
RIPLEY CATHY ANN 68 CLA

RIPLEY DARLA JOYCE 71 IT 645-9241  
BAILEY HALL  
RIPLEY MICHAEL JAMES 68 CLA 645-9607  
1303 GIBBS AVE  
RIPLEY RICHARD LOUIS 68 CLA 922-1745  
5925 CONCORD AVE SO  
RIPLEY STEVEN RICHARD 68 IT 645-8749  
1626 EUSTIS ST  
RIPPENTROP HARVIN LYLE 68 ED 331-5295  
725 8TH AVE SE  
RIPPEY JOAN ELLEN 68 ED

RIPPIE CARL ERWIN JR 69 GC 533-5225  
3852 GEORGIA AVE NO  
RISBRUDT MONICA ROSEA 70 CLA 331-1534  
418 ERIE ST SE  
RISCH DOUGLAS MARTIN 68 IT

RISCH JAMES THOMAS 71 CLA  
TERRITORIAL HALL  
RISCH MARY CATHERINE 68 CLA 926-3869  
4223 SCOTT TERRACE  
RISDALL ROBERT JOHN 70 CLA 336-9359  
1011 4TH ST SE  
RISDALL SHERMAN LANE 71 DULTH 879-7859  
609 SUNNYSIDE DR  
RISIUS JOHN HERBERT 69 CLA 338-7420  
617 20TH AVE SO  
RISK RORY JOHN 69 GC  
3021 DOUGLAS DR

RISKU CAROL MAE 69 DULTH 624-9538  
4425 W 8TH ST  
RISLEY RICHARD FRANKLI 71 CLA 533-6280  
3624 ADMIRAL LN  
RISLOVE GERALD AMBLE 70 ED  
627 6TH ST SO  
RISLOVE RICHARD ALLEN 68 CLA 331-1088  
809 11TH AVE SE  
RISSEY JUDITH ELLEN 70 AGFHE 633-7603  
600 CLEVELAND AV SW  
RISSEY LAURENCE EVANS GRAD 823-4070  
4929 FREMONT AVE SO  
RIST DANIEL VICTOR 70 CLA 866-2748  
5820 ELLIOT AVE S  
RISTINE CAROLINE ANN 69 CLA 644-6494  
970 CHARLES AVE  
RISTINEN TERRY LEE 70 DULTH 724-3452  
308 E 8TH ST  
RISTOW DENNIS DEAN 70 DULTH 724-3452  
910 E 6 ST  
RISTON SANDRA SEIF SUE GRAD 866-2344  
6920 MORGAN SO  
RISTUBEN BARBARA LOU RHF  
522 YORK AVE  
RISTUBEN ROBERTA NANCY 68 ED 774-1652  
522 YORK AVE  
RISTUBEN STEVEN JOHN GRAD

RITSTVED RAYMOND EARL 70 PHARM  
FRONTIER HALL  
RISVOLD KENNETH INGVAL 71 CLA 721-8954  
3226 39TH AVE SO  
RISVOLD MARY LEE 69 GC WA6-8548  
6917 HILLCREST LANE  
RISVOLD SHARAN JEANNE 68 CLA 869-8630  
6701 ELLIOT AVE SO  
RISVOLD SUSAN ANN 68 ED 926-8548  
6917 HILLCREST LANE  
RITCHEIE CLYDE HOWARD 69 DULTH 727-2939  
131 E 2 ST  
RITCHEIE JAMES OLIVER 69 GC 729-8647  
3744 45TH AVE SO  
RITCHEIE JOHN JAMES GRAD

RITCHEIE MARY SANDERS J 69 DULTH 727-1870  
5915 HAINES RD  
RITCHEIE MICHAEL EDWARD 70 CLA 722-3161  
2705 40TH AVE SO  
RITCHEIE STEVEN ROBERT 70 CLA 861-3727  
312 W 65TH ST  
RITCHEIE TRUDY HANSON K 70 DULTH 624-5343  
312 6 AVE  
RITT MARSHA LYNN AS ED 698-1318  
2164 LOWER ST DENNIS RD STP ST PAUL  
RITTEN LUCINDA LEE 68 GC  
410 NARCISUSS LANE  
RITTENHOUSE CAROL BREK AS ED 588-5997  
4336 BEARD AVE NO  
RITTER ALEXANDER FRENC 68 IT  
3231 36TH AVE SO  
RITTER DOROTHY ANN GRAD 331-9147  
1409 COMO SE  
RITTER GREGORY HUGH 68 ED 699-5921  
1737 BAYARD AVE  
RITTER GRETCHEN STEEM 70 CLA 331-8429  
515 DELAWARE ST SE  
RITZER JOANNE CAROL 69 ED 545-4367  
2534 OREGON AVE S  
RITZER MARY CATHERINE GRAD 331-9147  
1409 COMO AVE SE  
RITTER PATRICK KEVIN 71 CLA 699-8808  
2037 SARGENT  
RITTER WALTER WILLIAM 68 CLA 429-1672  
2511 HOMEWOOD PLACE  
RITTERBUSCH ROBERT LOU 69 CLA 226-0304  
431 MARSHALL AVE  
RITTGERS KARIN JEAN 69 PHARM 339-0531  
POWELL HALL  
RITTMANN ROGER ALLEN 70 IT 827-2089  
3236 COLUMBUS AVE SO  
RITZEN MICHAEL JOSEPH GRAD 333-7690  
429 JEFFERSON ST NE  
RIVARD ALLEN JAMES 71 IT  
TERRITORIAL  
RIVARD ANN MARGARET 71 CLA 869-5885  
7426 ELLIOT AVE  
RIVARD JAMES PETER RHF RICHFIELD  
28 OAK KNOLL DRIVE  
RIVARD ROBIN LEE 71 CLA  
WHITE BEAR LAKE 11 E 9TH ST  
TAYLORS FALLS

RIVENESS PHILLIP JONAT 70 CLA 339-1723  
1310 8TH ST SE  
RIVERA AUGUST GRAD

RIVERA REINALDO 71 CLA 373-6918  
319 FRONTIER HALL  
RIVERS LAWRENCE ALFRED GRAD  
125 E 9TH ST  
RIVET MICHELLE ANN 70 CLA 699-3352  
1373 SCHEFFER AVE  
RIVKIN DAVID BRUCE 70 CLA 922-0693  
3725 GLENHURST SO  
RIX CHARLES HARLAN SLP ST LOUIS PARK  
349 HESMAN TER  
RIXMANN MIRIAM JOYCE 70 CLA 935-5678  
4336 OAKLAND SO  
RIZZATO MARYANN THERES GRAD 332-2643  
134 WARWICK ST SE  
RIZZI ROSE MARY 69 DULTH 626-3146  
1514 99TH AVE W

ROACH RICHARD RALPH 69 DULTH 624-9538  
2084 ROTH PL  
ROACH LONNIE CHARLES 71 CLA 533-6280  
DULUTH  
MPL MINNEAPOLIS  
70 ED  
MPL PRESTON  
68 CLA 331-1088  
MPL PRESTON  
70 AGFHE 633-7603  
NWB NEW BRIGHTON  
GRAD 823-4070  
MPL STEWARTVILLE  
70 CLA 866-2748  
MPL MINNEAPOLIS  
69 CLA 644-6494  
STP ST PAUL  
70 MORRS  
MENAHGA  
70 DULTH 724-3452  
MORRIS  
GRAD 866-2344  
RHF  
69 NURS 774-1652  
STP ST PAUL  
68 ED 774-1652  
STP ST PAUL  
GRAD

ROACH RICHARD RALPH 71 DULTH 525-5591  
4313 LONDON RD  
ROADFELDT JOHN EDWARD 71 DULTH 724-9841  
TORRANCE HALL 114  
ROADFELDT PAMELA DORIS 70 AGFHE 645-9241  
310 BAILEY HALL  
ROADSTAD DOUGLAS JOHN 68 GC

ROAN PAMELA MARIAN 70 CLA 646-3948  
2341 COMMONWEALTH  
ROAZEN IRWIN HARVEY GRAD

ROBACK STACY ARI GRAD

ROBAN IRENE ELIZABETH 71 CLA PA2-0950  
4449 47TH AVE SO  
ROBAN JAMES GEORGE 70 LAW FEB-4414  
2615 ELLIOT AVE SO  
ROBB DENNIS MICHAEL MPL MINNEAPOLIS  
GRAD

ROBB GAY ESTILL GRAD

ROBB MARY ELIZABETH 68 ED

ROBB STEPHEN ANTHONY GRAD 329-5869  
4904 28TH AVE SO  
ROBB WILLIAM STEVEN MPL MINNEAPOLIS  
69 CLA 699-0501  
STP ST PAUL  
1595 BOHLAND  
ROBBIE MICHELLE MARIE 69 CLA 373-9395  
520 COMSTOCK HALL  
ROBBINS CHERYL RAE 70 CLA 429-2321  
3915 MC KNIGHT RD  
ROBBINS CLIFTON J 71 CLA 645-1318  
936 AURORA AVE  
ROBBINS EDWARD JAY 69 ED 699-3403  
1048 ST PAUL AVE  
ROBBINS JAMES PHILIP 70 CLA WA6-4287  
2901 QUENTIN  
ROBBINS JAN CLIFTON GRAD 645-1758  
1224 ROSE VISTA COURT  
ROBBINS JOAN KAY 70 CLA 429-2321  
3915 MCKNIGHT RD  
ROBBINS SCOTT CHARLES 70 IT 331-2810  
1800 COMO AVE SE  
ROBERSON DALE WARREN MPL MINNEAPOLIS  
DEXTER HALL  
ROBERSON JOYCE KAY 70 AGFHE 647-3505  
4424 5TH AVE SO  
ROBERSON LITA T 69 GC 824-0833  
1822 HAYES NE  
ROBERT GREGORY RALPH GRAD 789-3695  
70 IT

ROBERTS BARBARA REYNOL GRAD 331-5916  
918 1/2 UNIVERSITY SE  
ROBERTS CAROLYN SUE MPL  
BURNSIDE HALL 156 71 DULTH 724-9914  
ROBERTS CHERYL KAY NEW YORK MILLS  
SANFORD HALL 70 CLA 373-6663  
ROBERTS CLIFTON EMERY MPL NEW ULM  
1125 9TH ST SE 70 CLA 331-2792  
ROBERTS DEAN 70 AGFHE 646-7704  
2103 DOSWELL AVE  
ROBERTS DEBORAH JUNE STP LAKB CRYSTAL  
RT 1 BOX 27B 71 CLA 471-9513  
WAY WAYZATA  
ROBERTS DIANE MAXINE 69 GC 825-9744  
3305 GRAND S  
ROBERTS DONALD JOHN MPL MINNEAPOLIS  
5036 THOMAS ND 69 GC 521-2732  
ROBERTS DONALD JOHN MPL MINNEAPOLIS  
4556 MADISON ST NE GRAD 788-5395  
ROBERTS DONALD LINNE 71 DULTH 834-4009  
531 12TH AVE  
ROBERTS FRANCIS MICHAEL 71 MORRS 458-3430  
BOX 6 WENDELL  
ROBERTS GARY GUNNAR LA 69 GC 823-2732  
3521 OAKLAND  
ROBERTS GEORGE JEFFREY 68 BUS 338-3342  
407 7TH ST SE  
ROBERTS HAROLD GREGG 69 BUS 926-8565  
4909 W SUNNYSLOPE RD  
ROBERTS HERBERT ALLEN 68 MORRS 589-3078  
11 E 9TH ST  
ROBERTS JILL MARIE 70 CLA  
708 SE 5TH ST  
ROBERTS JOE DONALD GRAD 331-5916  
918 1/2 UNIVERSITY AVE  
ROBERTS MARGERY ANN MPL STILLWATER OK  
68 PT

ROBERTS MYRNA MORRISON GRAD 338-2734  
1535 E RIVER TERR  
ROBERTS RICHARD DEAN MPL ABILENE TX  
1741 HWY 96 70 CLA 429-5041  
ROBERTS RICHARD THOMAS 69 DULTH 724-9810  
GRIGGS HALL A217 BUHL  
ROBERTS RUSSELL JAMES 68 PH 263-2905

ROBERTS SALLY KLINE LE 70 CLA 560-6244  
5917 4TH ST NE FRD FRIDLEY  
ROBERTS SUSAN STRAUSS GRAD 331-6608  
1033 24TH AVE SE  
ROBERTS THOMAS WAYNE MPL DANVILLE IL  
TERRITORIAL HALL 71 IT 373-6455  
ROBERTS WILLIAM JOSEPH GRAD 331-6608  
1033 24TH AVE SE MPL WATSEKA IL

ROBERTSHAW LINDA KATHE 70 CLA 336-7894  
2002 PARK AVE S MPL FARIBAULT  
ROBERTSON CHARLES FRAM 70 AGFHE 755-3826  
11620 KUMQUAT CNR COON RAPIDS  
ROBERTSON DALE THOMAS 68 GC 224-8068  
1030 KRUSE ST WSP WEST ST PAUL  
ROBERTSON DARREL GENE 70 CLA 224-8068  
1030 KRUSE ST WSP WEST ST PAUL  
ROBERTSON JAMES CARL 70 CLA 823-2908  
BOX 5562 LAKE ST STA MPL  
ROBERTSON JAMES MICHAEL 70 CLA 922-9400  
5100 W 40TH ST SLP ST LOUIS PARK  
ROBERTSON JAMES R 70 CLA 698-2443  
495 SO HAMLINE STP GREENBAY WI  
ROBERTSON JOHN LOWELL 70 CLA 427-1562  
308 BRISBEN AVE ANK WILLIAMS  
ROBERTSON JULIANN MARI 69 GC 644-9302  
1505 MIDWAY PKWY STP ST PAUL  
ROBERTSON LEONARD 70 CLA 331-3713  
516 12TH AVE SE MPL NORTHPORT NY  
ROBERTSON LINDA MAE 70 CLA 521-9655  
3026 GIRARD AVE NO MPL MINNEAPOLIS  
ROBERTSON PEGGY LYNN 69 ED 922-8879  
2801 HUNTINGTON AVE SLP WILLMAR  
ROBERTSON ROBERT EDWARD 70 CLA 711-7862  
434 ENGLISH STP BUFFALO  
ROBIN JAMES GEORGE 70 IT  
ROBIN JAMES RAND 68 CLA  
3315 30TH N ROB  
ROBIN SANDRA CATHERINE 70 CLA 521-9363  
3431 MORGAN AVE ND MPL MINNEAPOLIS  
ROBINETTE JAMES DAVID 71 CLA 339-2404  
319 8TH ST SE APT 201 MPL SHAKOPEE  
ROBINETTE LINDA ANN 71 CLA 445-1852  
ROUTE 1 BOX 4A SHK SHAKOPEE  
ROBINS BRUCE ALAN 69 GC 645-7062  
1233 ROSE VISTA CT STP ST PAUL  
ROBINS JUDITH BARBARA 68 ED 646-3006  
992 MARSHALL AVE STP ST PAUL  
ROBINS LEONARD SHERWIN 70 CLA 922-3668  
4421 MINNETONKA BLVD SLP ST LOUIS PARK  
ROBINS MICHAEL HARRY 70 CLA 698-3988  
1725 JAMES AVE STP ST PAUL  
ROBINSON AUGUST ROBERT 70 CLA 776-7720  
1100 BARCLAY STP  
ROBINSON BEVERLY JOAN 70 AGFHE  
ROBINSON BEVERLY LYNN 68 NURS 331-1671  
1014 FULTON ST SE MPL BALATON  
ROBINSON CAROL MARIE 71 DULTH 345-3435  
BOX 12 BUHL  
ROBINSON CAROLYN IRENE 70 CLA 729-2698  
5457 30TH AVE SO MPL MINNEAPOLIS  
ROBINSON CHARLIE 70 CLA 823-6761  
4297 COLUMBUS AVE MPL  
ROBINSON COLIN BOYD 70 CLA 823-7264  
2730 HENNEPIN MPL KIMBALL  
ROBINSON CRAIG ARTHUR 71 IT 825-3770  
3404 FREMONT AVE SO MPL MINNEAPOLIS  
ROBINSON CURTIS GAEL 68 BUS 788-4858  
4050 4TH ST NE CLH OSAKIS  
ROBINSON DAMN CHERYL 69 GC 521-0978  
1327 SHERIDAN AVE N MPL MINNEAPOLIS  
ROBINSON DOUGLAS NYE 69 CLA 331-1326  
1725 UNIV AVE SE MPL GREAT FALLS MT  
ROBINSON EDGAR ALLAN 70 IT  
1779 THOMAS AVE MPL CLARION IA  
ROBINSON EDWARD MARTIN 71 CLA 488-3938  
2066 WILLIAMS ST ROV ROSEVILLE  
ROBINSON FLOYD LEE 69 GC 529-2553  
5101 JAMES AVE N MPL MINNEAPOLIS  
ROBINSON FREDERICK ED 69 CLA  
CENTENNIAL HALL MPL AUSTIN  
ROBINSON GREGORY AMES 70 CLA  
SIOUX CITY IA  
ROBINSON HENRY JOHN 68 BUS 332-3039  
717 UNIVERSITY AVE SE MPL GRAND RAPIDS  
ROBINSON JAMES HOWARD 68 IT 373-5887  
1827 UNIVERSITY AVE SE MPL DELMAR NY  
ROBINSON JAMES L 70 AGFHE  
ROBINSON JAMES RALPH 70 MORRS 589-3121  
BLAKELY HALL WINDOM  
ROBINSON JAMES RAY 68 GC 488-2117  
993 W DRAPER STP ST PAUL  
ROBINSON JEFFREY ALLEN 68 BUS HA6-7538  
3410 W CALHOUN BLVD MPL MINNEAPOLIS  
ROBINSON JOAN MARGARET 70 CLA  
16500 TONKAWAY HTV MINNETONKA  
ROBINSON JULIA WILLIAM 68 CLA 722-5843  
2317 30TH AVE SO MPL  
ROBINSON KAREN ELAINE 70 CLA 373-7134  
COMSTOCK HALL MPL RUSH CITY  
ROBINSON KIM LESLIE 71 CLA 927-7531  
2848 FRANCE AVE SO SLP ST LOUIS PARK  
ROBINSON LESLIE 71 CLA 374-1367  
1711 EMERSON AVE SO MPL MINNEAPOLIS  
ROBINSON LOREN EUGENE 71 CLA 824-7909  
620 W MINNEHAHA PKWY MPL MAHOMET  
ROBINSON MARY LOUISE I 69 CLA 781-3747  
3422 LINCOLN ST NE MPL MINNEAPOLIS  
ROBINSON MARYJO ELIZAB 69 CLA 644-6548  
1490 SHERBURNE AVE STP ST PAUL  
ROBINSON NANCY LEE 68 ED 825-2890  
4017 14 AVE SO MPL MINNEAPOLIS  
ROBINSON PEGGY JANE 71 CLA 331-9005  
515 DELEMARE SE MPL HOYT LAKES  
ROBINSON SANDRA MEYER 71 CLA 724-7884  
5036 17TH AVE SO MPL  
ROBINSON STEPHEN WILLI 69 DENT 869-4028  
7032 GARFIELD AVE RHF RICHFIELD  
ROBINSON SUSAN AGNES 69 IT  
ROBINSON THOMAS WINSTO 68 IT 336-2004  
48 27TH AVE SE MPL WINONA  
ROBINSON TIMOTHY CARL 70 CLA 464-5893  
309 W BROADWAY GRAD  
ROBINSON WILLIAM FRED 71 CLA 473-5738  
120 CIRCLE A DR FOL  
ROBINSON GORDON DENNIS 68 BUS  
ROBITZ KAREN SUE 69 GC WA6-0023  
2839 JOPPA AVE SLP ST LOUIS PARK  
ROBITZ RENEE LOUISE 69 ED WA6-0023  
2839 JOPPA AVE SLP ST LOUIS PARK  
ROBLES MANUEL AUGUSTO 69 ED 339-3748  
2411 8TH ST S MPL  
ROBLIN CAROL TUFTS 70 IT  
627 6TH ST S GRAD  
ROBNIK SPENCER LOUIS 70 CLA 884-2979  
1711 IRVING CURVE MPL WEST TISBURY MA  
ROCCIO ALAN FRANCIS 68 DULTH  
BLT CHISHOLM  
ROCCO BARBARA ANN 71 CLA 488-4063  
868 W IOWA STP ST PAUL  
ROCHAT THOMAS RONALD 69 CLA  
925 6TH ST SE MPL ST LOUIS PARK  
ROCHE DONALD LOUDON 70 CLA  
5007 FREMONT SO MPL MINNEAPOLIS  
ROCHE PATRICIA MAE 69 DULTH 724-9927  
GRIGGS HALL K313 HIBBING  
ROCHE PATRICK JAMES JR 68 LAW 331-1523  
1010 15TH AVE SE MPL INTERNAT FALLS  
ROCHFORD KAY JEAN 71 CLA 522-8694  
3647 VINCENT AVE N MPL MINNEAPOLIS  
ROCHELEAU RAINER GRELL 71 MED  
1186 GIBBS AVE STP DULUTH  
ROCHKES PATRICIA ANNE 70 CLA 929-9061  
5348 HOLLYWOOD RD EDN EDINA  
ROCK CARLTON DANIEL 69 IT JU8-4716  
5218 ST CROIX AVE GDV GOLDEN VALLEY  
ROCK NORMAN ALFRED 69 GC  
ROCK, LINDA DULTH 727-5252  
620 E 2 ST DULUTH  
ROCKIR MARSHA SUE 71 PHARM 522-8941  
1655 QUEEN N MPL MINNEAPOLIS  
ROCKLAND MICHAEL AARON GRAD  
ROCKLER JANE DEBORAH 70 CLA 544-7473  
8000 W 18TH ST SLP ST LOUIS PARK  
ROCKLER KENNETH MARK 70 CLA 545-4540  
516 CLOVER LEAF DR GDV GOLDEN VALLEY  
ROCKLER MARJORIE SUE 69 GC  
ROCKLER MICHAEL JEROME 70 CLA 920-4735  
2938 EWING AVE SO MPL MINNEAPOLIS  
ROCKLIN BONNIE JILL 70 CLA 935-7041  
9011 W 34TH ST SLP ST LOUIS PARK  
ROCKMAN RLYNN CRAIG 69 MORSC 774-9797  
835 JOHNSON PKWY STP CHESTER NY  
ROCKNE MARY ELLEN 71 CLA 935-1015  
HOP HOPKINS  
ROCKNE MICHAEL JAY 70 CLA 881-5397  
8235 11TH AVE SO BLT BLOOMINGTON  
ROCKSTROM JOANN AUDREY 70 CLA 735-0013  
1868 STILLWATER AVE AS GC  
ROCKSTROM JOHN MICHAEL 70 CLA 224-3991  
188 ALTMAN CT STP ST PAUL  
ROCKSTROM MARY ELIZABE 70 CLA 335-4762  
1807 WASHINGTON AVE SO MPL ST PAUL  
ROCKSWOLD GORDON ALVIN 70 MED  
631 OAK ST NU SIGMA NU MPL MADISON  
ROCKVAM LELAND NORMAN 70 IT  
CENTENNIAL HALL MPL ROCHESTER  
ROCKWELL GEORGE DAVID 71 CLA  
TERRITORIAL HALL MPL SHAKOPEE  
ROCKWELL GEORGE JAMES GRAD  
ROCKWELL JO LYNN 71 CLA 332-9637  
1308 5TH ST SE MPL MINNEAPOLIS  
RODA BETTE SUE 70 CLA 815-6TH ST SE AS BIOSC  
RODBERG KATHY FAYE 70 DULTH 626-1400  
9513 GRAND AVE DULUTH  
RODDY DAVID THOMAS 69 IT 881-4020  
10200 XERXES AVE SO BLT BLOOMINGTON  
RODE JOHN EDWARD 70 LAW 776-8257  
1126 5TH AVE SE MPL ST PAUL  
RODE TERRILL LLOYD 70 CLA 226-8902  
226 W ROBBIE STP WHITE BEAR LAKE  
RODEBERG EVAN TORIUS 71 CLA  
MONTEVIDEO  
RODEL ELLA MAE 69 CLA 331-8059  
321 12TH AVE SE MPL BIRD ISLAND  
RODELL CHARLES FRANKLI GRAD 331-2103  
931 22ND AVE SE MPL LA CROSSE WI  
RODDE LAURENCE MOEL 68 GC 533-6553  
9430 BASS LAKE RD NWH ELK RIVER  
RODEY GLENN EUGENE GRAD 373-2748  
BOX 494 MPL MANSFIELD OH  
RODGERS DANIEL LADANE GRAD  
RODGERS JAMES HENRY 71 CLA ST1-7727  
3566 FILLMORE ST NE MPL MINNEAPOLIS  
RODGERS JEAN MARIE RIM 71 CLA 644-3850  
534 CURFEW ST STP ST PAUL  
RODGERS LAWRENCE CHARL GRAD  
RODGERS ROBERT WILLIAM 71 DULTH 724-9810  
GRIGGS HALL AZ17 SILVER BAY  
RODGERS SUSAN STIRLING 70 NURS  
POWELL HALL MPL CHICOPEE FLS MA  
RODI LUANN JANE 71 CLA 771-3723  
1307 BIRMINGHAM STP ST PAUL  
RODIE DOROTHY MARCELLA 69 ED 781-7135  
1315 28TH AVE NE MPL  
RODIN JAMES ALAN 68 CLA 729-3214  
5656 22ND AVE SO MPL MINNEAPOLIS  
RODMAN DEAN RICHARD 71 CLA 771-7592  
1335 CLARENCE STP ST PAUL  
RODMAN JOHN HARRY 70 CLA  
1360 WESTERN AVE STP  
RODMAN LYNN KAY 70 CLA 771-7592  
1335 CLARENCE STP ST PAUL  
RODNE GUNNBJORG 71 DULTH 727-6636  
914 E 2ND ST TOFTE  
RODNE KJELL JOHN 70 DULTH  
103 N 7TH AVE E TOFTE  
RODNER CAROLE JEAN GRAD 332-2912  
715 UNIVERSITY AVE SE MPL BLOOMINGTON IL  
RODNEY DIANA MARY 71 CLA  
SPOKANE WA  
RODRIGUE FLOYDEEN LITS GRAD 771-7844  
1355 E ARLINGTON STP  
RODRIGUE RONALD JOHN GRAD 771-7894  
1355 E ARLINGTON AVE STP  
RODRIGUEZ CLARA INES GRAD  
RODUM DIANA MARGARET 70 CLA  
815 13TH AVE SE MPL WAYZATA  
ROE SHARON LOUISE 70 CLA 377-5685  
2423 LAKE PLACE MPL LAS VEGAS NV  
ROE VICKI CORINNE 71 CLA 454-4628  
2062 OPAL DR  
ROEBER LAREE JEAN GRAD  
SANFORD HALL MPL REDFIELD SD  
ROED NANCY KAY 70 DULTH 722-8129  
2444 HARVEY ST DULUTH  
ROEDLER GEORGE ROBERT 69 LAW 644-3365  
186 MONTROSE PL STP ST PAUL  
ROEDCKER ROBERT LOUIS 69 GC 929-3051  
4232 ALABAMA AVE SO SLP ST LOUIS PARK  
ROEGGE MARILYN PANNING 68 ED 922-3623  
5500 NEWTON AVE SO MPL HAMBURG  
ROEHL CANDICE ANN 71 CLA 333-7339  
917 15TH AVE SO MPL MINNEAPOLIS  
ROEHL PATRICIA ANN 70 CLA 521-0731  
4216 RUSSELL NO MPL MINNEAPOLIS  
ROELOFS ROBERT IRWIN GRAD 645-3595  
1772 PLEASANT ST ROCK VALLEY IA  
ROEMER JOHN JACOB JR 68 IT 338-2143  
330 5TH AVE SE MPL TAMAQUA PA  
ROEMER MARGARET LOUISE 70 CLA  
COMSTOCK MPL WINONA  
ROEN JANICE ALMA 69 DENNY  
COMSTOCK HALL MPL MADISON  
ROEN PAUL MICHAEL 70 DULTH 834-3855  
GODSEBERRY FALLS ST PK TWO HARBORS  
ROEN PETER ERIC 69 DULTH 628-1382  
3399 CARIBOU LAKE RD DULUTH  
ROEN RANDOLPH PERRY 68 IT 633-0807  
1945 EDGEWATER AVE ANH DULUTH  
ROENFELDT LLOYD 70 AGFHE  
1212 YALE PLACE MPL ROCHESTER  
ROEPKE ALAN JAMES 69 GC 938-8351  
3628 RHODE ISLAND SLP ST LOUIS PARK  
ROEPKE MICHAEL ANTHONY 70 CLA  
5049 NEWTON SO MPL MINNEAPOLIS  
ROERS ROLLAND HUBERT 70 CLA 331-1326  
1725 UNIVERSITY AVE SE MPL PARKERS PRAIRIE  
ROESKE JOHN RAYMOND 70 CLA 774-6462  
1611 STILLWATER AVE STP ST PAUL  
ROESKE WILLIAM BRUCE 68 GC 781-1315  
2319 NE 6TH ST MPL MINNEAPOLIS  
ROESLER DAVID FRANK 69 IT 645-1466  
1680 ASHLAND STP ST PAUL  
ROESLER GERARD STANLEY 68 ED 645-2409  
1160 FIFIELD ST STP FRANKLIN IL  
ROESLER NEIL WARREN 70 AGFHE 484-1356  
728 HEINEL DR ROV MINNETONKA BCH  
ROESLER ROBERT DEAN 69 AGFHE 484-1356  
728 HEINEL DR ROV MINNESOTA LAKE  
ROESSLER RICHARD CARL 69 GC  
HOP  
ROETHMAN LEE ANN 70 CLA 489-0780  
642 FRONT AVE APT 105 STP SIOUX CENTER IA  
ROEVER BRUCE BUDDY 69 IT  
TERRITORIAL HALL MPL CEDARBURG WI  
ROFF JAMES DAVID GRAD 331-8354  
626 ERIE SE MPL MINNEAPOLIS  
ROFF JOAN HERR THERESA 68 CLA 881-7178  
10031 JAMES CIRCLE BLT  
ROFF LINDA MARIE 69 GC 881-1011  
10025 GIRARD SO BLT BLOOMINGTON

ROFFERS DAVID WILLIAM GRAD 427-2994  
2580 107 LANE  
ROFFERS TONY

ROGUE DANIEL CHARLES 71 CLA  
FRONTIER HALL  
ROGEN SUSAN MARY 69 AGFHE 338-8302  
2129 RIVERSIDE AVE SO  
ROGERS BRUCE JOHN 71 IT 722-7815  
3043 32 AVE SO  
ROGERS BRUCE LUNNON 71 DULTH 724-9886  
VERMILLION 163  
ROGERS CAMILLE LOUISE 68 CLA WA6-6633  
4516 CEDARWOOD RD  
ROGERS CHARLES THOMAS 69 GC 771-1045  
1050 E IVY AVE  
ROGERS CHARLES WESLEY 69 CLA 331-4525  
708 UNIVERSITY SE  
ROGERS DONALD ANTHONY 70 CLA 474-7933  
RT 4 BOX 233  
ROGERS DONNITA LAMB MA GRAD

ROGERS EDWARD ALLEN 70 CLA 724-4520  
4445 E LAKE ST  
ROGERS EVAN DAVID GRAD

ROGERS GREGORY ALLAN 70 CLA 373-6566  
TERRITORIAL HALL  
ROGERS HARRY MOORE GRAD 698-7297  
976 SO CLEVELAND  
ROGERS JAMES GLENN 71 CLA 508-4223  
4364 FRANCE AVE N  
ROGERS JAMES RUSSELL GRAD

ROGERS JERRY PAUL 70 CLA  
HAMNOMEN  
ROGERS JOE LEMOIN GRAD

ROGERS JONATHAN WALLAC GRAD

ROGERS JOY MARIE 71 CLA  
366 W SANDHURST DRIVE  
ROGERS KATHLEEN DIANE 71 CLA 771-3885  
602 E IVY AVE  
ROGERS LOUISE AGNES 68 ED 922-8969  
5112 UPTON AVE SO  
ROGERS MANLIE WILLIAM 69 ED 545-7426  
2405 ZEALAND AVE NO  
ROGERS MARY JANE 68 GC

ROGERS PERRY ERNEST 68 GC  
MPL NORTHFIELD  
ROGERS ROGER CAROL 69 BUS

ROGERS SHELLEY VICTORI 68 ED 335-0292  
143 ORLIN AVE SE  
ROGERS THOMAS MICHAEL 70 CLA 698-4704  
600 SO FAIRVIEW  
ROGERS VICKI LYNN 69 CLA 331-9731  
1318 7TH ST SE  
ROGERS WAID GRAD

ROGERS WILLIAM EDWIN GRAD

ROGHANIZAD MOHAMMAD ES 69 IT 331-6494  
411 ONTARIO ST SE  
ROGICH CHERYL TURNER L 68 CLA

ROGIER NAN MARIE 71 AGFHE 938-4670  
BAILEY HALL  
ROGIN PAUL SOLOMON 71 CLA  
MPL ALEXANDRIA VA

ROGNE JAMES PHILIP 70 AGFHE 331-1326  
1725 UNIVERSITY AVE SE  
ROGNESS JOHN HOLDEN 70 IT 729-4550  
3328 47TH AVE SO  
ROGNESS SUSAN JOAN 68 ED  
1807 WASHINGTON AVE SO  
ROGNESS TONY CRAIG 71 IT

ROGNLIE LINDA KAY 70 CLA 824-1491  
2737 BLAISDELL  
ROGNLIE RONNIE WILLIAM 70 AGFHE

ROGOSHEKES DAVID GEORG GRAD

ROGOSHEKES THOMAS WALT 68 CLA 226-5495  
770 OSCEOLA AVE  
ROHDE GEORGE ALBERT JR 71 AGFHE 459-5035  
6611 16TH LANE  
ROHKOML RICKEY RONALD 69 BUS 824-9605  
4556 PARK AVE SO  
ROHLAND RICHARD ANTHON 69 GC 699-6788  
1882 ROME AVE  
ROHLER JEFFREY ARTHUR 68 IT 881-8861  
1600 PARK RD  
ROHMANN THOMAS MICHAEL 69 AGFHE  
769 COMO AVE  
ROHNER ILENE MARIE 68 ED 929-5446  
6000 OLINGER RD  
ROHR THOMAS EUGENE GRAD 645-7873  
140 GORTNER LAB  
ROHRBACHER LUANNE AMY 69 CLA 788-3600  
4134 ARTHUR ST NE  
ROHRER CHARLES OTTO 71 DENT  
PIONEER HALL  
ROHRE DONALD RICHARD 71 CLA 920-2745  
5240 OAKLAWN AVE  
ROHS CLAUDIA ANN 70 AGFHE 484-9235  
4911 MAPLE

ROHWEDDER VIRGINIA GAI 69 CLA 331-6921  
717 14TH AVE SE  
ROHMEDER JAMES ARTHUR 70 DULTH 624-0777  
133 S ST  
ROHWEDER RALPH ANDREW 69 ED 521-3345  
2901 JAMES AVE NO  
ROIKO JOYCE EMILY 70 IT 377-9562  
253 QUEEN AVE SO  
ROIKO WILLIAM RICHARD 69  
4405 GILLIAM  
ROLLAND RICHARD HAROLD 69 MORRS  
510 1/2 ATLANTIC  
ROISE JOHN CARL 68 AGFHE

ROISUM MARIT MARGARET 71 MORRS  
301 E 8TH ST  
ROITER ALLEN HARVEY 70 IT  
1901 UNIVERSITY SE  
ROKALA ELWOOD ARTHUR 70 CLA 331-5404  
878 18TH AVE SE  
ROKKE JOHN ARNOLD 70 CLA 874-2435  
ROUTE 2  
ROLANDSON RUSSELL BRUC 68 ED  
407 7TH ST SE  
ROLES RICHARD JOHN 70 PHARM  
MORRIS  
GRAD

ROLEWICZ THOMAS FRANCI GRAD

ROLF BRUCE ALAN 68 GC 222-4668  
600 VALLEY LANE  
ROLF JON ERIC GRAD 335-1005  
410 6TH ST SE  
ROLFE JANET BESAM VIOL 68 ED 227-3262  
1280 MAC ARTHUR  
ROLFE KATHLEEN SUSAN 71 CLA 724-8902  
5724 44TH AVE SO  
ROLFE KATHRYN IONE 68 MEDIC  
801 UNIVERSITY AVE SE  
ROLFING ROXANNA JANE 70 CLA 724-3695  
SANFORD HALL  
ROLFSON JOHN QUENTIN 69 VET M  
1618 EUSTIS ST  
ROLFSRUD STANLEY HILDI 69 CLA

ROLIG JOHN EDWARD 68 CLA 222-8209  
1193 CHEROKEE AVE  
ROLLA JOYCE MARIE 69 MEDIC  
COMSTOCK HALL  
ROLLA SHIRLEY KAY 71 DULTH 727-6636  
914 E 2 ST  
ROLLAND JAMES NICHOLAS 70 CLA 824-0541  
3112 JAMES AVE SO  
ROLLAND MARY TOWER ANN GRAD 332-2282  
416 11TH AVE SE  
ROLLAND PAUL STEVEN GRAD 331-7075  
2606 E HENNEPIN  
ROLLEFSON WILLIAM CHAR 68 GC 724-7771  
4900 38TH AVE S  
ROLLENHAGEN DENNIS L 71 AGFHE 553-3854  
BAILEY HALL  
ROLLER MARTIN ROY 71 CLA 560-5564  
5005 6TH ST NE  
ROLLING RICHARD EDWARD 68 AGFHE 644-9273  
2298 DOSWELL AVE  
ROLLINGER GREGORY ALOY 69 GC 735-0891  
1871 E 7TH ST  
ROLLINGER MAXINE ADELE 68 ED 777-4489  
1864 ELM ST  
ROLLINGS JERRY OCONNOR 69 AGFHE  
BAILEY HALL  
ROLLINGS JOHN VERL 71 AGFHE  
BAILY HALL  
ROLLINGS MARY HELEN 70 CLA 473-4327  
BOX 625 RT 5  
ROLLINGS THOMAS CLAIR 71 CLA 377-1676  
620 UPTON AVE SO  
ROLLINS BARBARA JEAN 68 AGFHE 645-6563  
1276 RAYMOND AVE  
ROLLINS DAVID BRUCE 70 CLA 421-3506  
1708 6TH AVE SO  
ROLLINS DIANE MARY 68 ED 722-7729  
4428 30 AVE SO  
ROLLINS JAMES 69 CLA 338-1980  
917 22ND AVE S  
ROLLOFF MICHAEL EARL 70 IT  
TERRITORIAL HALL  
ROLNICK ARTHUR JEFFREY 70 IT 884-4540  
8950 GOODRICH AVE S  
ROLNICK SANDRA NOREEN 68 ED 645-1356  
978 DAYTON  
ROLSHOUSE JAMES ERIC 70 AGFHE 825-4802  
115 W 48TH ST  
ROLSTAD GARY ORVIN 70 CLA 881-3212  
8443 BLAISDELL  
ROLSTAD JOHN DALE 68 CLA 881-3269  
8443 BLAISDELL SO  
ROM WILLIAM NICHOLAS 71 MED  
FRONTIER HALL  
ROMAN ROBERT LANCE 68 CLA UN9-1560  
7208 PENN AVE SO  
ROMANCHUK CAROL ANN 71 CLA 781-4195  
3155 LINCOLN ST NE  
ROMANCHUK PATRICIA KAY 70 CLA  
POWELL HALL  
ROMANENKO BOHDAN 69 IT 331-8566  
847 25TH AVE SE  
ROMANIUK JOANNE TERESA 70 CLA 789-5387  
2501 BENJAMIN NE  
ROMANOVSKIS MONICA ANN 68 ED PA2-7986  
2628 15 AVE SO

ROMBERG DONALD FRANK 69 CLA  
CENTENNIAL HALL  
ROME JOHN DOZIER 69 LAW 335-5631  
717 UNIVERSITY AVE SE  
ROME JUDITH MILLER LEE GRAD 335-5631  
717 UNIVERSITY AVE SE  
ROME SHARRON HEAVRIN GRAD 888-5493  
8840 FREMONT SO  
ROMER HENRY F GRAD 332-4952  
628 4TH ST SE  
ROMER RICHARD PHILLIP 70 CLA 374-5715  
2401 GIRARD AVE SO  
ROMERIN ROBERT LEE 68 CLA 333-2038  
908 13TH AVE SO  
ROMFO THOMAS ALVIN 70 CLA PA9-0686  
3849 28TH AVE SO  
ROMITTI DENNIS JAMES 70 CLA 888-3994  
10142 EMERSON SO  
ROMNES PAUL MICHAEL 69 GC  
3459 2ND ST NE  
ROMO ESTHER ALVIDA AS PH 823-2164  
4232 ELLIOT AVE  
ROMO LAURITZ ADOLPH 68 AGFHE 646-7017  
2085 BUFORD  
ROMSLO FLOYD GRAD 331-7360  
520 WASHINGTON AVE SE  
ROMSTAD JOHN MARTIN 71 DENT 331-5214  
631 ERIE ST SE  
RONALD JAMES BADE 69 CLA

RONAY JAMES EUGENE 69 CLA 489-2713  
1589 WOODBRIDGE  
RONAY ROBERT DAVID 69 BUS 489-0548  
1025 W HOYT  
RONBECK JEFFREY STEWAR 71 CLA 938-9555  
13008 STANTON DRIVE  
RONDORF DONALD LAVERN 71 AGFHE

RONEY NANCY EILEEN 69 ED 633-1365  
2483 SHELDON  
RONGITSCH JOHN DONALD 70 CLA 698-3455  
1031 S FINN  
RONICH MICHAEL JOHN JR 69 CLA

RONKEN ROBERT NOEL GRAD

RONNBACK GREGORY ALLAN 70 DULTH 525-4880  
5121 PEABODY ST  
RONNBACK MARSHA CAROLE 69 DULTH 525-4880  
5121 PEABODY ST  
RONNEVICK HANS ALBERT GRAD 331-3304  
899 23RD AVE SE  
RONNIE CHERYL ANNETTE 68 CLA  
720 6TH AVE SE  
RONNIE GARY DEAN 71 CLA 724-6927  
5244 47TH AVE SO  
RONNING BARBARA SWANSON 68 ED

RONNING CYNTHIA KAY 71 CLA  
SANFORD HALL  
RONNING DIANE DOROTHEA 70 CLA 729-1024  
3248 15TH AVE SO  
RONNING DIANN ARLOU 69 MORRS 589-2969  
MILTONA  
RONNING HENRY RUDOLPH 69 DENT 331-7033  
212 WALNUT ST  
RONNING JOHN MICHAEL 68 DULTH  
WORTHINGTON  
70 CLA

RONNING KENDALL ALLEN 70 CLA  
2427 1ST AVE SO  
RONNING RICHARD LEIGH 70 CLA 373-6180  
1024 PIONEER HALL  
RONNING ROBERT WILLIAM 69 CLA 869-8465  
6318 NEWTON AVE SO  
RONNING STEVEN ARLEN 68 IT

RONNING STEVEN PHILLIP 68 IT 331-7931  
515 10TH AVE SE  
RONNING SUE ELAYNE 71 CLA 331-1766  
1119 6TH ST SE  
ROOD DOUGLAS PAUL 71 CLA 922-9230  
4848 EWING SO  
ROOD FAYE SYLVIA 69 MEDTC 377-3474  
4535 DOUGLAS AVE S  
ROOD JAMES L GRAD

ROOD KATHERINE ELLEN 70 CLA 561-5526  
3219 62ND AVE NO  
ROOD KEVIN MICHAEL 70 CLA 464-3229  
RT 3 BOX 250A  
ROOD KIM STEPHEN 69 IT 464-3229  
RT 3 BOX 250A  
ROOD RUSSELL MICHAEL 69 ED  
3758 BRYANT AVE NO  
ROOD STEPHEN JOSEPH 68 CLA  
1418 5TH ST SO  
ROODK DAVID LOUIS GRAD

ROOK SUSAN LOUISE 70 MORRS  
GAY HALL  
ROOME RICHARD WILLIAM 68 IT 822-2004  
5040 GARFIELD AVE SO  
ROONEY DANIEL JOSEPH GRAD  
2109 LYNDALE AVE  
ROONEY ELIZABETH ANN GRAD 336-0291  
727 UNIVERSITY AVE SE  
ROONEY MARK STEPHEN 71 CLA  
1807 WASHINGTON AVE SO  
ROONEY MICHAEL ROLAND 71 CLA  
1807 WASHINGTON AVE SO  
MPL BUFFALO

ROONEY PATRICK ARTHUR	71 CL BUFFALO	ROSE SUSAN CAROL	71 AGFHE	ROSENEK HARVEY BRUCE	68 GC	522-8294
ROONEY PATRICK JOHN	69 VET M	ROSE THOMAS JOSEPH	MPL NEW LONDON	1427 SHERIDAN AVE NO	MPL MINNEAPOLIS	
ROONEY PATRICK JOSEPH	71 CL	ROSE VATEL THEODORE	GRAD	ROSENFELD GEORGE WALKER	GRAD	
ROOSEVELT CHRISTOPHER	MPL MINNEAPOLIS	ROSEBERG ROBERT FREDER	70 IT	2106 25TH ST SO	MPL NEW YORK NY	
ROOT CLAUDIA JEANNE	70 DULTH	ROSEEN BETTY JEAN	70 DULTH	ROSENFELD JEAN AARONSD	GRAD	336-2723
ROOT KEITH EDWARD	70 CLA	ROSEEN CLARICE ANN E	68 DULTH	2106 S 25TH AVE	MPL WASHINGTON DC	
ROOT MELVIN DALE	68 GC	ROSEEN JANET MARIE	70 CLA	ROSENFELD BONNIE SUE	68 GC	
ROOT MICHAEL CLARK	70 CLA	ROSEN BETTY JEAN	70 DULTH	ROSENFELD J ELI	GRAD	
ROOT RICHARD EDWARD	68 IT	ROSEN CLARICE ANN E	68 DULTH	ROSENFELD JOAN SAMOUR	GRAD	
ROPER DEAN RONALD	70 IT	ROSEN GARY STUART	70 CLA	ROSENFELD JOSEPH HOWA	71 CL	
ROPER DONALD HART	69 DULTH	ROSEN GWEN SUE	71 CL	ROSENFELD RICHARD ROB	70 MORRS	559-2261
ROPP ANN LOUISE	70 CLA	ROSEN HANNA RENE	70 CLA	ROSENGREN BRIAN PAUL	71 IT	929-5196
RORR GERALD DENNY	GRAD	ROSEN JAMES STEVEN	71 AGFHE	3948 COLORADO AVE S	SLP ST LOUIS PARK	
RORVICK MARVIN ADRIAN	69 CL	ROSEN JOANNE MARIE	71 MORRS	ROSENGREN RANDY WINCEN	70 CL	545-8208
RORVICK JAMES KENNETH	68 CL	ROSEN LEEANNE	71 CL	220 LAWN TERRACE	GDV GOLDEN VALLEY	
ROSA THOMAS WILLIAM	69 GC	ROSEN LOWELL HERBERT	GRAD	ROSENGREN SANDRA KAY	71 MORRS	763-4048
ROSACKER SUSAN LYNN	70 ED	ROSEN MARGARET ANN	71 CL	GAY HALL	ALEXANDRIA	
ROSAAT I LEONARD JOHN	69 DULTH	ROSEN MARK JEFFORY	71 IT	ROSENOW BARRY LAWRENCE	70 IT	
ROSBURG JOHN DOUGLAS	69 DENT	ROSEN MARK L	70 PHARM	814 8TH ST SE	MPL LITCHFIELD	
ROSCHE RICHARD HUBERT J	70 CL	ROSEN MARSHA JEAN	70 CL	ROSENOW CLARENCE ARNOLD	70 IT	
ROSCHE ROSE MARIE	68 ED	ROSEN MARY ELLEN	70 CL	ROSENOW GREGORY ALBERT	70 AGFHE	562-2443
ROSCOE MARY JEAN	70 CL	ROSEN NATHAN ALLAN	69 CL	110 DEXTER HALL	STP PRIOR LAKE	
ROSCOE ROBERT BYRON	69 GC	ROSEN RONALD SCOTT	70 CL	ROSENOW PEGGY LEE	69 NURS	339-0531
ROSCOE ROBERT JAMES	68 IT	ROSEN RICHARD BYRON	70 CL	POWELL HALL	MPL RIALTO CA	
ROSCOE ROBERT JOHN	71 CL	ROSEHAIM PAUL BENHARD	GRAD	ROSENOW PETER DEXTER	GRAD	
ROSCOE RONALD FRANK	GRAD	ROSHOLT JOHN CHARLES	68 LAW	ROSENOW STEVEN JAMES	68 GC	
ROSDAHL CAROLINE BUNKE	GRAD	ROSHOLT STEPHEN CRAIG	70 LAW	6120 11TH AVE SO	MPL MINNEAPOLIS	
ROSE ARTHUR DUANE JR	68 MORRS	ROSHOLT MIRROR MYSZYN	GRAD	ROSENQUIST DONALD EUGE	AS ED	
ROSE CAROL JO	71 CL	ROSLANSKY KATHRYN WACH	70 CL	499 W ORANGE	69 GC	489-7798
ROSE CHARLES EARL	71 MORRS	ROSLANSKY WILLIAM MICH	69 CL	ROSENQUIST STEPHEN LAW	STP ST PAUL	
ROSE CHARLOTTE ELEANOR	69 MORRS	ROSLIEN SHARON ESTHER	68 CL	1701 EMERSON SO	MPL OMAHA NB	
ROSE CYNTHIA JANE	69 AGFHE	ROSLIK KAZIMIERZ	68 BUS	ROSENSTOCK BARRY EDWAR	GRAD	
ROSE DANA SAMUEL	71 CL	ROSLIK WALTER	68 GC	CENTENNIAL HALL	MPL RENSSELAER NY	
ROSE DOUGLAS DANA	GRAD	ROSLIK JEFFERSON ST NE	68 GC	ROSENTHAL EUGENE	GRAD	339-7421
ROSE FRANCES DAWSON	AS ED	ROSLIEN SHARON ESTHER	68 GC	CENTENNIAL HALL	MPL DETROIT MI	
ROSE JAMES PHILLIP	AS BUS	ROSLANSKY WILLIAM MICH	69 CL	ROSENTHAL GAYLE BETH	69 GC	
ROSE JANET ELAINE	71 CL	ROSLANDY LYNDALE AVE SO	69 CL	ROSENTHAL HENRY GERRIT	GRAD	
ROSE JOHN ROBERT	69 IT	ROSLIEN SHARON ESTHER	68 CL	ROSENTHAL JAMES CARL J	70 IT	560-4035
ROSE KENNETH ALAN	68 BUS	ROSLIK JEFFERSON ST NE	68 GC	5116 5TH ST NE	CLH COLUMBIA HTS	
ROSE LOUIS ALLEN	71 CL	ROSLIK WALTER	68 GC	ROSENTHAL NEIL PAUL	68 MED	644-1861
ROSE LYNN MARGARET	70 MORRS	ROSLANDY LYNDALE AVE SO	69 CL	1769 CARROLL AVE	STP	
ROSE MICHAEL ALAN	69 IT	ROSLANSKY KATHRYN WACH	70 CL	ROSENTHAL STEPHEN BRUC	68 CL	488-9409
ROSE PATRICIA ANNE	70 CL	ROSLANSKY WILLIAM MICH	69 CL	467 W HAVYLAND	STP ST PAUL	
ROSE RICHARD HERBERT	70 CL	ROSLANDY LYNDALE AVE SO	69 CL	ROSENWALD SUSAN JEAN	69 MEDTC	338-9927
ROSE RICHARD MARK	71 MED	ROSLIEN SHARON ESTHER	68 CL	1100 5TH ST SE	MPL MINNEAPOLIS	
ROSE ROBERT ALAN	71 MORRS	ROSLIK KAZIMIERZ	68 BUS	ROSENWINKEL DOUGLAS HO	71 CL	448-2836
ROSE STEPHEN EDWARD	68 IT	ROSLIK WALTER	68 GC	105 ELM ST	CHK CHASKA	
		ROSLANDY LYNDALE AVE SO	69 CL	ROSENZWEIG ROBERT ALAN	GRAD	
		ROSLANSKY KATHRYN WACH	70 CL	ROSEQUIST TAMSON SUZAN	70 CL	920-7129
		ROSLANSKY WILLIAM MICH	69 CL	5543 OLIVER S	MPL MINNEAPOLIS	
		ROSLANDY LYNDALE AVE SO	69 CL	ROSER MINDA JUNE	69 GC	
		ROSLIEN SHARON ESTHER	68 CL	8100 W 34 1/2 ST	SLP ST LOUIS PARK	
		ROSLIK KAZIMIERZ	68 BUS	ROSEMALL RICHARD BYRON	GRAD	
		ROSLIK WALTER	68 GC	ROSEHAIM PAUL BENHARD	GRAD	
		ROSLANDY LYNDALE AVE SO	69 CL	ROSHOLT JOHN CHARLES	68 LAW	
		ROSLANSKY KATHRYN WACH	70 CL	1711 UNIV AVE SE	MPL MINNEAPOLIS	
		ROSLANSKY WILLIAM MICH	69 CL	ROSHOLT STEPHEN CRAIG	70 LAW	377-6639
		ROSLANDY LYNDALE AVE SO	69 CL	4115 GLENCREST RD	GDV GOLDEN VALLEY	
		ROSLIEN SHARON ESTHER	68 CL	ROSHWALD MIRIAM WYSZYN	GRAD	
		ROSLIK KAZIMIERZ	68 BUS	ROSLIN EBERHARD	GRAD	
		ROSLIK WALTER	68 GC	ROSLING NANCY HOWARD	GRAD	
		ROSLANDY LYNDALE AVE SO	69 CL	3115 1ST AVE SO	MPL	
		ROSLANSKY KATHRYN WACH	70 CL	ROSLIVAL RONALD JOSEPH	69 AGFHE	
		ROSLANSKY WILLIAM MICH	69 CL	1485 CLEVELAND AVE	STP MONTGOMERY	
		ROSLANDY LYNDALE AVE SO	69 CL	ROSKAFT CLAUDIA MARIE	71 CL	472-4400
		ROSLIEN SHARON ESTHER	68 CL	5440 3PTS BLVD	MND MOUND	
		ROSLIK KAZIMIERZ	68 BUS	ROSKOS STEPHEN RICHARD	68 MED	333-0676
		ROSLIK WALTER	68 GC	725 26TH AVE SO	MPL MINNEAPOLIS	
		ROSLANDY LYNDALE AVE SO	69 CL	ROSLANSKY KATHRYN WACH	70 CL	427-2585
		ROSLANSKY KATHRYN WACH	70 CL	RT 4	OSO JACKSON	
		ROSLANSKY WILLIAM MICH	69 CL	ROSLANSKY WILLIAM MICH	69 CL	868-5638
		ROSLANDY LYNDALE AVE SO	69 CL	7431 LYNDALE AVE SO	RHF ONALASKA WI	
		ROSLIEN SHARON ESTHER	68 CL	ROSLIEN SHARON ESTHER	GRAD	
		ROSLIK KAZIMIERZ	68 BUS	1345 N FARRINGTON	STP KENSETT IA	
		ROSLIK WALTER	68 GC	ROSLIK KAZIMIERZ	71 CL	781-2056
		ROSLANDY LYNDALE AVE SO	69 CL	2610 JEFFERSON ST NE	MPL MINNEAPOLIS	
		ROSLANSKY KATHRYN WACH	70 CL	ROSLIK WALTER	68 GC	
		ROSLANSKY WILLIAM MICH	69 CL	2610 JEFFERSON ST NE	MPL MINNEAPOLIS	
		ROSLANDY LYNDALE AVE SO	69 CL	ROSLUND LANGRE DARLENE	69 GC	588-8328
		ROSLIEN SHARON ESTHER	68 CL	3614 ABBOTT AVE NO	ROB ROBBINSDALE	
		ROSLIK KAZIMIERZ	68 BUS	ROSNER JOAN MARIE	68 GC	645-4024
		ROSLIK WALTER	68 GC	1344 MIDWAY PKWY	STP ST PAUL	
		ROSLANDY LYNDALE AVE SO	69 CL	ROSNER LEONARD GEORGE	GRAD	
		ROSLANSKY KATHRYN WACH	70 CL	ROSDOW RICHARD FRANCIS	69 CL	
		ROSLANSKY WILLIAM MICH	69 CL	813 11TH AVE SE	MPL CRYSTAL	
		ROSLANDY LYNDALE AVE SO	69 CL	ROSS BARBARA JUMB	69 CL	313-6644
		ROSLIEN SHARON ESTHER	68 CL	SANFORD HALL	MPL CLOQUET	
		ROSLIK KAZIMIERZ	68 BUS	ROSS DANIEL COLBURN	69 AGFHE	
		ROSLIK WALTER	68 GC	ROSS DAVID ALBERT	70 IT	922-7200
		ROSLANDY LYNDALE AVE SO	69 CL	5456 IRVING AVE SO	MPL MINNEAPOLIS	
		ROSLANSKY KATHRYN WACH	70 CL	ROSS DENNIS MICHAEL	68 BUS	631-0087
		ROSLANSKY WILLIAM MICH	69 CL	1973 ELDRIDGE AVE	ROV ROSEVILLE	





RUSHMANN JON MARK 71 CLA 373-7010 RUTCHICK ELLEN FAITH 70 CLA 698-2102 RYAN MARY KATHLEEN 71 CLA 698-6030
FRONTIER HALL MPL CHIPPEWA FLS WI 2164 WATSON AVE STP ST PAUL 1780 PRINCETON STP ST PAUL
RUSHTON JAMES RICHARD 69 CLA 601 19TH AVE SO RUSHTON JOSEPH GEORGE GRAD

RYS ELLEN KAY 71 CLA MCL GRASSTON  
1316 7TH ST SE 69 CLA  
RYSAVY JOSEPH ANTHONY 71 CLA MCL AUSTIN  
519 3RD AVE SE APT 206 71 CLA 331-8832  
RYSADAM PATRICIA SUE 71 CLA MCL STANCHFIELD  
1007 FULTON ST SE 71 IT 771-2862  
RYSYSS MICHAEL ALBERT 71 IT STP ST PAUL  
1601 DARLENE ST 55 GC  
RYTI PHYLLIS ANN 71 CLA 646-5814  
1740 HOLTOM FLH FALCON HEIGHTS  
SALMINEN ROBERT CRAIG 71 CLA 724-9856  
1740 HOLTOM MAHOMETDI  
SALMINEN WILLIAM VEIKK 71 CLA 922-9563  
GRIGGS HALL B318 EDN EDINA  
SALMON ANN MARIE 70 CLA 521-6582  
4350 FRANCE AVE SO MPL MINNEAPOLIS  
SALMON GLENBE LYNN 68 PH  
1524 IRVING AVE NO SALMON HOWARD WILLIAM  
SALMON JAMES EDWARD 69 CLA 823-9330  
5309 ELLIOT AVE SO MPL MINNEAPOLIS  
SALMON OLIVER NORTON 70 IT 488-5902  
418 GLENWOOD AVE ROV ROSEVILLE  
SALMON PAMELA JEANNE 68 ED  
SALMONSON JOHN EDWARD 69 DULTH 628-1782  
414 N 81ST AVE W DULUTH  
SALO BARBARA LBONA 71 DULTH 727-5819  
817 N 27 AVE W DULUTH  
SALO DIANE ROSALIE 71 CLA  
SANFORD HALL MPL VIRGINIA  
SALO JUDITH ELINOR 71 DULTH 525-5696  
RT 1 BOX 31 TWO HARBORS  
SALO NANCY KAY 69 CLA 588-5901  
2618 YORK AVE ROB ROBBINSDALE  
SALO RODNEY WILLIAM 69 IT  
SALOME DOROTHY JACK JE 69 GC 522-6168  
1509 GIRARD AVE NO MPL MINNEAPOLIS  
SALONEK CHARLES JAMES 70 AGFHE 788-4875  
5225 LINCOLN ST NE CLH PINE CITY  
SALONEN LYNNE MARGUERI 68 MORRS  
KEEWATIN  
SALOWAY JILL BETH 70 CLA 926-1402  
2736 KIPLING SLP ST LOUIS PARK  
SALSAMAN TODD ALLAN 70 AGFHE 373-6547  
TERRITORIAL HALL MPL NEW PRAGUE  
SALTER DELORES KAY 70 CLA 421-2459  
903 NORTH ST ANK ANOKA  
SALTURELLI ANNE MARIE 70 CLA 741-6871  
SANFORD HALL MPL VIRGINIA  
SALTVEIT MIKAL ENDRE 70 AGFHE 789-8447  
2825 POLK ST NE MPL MINNEAPOLIS  
SALTVOED INGRID ELAINE 70 DULTH  
2019 E 2ND ST RICHFIELD  
SALTZMAN MARC PAUL 69 IT  
940 FRANKLIN TERR MPL WILLOW GROVE PA  
SALTZMAN MARK STEPHAN 68 GC  
SALTZMAN MARLA STACY 69 GC 529-6210  
1229 UPTON NO MPL MINNEAPOLIS  
SALVERSON NANCY LOU 68 GC  
SALVINO JEANINE BERGIN 70 AGFHE  
BATTLE HALL STP BETHESDA MD  
SALYARDS ELY CHISHOLM 68 CLA  
SALZMAN JILL BEAUDETTE 70 CLA 331-2501  
25 CLARENCE SE MPL  
SALZMAN LAWRENCE EDWARD 70 AGFHE 331-2501  
25 CLARENCE AVE SE MPL HAYZATA  
SAMAAN MAKRAM KHALIL 70 AGFHE 645-8767  
SAMARZIA WILLIAM GEORG 70 DULTH 626-1679  
2400 OAKLAND AVE DULUTH  
SAMES MICHAEL VIRGIL 70 CLA 445-4117  
1037 SO SPENCER SHK  
SAMI KHLABID ABDUS 70 AGFHE 645-8767  
SAMI KHLABID ABDUS 70 AGFHE 645-8767  
SAMPSON ANITA JEANNE 70 CLA 631-1039  
2230 MARION RD ROV ROSEVILLE  
SAMPSON DARLENE IVA 71 CLA 784-0035  
ROUTE 4 ANK ANOKA  
SAMPSON JOHN MARK 71 DULTH 624-9649  
414 N 84 AVE W DULUTH  
SAMPSON JUDITH PATRICI 69 ED  
SAMPSON LAURA RUTH 69 GC 331-6361  
718 UNIVERSITY AVE SE MPL EXCELSIOR  
SAMPSON MERLE ARLEN 70 DULTH  
2120 E 3 ST THF RIVER FALLS  
SAMPSON SUSAN KATHERIN 70 DULTH 624-4210  
219 N 53RD AVE W DULUTH  
SAMS KARNIS DALE 69 DULTH 722-8693  
1516 N 1 ST HIBBING  
SAMS STEPHEN THOMAS 70 AGFHE  
2060 CARTER AVE STP REDWOOD FALLS  
SAMSAL DONALD LOWELL 71 IT 722-2609  
5657 25TH AVE SO MPL MINNEAPOLIS  
SANSKY SUSAN GAYLE 71 CLA 926-5234  
5200 W 29TH ST SLP ST LOUIS PARK  
SAMSON CHARLES EDWARD 70 CLA 633-1307  
872 8TH AVE NW NMB NEW BRIGHTON  
SAMUELS EDWARD MARK 68 DULTH 728-4916  
1513 E 2 ST MINNEAPOLIS  
SAMUELS FERDINAND ALON 70 AGFHE 374-3607  
520 BURNTSIDE DR GOV NEW YORK CITY NY  
SAMUELSON BETTY JAYNE 70 CLA  
1414 6 ST SE MPL MINNEAPOLIS  
SAMUELSON KAREN ANN 71 CLA 777-7913  
1872 MONA AVE WTB WHITE BEAR LAKE





SARBERG MARCELLA MAKI 1828 COLUMBUS AVE SARENPA MARK BURNS 200 PENN AVE SO SARETTE JOHN WILLIAM 326 2ND ST SARFF HELEN MARIE 2737 PORTLAND AVE S SARFF LAURA CLARK LEE 6910 HUMBOLDT AVE NO SARGEANT JAMES CRAIG	AS DULTH 724-5872 DULUTH 71 CLA 377-1123 MPL MINNEAPOLIS 69 DULTH 879-7314 CLOQUET AS GC MPL 70 CLA 561-6194 BRC ROBBINSDALE 69 DULTH ST LOUIS PARK 70 CLA 938-5595 SLP ST LOUIS PARK 71 AGFHE 789-3297 MPL MINNEAPOLIS 70 MORSC MPL SANGERVILLE ME 71 CLA 926-6629 MPL MINNEAPOLIS 70 CLA 926-6624 MPL MINNEAPOLIS 70 AGFHE 789-3297 MPL MINNEAPOLIS GRAD	SATZ CAROL ANNE 5221 LOGAN AVE SO SAUBER DOROTHY ANN 1322 LAFOND AVE SAUER DALE A 3220 47TH AVE SO SAUER DARYL JOHN SAUER DAVID BRUCE SAUER JAMES MICHAEL 225 JERSEY AVE NO SAUER JOSEPH JAMES SAUER SUSAN CREIGHTON SAUERS RICHARD FRANK 1825 SO 5TH ST SAUERS RICHARD JAMES 9215 NICOLLET AVE SAUKKO LARRY HAROLD 1032 GRANDVIEW AVE SAUMWEBER CATHERINE MA 1251 E 6TH ST SAUMWEBER JOHN HENRY SAUMWEBER LYNDA LOUISE 479 BIRMINGHAM SAUNDERS BRUCE ALLEN 864 ST PAUL AVE SAUNDERS COLLEEN ANNET 307 W COMSTOCK HALL SAUNDERS DIANE LUCILLE 1015 12TH AVE SE SAUNDERS ELIZABETH ANN 4501 CHATELAIN TER SAUNDERS KENT DONALD 5017 WASHBURN SO SAUNDERS LAVELL EUGENE 1231 GIBBS AVE SAUNDERS RHONDA BROOKE 1719 MORGAN AVE NO SAUNDERS RICARDA ROWEN 401 11TH AVE SE SAUR LARRY JAMES 7 373 FRONTIER HALL SAURO WILLIAM JOSEPH SAUSEN BARBARA JEAN 8330 FREMONT AVE SO SAUSEN JOSEPH HENRY 5636 BLAISDELL AVE SO SAUSEN ROBERT FRANCIS 1883 BEECHWOOD SAUSSER SUSAN ELLEN 3695 W HILL SAUTER EUGENE EDWARD TORRANCE HALL 115 SAUTER JUDITH ANN 1109 5TH ST SE SAUTER MICHAEL ANTHONY 1522 PORTLAND SAUTNER JOHN CARL 416 VINE ST SAUTTER DAVID ASHLEY 1550 FULHAM ST SAUTTER MARJORIE ANN 1550 FULHAM SAUVAGEAU DAVID RONALD 432 4TH ST SE SAVAGE ANNE MARTHA SANFORD HALL SAVAGE DOREEN BERG 3423 30TH AVE N SAVAGE GERALD DOUGLAS 115 13TH AVE SO SAVAGE GERALD JAMES 3701 11 AVE SO SAVAGE GREGORY ROBERT 14221 PRINCE PL SAVAGE LAUREN GAIL 579 GLENDALE ST SAVAGE ROBERT WILLIAM 4656 BAKER RD SAVAGE STEVEN RAYMOND 4656 BAKER RD SAVAGEAU JOHN PHILIP 1329 ST PAUL AVE SAVARD ROBERT JOSEPH SAVELA JUDY BARBARA 1531 E 4TH ST SAVINO VICTOR SAVITT HOWARD MICHAEL 501 ONTARIO AVE SAVITT STEVEN LEE SAVOIE ROBERT GENE 611 UNIV AVE SAVOLA PAMELA ANN BOX 115 SAVORD ERVIN GEORGE 1090 THOMAS SAWAI NOBORU SAWATSKY FRANK 5801 YUKON NO SAWATSKY WALTER WILLIA	70 CLA 922-9041 MPL MINNEAPOLIS 71 CLA 646-6807 STP NEW PRAGUE GRAD MPL COLD SPRING GRAD GRAD 68 GC 545-7455 GOV GOLDEN VALLEY 70 PHARM DETROIT LAKES 68 OT ROCHESTER GRAD 333-3757 MPL PHILADELPHIA PA GRAD 881-6579 BLT STILLWATER 70 DULTH 724-4736 EVELETH 68 PHARM 774-4988 STP ST PAUL 68 GC 71 CLA 776-4165 STP ST PAUL 71 CLA 699-7076 STP ST PAUL 70 CLA 373-7262 PINE CITY 70 CLA 331-2491 MPL HUMBOLDT IA 69 ED 374-4784 GOV GOLDEN VALLEY 71 CLA 926-9465 MPL MINNEAPOLIS GRAD 646-3592 STP 71 CLA 522-4166 MPL MINNEAPOLIS 70 CLA 331-3387 MPL ST PAUL 71 IT 373-6966 MPL TWO HARBORS 71 IT AS ED 881-0325 BLT PINE CITY 70 CLA 866-0370 MPL MINNEAPOLIS 71 CLA 699-7519 STP ST PAUL 70 CLA 777-9327 NSP NORTH ST PAUL 70 DULTH 724-9841 MINNEAPOLIS 68 AGFHE 331-1339 MPL WAUWATOSA WI 70 CLA 646-2421 MPL 68 ED 890-3549 SAV SAVAGE 71 CLA 644-4551 STP ST PAUL 68 ED 644-4551 STP ST PAUL GRAD 339-6267 MPL 71 CLA AS ED 588-1256 ROB 68 CLA 938-6198 HOP 70 IT 745-0347 MPL MINNEAPOLIS 69 GC 938-8736 MTV MINNETONKA 69 GC 646-7014 STP ST PAUL 71 CLA 935-4579 MTV MINNETONKA 70 CLA 935-4579 HOP HOPKINS 69 GC 698-2639 STP ST PAUL GRAD 68 DULTH 728-4350 HIBBING 69 DULTH NSIDE NY 70 HED 544-5278 MPL GOLDEN VALLEY 71 IT 70 CLA 227-1942 STP MARSHALL 71 CLA 421-1363 CHM CHAMPLIN 70 DENT 644-2506 STP ST PAUL GRAD GRAD 537-4222 NWH GRAD	SAWDEY MARY ANN 1617 22ND AVE NE SAWICKI ELLEN KAY PIONEER COURT SAWIN BONNIE DEE 700 10TH AVE SE SAWINA DIANE MARIE 5144 EMERSON NO SAWYER DONALD MORGAN SAWYER GEORGE NEIL 2013 13TH AVE SO SAWYER HELEN JANE 519 3RD AVE SE SAWYER JOHN COOPER 727 UNIVERSITY AVE SE SAWYER LINDA LEE 4423 REGENT ST SAWYER THOMAS JOSEPH 116 GROVELAND SAWYER THOMAS LEE JR 601 ERIE ST SE SAXENA SHIL KUMAR 2044 BREWSTER SAXERUD MARILYN DAHLBY 1618 EUSTIS SAXTON MARILYN KAY 7326 GARFIELD AVE SO SAXTON SALLY MADELINE 3889 BELLAIRE AVE SAYED HAMDY IBRAHIM HA SAYLER ROONEY DELL 4695 103RD LANE NE SAYNER GEORGE HARRISON 5656 FREMONT SO SAYRE RONAELE JANE 3312 16TH AVE SO SAYTHER EILEEN ELIZABE GRIGGS HALL K 311 SAYTHER TERRY TIMOTHY RT 4 BOX 120 SAZENSKI CAROL JEAN SBOROV MARK DOUGLAS 1815 UNIVERSITY AVE SBOROV HERRY GAIL SBOROV STEVEN DALE 4716 UPPER TERRACE SCALA ENRIQUE OSCAR DEPT OF ECONOMICS SCALES ROBERT RAY SCALISE PETER MICHAEL 1500 39TH AVE NE SCALLEN LENORE KAINE 5321 CLINTON AVE SO SCALLEN THOMAS MICHAEL 5329 GRAND AVE SO SCALLON ANTHONY J 410 11TH SE SCANDIN JOHN JAMES 1406 ANDERSON RD SCANDIN LAWRENCE JOSEPH 1406 ANDERSON RD SCANLAN MARGARET MARY 2573 EAST AVE SCANLAN MARY LUFKIN LU 2108 COMO AVE SE SCANLAN MICHAEL JOHN 4000 16TH AVE SO SCANLAN MICHAEL JOHN SCANLAN THOMAS MICHAEL 2108 COMO AVE SE SCANLAN TIMOTHY MICHAEL 1787 ASHLAND AVE SCANLON CATHY JO 409 UNIVERSITY AVE SCANLON GERHARD ROBERT 403 S 70 AVE W SCANLON JAMES EDWARD 9230 RIVERVIEW AVE SCANLON LARRY MELVIN 403 S 70TH AVE W SCANLON MARCIA JOANNE 4801 E 38TH ST SCANLON MICHAEL JOHN 807 12 AVE E SCAPANSKI LARRY NORBER 537 6TH AVE SO SCAPANSKI MARY LOUISE 1037 DAVERN ST SCARAMUZZO NANCY ANNE 191 W MARYLAND AVE SCARLETT SUSAN RAE COMSTOCK HALL SCARROW RICHARD FLOYD 5530 CAMDEN AVE NO SCATTARELLA DANIEL JAM 4046 THOMAS NO SCATTARELLA DAVID LOUI	69 ED 789-1923 MPL MINNEAPOLIS 71 IT MPL MOUND 68 CLA 331-5842 MPL OLIVIA 70 CLA 521-0155 MPL MINNEAPOLIS GRAD 70 CLA MPL WINONA 70 ED MPL WILLMAR 68 IT MPL MINNEAPOLIS 71 DULTH 525-1251 DULUTH GRAD MPL PORTLAND OR 69 CLA 331-9382 MPL ST PAUL GRAD 645-1471 STP GRAD 645-8013 STP 71 CLA 869-6577 RHF RICHFIELD 70 CLA 489-3017 WTB WHITE BEAR LAKE GRAD 71 AGFHE 786-4892 CRP CIRCLE PINES AS GC 823-6868 MPL MINNEAPOLIS 68 CLA 729-8455 MPL MINNEAPOLIS 71 DULTH 724-9927 WAYZATA 70 IT 473-3230 WAY WAYZATA 68 GC 68 GC 331-5986 MPL MINNEAPOLIS 68 GC 68 GC 922-5054 EDN EDINA GRAD MPL ARGENTINA GRAD 71 CLA 788-8943 CLH COLUMBIA HTS AS CLA 822-6131 MPL 70 CLA 824-0482 MPL MINNEAPOLIS GRAD MPL ACKLEY IA 71 DULTH 722-5098 DULUTH 69 DULTH 722-5098 DULUTH 71 ED 777-3229 NSP NORTH ST PAUL 68 CLA 331-3466 STP 69 CLA 729-6347 MPL MINNEAPOLIS GRAD GRAD 331-3466 MPL 71 HED 645-2634 STP ST PAUL 69 PT MPL WILLMAR 71 DULTH 624-2033 DULUTH 69 GC 881-1406 BLT BLOOMINGTON 70 DULTH 624-2033 DULUTH AS CLA 729-0587 MPL MINNEAPOLIS 71 DULTH 724-8317 DULUTH 71 IT 611-6070 SSP SOUTH SF PAUL 69 GC 698-5595 STP FOLEY 71 CLA 489-5598 STP ST PAUL 69 CLA MPL DULUTH 69 CLA 588-5868 MPL MINNEAPOLIS AS GC 522-3109 MPL MINNEAPOLIS 71 CLA 68 CLA 331-7886 MPL MINNEAPOLIS 68 CLA MPL MOLINE IL 70 AGFHE 644-5704 STP HASTINGS
--	--	--	---	---	--











SCHWEND LAURENE ILY 5125 13TH AVE SO SCHWENK TYRONE DAMON 9020 PARK AVE S SCHNEPPE MARY LOUISE 1215 12TH AVE NW SCHWICKERT JILL LINDA 1012 SE 5TH ST SCHWIE LARRY WILLIAM BAILEY HALL SCHWIE LYNN DIANE SANFORD SCHWIEGER DAVID PAUL 1507 WASH AVE S SCHWIEGER GRACE IRENE 916 19 AVE SE SCHWIETZ DANIELLE LOUI 1098 E ORANGE SCHWIETZ JEANINE MARIE 2190 LARRY HO DRIVE SCHWINN BARBARA ANN 4306 ALABAMA SE SCHWINN RONALD ALEXAND 3450 LOGAN AVE NO SCHWOCHERT KATHERINE A 1023 UNIVERSITY AVE SE SCHWOCHERT MARTHA SUSAN SANFORD HALL SCHWOCHERT MARY PATRIC PIONEER HALL SCIORTINO KATHRYN REDD 222 58TH ST E SCIPIONI JOHN STEVEN GRIGGS HALL 8312 SCOBIE BARBARA ANN GRIGGS HALL K113 SCOBIE PAUL NORMAN TERRITORIAL HALL SCOBIE SANDRA JOLEEN CUMSTOCK HALL SCOFIELD JACQUELINE LE BURNSTIDE HALL 136 SCOFIELD JAMES IRA  SCORE DAVID JOHN 7544 CHICAGO AVE SO SCORESBY A LYNN  SCOTLAND LEE CONRAD TERRITORIAL HALL SCOTT ALMA LEE 1503 GOODRICH SCOTT BONNIE LEE 1810 FILLMORE NE SCOTT CONSTANCE DOWNS 4711 FREMONT SO SCOTT DALE HARVEY  SCOTT DAN LEE GRIGGS HALL 8312 SCOTT DANIEL MARTIN 5306 LOGAN AVE SO SCOTT DAVID MICHAEL 549 HIAWATHA SCOTT DAVID ROBERT  SCOTT DIANA 303 CEDAR AVE SO SCOTT ETHEL OLIVIA S  SCOTT GLEN ELLIOTT TORRANCE HALL 355 SCOTT GREGORY DEAN 20 E 46TH ST SCOTT JACQUELYN LEE 2400 OAKLAND AVE SCOTT JAMES ALLEN 5806 JUNIATA SCOTT JAMES RICHARD 1829 UNIVERSITY AVE SE SCOTT JAMES THOMAS 5104 TINGDALE SCOTT JEFFERY ROBERT 100 SO CALIFORNIA SCOTT JOHN THOMAS 549 HIAWATHA SCOTT JOYCE ANN 7508 OAKLAND AVE SO SCOTT JUDITH NAOMI  SCOTT JULIAN JAMES 4254 24TH AVE S SCOTT KATHERINE LOUISE 517 20TH AVE SO SCOTT KATHLEEN LOIS 830 N 23RD AVE W SCOTT LAWRENCE EUGENE 2060 HODSON RD SCOTT LESLIE DALE 7969 SUNNYSIDE RD NE SCOTT LINDA JEAN 1102 MISSISSIPPI AVE SCOTT MARY JUDITH BAILEY HALL SCOTT MARY MARGARET 4631 REGENT ST SCOTT MARY SUZANNE GRIGGS HALL L116 SCOTT NORMAN WRIGHT 2 2751 1/2 LAMPHERE DR  SCOTT PATRICIA ANN 4139 UPTON SCOTT RICHARD WILLARD 372 NO CLEVELAND APT 13 SCOTT ROBERT HARRINGTON 2520 PAHL AVE NE SCOTT RONALD LAVERN 915 PENN AVE NO SCOTT SANDRA LYNN 1570 VINCENT ST SCOTT TERENCE NEIL 4631 REGENT ST SCOTT THOMAS RAY 631 OAK ST SE SCOTT ULRIC CARL JR  SCOTT WILLIAM RICHARD  SCOVELL WILLIAM MARTIN  SCOVILL GERALD DAVID CENTENNIAL HALL SCRIBNER DUANE C  SCROGGINS MABLE ALICE 1614 OAK PARK AVE NO SCROGGINS MAURICE ELBE 2015 JAMES SO SCROGGINS MICHAEL LEE 969 ROSELANN SCUDDER GLENN NELSON  SCUDDER MARILYN JEAN  SCULLY EILEEN ZITA  SCULLY LARRY L 3936 MINNEHAMA AVE SO SCULLY MARY CECILE 58 ORLIN AVE SE SCULLY RITA MARIE 1564 SELBY AVE SCULLY SR MARILLAC  SCULLY SUSAN MARIE 1564 SELBY AVE SCURRAH JAMES MELVIN 4921 LOGAN SO SEABLOND CURTIS DEAN 908 SO CYPRESS SEAL DONALD GENE 2520 PILLSBURY AVE S SEALE FRANCIS MARY CUMSTOCK HALL SEAMAN RONALD STUART 1709 2ND AVE SO SEAMANS LLOYD HUNT  SEAMANS MICHAEL RAY 6620 GERARD AVE SO SEAMANS ROY ROBERT RT 5 BOX 88W SEAMENS DANIEL ANTHONY TERRITORIAL HALL SEAMENS JOAN MARGARET 504 5TH ST SE SEAQUIST DAVID LOWELL  SEARLE R NEWELL JR 1165 14TH AVE SE SEARLES LORRAINE VIOLA 2510 BUCHANAN ST NE SEARLES WILLIAM RAYMON  SEASHORE EUGENE HUGO J 5713 BEARD AVE SO SEASHORE JOAN ELIZABET 311 10TH AVE SE SEAT PHILIP DAVID  SEATH MICHAEL SCOTT DEXTER HALL SEATON ESTA KLEIN  SEATON WILLIAM JOHN 1209 8TH LN SEAVERSON JOHN LLOYD 805 E RIVER RD SEAVEY FREDERICK RUDDL  SEBA BARBARA ALICE 3941 VERA CRUZ AVE NO SEBERG JOHN FRANCIS 1038 E 4TH SEBRING ELIZABETH STRE 2320 NOTTINGHAM CT SEBURG DAVID VICTOR 5913 XERXES AVE NO SEBY DIANE MARSHA 7801 13 LANE SECK ALLAN RICHARD 2949 DOUGLAS DR SECK GERALD LYNN 1826B 5TH ST SO SECK JAMES SCOTT 6304 ROLF AVE SECK LYNDIA MALONE SUE 1826B 5TH ST SO SEDERBERG RICHARD LAYN 2650 MERIDIAN DR  SEDERSTROM LEONARD THO 156 W SPRUCE SEDGWICK THOMAS BENSON 404 8TH ST SE SEIDIO DARRYL PATRICK 3034 PIERCE ST NE SEDLACK THOMAS ELDEN  SEE LAVONNE ENGLUND RA 1728 E 3RD ST SEEBACH RICHARD JOHN  SEEBER PAMELA ANN 5605 MCGUIRE RD SEEBOHM INGRID MARY 241 POWELL HALL SEEGER MICHAEL JACK  SEEGER RICHARD ALLEN 7100 13 AVE SO SEEGER ROBERT CHARLES 3109 4TH ST SE SEEKINS DANIEL LEONARD 1485 CLEVELAND SEEKINS LESLEY ELLEN 1103 4 ST SE SEEL RICHARD ALAN 6327 STEVENS AVE SEELAND MICHAEL JAMES TERRITORIAL HALL SEELEY DIANE LOUISE 327 14TH AVE SE SEELEY GAYLE LYNN 2009 E HOYT AVE SEELEY GERALD RAYMOND 540B COUNTRYSIDE RD SEEMAN ESTHER MILTON  SEEMAN PAMELA LIND JEA 29 RIVER TERRACE COURT SEEMANN BARBARA WEBER 2599 NO LEXINGTON SEEMANN DAVID GEORGE 3737 QUAIL AVE N SEETIN GEORGE ALVIN 1425 UNIVERSITY AVE SE SEFELT ROGER THOMAS 3855 10TH AVE SO SEGAL ALAN EDWARD 1412 HAMPSHIRE AVE S SEGAL BARBARA ANN 3552 IRVING AVE S SEGAL BONNIE LYNN 4801 E MARIE LANE SEGAL CAROL JEAN 2001 VINCENT NO SEGAL GREGORY MARK TERRITORIAL HALL SEGAL JAY ALAN  SEGAL NOLAN MARK 2221 S HILL LANE SEGAL RANDY 915 SO SNELLING SEGAL SHELDON JAY  SEGALE ANTHONY JAMES 2082 PALACE AVE SEGUIN BRADLEY EDSON 2 2328 BREWSTER ST SEGUIN ROSEMARIE VIRGI 6215 WESTRIDGE BLVD SEGUIRE JON MICHAEL 315 16TH AVE SE SEIBEL BONNIE RAE 3313 EGDEN AVE SEIBEL KAREN RAE 5744 19TH AVE SO SEIBERLICH JOHN ROBERT  SEIBERLICH LAWRENCE JA 799 1ST AVE NW SEIBERLICH SCOTT JOESE 1878 N ALBERT SEIBERT MICHAEL JOSEPH 2421 24TH AVE SO SEIDEL THEODOR KURT  SEIDENKRANZ PAMELA WYN SANFORD HALL SEIDENKRANZ ROBERT ERN 1028 W MONTANA AVE SEIDL STEVEN EDWARD 915 E HAWTHORNE SEIDL SUSAN KRISTINE 3046 CLEVELAND ST NE SEIDL THOMAS JAMES 761 DELAWARE AVE SEIFERT CARLA FRITSCH 444 SO FAIRVIEW AVE SEIFERT CASSANDRA RAE 2320 FREMONT AVE SO SEIFERT DEBORAH DEANE 2320 FREMONT AVE SO SEIFERT FLOYD FRED 1985 NO CHATSWORTH SEIFERT JUDITH ELAINE 5616 W 107TH ST SEIFERT LINDA PAULETTE 1660 UPPER AFTON RD  SEI 455-4517 SSP SOUTH ST PAUL 69 LAW 333-5928 MPL EDINA 69 CLA MPL 68 MED 68 DULTH 728-4820 DULUTH 69 IT 68 DENHY 941-1009 EDN EDINA 68 CLA 339-0531 MPL VESTAL NY 70 DULTH RED LAKE FALLS 68 GC 866-8185 RHF RICHFIELD GRAD 331-6787 MPL SALEM OR 69 AGFHE 645-8787 STP HOYT LAKES 70 CLA MPL JAMESTOWN ND 68 GC RHF RICHFIELD 71 IT 276-3418 MPL PAYNESVILLE 69 CLA MPL ROCHESTER 70 CLA 776-2447 STP ST PAUL GRAD 929-3048 EDN SCHOFIELD WI GRAD 68 BUS 338-1369 MPL HIBBING 70 CLA 484-5955 ROV 68 CLA 588-2861 ROB RAPID CITY SD 68 IT 331-1013 MPL MINNEBAGO 70 CLA 825-1003 MPL MINNEAPOLIS 69 LAW 544-1113 MPL MINNEAPOLIS 70 CLA 744-7729 MPL MINNEAPOLIS 70 CLA 588-1248 GOV GOLDEN VALLEY 69 ED 522-8700 MPL MINNEAPOLIS 71 CLA 373-6631 MPL DULUTH 71 IT 71 CLA 926-5146 SLP ST LOUIS PARK 69 GC 699-7446 STP ST PAUL GRAD 71 IT 699-2571 STP ST PAUL 70 VET M 644-1196 STP ALMA CENTER WI 71 AGFHE 929-7664 EDN EDINA 68 CLA 331-7929 MPL BUFFALO NY 71 CLA MPL COURTLAND 68 ED P49-1154 MPL MINNEAPOLIS 68 IT 68 IT 633-8989 NWB 71 CLA 645-9050 FLH FALCON HEIGHTS 69 GC 722-4449 MPL MINNEAPOLIS GRAD 70 CLA 488-2470 MPL ST PAUL 71 IT 489-5946 STP ST PAUL GRAD 776-7046 STP ST PAUL 69 GC 789-3794 MPL MINNEAPOLIS 71 CLA 224-9103 STP ST PAUL 68 ED 698-7552 STP NEW ULM 68 GC 377-7492 MPL MINNEAPOLIS 71 CLA 377-7492 MPL MINNEAPOLIS 68 GC 488-3205 ROV ROSEVILLE 70 CLA 944-1083 BLT BLOOMINGTON 69 ED 771-0141 STP ST PAUL
---











SILTALA DANIEL EDWARD 1820 3RD AVE NO SILTBURG DONALD NICHOL 4616 ADAIR AVE NO SILTMAN CAROLYN MARGAR 2215 HAINES RD SILUS STEPHEN DOUGLAS RT 1 BOX 24 SILVA RICHARD THOMAS 1515 W LAGOON AVE SILVER ALAN ARNOLD 4718 W 28TH ST SILVER ALAN IRVING 2501 INGLEWOOD AVE SILVER DANIEL MORRIS 5704 LONGFELLOW AVE SILVER DONALD THOMAS 4077 HUBBARD AVE N SILVER GEOFFREY STUART 1614 JAMES AVE NO SILVER JOAN SHIRLEY 8031 W 18TH ST SILVER KENNETH ALLAN 1833 ROME AVE SILVER STEVEN JAMES 1514 JAMES NO SILVER TERRY CAROLYN 1614 JAMES NO SILVERBERG JON FRIEDOL	68 IT 377-0172 MPL SEBEKA 68 CLA 537-7376 ROB ROBBINSDALE 69 DULTH 722-0362 DULUTH 68 GC 472-3685 MND MOUND 71 GC 825-1747 MPL MINNEAPOLIS 68 PHARM 926-8177 SLP ST LOUIS PARK 71 CLA 922-8097 SLP ST LOUIS PARK 71 IT 729-4155 MPL MINNEAPOLIS 68 BUS 533-5603 ROB TRACY 70 CLA 521-5650 MPL MINNEAPOLIS 68 ED 544-1480 SLP ST LOUIS PARK 70 CLA 699-5693 STP ST PAUL 68 ED 621-6259 MPL MINNEAPOLIS 71 CLA 521-5650 MPL MINNEAPOLIS 68 IT	SIMNING GARY JOHN 221 N 9 AVE E SIMON BARBARA REYNOLDS 416 4TH AVE NE SIMON HOWARD LESLIE 416 4TH AVE NE SIMON JEFFREY ALLEN 1776 BEECHWOOD AVE SIMON LUELLA CARDINAL SIMON MICHAEL JOHN SIMON MICHAEL KLEMENT SIMON RONALD JOHN 8022 SHERIDAN AVE S SIMON SR M MARIS GOOD COUNSEL HILL SIMON THOMAS CHARLES 1717 UNIVERSITY AVE SE SIMONEN LEE WILLIAM 520 WINNIPEG AVE SIMONES BARBARA JEAN 425 8TH AVE SE SIMONES ELSEBETH ANNE 6005 KELLOGG AVE SIMONES GEORGE JOSEPH SIMONES LYNNE MARY 6005 KELLOGG AVE SIMONET EDWARD WIELAND GRIGGS HALL C315 SIMONETTI THOMAS ROBER 183 MALCOLM AVE SE SIMONITSCH JOHN HENRY 420 E 73RD SO SIMONITSCH MARY ANN 4034 REGENT AVE NO SIMONS ALLAN BARNARD 2026 BREWSTER ST SIMONS KATHLEEN WALL R 1J/O AUDREY LANE SIMONS KENNETH CHARLES 2966 N SIMPSON SIMONS MARY CLARE SIMONS ROBERT ALAN 910 LYNDE DRIVE SIMONS SR M ANTOINETTE COMSTOCK HALL SIMONS WILLIAM PAUL 1112 6TH ST SE SIMONSEN GARY LEE 4727 PEABODY ST SIMONSEN HAROLD HANS 3209 PARK AVE SO SIMONSEN MARK ROBERT 2820 NOBLE AVE SIMONSEN PAUL MICHAEL 1485 N CLEVELAND SIMONSEN RICHARD JOHN PIONEER HALL SIMONSON ARVID LLOYD 612 24 AVE W SIMONSON BARBARA DELL SIMONSON CRAIG LOUIS 4109 LAVAQUE RD SIMONSON DOREEN LUCILL 5712 19TH AVE SO SIMONSON KENNETH BERNE 2615 38TH AVE SO SIMONSON KERMIT LEROY 3350 DUPONT AVE SO SIMONSON LEO VAN JR 522 BROADWAY NE SIMONSON LINDA JEAN 1131 DODD RD SIMONSON MYRON MALCOLM 3125 LYNDALE AVE SO SIMONSON NANCY JILL 528 N 23RD AVE W SIMONSON NEIL WALLACE FRONTIER HALL SIMONSON PETER ROY 2520 PARKVIEW BLVD SIMONSON RICHARD GENE GAY HALL SIMONSON RICHARD HERMA TERRITORIAL HALL SIMONSON ROGER DAVID SIMONSON SHARON LOUISE SIMONSON SIDNEY LEE 2502 E SUPERIOR ST SIMONSON STEVEN JEROME SIMONSON TOMMY CHARLES 114 N 66TH AVE W SIMONSON WALTER JEROME SIMONVICH MARJORIE ANN 1815 WALLACE AVE SIMPKINS CHARLES EDWAR 225 OAK GROVE ST SIMPSON ELEANOR ELIZAB 2620 14TH AVE S SIMPSON ELWOOD OTTO 7620 1ST AVE SO	69 DULTH 728-3948 WABASSO GRAD 335-0471 MPL BRONX NY GRAD 335-0471 MPL NEW YORK NY 70 CLA 699-1551 STP ST PAUL GRAD 70 CLA FARIBAULT 71 IT 451-5752 MPL OWATONNA 68 BUS 888-6920 BLT BLOOMINGTON GRAD 70 CLA 473-9767 MPL MINNETONKA 71 DULTH 722-9369 DULUTH 69 ED 331-3288 MPL JORDAN 69 GC 926-9973 EDN EDINA 70 CLA 68 CLA 926-9973 EDN EDINA 71 DULTH 724-9880 STILLWATER 69 GC 332-0710 MPL MINNEAPOLIS 68 IT 861-3671 RHF ROBBINSDALE 69 PT 477-3979 MPL MINNEAPOLIS GRAD 646-0467 STP BINGHAMTON NY 68 DULTH 326-6410 GRAND RAPIDS 68 AGFHE 633-5503 ROV WEST ALLIS WI GRAD 70 LAW 788-0171 FRD SIOUX FALLS SD AS ED 373-7156 MPL DENVER CO 70 CLA 331-6889 MPL LAKE CITY 71 DULTH 525-3814 DULUTH 70 CLA 822-0085 MPL GRAND MARAIS 69 CLA 588-1792 GDV GOLDEN VALLEY 70 AGFHE STP FAIRFAX 71 DENT 373-6161 MPL NORWAY 71 DULTH MCGRATH 71 CLA 71 DULTH DULUTH 71 CLA 722-7152 MPL FARIBAULT 68 GC 729-3294 MPL ANNANDALE 70 CLA 825-5472 MPL BENSON 69 ED 332-5078 MPL MINNEAPOLIS 70 CLA 224-0630 WSP WEST ST PAUL 69 GC MPL BENSON 70 DULTH 727-5970 DULUTH 70 CLA MPL FARIBAULT 70 CLA 588-1839 GDV GOLDEN VALLEY 71 MORRS BROWERVILLE 71 IT MPL MCINTOSH 68 BUS 69 NURS 70 DULTH 724-3293 BUHL 69 MORRS WOOD LAKE 71 DULTH 624-3832 DULUTH GRAD 60 DULTH 724-3712 SOUDAN GRAD MPL SHOALS WV GRAD MPL 70 CLA 869-3491 RHF RICHFIELD	SIMPSON JOHN M 404 2ND AVE SE SIMPSON MARILYN JANE B 212 EDMUND SIMPSON RONALD DENNIS RT 1 BOX 552A SIMPSON SCOTT SIMPSON STEPHEN PAIGE 623 BRYANT AVE NO SIMS ERMA JOHNSON RUTH 863 FULLER AVE SIMS JUDITH EILEEN 725 8TH AVE SE SIMS NANCY RAY 5028 VALLEY VIEW RD SIMUNOVICH LOIS ANNE 2019 E 2ND ST SIMURDAK ROGER CHARLES CENTENNIAL HALL SIMUTIS CATHY THOMPSON 1405 COMO SE SIMUTIS LEONARD JOSEPH SINAIKO JOANNE SARA 1371 FAIRMOUNT AVE SINCKLER MAXINE JANICE 517 15TH AVE SE SINCLAIR DAVID EUGENE 5818 HARRIET SINCLAIR JERRY MANLY 1513 E SUPERIOR ST SINCLAIR MICHAEL DEAN 3300 LOUISIANA AVE NO SINCLAIR PATRICK BENEDE 14 E FRANKLIN AVE SINDE SR M URSULA SINDELIR BONITA FAYE 629 UNIV AVE SE SINDELIR JO ANN GAY HALL SINDING STUART ERICK SINE MARY FARMER K 1725 EMERSON AVE SO SINENSE RICARDO RABANG SINGER DANIEL EUGENE SINGER DAVID ALLEN 2128 NILES AVE SINGER JEFFREY DAVID 2945 AQUILA AVE SO SINGER MICHAEL GERALD 2128 NILES SINGER MICHAEL JOHN 3020 OLD HIGHWAY B SINGER RICHARD CARL 1067 15 AVE SE SINGER ROBERT ALAN 352 LEICESTER AVE SINGEWALD ROBERT WILLI 3405 HIGHLAND DR SINGH AVTAR SINGH KANWAL NAIN DEPT OF MECH ENGR SINGLETON NANCY CAROL 914 E 2ND ST SINGSAAS EUGENE BENNIE 3850 W BROADWAY SINHA NAVIN KUMAR DEPT OF GENETICS SINKO LOUIS FRANKLIN TORRANCE HALL 354 SINKO ROBERT MICHAEL 814 ESSEX ST SE SINKOLA GARY LEE SINKOLA MICHAEL BINO 828 CHESTER PARK DR SINKS JOHN FREDERICR 6304 BARRIE RD SINN DAVID RICHARD 409 VAN DYKE ST SINN LINDA ANN 1214 7 ST SE SINN RICHARD JOHN 2912 VANDERBIE ST SINNA LEO CARL 5303 HODGSON RD SINNER STEPHEN WINTBR BLAKELY HALL SINNIGER BEVERLY RUTH 1940 FAIRMOUNT SINNOTT PATRICIA MARIE 4733 W 11TH ST SINNOTT THOMAS MINAR 1112 6TH ST SE SIPE ELIZABETH ANN GRIGGS HALL M312 SIPF VALERIE JEAN 321 ELMER SIPKINS DOROTHY GOODMA 4015 W 39TH ST SIPKINS PETER WASSERMA 48 GROVELAND TERR SIPPEL CURTIS LYNN 601 7TH ST SE	GRAD 336-9292 MPL INDIANA NY 69 GC 225-8296 STP ST PAUL 71 DULTH 879-9056 CARLTON 71 CLA MPL MINNEAPOLIS 71 CLA 374-1749 MPL MINNEAPOLIS 68 ED MPL GRAD MPL ROCKY RIVER OH 68 GC 929-5860 EDN EDINA 69 DULTH 724-4591 CALUMET GRAD 339-7421 MPL DEPERE WI 68 CLA 331-6877 MPL GRAD 68 MEDTC 698-5196 STP ST PAUL 71 IT 331-8073 MPL BARBADOS 68 IT 823-5022 MPL MINNEAPOLIS 70 DULTH 728-2108 DULUTH 68 MEDTC 533-9236 CYT CRYSTAL 69 CLA 529-6823 MPL COLD SPRING AS ED 68 ED 336-1211 MPL PITT 70 MORRS MORTON 68 MORSC GRAD 377-5249 MPL SAC CITY IA GRAD 69 CLA 68 UCOL 698-7700 STP ST PAUL 69 GC 935-0018 SLP ST LOUIS PARK 70 CLA 698-7700 STP ST PAUL GRAD 633-6059 ROV WHITE PLAINS NY 70 CLA 331-3161 MPL MINNEAPOLIS 70 DULTH 724-1964 DULUTH 71 CLA 890-1564 SAV SAVAGE GRAD GRAD 373-2994 MPL NEW DELHI 71 DULTH ISABELLA 68 AGFHE 533-7379 ROB WESTBROOK GRAD 647-3949 STP PATNA 70 DULTH 724-9800 HIBBBING 69 DENT 331-1324 MPL CHISHOLM 71 DULTH DEER RIVER 69 DULTH 724-6212 DEER RIVER GRAD EDN 71 CLA 735-2910 STP ST PAUL 70 CLA 331-9354 MPW MAPLEWOOD 69 IT 484-2882 LTC LITTLE CANADA 71 DENT 484-3453 SHV SHOREVIEW 71 MORRS 589-3121 REDWOOD FALLS AS CLA 373-3913 STP 68 GC 888-1978 BLT BLOOMINGTON 70 CLA 331-6809 MPL EDINA 70 DULTH 724-9869 ROBBINSDALE 71 AGFHE 489-5458 ROV ROSEVILLE AS ED 926-5103 SLP 69 LAW 377-1211 MPL MINNEAPOLIS 68 BUS 331-3180 MPL WINDOW
---	---	--	--	--	---









SMITH STANLEY STEVE 71 AGFHE 647-3756  
P O 1428 COFFEY HALL  
SMITH STEPHEN JAMES 68 GC

SMITH STEPHEN LEE 70 MED  
325 HARVARD ST SE  
SMITH STEVEN CHARLES  
TERRITORIAL HALL  
SMITH SUSAN ANN  
BAILEY HALL  
SMITH SUSAN JANE  
SANFORD HALL  
SMITH SUSAN LYDIA  
3743 BLAISDELL AVE SO  
SMITH SUSAN RAE  
6436 COLFAX AVE NO  
SMITH SVEA EDSTROM  
949 44TH AVE NE  
SMITH TERRY CRAIG  
600 UNIV AVE SE  
SMITH TERRY LEE  
34 WEST ROAD  
SMITH THOMAS HARVEY  
2101 21ST AVE SO  
SMITH THOMAS JAY

SMITH TRUDY SUZANNE  
SANFORD HALL  
SMITH VICKI LYNN  
791 E MONTANA AVE  
SMITH VIRGINIA LEE  
1251 90TH AVE W  
SMITH WAYNE EDWARD  
1861 GOODRICH  
SMITH WESLEY ROGER  
6344 ROLF AVE SO  
SMITH WILEY EDWARD  
152 E NIAGARA ST  
SMITH WILLEEN KALB VIO  
4012 QUEEN S  
SMITH WILLIAM ALEXANDE  
840 18TH AVE SE  
SMITH WILLIAM ARTHUR  
273 S SARATOGA  
SMITH WILLIAM BARCLAY  
2430 MCNAIR DRIVE  
SMITH WILLIAM FREDERIC  
248 15TH AVE SO  
SMITH WILLIAM JOHN  
1324 E 9TH ST  
SMITH WILLIAM MICHAEL  
FRONTIER HALL  
SMITH WILLIAM VAN SLYC  
3509 EMERSON SO  
SMITH WILLIE JAMES

SMITH ZOLA JANE LEE 68 GC 722-1504  
4205 40TH AVE S  
SMITMBERGER SANDRA ANN  
2300 ALDRICH AVE S  
SMITHEVASCONCELLOS BE  
3317 MINNETKA AVE NO  
SMITHERMAN MARVIN LEE  
902 26TH AVE SE  
SMITHSON MARK CHARLES  
118 W PEARY ST  
SMITS STEPHEN EDWARD

SMITS VALDIS GEORGE 68 IT 644-3696  
1364 EUSTIS  
SMOKA ROGER EDWARD  
3009 STINSON BLVD  
SMOKA WILLIAM DENNIS  
338 QUINCY ST NE  
SMOLAK JANE FRANCES  
6118 COLFAX LANE SO  
SMOLICH JAMES PHILIP  
TORRANCE HALL 365  
SMOLIK BARBARA ANN  
392 BANFIL ST  
SMOLIK KATHERINE LOUIS  
146 AMHERST  
SMOLIK NANCY JANE  
146 AMHERST  
SMOLIK THOMAS GEOFFREY  
941 ELEANOR AVE  
SMOLIN LEWIS MARVIN

SMOLKA PATRICIA HELEN 71 CLA 335-5850  
829 MARSHALL ST NE  
SMOTHERGILL DANIEL WIL

SMRCKA JERRY DEAN 69 IT 866-5219  
7200 12TH AVE SO  
SMREKAR JEROME ALBERT

SMRKOVSKI JAMES EDWARD  
616 6TH AVE SE  
SMUCKLER JACK DENNIS  
2024 PENN AVE SO  
SMUDE GERALD JOHN  
1624 CARL  
SMULLEN THOMAS HAMILTO  
1724 LOGAN AVE SO  
SMUTKA PAULETTE CHRIST  
605 OAK ST SE  
SMUTKA ROBERT ALAN  
TERRITORIAL HALL  
SMUTKA STEVEN DOUGLAS  
FRONTIER HALL

71 AGFHE 647-3756  
STP LEWISTON  
68 GC

70 MED  
MPL BLUE EARTH  
71 CLA 395-2225  
MPL LESTER PRAIRIE  
70 AGFHE  
STP ST PAUL  
71 CLA  
MONTEVIDEO  
GRAD 823-1593  
MPL W COXSACKIE NY  
70 CLA 561-2697  
BRC BROOKLYN CENTER  
AS ED 788-4184  
CLH  
GRAD 333-2720  
MPL WAYZATA  
69 GC 786-4473  
CRP CIRCLE PINES  
69 BUS 335-8572  
MPL WINNIPEG  
GRAD

70 CLA  
MPL ALBERT LEA  
70 CLA 771-5740  
STP ST PAUL  
70 DULTH 626-2696  
DULUTH  
70 CLA 338-0293  
STP WINDOM  
68 CLA 941-2471  
MPL MINNEAPOLIS  
70 DULTH 728-3331  
DULUTH  
GRAD 926-7437  
MPL MINNEAPOLIS  
71 CLA  
MPL MINNEAPOLIS  
71 CLA 698-0689  
STP ST PAUL  
69 BUS 588-6249  
MPL MINNEAPOLIS  
GRAD 333-7637  
MPL MINNEAPOLIS  
69 DULTH 724-6127  
DULUTH  
71 CLA  
MPL  
71 CLA  
MPL MINNEAPOLIS  
68 ED

68 GC 722-1504  
MPL MINNEAPOLIS  
70 CLA 377-6729  
MPL FARMINGTON  
68 CLA 544-2147  
CYT  
GRAD 331-1489  
MPL COATESVILLE IN  
71 DULTH 626-1781  
DULUTH  
GRAD

68 IT 644-3696  
STP ST PAUL  
70 AGFHE 788-5126  
MPL MINNEAPOLIS  
AS GC 335-0173  
MPL MINNEAPOLIS  
68 CLA UN9-2051  
MPL MINNEAPOLIS  
69 DULTH 724-9800  
AURORA  
69 GC 224-1175  
STP ST PAUL  
71 CLA 699-7433  
STP ST PAUL  
68 ED 699-7433  
STP ST PAUL  
69 GC 227-5037  
STP ST PAUL  
69 IT

71 CLA 335-5850  
MPL MINNEAPOLIS  
GRAD

69 IT 866-5219  
RHF RICHFIELD  
70 IT  
ELY

GRAD 331-8756  
MPL OSTRANDER  
68 IT 377-8231  
MPL MILWAUKEE WI  
69 AGFHE 645-4986  
STP PILLAGER  
68 GC 377-2608  
MPL  
68 MEDTC 331-4639  
MPL RICHFIELD  
71 CLA  
MPL ROCHESTER  
71 CLA  
MPL HUTCHINSON

SMYRAC JAMES MICHAEL  
2230 JOHNSON ST NE  
SMYTH SUSAN ANNE  
1555 MEADOW LANE  
SMYTHE TED CURTIS

SMYTHE WAYNE SWIGGUM  
FRONTIER  
SNABB CHARLES RAYMOND  
1324 MORGAN AVE N  
SNACKENBERG STEVEN JAM  
3630 XENIA AVE NO  
SNAVELY JAMES PATRICK  
1115 FIFTH ST SE  
SNEDEKER CLARENCE WILL  
3318 COLFAX SO  
SNEEN ARTHUR TERRY  
3728 36 AVE SO  
SNEGOSKI JOHN PATRICK  
1321 6 ST SE  
SNEGOSKY KAREN MARY  
231 PIONEER COURT  
SNELL GARY WAYNE

SNESRUD WAYNE REUBEN

SNETTING DONNA JEAN  
5452 31ST AVE SO  
SNETTING LEE VERNE  
5452 31 AVE SO  
SNETTING PAMELA ANN  
5324 38TH AVE SO  
SNEVE JACK STICKNEY 3  
2304 VERMILION RD  
SNIDER JOHN MATTHEW  
2204 RIVER HILLS DR  
SNIDER PAUL GREGORY  
2204 RIVER HILLS DR  
SNIDER ROSALIE INEZ  
2405 W 58TH ST  
SNIDER THOMAS MICHAEL  
2913 31 1/2 AVE NE  
SNITZ GWENDOLYN COHEN  
1566 E 80TH  
SNOBECK STEVEN RODNEY  
3012 E 50TH ST  
SNODGRASS BRADLEY FLOY  
2426 E SUPERIOR ST  
SNODGRASS LANA JEAN  
6615 WASHBURN AVE SO  
SNOEYENBOS CHRISTIAN R

SNOEYENBOS DAVID EDWAR  
5125 VALLEY VIEW RD  
SNOEYENBOS MILTON HENR  
7 BARTON AVE  
SNOKE MARY ANN  
2128 GOODRICH AVE  
SNOKE ROBERT LEE  
2128 GOODRICH AVE  
SNOOK JOSEPH EDWARD  
4350 BROWDALE AVE  
SNOOK ROBERT EDWARD  
1398 ST PAUL AVE  
SNOW ALICE HELEN  
1972 NO PRIOR  
SNOW DOUGLAS GORDON  
1972 NO PRIOR  
SNOW KATHERYN ANNE  
615 SE 6TH ST  
SNOW LARRY ALLEN  
315 19TH AVE SE  
SNOW MARK EDWARD  
2151 NILES AVE  
SNOW STEPHANIE MICHEL  
801 UNIVERSITY AVE SE  
SNOWFIELD JOHN GARRIS

SNYDER BARBARA ANN  
2111 HUMBOLDT SO  
SNYDER BOYD JUNGHANS  
2309 E 1ST ST  
SNYDER DAVID PAUL  
2344 COWERN PL  
SNYDER DIANNA MARIE  
1410 17TH AVE N  
SNYDER DONN WILLIAM  
227 OAK GROVE  
SNYDER EDWARD JOHN  
1927 DAYTON  
SNYDER ERVA MAY  
2128 KNAPP ST  
SNYDER HENRY ALLEN

SNYDER JACQUELINE MART  
3801 69TH AVE NO  
SNYDER JAMES LEWIS  
4221 16TH AVE S  
SNYDER JOHN RAYMOND  
2089 CARTER AVE  
SNYDER JUDY ZIMMER JEA  
225 3RD AVE SE  
SNYDER MARGARET ISABEL  
3318 62ND AVE NO  
SNYDER MARY DOLORES  
951 17TH AVE SE  
SNYDER RAYMOND LEE  
6252 SWAN LAKE RD

70 DENT ST1-4317  
MPL MINNEAPOLIS  
70 CLA 227-6047  
WSP WEST ST PAUL  
GRAD

71 IT  
MPL MENAHA  
68 GC 529-7802  
MPL MINNEAPOLIS  
68 IT 533-9079  
MPL MINNEAPOLIS  
70 CLA 331-3432  
MPL NORTH ST PAUL  
69 BUS 522-2621  
MPL MINNEAPOLIS  
70 IT 729-8927  
MPL MINNEAPOLIS  
71 IT  
MPL SHAKOPEE  
69 CLA 373-6012  
MPL LITCHFIELD  
68 ED  
AUSTIN  
68 BUS

70 IT

70 AGFHE 729-8587  
MPL MINNEAPOLIS  
70 CLA 729-8587  
MPL MINNEAPOLIS  
70 AGFHE  
MPL MINNEAPOLIS  
71 DULTH 724-8040  
DULUTH  
70 IT 890-3589  
68 GC 454-1054  
69 ED 926-7179  
MPL  
71 CLA 789-4647  
ST ANTHONY  
68 CLA 884-7170  
BLT SHAWNEE MISS  
69 GC PA2-2473  
MPL MINNEAPOLIS  
69 DULTH 724-1590  
AITKIN  
69 NURS 869-9094  
MPL LAS CRUCES NM  
68 CLA

70 CLA 929-5414  
EDN EDINA  
GRAD 336-7005  
MPL CHIPPEWA FLS WI  
68 ED 698-6313  
STP ST PAUL  
70 CLA 698-6313  
STP ST PAUL  
70 CLA 922-9576  
SLP MILLMONT PA  
68 CLA 698-5973  
STP EDEN PRAIRIE  
71 CLA M15-2947  
ROV ROSEVILLE  
70 CLA M15-2947  
ROV ROSEVILLE  
70 CLA  
MPL MINNEAPOLIS  
70 CLA 331-9297  
MPL GOLDEN VALLEY  
70 CLA 698-6854  
STP ST PAUL  
70 CLA  
MPL WAYZATA  
GRAD

70 CLA 377-4527  
MPL MINNEAPOLIS  
70 DULTH 825-0875  
MINNEAPOLIS  
70 AGFHE 777-3282  
NSP NORTH ST PAUL  
69 GC 521-7710  
MPL MINNEAPOLIS  
69 AGFHE 335-3966  
MPL NEW BRIGHTON  
69 GC 646-3761  
STP ST PAUL  
70 AGFHE 646-0208  
STP ST PAUL  
GRAD

69 CLA 561-2296  
BRC BROOKLYN CENTER  
69 PHARM  
MPL  
GRAD 644-6453  
STP IDAHO FALLS ID  
68 IT 339-3771  
MPL CEDAR  
69 ED 561-3156  
MPL  
68 CLA 331-9015  
MPL  
71 DULTH 722-9907  
DULUTH

SNYDER REUBEN WENDELL  
GRAD

SNYDER RICHARD THOMAS  
4021 SO QUEEN  
SNYDER RITA MARIE  
1824 E HOYT AVE  
SNYDER ROBERT KENNETH  
225 3RD AVE SE APT 4  
SNYDER ROBERT RUSSELL  
3506 LAURA LANE  
SNYDER STEPHEN ALBERT  
1905 1ST AVE SO  
SNYDER STEPHEN JOHN  
3318 62ND AVE NO  
SNYDER SUSAN JENNIFER  
COMSTOCK HALL  
SNYDER SUSAN KAY  
PIONEER COURT  
SNYDER WILLIAM MICHAEL  
BOX 225A RT 1  
SOBANIA DONALD EDWARD

70 CLA 926-0044  
MPL MINNEAPOLIS  
69 GC 771-6462  
STP ST PAUL  
GRAD 339-3771  
MPL MINNEAPOLIS  
68 CLA 938-2442  
HOP  
GRAD 336-5963  
MPL MONTPELIER OH  
69 IT 561-3156  
BRC BROOKLYN CENTER  
71 DENHY  
MPL EWEN MI  
68 CLA 373-6102  
MPL ELMORE  
68 GC 459-5627  
NWP NEWPORT  
68 IT

70 CLA  
MPL ALBERT LEA  
GRAD 544-7179  
GOV  
70 LAW 331-4861  
MPL BROOKLYN NY  
69 OT 338-3502  
MPL AUSTIN  
70 AGFHE

69 GC 529-4300  
MPL MINNEAPOLIS  
70 CLA  
MPL MINNEAPOLIS  
GRAD 645-9885  
STP ARGENTINA  
69 DULTH 722-1329  
DULUTH  
70 CLA 537-3954  
ROB ROBBINSDALE  
71 CLA 484-3608  
ROV ROSEVILLE  
70 CLA 338-1888  
MPL NEWTON MA  
69 IT

71 CLA 781-1460  
MPL MINNEAPOLIS  
71 DULTH 525-3219  
DULUTH  
71 DULTH 624-9605  
DULUTH  
71 DULTH 626-1795  
DULUTH  
70 DULTH 624-7870  
PROCTOR  
68 GC 644-9095  
ROV ROSEVILLE  
68 GC 922-9052  
EDN EDINA  
70 CLA 489-7595  
STP ST PAUL  
70 DULTH 879-8514  
CLOQUET  
69 DULTH 628-1364  
DULUTH  
71 AGFHE  
STP WORTHINGTON  
71 CLA  
MPL MINNETONKA  
68 CLA L15-3355  
MTV MINNETONKA  
68 DULTH 624-1944  
DULUTH  
71 DULTH 525-4673  
DULUTH  
68 DULTH 525-4673  
DULUTH  
71 MED 529-7878  
MPL MINNEAPOLIS  
70 CLA 771-2195  
STP ST PAUL  
AS IT 646-4222  
LRD LAUDERDALE  
68 CLA

GRAD  
STP  
GRAD 544-1778  
MPL GERMANY  
69 IT 331-2499  
MPL MARSHALL  
69 CLA

68 PHARM 922-4375  
SLP ST LOUIS PARK  
68 ED 922-4375  
SLP ST LOUIS PARK  
GRAD 331-1766  
MPL SINGAPORE  
68 CLA 338-7487  
MPL MINNEAPOLIS  
69 AGFHE

71 CLA 437-3346  
HST HASTINGS  
71 CLA  
MEV MIESVILLE





SPRAGUE LINDA ERLANDSO 68 CL  
2621 E 24TH ST  
SPRAGUE MARY ANN 71 CL 825-5035  
4761 PARK AVE SO  
SPRAGUER SANDRA LYNN 68 ED 338-1422  
809.5TH AVE SE  
SPRAIN BARBARA ANN 71 CL 721-4584  
253 FT SNELLING  
SPRAIN KENNETH CRAIG 68 ED PA1-4584  
253 FT SNELLING  
SPRANGERS DEBORAH MARI 71 CL 537-0010  
5400 GEORGIA AVE NO  
SPRAU JERALD DAVID 68 VET M 645-8787  
1485 N CLEVELAND AVE  
SPRAU JILL SUSAN 71 CL  
BAILEY HALL  
SPRAY CHARLES WILLIAM 70 IT

SPRAY DOUGLAS EDWARD 69 MORRIS 589-3296  
530 E 5TH ST  
SPRECKER CAROL LOUISE 71 AGFHE

SPRECKER DOUGLAS HERMA 70 AGFHE 869-5931  
2712 W 72ND ST  
SPREEMAN JAN FENSKE 69 CL 439-4740  
RR 3  
SPREIGL MICHAEL EDWARD 69 GC 489-5703  
45 W MARYLAND AVE  
SPREITZER ALEXANDRA RA 70 DULTH 724-4374  
824 E 11 ST  
SPREITZER FRANK JOSEPH 69 GRAD 631-2063  
1647 W COUNTY RD B  
SPRIESTERSBACH COLIN N 69 GC 588-1921  
5556 MORGAN AVE NO  
SPRING EVELYN BYRD C AS MORRIS 589-4127  
308 SOUTH ST  
SPRING THOMAS GARDINER 69 GRAD 331-6306  
2626 COMO AVE C 2  
SPRING WILLIAM DONALD 71 GRAD

SPRINGBORG JAMES GARY 69 GC  
1920 3RD AVE S  
SPRINGER DENIS DEAN 68 IT 331-6840  
1174 14TH AVE SE  
SPRINGER DWIGHT SYLVAN 71 GRAD 331-4259  
716 14TH AVE SE  
SPRINGER GAIL HART 70 CL 373-4528  
314 10TH AVE SO  
SPRINGER GERALD JOSEPH 71 CL 926-7103  
1872 SO MISS RIV BLVD  
SPRINGER MARILYN JUNE 71 CL 926-7103  
4351 PARKLAWN  
SPRINGER ROBERT FRANCI 70 DULTH 392-3960  
709 E 8TH  
SPRINGRER STEVEN R 71 CL 471-8653  
RT 1 BOX 260X  
SPRINGHETTI ROBERT 71 GRAD VIRGINIA  
218 9TH ST SO  
SPRINGMEYER STEPHEN RO 71 DENT  
PIONEER HALL  
SPROAT DAVID NEWTON 71 DULTH 724-9804  
GRIGGS HALL A317  
SPRY JUNE TINBERG 70 CL 825-7362  
3436 NICOLLET AVE  
SPRY ROBERT E 70 DULTH 728-4508  
1603 E 4 ST  
SPURGIN JOHN ROBERT 70 CL  
2023 STEVENS  
SPURRIER BARBARA ANN 70 CL 588-0102  
3925 CRYSTAL LK BLVD  
SPURRIER JOSEPH LEO 71 GRAD

SPYKER DANIEL ADRIAN 71 GRAD  
SPYKER JOAN MARIE 71 GRAD 331-5005  
1000 8TH ST SE  
SQUARE BRENDA JOYCE 68 GC 645-3586  
971 DAYTON AVE  
SQUIRES JANYCE IRENE 69 ED 331-1381  
1121 SE 5TH ST  
SRINIVASAGOPALAN RANGA 71 GRAD NEW HOPE  
E E DEPT U OF M  
SRINIVASAN VENKATARAMA 71 GRAD MADURAI

SROGA STANLEY MICHAEL 71 DENT HA1-3411  
12258 CROOKED LAKE BLVD  
SROKA CHERYL ANN 70 CL  
3400 NE HAYES ST  
SROKA CHESTER GEORGE J 69 GC 781-9252  
2914 30TH AVE NE  
ST ONGE GREGORY EDMUN 69 AGFHE  
1563 FULHAM ST  
STABER MICHAEL STEPHAN 68 GC 920-4987  
4528 CASCO AVE SO  
STABLESKI ROBERT LEE 71 CL 588-8825  
4328 FRANCE AVE NO  
STACH G ALEX 71 CL  
BOX 41 ST CLOUD ST  
STACHOWIAK BERNARD JOS 71 CL 771-7609  
992 WILSON  
STACHOWIAK JAMES ALBER 68 GC 735-2182  
2052 E MAGNOLIA AVE  
STANG KENNETH BERNARD 68 CL

STACH THOMAS JAMES 69 BUS 488-9629  
360 W COTTAGE  
STACKEN SHARON VIRGINI 68 ED 338-2989  
1023 UNIVERSITY AVE SE

STADELMAN JAMES ANTHON 71 CL  
STADLER SUSAN DIANE 71 DULTH 728-3486  
2801 E SUPERIOR ST  
STADLER SUSAN MAE 69 AGFHE 888-6945  
8133 E BLOOMINGTON FWY  
STADTHERR CATHERINE AN 68 ED 825-5622  
4716 ALDRICH AVE SO  
STADTHERR MICHAEL DAVI 71 CL 825-5622  
4716 ALDRICH AVE S  
STADY MARYLYN ANN AS ED

STAEBLER JON RAPHAEL 68 ED 724-5173  
3141 22ND AVE SO  
STAEBLER NANCY LEE 69 MEDTC 339-0531  
POWELL HALL  
STAFFON RICHARD CARLVY 71 DULTH 525-2367  
4931 LONDON RD  
STAFFORD ROBERT HOLMES 69 CL 869-0569  
6744 BLOOMINGTON AVE SO  
STAFSTROM SHERI KAY 71 DULTH 624-3215  
4618 W 5 ST  
STAGEBERG MARK NISSI 69 LAW  
409 UNIVERSITY AVE SE  
STAGER BARBARA JEAN 71 DULTH 624-2616  
108 N 59TH AVE W  
STAEHL JAMES EDWARD 68 GC 698-0546  
1532 RANDOLPH AVE  
STAHL FRED ALFRED AS CL 331-5077  
1050 15TH AVE SE  
STAHL JOHN MAGNUS 71 DULTH 724-3723  
1222 E 5 ST  
STAHL ROBERT JOSEPH 69 CL 698-1404  
563 WARWICK  
STAEHLER EMILIE THERESA 70 CL 333-0683  
613 4TH AVE SE  
STAHLY JAMES WILLIAM 70 CL 926-3326  
6708 WOODDALE AVE  
STAHLY JOHN WILSON 70 IT  
307 16TH AVE SE  
STAHN WAYNE EDWARD 69 ED 537-4968  
5400 VIRGINIA  
STAI GERALD ROGER AS CL 890-2539  
13817 THOMAS AVE S  
STAKE PAUL ERIK 68 AGFHE 645-9873  
2384 W LARPEUR AVE  
STALKER DOUGLAS FRANK 69 CL  
625 15TH AVE SE  
STALLCOP SUSAN RUTH 70 CL  
POWELL HALL  
STALLKNECHT GILBERT FR 71 GRAD 645-8990  
1216 FIFIELD  
STALOCH RICHARD MARK 68 GC  
FRONTIER HALL  
STAMNES CONNIE LYNN 69 AGFHE 646-3786  
1502 RAYMOND AVE  
STAMP GORDON LEE 69 GC 473-9568  
RT 3  
STAMPLEY ZACHARY ULYS 69 GC 645-9026  
1020 FULLER  
STANAGE ROBERT H 71 CL 690-1814  
1276 ELEANOR AVE  
STANAWAY NANCY CHELLEW 69 MEDTC 631-2015  
2265 N SNELLING  
STANCER BEVERLEE ANN 68 NURS 331-4869  
519 10TH AVE SE  
STANCHFIELD JEAN ANN 69 ED 537-3200  
4013 61ST AVE N  
STANCIUK PAMELA MARY 68 GC 888-1902  
425 E 99TH ST  
STANCAZKA JUDITH ANN 69 CL 335-0485  
717 UNIVERSITY AVE SE  
STANDEN DONALD LAWRENC 69 CL 336-2404  
2423 PORTLAND  
STANDING CHARLES NICH 70 CL 331-6628  
942 15TH AVE SE  
STANDISH JOHN DAVID 70 CL 926-6895  
4725 WASHBURN SO  
STANDISH MYLES JOSEPH 68 GC

STANDKE ROBERT ALAN 70 CL 474-4576  
1717 UNIVERSITY AVE SE  
STANEK BARBARA ANN 71 CL 781-2462  
2515 4TH ST NE  
STANEK FRANK JOSEPH 68 GC 336-9359  
1011 SE 4TH ST  
STANEK PETER MICHAEL 70 CL ST1-2462  
2515 4TH ST NE  
STANFORD CHARLES LAWDE 68 CL 336-2004  
48 27TH AVE SE  
STANFORD CHERYL JEAN 71 CL 735-3980  
412 WHITE BEAR AVE  
STANFORD WINNIFRED ALE 71 CL  
139 CECIL ST  
STANG EDWARD JAMES 69 IT  
DEERWOOD  
STANG LINDA LEE 68 BUS 645-3535  
1970 N SNELLING DR  
STANG MARK ALBIN 71 CL 938-8844  
133 16TH AVE NO  
STANGE MARGIT KNOWLTON 71 CL  
2018 6TH ST SO  
STANGHELLE DEAN LLOYD 68 AGFHE 645-2005  
2026 BREWSTER APT 14  
STANGHELLE GLORIA JEA 70 CL  
PIONEER HALL  
STANGL ALFRED MICHAEL 69 GC 488-5801  
508 W MINNEHAMA  
STANGL ELIZABETH CLARE 71 DULTH 724-9978  
GRIGGS HALL K217

STANGL JUDITH KATHERIN 68 DENNY 777-1830  
1890 PROSPERITY  
STANGORR DELNAR WALTER 71 CL 423-2830  
509 FAIRVIEW RD  
STANHOPE STEPHEN LEE 69 GC

STANICH JUDITH ALLYN 71 DULTH 834-4924  
430 16TH AVE  
STANISLAW CHARLES PAUL 71 CL 735-3631  
1808 E 3RD  
STANISLAW LEO MARTIN 69 ED 735-3631  
1808 E 3RD ST  
STANISLOWSKI LINDA MAR 70 CL 560-4885  
5046 6 ST NE  
STANIUS BRADLEY GILBER 70 PHARM 645-6923  
2045 KNAPP  
STANIUS RONALD EDWARD 70 DULTH 724-0137  
168 W AUSTIN ST  
STANKO SUSAN MARIE 69 OT 922-2326  
5852 RUSSELL AVE S  
STANKO TIMOTHY MICHAEL 71 CL 922-2326  
5852 RUSSELL SO  
STANLEY ERNEST DALE 69 GC 869-7953  
6701 3RD AVE SO  
STANLEY JAY CADET 70 IT 926-7232  
5236 LOGAN AVE SO  
STANLEY JEFFREY BRUCE 69 IT 788-2411  
3820 MACALASTER DR NE  
STANLEY MARY JUNE 70 CL 771-5224  
776 E ROSE AVE  
STANLEY SHIRLEY SMITH 69 GRAD 332-9509  
1403 4TH ST SE  
STANLEY VICTORIA JEAN 69 ED 331-1446  
1709 COMO SE  
STANLEY WILLIAM FRED 71 MED 331-1587  
631 OAK ST SE  
STANS RICHARD JOHN 68 ED 529-5810  
3427 RUSSELL AVE NO  
STANSBERRY STEVEN NORM 69 ED FE3-9759  
421 CEDAR AVE SO  
STANTHONY JANE JOSEPHI 71 CL 824-1074  
3717 COLFAX AVE SO  
STANTON ANN MARIE 71 CL 633-2296  
SANFORD HALL  
STANTON DAVID JOHN 69 IT 699-7300  
261 WARWICK  
STANTON JAMES RICHARD 69 IT 488-4819  
781 W IOWA  
STANTON JOHN BRIAN 71 CL  
14401 BLUNSDOWN DR  
STANTON JOHN RAYMOND 70 CL UN6-6021  
6445 RUSSELL AVE SO  
STANTON LEAH MARY 71 CL 224-0356  
1316 WACHTLER  
STANTON MARY SUE 68 OT 699-8990  
1872 GRAHAM  
STANTON MAURA FRANCES 68 CL 824-7069  
5504 15TH AVE SO  
STANTON MICHAEL JOSEPH 70 AGFHE

STAPLES JOHN WILLIAM 70 CL 823-3436  
5344 GIRARD AVE SO  
STAPLES SANDRA KAREN 70 CL 225-8591  
330 W PAGE ST  
STAPLETON CONSTANCE MA 70 CL  
1405 5TH ST SE  
STAPLETON MARY FRANCES 68 DENNY 331-0531  
500 ESSEX SE  
STAPP LANNY BRUCE 70 CL 484-8182  
5197 HODGSON RD  
STAR BARRY JOSEPH 71 CL 722-3132  
2540 BLOOM AVE SO  
STAR FRANKLIN EVERET 69 AGFHE PA2-0474  
WI 5228 37TH AVE SO  
STAR JACQUELYN CLAIRE 69 CL 722-0474  
5228 37TH AVE SO  
STAREKOW ROBERT BRUCE 70 CL  
320 7TH ST SE  
STARICH JOHN CHARLES 69 DULTH  
330 16TH AVE E  
STARK BARBARA LUCAS JE 70 AGFHE 560-6050  
5230 3RD ST NE  
STARK CAROL MARIE 70 CL  
SAVAGE  
STARK CATHERINE JUELL 70 CL  
425 UNIV AVE SE  
STARK CATHY ANN 70 CL 633-1720  
1269 12 AVE NW  
STARK CHARLES PAUL 70 CL  
GARFIELD  
STARK DAVID ALAN 71 CL 938-9413  
5924 WALNUT DR  
STARK DONNA MARGARST 69 GRAD 333-9370  
910 ELLIOT AVE SO  
STARK KAREN SUNDEEN 70 AGFHE  
2245 KNAPP ST  
STARK KENNETH REUBEN 68 AGFHE 646-3143  
2245 KNAPP ST  
STARK LINDA ANN 68 GC

STARK MARCELLA LORRAIN 71 GRAD 331-6124  
1219 4TH ST SE  
STARK MARY LORRAINE 69 DULTH 624-7912  
3279 STARK JET RD  
STARK ROGER DEAN 69 BUS 938-9413  
5924 WALNUT DR  
STARK VIRGINIA MARY 68 CL  
STARK WILLIAM BLAIR 70 CL  
TERRITORIAL HALL  
MPL ROCHESTER

STARKE DUANE DALE 6025 QUEBEC AVE NO STARKE EDWARD FRANKLIN	71 CLA MNH 68 ED	537-5677	STEARNS DAVID CLAYTON 2224 17TH AVE SO STEARNS JAMES EDWARD 1904 LAKEVIEW DR	71 CLA MPL ST CLOUD 70 DULTH	724-9002 724-2857	STEENERSON RICHARD MAR 1829 E 7TH ST STEENERSON ROBERT HENR 1829 E 7TH ST	68 DULTH 70 DULTH	724-4660 HOYT LAKES 724-4660 HOYT LAKES			
STARKE WILLIAM JACOB 7 MARINE CT STARKEY ARTHUR DOM 2908 EDGEWOOD AVE STARKEY GRACE ELAINE 2908 EDGEWOOD AVE S STARKS TERRY DON FRONTIER HALL STARKSON ROSS ORVILLE	70 DULTH DULUTH AS CLA SLP ST LOUIS PARK 70 CLA SLP ST LOUIS PARK 70 CLA MPL 70 IT	624-7536 929-8626 929-8626 929-8626	STEARNS JERRY HUBBARD 48 27TH AVE SE STEARNS JOHN SARGENT 5929 YORK AVE SO STEARNS JUDITH ANN COMSTOCK HALL STEARNS RODNEY JAMES 5015 28TH AVE SO STEBBINS KENNETH ERWIN 5224 RICHWOOD DR STEBBINS KENNETH RUBEN 1327 7TH ST SE STEBE JOHN THOMAS 3326 CLEVELAND NE STEBE MARY JEAN 346 KENILWORTH AVE STEBERG MERYNCE NELSON 704 E 2ND ST APT13 STEBLAY RONALD JOSEPH	69 CLA MPL HUTCHINSON GRAD EDN 70 CLA MPL AUSTIN GRAD 69 GC EDN EDINA 68 IT MPL MANKATO 68 GC MPL MINNEAPOLIS 70 DULTH GRAD 70 CLA	332-2085 2085 2085 2085 724-0361 929-4133 331-2441 781-9882 724-5353 469-2032 776-4448	STEENSON DOUGLAS KEITH 5620 BLOOMINGTON AVE SO STEER CLIFFORD JOHN 1950 PINEHURST STEER REGINALD DAVID 1950 PINEHURST AVE STEEVER LINDA LEE 1015 ESSEX ST SE STEEVES JAMES DAVID 1627 CARL ST STEFAN NANCY JEAN 1117 E 31ST ST STEFFEN CHRISTINE ELAI 1884 LINCOLN AVE STEFFENHAGEN TIMOTHY J 1115 5TH ST SE STEFFENS RICHARD DONALD 820 W 65TH ST APT 4 STEFFENS THOMAS LEE	68 GRAD 50 MPL MINNEAPOLIS 70 CLA 70 CLA 69 LAW 69 NURS 70 CLA 68 ED 71 CLA 71 CLA 69 CLA 68 GC 68 CLA	825-4089 MPL MINNEAPOLIS 699-1735 STP ST PAUL 699-1735 STP ST PAUL 331-2304 MPL LENNOX SD 645-5433 LRD NORTH BRANCH 722-4079 MPL HARTFORD WI 698-8523 STP ST PAUL 331-3432 MPL MINNEAPOLIS 866-2031 MPL MINNEAPOLIS 68 CLA			
STARR JACK DARRELL CENTENNIAL HALL STARR LINDA LEE 425 W WINONA STARR MARGERY MAY STARR PATRICK JOSEPH 21 LAWTON STARY STEVEN JOSEPH 983 DIEGO LANE STARZ GERALD KIETH	GRAD MPL MT PROSPECT IL 68 DULTH WINONA 70 DULTH GRAD STP ST PAUL 68 PHARM 71 AGFHE	728-2710 224-9515 224-8209 AGFHE	STEBLETON DANIEL GLEN 1979 E MARYLAND STECH KATHLEEN ANN 1014 MANUEL ST STECKEL HAROLD GEORGE 3733 GETTYSBURG NO STECCKER BRUCE THEODORE 4229 ELLIOT AVE S STECKLER CAROL ANN 1321 HILLSBORO AVE NO STECKMAN DIANA RAYE 704 E 2ND ST APT13 STECKMAN GARY LOUIS	70 CLA STP ST PAUL 70 CLA STP ST PAUL 69 GC MPL 69 BUS MPL FOREST CITY IA 70 CLA GDV GOLDEN VALLEY AS DULTH EVELETH	776-4448 644-8426 545-4349 825-7049 545-5039 727-4498 822-3257 FE1-1839 331-5517 GRAD 784-1691 784-1691 646-9311 545-6025 331-3288 724-7593 724-7593 484-3063 529-2936 699-7752 922-0644 922-7391 373-6320 755-3911 920-6129 771-2038 MPL CARROLLTON OH HIBBING	STEADMAN JOHN PATRICK 615 9TH AVE SE STEDTFELD RICHARD WARR 1051 MONTCLAIR AVE STEDTFELD RUTH LUND EL 1051 MONTCLAIR AVE STEEGE ALAN WALTER DEXTER HALL STEEGE MICHAEL DUANE 2530 FLAG AVE STEEKE CHERI LYNN 425 8TH AVE SE STEELE DAVID SINCLAIR 2705 E 5TH ST STEELE JOHN MILES	70 CLA MPL MINNEAPOLIS GRAD 68 GC STP ST PAUL GRAD 70 AGFHE 71 CLA 69 DULTH 71 DULTH 70 MED STP ST PAUL 71 CLA MPL MINNEAPOLIS 70 CLA MPL ALBERT LEA 71 CLA STP 68 GC 68 LAW MPL OMAHA NB 69 ED MPL MINNEAPOLIS 71 CLA MPL ALBERT LEA 71 CLA CNR COON RAPIDS 69 LAW MPL EDINA 70 CLA STP ST PAUL 70 CLA MPL CARROLLTON OH 68 DULTH HIBBING	789-6080 489-6766 699-3857 646-4790 784-5054 373-7399 331-7328 J49-3091 624-7401 MPL ALBERT LEA AGFHE MPL CROOKSTON DULUTH LAW STP DULUTH GRAD MPL PHOENIXVILLE PA 68 ED STP ST PAUL 70 CLA STP ST PAUL AGFHE BRC BROOKLYN CENTER GRAD MPL UNIONDALE NY 71 CLA MPL PRESTON 68 BUS MARSHALL 68 CLA MPL SAVAGE 70 MORRS 589-4860 MORRIS 71 MORRS 589-3121 PIPESTONE 68 CLA 331-6917 68 BUS 333-2628 MPL ROCHESTER GRAD 488-5719 STP GRAD	STEIN DAVID EARL 8326 13TH AVE SO STEEN DIANE LORRAINE 1403 N CLEVELAND STEEN JENIFER MARIE STEEN JOHN DAVID 1499 LINCOLN AVE STEEN JUDITH CHRISTINE 1115 4TH ST SE STEEN KAREN ELIZABETH 1499 LINCOLN AVE STEEN MARGARET ANN PIONEER COURT STEEN SHARON ELAINE 7601 ELLIOT AVE SO STEEN WILLIAM GEORGE FRONTIER HALL STEENERSON DAVID ALLAN 1829 E 7TH ST STEENERSON MARK ALFRED	71 CLA 68 MED 69 ED 71 CLA 70 CLA 68 DULTH 70 IT 69 GC BLT BLOOMINGTON 70 CLA STP ST PAUL 69 ED 70 CLA STP ST PAUL 70 ED 331-3888 71 CLA 699-4488 STP ST PAUL 70 CLA MPL FERGUS FALLS 71 CLA RHf RICHFIELD 71 CLA MPL FERGUS FALLS 68 DULTH HALSTAD GRAD	STEINERSON RICHARD MAR 1829 E 7TH ST STEENSON DOUGLAS KEITH 5620 BLOOMINGTON AVE SO STEER CLIFFORD JOHN 1950 PINEHURST STEER REGINALD DAVID 1950 PINEHURST AVE STEEVER LINDA LEE 1015 ESSEX ST SE STEEVES JAMES DAVID 1627 CARL ST STEFAN NANCY JEAN 1117 E 31ST ST STEFFEN CHRISTINE ELAI 1884 LINCOLN AVE STEFFENHAGEN TIMOTHY J 1115 5TH ST SE STEFFENS RICHARD DONALD 820 W 65TH ST APT 4 STEFFENS THOMAS LEE STEFFENS TIMOTHY JOHN 3037 MONTEREY AVE STEFFENSEN MERRY KAY 2386 BUFORD AVE STEFFENSON TONYA MERLE 401 11TH AVE SO STEFFES MARYJO MICHELE 2725 28TH ST W STEFFES MICHAEL WILLIA 19 BARTON AVE SE STEFFKE STEPHEN ROY TERRITORIAL HALL STEGEMAN CHARLES ALLAN 525 UNIVERSITY AVE SE STEGEMAN JAMES CARL PIONEER HALL STEGEMAN KAREN HILL LO 525 UNIVERSITY AVE SE STEGEMAN SHARON LEE 6350 VAN BUREN ST NE STEGEMANN DAVID WERNER 380 W LARPENTER STEGER JOSEPH MICHAEL 1928 JULIET AVE STEGMEIR LINDA MARIE 126 WILDWOOD RD STEGNER JEANETTE JONES 730 MONROE ST NE STEMY MARK PAUL 4928 PORTLAND AVE SO STEHN SANDRA ELIZABETH 615 15TH AVE SE STEICHEN PATRICIA JEAN BURNTSIDE HALL 134 STEICHEN PAUL EDWARD 6445 2ND AVE SO STEIDLER RICHARD EARL 5850 4TH ST NE STEIGENGA CHARLES GARY 8725 HARRISON RD STEIGER BRUCE WAYNE STEIGER DAVID EDWARD RR 1 ROGERS MINN STEIGERWALD ANE CORNEL HEREDITH HALL STEIGERWALD CHARLES DA 70 DULTH MOOSE LAKE GRAD MPL NEW YORK NY GRAD STP WAYZATA 71 CLA STP ST PAUL 71 DULTH DULUTH 70 CLA RHf RICHFIELD 69 CLA STP ST PAUL 70 CLA 374-5586 GDV GOLDEN VALLEY 68 BIOC 698-1769 STP ST PAUL 69 DULTH DULUTH 71 MED 698-7967 STP ST PAUL 69 CLA RHf RICHFIELD 69 CLA 926-4664 MPL ST LOUIS PARK 68 ED STP MINNEAPOLIS 71 CLA SLP ST LOUIS PARK GRAD 71 CLA RHf RICHFIELD





STOECKEL SANDRA LEA 69 ED 1420 SIXTH ST SE  
STOECKMAN ROGER EDWARD 69 BUS 3723 INDEPENDENCE AVE  
STOEPEL KENT CHARLES 70 CLA 200 LIBERTY PL  
STOEFFEN MARY ELAINE 71 DULTH  
GRIGGS HALL L216  
STOEGER SUSAN CORINNE 71 CLA  
1829 AGATE ST  
STOERZINGER CYNTHIA JE 68 DENHY  
215 BIRCHER AVE  
STOESSER WILLIAM JOHN 70 CLA  
4038 RALEIGH AVE SO  
STOESZ JANELLE DIANE 70 CLA  
SANFORD HALL  
STOEVE STEPHANIE 71 CLA  
745 19TH AVE N  
STOFFEL ARLENE DELORES 70 AGFHE  
COMSTOCK HALL  
STOFFEL RICHARD CHARLE 69 DENT  
1967 GRAND AVE  
STOFFERAHN DAVID ALLAN 69 CLA  
CENTENNIAL HALL  
STOFFERGEN JANE WILHELM 69 DULTH  
5225 AVONDALE ST  
STOFFREGEN ROBERT ALDE 71 IT  
FRONTIER HALL  
STOH- F-EDE-ECK W&L&A 70 CLA  
103 23RD AVE SO  
STOHR JOHN LEE 70 CLA  
380 FRONTIER  
STOICK DENNIS VINCENT 71 MORRS  
MARIETTA  
STOIKE LINDA LEE 70 CLA  
COMSTOCK HALL  
STOKELY LESLIE LEE 70 DENHY  
PIONEER COURT  
STOKES LEE WAYNE 71 DULTH  
6005 LONDON RD  
STOKES PHILLIP LEROY 69 DULTH  
719 W 16TH AVE E  
STOKKE JOHN CHARLES 69 IT  
CENTENNIAL HALL  
STOKKE JOYCE MARIE 68 LAW  
701 7TH ST SE  
STOLAREK STEPHEN PATRI 71 CLA  
5231 JAMES AVE NO  
STOLARIK MARIAN MARK 69 IT  
612 DELAWARE SE  
STOLEE ALLEN MARK 68 IT  
722-9991  
STOLESON JUAN KARSTEN 68 IT  
3446 42ND AVE SO  
STOLL STEPHEN ANTHONY 68 CLA  
100 W DIAMOND LAKE RD  
STOLLER JOHN CHAPMAN 69 CLA  
4023 AUBURN DRIVE  
STOLLER LARRY MARSHALL 68 CLA  
4530 W 38TH ST  
STOLP IRVIN ALFRED 71 AGFHE  
STOLP RONALD FLOYD 69 GC  
971 E COOK  
STOLPESTAD NANCY TWEET 70 AGFHE  
965 N AVON  
STOLPMAN KATHY ANN 71 MORRS  
CAMDEN HALL  
STOLTENBERG JO ALICE 70 CLA  
16012 DAWN DR  
STOLTMAN THOMAS MICHAEL 69 BUS  
4432 32ND AVE SO  
STOLTS DAVID JOHN 71 AGFHE  
3423 ELLIOT AVE SO  
STOLTZ KATHY JEAN 71 CLA  
915 6TH ST SE  
STOLTZMAN GARY LEE 70 IT  
STONE BRUCE WOODROW 68 CLA  
908 13TH AVE  
STONE CHARLES VENABLE 70 ED  
1619 CARL ST  
STONE DANIEL RILEY 70 ED  
3434 DUPONT NO  
STONE DAVID JAMES 70 IT  
STONE DAVID JAY 70 MED  
1664 VIRGINIA AVE SO  
STONE DENNIS WAYNE 69 CLA  
921 E HAWTHORNE AVE  
STONE DOUGLAS ALLAN 70 CLA  
5257 LOGAN SO  
STONE DOUGLAS ROY 70 IT  
STONE FREDERIC MURRAY 70 MED  
5257 LOGAN AVE SO  
STONE GAYLE VAUGHN 70 CLA  
32 SPRUCE PL  
STONE GERALD ALAN 70 CLA  
1625 UNIVERSITY SE  
STONE HOWARD EUGENE 68 CLA  
921 E HAWTHORNE  
STONE JAMES ROBERT 70 CLA  
4640 31 AVE SO  
STONE JEFFREY PAUL 69 CLA  
3147 CLEVELAND ST NE  
STONE JOHN BRUCE 68 GC  
718 5TH AVE SE  
STONE LESLEY ANN 71 CLA  
11TH & 5 SE  
STONE LYNN GOLDIE 68 ED  
6905 CHICAGO AVE SO  
STONE MEAD MEREDITH 70 CLA  
2505 SILVER LANE NE  
STONE MICHAEL SUMNER 71 CLA  
5054 CHOWEN SO  
STONE PAUL DAVID 68 AGFHE  
STONE PETER STEPHEN 71 MORRS  
1430 ANGELO DR  
STONE RICHARD BYRON 69 CLA  
PINE HALL  
STONE ROBERT ARTHUR 69 CLA  
11535 PALMER RD  
STONE ROBERT FRANK 68 GC  
1824 NEVADA AVE  
STONE ROBERT MORRIS 69 GC  
8715 W 35TH ST  
STONE ROBERT NORMAN 68 DULTH  
453-4230  
BROOKSTON  
STONE SARA SUE 70 CLA  
4219 FREMONT SO  
STONE SHAROL ELIZABETH 69 MEDTC  
923 FULTON ST SE  
STONE SPENCER RALPH 68 AGFHE  
4640 31ST AVE SO  
STONE TERRY LEE 69 DULTH  
618 E BOULEVARD  
STONE THOMAS HARLAN 70 CLA  
3832 PORTLAND AVE SO  
STONEBERG CRAIG STEPHEN 70 CLA  
1202 TYLER  
STONEBERG RAYMOND LEE 70 CLA  
1120 37TH AVE NO  
STONEKING BRADLEY JOE 70 DULTH  
222 W ST MARIE  
STONEKARK WAYNE KENNET 69 DULTH  
4044 HWY 194  
STONER LYNNE RAE 70 CLA  
STONER MARCUS DANIEL 69 IT  
CENTENNIAL HALL  
STONER ROBERT ALLAN 71 MORRS  
548 E 5TH ST  
STONESTRON MARILYN MAE 68 ED  
2301 EMERSON N  
STONGE PATRICIA LOUISE 69 CLA  
627 19TH AVE SO  
STOETS CAROL ELIZABETH 69 ED  
GENETICS DEPT U OF MINN  
STORCH LINDA MARIE 69 ED  
2326 CLEVELAND ST NE  
STORDAHL RONALD ARTHUR 70 LAW  
1420 CENTENNIAL DR  
STOREY LOY DOUGLAS 69 CLA  
2031 KNAPP  
STOREY NANCY ANNE 69 CLA  
839 OSCEOLA AVE  
STOREY SUSAN JANE 71 DULTH  
BURNSIDE HALL 186  
STORHAUG GARY WAYNE 70 CLA  
988 NO OXFORD ST  
STORHOFF ALLEN MARTIN 69 DULTH  
LANESBORO  
STORHOLM JAMES RICHARD 68 BUS  
4426 41ST AVE SO  
STORIE KENNETH JOSEPH 70 CLA  
TERRITORIAL HALL  
STORKE JOHN KENNETH 69 GC  
RT 3 BOX 79  
STORKSON KENNETH CLARE 70 AGFHE  
5014 NO 6TH  
STORLAND JAMES IRVIN 70 AGFHE  
RT 1  
STORLIE ERIK FRASER 70 AGFHE  
1924 DREW  
STORLIE JANETTE LYNN 71 DULTH  
GRIGGS HALL L214  
STORM DONALD LEROY 68 DENT  
1350 7TH ST NW  
STORM JEAN FRANCES 68 CLA  
3310 EMERSON AVE NO  
STORM RONALD ALFRED 71 CLA  
FRONTIER HALL  
STORMS DANIEL LEE 71 CLA  
223 NO BYRONDALE  
STORMS JOHN SANFORD 69 GC  
133 E KINGSTON  
STORMS SALLY ELEANORE 70 DULTH  
501 W BLVD  
STORVICK SYLVIA WISENE 70 DULTH  
4812 12TH AVE S  
STORY JOHN ELBRIDGE 69 CLA  
RT 2 BOX 17  
STOTESBERY DAVID PATRI 69 MORRS  
704 E 7TH ST  
STOTESBERY KAY LOUISE 70 MORRS  
748-7173  
GRACEVILLE  
724-2846  
MPL MINNEAPOLIS  
781-9607  
MPL MINNEAPOLIS  
331-8726  
MPL MINNEAPOLIS  
MPL WHITE BEAR LAKE  
869-2925  
RHIF RICHFIELD  
788-1346  
STA ST ANTHONY  
926-6087  
MPL MINNEAPOLIS  
AGFHE  
588-3209  
GDV GOLDEN VALLEY  
589-3203  
ST PAUL  
888-7452  
BLT BLOOMINGTON  
545-2914  
SLP ST LOUIS PARK  
935-0732  
SLP ST LOUIS PARK  
GRAD  
453-4230  
704-3237  
MPL ALEXANDRIA  
331-6788  
SAMYER  
724-2846  
MPL MINNEAPOLIS  
722-7520  
INTERNAT FALLS  
822-1483  
MPL ABINGTON PA  
437-5518  
HST HASTINGS  
529-2882  
MPL MINNEAPOLIS  
GRAD  
724-8270  
DULUTH  
729-7821  
DULUTH  
70 CLA  
69 IT  
MPL MORRIS  
589-3165  
MORRIS  
7083  
7083  
MPL MINNEAPOLIS  
338-0044  
MPL PEQUOT LAKES  
647-3949  
789-2041  
MPL MINNEAPOLIS  
633-0632  
ROV THF RIVER FALLS  
644-3944  
70 LAW  
STP JEFFERS  
225-8805  
69 CLA  
STP ST PAUL  
724-9992  
ST PAUL  
489-9188  
STP ST PAUL  
69 DULTH  
LANESBORO  
722-1865  
MPL MINNEAPOLIS  
70 CLA  
MPL MINNEAPOLIS  
472-1660  
MND MOUND  
521-3714  
GRAD  
MPL SPOKANE WA  
70 AGFHE  
ROS ROSEMOUNT  
746-5147  
GRAD  
MPL MINNEAPOLIS  
724-9950  
71 DULTH  
MINNEAPOLIS  
633-8216  
68 DENT  
NWB ORTONVILLE  
521-9379  
68 CLA  
MPL MINNEAPOLIS  
429-1625  
71 CLA  
MTB WHITE BEAR LAKE  
473-6748  
71 CLA  
WAY WAYZATA  
488-3430  
69 GC  
MPW MAPLEWOOD  
722-0015  
70 DULTH  
DULUTH  
705-7730  
GRAD  
MPL  
474-6978  
69 CLA  
EXC EXCELSIOR  
589-4833  
69 MORRS  
GRACEVILLE  
748-7173  
70 MORRS  
GRACEVILLE  
71 MORRS  
589-2921  
GRACEVILLE  
777-7034  
MPW MAPLEWOOD  
69 ED  
331-7303  
MPL DEGRAF  
70 DULTH  
724-0444  
ASKOV  
GRAD  
MPL ST PETER  
788-8700  
70 CLA  
CLH COLUMBIA HTS  
824-8736  
69 CLA  
MPL MINNEAPOLIS  
331-4232  
68 PH  
MPL MAUVIKA OK  
331-6100  
68 CLA  
MPL BAYPORT  
222-3830  
68 CLA  
WSP WEST ST PAUL  
331-1507  
70 CLA  
RHIF RICHFIELD  
644-5613  
GRAD  
FLH SPOKANE WA  
545-6682  
70 CLA  
GDV GOLDEN VALLEY  
727-6135  
69 DULTH  
DULUTH  
71 CLA  
MPL WHITE BEAR LAKE  
645-1745  
71 CLA  
FLH FALCON HEIGHTS  
645-1745  
AS LA  
FLH  
AS ED  
70 CLA  
938-8203  
MPL MINNETONKA  
252-2611  
70 CLA  
MPL ST CLOUD  
GRAD  
71 CLA  
646-2049  
71 CLA  
FLH FALCON HEIGHTS  
929-8127  
70 CLA  
SLP ST LOUIS PARK  
823-2558  
70 CLA  
MPL MINNEAPOLIS  
869-2512  
69 GC  
MPL MINNEAPOLIS  
699-3260  
71 AGFHE  
STP ST PAUL  
645-3292  
69 ED  
STP ST PAUL  
823-5994  
68 CLA  
MPL MINNEAPOLIS  
71 CLA  
MPL MINNEAPOLIS  
71 DULTH  
CLM CLM  
GRAND MARAIS  
944-1640  
71 DULTH  
GRAD  
333-2908  
BLT  
GRAD  
MPL  
71 CLA  
MPL MINNETONKA  
633-1361  
GRAD  
STP  
68 AGFHE  
GRAD  
777-5391  
STP OSNABROCK ND  
70 CLA  
823-6468  
MPL MINNEAPOLIS  
938-3377  
70 CLA  
SLP ST LOUIS PARK  
331-2907  
MPL CLOQUET  
69 GC  
935-1833  
SLP ST LOUIS PARK  
377-4182  
70 CLA  
MPL DECORAH IA  
823-3002  
68 ED  
MPL MINNEAPOLIS  
544-5995  
71 CLA  
PLY PLYMOUTH  
525-3128  
69 DULTH  
DULUTH  
71 IT  
544-4080  
NWH NEW HOPE  
331-3653  
69 BIOSC  
MPL MILAN  
525-5856  
71 DULTH  
DULUTH  
GRAD  
ROV  
332-2085  
69 IT  
MPL MONTEVIDEO  
GRAD  
68 AGFHE  
869-3662  
STP RICHFIELD  
795-2420  
70 MORRS  
CYRUS  
GRAD  
70 AGFHE  
544-4080  
NWH NEW HOPE  
68 PT  
MPL CLOQUET



STRAND VIRGINIA LOUISE 70 CLA COMSTOCK HALL STRANDBERG DIANE CLAIR 68 ED 2801 42ND AVE S STRANDBERG GALE LERDY 70 CLA 3901 FLORIDA AVE NO STRANDBERG GREGORY THO 71 CLA 2768 NO HELEN ST STRANDBERG JOHN P NICH STRANDBERG ROBERT STUA 68 IT STRANDBERG SUSAN LYNET 70 CLA 3407 BRUNSWICK STRANDE NORMAN WILLIAM 68 GC 3017 HARDING ST NE STRANDNESS MARTIN JAM 71 MED 317 UNION ST SE STRANOUQUIST HAROLD ALB 71 CLA 982 W MONTANA AVE STRANE STAR FLOWERS 70 AGFHE 1529 GRANTHAM STRANG GERALD ALAN STRANGE ROBERT JAMES 1270 GIBBS ST STRANGE STEPHEN GORDON 68 IT 1000 18TH AVE SE STRANGE WINIFRED 416 11TH AVE SE STRANGIS GEORGENE 71 CLA 3501 BUCHANAN ST NE STRANGIS JOEL STEPHEN 70 CLA 4532 ZENITH AVE STRANSKY JOE ROBERT STRANSKY THOMAS JOHN 71 CLA 4651 CEDAR AVE SO STRAPP MICHAEL FRANCIS 69 CLA 2020 STANFORD STRASFOGEL ANDREW WIG 71 CLA 2019 PORTLAND AVE S STRASSBERGER JEANNE DO 70 CLA SANFORD HALL STRASSER WALTER 1023 E 8TH ST STRATFORD MICHAEL CHRI STRAUB CONRAD PAUL JR 69 CLA 2330 CHALET DR STRAUCH LOUIS OTTO 68 ED 17305 9TH AVE NO STRAUCHLER IRVING DAVI 71 CLA 2044 W BROADWAY NO STRAUSS JANET LYNN 71 DULTH 1017 N 19 AVE E STRAUSS PEARL GAYLE 70 CLA 9108 W 22ND ST STRAUSS ROBERTA SUSAN 71 CLA 7333 STEVENS SO STRAVINO VINCENT D STRAW THOMAS EUGENE STRECKER DONALD WALTER 409 UNIV AVE SE STRECKER JUDITH TODD A 70 CLA 2618 31ST AVE SO STRECKER TERRY WALTER 69 ED 2618 31ST AVE SO STRED BARBARA LAURA 70 AGFHE 2067 CARTER AVE STRED DOUGLAS DONALD 68 IT 1332 7TH ST NW STRED MICHAEL RICHARD 71 MORRS CLAYTON A GAY HALL STREGE PHILIP LUVERNE 70 IT 6715 W RIVER RD NO STREGE WAYNE BERNARD 71 CLA 6715 W RIVER RD NO STREIFF CHARLES JOHN 68 AGFHE 1103 5TH ST SE STREIFF WYNN SUSAN 69 CLA 1026 5 ST SE STREIT RICHARD JOHN 3405 NO CLEVELAND STREITMAN SANDRA RUTH 68 CLA 9031 W 34TH ST STREITZ WILLIAM LEONAR 68 MED STREM JACQUELINE 1305 PINEHURST STREMEL ELBERT MYRON 70 AGFHE 1230 W 7TH ST STRENGE DENNIS LEROY STREUFERT DONALD EARL 442 4TH ST NE STREWLER BARBARA MOFFA 71 CLA SANFORD HALL STRICKER RUSSELL DEAN 70 CLA 2104 22ND AVE SO STRICKLEN KENNETH ALLE 71 CLA 4213 GLENRIDGE RD STRICKLEN RAYMOND STRICKLER JEFFREY HARO 69 MED 2401 W 90TH ST STRICKLER JOHN CHARLES 69 CLA 706 SIXTH AVE SE	STRICKLER KATHLEEN ANN 71 CLA 6732 VINCENT SO STRIETZ PATRICIA RYAN 2505 E 1ST ST STRIKE HARLOW DEAN 68 PHARM 4036 37 AV N APT 101 STRIKER MYRON HARVEY 69 CLA 3526 COLFAX SO STRIKER RONALD KEITH 69 GC 9400 W FRANKLIN STRINGER GENE CHESTER 71 VET M 725 1/2 NO SNEILING AVE STRITTMATTER JOHN LEON 70 CLA 1515 UNIVERSITY AVE SE STROBECK JEROME GRIFFI 69 IT STROBEL DIAN LYN 70 CLA 5100 ROBERTS PLACE STROBL GREG FRED 16030 9TH AVE N STROEBEL GARY JOHN 2916 36TH AVE SO STROHFUS NORMAN CARL 1000 BAYLESS AVE STROHKIRCH JOHN ALLENR 71 AGFHE 632 ASBURY STROHMAYER SANDRA ANN 71 CLA 1911 E MINNEHAMA AVE STROHMEIER GARY WARNER 71 MORRS PINE HALL STROHN RUTHANNE DOROTH 71 CLA PIONEER HALL STROHOFFER ZOLTAN 3900 SHERIDAN AVE SO STROHSCHIEIN SUSAN HELE 68 NURS 625 ERIE ST SE STROKIRK JANE LEE 68 CLA 2164 ROBLYN AVE STROM CAROL MARIE 69 PT 1025 6TH ST SE STROM ERIK GORDON 70 MED 631 OAK ST SE STROM GARY GORDON 70 MED STROM JAMES CHRISTOPHE 70 MED STROM PAULINE CLARA LA 68 ED 4944 17TH AVE SO STROM ROBERT RALPH 4815 ONEIDA STROM RONALD EUGENE 68 CLA 3933 16TH AVE SO STROM SUSAN LEE 70 DULTH 206 1ST ST STROMBERG MARY JO 70 CLA COMSTOCK HALL STROMBERG ROBERT GORDO 71 DENT PIONEER HALL STROMGREN LINDA KAREN 71 DULTH 3405 CARLTON ST STROMGREN STEPHEN CURT 71 CLA 31 9TH AVE NW STROMLEY GARY ALLEN 71 AGFHE STROME CHRISTINE BROW 70 CLA 4805 E SUNNYSLOPE RD STROME ELIZABETH JEAN 69 CLA 1026 5TH ST SE STROME NEIL BARRETT 71 IT 101 WILKIN ST STROMMER BERNICE HELEN 71 DENT 1571 RICE ST STROMMER JEAN THERESA 68 CLA 1571 RICE ST STROMQUIST JOHN WILLIA 71 DULTH 5133 GLENWOOD STROMQUIST JON GEORGE 69 IT STROMQUIST KENNETH JAM 68 BUS 521 12TH AVE SE STROMQUIST PAUL BOYD 70 DULTH 4730 DODGE ST STROMWALL MARK HAROLD 68 CLA LAKESIDE RD STRONG GREGORY STEPHEN STRONG INA JEANNE STRONG SARAH JANE STRONG STEVEN ROGER STRONG TERRY LEE CENTENNIAL HALL STRONG WILLIS EDWARD 69 GC ROUTE 1 BOX 477 STROODMAN DENNIS JAMES 71 CLA 3962 COON RAPIDS BLVD STROODMAN LARRY DALE 69 BUS 3962 COON RAPIDS BLVD STROTHER PAUL BARRETT 71 CLA 4607 WOODDALE STROUD MARY LOEL 2067 CARTER AVE STRUB CYNTHIA ANN 323 10TH AVE SE STRUB JUDITH MARIE 946 ARKWRIGHT STRUBLE MARY JO 71 CLA 5617 DUPONT AVE SO	STRUPPEN CATHERINE LOU 68 GC STRUCK LAURENCE LOUIS 70 CLA 1282 STANFORD AVE STRUCK LYDELL KEITH 68 AGFHE 1485 N CLEVELAND STRUCK RICHARD CHARLES 69 CLA 3302 MANOR DR STRUCK VERA VICTORIA 71 CLA 6521 TINGDALE AVE STRUCK VIRGINIA GENE 69 CLA 1132 EARL ST STRUKEL ROBERT JOSEPH 71 DULTH 5020 PEABODY ST STRUM CURTIS ALLEN 70 DULTH 1915 E 4TH ST STRUPP DEAN ROBERT 70 CLA 5113 RICHMOND DR STRUSINSKI ROBERT PATR 70 CLA 1172 E COOK STRUTZ DAVID WILLIAM 2032 STRATFORD AVE STRUVE BRADLEY WILLIAM 68 GC 1676 SCHEFFER AVE STRUVE JAMES KENNETH 70 MED 317 UNION ST SE STRUVE WILLIAM ALLEN 68 CLA 1011 PIONEER HALL STRUXNESS MARTHA JANE 70 CLA 1215 8TH ST SE STS AUVER CHARLES LOUIS 71 IT RT 1025 STS AUVER DENNIS STANLE 70 CLA 1211 E MARYLAND STS AUVER JOHN DARRYEL 69 DULTH 2132 JEFFERSON STS AUVER THERESA MAY 69 ED 928 YORK AVE STUART DAVID DIXON 69 MED 2311 PLEASANT AVE SO STUART NELSON 3 68 CLA 1725 UNIV AVE SE STUART PAULA KATHLEEN 70 CLA 1080 BOWDWIN STUART THOMAS LEE 68 CLA PIONEER HALL STUBBS DAVID ROGER 70 CLA STUBBS MARCIA BEVERLY 70 CLA RT 1 BOX 503 STUBBS NANCY LORRAINE 68 CLA 2013 SO 2ND ST STUBBS TIMOTHY WOLFE 71 CLA 5624 15TH AVE SE STUBE THOMAS LEYTON 70 CLA RT 4 BOX 906 STUBEE DENNIS LARS 71 CLA 8427 12TH AVE SO STUBER CAROL JUNE 71 IT COMSTOCK HALL STUBSTAD JOHN ANDERSON 71 IT 1799 SCHEFFER AVE STUBSTAD SANDRA ANN 71 IT SANFORD HALL STUCKE ALBERT LOUIS 69 MORRS 603 11TH ST NO STUCKI DANIEL DALE 70 CLA 427 19TH AVE S STUDANSKI GERALDINE KA 68 AGFHE 2626 COMO AVE SE STUDANSKI TERRY RAY 70 CLA R 2 STUDE RONALD HENRY 68 AGFHE 461 W LYNNHURST AVE STUDELSKA DANIEL R JR 70 MORRS LA GRANDE HOTEL STUDELSKA JOAN ANNE 71 CLA 4558 COLFAX NO STUDER ELIZABETH JANE 68 CLA 1012 5TH ST SE STUDER IRENE ELIZABETH 68 ED 327 14TH AVE SE STUDER JANANN LEE 71 AGFHE 8800 GIRARD AVE SO STUDER RICHARD JULIAN 68 CLA 124 E ARION ST STUDINER CHARLES JOHN 70 CLA 1885 E 7TH STUERMER JEFFREY FRANK 70 CLA 10905 RIVER CT STUERZL JANICE PEDERSE 70 CLA 2825 N PASCAL STUETZER MAX 68 GC 1401 PARK AVE SO STUEVE JOSEPH GEORGE 68 GC STUEVEN RONALD RAY 71 MORRS BLAKELY HALL STUEWER HELGA 71 MORRS 2501 GIRARD AVE SO STUHLFAUT MARK WILSON 71 CLA STUKEL SONJA JEAN 70 CLA 327 6TH AVE SE STULBERG MICHAEL MARK 68 GC 1415 MELROSE AVE STULC DONALD ARTHUR 68 GC 1601 WOODLAND AVE STULTS CORALYN ANNE 71 CLA 5011 NEWTON AVE SO
--	--	--



SUDMALA RICHARD VICTOR 71 DULTH 722-4500  
2821 MORRIS THOMAS DULUTH  
SUDMI LAWRENCE ROBERT 69 DULTH 724-7001  
2232 JEFFERSON DULUTH  
SUOMINEN KENNETH ALAN 71 DULTH 879-5177  
RT 3 BOX 174 CLOQUET

SUPALLA RAYMOND JOSEPH 69 AGFHE 484-8645  
218 W CO RD B 2 ROY MINNESOTA LAKE  
SUPALLA WILLIAM JOHN 70 PHARM  
800 UNIVERSITY AVE SE MPL NEW RICHLAND  
SUPAN LINDA LEE 71 CLA 784-6760  
8949 JEFFERSON ST NE MPL MINNEAPOLIS  
SUPEL MARY ROOT ALICE GRAD

SUPEL THOMAS MARTIN GRAD

SUPER DIXIE LEE 71 CLA 788-3135  
4221 FIFTH ST NE CLH COLUMBIA HTS  
SUPER JOHN CHARLES 70 CLA 788-2643  
954 42ND AVE NE CLH COLUMBIA HTS  
SUPLEE CURTIS BURTON GRAD  
2254 8TH AVE SE MPL E GREENBUSH NY  
SUPLICK L CARD GRAD KE7-6736  
3916 HAMPSHIRE AVE NO CYT CRYSTAL  
SUPLICK STANLEY MICHAEL GRAD KE7-6736  
3916 HAMPSHIRE NO ROB ROBBINSDALE  
SUPPER DAVID JEROME 70 AGFHE  
1459 NO CLEVELAND AVE STP CLARISSA  
SUPPES DONALD JAMES 68 IT 644-3971  
1395 PORTLAND STP MOUNDS VIEW  
SUPPLEE JOSEPH EDWARD 70 CLA 866-3284  
216 EAST 60TH ST MPL MINNEAPOLIS  
SURFACE CHARLES EDWARD 70 DENT 331-1324  
814 ESSEX SE MPL ST VINCENT  
SURFACE RICHARD CHARLE 70 IT 331-3749  
510 12TH AVE SE MPL LEXINGTON MA  
SURGE FRANCIS PAUL AS CLA 776-8012  
2055 BRADLEY ST STP  
SURIS ANDRES GRAD

SURIS MARIA JULIA 69 CLA 644-6749  
2280 PRISCILLA ST ST ANTHONY  
SURMA SUSAN ANNE 71 CLA 788-0421  
1055 LINCOLN TER CLH COLUMBIA HTS  
SUSAG DAVID MICHAEL 71 CLA  
TERRITORIAL HALL MPL ALEXANDRIA  
SUSLAK DIANA POCH GRAD 333-3646  
628 UNIV AVE SE MPL  
SUSLAK KENNETH V GRAD

SUSSKIND RONALD GRAD

SUSSMAN DAVID ALLEN 70 IT 545-5233  
2349 TEXAS AVE SO SLP ST LOUIS PARK  
SUSSMAN DEBORAH JUNE 69 CLA

SUSSMAN MARILYN BLACKE GRAD 922-0359  
3840 XERXES S MPL  
SUTER CAROL ANNE 70 CLA 331-2933  
609 OAK ST SE MPL DEGRAF  
SUTER PHILIP SAMUEL 70 CLA 331-9831  
406 11TH AVE SE MPL MONTEVIDEO  
SUTHERLAND BEVERLY MEN 68 ED 377-3155  
1203 OLSON HWY MPL  
SUTHERLAND BEVERLY SHA GRAD 392-8337  
1109 N 18TH ST RTOR WI  
SUTHERLAND JOHN NEIL GRAD

SUTHERLAND LONNIE LEA 69 DENHY 331-3039  
3109 4TH ST SE MPL HALLOCK  
SUTHERLAND STEPHEN DEA 68 CLA 644-7977  
2067 TEMPLE CT STP ST PAUL  
SUTHERLAND WILLIAM THO 69 IT 926-7864  
4837 SHERIDAN AVE SO MPL MINNEAPOLIS  
SUTICH NICK 70 DULTH 727-2287  
1915 E 4TH ST MOUNTAIN IRON  
SUTIN CECILIA 69 CLA 929-0775  
2807 KENWOOD AVE S SLP ST LOUIS PARK  
SUTTLES SYDNEY LEE 69 CLA

SUTTON DANIEL JOHN 70 DULTH 724-7119  
102 W ANOKA ST DULUTH  
SUTTON GLORIA ANN 70 CLA 489-5198  
1581 NO GRIGGS ST STP ST PAUL  
SUTTON KATHLEEN MARY 70 CLA 869-3317  
7001 KNOX SO RHF RICHFIELD  
SUTTON LEE JAMES 68 DULTH  
ST PAUL

SUTTON MICHAEL PHILIP 68 CLA 929-2357  
2840 ALABAMA SLP ST LOUIS PARK  
SUTTON NANCY ANN GRAD 645-6528  
1750 HALVERN ST LRD  
SUTTON NANCY JANE 71 CLA  
5536 HERRITT CIR EDN EDINA  
SUTTON RICHARD DOUGLAS 69 BUS 824-9564  
1101 W 53RD ST SW MPL MINNEAPOLIS  
SUTTON ROBERT MARSHALL 71 CLA 824-9564  
1101 W 53RD ST MPL MINNEAPOLIS  
SUTTON ROBERTA JEAN 70 DULTH 724-0001  
4507 E 3RD ST DULUTH  
SUTTON SUSANN IRENE 69 GC 588-2376  
3131 PARKVIEW BLVD ROB ROBBINSDALE  
SUTTON THOMAS MATTHEW 70 CLA 929-2812  
5536 HERRITT CIR EDN EDINA  
SUZUKI DAVID AKIRA GRAD 331-4232  
708 5TH ST SE MPL OAKLAND CA  
SVALBE AGNARS ADOLFS GRAD 822-9587  
4944 3RD AVE SO MPL DALBO  
SVANG CHARLES EDWIN GRAD 722-1964  
3427 25TH AVE SO MPL RICHFIELD

SVANG LUCY MAE 68 ED 822-5338  
4140 11TH AVE SO MPL MINNEAPOLIS  
SVARE ROBERT JOHN 69 IT  
402 MARSHALL AVE STP ST PAUL  
SVATOS KATHLEEN MARIE 69 DULTH  
115 E ARTAVIA SOUDAN  
SVEEN RICHARD DAVID 68 BUS 822-4255  
5443 CHICAGO AVE SO MPL  
SVENDAMH H MICHAEL 70 CLA 722-2781  
3048 16TH AVE SO MPL MINNEAPOLIS  
SVENDBY JOAN OLIVE 70 AGFHE 781-2573  
2501 LOWRY AVE NE STA BRAHAM  
SVENDSEN ARNULF LOHREN 68 MED 922-4493  
2753 UPTON AVE SO MPL MINNEAPOLIS  
SVENDSEN DANIEL LEE 68 BUS 722-0030  
2730 CEDAR AVE SO MPL MERRIFIELD  
SVENDSEN JAMES THOMAS GRAD 776-9643  
827 MOUND ST STP ST PAUL  
SVENDSEN KATHLEEN ANN 70 AGFHE 645-5147  
2342 COMMONWEALTH STP ST PAUL  
SVENDSEN LAWRENCE ALFR 69 CLA 771-7179  
1848 E ORANGE STP ST PAUL  
SVENDSEN MARGARET ANNE 70 CLA 824-8284  
5412 3RD AVE SO MPL MINNEAPOLIS  
SVENDSEN STEVEN MARTIN 71 AGFHE

SVENPLADSEN LYNN OBERT 70 CLA 920-2436  
5560 QUEEN AVE SO MPL MINNEAPOLIS  
SVENSON CLITHROE DEAN 71 CLA  
SANFORD HALL MPL EXCELSIOR  
SVERCL PAUL VINCENT M 68 IT

SVERDRUP GEORGE MICHAEL 71 IT 881-5946  
1448 E OLD SHAKOPEE CIR BLT BLOOMINGTON  
SVERKERSON LEE CARL 71 CLA 545-8134  
9003 36TH AVE NO NWH NEW HOPE  
SVIGEL JOHN RODNEY 69 DULTH 263-7690  
1702 13TH AVE E CHISHOLM  
SVIHJEL CHARLES E 70 CLA  
217 12TH AVE HOP  
SVOBODA NORMAN ALVIN 69 AGFHE 331-5873  
15 MALCOLM AVE SE MPL NEW PRAGUE  
SVOR KENNETH ROBERT 68 GC FE1-1184  
818 10TH AVE SE MPL BENSON  
SWADDEN SHEILA ANN 68 CLA 545-7201  
1640 VIRGINIA AVE SO SLP ST LOUIS PARK  
SWAGGERT PATRICK JOHN 70 CLA 825-1475  
22 49TH ST MPL MINNEAPOLIS  
SWAIMAN SYBIL ROCHELLE GRAD 545-1836  
2205 QUEBEC AVE SO SLP ST LOUIS PARK  
SWAIN ALBERT MARVIN GRAD  
301 RAVOUX ST STP  
SWAIN HARRY SHELDON GRAD  
3721 CHANDLER DR STA WILLOWDALE  
SWAIN STEPHEN PAUL 70 CLA 331-7931  
515 10TH AVE SE MPL INTERNAT FALLS  
SWAN BONNIE JEAN 71 CLA 869-0818  
6232 3RD AVE SE RHF RICHFIELD  
SWAN CAROL JOY 68 ED 331-3387  
401 11TH AVE SE MPL  
SWAN DALE GUSTAF GRAD  
SWAN JEROLD BRUCE 70 AGFHE

SWAN KATHRYN ANN 71 CLA 224-3080  
20 W IMPERIAL DR MSP WEST ST PAUL  
SWAN PAMELA JUNE 68 PHARM 941-2510  
5100 MEADOWBRIDGE EDM PELICAN RAPIDS  
SWAN TONY JOE 70 CLA  
1423 5TH ST SE MPL  
SWANBERG DAVID ROLAND 68 IT 338-9845  
1308 7TH ST SE MPL BROWERVILLE  
SWANBERG MYRNA JEAN 70 CLA

SWANBERG WILLIAM NELS 68 GC 421-2325  
4020 COON RAPIDS BLVD ANK ANOKA  
SWANBURG DAVID ALLEN 70 IT

SWANDBY JAMES ERNEST 69 CLA 331-5467  
1515 UNIVERSITY AVE SE MPL EDINA  
SWANN CHARLES WILLIAM GRAD  
SWANN SHARLENE BRIGGS GRAD

SWANSICK DAVID THING 69 CLA 426-3480  
1046 GRIFFIN ST MAH MAHTOMEDI  
SWANSON ALAN WESLEY 70 CLA 545-7705  
2510 A LANCASTER LN N PLY PLYMOUTH  
SWANSON ALVIN SEVERIN 69 CLA 781-2451  
3342 FILLMORE NE MPL MINNEAPOLIS  
SWANSON ARCHIE PETER 69 IT 588-5554  
3513 KLYE AVE N CYT ELY  
SWANSON ARLENE TIMMERM 69 CLA 336-1316  
19 1ST ST SO MPL  
SWANSON BARBARA JO 71 DULTH 624-1915  
4112 W 8 ST DULUTH  
SWANSON BERT THEODORE GRAD  
19 HAYS SKYLINE VILLAGE ING TAYLOR ND  
SWANSON BETTY MAE 70 CLA 644-5549  
1398 MIDWAY PKWY STP LAKE ALFRED FL  
SWANSON BRUCE ALBERT 71 DULTH 72-4984  
GRIGGS HALL C118 EDINA  
SWANSON BRUCE HARRY GRAD 330-8611  
615 15 AVE SE MPL MILACA  
SWANSON CAROL ANN 70 CLA 866-9604  
POWELL HALL MPL RICHFIELD  
SWANSON CAROL JOY 70 CLA 823-8057  
5245 10TH AVE MPL MINNEAPOLIS  
SWANSON CHARLES DWIGHT 71 IT  
622 GRAND AVE STP TRACY

SWANSON CHARLES JOHN 68 DULTH 727-2993  
4115 CHAMBERSBURG AVE DULUTH  
SWANSON CHARLES LOREN 69 MORRS  
530 E 4TH MORRIS  
SWANSON CHARLES ROGER 71 CLA 869-4846  
6717 HARRIET AVE SO RHF RICHFIELD  
SWANSON CHARLES WILLAR GRAD

SWANSON CHRISTINE GILB 70 ED  
1811 SEE AVE SO MPL HOPKINS  
SWANSON CLIFFORD LEROY 68 CLA 331-1326  
1725 UNIVERSITY SE MPL MINNEAPOLIS  
SWANSON CRAIG GORDON 68 GC

SWANSON CRAIG JOHN 69 DULTH 624-1915  
4112 W 8TH ST DULUTH  
SWANSON CRAIG REYNOLD 70 CLA 938-4401  
249 INTERLACHEN RD HOP HOPKINS  
SWANSON CYNTHIA JANE 69 CLA 869-4846  
6712 HARRIET AVE SO RHF RICHFIELD  
SWANSON DALE GORDON 69 CLA 645-2902  
1440 RAYMOND AVE STP ST PAUL  
SWANSON DALE WILLIAM 69 CLA

SWANSON DARRELL CHARLE 71 DULTH 256-6175  
RT 1 CARLTON  
SWANSON DAVID BYRON 71 IT

SWANSON DAWN ELAINE 69 DULTH 626-2463  
1055 85TH AVE W DULUTH  
SWANSON DEAN EDWARD 71 CLA 645-2902  
1440 RAYMOND STP ST PAUL  
SWANSON DEL WAYNE 70 CLA  
PIONEER HALL MPL PINE CITY  
SWANSON DENISE LILLIAN 71 CLA 722-5546  
3337 16TH AVE SO MPL MINNEAPOLIS  
SWANSON DENNIS ARTHUR 68 DULTH 727-2817  
4005 HERMANTOWN RD DULUTH  
SWANSON DENNIS L 68 AGFHE

SWANSON DENNIS WILLIAM 68 GC WA2-1448  
5813 ZENITH AVE SO EDN EDINA  
SWANSON DONALD LEE 70 CLA 334-8253  
FARIBAULT  
SWANSON DONNA MAE 70 CLA 771-0646  
683 E COTTAGE STP ST PAUL  
SWANSON DORIS ELIZABET 70 CLA  
BALATON

SWANSON DOUGLAS EUGENE 71 CLA 722-9646  
3607 LONGFELLOW AVE SO MPL MINNEAPOLIS  
SWANSON DOUGLAS KEITH 69 ED 777-6017  
2296 E NAVAJA RD NSP NORTH ST PAUL  
SWANSON DOUGLAS MERLYN 68 CLA 646-5585  
1988 BREWSTER ST STP CANNON FALLS  
SWANSON EMMETT ARTHUR 68 IT 331-7931  
515 10TH AVE SE MPL  
SWANSON EUGENE PAUL 70 AGFHE  
415B E BAILLEY HALL STP TRIMONT  
SWANSON GARY ARNOLD 69 BIOCQ 771-7774  
2052 CLEAR AVE STP ST PAUL  
SWANSON GARY LEE 68 CLA 935-1643  
416 GRIFFIT ST HOP HOPKINS  
SWANSON GAYLE MARY 71 CLA 824-8939  
3944 13TH AVE SO MPL MINNEAPOLIS  
SWANSON GEORGE MAXWELL 68 CLA 822-9464  
4901 1ST AVE SO MPL MINNEAPOLIS  
SWANSON GLORIA JUNE 70 CLA 776-1240  
1805 E HANTHORNE STP ST PAUL  
SWANSON GREGORY HERBER 71 CLA 771-3782  
1685 ENGLISH ST STP ST PAUL  
SWANSON GWEN ANNE 69 AGFHE 755-3472  
BAILLEY HALL STP COON RAPIDS  
SWANSON HAROLD FREDERI 68 DULTH 722-0796  
2210 W 3RD ST DULUTH  
SWANSON JAMES ALLEN 70 CLA 789-5445  
2547 UNIVERSITY AVE NE MPL MINNEAPOLIS  
SWANSON JAMES DOUGLAS 70 CLA 938-1653  
5124 SO BLAKE RD EDN EDINA  
SWANSON JAMES LEROY 70 AGFHE 724-0247  
3829 18TH AVE SO MPL RUSSELL  
SWANSON JAMES TIMOTHY 68 DENT 336-3905  
311 11TH AVE SE MPL WILLMAR  
SWANSON JAMIE DEAN 69 VET M 645-2175  
1618 EUSTIS ST STP CUSHING WI  
SWANSON JANALEE 71 CLA 869-2934  
6321 THOMAS AVE SO RHF RICHFIELD  
SWANSON JANET CARROLL AS ED

SWANSON JANET MARIE 71 DULTH 624-7482  
4007 W 4 ST DULUTH  
SWANSON JANET RUTH 69 GC 522-0065  
3334 EMERSON SO MPL MINNEAPOLIS  
SWANSON JEAN PHYLLIS GRAD

SWANSON JEFFREY DONALD GRAD 646-4489  
1824 NO ASBURY ST FLH FALCON HEIGHTS  
SWANSON JO ANN 70 CLA 560-7857  
5032 MADISON ST NE CRP CIRCLE PINES  
SWANSON JOANN CAROLYN 68 ED

SWANSON JOEL ANTHONY 70 MORRS  
RT 3 MORRIS  
SWANSON JOHN CARL GRAD 739-6072  
521 LAMPLIGHT DR STP  
SWANSON JOHN LEONARD 69 GC 777-6018  
1753 BIRMINGHAM MPW MAPLEWOOD  
SWANSON JOHN ROGER 69 AGFHE 588-7828  
3355 REGENT AVE GOV GOLDEN VALLEY  
SWANSON JUDITH KAY 70 CLA 788-6923  
1316 NE 43RD AVE CLH COLUMBIA HTS



SWORSKY EDMOND ANTHONY 69 CLA 560-3774 491 61ST AVE NE SWORSKY FRANCIS PHILIP 70 CLA 560-3774 491 61ST AVE NE SY BENITO CHU GRAD	TAINTER FRANK HUGH GRAD 645-8073 1259 CLEVELAND AVE NO TAIPALE HARVEY JOHN GRAD 644-1606 461 W LYNNHURST TAKAHASHI KATUYUKI GRAD	TANEY JUDITH ANN 70 CLA 226-6852 168 E COOK TANEY PATRICIA ANN 70 CLA 489-0518 62 W GERANIUM AVE TANG GRACE DZCHYANG GRAD 647-3793 MEREDITH HALL TANG NANCY NAINGSHU GRAD	SYCKS GREGORY LEWIS 68 GC T44-4022 5641 DUPONT AVE SO SYDEJKO NANCY ANN 70 NURS 331-7366 1734 COMO AVE SE SYFKO MICHAEL THOMAS 70 IT	TAKAICHI CAROL EILEEN 69 ED COMSTOCK HALL TAKEDA AYAKO 1119 6TH ST SE TAKEICHI HIDEO CENTENNIAL HALL TAKEMOTO ANNE HIROKO 70 CLA 888-9312 9924 11TH AVE SO TAKEMOTO JAMES HIDEO 71 IT 888-9312 9924 11TH AVE SO TAKEUCHI RICHARD K BAILEY HALL TAKLE ANNE KATHLEEN 70 CLA 227-2877 938 LOMBARD AVE TAKUMI GERALD WAYNE 68 CLA 419 ERIE ST SE TAL JACOB 711 MORGAN NO TAL RACHEL ALKONY 69 ED	TANGHE JAN HENRY GRAD	TANGHE MARY FALENCZYKO 70 MED 698-4465 MEDICAL SCHMOOL TANGLIN DAVID JEROME 71 CLA STANCHFIELD TANI PAUL MASAO 68 CLA 331-1326 1725 UNIVERSITY AVE SE TANICK LENORE 71 CLA 521-9503 2601 GOLDEN VALLEY RD TANICK MARSHALL HOWARD 69 CLA 544-5619 2311 SUMTER SO TANICK PEGGY SUE 70 CLA 521-9503 2601 GOLDEN VALLEY RD TANICK SHARON LEE 70 CLA 529-8046 2010 THOMAS NO TANK ALLEN RUDOLPH GRAD	SYKES RICHARD EUGENE 71 MORRS 303 E 5TH SYKES THOMAS LEE 71 DULTH 525-3805 4906 GLENDALE ST SYKORA JAMES HARRY 69 IT 776-4420 1746 E 4TH SYLTE CAROLYN JOY 69 GC 784-4935 7471 KNOLLWOOD DR SYLTE DAVID MARLOW 70 CLA 335-4872 711 26TH AVE SO SYLVESTER PATRICIA MAR 70 CLA SANFORD TOWERS SYLVESTER THOMAS ANTHO 71 DULTH 728-2642 145 E TOLEDO ST SYMINGTON RUSSELL LLOYD 70 IT	TAKAICHI CAROL EILEEN 69 ED COMSTOCK HALL TAKEDA AYAKO 1119 6TH ST SE TAKEICHI HIDEO CENTENNIAL HALL TAKEMOTO ANNE HIROKO 70 CLA 888-9312 9924 11TH AVE SO TAKEMOTO JAMES HIDEO 71 IT 888-9312 9924 11TH AVE SO TAKEUCHI RICHARD K BAILEY HALL TAKLE ANNE KATHLEEN 70 CLA 227-2877 938 LOMBARD AVE TAKUMI GERALD WAYNE 68 CLA 419 ERIE ST SE TAL JACOB 711 MORGAN NO TAL RACHEL ALKONY 69 ED	TANGHE JAN HENRY GRAD	TANGHE MARY FALENCZYKO 70 MED 698-4465 MEDICAL SCHMOOL TANGLIN DAVID JEROME 71 CLA STANCHFIELD TANI PAUL MASAO 68 CLA 331-1326 1725 UNIVERSITY AVE SE TANICK LENORE 71 CLA 521-9503 2601 GOLDEN VALLEY RD TANICK MARSHALL HOWARD 69 CLA 544-5619 2311 SUMTER SO TANICK PEGGY SUE 70 CLA 521-9503 2601 GOLDEN VALLEY RD TANICK SHARON LEE 70 CLA 529-8046 2010 THOMAS NO TANK ALLEN RUDOLPH GRAD	SYMONS GREGORY JAY 70 CLA HOP HOPKINS 102 12TH AVE SO SYMONS LESLIE ALLISON 71 AGFHE	TALABI SULAIMAN OWOLAB GRAD	TALAJIA KOKILA GRAD	TALARICO MARY LEE 71 DULTH 624-0696 123 S 58TH AVE W TALBERG CAROLE ANN 69 CLA 331-3795 520 12TH AVE SE TALBOT BETSY LEAHY 68 ED 699-3073 1746 HARTFORD TALBOT DANIEL HAASE 68 CLA 1327 7TH ST SE TALBOT DAVID REGINALD 71 DULTH 624-3079 8522 VINLAND ST TALERICO DANIEL JOSEPH 69 DULTH 624-9306 314 N 75TH AVE W TALERICO JEFFREY JAMES 70 DULTH 626-1120 8715 BEVERLY ST TALIAN ROBERT JOSEPH 68 MORSC 332-6566 1825 CHICAGO AVE TALLAKSON JOANNE KAY 69 GC 377-1469 408 SHERIDAN AVE SO TALLEN DAVID CHARLES 69 CLA 488-2131 848 W SANDHURST DR TALLEN STEVEN MARK 71 CLA 488-8794 848 W SANDHURST DR TALLEY ARENA ANNETTE 70 CLA 451-2731 508 DAVIS LN TALLEY JAMES DAYTON 70 CLA 600 4TH ST SE TALLEY JAMES DONALD 68 CLA W 107 CENTENNIAL HALL TALLEY LYLE DUANE 69 AGFHE WINNEBAGO	TANER ROY JAMES 68 CLA 331-5986 1815 UNIV AVE SE TANNER SHARON JEAN 71 DULTH 525-2626 4531 DODGE ST TANNER STEVEN JOHN 69 CLA 336-2741 407 7TH ST SE TANNING LARRY GREGG 69 BUS 429-0344 4455 OTTER LAKE RD TANSEY MARK CHRISTOPHE 70 CLA 699-7686 1325 PINENURST TANSEY ROBERT JOSEPH 68 LAW 501 S BRIMHALL TANSKI BERNARD EDWIN 68 DULTH 410 N 8 AVE W TANTANELLA BARBARA OLS 70 CLA 331-1977 1112 15TH AVE SE TAO TEHSU GRAD	SYMONS MICHAEL DAVID 70 CLA 690-1826 1565 ST PAUL AVE SYRJAMAKI JOHN ARNDLD 69 CLA 824-0240 2525 PILLSBURY SO SYVERSON DAVID SERVIN 70 AGFHE BENSON SYVERSON LOIS ANNELL 70 MORRS 589-3421 301 E 8TH ST SYVERSON MONA KAYE 70 MORRS 301 E 8TH ST SYVERSON TED ROBERT 68 GC 561-7773 6910 HUMBOLDT AVE NO SYVERSON WESLY GLEN 70 PH 331-1013 1425 UNIVERSITY AVE SE SYVERTSEN JAMES ALLEN 70 AGFHE 488-3063 1124 NORTON ST SZALAPSKI JAMES HOWARD 70 CLA 644-4340 1552 BREDA SZCZECZ JAMES THEODORE 69 GC 781-4967 2106 WASHINGTON ST NE SZCZEPANSKI DAVID JOEL 71 CLA 739-9201 2357 CASE ST SZEREMETA MICHAEL STAN 68 IT	TAMIN MOKHTAR BIN GRAD	TAMM PAUL WHITFIELD GRAD 338-4037 1833 FRANKLIN AVE SE TAMMINEN GRETCHEN MARI 68 AGFHE	TAMMINEN HENRY JOSEPH 70 CLA 741-2615 VIRGINIA TAMTE BRUCE ALLAN 68 GC KE7-0382 3607 95TH AVE NO TAMTE BRUCE ARNOLD 68 IT 579-7421 MPL SUPERIOR WI TAN AGNES WEN HUI GRAD	TANER ROY JAMES 68 CLA 331-5986 1815 UNIV AVE SE TANNER SHARON JEAN 71 DULTH 525-2626 4531 DODGE ST TANNER STEVEN JOHN 69 CLA 336-2741 407 7TH ST SE TANNING LARRY GREGG 69 BUS 429-0344 4455 OTTER LAKE RD TANSEY MARK CHRISTOPHE 70 CLA 699-7686 1325 PINENURST TANSEY ROBERT JOSEPH 68 LAW 501 S BRIMHALL TANSKI BERNARD EDWIN 68 DULTH 410 N 8 AVE W TANTANELLA BARBARA OLS 70 CLA 331-1977 1112 15TH AVE SE TAO TEHSU GRAD	TAPPIO DAVID RICHARD 71 IT	TAPLIN ELIZABETH SHIRL 68 ED 224-8840 799 SO SMITH AVE TAPPE CHARLES RAYMOND 70 CLA 3248 GIRARD AVE SO TARAGOS DANIEL 68 GC 866-9951 7420 10TH AVE SO TARAGOS DONALD 68 GC 866-9951 7420 10TH AVE SO TARAGOS THOMAS 68 GC 866-9951 7420 10TH AVE SO TARASAR GREGORY GEORGE 69 BUS	TAMNACHO STEVEN WAYNE 71 IT 866-6522 6620 13TH AVE SO TANBERG DIANA LOUISE 71 CLA 374-3366 245 THOMAS AVE SO TANBERG JAMES RICHARD 69 GC 331-4917 647 TAYLOR ST TANBERG ROLF TORE 70 CLA TERRITORIAL HALL TANBERG YVONNE MARGAR 70 NURS 533-5649 4816 UTAH AVE NO TANDON JAGDISH SINGH GRAD	TARASAR PETER GREGORY 68 GC 781-7940 3242 MCKINLEY ST TARDIFF GREGORY JON 68 ED 429-2709 1379 N BIRCH LAKE BLVD YARDIFF JEFFREY G 632 ONTARIO ST SE TARDIFF MICHELLE ANNE 71 CLA 429-2709 1379 N BIRCH LK BLVD TARMAN MARY SANDRA 68 CLA 451-1282 117 13TH AVE SO TARMANN MARK THOMAS 69 GC 724-4980 5448 31ST AVE SO TARNG MING LIANG 70 CLA 333-8712 130 ARTHUR AVE SE TARNOWSKI FREDRICK GEO 70 DULTH 724-8359 109 CHESTER PKWY TARNOWSKI ROBERTA ANN 71 DULTH R44-8359 109 CHESTER PARKWAY TARR DELBERT HOWARD JR GRAD 524-5036 3108 COLUMBUS AVE SO TARSHISH ELAINE SANDRA 68 GC	TANABE DIANE STONE 70 CLA 331-1525 425 13TH AVE SE TANAKA SUSUMU GRAD	TARVERS ANTHONY CRAWLE 71 DULTH 724-3282 640 WOODLAND AVE TASA KATHLEEN ELIZABET 68 ED 866-3864 5932 CLINTON AVE TASA SUSAN JANE 70 AGFHE 866-3864 5932 CLINTON AVE SO	TARASAR PETER GREGORY 68 GC 781-7940 3242 MCKINLEY ST TARDIFF GREGORY JON 68 ED 429-2709 1379 N BIRCH LAKE BLVD YARDIFF JEFFREY G 632 ONTARIO ST SE TARDIFF MICHELLE ANNE 71 CLA 429-2709 1379 N BIRCH LK BLVD TARMAN MARY SANDRA 68 CLA 451-1282 117 13TH AVE SO TARMANN MARK THOMAS 69 GC 724-4980 5448 31ST AVE SO TARNG MING LIANG 70 CLA 333-8712 130 ARTHUR AVE SE TARNOWSKI FREDRICK GEO 70 DULTH 724-8359 109 CHESTER PKWY TARNOWSKI ROBERTA ANN 71 DULTH R44-8359 109 CHESTER PARKWAY TARR DELBERT HOWARD JR GRAD 524-5036 3108 COLUMBUS AVE SO TARSHISH ELAINE SANDRA 68 GC	TANABE DIANE STONE 70 CLA 331-1525 425 13TH AVE SE TANAKA SUSUMU GRAD	TANAMACHI STEVEN WAYNE 71 IT 866-6522 6620 13TH AVE SO TANBERG DIANA LOUISE 71 CLA 374-3366 245 THOMAS AVE SO TANBERG JAMES RICHARD 69 GC 331-4917 647 TAYLOR ST TANBERG ROLF TORE 70 CLA TERRITORIAL HALL TANBERG YVONNE MARGAR 70 NURS 533-5649 4816 UTAH AVE NO TANDON JAGDISH SINGH GRAD	TARVERS ANTHONY CRAWLE 71 DULTH 724-3282 640 WOODLAND AVE TASA KATHLEEN ELIZABET 68 ED 866-3864 5932 CLINTON AVE TASA SUSAN JANE 70 AGFHE 866-3864 5932 CLINTON AVE SO
--	--	---	--	--	-----------------------	---	--	--	-----------------------	---	--	-----------------------------	---------------------	---	---	---	------------------------	--	---	---	----------------------------	---	---	---	---	---	---	---	--	---

TASCHE HENRY REINHARDT 71 IT  
MPL ELK GROVE IL  
68 DULTH 724-5930  
INTERNAT FALLS

TASCHUK JOSEPH M JR  
317 N 16TH AVE E  
TASCON MANUEL ALONSO  
100 ARTHUR AVE SE  
TASCONALONSO MARGARET  
100 ARTHUR AVE SE  
TASHIRO ELAINE KAZU  
4 210 8TH ST SE  
TASKY LINDA ELAINE  
1401 N CENTRAL AVE  
TASKY PATRICIA ANN  
29 5TH ST  
TAST KAREN DAGMAR  
9876 HALLIE RD  
TAST MARY ANN  
4511 MORRIS THOMAS RD  
TATE HARLEY JOHN  
1485 CLEVELAND AVE N  
TATE JOELLEN MARGARET  
988 ARBOGAST ST  
TATE JUDITH KAY

TATE MARY LOUISE  
330 5TH AVE SE  
TATE MICHAEL DEAN  
BLAKELY HALL  
TATEOSIAN HAZELANN MAR  
18 SO PT DOUGLAS RD  
TATHAM LESLIE ANNE

TATINI SITA RAMAYYA

TATREAU ROBERT WILLIAM  
999 DIVISION AVE  
TATTING FREDRIC DAVID  
3814 RESERVOIR BLVD  
TAUBE JOHN JANIS

TAUBE JULIA THERESA  
1007 GALTIER  
TAUBE ZAIGA  
PIONEER COURT  
TAUBER NANCY CAROL  
GAY HALL  
TAUER CHARLES GEORGE

TAUER KENNETH ALFRED  
1615 W ELDRIDGE AVE  
TAUER MARLEEN MARY  
P O BOX 364 HOWELL HALL  
TAUER MICHAEL LAVERNE  
1700 STANICH PL  
TAUSCHECK RMO  
300 RUBY DR  
TAVARES JOAN CHRISTINE  
840 18TH AVE SE  
TAVEGGIA TIMOTHY JOSEF

TAVERNIER PAUL EDWARD  
4037 17TH AVE SO  
TAVERNIER ROBERT STEVE  
2289 E 16TH AVE  
TAWNEY ELIZABETH ALICE  
1370 LEMAY AVE  
TAXIS SELMA TILLER LYD

TAYKALO THOMAS LEE  
206 14TH AVE NE  
TAYLOR ALDINE  
522 SHADYWAY RD  
TAYLOR BARBARA KAYE  
9033 RUSSELL AVE  
TAYLOR BILLY JAMES  
612 WALNUT SE  
TAYLOR BRIAN WILLIAM  
1309 FLORIDA NO  
TAYLOR CARL BRUCE 3  
4634 DUPONT S  
TAYLOR CAROL ANN  
1830 HAYES ST NE 2  
TAYLOR CHARLES EWALT 3

TAYLOR DANIEL LEE  
7445 HAROLD AVE  
TAYLOR DAVID ALLEN  
720 LAKEWOOD RD  
TAYLOR DAVID DRAPER

TAYLOR DAVID GARTH  
FRONTIER HALL  
TAYLOR DONALD EUGENE  
1383 RAMBLER RD  
TAYLOR DONALD GRANT

TAYLOR DORRIS ANDERSON  
6041 4TH AVE S  
TAYLOR HAROLD ALLEN JR  
2643 ELLIOT AVE SO  
TAYLOR HELEN MARGARET

TAYLOR HERBERT LEWIS J  
1529 N 45 AVE E  
TAYLOR HOWARD WALL  
1500 27TH AVE NE  
TAYLOR JACALYN ANN  
2921 SILVER LAKE RD  
TAYLOR JACK NORTON  
515 15TH AVE SO

TAYLOR JAMES MICHAEL 68 AGFHE  
TAYLOR JAMES ROBERT 70 IT  
TAYLOR JAMES WESLEY 68 GC  
TAYLOR JEAN ANN 70 CLA 544-4327  
85 HAMPSHIRE NO  
TAYLOR JERI LYNNE 71 CLA 544-4327  
85 HAMPSHIRE NO  
TAYLOR JERRY T JR 69 GC 374-2465  
525 HUMBOLDT AVE N  
TAYLOR JOHN ELVON 70 CLA 533-9682  
6901 65TH AVE NO  
TAYLOR KENNETH EDWARD 71 CLA 322-9237  
1406 SHERIDAN N  
TAYLOR LORELEI TRUDE 68 ED 522-8210  
1425 45TH AVE NO  
TAYLOR LORETTA RUTH 70 CLA 335-8467  
516 5TH ST SE  
TAYLOR M FRANCES 69 GC 336-7090  
2125 E RIVER TERRACE  
TAYLOR MARY HELEN 71 CLA 822-2534  
3018 ALDRICH AVE SO  
TAYLOR MARY MARGARET 70 CLA 464-3149  
319 NW 7TH AVE  
TAYLOR MICHAEL IRVING 70 CLA 784-7536  
8065 RIVERVIEW TERR  
TAYLOR PATRICIA LEE 71 CLA 699-2317  
ST PAUL  
TAYLOR PAUL JOSEPH 69 LAW 339-7421  
3109 CENTENNIAL HALL  
TAYLOR PAUL WILLIAM 69 CLA 339-7421  
CENTENNIAL HALL  
TAYLOR RICHARD BARNES 70 IT  
421 CEDAR AVE SO  
TAYLOR RICHARD DENNIS 71 IT 869-3462  
6944 5TH AVE SO  
TAYLOR RICHARD ROGER 70 CLA 788-1883  
BOX 4061 UNIV STA  
TAYLOR ROBERT JOSEPH 68 GC 922-3098  
5204 YORK AVE SO  
TAYLOR RONALD LYNN 71 CLA 537-7388  
3560 WELCOME AVE N  
TAYLOR RONALD NIXON 70 CLA 869-6186  
RHF MINNEAPOLIS  
TAYLOR ROY STEVEN 70 CLA 473-9048  
6325 LYNDALY AVE SO  
TAYLOR SUSAN LEIGH 71 CLA 463-7655  
1012 5TH ST SE  
TAYLOR SUSAN MARGUERIT 69 GC 935-3590  
1714 HILLCREST  
TAYLOR SUSAN SHAPIRO B 68 GC 631-1275  
5205 HUMBOLDT SO  
TAYLOR WILLIAM FRANCIS 68 GC 827-4857  
3752 HILLTOP RD  
TCHIDA MICHAEL CLIFFOR 69 AGFHE 861-2315  
1864 MALVERN  
TEACHWORTH ROGER MASON 71 CLA 463-7655  
800 W 65TH ST  
TEAGER ROGER CALVIN 70 IT 472-1983  
420 UNIVERSITY SE  
TEAGUE CHARLES TRACY 70 IT 472-1983  
RT 3 BOX 229  
TEAGUE PERRY OWEN 71 CLA 463-7655  
505 SUNNYSIDE LN  
TEAL JEFFREY CLEMAN 69 DULTH 724-5498  
FRONTIER HALL  
TECHAR JAMES RUDDLPH 68 GC  
2302 E 5TH ST  
TEDAMONSON KAY LYNN

TEDEFALK ROLF KURT  
TEEL PATRICK A 69 GC 522-7103  
195 SO CLEVELAND  
TEENER SUSAN ANN 70 CLA 781-7501  
1511 LOGAN NO  
TEETER THOMAS RICHARD 68 GC  
PIONEER HALL  
TEETZEL MICHAEL LESLIE 69 GC 489-7131  
TEGENFELDT JOHN HERMAN 71 DULTH 722-9152  
692 W ELDRIDGE AVE  
TEICH THERESA MARIE 71 DULTH 722-9152  
2935 LAKE AVE SO  
TEIPEL WALTER ALEXANDE 68 IT  
OIT MI

TEISBERG JANICE CHALEE 69 CLA 333-0297  
928 5TH ST SE  
TEISBERG JEAN ALICE 71 CLA 227-1678  
215 S GROTT  
TEISBERG THOMAS JOHN 71 CLA  
MPL FARIBAULT  
TEKAVEC PATRICK FRANK 69 DULTH  
46 W CAMP ST  
TEKSE CRAIG THOMAS 69 IT JUB-3086  
3735 ORCHARD  
TELEGA PAUL ANTHONY 71 DULTH 722-0203  
1024 PIEDMONT AVE  
TELFORD GARY KEITH 69 MORRS  
704 E 7TH  
TELINDA JAMES ANDREW 69 IT 735-0282  
877 ALGONQUIN AVE  
TELKE DAVID ALLEN 68 CLA 338-1629  
1619 5TH ST SO  
TELKE ELIZABETH JEAN 69 ED

TELKE JANICE KAY 71 CLA 884-1037  
1401 E 96TH ST  
TELL ERNEST LAURENCE J 69 IT  
TELSCROW LLOYD WESLEY 70 NURS  
TELSCROW MARYJANE ANDE 70 NURS  
TEMALI AGNETE 70 CLA 774-6333  
150 MOUNDS BLVD  
TEMANSON JANIS KAY 68 ED 331-8655  
891 WEEKS AVE SE  
TEMPEL DENNIS CHARLES 71 DENT  
CENTENNIAL HALL  
TEMPEL THOMAS PAUL 69 CLA  
WINNEBAGO  
TEMPEST WILLIAM REESE 68 LAW 522-4053  
4050 N LYNDALY  
TEMPLE HELEN MARSHALL 69 GC 335-8467  
RT 1 BOX 229  
TEMPLETON JULIE ANN 70 CLA  
LITTLE FALLS  
TEMPLIN BETTY JEAN 70 CLA  
1327 4TH ST SE  
TEMPLIN EDITH AFRA 71 DULTH 724-9992  
BURNTSIDE HALL 191  
TEMPLIN JENNIFER JANE 69 ED 331-6146  
319 12TH AVE SE  
TEMTE LEE BRYAN 69 MORRS  
MINNEAPOLIS  
TENBENSEL ROBERT WILLI 68 ED 698-8022  
4541 XERXES  
TENBERGEN REICHEL ABEL 70 DULTH 624-3350  
415 ERIE ST SE APT 3C  
TENDER PAUL EDWARD 70 CLA  
OSSEO  
TENENBAUM MARILYN 68 ED 698-8022  
1458 GOODRICH  
TENGQUIST LOUISE HELEN 70 DULTH 624-3350  
312 N 40TH AVE W  
TENGWALL CHERYL ANN 70 CLA 881-2177  
9301 CHICAGO AVE  
TENNAPEL ROGER DALE 68 IT 331-5951  
613 OAK ST SE  
TENNER JUDITH PARKER 71 CLA 922-3954  
5917 THOMAS AVE  
TENNER LORETTA JANE 70 CLA 926-3252  
4504 EDINA BLVD  
TENNER SUZANNE HARPER 68 CLA 339-0063  
4504 EDINA BLVD  
TENNENSON ALAN JAMES 68 LAW 890-2174  
3809 E SIBLEY ST  
TENNESSEN ROBERT JOSEF 68 LAW 890-2174  
CENTENNIAL HALL  
TENNESSEN VIRGINIA ROS 68 CLA 339-0063  
52 SO 10TH ST  
TENNEY JUDITH ANN 70 CLA  
961 W IOWA AVE  
TENNISON MARYLIS JEWEL 69 DULTH 724-0113  
1128 E 9TH ST  
TEPE WILLIAM ALBERT 70 CLA 777-6876  
1753 FLANDRAU  
TEPLEY JUDY MARIE 70 DULTH 724-9978  
GRIGGS HALL K214  
TEPLEY SUSAN KAY 70 AGFHE 698-6338  
1353 SO CLEVELAND  
TEPPER MARVIN MEYER 68 LAW 331-6963  
515 DELAWARE ST SE  
TERADA KOREKIYO 70 DULTH 724-5498  
CENTENNIAL HALL  
TERAS VERNON HUGO 68 DULTH 728-1751  
1308 E 5TH ST  
TEREAULT KATHLEEN CARO 70 CLA

TERHAAR ALFRED A 70 MED  
TERHORST THOMAS RALPH 68 ED 471-7921  
1522 PORTLAND  
TERLINDEN DUWAYNE DUDL 70 CLA 825-6385  
RT 1 BOX 323  
TERLISNER MICHAEL ARTH 70 DULTH  
3141 5TH AVE SO  
TERNES DONALD ROGER 71 IT  
714 COLLEGE ST  
TERPSTRA JAMES GEORGE 69 DULTH 728-4842  
NOPEMING  
TERRELL DIANE O 69 CLA  
504 N 15 AVE E  
TERRES PETER JOSEPH 68 AGFHE  
STP NORTHFIELD  
TERRY EDWARD CHESTER 70 CLA  
1485 NO CLEVELAND  
TERRY SHEILA MARGARET 68 MORRS  
4443 CEDAR AVE SO  
TERSTEEL MARK DAVID 68 MORRS  
LA GRANG HOTEL  
TERSTEEL PAUL ANTHONY 68 MORRS  
LA GRAND HOTEL  
TERVO JUDITH ANN 70 DULTH 727-4205  
601 E 10TH ST  
TERWILLIGER MILDRED CA 69 CLA 645-7696  
1492 N HOLTEN ST  
TERWILLIGER PAMELA DEN 71 DULTH 724-9896  
BURNTSIDE HALL 175  
TESCH BARBARA ANN 70 CLA 339-0931  
SANFORD HALL  
TESCH JUDITH ORNA 71 MORRS 589-4693  
SPOONER HALL  
TESKA DAVID CHARLES 69 DULTH  
GHEEN

TESKE BRADLEY E 70 CLA 331-6400  
 494 FRONTIER HALL  
 TESKE DIANE JUDITH 69 CLA 331-5588  
 516 12TH AVE SE  
 TESKE JAMES EDWARD 71 CLA 522-0017  
 3106 NEWTON N  
 TESKE JOHN WILLIAM 68 IT  
  
 TESKE RICHARD PAUL 71 DULTH 724-9800  
 TORRANCE HALL 230  
 ST PAUL  
 TESKE WALTER FREDERICK 69 DENT 724-2095  
 4254 24TH AVE SO  
 MPL MINNEAPOLIS  
 TESLOW PHILIP BURTON 69 LAW 331-1108  
 317 18TH AVE SE  
 MPL ST LOUIS PARK  
 TESSLER BERNARD BARRY 71 DULTH 633-2217  
 1405 TERRACE DR  
 ROV  
 TESSLING CLIFFORD MICH 71 CLA 644-1769  
 1914 ASHLAND  
 STP ST PAUL  
 TESSMAN CAROL JOY ANNE 70 CLA 529-4780  
 4949 DUPONT NO  
 MPL MINNEAPOLIS  
 TESSMANN PAMELA ANN 71 CLA 774-2460  
 1955 E MONTANA  
 STP ST PAUL  
 TESSMER GEORGE WILLI J 70 CLA 226-9416  
 309 S EXCHANGE  
 STP ST PAUL  
 TESSMER LINDA PAULINE 70 AGFHE  
  
 TESTA KATHLEEN ANN 68 ED 771-6079  
 710 E COOK  
 STP ST PAUL  
 TESTA MICHAEL ADRIAN 2 69 CLA 488-8575  
 418 W-WHEELLOCK  
 STP ST PAUL  
 TESTEN THEODORE JAMES 70 IT  
  
 TESTER DENNIS WAYNE 71 CLA 227-3332  
 791 HOLLY  
 STP ST PAUL  
 TESTER MARY ELIZABETH 69 ED  
  
 TESTER RICHARD LOWELL 68 DULTH  
 MINNEAPOLIS  
 TESTER WARREN WILLIAM 70 DULTH  
 MINNEAPOLIS  
 TETER JULIE ANN 71 DULTH 626-1276  
 1030 86TH AVE W  
 DULUTH  
 TETHER DOROTHY PATRICI 68 ED 884-1953  
 11038 RUSSELL AVE SO  
 BLT BLOOMINGTON  
 TETHERLY JONATHAN COLL 71 DULTH 473-8432  
 161 FERNDALE AVE SO  
 GRAD  
 TETNER JOANNE MARIE 69 GC 825-1212  
 3537 COLFAJ AVE SO  
 MPL MINNEAPOLIS  
 TETRUD LINDA ELIZABETH 69 CLA 115-8056  
 1041 IDAHO NO  
 GDV GOLDEN VALLEY  
 TETZLAFF WILLIAM ARTHU 69 BUS  
  
 TETZLOFF STEPHEN PAUL 69 GC  
 MPL JANESVILLE  
 TEUBER VICKI HELENE 69 CLA  
 MPL RICE  
 TEVOGT WILLIAM HUGH 69 ED 533-3417  
 6651 67TH AVE NO  
 BRP  
 TEW MICHAEL PETER 68 DULTH 384-4345  
 WRENSHALL  
  
 TEWINKEL CHARLES G GRAD  
  
 TEWINKEL JOSEPH M GRAD 777-2947  
 1497 E LARPEnteUR  
 MPW SPOKANE WA  
 TEZLA KATHY ELAINE 70 CLA 525-1208  
 5255 DODGE ST  
 DULUTH  
 TEZLA MICHAEL WILLIAM 68 CLA  
  
 THACHER THOMAS ALLSOPP 70 CLA  
 MPL MINNEAPOLIS  
 1800 16TH AVE SE  
 THAEMERT ROBERT CARL 70 CLA 537-3909  
 4043 REGENT AVE NO  
 ROB ROBBINSDALE  
 THAKER ANILKUMAR KESHA 71 DULTH 338-9052  
 219C 8TH AVE SE  
 GRAD  
 MPL BOMBAY  
 THALBERG MICHAEL DEAN 68 PHARM 866-0546  
 6024 15TH AVE SO  
 MPL DASSEL  
 THALHUBER WAYNE H GRAD  
  
 THALHUBER WILLIAM JOHN 69 IT 646-0086  
 1145 BLAIR  
 STP ST PAUL  
 THARALDSON MARLENE ANN 68 MORRS  
 STARBUCK  
 THARALDSON STEVEN HOWA 70 CLA 869-2278  
 6104 CLINTON SO  
 MPL MINNEAPOLIS  
 THARALDSON SUSAN KAY 69 GC  
 MPL MINNEAPOLIS  
 6104 CLINTON AVE SO  
 THARALSON KATHLEEN JEA 70 ED 222-7079  
 PIONEER COURT  
 MPL WEST ST PAUL  
 THATCHER DAVID ALLAN 68 DULTH 722-1114  
 312 W 4TH ST  
 DULUTH  
 THATCHER DAVID PETER 68 GC 224-0627  
 209 CURTICE ST W  
 WSP WEST ST PAUL  
 THATCHER LINDEN EDWIN 69 GC 888-5303  
 RT 1  
 LKV BLOOMINGTON  
 THAUVALD KURT GORDON 71 IT 426-2697  
 RT 3  
 STP ST PAUL  
 THAVIKULMAT PRECHA 71 IT 338-3392  
 1009 UNIVERSITY AVE SE  
 MPL BANGKOK  
 THAYER DARRYL ALLISON 69 IT 644-5060  
 2406 DOSWELL  
 STP  
 THAYER ELLEN ROSE 69 ED  
 EDINA  
 THAYER JANET BELL NYE 69 ED 560-3858  
 377 66TH AVE NE  
 FRD  
 THAYER YVONNE FRANCES 70 CLA  
 MPL EDINA  
 305 WALNUT AVE SE  
 THEEL ROBERTA ADAIR 69 GC  
 MPL MINNEAPOLIS  
 15 ARTHUR ST SE  
 THEIS DENNIS CLARENCE 71 DENT  
 MPL EDEN VALLEY  
 901 E RIVER RD







TIPPIN ROBERT BRUCE 2530 FISK TIPPLE BRUCE EDWARD 2611 17TH AVE SO TIRPAK ANDREW JAY FRONTIER HALL TISCH CANDACE ANN RTE 6 BOX 248 TISCHER CYNTHIA LYNN 9141 MORGAN AVE TISCHER LARRY JAMES 2111 GORDON AVE TISCHER TIMOTHY JOHN	GRAD 484-4698 ROV FAIRBURY NB AS ED 724-3306 MPL MINNEAPOLIS 70 CLA MPL GOLDEN VALLEY 71 CLA 474-7838 EXC EXCELSIOR 69 GC 881-7385 BLT BLOOMINGTON 70 VET M 644-1649 STP CLARA CITY 69 GC	TOENSING STEPHEN EARL 791 HOWELL TOERING LAWRENCE HUBER 4012 MONTEREY AVE TOEMA BARBARA ANN 125 N 64TH AVE W TOFFOLI MICHAEL MARTIN 390 W COTTAGE TOFFE JOHN A 1933 SPRINGVALE RD TOFFE NANCY ELIZABETH 1109 5TH ST TOFFE R JOEL 520 KENILWORTH AVE TOFFE RICHARD JAMES	70 CLA 644-0674 STP ST PAUL 70 IT 926-7089 EDN 69 DULTH 624-2752 DULUTH GRAD 488-9991 STP DULUTH 68 DULTH 722-9605 TOFFE 68 MEDTC 331-1339 MPL 68 DULTH 724-5311 DULUTH 71 DULTH 663-7261 TOFFE AS DULTH 724-5309 TOFFE	TOMKINS RICHARD JAMES 317 18TH AVE SE TOMLAN THOMAS H 2721 E SUPERIOR ST TOMLINSON JAMES LEROY 1485 CLEVELAND AVE TOMLINSON MARY SUZANNE 4628 YORK SO TOMLINSON SANDRA KAY RT 3 BOX 554 TOMORY ROBERT ERNEST 2740 W 66TH ST TOMPCKINS STEPHEN DONALD 1364 SO SMITH AVE TOMPCKINS TERRENCE JERO 3106 IRVING NO TOMSEVICS ILZE	68 GC FE1-1108 MPL 68 DULTH 724-7857 DULUTH 69 AGFHE 645-8787 STP MANKATO 68 GC 922-2052 MPL MINNEAPOLIS 71 CLA 474-4556 EXC EXCELSIOR 69 ED 869-7853 RHF CHICAGO IL 70 CLA 227-2294 WSP WEST ST PAUL 70 CLA 521-1479 MPL MINNEAPOLIS 70 AGFHE 331-8858 MPL ISANTI 68 DULTH 727-2880 TOWER	TISOVICH JAMES DONALD 1025 E HARVEY TITCOMB JEFFREY DAVID	69 DULTH 365-4732 ELY 68 GC	TITON JEFF TODD	GRAD	TITON PAULA PROTZE 413 20TH AVE SO TITTERINGTON ROBERT ST 3503 HILLSBORO NO TITTERUD GERALD LUVERN ROUTE 4 TITTERUD SHIRLEY JEAN RT 5 TITTLE HARRY ROSS	GRAD 336-3909 MPL WELLESLEY MA AS CLA 544-8384 NWH YAKIMA WA 71 IT 434-5853 ANK ANOKA 68 ED 434-5845 ANK ANOKA 68 GC	TITTLE MARY JEAN 1121 HAGUE AVE TITUS JAMES MARTIN 803 HURON SE TITUS PATRICIA JOAN 800 UNIVERSITY AVE SE TITUS TIMOTHY EDWARD	70 CLA 646-0825 STP ST PAUL AS PH FE5-4887 MPL MILLBRAR CA 68 CLA 331-3098 MPL HASTINGS 71 CLA	TIX PAUL EDWARD	GRAD	TIZIANI LAWRENCE JOHN	69 ED IRONWOOD MI	TJART BEVERLEY JOHNETT POWELL HALL TJEPKES MICHAEL ALLAN	GRAD 339-0531 MPL BAXTER SPNGS 69 CLA	TJONGAHUNG ARMAND ROMA	GRAD	TJOSVOLD BRUCE FRANCIS 5413 OLIVER AVE SO TJOSVOLD DEAN WILLIAM 3223 MINNEHAHA TJOSVOLD JOANNE MARY 3122 NE BENJAMIN ST TKACH DANIEL JR 4050 JEFFERSON ST NE TKACH VLADIMIR 4053 VAN BUREN TOBER DENNIS WILLIAM 2030 GIESMAN TOBER RICHARD MATTHEW 2080 GIESMAN TOBIAS JAMES RICHARD	69 GC 926-5004 MPL MINNEAPOLIS GRAD 724-0936 MPL MINNEAPOLIS 70 CLA 789-7783 MPL MINNEAPOLIS 69 BUS 788-6148 CLH COLUMBIA HTS 68 BUS 788-3155 CLH COLUMBIA HTS 69 GC 489-6708 STP ST PAUL 69 IT 489-6708 ROV ROSEVILLE GRAD	TOLLEFSON CARMEN MARY 2006 JEFFERSON AVE TOLLEFSON LEE EMMETT 1411 BLAIR AVE TOLLEFSON MERLAND DUAN 1922 WILLOW AVE NO TOLLEFSON SANDRA SUE SANFORD HALL TOLLEFSON TERRY WILLIA TERRITORIAL HALL TOLLEFSON GREGORY JOH BRAHAM	71 CLA STP SOUTH ST PAUL 68 CLA 646-6852 STP LAMBERTON 68 PHARM JA9-5391 MPL MINNEAPOLIS 70 CLA MPL LONG LAKE 71 CLA MPL MINNETONKA 70 CLA	TOLLISON JULIE ANN 519 10TH AVE SE TOLLUND LESLIE RICHARD 3309 31ST AVE NE TOLZMAN HARRY FREDERIC BAILEY HALL TOLZMAN LESLIE CARL 700 UNIVERSITY SE TOLZMANN DONALD HEINRI 3710 13TH AVE SO TOMAN BRUCE EDWARD	70 CLA 331-7213 MPL RED WING 71 CLA 781-9212 STA ST ANTHONY 71 AGFHE STP LE CENTER 71 CLA MPL NORTH BRANCH 68 CLA MPL MINNEAPOLIS 70 IT	TOMAN ROGER T BOX 353 TOMASCAC PATRICIA ANN 4740 QUAIL AVE NO TOMASCHESKI KARL HEIN	70 DULTH MARBLE 70 CLA 537-9420 CYT CRYSTAL 68 IT	TOMBERS MATHEW JOHN 4801 BRYANT SO TOMBERS REID BERNARD	71 CLA 824-4027 MPL MINNEAPOLIS 68 IT	TOMBOULIAN JOYCE LAVIK 725 8TH AVE SE TOMBOULIAN LAWRENCE AR 725 8TH AVE SE TOMCIK MARY SUSAN 1414 7TH ST SE TOMCZAK APRIL JOY 1645 INNSBRUCK PKWY TOMCZAK GARRETT JOHN 4255 YORK N TOMCZYK MARTHA ANN 1614 CALIF ST NE TOMCZYK MICHAEL STANLE 1032 43RD AVE NE TOMERVIK KARIN MARIE 555 MARSHAN LANE TOMFOHRDE SUSAN KAY SANFORD HALL TOMHAVE JOHN FRANCIS	GRAD 331-3346 MPL GRAD 331-3346 MPL 68 CLA MPL NILES IL 70 CLA 788-0322 MPL MINNEAPOLIS 70 CLA 588-7635 ROB ROBBINSDALE 70 CLA 789-5764 MPL MINNEAPOLIS 70 AGFHE 788-0735 MPL MINNEAPOLIS 69 CLA 786-1435 CRP CIRCLE PINES 71 CLA 843-3205 MPL MAZEPPA 68 CLA HIBBING	TOMHAVE MARTHA ANNE COMSTOCK HALL TOMISAK ROBERT ANDREW 1805 MARSHALL	70 CLA MPL HIBBING GRAD 644-2145 STP	TOMSKICH BARRY JOHN 410 B E 1 ST TOMSKICH PETER MICHAEL 1810 11TH AVE SO TONDER JERALD MARTIN 1032 WARNER AVE TONE LAURIE ANN 603 OAK ST SE TONER DANIEL OWEN FRONTIER HALL TONER MICHAEL ANTHONY 2097 COMO AVE TONER SHARRON LYNN 4701 ABBOTT SO TONGEN MARY VEDA 1391 EDGCUMBE RD TONGEN THOMAS AARON 1391 EDGCUMBE RD TONIA JOHN DANIEL 1288 JESSIE TONKIN PATRICIA ANN 313 HARVARD SE TONKIN THOMAS MASON 1822 E 8TH ST TONKO JOSEPH RUDDOLPH EVELETH	69 AGFHE 644-1289 STP BEAVER CREEK 71 IT MPL PELICAN RAPIDS 69 IT 522-5304 MPL MINNEAPOLIS 71 DULTH ORR 70 DULTH BOVEY 70 CLA 781-1631 STA ST ANTHONY 69 IT 71 DULTH 724-9814 ANOKA 71 AGFHE 484-7042 SHV SHOREVIEW GRAD	TONSBERG JEANETTE RUTH 516 12TH AVE SE TONSKEMPER GLORIA JEAN 5808 10TH AVE SO TOOKENAY VINCENT FAVIA 3516 18TH AVE SO TOOL JAMES WAYNE	70 CLA 331-5508 MPL HOWARD LAKE 70 ED 866-2424 MPL MINNEAPOLIS 70 CLA 729-4868 MPL AS ED	TOOL SANDRA ANITA	AS ED	TOOLEY JOHN FRANCIS 1223 4TH ST SE TOOLEY RODNEY GEORGE	GRAD MPL JERSEY CITY NJ GRAD	TOPNESS DONNEL ELMER 1254 GIBBS AVE TOPOLKA KATHLEEN JOYCE COMSTOCK HALL TOPOLKA MICHAEL EDWARD	68 ED 645-2002 STP ST PAUL 68 ED 333-2161 MPL FLINT MI 69 IT	TOPOR MICHAEL GRANT CENTENNIAL HALL TOPP JERALD CURTISS	GRAD MPL HILLSIDE IL 71 AGFHE 463-8125 FARMINGTON	TOPP LEE E	AS ED	TOPPSON KAREN MARGARET 4017 GILLIAT ST TORAIN CLEVELAND MICHA 903 SHERIDAN AVE NO TORBENSON RICHARD LBRO TERRITORIAL HALL TORBERT JAMES DONALD	70 DULTH 525-5798 DULUTH AS IT 529-8088 MPL INDIANAPOLIS IN 70 IT MPL PAYNESVILLE AS ED	TORBERT MORRIS LYLE BOX 68 TORBETT DAVID S	68 CLA HECTOR GRAD	TORBORG LAURA MARIE 630 4TH ST NE TORELLA JANET RAYE GRIGGS HALL M317 TOREN ELEANOR MCILVENN 805 PARK AVE TORESON JUDITH ANN 3413 LONGFELLOW AVE S TORFIN NANCY LOU 910 ESSEX TORGERSEN ELIZABETH SI 727 15TH AVE SE TORGERSON BYRON ROBERT 604 ONTARIO ST SE TORGERSON JESSIE M	71 CLA 335-1359 MPL MINNEAPOLIS 71 DULTH 724-9869 STILLWATER 68 ED 426-2531 MAH 69 CLA 729-2916 MPL MINNEAPOLIS 68 NURS 331-3261 MPL VIKING 70 CLA 645-4162 STP ST PAUL 68 DENT 331-8599 MPL STILLWATER AS ED	TORGERSON JOHN ALFRED 5017 OTSEGO ST TORGERSON PHILIP ERVIN 9005 LENROD ST TORGERSON ROBERT BURTO 604 ONT ST SE	71 CLA 784-8817 NWB BAGLEY 70 CLA 377-6584 GDV GOLDEN VALLEY GRAD 71 DULTH CLEARBROOK 70 DULTH 626-1519 DULUTH 69 DENT 331-8599 MPL STILLWATER
TISOVICH JAMES DONALD 1025 E HARVEY TITCOMB JEFFREY DAVID	69 DULTH 365-4732 ELY 68 GC	TITON JEFF TODD	GRAD	TITON PAULA PROTZE 413 20TH AVE SO TITTERINGTON ROBERT ST 3503 HILLSBORO NO TITTERUD GERALD LUVERN ROUTE 4 TITTERUD SHIRLEY JEAN RT 5 TITTLE HARRY ROSS	GRAD 336-3909 MPL WELLESLEY MA AS CLA 544-8384 NWH YAKIMA WA 71 IT 434-5853 ANK ANOKA 68 ED 434-5845 ANK ANOKA 68 GC	TITTLE MARY JEAN 1121 HAGUE AVE TITUS JAMES MARTIN 803 HURON SE TITUS PATRICIA JOAN 800 UNIVERSITY AVE SE TITUS TIMOTHY EDWARD	70 CLA 646-0825 STP ST PAUL AS PH FE5-4887 MPL MILLBRAR CA 68 CLA 331-3098 MPL HASTINGS 71 CLA	TIX PAUL EDWARD	GRAD	TIZIANI LAWRENCE JOHN	69 ED IRONWOOD MI	TJART BEVERLEY JOHNETT POWELL HALL TJEPKES MICHAEL ALLAN	GRAD 339-0531 MPL BAXTER SPNGS 69 CLA	TJONGAHUNG ARMAND ROMA	GRAD	TJOSVOLD BRUCE FRANCIS 5413 OLIVER AVE SO TJOSVOLD DEAN WILLIAM 3223 MINNEHAHA TJOSVOLD JOANNE MARY 3122 NE BENJAMIN ST TKACH DANIEL JR 4050 JEFFERSON ST NE TKACH VLADIMIR 4053 VAN BUREN TOBER DENNIS WILLIAM 2030 GIESMAN TOBER RICHARD MATTHEW 2080 GIESMAN TOBIAS JAMES RICHARD	69 GC 926-5004 MPL MINNEAPOLIS GRAD 724-0936 MPL MINNEAPOLIS 70 CLA 789-7783 MPL MINNEAPOLIS 69 BUS 788-6148 CLH COLUMBIA HTS 68 BUS 788-3155 CLH COLUMBIA HTS 69 GC 489-6708 STP ST PAUL 69 IT 489-6708 ROV ROSEVILLE GRAD	TOLLEFSON CARMEN MARY 2006 JEFFERSON AVE TOLLEFSON LEE EMMETT 1411 BLAIR AVE TOLLEFSON MERLAND DUAN 1922 WILLOW AVE NO TOLLEFSON SANDRA SUE SANFORD HALL TOLLEFSON TERRY WILLIA TERRITORIAL HALL TOLLEFSON GREGORY JOH BRAHAM	71 CLA STP SOUTH ST PAUL 68 CLA 646-6852 STP LAMBERTON 68 PHARM JA9-5391 MPL MINNEAPOLIS 70 CLA MPL LONG LAKE 71 CLA MPL MINNETONKA 70 CLA	TOLLISON JULIE ANN 519 10TH AVE SE TOLLUND LESLIE RICHARD 3309 31ST AVE NE TOLZMAN HARRY FREDERIC BAILEY HALL TOLZMAN LESLIE CARL 700 UNIVERSITY SE TOLZMANN DONALD HEINRI 3710 13TH AVE SO TOMAN BRUCE EDWARD	70 CLA 331-7213 MPL RED WING 71 CLA 781-9212 STA ST ANTHONY 71 AGFHE STP LE CENTER 71 CLA MPL NORTH BRANCH 68 CLA MPL MINNEAPOLIS 70 IT	TOMAN ROGER T BOX 353 TOMASCAC PATRICIA ANN 4740 QUAIL AVE NO TOMASCHESKI KARL HEIN	70 DULTH MARBLE 70 CLA 537-9420 CYT CRYSTAL 68 IT	TOMBERS MATHEW JOHN 4801 BRYANT SO TOMBERS REID BERNARD	71 CLA 824-4027 MPL MINNEAPOLIS 68 IT	TOMBOULIAN JOYCE LAVIK 725 8TH AVE SE TOMBOULIAN LAWRENCE AR 725 8TH AVE SE TOMCIK MARY SUSAN 1414 7TH ST SE TOMCZAK APRIL JOY 1645 INNSBRUCK PKWY TOMCZAK GARRETT JOHN 4255 YORK N TOMCZYK MARTHA ANN 1614 CALIF ST NE TOMCZYK MICHAEL STANLE 1032 43RD AVE NE TOMERVIK KARIN MARIE 555 MARSHAN LANE TOMFOHRDE SUSAN KAY SANFORD HALL TOMHAVE JOHN FRANCIS	GRAD 331-3346 MPL GRAD 331-3346 MPL 68 CLA MPL NILES IL 70 CLA 788-0322 MPL MINNEAPOLIS 70 CLA 588-7635 ROB ROBBINSDALE 70 CLA 789-5764 MPL MINNEAPOLIS 70 AGFHE 788-0735 MPL MINNEAPOLIS 69 CLA 786-1435 CRP CIRCLE PINES 71 CLA 843-3205 MPL MAZEPPA 68 CLA HIBBING	TOMHAVE MARTHA ANNE COMSTOCK HALL TOMISAK ROBERT ANDREW 1805 MARSHALL	70 CLA MPL HIBBING GRAD 644-2145 STP	TOMSKICH BARRY JOHN 410 B E 1 ST TOMSKICH PETER MICHAEL 1810 11TH AVE SO TONDER JERALD MARTIN 1032 WARNER AVE TONE LAURIE ANN 603 OAK ST SE TONER DANIEL OWEN FRONTIER HALL TONER MICHAEL ANTHONY 2097 COMO AVE TONER SHARRON LYNN 4701 ABBOTT SO TONGEN MARY VEDA 1391 EDGCUMBE RD TONGEN THOMAS AARON 1391 EDGCUMBE RD TONIA JOHN DANIEL 1288 JESSIE TONKIN PATRICIA ANN 313 HARVARD SE TONKIN THOMAS MASON 1822 E 8TH ST TONKO JOSEPH RUDDOLPH EVELETH	69 AGFHE 644-1289 STP BEAVER CREEK 71 IT MPL PELICAN RAPIDS 69 IT 522-5304 MPL MINNEAPOLIS 71 DULTH ORR 70 DULTH BOVEY 70 CLA 781-1631 STA ST ANTHONY 69 IT 71 DULTH 724-9814 ANOKA 71 AGFHE 484-7042 SHV SHOREVIEW GRAD	TONSBERG JEANETTE RUTH 516 12TH AVE SE TONSKEMPER GLORIA JEAN 5808 10TH AVE SO TOOKENAY VINCENT FAVIA 3516 18TH AVE SO TOOL JAMES WAYNE	70 CLA 331-5508 MPL HOWARD LAKE 70 ED 866-2424 MPL MINNEAPOLIS 70 CLA 729-4868 MPL AS ED	TOOL SANDRA ANITA	AS ED	TOOLEY JOHN FRANCIS 1223 4TH ST SE TOOLEY RODNEY GEORGE	GRAD MPL JERSEY CITY NJ GRAD	TOPNESS DONNEL ELMER 1254 GIBBS AVE TOPOLKA KATHLEEN JOYCE COMSTOCK HALL TOPOLKA MICHAEL EDWARD	68 ED 645-2002 STP ST PAUL 68 ED 333-2161 MPL FLINT MI 69 IT	TOPOR MICHAEL GRANT CENTENNIAL HALL TOPP JERALD CURTISS	GRAD MPL HILLSIDE IL 71 AGFHE 463-8125 FARMINGTON	TOPP LEE E	AS ED	TOPPSON KAREN MARGARET 4017 GILLIAT ST TORAIN CLEVELAND MICHA 903 SHERIDAN AVE NO TORBENSON RICHARD LBRO TERRITORIAL HALL TORBERT JAMES DONALD	70 DULTH 525-5798 DULUTH AS IT 529-8088 MPL INDIANAPOLIS IN 70 IT MPL PAYNESVILLE AS ED	TORBERT MORRIS LYLE BOX 68 TORBETT DAVID S	68 CLA HECTOR GRAD	TORBORG LAURA MARIE 630 4TH ST NE TORELLA JANET RAYE GRIGGS HALL M317 TOREN ELEANOR MCILVENN 805 PARK AVE TORESON JUDITH ANN 3413 LONGFELLOW AVE S TORFIN NANCY LOU 910 ESSEX TORGERSEN ELIZABETH SI 727 15TH AVE SE TORGERSON BYRON ROBERT 604 ONTARIO ST SE TORGERSON JESSIE M	71 CLA 335-1359 MPL MINNEAPOLIS 71 DULTH 724-9869 STILLWATER 68 ED 426-2531 MAH 69 CLA 729-2916 MPL MINNEAPOLIS 68 NURS 331-3261 MPL VIKING 70 CLA 645-4162 STP ST PAUL 68 DENT 331-8599 MPL STILLWATER AS ED	TORGERSON JOHN ALFRED 5017 OTSEGO ST TORGERSON PHILIP ERVIN 9005 LENROD ST TORGERSON ROBERT BURTO 604 ONT ST SE	71 CLA 784-8817 NWB BAGLEY 70 CLA 377-6584 GDV GOLDEN VALLEY GRAD 71 DULTH CLEARBROOK 70 DULTH 626-1519 DULUTH 69 DENT 331-8599 MPL STILLWATER						

TORGERSON RONALD AANE 284 VINCENT RD TORGERSON ROSLYN BAHR 6328 BARRIE RD TORGESON MICHAEL GEORG 7483 OSSEO RD TORGRIMSON MARK LLOYD 1820 A 5TH ST SE TORGUSEN RICHARD CHARL DAY HALL TORKELSON EDNA ROSE 1912 CLINTON AVE TORMA DAVID LEON	69 GC 377-1289 MPL MINNEAPDLIS GRAD 926-8082 69 BUS BRP BROOKLYN PARK 69 CLA MPL HUTCHINSON 71 MORRS BRANDON 71 CLA 336-2906 MPL WILLOW RIVER 68 IT	TORMANEN CALVIN DOUGLA 1820 THIRD AVE NO TORNELL GLENN CLIFFORD	69 CLS 377-0172 MPL COKATO 70 CLA	TURNELL KATHY JEAN 3200 FRANCE AVE NO TURNING LINDA MARIE 412 HERSCHEL TURNOW WALTER WILLIAM 8217 W 30 1/2 ST TURNQUIST SHELDON LEE 722 27TH AVE S TORK ANDREW	71 CLA 588-3689 ROB ROBBINSDALE 70 CLA 644-3152 STP ST PAUL GRAD 935-8925 SLP 68 ED 336-3215 MPL KERKHOVEN GRAD	TORP BARRY LEE 325 LEICESTER AVE TORP WILLIAM BRYAN	68 DULTH 724-6392 DULUTH GRAD	TORRANCE CHARLES MICHA RICHFIELD	68 DULTH RICHFIELD 70 CLA 545-1270 SLP ST LOUIS PARK 69 CLA 866-6155 RHF RICHFIELD 71 DULTH 724-9814 RICHFIELD 70 DULTH 724-8914 DULUTH 70 CLA MPL HIBBING GRAD 784-7774 STP CHIPPEWA FLS WI GRAD MPL ALBAY GRAD	TORREANO CAROLE ANN 727 EVERETT ST TORREANO MARIE HELEN CONSTOCK HALL TORRENCE JUDITH LYNN 2071 OAKWOOD DR TORRES ENRIQUETA BERNA 515 DELANARE SE TORRES LUIS	68 DULTH RICHFIELD 70 CLA MPL HIBBING GRAD 784-7774 STP CHIPPEWA FLS WI GRAD MPL ALBAY GRAD	TORRES REMIGIO DIOSO HAECKER HALL TORREST ROBERT STEVEN	GRAD STP GRAD	TORREY EUGENE ARNOLD	69 IT	TORRISON THOMAS JOHN 1424 E 4TH ST TORSKE CHARLES RICHARD PIONEER HALL TORVICK CAROLYN CHRIST 4311 W 5TH ST TOSIER KATHLEEN LOUISE 4122 ZENITH TOSKAS DENNIS 1301 SE 7TH ST TOSKAS JAMES WILLIAM 1301 SE 7TH ST TOSKEY BRUCE RICHARD 2915 ASBURY ST TOSKEY MICHAEL GARRY 1177 VIRGINIA ST TOSTRUD MILTON I 401 CO RD 3 TOTUSHEK MARLYS ANN	AS DULTH 724-2998 DULUTH 69 BUS MPL PINE RIVER 71 DULTH 624-0717 DULUTH 68 GC 926-4238 MPL MINNEAPDLIS 68 CLA 331-1104 MPL MINNEAPOLIS 70 MED MPL MINNEAPOLIS 71 CLA ROV ROSEVILLE 69 CLA 489-0300 STP ST PAUL 69 BUS HOP ALBERT LEA GRAD	TOTINO BONITA JOSEPHIN 3434 FILLMORE ST NE TOTINO REBECCA JOSEPHI 1700 COMO SE TOTTEN NOEL JR 11167 ARROWHEAD ST TOTUSHEK MARLYS ANN 1502 RAYMOND AVE TOUGAS FRANCIS STEPHEN 2722 SHERIDAN RD TOUPIN RONALD FRANCIS 4216 OAK DR LANE TOURANGEAU JOHN ARTHUR RR 5 BOX 629 TOURJE ELTON JAMES 632 ONTARIO ST SE TOURVILLE ALAN VERN 2625 XYLON AVE SO TOURVILLE ANDREW JOSEPH 235 3RD AVE SO TOUSIGNANT THOMAS ARTH 2249 CONWAY ST TOUVE CAROLYN MARIE 914 2ND AVE E TOMBER RICHARD IVAN 7601 KNOX AVE SO TOWERS MICHAEL BRUCE P O BOX 4007 UNIV STA TOWNEY EDWARD ANDREW 421 CEDAR AVE SO TOWNEY MARILYN HELEN	69 GC 789-1971 MPL MINNEAPOLIS 70 CLA MPL MINNEAPOLIS 70 CLA 421-2579 CNR COON RAPIDS 69 AGFHE WE8-5040 STP MINNETONKA 71 CLA 521-9137 MPL MINNEAPDLIS 71 CLA WE5-3196 HOP HOPKINS 69 GC 473-8276 WAY WAYZATA 69 MED 331-1369 MPL SILVER BAY 69 GC 545-6150 SLP GOLDEN VALLEY 68 CLA 451-8477 SSP SOUTH ST PAUL 71 IT 735-4621 STP ST PAUL 71 DULTH AR WI GRAD 861-3844 RHF 71 CLA MPL OAKLAND CA 68 BUS MPL ROCHESTER 69 ED	TOWNEY MARTHA MARY 815 13TH AVE SE TOWLE MERRY CAROL 1120 5TH ST SE TOWLE PATRICIA HILL RT 3 BOX 130 TOWN DOUGLAS RAYMOND J 5544 41ST AVE SO TOWN FREDERICH CLIFFOR 310 4 ST TOWN GAIL ANN 5257 ZENITH AVE SO TOWN PATRICIA MARIE 624 N 25TH AVE W TOWNER MARY LYNN 166 NIAGARA LANE TOWNER WILLIAM EARL 81 N GRIGGS ST APT 5 TOWNS DENNIS LESTER 1724 BOUNDARY AVE TOWNSEND DIANE KAY 6721 COLUMBUS TOWNSEND JAMES CHARLES 1796 HUBBARD TOWNSEND JOHN CHARLES 315 16TH AVE SE TOWNSEND JOHN CLENDENI 418 E 26TH ST TOWNSEND MICHAEL LEE 4112 W 110TH ST TOWSLEE DIANE MARIE 815 13TH AVE SE TOYLI MICHAEL JOHN PIONEER HALL TRAASETH CURT LAVERNE FRONTIER HALL TRACH ELLIOT IRWIN 4700 MINNETONKA BLVD TRACH LAUREL ANN 2531 KIPLING AVE TRACHSEL LAWRENCE PAUL 1119 E 5 ST TRACY CLARENCE JOSEPH CENTENNIAL HALL TRACY DENNIS JAMES 814 8TH ST SE TRACY EDWARD MICHAEL 2181 N HARLINE TRACY KATHRYN MARY 1896 NORFOLK TRACY MICHAEL LOUIS 2089 ELEANOR TRAEGER DOUGLAS JOHN 940 FRANKLIN TERRACE TRAGETHON GRANT ALLAN 6939 3RD AVE SO TRAHMS MARGARET KAREN	68 GC 331-8022 MPL ROCHESTER 68 NURS 331-7117 MPL LONSDALE 70 CLA 473-2221 WAY WAYZATA 69 CLA 724-9323 MPL MINNEAPOLIS 71 DULTH 879-5343 CLOQUET 71 CLA 920-6437 MPL MINNEAPOLIS 70 DULTH 722-6240 DULUTH 70 CLA 473-6715 WAY WAYZATA 70 CLA 646-3367 STP ST PAUL 71 DULTH 624-0148 DULUTH 70 CLA UN9-4017 RHF RICHFIELD 68 GC 644-1325 STP ST PAUL 70 CLA 869-6361 MPL MINNEAPOLIS GRAD 335-1001 MPL 70 CLA 881-7394 BLT BLOOMINGTON 68 ED MPL CLOQUET 69 BUS MPL PALISADE 71 CLA 331-6400 MPL HAYFIELD 69 CLA WA6-6002 SLP ST LOUIS PARK 71 CLA SLP ST LOUIS PARK 71 DULTH 724-3260 DULUTH GRAD 339-7421 MPL INTERNAT FALLS 69 IT 331-6725 MPL HOUSTON 68 MORSC 631-0056 STP ST PAUL 71 CLA 699-3733 STP ST PAUL 68 GC 699-7139 STP ST PAUL 68 CLA 335-2547 MPL ROCHESTER 68 CLA 869-8792 RHF RICHFIELD 70 CLA JANESVILLE GRAD	68 CLA 881-0655 BLT BLOOMINGTON 69 CLA 722-0030 MPL NORTHFIELD 70 AGFHE GRAD	69 MORRS 589-4693 OWATONNA 71 VET M STP MEDFORD 70 CLA 722-8179 MPL MINNEAPOLIS 71 CLA 722-8179 MPL MINNEAPOLIS 68 ED 366-0861 STP MINNEAPOLIS GRAD 336-0861 MPL GUELPH 71 CLA 822-1892 MPL MINNEAPOLIS 68 CLA 825-8657 MPL MINNEAPOLIS GRAD 339-7421 MPL BRONX NY 70 CLA MPL BLOOMINGTON GRAD 71 CLA	70 CLA 429-6865 WTB WHITE BEAR LAKE GRAD MPL KANSAS CITY MO GRAD 890-5626 KANSAS CITY MO 70 PHARM 331-1326 MPL AITKIN 68 ED	AS CLA 339-6250 MPL RACINE 71 CLA 784-1705 SKP SPRING LAKE PK GRAD 68 GC MPL WASH DC	TRAXLER ROBERT LEE BREWSTER HALL TRDAN MICHAEL ARTHUR 5028 ALDRICH AVE NO TREANGEN DIANE FAYE	70 AGFHE STP LE CENTER 70 CLA 529-3082 MPL MINNEAPOLIS 70 AGFHE	TREAT CRAIG PHILIP 6709 16TH AVE SO TREAT DANIEL PIERCE 1122 COMO AVE SE TREAT RUSSELL ROE 1120 E 9TH ST TREBNIICK PHILIP STEPHE 2014 3RD AVE S TREBNIICK SHERRY MILLER 2014 3RD AVE S TREDAL STEVEN MOORE 2055 E HWY 36 TREECE JAMES WILLIAM J 1809 E 41ST ST SO TREESIE JULIE KAYE 520 WASHINGTON AVE SE TREIBER FRED AUGUST 1200 NE HWY 100 TREICHLER DAVID LAUREN 315 19TH AVE SE TREISE JUDITH ANN 1620 FREMONT TREMANN CHARLES FREDER 4823 HIGHBURY LN TREMEL JON THOMAS	69 GC 869-5804 RHF RICHFIELD 71 VET M MPL BURLINGTON VT 70 DULTH BIG FALLS 68 CLA 335-7088 MPL GRAND RAPIDS 70 CLA 335-7088 MPL DEER RIVER 70 CLA 777-8402 NSP NORTH ST PAUL GRAD MPL 70 ED MPL MONTEVIDEO AS IT 788-5002 MPL FARMINGDALE NY 70 AGFHE 331-3974 MPL BLOOMINGTON 69 CLA 774-2668 STP ST PAUL 69 DENT 938-5314 HOP HOPKINS 68 BUS	71 CLA 724-7273 MPL BLOOMINGTON 70 MORRS 589-3121 ANOKA 68 AGFHE 869-0754 RHF AS CLA 333-7829 MPL 69 CLA 333-5829 MPL GERMANY GRAD 227-8371 WSP 70 VET M 724-0820 MPL MINNEAPDLIS 69 UCOL 644-0003 STP FOREST LAKE 68 GC 825-4779 MPL MINNEAPOLIS 70 CLA 926-0531 MPL MINNEAPOLIS 69 CLA	68 AGFHE 331-6023 MPL BOWLUS 69 DULTH THF RIVER FALLS 69 DENT 721-6080 MPL RICHFIELD 70 AGFHE 644-5704 STP ST CLOUD 70 CLA 866-1348 MPL MINNEAPOLIS GRAD 645-6543 STP MITCHELL SD 71 CLA 722-0905 MPL MINNEAPOLIS 68 ED 331-4772 MPL LONG PRAIRIE 68 LAW 331-4772 MPL GROSSE PT FM MI AS CLA MPL AURORA 71 IT GRAD MPL PURI 70 CLA 331-5176 MPL BUFFALO 71 CLA 451-6563 STP ST PAUL 68 VET M MPL SPARTA WI 69 GC 745-6932 MPL MINNEAPOLIS 69 IT BELGRADE 69 CLA 866-1444 MPL MINNEAPOLIS GRAD 729-5008 MPL BELGRADE 71 CLA 781-8827 MPL MINNEAPOLIS 68 DULTH VIRGINIA 71 CLA 789-6593 MPL MINNEAPOLIS 70 IT	68 MORRS HENNING 70 AGFHE 645-1929 STP DUMONT GRAD MPL MINNEAPOLIS GRAD LI5-1234 GDV 69 DT 721-4507 FTS
---	--	---	---	--	---	---	-------------------------------------	-------------------------------------	--	---	---	---	---------------------	----------------------	-------	--	---	---	--	---	--	---	--	---	--	---	---	--	--	--	--	--





UPLINGER JANE HAY ALLT 68 CL 48 27TH AVE SE 801-4832  
UPPGREN ESTELLE BANCRO 801-4832  
UPWOOD JOHN HENRY 68 GC 935-9604  
1125 HIAWATHA  
URAM NANCY LOUISE 70 CL 645-2094  
2386 BUNDFORD AVE  
URAN BERNARD CARLILE 68 AGFHE M15-8231  
1475 NO CLEVELAND AVE  
URBACH JOHN WILLIAM 70 AGFHE 644-7137  
1928 NO SNELLING  
URBAIN CATHEEN MARIE 69 CL 689-1485  
2119 5TH ST SO  
URBAN BERNHARD JOHN 68 GC 767-2627  
4011 HUBBARD AVE NO  
URBAN JUDITH ANNE DIX 69 NURS 331-9155  
614 HURON ST SE  
URBAN MARGARET ANN 71 CL  
SANFORD HALL  
URBAN PAULA MAY 68 ED 825-0480  
5853 SO GIRARD CT  
URBAN SUSAN ELIZABETH 71 CL 226-9202  
378 SO OSCEOLA AVE  
URBANK JEAN REINE AS MED 333-2940  
121 MALCOLM AVE SE  
URBANSKI CLEMENS ANDRE 69 GC 488-4423  
1148 W CALIFORNIA  
URBANSKI CURTIS GENE 69 GC  
235 W IVY ST  
URBANSKI GERALDINE JOY 68 DULTH 722-6416  
221 W PITTSBURGH AVE  
URBANSKI WILLIAM JOHN GRAD 646-4434  
1262 VAN BUREN AVE  
URBANYI SOPHIA EVA AS CL 721-7355  
2315 30TH AVE SO  
URDANEFA LUIS FERNANDO GRAD  
  
UREN FREDRIC MAURICE 71 CL 488-7004  
272 ROMA AVE  
UREN JAMES WESLEY JR 69 DULTH 724-2872  
2005 E 9TH ST  
UREN THOMAS JOHN 70 AGFHE 645-7605  
1808 EUSTIS ST  
URGO MICHAEL VINCENT 70 CL 633-3535  
960 11TH AVE NW  
URIAH SORINDRO BNASAN AS AGFHE 332-9852  
1507 UNIV AVE SE  
URICK CARL EDWARD 69 DULTH  
2026 E 1ST ST  
URICK LARRY JAMES 69 DULTH 265-6133  
1027 ARROWHEAD RD  
URIE DEBORAH ANN 71 DULTH 722-8269  
2409 CHAMBERSBURG AVE  
URKE BRENDA LEE 70 MORRS  
P O 74 U OF MINN  
URMAN DUANE JOHN 71 AGFHE 222-6972  
936 ST CLAIR AVE  
URNESS GARY ALLAN 70 CL  
KENYON  
  
URRVTIA RAFAEL VICTOR AS MED  
  
URSEL OWEN VAUN 68 CL 721-1880  
3900 24TH AVE SO  
URSETH MICHAEL PETER 71 CL 929-8058  
2757 KENTUCKY  
USALIS KATHRYN FRANCES 68 CL  
STP MELROSE PK IL  
USAN SHELDON MERL 69 DULTH  
142 CALVARY RD  
USHERWOOD JULIA ANN 69 ED 935-5067  
5608 LTDY RD 18  
UTECH LINDA MARIE 71 CL 771-4724  
1135 KENNARD  
UTECH ROBERT WILLIAM 71 DULTH 879-4384  
2303 SAHLUMAN AVE  
UTECH GREGORY ROBERT 71 CL 881-5051  
8717 OXBOROUGH AVE  
UTLAUT ROBERT LOUIS GRAD  
  
UTNE ERIC JON 68 IT  
1426 SO 3RD ST  
UTNE JAMES HUNTINGTON 68 BUS 331-5941  
1206 5TH ST SE  
UTNE MARJORIE LOUISE 70 CL 645-4340  
1806 NO PASCAL  
UTNE THOMAS CARL 71 CL 227-5564  
TERRITORIAL HALL  
UTOF JOHN RICE 71 DENT  
PIONEER HALL  
UTT WALTER KENNETH GRAD  
  
UTTER TIMOTHY PHILIP 71 CL 926-0583  
3505 W FULLER ST  
UTTERBERG RICHARD NORM 68 IT 455-8467  
35 HAYS AVE  
UTTERMARK BRUCE ARDEN 68 BUS 336-5026  
1810 WASHINGTON AVE SO  
UTTERMARK JOHN ALLEN 69 IT  
  
UTTLEY JAMES PALEMON 68 CL 824-0953  
3450 DUPONT AVE SO  
UTTLEY MARGARET TAYLOR 70 CL 926-0680  
4101 ZENITH AVE SO  
UTTLEY THOMAS DANIEL 69 CL 926-0680  
4101 ZENITH AVE SO  
UTZ JOHN HENRY 68 IT  
FULDA  
  
VAALA JOHN OSCAR 69 MORRS  
407 E 2ND APPELTON  
  
VACINEK JAMES FRED 68 AGFHE  
  
VACK JOHN HARVEY 70 CL  
503 6TH ST SE  
VACURA MEREY LOUISE 69 NURS 331-5205  
415 ERIE ST SE  
VADIES EUGENE E 68 CL 537-9548  
3700 55TH AVE N  
VADIS DAVID LAWRENCE 70 CL 781-4629  
692 LOWRY AVE  
VADNAIS DEBORAH SUE 71 CL  
PIONEER COURT  
VAGLE ARNOLD NICHOLAS 68 AGFHE  
1998 BREWSTER ST  
VAGLE FREDOIE CORDELL 70 CL  
3709 15TH AVE SO  
VAGLE KEITH JOSEPH 71 CL  
TERRITORIAL HALL  
VAGTS WAYNE JOHN 68 IT  
636 ERIE ST SE  
VAIDICH MARY THERESE 68 ED 451-8260  
832 5TH AVE SO  
VAILL STANLEY T AS CL 927-9678  
5019 BRUCE AVE  
VAILLANT JOHN PATRICK 68 BUS 7A2-3412  
4917 ALDRICH AVE SO  
VAINEO CHERYL LEE 70 DULTH 879-3979  
RT 2 BOX 57A  
VAINEO SHARLA ANN 69 DULTH 879-3979  
RT 2 BOX 57A  
VAITKUS RIMANTAS LEONA GRAD  
2020 PILLSBURY AVE S  
VAJCMER ALEXANDER F GRAD  
  
VAKE ROGER LEO 68 DULTH  
BABBITT GRAD  
  
VAKOS HARRY NICHOLAS 71 CL  
MPL MINNEAPOLIS GRAD 246-4059  
  
VALDER REBECCA ANN 71 CL  
3605 17TH AVE SO  
VALDES MURIEL LAVONNE GRAD 373-5118  
NORTH SHORE DR  
VALDEZ JESUSA VILLANOS GRAD  
QUEZON CITY  
  
VALDOVINOS GLADYS MARY 69 CL 922-0031  
4621 YORK AVE SO  
VALEK CHRISTINE ANN 70 CL 698-4792  
395 SO HAMLINE STP ST PAUL  
VALEN DIANE LORRAINE 70 CL  
2118 MANITOU AVE STP ST PAUL  
VALENCIAND JANE SAARI 68 AGFHE 338-8038  
2827 9TH ST SO  
VALENTA JOSEPH CLYDE 70 VET M 484-7010  
2599 LEXINGTON PKWY STP SURING WI  
VALENTINE ROGER HENRY 71 CL 484-4743  
2140 DULUTH PL  
VALENTINE RUSSELL LEE 69 GC  
MAPLEWOOD  
  
VALENTINETTI JOSEPH 70 CL  
232 1/2 S SNELLING AVE STP  
VALENTO BRIAN JAMES 69 GC  
506 NO LEXINGTON  
VALES JAMES PETER 71 IT  
4019 FREMONT NO  
VALESKA DOROTHY ROSE 71 CL 331-5289  
1004 ESSEX ST SE  
VALIUKAS GUORUN 71 AGFHE 776-6897  
239 SKYWAY DR STP ST PAUL  
VALKEVICH JAMES MICHAE 68 IT 338-2249  
409 UNIV AVE SE  
VALLE RAFAEL FIGUEROA 71 CL  
GRAD  
  
VALLEJO BARBARA ANN 71 CL 560-6065  
4628 5TH ST NE  
VALLEY DONALD BRUCE 71 CL 429-4448  
2048 FLORAL DR  
VALLIE LAURENCE ANTHON 69 DULTH 722-6076  
13 W 8 ST  
VALLIE WILLIAM JAMES 70 DULTH 724-8080  
801 E 6TH ST  
VANAKIN EVERETT FRANK DULUTH  
CENTENNIAL HALL  
VANARMAN STEVEN CARL GRAD 339-7421  
130 WREN AVE  
VANASEK RICHARD JAMES 71 DULTH 722-6934  
DULUTH  
  
VANASEK ROBERT EDWARD 69 MED  
NEW PRAGUE  
71 CL  
NEW PRAGUE  
  
VANBAELEN JOMAN ALFONS GRAD  
930 15TH AVE SE  
VANBALLEMBERGHE VICTOR 68 IT  
1864 ARONA AVE  
VANBEEK ALLEN LESTER 68 MED 869-1043  
1600 77TH ST E  
VANBEEK PERRY EDWIN 68 AGFHE 646-3554  
1630 EUSTIS ST  
VANBERGEN PETER GEORGE 70 CL 938-9112  
6416 MALONEY AVE  
VANBROEKE LINDA LOUISE 70 CL  
HOP HOPKINS  
SIoux FLS SD  
  
VANBUSKIRK JAMES DEAN 69 CL 489-7054  
286 N MCCARRONS BLVD ROY ROSEVILLE  
VANCE MARY LINDA 70 CL 777-9519  
2486 E 16TH AVE  
VANCE SUSAN MARY 71 CL 429-1236  
2170 RANDY  
VANCISE KENNETH LEIGH STP ST PAUL  
CENTENNIAL HALL  
VANCLEAVE JAMES NEWTON 68 IT  
754 LIGHTNER PL  
70 CL 226-6985  
STP ST PAUL  
  
VANDAKE BRUCE FRBDRIC 71 CL 544-1851  
3656 DECATUR NO  
VANDAMME DOUGLAS MICH 70 PHARM 373-6510  
326 TERRITORIAL HALL  
VANDEGARDE ARLIS FAYE 68 ED 823-3837  
3130 PILLSBURY APT 206  
VANDEGARDE GERALD ALAN GRAD 823-3837  
3130 PILLSBURY AVE SO  
VANDELAARE JUDY ANN 71 DULTH 727-6636  
914 E 2ND ST  
VANDELLEN ADRIAN FRED 68 VET M 116-1908  
2223 KNAPP ST  
VANDELLEN GARY ALBERT 69 AGFHE 646-1908  
2223 KNAPP ST  
VANDEMARK SARAH JANE 68 CL  
STP LAKEVILLE  
  
VANDENBERG DOUGLAS L 70 DULTH 624-1584  
4 ALICE ST  
VANDEBERG KIM 68 CL  
PROCTOR  
  
VANDENBERG MARGARET LO 68 ED 377-4721  
1725 MORGAN AVE S  
VANDENHOEK ROBERT JOHN 70 CL 338-4145  
2200 PILLSBURY SO  
VANDERAU MADINE JOYCE GRAD 333-2161  
COMSTOCK HALL  
VANDERGRIFT JOHN JEFFR GRAD 336-5480  
315 UNIVERSITY AVE SE  
VANDERHAGEN ANNETTE LO 70 MORRS  
GAY HALL  
VANDERHOEK JACK YEHUDI AS CL 332-6835  
2101 27TH AVE SO  
VANDERHOEK RACHEL MYBR AS CL 332-6835  
2101 27TH AVE SO  
VANDERMYDE MARY LOUISE 68 NURS 789-6309  
2514 BENJAMIN ST NE  
VANDERPOOL THOMAS EARL 70 IT  
  
VANDERSCHAEGEN PHILLIP GRAD  
STP  
VANDERSLUIS CHARLES WE 68 CL  
HAMLINE UNIVERSITY BEHIDJI  
VANDUSEN DEBORAH ANN 71 CL  
SANFORD HALL  
VANDUSEN JANE KATHERI 71 CL 866-9219  
7221 10 AV SO  
VANDEVOORT LEROY ALLE 70 IT  
  
VANDOVER LAMONT K 68 CL 739-7767  
809 BARTELY  
VANDUSEN PATRICIA LYNN 68 ED 545-7123  
7080 GREEN VALLEY RD  
VANDUZEE NICHOLAS CHAR 68 ED 331-3614  
1109 6TH ST SE  
VANDUZEE REGINA EBBESE 70 IT  
STP LAKEVILLE  
GRAD  
  
VANDYKE GLORIA MARILYN 70 DULTH 727-4001  
6875 LAVAQUE JCT RD  
VANDYKE WILLIAM GRANT DULUTH  
1125 5TH ST SE  
VANDYKEN NANCY 68 CL 331-2792  
SANFORD HALL  
VANEECK VICTOR CHARLES 70 CL 373-6644  
CENTENNIAL HALL  
VANEK CONSTANCE THERES 69 CL 373-6544  
1791 DUNLAP ST  
VANEK RICHARD MELVIN 69 CL 373-6156  
PIONEER HALL RM 911  
VANENGELENHOVEN DAVID 69 CL 788-1765  
712 47TH AVE NE  
VANEPPS STANLEY HEATH 69 AGFHE  
BAILEY HALL  
VANESSENDELFT WILLIAM STP GRAND RAPIDS  
GRAD  
  
VANGELDER PETER WHITNE GRAD 331-3253  
41 MELBOURNE AVE SE  
VANHOEVEN ROBERT FRANKLIN 69 CL  
GRAD  
  
VANGUILDER BARBARA GLA 71 DULTH 729-7516  
7624 LAVAQUE RD  
VANGUILDER MICHAEL PAT 68 GC 225-2181  
40 E WYOMING ST STP ST PAUL  
VANHAUER JAN 71 CL JUB-1253  
3905 GOLDEN VALLEY RD  
VANHAUER PETER 69 DULTH  
219 N 2ND AVE E  
VANHEE JAMES OBAN 69 MORRS 589-1982  
324 UNIVERSITY AVE  
VANHEEL LEON WALTER 68 GC 522-6963  
4131 RUSSELL NO  
VANHEUVELN RICHARD JOH 68 CL 331-1335  
1609 UNIVERSITY AVE SE  
VANHOEFEN LLOYD ARTH 69 CL  
GRAD

VANMAN JOYCE MARIE 68 CLA 545-8662  
11414 B HWY 55  
VANMAN MAJSIRI 70 CLA 545-6876  
2410 HEMLOCK LANE  
VANNEIER JOHN PETER 69 GC 439-1166  
226 E MYRTLE ST  
VANN ARLENE THERESA 69 GC 724-5078  
705 DAYTON  
VANN BARBARA ELAINE 70 DULTH 724-5078  
24 GARDEN ST  
VANN JAMES DELBERT 71 CLA 771-5482  
1655 E HOYT  
VANN MARSHA ARNOLD 71 CLA 729-8706  
3504 SNELLING AVE SO  
VANNELLI JAMES JOSEPH 68 GC 227-2346  
334 DALY ST  
VANNELLI MARY JO 68 CLA HUB-3183  
996 VAN BUREN AVE  
VANNOSTRAND DAVID MICH 70 CLA 554-0926  
1650 TEXAS AVE SO  
VANO JOSEPH JULIUS 68 IT 331-1020  
2713 DELAWARE ST SE  
VANORDEN DENNIS JAMES 70 CLA 331-7824  
727 15TH AVE SE  
VANOSS JOSEPH PATRICK 68 GRAD 922-2065  
4101 ST JOHNS AVE  
VANOUSE DONALD PAUL 68 GRAD 335-8382  
515 5TH AVE SE  
VANOUSE EVELYN HAWTHOR 68 GRAD 335-8382  
515 5TH AVE SE  
VANOVERBEKE JUOITH LOE AS ED  
VANOVERBEKE LYNN MARY 69 AGFHE 373-6740  
771 SANFORD HALL  
VANOVERBEKE PAMELA DOR AS CLA  
800 UNIVERSITY AVE  
VANRAENDONK KAETHE KER 70 ED  
VANROEKEL JANE ELLEN 69 MEDTC 333-2161  
233 E COMSTOCK HALL  
VANROSSUM EILEEN ANN 71 CLA 339-0931  
SANFORD HALL  
VANRYSNYK GARY JON 68 IT 336-9475  
723 5TH AVE SE  
VANRYZIN MARY TARNOVSK AS DULTH 724-1347  
218 S 28 AVE E  
VANSCOY GARY JOSEPH 70 IT  
VANSELOW VICKIE RENEE 71 AGFHE 561-2528  
5937 EMERSON NO  
VANSELUS MARY OETTINGE AS CLA 529-4295  
2435 ILION AVE  
VANSICKLE CHARLOTTE JA 68 DENHY 331-2078  
833 E RIVER RD  
VANSICKLE DELWIN PETER 70 IT 338-9752  
925 6TH ST SE  
VANSLINGERLANDT ELISA 69 PHARM 522-1708  
1410 EMERSON AVE NO  
VANSLOOTEN STEVEN JOHN 70 MORRS 589-3131  
RT 3  
VANSLUYTER CHARLES KIM AS PH 331-4232  
708 FIFTH ST SE  
VANSLYKE WILLIAM STEPH 69 DULTH 724-9804  
GRIGGS HALL A316  
VANSTEENKISTE DENNIS E 69 DULTH 624-2260  
3179 LINDAHL RD  
VANSTRUM WENDY JANE 71 CLA 373-6072  
442 PIONEER HALL  
VANTASSEL DAVID STERLI 69 CLA 537-6573  
5109 FLORIDA AVE NO  
VANUELFT REINHOLD WILH GRAD  
VANVALKENBURG JOYCE WI 70 AGFHE JU8-7402  
3458 ZENITH AVE NO  
VANVALKENBURG ROGER LA 70 AGFHE  
1008 LEXINGTON NO  
VANVICK RUSSELL THOMAS 71 DULTH 624-2669  
6011 NASHUA ST  
VANVICKLE CAROL JEANNE 69 GC 789-4911  
2018 TAYLOR ST NE  
VANVORST PAIGE 68 BUS 922-6704  
5612 IRVING AVE SO  
VANVUGT NOLA ANN 71 CLA  
8003 GEORGETOWN PK  
VANWERSCH HERMAN JOSEPH GRAD  
VANWHY CAROL BREESE 70 AGFHE  
VANWINKLE JOHN DAVID J 69 LA 646-0464  
22 RAYMOND PL  
VANWYNGARDEN GERALD 71 CLA 644-5255  
3445 NO CLEVELAND  
VANVY THOMAS JOHN AS GC  
VANZANDT LINDA KAMIN 70 CLA 690-1870  
1146 ST CLAIR AVE  
VANZANDT MARC 71 CLA 784-3365  
1950 VALLEY VIEW LN  
VARADACHARI VUGRAMAN C GRAD  
VARANI WILLIAM BERNARD 71 MED 331-1319  
325 HARVARD ST SE  
VARCO JAMES ALLEN 71 CLA 644-5255  
420 N MISS RIV BLVD  
VARCO JOHN DOUGLAS 69 ED 644-5255  
420 N MISSISSIPPI BLVD  
VARGAS ESTELITA OLIVA 68 GRAD  
1015 ESSEX ST SE  
VARGAS JOSEPH MARTIN 68 GRAD 488-0739  
996 NO GROTTO  
VARGO AUDREY J 71 DULTH 727-6636  
914 E 2ND ST  
VARIAN JANE MARIE 68 GC 579-3014  
1812 6TH ST NE  
VARMA CHANDRA MOHAN GRAD 373-5962  
SCHOOL OF PHYSICS  
VARNER DANIEL MADE 71 CLA 537-5648  
8116 NOID AVE NO  
VARNER GLORIA MCAULIFF 70 CLA 881-7666  
1618 E 89TH ST  
VARNER JOHN LAFAYETTE 71 CLA 588-5518  
3621 NOBLE AVE NO  
VARRIANO ELIZABETH MAY 68 AGFHE 645-8203  
2384 W LARPENTEUR  
VARRO JOHN THEODORE 69 AGFHE 224-2570  
333 COLBORNE ST  
VARIS CYNTHIA ANN 70 CLA 698-4096  
1435 ST CLAIR AVE  
VARS SANDRA JEAN 69 ED 698-0618  
501 BRIMHALL  
VASALY ANN CAROL 71 CLA 922-8756  
1717 W 99TH ST SW  
VASALY THOMAS CAMPION 69 CLA 922-8756  
1717 W 99TH ST  
VASECKA JUDITH JOHNSON 69 ED 331-6203  
325 8TH AVE SE  
VASECKA MARY MARLENE 70 CLA 560-4786  
5427 4TH ST NE  
VASECKA VERNON ROY 70 CLA 331-6203  
325 8TH AVE SE  
VASILE JEAN MARIE 70 DULTH 624-1825  
5817 HUNTINGTON ST  
VASIREDDI PRASAD S GRAD 338-1826  
1904 RIVERSIDE  
VASSAR DAWN GLORIA 70 CLA 224-1484  
1322 BIDWELL ST  
VATTER BARBARA AMY GRAD  
VAUBEL JOHN EDWARD 68 AGFHE  
VAUGHAN CHARLES EDWIN GRAD  
1248 GIBBS AVE  
VAUGHAN EDWARD EUGENE 69 AGFHE 484-8040  
2599 N LEXINGTON AVE  
VAUGHAN SHARON RICE 68 CLA 225-0115  
1000 GOODRICH AVE  
VAUGHN EDGAR DUNCAN 68 PH 929-1885  
3233 FLORIDA AVE S  
VAUGHN JANICE SUSAN SLP LOUISVILLE KY GRAD  
VAUGHN JOAN MARIE 68 CLA 331-4615  
801 UNIVERSITY AVE SE  
VAUGHN PEGGY ANN 70 CLA 633-3147  
3455 GLEN ARDEN RD  
VAUGHN SAMMY CHARLES 70 MORSC  
FRONTIER HALL  
VAUGHN TIMOTHY 70 CLA 333-2923  
401 19TH AVE S  
VAUPEL BRIAN 70 AGFHE  
VAURIO C EDWARD JR 68 MED TAZ-4136  
3939 CHICAGO AVE  
VAURIO STEVEN LEE 68 PHA 869-4437  
7508 PARK AVE SO  
VAUX DONALD LEO 69 LAW 373-6184  
PIONEER HALL  
VAUX WALTER GREGSON GRAD  
VAVOULIS ANASTASIA STA 68 ED  
VAVOULIS BEVERLY MORIT GRAD  
VAVRA DALE FREDERICK AS DULTH 724-3021  
1301 E SKYLINE PKWY  
VAVRICK DANIEL JAMES 69 IT  
VAVRICK THOMAS PHILIP 69 GC 929-8954  
6404 MTKA BLVD  
VAYDICH JOHN MICHAEL SLP ST LOUIS PARK  
FRONTIER HALL 71 ED  
VAYDICH LAWRENCE D 68 DULTH 626-1376  
214 W GARY ST  
VAYDICH MARCELLA ANN 71 DULTH 626-1376  
214 W GARY ST  
VEA ELYMAR VEA GRAD 644-9803  
1504 FULHAM  
VEALITZKE DAVID JON 69 CLA 724-6373  
4132 LONGFELLOW AVE SO  
VEALITZKE DENNIS PETER 69 CLA 331-2792  
1125 5TH ST SE  
VEATCH GEORGE EDWARD J GRAD  
VEBLEN SUSAN BEAVER AL 70 CLA 926-8627  
4858 IRVING AVE SO  
VEDI PARSHOTAM SINGH GRAD  
VEEDER DAVID AINSWORTH GRAD 331-4368  
719 7TH ST SE  
VEENHUIS EUGENE HERMAN 68 BUS 339-3983  
523 20TH AVE S  
VEERKAMP ALPHONSE ANTH 69 IT 941-3696  
7690 HERITAGE RD  
VEESENMEYER LINDA MARY 70 CLA  
1010 EDGERTON  
VEGEE STEPHEN CLIFFORD 70 CLA  
PIONEER HALL  
VEIGEL CAROL ANN 71 CLA 588-4495  
2640 ABBOTT AVE NO





VOIGT LYNN DIANE 71 CLA WELLS  
 VOIGT MAVIS AMERSON AS CLA 823-4934  
 4934 ALDRICH AVE S MPL  
 VOIGT PATRICIA LEE 69 CLA 333-2161  
 COMSTOCK HALL MPL AUSTIN  
 VOIGT PAUL STUART GRAD  
  
 VOIGT ROBERT SIDNEY AS CLA 823-4934  
 4934 ALDRICH AVE SO MPL  
 VOIGT STEPHEN WILLIAM 69 IT  
  
 VOIGT WAYNE ARTHUR 71 CLA 537-6234  
 3406 YUKON AVE N NHX NEW HDPE  
 VOITA DONALD ARDELL 69 CLA 447-2741  
 RT 1 BOX 319 PRL ST PAUL  
 VOJE DANIEL WILLIAM 71 IT 459-2371  
 1127 AURORA AVE SPP ST PAUL PARK  
 VOJE NANCY LEE 70 CLA 459-7371  
 1177 AURORA AVE SPP ST PAUL PARK  
 VOKATY ALAN LEO 70 CLA 739-8042  
 2293 STILLWATER AVE MPW MAPLEWOOD  
 VOKATY DWIGHT EVAN 71 CLA 739-8042  
 2293 STILLWATER AVE MPW MAPLEWOOD  
 VOLD KENNETH LEE 70 IT  
 THETA CHI 16TH AVE SE MPL WINDOM  
 VOLD RODERICK JAY 70 DULTH 834-4823  
 234 SOUTH AVE TWO HARBORS  
 VOLD DAHL SUSAN JANE 70 CLA  
 615 5TH AVE SE MPL WELLS  
 VOLGY THOMAS JOHN GRAD 336-2088  
 330 8TH ST SE MPL GRAND RAPIDS MI  
 VOLK DONALD MICHAEL 69 MED  
 972 BIDWELL ST WSP WEST ST PAUL  
 VOLK LYLE HARLAN 68 IT 339-7421  
 CENTENNIAL HALL MPL ST PETER  
 VOLK MARY KATHERINE 68 CLA 222-5693  
 972 BIDWELL ST WSP WEST ST PAUL  
 VOLK MIRIAM LEE 70 CLA 927-6244  
 4625 W 28TH ST SLP ST LOUIS PARK  
 VOLK THOMAS ANDREW 70 CLA 489-9449  
 1781 ALAMEDA RDV ROSEVILLE  
 VOLKART BRUCE RAY 70 IT  
  
 VOLKMAN GAIL JEAN 71 PHARM  
  
 VOLKMAN KENNETH ALLEN 68 GC  
 427 1/2 7TH ST SE MPL MINNEAPOLIS  
 VOLLMER GERALD ALLEN 68 GC  
  
 VOLLMER JANICE TURNER 68 MED 331-1810  
 515 FIFTH ST SE MPL CANTON CTR CT  
 VOLLMERS ESTELLE WALLA 68 ED 331-7009  
 1100 COMO SE MPL FARIBAULT  
 VOLLMERS LLOYD MILTON 70 MORRS 589-3121  
 BLAKELY HALL DUMONT  
 VOLTIN DOUGLAS ARTHUR GRAD FR7-7090  
 7 PENN AVE SO MPL MINNEAPOLIS  
 VOLTIN GARY MICHAEL 70 CLA  
 7397 SPRING LAKE RD MOV MOUNDS VIEW  
 VOLTIN RONALD FRANCIS 70 MED 561-4395  
 6001 KERES NO BRC BROOKLYN CENTER  
 VOLTZKE RICHARD ALLEN 68 DULTH 724-7853  
 2507 LONDON RD DULUTH  
 VOLZ GARY ARLEN GRAD 823-2580  
 2746 STEVENS MPL ROCKVILLE MD  
 VOLZ MARCUS DEAN 71 IT 331-7969  
 521 12TH AVE SE MPL MINNESOTA LAKE  
 VOLZ PAULETTE ANN 69 CLA 338-6191  
 2118 7TH ST SO MPL FROST  
 VOMACHKA ARCHIE JOEL 68 DULTH 728-1649  
 2131 E 4 ST MEADOWLANDS  
 VOMACHKA JONATHAN FRAN 71 DULTH  
 807 GRANDVIEW MEADOWLANDS  
 VOMACHKA MARY FRANCES 70 DULTH 728-2614  
 1815 CARVER AVE MEADOWLANDS  
 VOMHOF CARROLL GENE GRAD 459-2301  
 1516 JAMES ST SPP  
 VOMHOF ROGER EILERT 71 CLA 529-1725  
 4039 PENN AVE NO MPL MINNEAPOLIS  
 VON RUEDEN RICHARD CAR 70 DULTH 722-0142  
 6 E BLVD HINCKLEY  
 VONBEHREN JAMES ARNOLD 69 IT 454-1990  
 1742 JAMES ROAD MEY MIESVILLE  
 VONBLUECHER HELMUTH 70 VET M 646-4790  
 2060 CARTER AVE STP LONG LAKE  
 VONDELINDE RODNEY EARN 69 CLA 774-2732  
 1497 REANEY STP ST PAUL  
 VONDELINDE WARREN JERO 70 CLA 774-1511  
 1511 REANEY AVE STP ST PAUL  
 VONDERHAAR JOANNE BARB 70 CLA  
 COMSTOCK HALL MPL HIBBING  
 VONDERHAAR MARY ANNA 69 DULTH 724-9914  
 BURNTSIDE HALL 104 VIRGINIA  
 VONENDE DIANE MARIE 70 CLA  
 409 6TH AVE SE MPL OSSEO  
 VONENDE KATHERINE ALIC 69 CLA 331-3599  
 405 ERIE SE MPL MOUND  
 VONENDE PAUL JULIUS 71 CLA 588-9310  
 3211 ST MARGARET DR GDV GOLDEN VALLEY  
 VONESH ROBERT SILVERIU 69 CLA  
 CENTENNIAL HALL MPL HINSDALE IL  
 VONFAY MARILYN ADELE GRAD 935-2705  
 PD BOX 1341 MTV  
 VONFISCHER SANDRA LEE 70 CLA  
 514 14TH AVE SE MPL VIRGINIA  
 VONG MARY ANN 69 CLA 646-2129  
 1821 EUSTIS STP ST PAUL  
 VONGLAHN KAREN ELIZABE 71 DULTH 724-1939  
 2105 VERMILION RD DULUTH

WAGNER MARY ELIZABETH 71 CLA 455-5143 2317 WENTWORTH AVE WAGNER MICHAEL JOHN 68 GC	WAINIO JOHN DAVID 68 DENT 102 W DIAMOND LAKE RD WAINANEN AUDREY ELAINE 68 DULTH 724-8287 216 E 14 ST WAINANEN GERALD RAYMOND 71 DULTH 724-8287 216 E 14 ST WAINANEN LINDA SUSAN 70 DULTH 724-8287 216 N 14 AVE E WAINANEN LYNNE 70 AGFHE BAILEY HALL BOX 120 AN WAINANEN SHARON UKURA 69 DULTH 1350 LAVAQUE RD BX 11 WAISBROT ANTHONY JOHN 1491 PIPER DR WAISS STEFANIE MARSHA 2534 HUNTINGTON WAITE JAMES MARVIN 1110 6TH ST SE WAITE LYNDA LEE 6208 SO HALIFAX WAITE PAMELA MARIE 1201 EDGERTON ST WAITE THOMAS WALTER 824 ESSEX SE WAKEFIELD DONALD MICKE RT 3 BOX 584 WAKEFIELD ELIZABETH MA BAILEY HALL WAKEFIELD KEITH CHARLE FRONTIER HALL WAKEFIELD ROSEMARIE EL 622 W 3 ST WAKEFIELD SUSAN MARJOR GAY HALL WAKEFIELD THAD MILO TERRITORIAL HALL WAKEFIELD WALLACE PETE	68 DENT 774-3461 STP ST PAUL 71 IT 735-3036 STP ST PAUL 69 AGFHE 488-7402 STP ST PAUL 69 BUS MPL RED WING 70 CLA 377-0715 SLP ST LOUIS PARK 68 GC 473-3145 WAY HAYZATA GRAD 644-1772 STP MINNEAPOLIS GRAD 331-7572 MPL GRAD 377-1408 MPL ST PETERSBURG FL GRAD  WALKER BONNIE LOUISE GRAD  WALKER BRADLEY PRESCOT 71 DULTH 525-5080 5030 COLORADO ST DULUTH WALKER BRUCE MARLON 68 IT 1170 FIFIELD WALKER CHARLES SCOTT AS PH 789-4813 2501 LOWRY AVE NE WALKER CHERYL ANN GRAD HIBBING WALKER CONSTANCE DUNLO 69 GC 922-9381 5841 ST JOHNS AVE EDN EDINA WALKER DANIEL CHARLES 69 GC  WALKER DAVID PHILIP GRAD  WALKER DEAN SAMUEL 68 IT  WALKER DEWAYNE HAROLD 68 VET M 644-6238 1222 GIBBS AVE STP LAKE ORION MI WALKER DIXIE JR 70 CLA 5124 DANENS DR EDN EDINA WALKER FRANK LESLIE JR 69 MED 881-0833 8133 BLOOMINGTON FRWY BLT HOPKINS WALKER GREGORY ARTHUR 70 IT 1501 2ND AVE S MPL PENGILLY WALKER JAMES LAKE 71 CLA 14 OVERLOOK RD STP ST PAUL WALKER JAMES LAWERENCE 68 CLA 225-8950 1055 VIEW LN STP WALKER JAMES ROBERT 70 MED 331-1839 317 UNION ST SE MPL SARASOTA FL WALKER JILL MARIE 71 CLA 225-8950 1055 VIEW LANE MEV MIESVILLE WALKER JOHN STERNER 68 ED 331-4103 1036 6TH ST SE MPL WALKER KEITH LEO 69 ED WE8-1159 12010 LAKE ST EXT HOP HOPKINS WALKER KERN GORDON GRAD  WALKER LINDA LOU 71 CLA 724-6106 2913 1/2 31ST AVE SO MPL CRESCO IA WALKER LITA LUCILLE 70 CLA 339-1833 813 UNIV AVE SE MPL HAYZATA WALKER LOUISE MARIE 68 GC 825-3846 4433 LYNDALE AVE SO MPL MINNEAPOLIS WALKER RICHARD JOHN 68 GC 3511 LINCOLN ST NE MPL HOPKINS WALKER ROBERT ALVA GRAD 698-7291 223 MACALESTER ST STP WALKER ROBERT JERRY 68 IT  WALKER TODD LOWELL 70 CLA 866-7138 6245 VINCENT SO RHF RICHFIELD WALKER WANDA ELLEN AS CLA COLUMBUS OH WALKER WENDY 68 ED 941-2184 5124 DANENS DR EDN EDINA WALKNER PATRICIA FLORE 70 NURS 789-3097 3119 ULYSSES ST NE MPL MINNEAPOLIS WALKOWIAK CAROL JEAN 71 DULTH 624-3219 817 N 39 AVE W DULUTH WALKOWIAK DONALD BERNA 69 DULTH 624-5220 203 N 35 AVE W DULUTH WALKUP JOHN EVANS JR 68 CLA 1046 16TH AVE SE MPL WALKUP JOHN PRENTICE GRAD 922-6419 4609 ABBOTT AVE SO MPL CLERMONT FL WALL COLLEEN KAY 69 CLA 336-0565 34 ARTHUR AVE SE MPL ST PAUL WALL CURTIS LAWRENCE 69 GC 789-2502 3528 BELDEN DR STA ST ANTHONY WALL FAITH CECILE 70 CLA PIONEER COURT HALL MPL HAYFIELD WALL KENT DELL GRAD 331-3809 527 5TH ST SE MPL CLIFTON NJ WALL MICHAEL ROSS 70 CLA 784-5864 5425 QUINCY ST 784-5864 MOV MOUNDS VIEW WALL ROBERT ARNOLD 69 AGFHE COFFEY HALL STP MOUNTAIN LAKE WALL STEVEN JOSEPH 70 AGFHE 633-6681 1758 BRUCE AVE ROY ROSEVILLE WALL TERRANCE BLAINE 68 GC 459-4755 1524 LINCOLN AVE SPP SOUTH ST PAUL WALLACE BRUCE JAY 69 BUS 929-7995 2925 COLORADO AVE SLP ST LOUIS PARK WALLACE DAVID LLOYD 68 MED FE9-1383 60 MELBOURNE AVE SE MPL WALLACE DOUGLAS GRAD 336-9437 123 MELBOURNE AVE SE MPL	
WAGNESS WARREN JOHN 70 DULTH 724-9831 GRIGGS HALL A113 INTERNAT FALLS WAGNILD DALE OWEN 69 GC 729-8432 MPL MINNEAPOLIS WAGNILD GALEN WALTER 71 DENT 724-7780 4231 MINNEHAMA AVE SO MPL MINNEAPOLIS WAGNILD JEROME VALENTI 70 CLA 336-1968 2439 3RD AVE SO MPL MINNEAPOLIS WAGSTROM RUTH LILLY 68 ED 755-3442 10341 IBIS ST NW CNR COON RAPIDS WAGSTROM WALLACE EDWAR 71 CLA 776-7401 1658 E NEBRASKA STP ST PAUL WAGTSKJOLD MARY KRISTI 68 CLA 331-2745 329 OAK ST SE MPL CLOQUET WAHBA AZZA SOLIMAN ABD 70 CLA 645-6845 2024 COMMONWEALTH AVE STP UNITED ARAB REP WAHBA MAHMOUD AHMED MO GRAD	WAKIRIAK IRENE ANN 70 CLA 333-7940 660 SPRING ST NE MPL MINNEAPOLIS WAKSDAHL ROBERT EDWARD 70 DULTH 626-1026 1257 91 AVE W DULUTH WALBRAN MARGARET ANN 70 CLA 333-9285 311 10TH AVE SE MPL WALBRIDGE DONALD THOMA 71 DULTH 724-1294 3620 CRESENT VIEW DR NEW BRIGHTON WALBURG JAMES STANLEY 71 AGFHE 789-0311 1323 SKYWOOD LN MPL MINNEAPOLIS WALBURG LINDA MARIE 70 DULTH 728-3713 RT 4 BOX 404F DULUTH WALBURG STEPHEN WILLIA 70 CLA 825-3551 5505 14TH AVE SO MPL MINNEAPOLIS WALCH HERBERT NICKOLAS GRAD	WALCZAK DAVID PAUL 70 CLA 789-4762 541 36TH AVE NE MPL MINNEAPOLIS WALCZAK MICHAEL ROBERT 69 DULTH 525-3940 25 SO 5TH AVE E DULUTH WALCZYNSKI GREGORY JOH 68 DULTH 722-1365 2720 W SKYLINE PKY DULUTH WALCZYNSKI STEPHEN CHA 71 DULTH 722-1365 2720 W SKYLINE PKWY DULUTH WALCZYNSKI SUZANNE MAR 69 DULTH 722-1365 2720 WEST SKY PKWY DULUTH WALD DAVID ALLEN 68 IT  WALD FRANK RICHARD 68 ED 771-4198 1051 SUBURBAN STP ST PAUL WALD JAMES HAROLD 71 CLA 646-1298 1395 EDMUND AVE STP ST PAUL WALD LEON DAVID GRAD 784-4323 7426 BACON DR NE FRD WALD MICHAEL WILLIAM 70 CLA PA2-9655 2500 36TH AVE SO MPL WALD RAYMOND PHILLIP 69 GC 784-5298 8527 ELDOGADO ST NE BLA BLAINE WALD RICHARD ARNOLD 70 CLA 938-5724 138 6TH AVE NO HOP HOPKINS WALD ROBERT FRANCIS GRAD MPL KANLSRUHE ND 1829 5TH AVE SO 70 CLA 521-0214 WALDER SANDRA GAIL 1723 SHERIDAN NO MPL MINNEAPOLIS WALDERA ARLEEN 68 GC 222-8351 1290 OTTAWA AVE WSP WEST ST PAUL WALDERA MARIJO 69 CLA CA2-8358 1290 OTTAWA WSP WEST ST PAUL WALDMAN BARBARA EVE 69 ED 698-5111 2084 BAYARD AVE STP ST PAUL WALDOCH DONALD RICHARD GRAD 488-4518 904 W ARLINGTON AVE STP ST PAUL WALDOCH LAURANCE RICHA 69 LAW 331-1660 1405 COMD SE MPL WALDOW GEORGE MYRON 70 IT LACRESCENT WALDRON JAMES RUSSELL 71 CLA FRONTIER HALL WALDRON ROBERT ALLEN 70 AGFHE 435-5265 15800 LYNDALE AVE S SAV SAVAGE WALEEN KATHRYN HARRIET 68 CLA 645-5064 1878 PORTLAND AVE STP ST PAUL WALERIUS THOMAS JOSEPH 69 GC 980 HAMPDEN STP ST PAUL WALERKO FRANK GRAD	WALES KAREN JO 69 CLA 699-4660 325 BRIMHALL STP ST PAUL WALES LEE ROBERT 68 MED 699-4660 325 BRIMHALL ST STP ST PAUL WALES LINDA ANN 69 CLA
WAIBEL MARTIN LEO 69 CLA 338-2375 725 8TH AVE SE MPL BIRD ISLAND WAIBEL THERESA MARY 68 CLA 529-7640 1301 VINCENT AVE N MPL MINNEAPOLIS WAIGHT JOHN ALBERT GRAD	WAIN JAMES WILLIAM 68 AGFHE 645-3312 1369 CLEVELAND AVE NO STP FLOODWOOD		

WALLACE KATHLEEN LOUIS 70 NURS 451-3329  
1812 PLEASANT AVE SO  
WALLACE KATHY JANE 68 GC 544-3491  
2425 ZANE NO  
WALLACE MARC JOHN  
  
WALLACE NOEL ANNE 71 CLA 331-6533  
1129 6TH ST SE  
WALLACE NORMA JEAN 71 CLA 823-6489  
3924 PARK AVE S  
WALLACE RONALD SHERMAN 70 CLA WA6-2036  
6616 BRITANNY RD  
WALLACE RUBY M AS CLA 633-5883  
1366 CUMMINGS LA  
WALLACE WILLIAM MEDLEY 71 CLA 339-5996  
603 5TH AVE SE  
WALLACH HOWARD S  
135 SEYMOUR AVE SE  
WALLAK FRANCES JEAN 70 CLA 339-2959  
204 5TH AVE SE  
WALLAK JUDITH KAY 70 CLA 339-2959  
204 5TH AVE SE  
WALLAT SCOTT CHARLES 71 CLA 561-5983  
1207 65TH AVE N  
WALLBLOM JONATHAN WALT 71 CLA 699-0259  
2005 STANFORD AVE  
WALLEN MARI BETH 68 ED 645-2115  
1767 THOMAS  
WALLEN DONALD F GRAD 724-1239  
1915 WOODLAND AVE  
WALLEN RICHARD ALEX GRAD 644-7072  
1989 KNAPP AVE  
WALLENTINE MARY SUSAN 71 CLA 866-6638  
6300 THOMAS AVE SO  
WALLER JACK KING AS GC 429-4020  
BOX 8624  
WALLER JEROME HOWARD GRAD 560-7661  
5437 BAKER AVE NE  
WALLER STEVEN ARNOLD 68 BUS 339-4179  
1806 16TH AVE SO  
WALLER SUSAN ALMA 70 CLA 339-0931  
SANFORD HALL  
WALLFRED STEPHEN PAUL 69 GC 822-5569  
4554 WENTWORTH AVE SO  
WALLFRED THOMAS BENNETT 70 CLA 822-5569  
4554 WENTWORTH  
WALLI GENEVIEVE MARIE 69 DULTH  
1517 E 4TH ST  
WALLIN DANIEL NEIL 69 DULTH 626-2320  
8743 ARBOR ST  
WALLIN DARYLL MARVIN 68 AGFHE 544-2815  
7927 BUCHANAN ST NE  
WALLIN DAVID DENNIS 69 CLA 729-4460  
5320 SHOREVIEW AVE SO  
WALLIN GERALD EUGENE 68 CLA 776-2531  
969 HUDSON RD  
WALLIN GREGORY STEVEN 70 CLA 789-5649  
634 19TH AVE NE  
WALLIN JUDITH KRISTIN 69 B10SC  
1197 ARONA ST APT 3  
WALLIN LLOYD ANTHONY 68 DENT 645-2928  
1752 LAUREL AVE  
WALLIN MARY LEE 71 CLA 922-2169  
5516 RICHMOND CURVE SO  
WALLIN MARY MARTHA 70 CLA 690-1648  
1443 GOODRICH  
WALLIN HILD CARL 68 GC 774-0101  
446 ENGLISH ST  
WALLIN SUSAN ANDERS RU 68 CLA ST1-1970  
1113 27TH AVE NE  
WALLIN TIMOTHY JOHN 69 GC 825-6657  
5425 PLEASANT AVE  
WALLIN WILLIAM MARTIN GRAD 729-8525  
5726 35TH AVE SO  
WALLINDER JANET MARIE 71 CLA 225-8098  
538 LAUREL AVE  
WALLINE JAMES MAURICE GRAD  
1642 EUSTIS ST  
WALLING ANDREA SCOTT B 68 CLA 929-5281  
4600 MERILANE  
WALLING GREG THOMAS 68 DENT 484-9564  
2599 N LEXINGTON  
WALLING STEVEN GREGORY 71 CLA 545-0747  
1335 WISCONSIN AVE NO  
WALLMAN SANDRA ELEANOR AS ED  
  
WALLNER ARTHUR GEORGE GRAD  
  
WALLNER JENNIFER JUNE 70 CLA 489-2739  
1499 SCHLETTI ST  
WALLNER JUDITH ANN 70 CLA 331-1491  
1316 7TH ST SE  
WALLRAFF MARK ALAN 69 GC 489-9242  
2001 ALAMEDA  
WALLS PATRICK GEORGE 70 CLA 935-3730  
231 MAPLE HILL ROAD  
WALLS RONALD WAYNE 69 LAW 484-7465  
2442 RICE ST  
WALLS VIRGINIA MARY GRAD 331-7820  
1112 4TH ST SE  
WALLSKOG LOUISE ELAINE 71 CLA 465-3674  
PIONEER HALL  
WALMAN PETER LOUIS 68 DENT 935-9239  
3101 XYLON SO  
WALMSLEY JOSEPH VINCENT GRAD  
505 8TH AVE SE  
WALMSLEY KAREN PEARSON GRAD 560-2590  
572 RICE CREEK TER  
WALONICK ALBERT L GRAD  
  
WALONICK DAVID STEVEN 71 CLA 938-4880  
715 OAKRIDGE RD  
WALRATH MICHAEL PHIPPS 70 IT 331-4262  
814 8TH ST SE APT 12  
WALROS JANICE BEVERLY 69 CLA 331-5206  
413 ERIE SE  
WALSER RICHARD JOHN 71 AGFHE  
WALSER ROBERT ANTON AS ED 784-0529  
2091 SHERWOOD RD  
WALSMITH HANNAH KRISTIN GRAD  
  
WALSMITH MICHAEL CHARLE 70 CLA 459-2669  
TERRITORIAL HALL  
WALSH BARRY JAMES MPL ST PAUL PARK  
1315 OLSON HWY GRAD 377-1034  
WALSH CHERYL LEE MPL WILLIAMSBURG VA 69 CLA 333-5788  
1018 UNIVERSITY AVE SE  
WALSH DANIEL JAMES MPL CHASKA  
PINE HALL 71 MORRS 589-3203  
WALSH DAVID ALBERT GRAD SHAKOPEE  
  
WALSH EDWARD PATRICK 71 CLA 699-8450  
1791 LINCOLN STP ST PAUL  
WALSH JAMES MATTHEW 70 IT  
  
WALSH JOHN JOSEPH 69 ED  
  
WALSH JOHN WILLIAM 70 CLA  
TERRITORIAL HALL MPL CHICAGO IL  
WALSH JOSEPH T GRAD  
1614 15TH AVE SO MPL TARRYTOWN NY  
WALSH KAREN ROSS 70 CLA 425-2021  
224 7TH AVE NE OSO OSSEO  
WALSH KATHLEEN JOYCE 71 DULTH 724-9992  
BURNSIDE HALL 192 CLOQUET  
WALSH KATHLEEN MARY 68 CLA 644-1351  
1705 DAYTON AVE STP ST PAUL  
WALSH LINDA CAROL GRAD 331-3878  
1312 4TH ST SE MPL FT WORTH TX  
WALSH MARK SHANE 69 CLA  
1015 8TH ST SE MPL WILLMAR  
WALSH MARY SHARON 69 MED 633-2923  
1401 FOREST LANE COURTLAND  
WALSH MICHAEL JAMES 71 ED  
1705 DAYTON AVE STP ST PAUL  
WALSH MICHAEL PATRICK 68 MORRS 589-1918  
710 E 7TH MOORHEAD  
WALSH MICHELE PATRICIA 69 CLA 331-1674  
517 15TH AVE SE MPL WILLMAR  
WALSH NANCY JOANNE 69 ED 645-4200  
75 OTIS AVE STP ST PAUL  
WALSH PATRICK GERARD 68 IT 881-3624  
2013 W 89TH ST BLT BLOOMINGTON  
WALSH PATRICK LEO 70 LAW 474-7702  
230 MONROE AVE EXC EXCELSIOR  
WALSH ROBERT JOSEPH JR 68 IT  
  
WALSH RUTH HELGERSON L 69 ED  
  
WALSH SUSAN ANN 68 GC 869-5993  
7121 NEWTON AVE SO RHF RICHFIELD  
WALSH THOMAS EDWARD 68 IT  
  
WALSH THOMAS JEFFREY 70 IT 224-6173  
41 DOUGLAS ST STP ST PAUL  
WALSTAD HUGH EDWARD 68 CLA 336-5595  
2604 7TH ST SO MPL WILLMAR  
WALSTEAD RICHARD DANIE 70 CLA 522-2725  
4249 MORGAN NO MPL MINNEAPOLIS  
WALSTEAD SANDRA KAY 68 GC 588-6435  
2651 ZENITH AVE NO ROB ROBBINSDALE  
WALSTEAD THOMAS ANDREW 70 CLA 522-2225  
4249 MORGAN NO MPL MINNEAPOLIS  
WALSTEN MICHAEL JAMES 71 CLA 474-5672  
41 BOX 873 EXC EXCELSIOR  
WALSTER GEORGE WILLIAM GRAD  
  
WALSTROM CYNTHIA JEANN 69 DULTH  
811 23 ST CLOQUET  
WALSTROM JON LYMAN GRAD 729-0984  
3447 20TH AVE SO MPL MINNEAPOLIS  
WALSTROM MARILYN JEAN 68 CLA 331-4767  
1000 8TH ST SE MPL MINNEAPOLIS  
WALSTROM SUSAN JO 68 DULTH 741-8273  
222 DOUGLAS AVE EVEL  
WALSTROM THOMAS DONALD 71 IT 724-7910  
3317 MINNEHAHA AVE SO MPL MINNEAPOLIS  
WALTA DOUGLAS CRAIG 68 MED 331-1379  
325 HARVARD SE MPL BROOKINGS SD  
WALTER BERT 68 CLA 225-3451  
1009 FAIRMOUNT AVE STP ST PAUL  
WALTER PATRICIA CAROL 70 CLA  
PIONEER CT MPL BAYPORT  
WALTER PATRICIA CAROL 71 IT 890-1825  
12920 VIKING DR  
WALTER RICHARD CLARENC AS AGFHE  
  
WALTER SUSAN LYNN 69 GC 822-5051  
4953 DUPONT SO MPL MINNEAPOLIS  
WALTERS CHARLES KENT 71 DULTH  
I W S ST MCGRATH  
WALTERS CHARLES LEDNAR 68 GC 781-1234  
3234 HAYES ST NE MPL MINNEAPOLIS  
WALTERS FRANCES SLAGER AS MORRS  
  
WALTERS GREGORY JOHN 71 CLA 881-8134  
401 E PORTLAND PLACE BLT BLOOMINGTON  
WALTERS LINDA RAE 71 CLA 521-3307  
4642 DUPONT NO MPL MINNEAPOLIS  
  
WALTERS LYNDA KATHRYN 71 DULTH 724-6431  
1846 WALLACE AVE DULUTH  
WALTERS MARGARET MARY 68 CLA 869-9152  
1220 W 73RD ST RHF RICHFIELD  
WALTERS MAXINE MARY 69 GC  
  
WALTERS RICHARD JOHN 71 CLA 777-3692  
2742 APACHE RD NSP NORTH ST PAUL  
WALTERS RICHARD PAUL AS ED  
  
WALTERS SUSAN RACHEL 69 CLA 377-9748  
1785 LOGAN AVE SO MPL MINNEAPOLIS  
WALTERS TERENCE MICHA 71 IT  
FRONTIER HALL MPL ROCHESTER  
WALTERS WILLIAM ALDRIC 71 CLA 377-9748  
VA 1785 LOGAN AVE SO MPL MINNEAPOLIS  
WALTERS YVONNE BARBARA 69 GC  
  
WALTHER DIANE DELORES 70 CLA 776-8475  
147 MAPLE ST STP ST PAUL  
WALTHER JANET MARIE GRAD  
POWELL HALL MPL DES MOINES IA  
WALTHER JOHN WILLIAM GRAD 631-2577  
1363 W COUNTRY RD B STP ST PAUL  
WALTMAN LARRY EDWARD 71 DULTH  
DULUTH  
WALTON BEVERLY RAE 71 CLA 645-2061  
1741 N SNELLING ROV ROSEVILLE  
WALTON CATHERINE ELIZA 71 DULTH 728-1653  
2832 E SUPERIOR ST DULUTH  
WALTON CYNTHIA ANN 70 CLA 588-4297  
4040 WASATCH LN GOV GOLDEN VALLEY  
WALTON ELLEN GRACE SHE 69 CLA 588-4297  
4040 WASATCH LN GOV  
WALTON MARK LOUIS 68 CLA 645-2061  
1941 N SNELLING ROV ROSEVILLE  
WALTON NANCY KAY 69 CLA 825-0279  
4741 DUPONT AVE SO MPL MINNEAPOLIS  
WALTZ SANDRA LYNN 70 CLA 225-6210  
974 DODD RD WSP WEST ST PAUL  
WALTZ SR M VINCENT AS ED  
  
WALTZEK JILL MARIE 70 CLA  
COMSTOCK HALL MPL HIGHLAND PK IL  
MALUKIEVICZ SUSAN KAY 70 CLA  
SANFORD HALL MPL HALLOCK  
WALVATNE HARRIETTE LOU 69 ED 374-4287  
2643 IRVING AVE S MPL BATTLE LAKE  
WALZ GARY ALLEN 71 CLA 771-3922  
1091 WILSON AVE STP ST PAUL  
WALZ JUDITH CLARA 71 MORRS 589-4693  
SPOONER HALL WADBNA  
WALZ LEO JOSEPH 68 IT  
  
WALZ ROBERT GEORGE 68 CLA  
1203 8TH ST SE MPL ST PAUL  
WALZ RODNEY JEROME 71 IT  
  
WALZ STEPHANIE RUTH 71 CLA 929-6041  
3121 COLORADO AVE SO SLP ST LOUIS PARK  
WALZER ARTHUR EUGENE GRAD  
  
WALZER RICHARD LEE 70 CLA  
65 11TH ST SO MPL MINNEAPOLIS  
WAMBACH CATHERINE ANN 71 CLA  
SANFORD HALL MPL BENSON  
WANCZYCKI WLODZIMIERZ 69 IT 823-0535  
2901 KNOX AVE SO MPL MINNEAPOLIS  
WANDELL JAMES ARVID 70 DULTH  
1120 E 9 PINE CITY  
WANDERSEE GARY WAYNE 70 IT  
CENTENNIAL HALL MPL AUDUBON  
WANDERSEE ROSE MARIE 69 NURS 331-5679  
514 14TH AVE SE APT MPL COKATO  
WANDMACHER WAYNE EUGEN 68 PHARM 331-2041  
1015 ESSEX ST SE MPL HAGER CITY WI  
WANER ALLEN RUSSELL 68 IT 331-9831  
406 11TH AVE SE MPL WINONA  
WANG CHAO LING GRAD 331-5095  
1424 SE 6TH ST MPL NEWARK NJ  
WANG CHENGSHIN AS IT 560-3385  
701 RICE CREEK MPL TAITUNG  
WANG CHINSHIA GRAD  
670 CAPITOL BLVD BX 181 STP TAIPEI  
WANG DAVID MARK 68 BUS 338-6853  
707 UNIVERSITY AVE SE MPL MINNEAPOLIS  
WANG FRANCIS CHENGPING GRAD 331-9912  
1108 7TH ST SE MPL TAIPEI  
WANG ISHOU GRAD 338-5091  
1913 COLUMBUS AVE S MPL TAIPEI  
WANG JAMES PENGWEUI GRAD  
215 WALNUT SE MPL  
WANG JOSEPH HOWJYH GRAD  
MILLARD HALL MPL HONG KONG  
WANG KYUHUYUN GRAD  
  
WANG MICHELE NELSON FA 69 ED 338-6853  
707 UNIVERSITY AVE SE MPL PINE CITY  
WANG SHARON MAE 71 DULTH 727-6636  
914 E 2 ST BABBITT  
WANG SINN SHYONG GRAD 647-3375  
DEPT OF PLANT PATH STP TAMSUI  
WANG SUNGCHU GRAD  
  
WANG TINGCHUNG GRAD  
  
WANG WEIMING GRAD 331-2676  
1229 7TH ST SE MPL  
WANGAARD SUSAN KAYE RE 68 CLA  
1626 EUSTIS ST LAD

WANGEN ARDEN GLEN 1631 CARL WANGEN TERRY ALAN BLAKELY HALL WANGENSTEEN EDWIN FRED 1044 DOUGLAS RD WANGENSTEEN OVE DDUCLA 3720 MINNEHAHA AVE SO WANGENSTEEN WILLIAM K 5417 PARK AVE SO WANGERIN JANET LEA 900 E 78TH ST WANGLIE DAVID OLIVER 3646 KEXXES NO WANGSTAD ANDY HARVIN	69 B10SC STP OAKLAND 70 MORRS 589-3121 SARGEANT 71 AGFHE 454-4411 STP ST PAUL GRAD 721-3296 MPL ST PAUL GRAD TA4-3842 MPL MINNEAPOLIS 69 CLA 866-7641 RHF SUPERIOR WI GRAD 529-2054 MPL MINNEAPOLIS 69 BUS	WARDIN ROBERT PIERCE 3021 NO PASCAL WARDWELL JUDITH ANN 1026 SE 5TH ST WARE CYNTHIA LEE 676 SUMMIT AVE WARFORD DAVID THOMAS 8912 WALLY DR WARFORD JOHN HOWARD JR 1015 PIONEER HALL WARGIN WILLIAM ANTHONY 3718 DUPONT AVE N WARHOL HELEN GRANT ADE WARHOL KATHRYN LOIS 5428 46TH AVE SO WARHOL LYNDA LEE 2585 ALDINE WARHOL RICHARD MICHAEL WARHOL WALLACE WILLIAM 4920 40TH AVE SO WARK RENAE LAVERNE 4412 ARNOLD RD WARLING LOIS MARIE WARMACK WILLIAM DAVIES WARMANEN JUDITH JOANNE 1236 CIR TERR BLVD NE WARN DONALD THEODORE WARN E LUCILLE 615 SHURON W B L WARN EDWARD JOSEPH WARNBURG GARY THOMAS 7344 2ND AVE SO WARNBURG RUSSELL WILLI WARNOAHL LINDA LEE BURNTSIDE HALL 141 WARNE SUSAN MARGARET 905 LOWRY AVE NE WARNER ALAN TIB 2501 ARCADE ST WARNER BETTY LOUISE 701 19 AVE SO WARNER BONNIE GAY 619 UNIVERSITY AVE SE WARNER DAVID MAHER WARNER ELIZABETH ANNE 4616 LYNWOOD TERR WARNER FRANK JOSEPH 3824 COLUMBUS AVE SO WARNER JAMES CURTIS 1601 UNIV SE WARNER JULIANNE JANELL 4112 YATES AVE NO WARNER KENNETH LESTER 5655 HUMBOLDT AVE N WARNER LEON CHARLES 1617 UNIVERSITY SE WARNER LINDA MINNA SPOONER HALL WARNER MARY KATHERINE 6461 WESTCHESTER CIRCLE WARNER MERLIN LESTER WARNER PETER DAVID WARNER RICHARD ALLAN 1068 86 AVE W WARNER ROBERT LEE 5444 KNOX AVE N WARNER TERRENCE ALEX FRONTIER HALL WARNER VICTORIA LEE SANFORD HALL WARNER WOODROW CHARLES 30 W WABASHA ST WARNERT GLENN ANDREW 3112 EDWARD ST NE WARNES ROBERT ARNOLD 2823 27TH AVE SO WARNING LINDA KAY WARNKE CORRINE LUCILLE 3290 BAILEY RD RT 1 WARNCEN MARK GERARD 1173 FIFIELD ST WARNSHOLZ LOIS JEAN 497 UNIVERSITY AVE WARNYGGORA MARY LOU 1912 E 5 ST WARP DIANA LOIS 528 ONTARIO SE WARP JOHN MICHAEL GRIGGS HALL C214 WARPEHA WALTER STANLEY 814 ESSEX SE WARPULA LINDA ARLENE 895 EDMUND AVE WARREN BARTON JOHN 9001 NORTHWOOD CIR WARREN DAVID HARDY WARREN DONALD MICHAEL 2100 HARRIET AVE SO	GRAD 639-1469 ROV CEDAR FLS IA 68 CLA 335-4196 MPL ST PAUL 70 CLA 227-2353 STP ST PAUL 70 CLA L15-7352 GOV MCINTOSH 71 DENT 373-6174 MPL BEMIDJY 70 CLA 522-5984 MPL MINNEAPOLIS AS CLA 70 CLA 729-2603 MPL 70 CLA 633-2827 ROV ST PAUL GRAD 70 CLA 724-0990 MPL MINNEAPOLIS 71 DULTH 724-6435 DULUTH 68 GC 70 IT GRAD 788-1068 MPL MINNEAPOLIS GRAD AS AGFHE 429-5909 WTB 68 IT 71 CLA 869-4332 RHF RICHFIELD AS GC 71 DULTH 724-9914 68 ED 781-8943 MPL MINNEAPOLIS 70 CLA 484-8704 LTC LITTLE CANADA 69 CLA 338-1584 MPL ST PAUL 68 ED 335-8140 STP MAPLE PLAIN 69 IT 68 CLA 474-6421 MTV MINNETONKA 70 LAW 823-3439 MPL MINNEAPOLIS 70 CLA 331-7916 MPL BOYD 70 CLA 537-7788 ROB ROBBINSDALE 70 CLA 588-5332 BRC BROOKLYN CENTER 69 GC MPL WAYZATA 71 MORRS 589-4693 ELKTON SD 70 CLA 545-1213 GOV GOLDEN VALLEY 70 IT GRAD 68 DULTH 626-3016 DULUTH 70 CLA 588-4217 BRC BROOKLYN CENTER 71 CLA MPL DWATONNA 71 CLA MPL MINNETONKA 69 DULTH 724-6610 DULUTH 69 GC 789-5780 ST ANTHONY 69 GC 721-1117 MPL MINNEAPOLIS 69 GC 69 GC 459-9580 NMP NEWPORT 71 MED 646-8083 STP MINNEAPOLIS 70 CLA 222-1228 STP 71 DULTH 724-0309 DULUTH 69 MED MPL MINNEAPOLIS 70 DULTH 724-9813 MINNEAPOLIS 71 DENT MPL COON RAPIDS 70 CLA 225-8451 STP ST PAUL 68 GC 544-3266 NWM NEW HOPE GRAD GRAD 339-2004 MPL	WARREN DUANE J 4330 MINNEHAHA AVE SO WARREN HERMAN LECIL BREWSTER HALL WARREN JOHN ANTHONY 2037 SELBY AVE WARREN LYNDA WALKER AN 818 8TH ST SE WARREN MARK GUY 820 E 13TH ST WARREN RICHARD ALLEN 2606 CEDAR AVE SO WARREN RICHARD JAMES 1055 S CLEVELAND AVE WARREN TIMOTHY CHARLES BAILEY HALL WARRICK RICHARD JOHN 4636 FILLMORE ST NE WARRINER GILBERT HOWAR 1505 N CLEVELAND WARRINER WILLIS WELTON WARRINGTON MARK GEORGE 653 ERIE ST SE WARTCHOW JEFFREY CARL 7821 LYNDALE SO WARTERS MARY ELLEN WARTHESEN JOSEPH JOHN 1494 GRANTHAM ST WARTMAN JUDY KAY 204 W 4TH ST WARKICK CONNIE LOUISE CAMDEN HALL WARWICK HENRIETTA ORLA 1952 E RIVER TER WASBOTTEN THOMAS ALAN WASCHBUSCH EUGENE ROBE WASCOE LINDA ANNE 1530 VALDERS AVE WASHA DARRYL MILO 9319 CLINTON AVE SO WASHBURN JANET MAY 315 UNIVERSITY AVE SE WASHICK CAROLE HAJOWIK 1129 PAYNE AVE WASHINGTON CLAUDITH MA 1330 ST PAUL AVE WASHINGTON THELMA 717 UNIVERSITY AVE SE WASHNESKY MARY MARGARE 1022 E 4TH ST WASICK GREGORY JEROME 6221 LOGAN SO WASILK GAIL ANN WASILK ROSALIND THRSE 1850 CD RD C2 WASKO ROBERT JOHN WASKOSKY JEAN RENE 520 WASHINGTON AVE SE WASHMUND WILLIAM CLAREN 1022 E 4TH ST CENTENNIAL HALL WASOWICZ DONNA BENSON 5378 E BALD EAGLE BLVD WASS DAVID FRANKLIN WASS JUSTIN LEO 509 6TH ST SE WASSENAAR LINDA HANSON 4200 3RD ST NE WASSER DIANE ELAINE WASSER LEONARD NORMAN 3007 3RD ST N WASSERBURGER MARJORIE COMSTOCK HALL 219E WASSERMAN MARK STEVEN 1616 TEXAS AVE SO WASSMAN GARY LYNN BAILEY HALL WASSMAN JAMES STEVEN BAILEY HALL WASSMER FRANCIS HAROLD WASSON JOHN BRUCE WASSON JULIE MARIE SANFORD HALL WASSON KATHERINE ANN 1012 5TH ST SE WASTWEET DUANE DENNIS 2237 KNAPP ST WASYLAK PAUL STANLEY CENTENNIAL HALL WATCHMAN JOAN MARILYN 1354 LINCOLN WATERHOUSE ANN MARIE 700 10 AVE SE WATERLAND HIRAM THOMAS CENTENNIAL HALL WATERMAN BRUCE DALE 951 17TH AVE SE WATERMAN JOHN BRADLEY CENTENNIAL HALL WATERMAN JUDITH ANN 4104 22ND AVE S	69 GC MPL BLOOMINGTON GRAD STP TYLER TX 69 CLA 646-6707 STP ST PAUL GRAD 331-7683 MPL MOUNTAIN LK NJ 70 DULTH 724-0261 DULUTH 69 CLA 724-3004 MPL 68 CLA STP ST PAUL 70 AGFHE STP WOODSTOCK 69 GC 788-8232 CLM COLUMBIA HTS 69 AGFHE 646-3196 STP BRAHAM AS ED 70 CLA 331-7303 MPL AUSTIN 68 CLA 869-3296 BLT MINNEAPOLIS GRAD 70 AGFHE 644-9355 STP THEILMAN 71 MORRS 589-3731 MORRIS 71 MORRS 589-1030 WADENA GRAD 336-9156 MPL 69 DULTH AS ED 71 CLA 545-0630 GOV GOLDEN VALLEY GRAD 881-9133 BLT MONTGOMERY GRAD 338-4275 MPL ROCHESTER 68 CLA STP 69 CLA 698-8007 STP GRAD 335-2659 MPL BIRMINGHAM AL 70 DULTH 724-4462 DULUTH 70 CLA 869-8941 RHF RICHFIELD 70 AGFHE 70 CLA 633-7350 ROV ROSEVILLE AS ED 71 IT 331-3575 MPL MINNEAPOLIS 70 CLA MPL RED WING 68 ED 429-2263 WTB GRAD 68 MED 331-7041 MPL BIGBLOW 69 CLA 788-2595 CLM 71 AGFHE 70 AGFHE MPL MINNEAPOLIS GRAD 373-7171 MPL 71 CLA L15-3603 SLP ST LOUIS PARK 70 AGFHE STP ORMSBY 71 AGFHE STP ORMSBY GRAD GRAD 71 CLA MPL ALEXANDRIA 68 ED MPL ALEXANDRIA 70 AGFHE 644-0324 STP BAGLEY 69 CLA 339-7421 MPL DRACUT MA 69 GC 698-7179 STP ST PAUL 70 CLA MPL ROCHESTER GRAD MPL MINOT ND 70 DENT 331-8547 MPL ALBERT LEA 68 ED 339-7421 MPL LAMBERTON 69 CLA 724-1591 MPL MINNEAPOLIS
---	--	---	--	---	---

WATERMAN MYRNA CAROL 303 E 7TH ST WATERMOLEN JEFFREY JOH 3985 COLORADO AVE SO WATERMOLEN MARCIA JEAN 3985 COLORADO AVE SO WATERS JOHN JOSEPH 1974 BEECHWOOD AVE WATERS RICHARD STEVEN 4521 FLORIDA AVE N WATERSTON ANN KATHLEEN 5412 JAMES SO WATERSTON MARK CLAIR 4343 NICOLLET WATKINS CAROL ROSELIA 616 6TH ST SE WATKINS JAMES DAVID CENTENNIAL WATKINS JEAN AUGUSTA GRIGGS HALL N114 WATKINS JEROME ARTHUR  WATKINS JOHN F BOX 14014 WATKINS KATHLEEN JOY 519 3RD AVE SE WATKINS RICHARD HERBER 3328 OWASSO HGTS WATKINS STEVE FRANCIS  WATLAND JUDY MARIE 5132 14TH AVE SO WATLAND ROGER THOMAS 5335 41ST AVE SO WATNEMO LINNAB KAREN 914 E 2 ST WATRALL CHARLES RUODLP 2009 28TH AVE S WATRIN MARITA 1824 E 10TH ST WATRUD KAREN ANN 525 6TH AVE SE WATRY DANIEL MICHAEL 2111 GORDON ST WATSON ARTHUR LYNN  WATSON BENJAMIN FRANKL 624 HURON ST SE WATSON BETTY ELSE 3326 BRUNSWICK AVE NO WATSON BRUCE WINSOR 1815 UNIVERSITY AVE SE WATSON DALE MERYL TERRITORIAL HALL WATSON DOUGLAS FREDERI 1725 UNIVERSITY AVE SE WATSON EDWARD ALBERT  WATSON JANE FINLAYSON  WATSON JANE MARGARET 2352 WELLSWOOD CRU S WATSON JOHN ROBERT JR 1611 RIVER RD E WATSON PATRICIA CAROLE 2352 WELLSWOOD CURVE WATSON PEGGY LOU 6069 JAMES SO WATSON RICHARD ARTHUR 6069 JAMES AVE SO WATSON RICHARD DUANE 1841 FAIRMOUNT WATSON ROBERT BRUCE 2470 COMO AVE WATSON ROBERT GEORGE 5824 FRANCE AVE SO WATSON ROBERT LEE  WATSON ROBERT WAYNE GAY HALL WATSON STEVEN RICHARD 1821 UNIVERSITY AVE SE WATSON THOMAS ALLAN 5202 CHICAGO AVE WATSON WILLIAM DOWNING 318 8TH AVE SE WATSON WILLIAMINA AGNE COMSTOCK HALL WATSULA SHARANN LEE 1236 BRAINERD AVE WATT ADRIAN LEE 1924 E 7 WATT CAROL ANDREA 215 W GARY ST WATT GAIL HUBERT 2311 23RD AVE SO WATT NORMAN MAIRS  WATTENBERG RICHARD B 53 SEYMOUR AVE SE WATTERS CYNTHIA COMB M 137 BEDFORD SE WATTERS JOAN LORRAINE 752 LAUREL ST WATTS DANIEL MAURICE 612 DELAWARE SE WATTS JOHN ARTHUR 3928 OAKLAND AVE WATTS KENNETH FRANK	69 MORRS MONTEVIDEO 68 ED 929-8266 71 CLA SLP ST LOUIS PARK 71 CLA SLP ST LOUIS PARK 69 IT 699-6376 70 CLA STP ST PAUL 70 CLA 537-8304 69 GC CYT CRYSTAL 69 GC 926-5387 69 CC MPL MINNEAPOLIS 69 GC MPL MINNEAPOLIS 68 CLA 331-7225 69 BUS MPL BUTTERFIELD 69 MPL AUSTIN 69 DULTH 724-9832 70 AGFHE BRAINERD 68 IT MPL AUSTIN 70 CLA MPL WILLMAR 68 VET M 484-9281 71 DULTH 345-3275 70 CLA 824-6962 70 CLA MPL MINNEAPOLIS 70 CLA 722-2077 71 DULTH 727-6636 70 AGFHE BUHL 70 DULTH GRAD 339-2162 70 DULTH SANDSTONE 68 AGFHE 645-8011 69 IT STP ADRIAN 70 IT GRAD 331-4365 70 IT GRAD 533-4553 68 CLA 331-5986 71 IT MPL ST PAUL 71 IT MPL RED WING 68 IT 331-1326 70 IT MPL EDINA 71 ED 888-9073 69 CLA 335-1523 68 ED 888-9073 70 CLA 866-2476 70 CLA 869-0298 69 GC MPL MINNEAPOLIS 69 GC 698-9604 69 CLA STP GRAND ISLAND 69 CLA 644-7846 69 CLA STP ALLEN PARK MI 69 CLA 926-1966 69 IT EDN EDINA 71 MORRS 776-7081 70 CLA TRUMAN 70 CLA 331-5887 70 AGFHE 823-7944 70 AGFHE MPL MINNEAPOLIS 70 AGFHE 335-5857 68 ED MPL DORANGO CO 71 DULTH 373-7172 71 DULTH MPL EDMONTON 71 DULTH 724-7935 69 DULTH 626-1471 70 AGFHE 724-8563 69 DULTH MPL WARREN PA 69 CLA 333-8461 69 CLA MPL MINNEAPOLIS 70 DULTH 338-6859 70 DULTH 879-7714 70 CLA CLOQUET 70 CLA 339-7421 70 CLA MPL MINNETONKA BCH 70 IT AS GC 824-2086 70 IT MPL ROCK ISLAND IL	68 ED 339-3342 69 CLA 333-4527 69 LAW 926-0795 68 LAW 644-8747 68 GC 824-7504 70 CLA MPL MINNEAPOLIS 71 IT MPL BRAHAM 70 CLA 922-9207 70 CLA MPL MINNEAPOLIS 69 CLA MPL NEW ULM 70 CLA MPL OWATONNA 71 AGFHE 222-7845 69 GC WSP WEST ST PAUL 70 CLA MPL AUSTIN 70 IT GRAD 70 IT GRAD 336-2016 69 IT P44-6845 71 DULTH 834-3067 70 CLA TWP HARBORS 69 IT MPL TWO HARBORS 69 CLA 722-4083 70 CLA MPL MINNEAPOLIS 70 CLA 935-4606 68 ED SLP ST LOUIS PARK 68 CLA 331-1114 69 AGFHE 225-7279 68 ED 925 OTTO AVE 68 ED 986 15TH AVE SE 70 CLA 222-6194 71 CLA WSP WEST ST PAUL 70 CLA 922-9129 70 CLA EDN EDINA 70 CLA 929-1841 70 AGFHE SLP ST LOUIS PARK 70 AGFHE 373-7177 68 BUS MPL MINNEAPOLIS 68 ED 929-0990 68 ED EDN EDINA 68 ED 429-7271 69 IT WTB WHITE BEAR LAKE 69 IT 489-9573 60 CLA ROV ROSEVILLE 68 CLA 332-3092 71 IT 489-7416 68 ED ROV ROSEVILLE 71 CLA 646-0249 71 CLA STP COTTONWOOD 71 CLA 881-3438 68 ED BLT BLOOMINGTON 69 CLA MPL PAW PAW MI 60 GC 825-7023 70 CLA MPL MINNEAPOLIS 70 CLA 331-8868 70 CLA 473-5130 68 ED AS CLA 644-6895 71 CLA ROV ROSEVILLE 71 CLA 884-3921 68 DULTH 724-0626 68 CLA HOYT LAKES 68 GC 825-7023 71 DULTH 525-1584 69 DULTH 545-1523 68 GC 888-7164 68 MORRS 634-3073 70 LAW 588-6319 70 IT GOV TRIMONT 69 GC 646-5130 71 MED STP CRYSTAL 71 MED 331-1704 70 IT MPL MINNEAPOLIS 70 IT GRAD	68 GC 588-8055 71 DULTH 724-9992 69 IT RICHFIELD 69 GC ST1-9481 70 STA ST ANTHONY 70 AGFHE 644-6792 70 ST PAUL GRAD 71 IT 698-1161 70 STP SOUTH ST PAUL 70 IT GRAD 827-2290 70 MPL AVGN SD 70 CLA 529-5945 70 MPL MINNEAPOLIS 70 CLA 522-5609 70 MPL MINNEAPOLIS 70 IT GRAD FE5-8516 69 MPL YEADON PA 69 CLA MPL APPLETON WI 70 AS CLA NSP 71 MORRS 751-5328 70 IT BEMIDJI 71 CLA 533-5198 68 DULTH CYT CRYSTAL 68 DULTH HASTINGS 68 MORSC 561-4880 71 CLA BRC MELROSE 71 CLA 722-5119 70 IT MINNEAPOLIS 70 IT ELLSWORTH WI 71 CLA 533-5456 69 GC BRC BROOKLYN CENTER 70 IT EDN EDINA 70 IT GRAD 71 CLA 822-3046 69 ED MPL MINNEAPOLIS 69 ED 776-2678 70 STP ST PAUL 70 GRAD 588-6197 69 ED GOV GOLDEN VALLEY 69 CLA 473-9671 70 CLA WAY WAYZATA 70 CLA 824-3662 70 IT MPL MINNEAPOLIS 70 IT GRAD 724-1832 69 ED 927-9070 71 MPL MINNEAPOLIS 71 CLA 927-9070 71 MPL MINNEAPOLIS 70 CLA 822-3046 70 CLA 698-6389 68 ED STP ST PAUL 70 IT GRAD 339-3182 70 MPL GRNBELT MD 70 CLA MPL NEW ULM 69 CLA 645-7451 68 CLA 331-5612 71 MPL RYE NY 71 CLA 922-0905 69 ED EDN EDINA 69 ED 861-3122 70 CLA BLT MINNEAPOLIS 70 CLA 561-7637 68 ED BRP BRQOKLYN PARK 68 ED 521-0564 69 ED MPL MINNEAPOLIS 69 ED P44-4361 70 IT MPL MINNEAPOLIS 70 IT GRAD 825-9247 68 AGFHE 645-2278 70 CLA STP ALBERT LEA 70 CLA MPL ALBERT LEA 70 IT AS CLA 70 MPL WINONA 70 IT GRAD 71 DULTH 727-6131 71 DULTH 727-1982 68 ED DULUTH 68 ED 522-6078 70 CLA MPL 70 CLA 521-4049 70 IT MPL MINNEAPOLIS
---	--	---	---









WHALEN CHARLES MICHAEL 71 DULTH 724-9804  
 GRIGGS HALL A313 EDINA  
 WHALEN DAVID OWEN 70 CLA 890-4717  
 2501 W 140TH ST  
 WHALEN KATHLEEN JEAN 70 CLA 338-6895  
 902 21ST AVE SO MPL MINNEAPOLIS  
 WHALEN MICHAEL ROBERT 69 IT  
 3630 NEWTON NO MPL MINNEAPOLIS  
 WHALEN SR M ROSALIE GRAD 333-2161  
 113 E CONSTOCK HALL MPL DUBUQUE IA  
 WHALEN WILLIAM EDWARD 71 CLA 699-4147  
 1588 HIGHLAND PKWY STP ST PAUL  
 WHALEY SANDRA KAY GRAD 339-1217  
 415 ERIE ST SE MPL COLUMBUS ND  
 WHALEY TIMOTHY LYLE 69 CLA 455-5391  
 827 21ST AVE NO SSP SOUTH ST PAUL  
 WHALIN MICHAEL MATTHEW 70 CLA  
 CAMBRIDGE  
 WHALL DAVID GERALD 69 CLA 774-3993  
 1323 E MINNEHAMA STP ST PAUL  
 WHALTON DENNIS ROBERT 68 ED 926-6086  
 4152 TOLEDO AVE SO SLP ST LOUIS PARK  
 WHEAR ANN ELIZABETH 70 CLA WA7-9217  
 5310 KERXES SO EDN EDINA  
 WHEAR THOMAS CHARLES 70 CLA WA7-9217  
 6310 KERXES S EDN EDINA  
 WHEATCRAFT LUANNE POLI 71 AGFHE  
 828 NO HAZEL STP AITKIN  
 WHEATLEY JOHN LABAN GRAD  
 302 3RD AVE SE MPL  
 WHEATON TERRY ANN 69 PHARM  
 WHEELER ARTHUR WILLIS 71 GC 225-5467  
 383 DAYTON AVE STP  
 WHEELER CHARLOTTE SCHW 68 MORRS 589-1032  
 503 1/2 ATLANTIC HUTCHINSON  
 WHEELER CHRISTA LEE 69 CLA 484-7873  
 958 EDGEWATER AVE W SHV SHOREVIEW  
 WHEELER DAVID NELSON GRAD 721-4532  
 2449 34TH AVE SO MPL CHETMYND  
 WHEELER DONALD JAMES AS PH 645-8012  
 1763 ROSELAWN AVE W ROV  
 WHEELER JAMES CLINTON 68 MORRS 589-1032  
 503 1/2 ATLANTIC GLENWOOD  
 WHEELER JAMES JESS AS CLA 588-6578  
 3713 PERRY AVE NO MPL MINNEAPOLIS  
 WHEELER JAMES MAURICE GRAD 488-7943  
 380 W LARPENTEUR STP LEXINGTON KY  
 WHEELER JOHN WILLIAM GRAD 339-7421  
 CENTENNIAL MPL RUSH NY  
 WHEELER JULIE ANN 70 CLA  
 319 12 AV SE MPL ST PAUL  
 WHEELER KENNETH GERALD GRAD  
 1907 SHARON AVE SE MPL CLOVIS CA  
 WHEELER LOLA SCHUELTHER AS ED  
 WHEELER MARK ERLING 69 AGFHE 633-0050  
 1360 7TH NW NMB DELAVAN  
 WHEELER MARK PHILIP 71 CLA 929-4123  
 3125 HAMPSHIRE AVE SO SLP ST LOUIS PARK  
 WHEELER MARY ANNE 70 CLA 588-4413  
 5507 JUDY LN 8RC BROOKLYN CENTER  
 WHEELER PAUL RAYMOND 71 CLA 645-1876  
 1446 ASHLAND AVE STP  
 WHEELER RAY LOUIS 68 GC PA1-4316  
 4338 43RD AVE SO MPL  
 WHEELER SUSAN MARGRETT 70 NURS  
 POWELL HALL MPL DELAVAN  
 WHEELER TIMOTHY ALLAN 68 CLA 869-0134  
 1011 4TH ST SE MPL MINNEAPOLIS  
 WHELAN COLLEEN MARY 70 CLA 338-6839  
 335 8TH ST SE EDN EDINA  
 WHELAN MAUREEN MARY 68 GC 338-6839  
 335 8TH ST SE MPL MINNEAPOLIS  
 WHELAN PATRICK JOHN 71 CLA 588-4338  
 4900 NORMANDY PL GOV GOLDEN VALLEY  
 WHELAN TIMOTHY JOSEPH 69 CLA 529-3068  
 2218 FREMONT NO MPL MINNEAPOLIS  
 WHELPLEY JAMES CARLYLE 70 CLA 926-1334  
 3721 THOMAS SO MPL MINNEAPOLIS  
 WHERRY JOHN ALAN 71 AGFHE 647-3503  
 BREWSTER HALL STP MINNEAPOLIS  
 WHERRY W STEPHEN 70 CLA 825-6128  
 4736 ALDRICH SO MPL MINNEAPOLIS  
 WHETSTONE ANN ELIZABETH GRAD 339-5130  
 629 UNIV AVE SE MPL ARLINGTON VA  
 WHIPKEY JAMES EDWIN 68 IT  
 WHIPPLE BARBARA ANN 68 ED  
 CONSTOCK HALL MPL FERGUS FALLS  
 WHIPPLE GARY DEWITT 71 DULTH  
 2910 E 2ND ST RAY  
 WHIPPLE RICHARD EARL 68 PHARM  
 2837 WILLIAMS AVE SE MPL MARSHALL  
 WHIPPLE RODGER EARL 69 IT  
 PIONEER HALL MPL METUCHEN NJ  
 WHIPPLE SCOTT STUART 69 MORSC 926-3941  
 5832 ASHCROFT AVE EDN EDINA  
 WHITAKER GRETTEL HOFFMA GRAD 331-5088  
 1097 13TH AVE SE MPL ST PAUL  
 WHITBECK RICHARD BRUCE 69 ED 881-1904  
 8242 PORTLAND AVE SO BLT BLOOMINGTON  
 WHITCOMB DENNIS KEITH 70 CLA 774-3187  
 1625 EDGERTON ST STP ST PAUL  
 WHITCRAFT ROBERT JAMES 69 GC JA1-4250  
 3835 PENN NO MPL MINNEAPOLIS  
 WHITE ANTHONY WAYNE 69 GC 825-9458  
 4133 ELLIOT SO MPL MINNEAPOLIS  
 WHITE BARBARA ANN 68 ED 789-5571  
 2312 POLK ST NE MPL MINNEAPOLIS

WHITE BARBARA ANNE 68 GC 935-5469  
 3301 DECATUR LANE SLP ST LOUIS PARK  
 WHITE BOB FREDERICK GRAD 521-3123  
 2518 LOGAN AVE NO MPL BLOOMINGTON IL  
 WHITE BETTY MITCHELL AS ED  
 WHITE BRIAN ODOGNOHUE AS CLA 313-6506  
 318 TERRITORIAL HALL MPL NEW CANAAN CT  
 WHITE CHARLES DAVID 68 GC 484-4046  
 2599 N LEXINGTON AVE ROV ROSEVILLE  
 WHITE CHERYL ANNE 69 MORRS  
 RM 105 CAMDEN HALL NORTH ST PAUL  
 WHITE CONSTANCE MARIE 71 CLA 42 -  
 PIONEER COURT MPL WHITE BEAR LAKE  
 WHITE COURTLAND YARDLE GRAD  
 WHITE DARRELL KERMIT 68 IT  
 WHITE DAVID ALLEN 70 CLA  
 FRONTIER HALL MPL EAU CLAIRE WI  
 WHITE DAVID JACK 68 CLA 722-3219  
 4025 42ND AVE SO MPL NEW BRIGHTON  
 WHITE EILEEN KATHERYN 71 CLA 488-8027  
 1050 W MINNEHAMA STP ST PAUL  
 WHITE ELAINE ANNA 70 CLA 331-1339  
 1109 5TH ST SE MPL WINGONA  
 WHITE FREDERICK JOHN 70 AGFHE 777-7778  
 2511 E 19TH AVE NSP NORTH ST PAUL  
 WHITE GORDON LEONARD 70 CLA 881-3957  
 8417 LITTLE ROAD BLT BLOOMINGTON  
 WHITE HEWITT AUSTIN 68 IT  
 WHITE JAMES CHRISTOPHE 71 IT 888-9381  
 9301 OAKLAND BLT BLOOMINGTON  
 WHITE JAMES EDWARD 70 CLA 721-6830  
 5348 46 AVE SO MPL MINNEAPOLIS  
 WHITE JAMES HARRIS GRAD  
 WHITE JAMES VINCENT 68 IT 739-8874  
 768 BARTELMY LN STP ST PAUL  
 WHITE JOHN FRANKLIN GRAD  
 WHITE JOHN FREDERICK 68 BUS  
 WHITE JOHN FREDERICK 68 CLA 336-2516  
 912 21ST AVE SO MPL PRINCETON  
 WHITE KATHLEEN PETERSO 70 CLA  
 3105 COLFAX SO MPL ST LOUIS PARK  
 WHITE KENNETH ALAN JR AS ED  
 WHITE LENORE LOUISE 71 CLA  
 PIONEER COURT MPL HUTCHINSON  
 WHITE LOIS D GRAD  
 606 DRIFTHOOD RD NMB  
 WHITE LUELLA ANN GRAD 338-8135  
 425 SIXTH AVE NE MPL ALBERT LEA  
 WHITE MARJORIE ANTONOV 69 ED 757-3697  
 10920 JEFFERSON ST NE BLA MINNEAPOLIS  
 WHITE MARY ELIZABETH 70 AGFHE 644-4222  
 1387 CLEVELAND STP FARIBAULT  
 WHITE MICHAEL BRIAN 69 DULTH  
 MINNEAPOLIS  
 WHITE MICHAEL KEITH 70 CLA 521-2540  
 3834 QUEEN AVE NO MPL MINNEAPOLIS  
 WHITE PHILIP ELDON 69 IT  
 WHITE ROBERT JAMES 70 CLA 784-4059  
 8000 TERRACE RD NE SKP SPRING LAKE PK  
 WHITE ROBERT PAUL JR AS MORRS  
 408 E 4TH ST  
 WHITE RONALD MERRILL 71 CLA 631-2080  
 1430 COMMERCE ROV BLOOMINGTON  
 WHITE RUTH RAYBURN 70 NURS 721-6830  
 5368 46TH AVE SO MPL  
 WHITE SUSAN OPSTAD GRAD  
 WHITE TERRY KENNETH 71 DENT 533-6751  
 3750 LOUISIANA AVE NO NMH NEW HOPE  
 WHITE WARREN HOWARD 70 IT  
 224 CECIL ST SE MPL GRASSTON  
 WHITE WILLIAM JEFFERSO 70 CLA 827-5084  
 3105 COLFAX SO MPL MINNEAPOLIS  
 WHITE WILLIAM WALLACE 69 BUS 332-4808  
 834 THORNTON ST SE MPL ST PAUL  
 WHITEAKER ROBERT BARRY GRAD  
 WHITEBREAD DAVID ANTHO 71 CLA 774-1635  
 2102 SLOAN ST MPN MAPLEWOOD  
 WHITECAR JOHN P JR GRAD  
 WHITEFORD CYNTHIA MARI 71 CLA  
 CONSTOCK HALL MPL MINNEAPOLIS  
 WHITEHEAD DONALD KENNE 70 IT  
 WHITEHOUSE BRUCE ALAN 71 IT  
 WHITEMAN WILLIAM KURT 71 DULTH 724-0226  
 2603 S 5 ST DULUTH  
 WHITENACK MICHAEL JAME 70 CLA 888-8974  
 8219 JOHNSON CIRCLE BLT BLOOMINGTON  
 WHITENECK PETER JOHN 68 ED  
 WHITING JAMES THOMAS 70 CLA 537-7810  
 5026 42ND AVE NO ROB MAPLETON IA  
 WHITING RICHARD BROOKE 70 CLA 927-6A26  
 4418 W LK HARRIET BLVD MPL MINNEAPOLIS  
 WHITING SHIRLEY GOLTZ 70 CLA  
 5742 BLAISDELL AVE S MPL  
 WHITING SUZANNE MARTHA 70 CLA 333-2161  
 419 W CONSTOCK HALL MPL YPSILANTI MI

WHITLEY JANET LOUISE AS CLA 335-5057  
 126 HARWICK ST SE MPL MINNEAPOLIS  
 WHITLOCK DANIEL JOHN 69 MED 331-1319  
 325 HARVARD ST MPL HANKATO  
 WHITLOCK EVE ALYNN 70 CLA 699-3918  
 2116 LINCOLN STP ST PAUL  
 WHITLOW RAY ERROL 68 CLA  
 WHITMAN ALAN BRUCE GRAD  
 WHITMAN ANDREW FRANKLI 68 LAW 822-0907  
 3200 HUMBOLDT AVE MPL PHILADELPHIA PA  
 WHITMAN SUE ELLEN 68 ED 429-4216  
 2188 ROTH PLACE WTB WHITE BEAR LAKE  
 WHITMORE GEORGE ALEXAN GRAD  
 WHITNAH THOMAS ARDEN 71 CLA 537-0710  
 5456 E TWIN LAKE BLVD MPL MINNEAPOLIS  
 WHITNEY CYNTHIA JEAN 71 CLA 881-3809  
 8218 COLFAX SO BLT BLOOMINGTON  
 WHITNEY DENNIS GENE 69 AGFHE 646-1603  
 2228 DOSWELL STP DELAVAN  
 WHITNEY JULIE LOUISE 71 CLA 825-0177  
 4746 DUPONT AVE SO MPL MINNEAPOLIS  
 WHITNEY LINDA MAY 70 AGFHE 222-7205  
 207 E CURTICE STP ST PAUL  
 WHITNEY MARY KATHRYN 71 CLA  
 PIONEER COURT MPL GRAND RAPIDS  
 WHITNEY RUSSELL TERREN 70 CLA 222-7205  
 207 E CURTICE ST STP ST PAUL  
 WHITNEY STEPHEN QUENVO 68 IT 822-6038  
 3537 IRVING S MPL MINNEAPOLIS  
 WHITSITT WILLIAM HARWO 70 DULTH  
 1402 MORNINGSIDE AVE DULUTH  
 WHITSON LYNN JANET 70 CLA  
 SANFORD HALL MPL WAYZATA  
 WHITTAKER GWENDOLYN M 70 CLA 788-5903  
 3970 VAN BUREN ST NE CLM COLUMBIA HTS  
 WHITTAKER KATHLEEN ANN 70 DULTH 624-7576  
 5726 HUNTINGTON ST DULUTH  
 WHITTED ALAN LEE 69 IT 335-7401  
 618 VAN BUREN NE MPL  
 WHITTEMORE WILLARD MCL 71 CLA 888-7276  
 2124 DIXON DRIVE BLT BLOOMINGTON  
 WHITTENBERG WILLIAM DA 70 CLA 897-7382  
 415 FRANKLIN ST HUTCHINSON  
 WHITTENDALE EILEEN JAN 68 GC 338-7941  
 2424 BUTLER PLACE MPL LONG ISLAND NY  
 WHITTIER TERRY LEE 68 GC  
 WHITTLEF ALLAN LLOYD 71 IT  
 WHITTLEF DARWIN JAMES 70 CLA 645-5022  
 1693 THOMAS AVE STP ST PAUL  
 WHOLL EDWARD RAYMOND 68 LAW 445-5482  
 CENTENNIAL HALL MPL FLUSHING NY  
 WHYATT FRANCES GRANMIS 70 CLA 336-6106  
 1215 9TH ST SO MPL  
 WHYATT NELSON THOMAS GRAD  
 WHYATT THOMAS EDWARD 68 LAW 336-6106  
 1215 S NINTH ST MPL ST PAUL  
 WHYTE JOHN EDWARD 70 CLA  
 5624 BEARD AVE SO EDN EDINA  
 WIBERG DIANE MARY 70 AGFHE 824-3327  
 5129 OAKLAND AVE SO MPL FARIBAULT  
 WIBERG GAYLE BBAATRICE 70 AGFHE 789-8658  
 2811 NE ULYSSES ST MPL MINNEAPOLIS  
 WIBERG JAMES JOHN 68 MED 332-7861  
 517 4TH AVE SE STP ST PAUL  
 WIBERG JOHN MYLER 70 DENT 429-4342  
 4376 COTTAGE PK RD WTB WHITE BEAR LAKE  
 WIBERG RICHARD ALLEN 68 CLA 776-4378  
 1687 E NEVADA AVE STP  
 WICHELMAN ALLAN FREDER 69 CLA 331-1447  
 1405 SE 6TH ST MPL GIBBON  
 WICHERN PHILIP HOWARD GRAD  
 WICHMAN KIRK RANDALL 70 MORRS 589-3121  
 BLAKELY HALL HUTCHINSON  
 WICHMAN PAMELA SUE 71 CLA  
 HUTCHINSON  
 WICHMANN GAIL LYNN 70 MORRS 354-5610  
 GAY HALL NEW ULM  
 WICK CHRISTIE MARGARET 69 DULTH 722-2758  
 2806 W 15TH ST DULUTH  
 WICK CLAYTON PEARCE 68 DULTH 727-4763  
 613 E 8TH ST DULUTH  
 WICK ERIC JOHN 70 IT  
 WICK GERALDINE MARIE 68 BIOC 588-3959  
 1445 SPRING VALLEY RD GOV GOLDEN VALLEY  
 WICK JANICE RAE 68 DULTH 722-0006  
 4121 UNSTAD RD DULUTH  
 WICK ROBERT CHARLES 68 GC  
 WICK THOMAS MEAD 71 CLA  
 FRONTIER HALL MPL ST CLOUD  
 WICKENHEISER ROBERT JO GRAD  
 WICKER VICKI LYNN 70 CLA 560-6308  
 4839 2 1/2 ST NE CLM COLUMBIA HTS  
 WICKHAM GERALD FRANCIS 71 CLA 377-5414  
 1649 PRINCETON AVE SLP ST LOUIS PARK  
 WICKLEM BETTY HOLMES J 68 NURS 488-8946  
 835 COMO AVE STP HINCKLEY  
 WICKLEM ROBERT GEORGE GRAD  
 WICKLUND DIANE LOU 71 CLA  
 SANFORD HALL MPL CAMBRIDGE





WILLOW ROGER BRADFORD 68 GC 781-7176  
2350 BENJAMIN ST NE  
WILLSHIRE KAY LYNN 69 CLA  
COMSTOCK HALL  
WILLSON MARNEE LYNN 69 PT 332-8516  
323 10TH AVE SE  
WILLSON MICHAEL KING 70 CLA 508-3870  
1180 PIERCE TERRACE  
WILLSON NANCY RUTH 69 CLA 881-5388  
8419 4TH AVE SO  
WILM MICHAEL FREDRICK 70 CLA 429-7973  
P O BOX 8625  
WILMES JEAN MARIE 69 ED 225-2964  
562 OTTAWA  
WILMES STEPHEN JOSEPH 68 CLA PA4-9414  
3913 29TH AVE SO  
WILMS HERBERT RAYMOND AS ED  
  
WILMS PATRICIA ANN KEL AS ED 927-5701  
2715 CHOWEN AVE SO  
WILSEY LESTER ARTHUR 71 CLA 484-2324  
1178 TILLER LANE  
WILSON ALAN EDWARD 70 IT  
803 E 2ND  
WILSON ANDREW CALVIN 69 GC 729-3480  
3952 SNELLING AVE SO  
WILSON ATHEEN MARIE 69 CLA 335-5395  
813 UNIV AVE SE  
WILSON BARBARA MAE 69 DULTH 724-7930  
35 W MANKATO ST  
WILSON BETTY CAPPERS GRAD 941-4749  
6341 WARREN  
WILSON BETTY MOORE GRAD 333-8583  
RT 2  
WILSON BEVERLY JEAN GR 68 ED  
  
WILSON BEVERLY KAY 69 CLA  
55 WILLIAMS AVE SE  
WILSON BRUCE LELAND GRAD  
  
WILSON CAROLYN ANNE 71 CLA 331-9726  
708 5TH ST SE  
WILSON CHARLES LAWREN 71 CLA 474-9559  
710 14TH AVE SE  
WILSON CHERYL DONART F 68 AGFHE  
511 UNIV SE  
WILSON CLAIRE WALKER AS AGFHE  
  
WILSON CLARK MICHAEL 69 AGFHE 338-3330  
2409 1ST AVE SO  
WILSON CURTIS RAY 68 ED  
PIONEER HALL  
WILSON CYNTHIA ANNETTE 71 DULTH 525-5644  
29 N 43 AVE E  
WILSON DANIEL HARRY 70 AGFHE 646-4790  
2060 CARTER AVE  
WILSON DAVID SCOFIELD GRAD  
  
WILSON DONALD ALAN 69 DULTH 724-2697  
1910 KENT RD  
WILSON DOUGLAS DEAN 69 GC  
708 6TH ST SO  
WILSON DUANE ARCHIE GRAD  
  
WILSON EMILY KATHERINE 69 CLA 331-8980  
700 10TH AVE SE APT 1  
WILSON FRANCES AGNES Z 68 ED 788-6759  
1629 INNSBRUCK CIRCLE W  
WILSON FREDERIC BARLOW 71 CLA 646-5747  
2068 IGLEHART  
STP BLOOMINGTON  
WILSON GARY WOODROW 68 IT 724-3025  
3251 36TH AVE SO  
WILSON GREGORY WAYNE AS GC 938-1376  
400 GRIFFIT ST  
WILSON HELEN KATHLEEN GRAD 331-5284  
2420 COMO AVE SE  
WILSON JAMES DOUGLAS 68 IT 339-7421  
CENTENNIAL HALL  
WILSON JAMES JAY 68 GC  
  
WILSON JAMES RICHARD 70 CLA 724-9262  
5720 25TH AVE S  
WILSON JAMES SIDNEY 69 IT 537-9900  
5454 LAKELAND AVE N  
WILSON JAMES WARREN GRAD  
  
WILSON JANET CAROLENE 70 CLA 429-0045  
5195 DIVISION AVE  
WILSON JAY CARTER 69 GC 777-4918  
2700 GERALD AVE  
WILSON JOHN BELL 69 CLA 869-7680  
7421 GIRARD AVE SO  
WILSON JOHN DAVID 68 CLA 724-9262  
5720 25TH AVE SO  
WILSON JOHN RANDALL 68 DULTH 724-2697  
1910 KENT RD  
WILSON JON ROBERT 68 DULTH  
1500 E SKYLINE PKWY  
WILSON JULIA CHRISTINA 69 ED 729-3603  
5509 30TH AVE SO  
WILSON KATHLEEN ANN 70 DULTH 724-5998  
4715 WOODLAND AVE  
WILSON KIM JOAN 71 CLA 881-2509  
9436 STANLEY AVE  
WILSON LINDA LOU GRAD  
  
WILSON LYNNE ANNE 71 CLA 588-3204  
3330 MAJOR  
WILSON MARY ANN 68 CLA 331-9725  
708 5TH ST SE  
WILSON MARY MARGARET 71 CLA  
SANFORD HALL 302  
WILSON MEREDITH ANN GRAD  
  
WILSON MICHELLE EDELIN 70-CLA  
SANFORD HALL  
WILSON PEARL ELIZABETH AS GC 335-5984  
2319 10TH AVE S  
WILSON PETER MICHAEL 68 ED  
1428 WASHINGTON AVE SO  
WILSON RICHARD ALAN 69 MED 724-7411  
5129 38TH AVE SO  
WILSON ROBERT ASHLEY 69 CLA 331-7929  
315 16TH AVE SE  
WILSON ROBERT GLENN AS DULTH 834-3312  
134 2 AVE  
WILSON ROBERT LINN 69 GC  
  
WILSON ROBERT MICHAEL 69 DULTH 724-2697  
1910 KENT RD  
WILSON ROBERT NICHOLI GRAD 331-7229  
615 15TH AVE SE  
WILSON SCOTT EARL 68 GC 545-7131  
1406 VALDERS AVE  
WILSON SHARON FRANCES GRAD 633-4997  
393 OLD HWY 8  
WILSON SHELIA ANN 69 DULTH 729-7903  
3814 ROSE RD  
WILSON SHERWOOD ANN GRAD  
KING CITY MO  
WILSON STEVEN ROBERT 70 CLA  
1721 UNIVERSITY AVE SE  
WILSON SUSAN CAROLYN 70 CLA 338-1324  
517 20TH AVE SO  
WILSON THOMAS DALE 70 MORRS  
102 E 7TH  
WILSON VICKIE LYNN 68 CLA  
  
WILSON WANDA MARIA 71 AGFHE 827-4965  
2811 PORTLAND AVE SO  
WILSON WARREN DENNIS MPL DUMONT  
1630 EUSTIS  
WILSON WENDELL E JR 69 DULTH 728-1996  
2234 WOODLAND AVE  
WILTON RODNEY ALLAN 71 DULTH 729-9893  
VERMILION HALL 181  
WILTSE JEANETTE ARLINE GRAD 645-4265  
1223 ROSE VISTA  
WILTZ ROBERT EUGENE ROV DALLAS TX  
705 E WOODLEY GRAD 645-8584  
WIMBERLEY SANDRA JOYCE 71 CLA 929-1933  
3954 BRUNSWICK  
WIMER LOIS MARIE SLP ST LOUIS PARK  
2730 MERIDIAN DR 69 PT 588-4370  
WINBERG RICHARD LAWREN 68 CLA 537-6387  
6418 QUAIL AVE NO  
WINBERG ROGER LAWRENCE BRC BROOKLYN CENTER  
CENTENNIAL HALL 70 CLA  
WINGEK THOMAS JOHN MPL HIBBING  
4139 QUEEN SO  
WINCHESTER JEAN HERSEY 68 ED 377-5560  
2116 NEWTON AVE SO  
WINKLER KATHRYN ELIZA 70 CLA 338-0891  
516 UNIVERSITY AVE SE  
WINKLER MARIE LOUISE 71 CLA 646-2900  
787 CROMWELL RD  
WINDAHL ETHAN LONGREN SLP MINNEAPOLIS  
2628 W 44TH ST 69 LAW 920-2019  
WINDAHL JULIE HUTCHISO MPL EAGLE GROVE IA  
GRAD  
  
WINDAHL CHRISTINE JU 69 MEDTC 333-2161  
213 W COMSTOCK HALL  
WINDEN KENNETH LUTHER 68 IT 646-5138  
1297 FIFIELD PL  
WINDY MICHAEL THOMAS 68 GC 644-7475  
445 N WHEELER  
WINDFELDT CYNTHIA ANN MPL MINNEAPOLIS  
COMSTOCK HALL  
WINDHORST PETER BOTTGE AS CLA 926-0277  
4907 W LAKEVIEW DR  
WINDMILLER NANCY LOU EDN EDINA  
PIONEER HALL 70 CLA 439-5603  
WINDORSKI ELIZABETH AN 69 GC 646-8285  
1310 RYAN AVE W  
WINDORSKI MARY CLARE 70 CLA 646-8285  
1310 RYAN AVE W  
WINDSCHITL CAROL MARIE 71 CLA 331-2139  
1416 7TH ST SE  
WINDSOR ROBERT ANTHONY MPL STEWART  
1141 OLSON HWY GRAD 377-4119  
WINEMAN GERALD ALAN 69 GC 825-1482  
4129 HARRIET AVE SO  
WINER EDWARD LEWIS 68 LAW 544-2649  
1349 JERSEY SO  
WINER MICHAEL HILLARD SLP ST LOUIS PARK  
3241 KENTUCKY AVE S  
WINER SALLY LISS JEAN SLP ST LOUIS PARK  
2241 PENNSYLVANIA  
WINER STEVEN IRA 68 CLA 698-7046  
1691 BOHLAND AVE  
WINER STEVEN MARK STP ST PAUL  
5660 WEST BROOK RD  
WINERMAN CAROLE VICKI 70 CLA 544-4876  
2636 KIPLING AVE  
WINFIELD VERNON HALL 70 CLA 926-6668  
FRONTIER HALL SLP ST LOUIS PARK  
WING CHRISTINE ZOE 71 ED 729-9196  
SANFORD  
WING DAVID JOHN 71 CLA  
1113 19TH AVE SE MPL WAYZATA  
MPL AGFHE 331-7431  
MPL MINNEAPOLIS

WINTERHALTER JOAN ANN 1293 PORTLAND WINTERHALTER JOAN MARG 905 21ST AVE SO WINTERMUTE JOHN STEVEN 1011 4TH ST SE WINTERS JILL MARLENE 2140 NW 14TH ST WINTERS LYNN SHARON 212 WALNUT ST SE WINTERS RICHARD WILLIA 5290 3RD ST NE WINTERS SHARON KAY SANFORD WINTERSTEIN THOMAS ALA GRIGGS HALL B317 WINTERVOLD BRUCE LEE CENTENNIAL HALL WINTERZUNAGA SAMUEL 910 25TH AVE SO WINTHEISER GERALD NICH 2513 EMERSON SO WINTHROP ROBERTA ELLEN 3025 FLORIDA SO WIPLINGER ROBERT DONAL ROUTE 10 WIPPERMANN LESLIE ANN 314 10TH AVE SE WIPPL JOSEPH WILLIAM 1067 15TH AVE SE WIRE JOHN LACY 423 CEDAR AVE APT 8 WIRGAU OTTO RICHARD	68 ED 646-3218 STP ST PAUL 71 CLA MPL HAMEL 69 CLA FE6-9359 MPL LA GRANGE IL 69 CLA 633-7833 NWB NEW BRIGHTON GRAD 331-6245 MPL WINNIPEG 68 ED FRD FRIDLEY 69 GC MPL BINGHAM LAKE 71 DULTH 724-9856 WHITE BEAR LAKE 70 CLA MPL RED WING 70 IT MPL LIMA 68 DENT 377-6579 MPL EXCELSIOR 71 CLA 929-7670 SLP ST LOUIS PARK 68 IT SSP SOUTH ST PAUL 69 ED WA6-0372 MPL EDINA GRAD 331-3161 MPL MILWAUKEE WI GRAD MPL MILLBROOK NY GRAD	WISNIEWSKI PAMELA MARI 70 IT  WISOCKI ANTHONY CHARLE 71 DULTH 724-7718 100 E FAIRBAULT DULUTH WISOCKI JOSEPH JOHN 69 DULTH 525-3610 5806 GLENWOOD ST DULUTH WISOCKI PETER MICHAEL 70 DULTH 724-7718 400 E FAIRBAULT DULUTH WISSER JAMES LEE 70 MORRS GAY HALL BLOOMINGTON WISSER NATHAN RICHARD GRAD	WITTHAUS DONNA WINTER 121 WILWOOD AVE STP GRAD 426-2367 WITTICH FREDERICK WILL 68 GC 929-6808 3230 ALABAMA AVE SLP ST LOUIS PARK WITTICH JANE ELIZABETH 70 NURS 866-5979 6444 14TH AVE SO RHF RICHFIELD WITTKOP DENNIS ROY 70 CLA 429-4133 5300 NW AVE WTB WHITE BEAR LAKE WITTKOP PATRICIA MARIE 71 DULTH 613 N 5TH AVE E DULUTH WITTKOPP THOMAS ARNO 70 MED 339-6073 921 24TH AVE SO MPL WORTHINGTON WITTLES EVA JEANNE 68 NURS 331-2474 621 15TH AVE SE MPL MINNEAPOLIS WITTLES RACHEL HARRIS 70 CLA 922-3247 5245 KNOX AVE S MPL WITTLIEF NORBERT EDWAR 70 CLA TERRITORIAL HALL MPL LYLE WITTMAN KAY LAVON 70 AGFHE 645-9241 BAILEY HALL STP ST PAUL WITTNER PAUL DENNIS 70 AGFHE 1495 N CLEVELAND STP ALBON WITTMERS LORENTZ EDWAR 70 GRAD 331-2959 412 MILLARD AVE MPL MINNEAPOLIS WITTMERS PATRICIA JEAN 71 CLA 561-1662 6801 BEARD NO MPL MINNEAPOLIS WITTNEBEL JONATHAN EDW 69 MORRS NASSAU WITTNEBEL THOMAS CARL 69 AGFHE	WITTRICK DONNA MARIE 69 AGFHE MPL WASECA WITTRUP MARK RICHARD 71 DULTH 724-9998 GRIGGS HALL D112 OWATONNA WITTMER KATHRINE DIANE 71 CLA SANFORD HALL MPL REDWOOD FALLS WITTMER SALLY ANN 70 CLA GLENWOOD WITZ LAWRENCE EARL 68 GC 788-7559 4407 JACKSON ST NE CLH COLUMBIA HTS WITZ LEONARD EDWARD 68 GC 788-7559 4407 JACKSON ST NE CLH COLUMBIA HTS WITZMAN BARBARA SHARON 70 DULTH 724-2198 1019 E 6 ST DULUTH WITZMAN BEVERLY ROSE 70 DULTH 724-2198 1019 E 6 ST DULUTH WITZMAN GARY LEE GRAD 2818 31ST EAST MPL BINABIK WIVELL WILLIAM THOMAS 69 CLA 537-8009 4327 TOLEDO NO ROB ROBBINSDALE WLASCHIN CATHERINE FRA 71 CLA 429-1908 RT 3 STM STILLWATER WLASCHIN PAUL LELAND 68 CLA 429-1908 RT 3 STILLWATER STM STILLWATER WLASCHIN SHERYL CATHER 71 CLA 426-3818 RT 1025 WOBBE SHEILA PERKINS 68 DULTH 225-2554 HOYT LAKES WOBBROCK PAMELA JEANNE 71 CLA 334-3624 SANFORD HALL MPL MORRISTOWN WOBIG JOHN LEE GRAD 522-3046 3958 WASHBURN AVE N MPL WOBKEN TERRY G 68 IT 331-2358 986 15TH AVE SE MPL SIOUX CITY IA WOBBSCHALL GERALD REUBE 69 BUS 335-2978 504 UNIV AVE SE MPL MAZEPPA WOCKEN JOAN ELIZABETH 69 PT 373-7212 COMSTOCK HALL 233M MPL ST PAUL WODELE JOHN HENRY 70 CLA 331-1732 307 16TH AVE SE MPL WABASHA WODRICH JAMES ALLAN 71 IT 331-3432 1115 5TH ST SE MPL MINNEAPOLIS WODZIAK SHIRLEY MARY 70 NURS 788-0087 3934 3RD ST NE CLH COLUMBIA HTS WOEHRLE ELIZABETH HAUG 68 ED 338-9927 1100 5TH ST SE MPL ST PAUL WOEHRLE JAMES FRDERIC 70 CLA 1206 SE 5TH ST MPL MINNEAPOLIS WOERNER SUSAN JANE 71 CLA 927-7462 915 6TH ST SE MPL EDINA WOESSNER DAVID PAUL 71 CLA 489-6357 925 W CO RD B RDV ROSEVILLE WOGSLAND CURTIS LEROY 70 CLA 729-2758 3037 21ST AVE SO MPL MINNEAPOLIS WOHLEEN DANIEL CARROLL 70 CLA 824-8490 4201 12TH AVE SO MPL MINNEAPOLIS WOHLERS GARY LOUIS 68 IT 1642 EUSTIS STP BROWNSVILLE WOHLFORTH NANCY JULIA 70 AGFHE 724-0305 5712 43RD AVE SO MPL WOHLIN ROLAND WILLIAM 71 VET M 722-8193 3401 39TH AVE SO MPL NEW LONDON WOHLMAN LEONARD HAROLD 69 AGFHE 3421 15TH AVE SO MPL RENVILLE WOHLRABE JERALD CHARLE 70 MORRS 677-3001 P O 818 HERMAN WOHLWEND JUDITH ANN AS GC 489-7192 1525 LORIENT STP WOHNOUTKA GERALD EDWAR 68 PHARM 333-2287 1024 4TH ST SE MPL STEWARTVILLE WOIDA SHARON FRANCES 70 PHARM 560-1157 201 SATELLITE LANE NE FRD FRIDLEY WOJCIAK BARBARA JEAN 68 ED	WITTHANS RONALD CHARLE 71 IT GRAD 488-0037 MPL FALLS CHURCH VA 71 CLA 922-4427 EDN EDINA 68 CLA 827-1026 MPL MINNEAPOLIS 71 AGFHE 827-1026 MPL MINNEAPOLIS 68 CLA 866-0469 RHF BRAINERD 71 DULTH 724-9831 NER WI 71 DULTH 834-2725 TWO HARBORS 70 CLA 336-9590 MPL MENAUGA 69 PHARM 70 CLA 331-3529 MPL HUTCHINSON 70 CLA MPL WAYZATA 69 GC 332-1989 MPL MINNEAPOLIS 69 GC 922-2111 MPL MINNEAPOLIS 70 CLA 588-2908 ROB ROBBINSDALE 68 ED 334-7800 MPL MINNEAPOLIS 69 GC 922-7222 EDN EDINA 68 ED MPL GRAND RAPIDS 71 CLA 823-1772 MPL MINNEAPOLIS 69 GC JUB-1129 GOV GOLDEN VALLEY 71 CLA 935-6733 HOP PAULLING IA 71 DULTH 879-7568 CLOQUET 69 GC 788-8469 CLH COLUMBIA HTS GRAD 644-1505 STP MAHMONEN 69 DULTH 724-9886 MINNEAPOLIS 69 CLA 695-4897 MPL ST PAUL 70 CLA MPL WHITE BEAR LAKE 70 CLA MPL BROOKLYN NY 69 MORRS 589-3276 HENNING 70 CLA MPL ROCHESTER 69 DULTH 724-5098 KENYON 68 ED MPL 69 GC 226-2803 MPL MINNEAPOLIS GRAD 69 AGFHE STP MINNESOTA CITY 69 CLA 825-9655 MPL WINTHROP 70 CLA MPL MINNEAPOLIS 68 IT 70 CLA 338-0979 MPL BEMIDJI 71 AGFHE MPL HUTCHINSON 71 CLA 646-7785 STP ST PAUL 71 CLA 938-4357 HOP HOPKINS 69 CLA 729-1395 MPL MINNEAPOLIS 68 CLA GRAD 647-3511 STP CHARLOTTEVILLE VA 70 CLA 776-7854 STP ST PAUL 69 CLA 722-9410 MPL MINNEAPOLIS 70 CLA 331-5887 MPL BLOOMINGTON 70 ED 869-8905 RHF RICHFIELD 71 IT
---	--	---	---	--	---

WOJCIC JUDITH ANN ROUTE 4 BOX 452 WAYZATA WOJCIC LINDA MARIE 3608 BELDEN DRIVE WOJCIC MARK LOUIS 975 E CO RD C WOJNAR ROSEMARY THERES 2145 FOX PL WOLANIN THADDEUS STANL 3977 EARLYNN LANE WOLBECK KATHRYN ANN WADDELL TR CT # 29 WOLCOTT JOHN BALDRIDGE 4110 COFFMAN LN WOLCOTT MARK CHARLES BOX 188 WOLD CAROL ANNE 3808 GARFIELD AVE SO WOLD DAVID ELMER 741 E ROSELAWN AVE WOLD DENNIS GORDON	68 ED 473-4581 71 CLA 781-1714 71 CLA 484-2786 MPW MAPLEWOOD 70 CLA 454-3623 WSP WEST ST PAUL 70 IT MTB MINNETONKA BCH 70 MORRS SAUK CENTRE 68 CLA 724-1690 MPL MINNEAPOLIS 70 CLA 257-7802 CENTER CITY 71 CLA MPL MINNEAPOLIS GRAD 771-8598 MPW AS IT	WOLFF JOHN HUGH 2245 STANFORD CT WOLFF JOHN MANEY WOLFF LESLIE ELMER 2501 LOWRY NE WOLFF LINDA SHAY 815 SE FULTON WOLFF MARY JOSEPHINE 1748 YORKSHIRE WOLFF MICHAEL ANDREW 421 CEDAR AV S WOLFF PAUL ALLAN 1126 5TH ST SE WOLFF STEVEN JERALD WOLFS IRENE ALICE 309 6TH ST SE WOLFSON KAREN THELMA P 751 GODDRICH AVE WOLFSON RICHARD MARTIN CENTENNIAL HALL WOLINSKI GERALD JOHN WOLK MARILYNN GOLDA 8308 W 30 1/2 ST WOLK ROBERT BERNARD WOLK SHEILA DARYL 1500 RUSSELL AVE N WOLKE GERARD GEORGE JR 2141 PARK AVE WOLKERSTORFER SR JOHN 2414 SO 7TH ST WOLKOWICZ JOSEPH HENRY 1646 ROME WOLL JANE ANN 4748 HARRIET AVE SO WOLLAK NORBERT JOSEPH 1390 BLACKMAN AVE WOLLEAT PATRICIA LYNN 96 BEDFORD ST SE WOLLER ROY ERNEST 851 W COPE AVE WOLLMUTH DEAN EDWIN 805 E RIVER ROAD WOLLSCHLAGER GARY GENE 801 UNIVERSITY AVE SE WOLLWAGE MARLIN IRWIN 812 7TH ST SE WOLNER BARBARA LYNN 1250 JESSIE ST WOLNER DAN AUSTIN 4821 PORTLAND SO WOLNER SHIRLEY ANN PIONEER COURT WOLNER STEPHEN LYNN 715 UNIVERSITY AVE SE WOLNIK JEFFREY STEPHEN 4112 NE TYLER WOLOSEWYCZ VICTOR 1400 ADAMS ST NE WOLSEY MARY MORRIS LOU WOLSTED MICHAEL JOEL WOLSZON MARGARET ANNE 1793 MARYKNOLL WOLSZON RICHARD JOSEPH 1793 MARYKNOLL WOLTER DONALD LOREN WOLTER RICHARD CARL TERRITORIAL HALL WOLTER WARREN HERBERT 1115 SE 5TH ST WOLTERS BARBARA JEAN 1874 DELAWARE AVE WOLTERS KATHLEEN MARY 2709 E SUPERIOR ST WOLTERS PATRICE RUTH 2709 E SUPERIOR WONDRA ALLAN GORDON 1210 CAMBRIDGE ST WONDRA MARILYN JOAN 57 W LOGAN WONG CHORNHUEY 709 15TH AVE SE WONG DAVID THOMAS 5617 HUMBOLDT AVE SO WONG EDWARD TOWL WONG FRED CARL WONG GREGORY STERLING 3701 PORTLAND AVE WONG HERBERT Y 621 BRYANT AVE N WONG IRENE 2430 11TH AVE SO WONG JOHN HOWARD TERRITORIAL HALL WONG JUDY MARILYN 3108 JERSEY AVE WONG MICHAEL WONG 514 14TH AVE SE WONG PATRICIA ANN 5617 HUMBOLDT AVE S WONG PAULA RUTH	71 MED 698-3115 STP ST PAUL GRAD DULUTH 69 PHARM 781-0891 MPL MADISON 71 CLA 331-7242 MPL MINNEAPOLIS 69 GC 698-9640 STP ST PAUL 70 LAW 335-5503 MPL ROCHESTER 69 LAW 331-1575 MPL WHITE BEAR LAKE 70 CLA 439-5175 GRAD 338-0239 MPL MISSION KS GRAD 225-5446 STP ST PAUL GRAD MPL BROOKLYN NY 68 GC 70 CLA 938-1115 SLP ST LOUIS PARK AS ED 71 CLA 521-1173 MPL MINNEAPOLIS 68 CLA 429-2670 MTB MAXWELL AFB AL GRAD 338-9381 MPL MINNEAPOLIS 68 CLA 698-0886 STP ST PAUL 70 CLA 825-0251 MPL MINNEAPOLIS 70 DULTH 727-7329 DULUTH GRAD 333-8834 MPL BRANCH 68 GC 484-3931 ROY ROSEVILLE 70 CLA MPL MINNEAPOLIS 70 LAW 331-4945 MPL FAIRMONT 70 CLA 331-2980 MPL BROOKTON 68 CLA 776-5985 STP BUTTERFIELD 70 CLA MPL MINNEAPOLIS 71 CLA MPL ST JAMES 69 ED MPL ST JAMES 71 IT 788-2656 CLH COLUMBIA HTS 70 CLA 781-7089 MPL MINNEAPOLIS GRAD GRAD 71 CLA 777-5924 MPW MAPLEWOOD 69 IT 777-5924 MPW MAPLEWOOD GRAD 71 CLA MPL CANNON FALLS 70 CLA 331-3432 MPL HOPKINS AS GC 451-8452 WSP WEST ST PAUL 69 DULUTH 728-4138 DULUTH 70 DULTH 728-4138 DULUTH 69 CLA HOP HOPKINS 68 ED 224-6994 STP GRAD 331-4439 MPL CHIAYI 70 CLA 824-9133 MPL MINNEAPOLIS GRAD AS IT ST CLOUD 69 CLA 824-2010 MPL MINNEAPOLIS 71 IT MPL MINNEAPOLIS GRAD 333-8050 MPL SAN FRANCISCO CA 71 CLA MPL BLOOMINGTON 71 CLA 929-5746 SLP ST LOUIS PARK 71 CLA 331-1702 MPL ROCHESTER 71 CLA 824-9133 MPL MINNEAPOLIS 68 ED ROCHESTER	WONG WAI CHEONG 725 8TH AVE SE WONSavage ROBERT LEB 1705 STEVENS AVE SO WOOD LINDA WONG 3040 EMERSON SO WOOD BARBARA WASHBURN 2058 CHARLTON RD WOOD BARRY LAMONT WOOD BYARD DEAN 1109 17TH AVE SE WOOD CHARLES FRANKLIN CENTENNIAL MALL WOOD CHESTER WAYNE JR WOOD DAVID ANDREW 871 W HOYT WOOD ELIZABETH ANN 5344 CHICAGO AVE SO WOOD GUY HARLAND VERMILION HALL 123 WOOD JACQUELINE MONTGO 445 REFLECTION RD WOOD JAMES FRAZER 15 SO 20TH AVE E WOOD JAMES RAYMOND 6238 GIRARD S WOOD JAMES THOMAS 3323 MC NAIR DR WOOD JANET DAILEY 122 MORRIS ST NW WOOD JEFFREY ROGER 1430 GRAND AVE WOOD JUDITH ANN SPOONER HALL WOOD MARY ROBERTA 2019 21ST AVE SO WOOD NANCY CHRISTINE 1430 GRAND AVE WOOD NANCY ELLIS 1720 W 76TH ST WOOD NEAL HAMILTON 2 2250 ACORN RD WOOD NORMA JEAN 105 SHEVLIN WOOD PAMELA KAYE 4305 MINNETONKA BLVD WOOD RAY WILLIAM 621 OAK ST SE WOOD RICHARD EUGENE 624 4TH AVE SE WOOD RICKEY DEAN 10308 ARROWHEAD NW WOOD ROBERT MATHEWSON 17 N OAKS RD WOOD SHARON HULTGREN C 1809 CARL ST WOOD STEPHEN RUSSELL WOOD STEVEN CHARLES 1390 SCHLETTI WOOD SUZANNE 1025 6TH ST SE WOOD VERNON DEAN 2245 NO SMELLING WOOD WALTER DONGAN WOOD WILLIAM ARNOLD 2297 HILLSIDE AVE WOODALL DONNA LAURAIN GRIGGS HALL K211 WOODARD CAROL JEANNE WOODARD MICHAEL DENNIS 4215 LONDON RD WOODCOCK JANE ALISON 5609 COUNTRYSIDE RD WOODCOCK RICHARD D WOODE CHERYL ANN 5817 MARYLAND AVE NO WOODE KATHLEEN EVELYN 1112 SE 4TH ST WOODFILL BRENT THOMAS 1605 N LILAC DR WOODFILL JOHN FREDERIC 1606 W 66TH ST WOODFORD GARY RUSSELL 815 13TH AVE SE WOODHOUSE RICHARD CHAR 2111 21ST AVE SO WOODKE AUDREY E 505 15TH AVE SE APT 5 WOODLEY WILLIAM LOUIS 1011 4TH ST SE WOODRICH WARREN BROWN WOODRUFF DAVID LESLIE WOODRUFF ROGER WESLEY WOODRUFF SUSAN GAIL WOODS CARL WILLIAM WOODS JERROLD LEB 2111 GORDON AVE WOODS LYNNE 418 11TH AVE SE	GRAD 335-3472 MPL SAGIL JOHORE 68 CLA 333-8660 MPL MINNEAPOLIS 70 CLA 824-2503 MPL MINNEAPOLIS 70 CLA 611-3716 STP ST PAUL 71 IT GRAD 331-8594 MPL BOISE ID 68 IT 339-7421 MPL PLAINVIEW 69 IT 71 CLA STP ST PAUL 71 CLA 825-2663 MPL MINNEAPOLIS 69 DULTH 724-9886 ROCHESTER 71 CLA 432-5288 ROS ROSEMOUNT 70 DULTH 724-9454 DULUTH 71 IT 869-0398 RMF RICHFIELD 68 ED 588-7543 ROB ROBBINSDALE GRAD 633-8425 NWB WELLESLEY MA 70 CLA 698-6583 STP ST PAUL 70 MORRS 589-4693 BROWNSDALE 69 CLA 333-2675 MPL FAIRMONT 71 CLA 698-6583 STP ST PAUL EDN 70 CLA 631-1457 ROY ROSEVILLE GRAD 373-3461 MPL CAMP VERDE AZ 68 ED 926-4245 SLP ST LOUIS PARK 71 MED 331-1744 MPL GRAMADA GRAD 336-6838 MPL CANTON OH 71 IT 427-1594 CNR COON RAPIDS 69 VET M 484-5673 STP GRAD 645-2944 ROV CANNON FALLS 68 BUS 69 GC 489-9475 68 PT 331-1863 MPL LOCKPORT IL 68 AGFHE ROY AUSTIN GRAD GRAD 645-3770 STP CHINO CA 68 DULTH 724-9978 GRAND RAPIDS 69 NURS 71 DULTH 525-5255 DULUTH 70 AGFHE 929-4067 EDN EDINA GRAD 71 CLA KE7-6596 CYT CRYSTAL 69 CLA 331-7820 MPL CRYSTAL 68 GC 545-4876 GOV GOLDEN VALLEY 68 GC UN9-3591 RHF RICHFIELD 69 IT 331-5507 MPL REDWOOD FALLS GRAD 336-0924 MPL MASON CITY IA GRAD 331-3668 MPL DULUTH 68 CLA FE6-9359 DPH 69 GC GRAD 69 IT 70 MORRS 68 GC 822-2416 MPL 70 VET M 644-1649 STP NEW RICHMOND WI GRAD MPL ANCHORAGE AK
---	--	---	---	--	--











ZORZI EDWARD SILVIO GRAD 335-8339  
2014 3RD AVE SO MPL SPFLD MA  
ZOSKE LOUISE MARIE 71 CLA 222-6467  
235 E ARION WSP WEST ST PAUL  
ZOSS BARRY DAVID 71 PHARM WA6-3408  
4612 W 28TH ST SLP ST LOUIS PARK  
ZOSS ROBERT ALAN 69 IT

ZOTALIS CHARLES ARTIST 70 CLA 489-0647  
938 W CALIFORNIA STP ST PAUL  
ZOUBER JACK GREGORY 70 CLA 522-2400  
900 QUEEN AVE N MPL MINNEAPOLIS  
ZOUZOUAS GARY J GRAD  
CENTENNIAL HALL MPL DEMAREST NJ  
ZSCHUNKE MARION JANE 69 ED 644-1689  
1662 ENGLEWOOD AVE STP  
ZUBER ALAINE MICHELLE 68 DULTH 724-6072  
217 ST MARIE BIWABIK  
ZUBER JERI ERVIN 68 IT 331-2441  
1327 7TH ST SE MPL MINNEAPOLIS  
ZUBER WILLIAM RANSLow GRAD 222-1128  
589 SUMMIT AVE STP  
ZUBULAKE HARRY JAMES 71 CLA  
TERRITORIAL HALL MPL ANOKA  
ZUCCO WILLIAM CHARLES 70 LAN 699-9211  
520 MT CURVE BLVD STP ST PAUL  
ZUCK WILLIAM CHARLES 71 DULTH 725-2051  
434 W REDWING ST DULUTH  
ZUCKER ARTHUR BRUCE GRAD

ZUCKER LAURIE HALPERIN GRAD 374-2979  
2222 GIRARD AVE SO MPL NEW YORK NY  
ZUCKWEILER GARY RAY 70 CLA 459-1878  
438 SCOTT DRIVE CTG COTTAGE GROVE  
ZUELKE DARYL EUGENE 71 IT 373-5602  
TERRITORIAL HALL MPL ALBERT LEA  
ZUGER WILLIAM PETER 69 CLA  
3304 CENTENNIAL HALL MPL BISMARCK ND  
ZUIDEMA SUZANNE MARIE 69 CLA  
1320 7TH ST SE MPL COLUMBIA HTS  
ZUKOWSKI CHRISTINE MAR GRAD  
1818 ARTHUR ST NE MPL LA SALLE IL  
ZUMBERGE NANCY JO 69 GC 926-6323  
4228 VINCENT AVE SO MPL MINNEAPOLIS  
ZUMBERGE TERRY ALLEN 68 GC 822-7770  
3300 BRYANT AVE SO MPL MINNEAPOLIS  
ZUMBRUNNEN KEITH GEORG 70 DULTH 724-9801  
J RIGGS HALL B211 GRAND RAPIDS  
ZUMWALDE MARGARET CATH 71 CLA 455-4358  
300 18TH AVE SO SSP SOUTH ST PAUL  
ZUPANCICH ALBERT OWEN 70 CLA

TOWER:  
ZUPETZ JEANNE CAROL 71 DULTH 724-9950  
GRIGGS HALL L217 MOUNTAIN IRON  
ZUPFER JOHN HOWARD GRAD 488-1861  
1121 NO OXFORD STP  
ZUPONCIC HERMAN MARTIN 70 DULTH 727-2124  
22 E 6TH ST AURORA  
ZUPPKE KURT EDWARD 69 CLA 938-3919  
5316 BLAKE RD EDN EDINA  
ZUREK RICHARD JAMES 70 CLA 533-1097  
3556 IDAHO AVE N CYT CRYSTAL  
ZURN KATHALEEN MARYANN 69 AGFHE 338-2034  
1926 PLEASANT AVE S MPL CALLAWAY  
ZURN ROGER GORDON GRAD 929-1085  
6920 WTKA BLVD SLP  
ZWACH DENNIS JOSEPH 71 AGFHE

ZWACH MERION DEAN 69 ED 339-7421  
CENTENNIAL HALL MPL TRACY  
ZWAGERMAN JAY ALLYN GRAD 544-6748  
1400 NO DOUGLAS DR GOV ZEELAND MI  
ZWEBER HELEN MARY 68 CLA 646-0518  
1515 NO PASCAL ST STP LAKEVILLE  
ZWEBER WAYNE MICHAEL 69 GC 224-8243  
282 W BERNARD WSP WEST ST PAUL  
ZWEIG GARY RICHARD 68 CLA 439-3461  
553 NO 2ND ST BPT BAYPORT  
ZWEIG TIMOTHY HUGHES 68 BUS 331-2770  
9 MALCOLM AVE SE MPL STILLWATER  
ZWEIGBAUM LARRY HOWARD 71 PHARM 545-3113  
6910 W 23RD ST SLP ST LOUIS PARK  
ZHERMAN PATRICIA ANNE AS CLA 331-7896  
817 SE 7TH ST MPL  
ZWIASKA SANDRA LEE 70 CLA 560-5834  
4924 NE 7TH ST CLM COLUMBIA HTS  
ZWIEG GARY ALAN 69 CLA 489-0235  
799 PARK ST STP ST PAUL  
ZWINGELBERG MARK MANLE 70 CLA 338-7936  
404 SE 2ND AVE APT 101 MPL LITTLE FALLS  
ZWOLLE DONALD RAY GRAD

ZYCH THOMAS GEORGE 70 AGFHE 646-1929  
1475 N CLEVELAND STP GRACEVILLE  
ZYTEKOVICZ THOMAS HENRY GRAD

ZYWICKI THOMAS EDWIN 71 IT 786-3194  
1619 73RD AVE NE FRD FRIDLEY  
ZYWIEC FRANCIS ANDREW 69 CLA 431-6577  
233 BURON LANE SSP INVER GROVE

MAYO GRADUATE SCHOOL OF MEDICINE REGISTRANTS

ABDOU, NABIH IBRAHIM  
 ADAMS, ROBERT W.  
 ADKINS, WILLIAM C.  
 ALLAN, CHRISTOPHER J  
 ALLEN, PATRICK G.  
 ALLEN, RAY EDMOND  
 ALTENBURG, BERNARD  
 ALTMAN, ROBERT LEE  
 AMBRE, JOHN JOSEPH  
 AMBROSIONI, ETTORE  
 ANMON, HELMUT VOLKER  
 ANASTASI, LORENE M  
 ANDERSON, JAMES ALLE  
 ARKIN, CHARLES RICHA  
 ARMBRUSTER, ROBERT  
 ARNOLD, GORDON  
 ARRIGONI, MARCO GIUS  
 ASHBY, THOMAS M  
 ATEN, JAMES L  
 AUERBACH, ARTHUR M  
 AUGER, ARMAND J  
 AUGER, RAYMOND GEORG  
 AVASTHEY, PRABHA  
 BACHNER, IRVING NATH  
 BAKER, JAMES A  
 BANDILLA, KLAUS K  
 BARBEE, CHARLES WALK  
 BARNARDO, DAVID ERIC  
 BARTON, FORBES M JR.  
 BAUMGARTNER, C JOHN  
 BEASLEY, HALEY K  
 BECHAMPS, GERALD J  
 BECKENBAUGH, ROBERT  
 BECKERING, RAYMOND  
 BEELER, GEORGE W. JR  
 BEIGHLE, RICHARD WAL  
 BELL, RICHARD A  
 BENJAMIN, IMMANUEL  
 BERGER, GEORGE M B  
 BERGER, STEPHEN MILE  
 BERGH, ALLEN VERNON  
 BERWALD, CHARLES JOH  
 BERWALD, DAVID MORTO  
 BIEGER, R CYRIL  
 BILSTAD, JAMES M.  
 BIZARRO, RAUL OLIVEI  
 BJARNASON, DAVID FRA  
 BJORNSSON, SIGURDUR  
 BLAIR, ROBERT D G  
 BLONDIN, CLAUDE  
 BLOSSMAN, ROBERT C  
 BOMAN, PETER L.  
 BOND, ROBERT EDWARD  
 BONEBRAKE, ROBERT A  
 BOSLAND, JON HOWARD  
 BOULWARE, FREDERICK  
 BOURGEOIS, MAURICE J  
 BOWER, PHILIP J.  
 BOWERS, FRANK R  
 BOYCE, DANIEL  
 BOYD, ALLEN STREET  
 BOYER, STANLEY WADE  
 BRANDSTATER, MURRAY  
 BREIVIS, JAMES STANL  
 BRENNER, CEDRIC GORD  
 BRENNAN, LEONARD JR  
 BRIGHTBILL, FREDERIC  
 BRINKMAN, JAMES F.  
 BROOKLER, KENNETH H  
 BROOKSBY, GERALD A  
 BROWN, ALGIE CURRY  
 BROWN, GEORGE R  
 BROWN, LARRY RANDOLP  
 BROWN, PATRICK M  
 BROWN, RANDALL STEVE  
 BROWN, RONALD DUANE  
 BROWNFIELD, JAMES AL  
 BRUCE, JAMES DOUGLAS  
 BUCCHIERE, JOHN J JR  
 BUNCH, THOMAS WILLAR  
 BUNTAIN, WILLIAM LER  
 BURGE, KELMAR MON JR  
 BURGESS, JOHN NIGEL  
 BURKHART, JAMES M  
 BUSCEMI, MICHAEL F  
 BUSH, STEPHEN THOMAS  
 BUZA, ROBERT CHARLES  
 BYRON, ROBERT SILL

CAEIRO, TOMAS FRANCI  
 CALDWELL, JOSEPH GRI  
 CALI, ROBERT W  
 CAMERON, ALAN JOHN  
 CAMPBELL, FREDERICK  
 CAMPBELL, MARGE LEE  
 CAMPION, BRIAN C.  
 CANT, BARRY R  
 CANTWELL, JOHN DAVIS  
 CARDOZA, FRANCISCO  
 CAREY, MARY ANNE  
 CARLO, OSCAR AUGUST  
 CARNAHAN, CHARLES EU  
 CARRINGTON, STEWART  
 CARTER, DAVID ALLEN  
 CASSAN, STANLEY MORR  
 CHEN, KWANG-MING  
 CHIDLON, JOHN HENDRI  
 CHILES, JAY LEE  
 CHIROFF, RICHARD T  
 CHIU, SYLVESTER SHIN  
 CHOW, ALROY ANDREW  
 CHULMAN, MIGUEL ANGE  
 CHUNG, MYUNG H  
 CLARK, JACK LEWIS  
 CLELAND, JOHN  
 CLOUTIER, MARK D  
 CODER, DONALD M  
 COETZER, HENDRIK MAR  
 COHEN, LEROY ELLIS  
 COHEN, MANLEY  
 COHEN, RAFAEL  
 COLEMAN, ROBERT LEHN  
 COLLIGAN, PAUL C  
 COLLINS, KATHLEEN MA  
 COLLINS, ROGER THEOD  
 COLLISON, ROBERT WES  
 CONN, DOYT LADEAN  
 COOK, DAVID MICHAEL  
 COOPER, HERBERT ASEL  
 COOPERMAN, AVRAM M  
 COTTON, GERALD EUGEN  
 COTTRELL, RICHARD E  
 COULAN, CRAIG MERRIL  
 CRACCO, ROGER Q  
 CREASMAN, JOHN PAUL  
 CREMER, GUILLERMO M  
 CRIST, ROBERT SAMUEL  
 CROUCH, THOMAS TINDA  
 CROW, RICHARD S  
 CSEUZ, KALHAN A  
 CULLIGAN, DAVID E.  
 CUMMINS, BEN M  
 CUNNINGHAM, JOHN  
 DAICHMAN, RICARDO  
 DANKMYER, FREDERICK  
 DART, LEROY H JR  
 DATNOW, BORIS  
 DAVID, EDUARDO  
 DAVID, RONALD BRIAN  
 DAVIDSON, ALLAN D  
 DAVIDSON, CHESTER JR  
 DAYTON, DAVID AMSBRY  
 DECKER, RICHARD H  
 DEGER, GRANT EDWARD  
 DEJAGER, ROBERT LEON  
 DEMARCO, PETER R.  
 DESJARDINS, RONALD P  
 DETENBECK, LEE CLARK  
 DEVROEDE, GHISLAIN  
 DEWEES, GUY B. III  
 DICKEN, CHARLES H  
 DILLEY, JOHN JEROME  
 DIMAGNO, EUGENE PASQ  
 DIPASQUALE, JOSEPH A  
 DISNEY, THOMAS FRED  
 DIXON, GEORGE D  
 DOLAN, CHARLES T  
 DOZOIS, ROGER ROBERT  
 DRY, THOMAS J  
 DUANE, DRAKE DELAND  
 DUNLAP, ROBERT W  
 DUNN, FRANCIS C. JR  
 DUNN, ROBERT JOSEPH  
 DUPREE, ENNETT LEE  
 DUVAL, DAVID L  
 DUVOISIN, GEORGE E  
 DYKKE, DAVID RICHARD

ECHOLS, WILLIAM J  
 ECKELBERG, MERLYN E  
 EDWARDS, WALTER G JR  
 ELLIS, GEORGE GRAHAM  
 ELMQVIST, DAN  
 EMERSON, ROBERT KEIT  
 EMMONS, HELEN J  
 EMMONS, WILLIAM FRAN  
 ENGELBERG, JERRY  
 ERRICO, JAMES MELTON  
 ESELIUS, ERIK PHILIP  
 EUBANKS, DONALD R  
 EVANS, TITUS CA JR  
 FABER, JOHN W.  
 FACER, GEORGE W  
 FAIMAN, CHARLES  
 FATOURECHI, VAHAB  
 FAY, THOMAS MARTIN  
 FEHRENBAKER, LAWRENC  
 FEINBERG, JACK H  
 FEINTUCH, THEODORE A  
 FELLOWS, JOE FRANK  
 FELSTED, THOMAS RUSS  
 FENNING, ROBERT L  
 FERGUSON, DAVID ARTH  
 FERNANDEZ, MANUEL NI  
 FIELD, BRENTON H JR.  
 FINA, CHARLES P.  
 FINCH, JOHN ENNETT  
 FINK, LAWRENCE HOLLI  
 FINKELSTEIN, JOEL  
 FISH, CHARLES R  
 FISHER, DARRELL ERVI  
 FITZ, FREDERICK WILL  
 FLICK, WILLIAM FREDR  
 FLORES, JOSE C  
 FOCHTMAN, JOHN ADOLP  
 FORKER, ALAN D.  
 FOSTER, THOMAS NEWTO  
 FOWLER, FRANKLIN SCO  
 FOX, ABE L JR  
 FOX, JOHN A  
 FRAKER, KEITH EDWARD  
 FREDERICKS, EDWARD J  
 FREEL, ROBERT J  
 FROHNERT, PETER P  
 FULLER, EDWIN BERTRA  
 FULTON, RICHARD EUGE  
 FURMAN, PHILIP J  
 FURSZYFER, JACOB  
 GAFFEY, THOMAS A JR.  
 GARCIA, EDUARDO  
 GARRISON, CHARLES O  
 GAU, GERALD T  
 GEALL, MICHAEL GEORG  
 GEISLER, JOHN D  
 GENTLING, PETER A.  
 GERBER, CHARLES TREN  
 GERSTNER, PHILLIP L  
 GESUNDHEIT, SIM  
 GHARIB, HOSSEIN  
 GILBAUGH, JAMES H JR  
 GILBERT, BARRY KENT  
 GISVOLD, JOHN J  
 GITNICK, GARY  
 GLATTRE, EYSTEIN  
 GO, VAY LIANG WONG  
 GODSIL, RAYMOND DEAN  
 GOLDMAN, SHERWIN  
 GOLDNER, JOHN CHARLE  
 GOODWIN, HENRY NORTH  
 GOREN, HERSHEL  
 GOTTSCHALK, PAUL G  
 GOULD, RONALD JAY  
 GRACEY, DOUGLAS R  
 GRAF, JOHN A  
 GREENBERG, BURTON HO  
 GRIFFITHS, ROBERT WR  
 GRUSKIN, SANFORD ERN  
 GUDMUNDSSON, KRISTIN  
 GULLEDGE, ALBERT D  
 GULLER, BARBARA  
 GUNDERSON, DAVID HAR  
 GUNNLAUGSSON, GUNNAR  
 GUNNLAUGSSON, OLAFUR  
 HABLE, KATHLEEN ANNE  
 HADDAD, NICKIE JOE  
 HAHN, FREDERICK JR.

HATGLER, EDWARD DAVI  
 HALL, JACK W  
 HAH, O EMERSON JR  
 HAMAMOTO, KEN  
 HAMILTON, WARREN W  
 HAMMARGREN, LONNIE L  
 HAMMOND, HUGH DARVEL  
 HANASH, KANAL ANTOIN  
 HANSARD, DONALD RAY  
  
 HANSEN, STEPHEN LLOY  
 HANSON, JEROME R  
 HARBOLD, NORRIS B JR  
 HARDING, JOHN SCOTT  
 HARDY, KENT MILTON  
 HARRELL, JERRY DEWIT  
 HARRIS, JOHN A.  
 HARVEY, RICHARD FRAN  
 HASTINGS, BARBARA AN  
 HASTINGS, JOHN DANIE  
 HATAYAMA, YOSHIYUKI  
 HATHAWAY, DAVID S  
 MATTERY, ROBERT R JR  
 HAVEN, JAMES JAY  
 HAVIG, TERRANCE ARLA  
 HAME, ANTHONY  
 HAWS, JOSEPH A.  
 HAYASHI, MELVIN MITS  
 HAZELL, SHIRLEY GLEN  
 HENDERSON, ROBERT M  
 HENDERSON, W DOUGLAS  
 HENRY, JAMES D  
 HEPPER, KENNETH NORM  
 HERTZLER, JERRAD J  
 HILGERS, ROBERT D  
 HINTZ, CHARLES STUEB  
 HIRSCH, FREDERICK D  
 HIRZ, DALE LEE  
 HOAGLAND, H CLARK  
 HODGSON, STEPHEN FRE  
 HOEHN, JAMES GURNEY  
 HOENES, RUSSELL LOUI  
 HOLN, PETER CHRISTIA  
 HOLSTAD, CREIGHTON A  
 HOOD, RODERICK P  
 HORTON, VERN HICKS  
 HOUSER, OTIS WAYNE  
 HOWELL, JOHN LLEWELY  
 HUGHES, RICHARD C.  
 HUMMER, WILLIAM K.  
 HUNG, JUI-SUNG  
 HUTCHINSON, JAMES JR  
 IACOBUCCI, ALFRED  
 ILLIG, WILLIAM P  
 IMPERTAL, ROLAND LAZ  
 IRWIN, JACK C. JR.  
 ISBELL, ROBERT G  
 IVEY, DAVID M.  
 JACKMAN, ROGER J.  
 JACOBSON, JAMES L  
 JACOBSON, STEPHEN G  
 JANDA, WAYNE EDWARD  
 JAMES, DONALD R  
  
 JANSSEN, HEIDRUM  
 JAY, ALAN ROBERT  
 JEREB, JOHN A  
 JESSEN, HUASCAR ENRI  
 JIMENEZ, SERGIO ASTE  
 JOHNS, DONNELL FRAN  
 JOHNSON, CHARLES LOR  
 JOHNSON, DAVID C  
 JOHNSON, GERHARD J  
 JOHNSON, KENNETH ALL  
 JOHNSON, ROBERT MELV  
 JOHNSON, THOMAS FRAN  
 JONES, ALLEN HAULSBY  
 JONES, H ROYDEN JR  
 JONES, HARRY F  
 JORDAN, JAMES JOSEPH  
 JORDON, ROBERT EARL  
 JOY, WILLIAM BRUGH  
 KAD, CHUN CHING  
 KASHER, RAYMOND J.  
 KATORI, RYO  
 KAMAMOTO, TAKESHI  
 KELLER, EUGENE E  
 KELLEY, JOHN J

KELLY, KEITH ALAN  
KENEPICK, THOMAS P  
KENNEY, EDWARD JOHN  
KERN, EUGENE B  
KHONSARI, STAVOSH  
KIMBER, WILLIAM J  
KING, JOHN EDWIN  
KISHON, YEHEZKIEL  
KOBAYASHI, SHIGEAKI  
KOLB, EDITH  
KOLB, HARVIN OTTO  
KOLKER, PAUL  
KRIGSTEN, ELI JAY  
KROLL, LARRY LEROY  
KRUEGER, MYRON KEITH  
KRUSE, ROBERT LELAND  
KUBISTA, THEODORE P  
KULLMANN, GEORGE LEO  
KUSTER, GUSTAVO  
LAGOS, JORGE C  
LAHOOD, JOSEPH J  
LAKE, THOMAS PHILIP  
LAMARCA, DONALD DOMI  
LANGLOM, NIKOLAUS DI  
LANIER, BOBBY G  
LAPORTE, LEON RENE  
LAROCHE, GILLES P  
LARSON, RICHARD HENR  
LARSON, STEPHEN L  
LATTIN, JOHN ELLIS  
LAUFENBERG, HENRY JR  
LAUPER, NIKLAUS THOM  
LAURNEN, EDWIN L  
LAVERTU, JULIEN GEOR  
LAXDAL, THROSTUR  
LAYLE, NANCY JOAN  
LEACH, GARY RUSSELL  
LEAVELLE, DENNIS ELV  
LEE, JU HAO  
LEE, MINAKO YOSHIOKA  
LEE, MING JONG  
LEE, PING-CHEUNG  
LEE, ROBERT GEORGE  
LEECH, STEPHEN HARRY  
LEGE, DAVID ANTHONY  
LERNER, KENNETH GERA  
LEVIT, SIMON ALBERT  
LEVY, BERNARD PIUS  
LEWALL, DAVID B  
LEWIS, ANDREW J  
LEWIS, WILLIAM STANL

LILLY, ALAN DOUGLAS  
LINEBERRY, DICE KYLE  
LITWAK, OSCAR  
LONG, JOHN CHARLES  
LOSITO, RAYMOND J  
LUDES, BERNARD F  
LYNCH, JOSEPH DANIEL  
MACDONALD, CHARLES J  
MACDONALD, GILES F  
MACDONALD, RONALD DO  
MACDONALD, VANCE D  
MACKENZIE, KENNETH R  
MACY, NORMAN E  
MADSEN, PETER NEVILL  
MAGNANT, CLAUDE DANI  
MAGNANT, HENRY ANTHO  
MAGNESS, JOHN L  
MAHOUR, GHOLAM-HOSSE  
MAIR, DOUGLAS D  
MALEK, REZA SAID  
HANSON, ARTHUR DAVID  
HANSON, ROBERTO RAMO  
MARCoux, ANDRE  
MARK, ALEXANDER LEE  
MARTALOCK, DEAN LANE  
MARTYN, DAVID THOMAS  
MATTSON, ROGER ALBER  
MAZZA, JOSEPH J.  
MCARTHUR, ROBERT GER  
MCCARRON, EDWARD JOH  
MCCONAHAY, DAVID RON  
MCCOY, ALLEN BURN JR  
MCCULLY, JAMES GREIG  
MCDONALD, JEANNETTE H  
MCGOWAN, RONALD LEE  
MCKINNE, RICHARD ALA  
MCLAUGHLIN, RICHARD  
MCLEAN, PETER  
MCLENNAN, KATHERINE  
MEHLISCH, DONALD ROB  
MEKHJIAN, HAGOP SARK  
MERCER, EDWARD NEVIL  
MERIDETH, JOHN  
MERRICK, DAVID KENT  
MERTENS, BENNY FRANK  
HESS, CHARLES FRANCI  
MESSICK, JOSEPH M JR  
MEYER, JAMES JACOB  
MEYER, MELVIN EUGENE  
MEYER, WILLIAM CAMPB

MICHEL, BENO  
MIDYETT, FREEMAN ALL  
MILICIC, MATKO  
MILLER, DONALD R  
MILLER, JOE IRVIN JR  
MILLER, JOHN W JR  
MINIELLY, JOHN A.  
MITCHELL, JOHN C III  
MOCKERT, THOMAS JR  
MOELLER, HENRY G JR  
MOHR, ARMIN ASMUS  
MOORE, DANIEL LEE  
MORGAN, PAUL R  
MORGAN, REGINALD GEO  
MORGAN, STEPHAN S  
MOUCHON, MARD PAUL  
MOULAERT, ANDRE JULE  
MULCAHY, JOHN JOSEPH  
MULDOON, SHEILA MARY  
MULLANAX, MILTON GAY  
MUSSELMAN, BERNARD C  
MYERS, GEORGE M JR  
MYERS, THOMAS T  
NATHAN, DAVID  
NATHAN, FRED F  
NAYA, CARLOS G  
NAVERT, HENRI  
NANROCKI, ALBERT  
NELSON, AUDREY MAY  
NELSON, J. PHILLIP  
NELSON, JOHN ROBERT  
NELSON, RODGER K  
NESSET, DAVID GEORGE  
NETTLES, JOE LEE  
NETTROUR, LEWIS FAIR  
NETTROUR, WALTER S  
NEMMAN, DONALD R  
NGUYEN, VU VAN  
NICHOLAS, KARL RAY K  
NIERLI, RAUL L.  
NIKOLAI, LEON MARTIN  
NOBREGA, FRED T  
NOLAN, ALFRED C.  
NOLAN, NICHOLAS G.  
NUSS, DONALD  
OBETZ, S. WENDELL  
ODYNIEC, NORMAN A  
OELS, HELEN C  
OGLE, RICHARD G  
OKANE, HUGH OLIVER  
OKESON, GYMAN CLARE  
OLSON, NEAL R.  
ONSTAD, THOMAS A  
OSHIBA, SUSUMU  
OSULLIVAN, MICHAEL B  
OXMAN, HERBERT ARTHU  
PAARLBERG, DONALD  
PACHECO, JOSE CARLOS  
PAGET, EDWARD THURST  
PATROLERO, PETER C.  
PAJARI, ANTTI K O  
PAK, TAI JIN  
PARKER, HOWARD GARY  
PARKER, JOSEPH C JR  
PASTERNAK, BARTLOME  
PASTERNAK, HERBERT S  
PATRICK, DONALD LEE  
PAYNE, ROBERT A  
PAYNE, STANLEY R.  
PERSON, DONALD AMES  
PETERSBURG, SANDRA J  
PETERSON, DALE T  
PETRIE, CLARENCE ROL  
PIKIELNY, RALPH TOBI  
PINEDA FUENTES, ALVA  
PINGREE, GEORGE C  
PINILLA, CESAR  
PLIMPTON, DAVID BLAI  
PLUMMER, ALAN LANE  
PLUTH, JAMES R.  
PODOLL, LEE NOREM  
POLEY, J RAINER  
PONGPANICH, BOONCHO  
POPE, FERGUS BAYLEY  
POTTER, WILLIAM ARTH  
POZUELO-UTANDA, JOSE  
PPOOL, DAVID B JR.  
PRACHUABOMH, CHADSRI  
RAINUNDO, HUGO SA  
RAMIREZ MADRID, HUGO  
RAMIREZ-PEREDE, JORG  
RAMIREZ, PERLA FAJAR  
RASTELLI, GIAN C  
RAVANO, JOSE FABRICA  
REAGAN, THOMAS JOSEP  
REDFIELD, NICHOLAS P  
REED, JOHN H JR  
REILLY, WILLIAM F JR  
REINER, CARL E.  
RETZLAFF, JOHN A  
REYNOLDS, JAMES CART  
RHODES, JOHN

RICK, GREGORY GEO JR  
RIEMER, DONALD EUGEN  
RIFE, CHARLES C  
RILEY, FENKICK C JR  
RIVERS, THOMAS ARTHU  
RODMAN, CHARLES ARTH  
RODRIGUES GOMES, MAN  
ROLAND, CHARLES  
ROSENBAUM, ALAN HOWA  
ROSENBERG, SIDNEY H  
ROSI, TOMLIN CAPPS  
ROTH, GEORGE R JR  
ROULEAU, CLAUDE A  
ROY, PAUL H  
ROYALS, DAGGETT O  
RULFS, DAVID M JR  
RUSSELL, THOMAS II  
RYDELL, RALPH EDWARD  
SAARNI, MATTI ILMARI  
SABENS, JAMES ALBERT  
SALAZAR, MAURICIO  
SALVADOR, ANTONIO HE  
SANCHEZ-CASIS, GERMA  
SANDERS, WILLIAM M  
SANDERSON, IAIN DAVI  
SANDOK, BURTON ALAN  
SANFELIPPO, PETER MI  
SANTOS, RAY E.  
SANTOSCOY, GILBERT S  
SCHELLINGER, DIETER  
SCHIMA, EDWARD M  
SCHLEIN, ALLEN PHILI  
SCHMID, WALTER C  
SCHMIOT, ARNOLD P  
SCHMUR, PAUL LEO  
SCHOEN, ROLAND FRANZ  
SCHRANTZ, ROBERT D  
SCHROEDER, DAVID HED  
SCHROETER, ARNOLD L  
SCOFIELD, EDWARD L  
SCOTT, WYLIE T JR  
SEBALD, JOHN R  
SEMEL, GEORGE HERBER  
SEMERAD, EMANUEL  
SEPP, MAX GEORG FLOR  
SERVICE, FREDERICK J  
SEYBOLD, MARJORIE E  
SHEEDY, PATRICK F  
SHEEHAN, WILLIAM CHA  
SHERIDAN, PHILLIP JO  
SHERTZER, JOHN H  
SHIN, MYUNG HI  
SHORTER, RHIANNON  
SIDNER, ROBERT DUNBA  
SIEBERT, RICHARD CAR  
SIEMENS, PETER  
SIM, FRANKLIN H  
SIMONS, GEORGE W  
SIMPSON, THOMAS E  
SINCLAIR, RICHARD M  
SITTIPONG, RUNGSON  
SKOLNICK, JUDAH L  
SMITH, CHARLES STEPH  
SMITH, GEORGE R  
SMITH, JUDITH CHERRY  
SMITH, MAX  
SNIDER, JAMES HOWARD  
SNYDER, ARTHUR F  
SOLTANI, JAHANGUIR  
SOUADJIAN, JACQUES V  
SOUKUP, DENNIS ALBIN  
SOUTHALL, ROGERS C.  
SPANN, RICHARD WARNE  
SPARKS, JAMES THOMAS  
SPEARMAN, WILLIAM BE  
SPENCER, STEVEN KNOX  
SPIEGEL, RONALD NORT  
SPRAGG, THOMAS R.  
SPRAGINS, JOEL FRED  
SPRAGUE, JOHN H  
SPRING, DONALD ARTHU  
STACEY, RICHARD R  
STAMBUK, BERIGOJ KAR  
STARKEY, THOMAS A  
STAUFFER, RICHARD N  
STEIN, PAUL  
STEINBRECHER, LEROY  
STEINFELD, CARROLL M  
STENSETH, JON H  
STEPHENS, BURL JR  
STEPHENS, DAVID H  
STERLING, WILLIAM A.  
STERN, BARRY LEWIS  
STEVENS, JOHN CLARKE  
STOKES, JOHN P.  
STUBBS, SAMUEL EDWAR  
SUAREZ, JORGE  
SUTTER, RONALD D  
SUROS, JUAN  
SUTOR, ANTON HEINZ  
SUTTHIMAN, PHAIBUL  
SWEETING, RICHARD C

SZOSTAK, ROBERT J  
SZURSZEMSKI, JOSEPH  
TACHOVSKY, THOMAS J  
TAHARA, HIROYA  
TALavera, JOSE MESIN  
TANCREDI, ROBERT G  
TAPPER, EDWARD M  
TAYLOR, DEAN GATES  
TEEN, MARTIN VAN  
THEUERKAUF, FRANK JR  
THEW, ROY FARLEY  
THISTLE, JOHNSON L  
THOEN, CHARLES OREL  
THOMPSON, DENNIS P  
THOMPSON, WAYMAN JR  
THOMPSON, WILLIAM M  
THORSTEINSSON, V T  
THORVALDSSON, S  
TIFFANY, JOSEPH CALV  
TODD, DAVID W  
TOFT, THOMAS VICTOR  
TOMPKINS, RICHARD B  
TOWNSEND, CLARY HENR  
TSAKIRIS, PETER  
TSAKIRIS, ANASTASIOS  
TUCKER, GLEN MCFARLA  
TURNER, EUGENE FAY  
TURNER, JAMES A  
TURNER, RICHARD HAGG  
TYCE, GERTRUDE M  
UCEDA, JORGE ENRIQUE  
UEDA, MASAOKI  
UMNI, KOLATHUR KRISH  
VALKO, ROBERT M  
VAN DELLEN, RICHARD  
VAN HEERDEN, JONATHA  
VAN NESS, NOEL THOMA  
VAN SCOY, ROBERT EVE  
VANDENBERG, CHRISTIA  
VANDENBERG, RUSSELL  
VANDERSPEK, JOHANNES  
VANDERSTEEN, PAUL RI  
VANDERVOORT, ROBERT  
VAUGHN, KENNETH W JR  
VELASQUEZ, ALVARO  
VERMILLION, STANLEY  
VESSER, HUBERT H JR  
VILES, PETER HAYES  
VITTANDS, INGVARIS JA  
VON BERNUTH, GOTZ F  
WALLER, ROBERT REX  
WALLS, JOSEPH T  
WALSH, WILLIAM EMMET  
WANG, JOSEF KING-SU  
WARDILL, KENNETH EDW  
WARREN, MICHAEL MARK  
WASHINGTON, JOHN II  
WATKINS, PHILLIP CAN  
WATTERSON, WILLIAM M  
WEBB-PEPLOE, MICHAEL  
WEBB, DONALD E  
WEBER, WILLIAM F.  
WEBSTER, KIRK HOWELL  
WEERASOORIYA, LASHMA  
WEICK, JAMES KAYE  
WEIER, THOMAS EDWARD  
WEILAND, LOUIS HENRY  
WEINGART, JON L  
WEISBERG, MARTIN G  
WEITZ, JOHN THOMAS  
WELLEK, MARK A  
WENGER, MARLIN ESBEN  
WESTBROOK, PHILIP R  
WHAREN, ROBERT ELLSW  
WHITE, HARVEY I.  
WHITE, JOHN W JR  
WHITE, ROGER DEAN  
WHITE, STEWART ANDRE  
WHITTAKER, LORIN D  
WHYTE, THOMAS R  
WIEGAND, STEWART EAR  
WILLIAMS, JOHN C P  
WILLIAMSON, BYRN JR  
WILLIAMSON, KENNETH  
WILLIS, ROBERT THOMA  
WILLSON, RICHARD ATW  
WILSON, DAVID F  
WILSON, JOHN D  
WINDECK, JAMES LYNN  
WISHNEV, MARTIN ALLA  
WOLFF, WILLIAM ANDER  
WOLPERT, ENRIQUE  
WOOD, ROBERT C.  
WOODS, JOHN E  
WOOLAM, GERALD L  
WOTYCHA, EDWARD B.  
MURTELE, LESTER HERB  
MYCHULIS, ADAM R  
YACKEL, DOUGLASS B  
YAKE, RONALD FAVORIT  
YAN-BO, FRISCA L  
YANAGIHARA, TAKEHIKO  
YASUMURA, YUTAKA

YIPINTSOI, TADA  
YOUAMAN, J DUDLEY  
YOUNG, SHERWOOD FRED  
YTREDAL, DUANE OSCAR  
ZALLA, JAMES ALBERT

TO REACH HOSPITAL NUMBERS:

From  
MINNEAPOLIS CAMPUS PHONES

Dial 192 then the listed  
number

From  
HOSPITAL PHONES

Dial listed number

FROM ALL OTHER PHONES

Dial 339-7311  
ask operator for  
listed number

## STUDENT ORGANIZATIONS

### GOVERNING BOARDS AND INTER-GROUP COUNCILS

All University-Judiciary Council, 302 EdH  
Alpha Phi Chi, 203 CH, 373-4200  
Board in Control of Student Publications, 9 TNM, 373-4158  
Board of Residence Halls, 225 CMU, 373-4139  
Business Board of the School of Business Administration, BA  
College of Education Student Board, 242 Bu  
College of Liberal Arts Intermediary Board, 101 JohH  
Commonwealth Terrace Council  
Council of Student Religious Organizations, 211 EdH  
General College Board, 111 NH  
Home Economics Board, 200 McNH  
Inter-Dental Fraternity Council, 136 Owre  
Interfraternity Council, 347 CMU  
International Student Council, 203 CMU  
Inter-Sorority Council, 118 TNM  
Law School Council, FraH  
Medical Student Council, 1305 Mayo  
Medical Technology Student Council, C205 Mayo  
Minnesota Student Association, 213 CMU  
Nursing College Board, 125 Owre  
Panhellenic Council, 347 CMU  
Pharmacy College Student Representative Board, AH  
Pi Phi Chi, 203 CH, 373-4200  
St Paul Campus Student Council, NorH  
Social Service Council, 114 TNM  
Student Association of the Department of Mortuary Science  
Student Project for Amity Among Nations, 133 ClayS  
Technical Commission, 129 E  
Technolog Board, 121 TNM  
University of Minnesota College of Liberal Arts Honors Student Council,  
115 JohH  
White Dragon Society  
Women's Intramural Program, 202 NGW

### UNION BOARDS

Student Center Board of Governors, 104 StCen  
Union Board of Governors, 315 CMU

### STUDENT PUBLICATIONS

Gopher Peavey, School of Forestry  
The Minnesota Daily, MurH, 373-3381  
Minnesota Technolog, 2 ME

### ACADEMIC FRATERNITIES

Acacia, 1206 5th St SE, 331-5941  
Alpha Delta Phi, 1725 University Ave SE, 331-1326  
Alpha Epsilon Pi, 526 11th Ave SE, 333-0533  
Alpha Tau Alpha, 1983 Knapp Ave, St Paul, 645-3200  
Alpha Tau Omega, 1821 University Ave SE, 331-5887  
Beta Sigma Psi, 1103 5th St SE, 331-1507  
Beta Theta Pi, 1625 University Ave SE, 331-2313  
Chi Phi, 315 19th Ave SE, 331-3974  
Chi Psi, 1515 University Ave SE, 331-5467  
Delta Chi, 1601 University Ave SE, 331-7916  
Delta Kappa Epsilon, 1711 University Ave SE, 331-7858  
Delta Tau Delta, 1717 University Ave SE, 331-5997  
Delta Upsilon, 1112 6th St SE, 331-6889  
Kappa Alpha Psi  
Kappa Sigma, 1125 5th St SE, 331-2792  
Phi Delta Theta, 1011 4th St SE, 336-9359  
Phi Epsilon Pi, 1901 University Ave SE, 331-2388  
Phi Gamma Delta, 1129 University Ave SE, 336-8661  
Phi Kappa Psi, 1609 University Ave SE, 331-1335  
Phi Kappa Theta  
Phi Sigma Kappa, 317 18th Ave SE, 331-2291  
Psi Upsilon, 1617 University Ave SE, 331-1114  
Sigma Alpha Epsilon, 1815 University Ave SE, 331-5986  
Sigma Alpha Mu, 311 11th Ave SE, 333-6527  
Sigma Chi, 1623 University Ave SE, 331-1723  
Sigma Nu, 307 16th Ave SE, 331-1732  
Tau Delta Phi  
Tau Kappa Epsilon  
Theta Chi, 315 16th Ave SE, 331-7929  
Theta Delta Chi, 400 10th Ave SE, 339-1266  
Zeta Psi, 1829 University Ave SE, 331-7455

### ACADEMIC SORORITIES

Alpha Chi Omega, 915 University Ave SE  
Alpha Delta Pi, 1000 5th St SE, 336-4373  
Alpha Epsilon Phi, 928 5th St SE, 333-0297  
Alpha Gamma Delta, 401 11th Ave SE, 331-3387  
Alpha Omicron Pi, 1121 5th St SE, 331-1383  
Alpha Phi, 323 10th Ave SE, 332-8516  
Chi Omega, 315 10th Ave SE, 333-6529  
Clovia, 1502 Raymond Ave, St Paul, Mi 6-3786  
Delta Delta Delta, 316 10th Ave SE, 333-4527  
Delta Gamma, 1026 5th St SE, 335-4196  
Delta Zeta  
Gamma Omicron Beta, 2067 Carter Ave, St Paul, 646-3970  
Gamma Phi Beta, 311 10th Ave SE, 333-7285  
Kappa Alpha Theta, 1012 5th St SE, 331-9552  
Kappa Delta, 1025 6th St SE, 331-1863  
Kappa Kappa Gamma, 329 10th Ave SE, 333-0389  
Lambda Delta Phi, 1276 Raymond Ave, St Paul, 645-6563  
Phi Mu, 330 11th Ave SE, 331-2618  
Pi Beta Phi, 1109 5th St SE, 331-1339  
Sigma Delta Tau, 1121 University Ave SE, 331-7935

### PROFESSIONAL FRATERNITIES

Alpha Chi Sigma, 613 Oak St SE, 331-5951  
Alpha Delta Sigma, 301 St Anthony Ave SE  
Alpha Gamma Rho, 2060 Carter Ave, St Paul, Mi 6-0591  
Alpha Kappa Kappa, 621 Oak St SE, 331-1744  
Alpha Kappa Psi, 1116 5th St SE, 331-1391  
Alpha Mu Sigma  
Alpha Omega  
Alpha Psi  
Alpha Rho Chi, 605 Ontario St SE, 331-7961  
Alpha Tau Alpha, 210 Hr, 645-3200  
Anchor and Chain (NROTC)  
Delta Sigma Delta  
Delta Sigma Pi  
Delta Theta Phi  
Delta Theta Sigma, 1485 Cleveland Ave N, St Paul, 645-8787  
Farm House, 1505 Cleveland Ave N, St Paul, 646-3196  
Gamma Eta Gamma, 1126 5th St SE, 331-1575  
Iota Rho Chi, BA  
Kappa Alpha Mu  
Kappa Eta Kappa, 901 Washington Ave SE, 331-2133  
Kappa Psi, College of Pharmacy, AH, 373-2194  
Mu Beta Chi  
Mu Iota Epsilon  
Mu Sigma Nu, 631 Oak St SE  
Phi Beta Pi, 632 Ontario St SE, 331-1369  
Phi Chi, 325 Harvard St SE, 331-1319  
Phi Delta Chi, 1024 4th St SE, 333-2287  
Phi Delta Epsilon, 501 Ontario St SE, 331-7149  
Phi Delta Phi  
Phi Epsilon Kappa, 202 CH  
Phi Mu Alpha  
Phi Rho Sigma, 317 Union St SE, 331-1839  
Pi Sigma Epsilon  
Psi Omega, 901 E River Road  
Sigma Alpha Sigma  
Sigma Delta Chi  
Theta Tau, 515 10th Ave SE, 331-7931  
Triangle, 521 12th Ave SE, 331-7969  
Xi Psi Phi, 1004 7th St SE, 331-7933

### PROFESSIONAL SORORITIES

Alpha Delta Theta  
Alpha Epsilon Iota, 528 Ontario St SE, 331-1419  
Alpha Kappa Gamma  
Alpha Tau Delta  
Kappa Epsilon  
Phi Delta  
Phi Upsilon Omicron  
Sigma Alpha Iota  
Tau Beta Sigma  
Theta Sigma Phi, 219 MurH, 373-3163

**RESIDENTIAL ORGANIZATIONS**

Associated Students of Brewster Hall, BrH, 647-3502  
 Associated Students of Meredith Hall, MeH, 647-3502  
 Balley Hall Residents' Association, BaH, 645-9241  
 Centennial Hall Residence Association, CenH, 339-7421  
 Comstock Hall House Council, ComH, 333-2161  
 Frontier Hall Residence Association, FronH, 331-6400  
 Pioneer Hall Residence Association, PIH, 373-6320  
 Powell Hall Governing Association, Poh, 339-0531  
 Sanfrpd Women's Association, SaH, 339-0931  
 Territorial Hall Residence Association, TerH, 373-6631  
 Andrew House, 708 5th St SE, 331-4232

**CO-OPERATIVE ORGANIZATIONS**

Chateau Co-operative Club, 425 13th Ave SE, 331-4494  
 Fraternity Purchasing Association, 15 TNM, 373-3865  
 Independent Men's Co-op, 1469 Cleveland Ave N, St Paul, 646-1929  
 Minnesota Graduate Club, 2089 Carter Ave, St Paul, 644-6453  
 Richfield Student Association, Richfield Bus Company, 6424 Emerson Ave S,  
 869-4489  
 Students' Child Care Co-operative, 1629 Innsbruck Circle, 788-6759  
 Students' Co-operative, Incorporated, 1721 University Ave SE, 331-1708  
 University Play Center Parent's Association, 1203 Fifield, St Paul,  
 645-7485

**RELIGIOUS AND INTER-FAITH ORGANIZATIONS**

Baha'i Club, 1415 Dupont Ave N, 529-1781  
 Baptist Student Fellowship, 1225 5th St SE, 331-9298  
 Baptist Student Union, 400 6th Ave SE  
 Buddhist Student Association, PIH, 373-6086  
 Campus Crusade for Christ, 1120 5th St SE, 331-7187  
 Chi Alpha, 912 Elliot Ave S, 332-2409  
 Christian Medical Society, 4728 17th Ave S, Pa 4-1384  
 Christian Science Organization, 1215 27th Ave NE, 781-7876  
 Commons Club, Minnesota, 2911 Minnehaha Pkwy E, Pa 2-1234  
 Conservative Baptist Student Union, 4140 5th Ave S, 822-5165  
 Coptic Association, 825 5th St SE, 331-7610  
 Covenant Club, 3491 Garfield NE, St 9-0186  
 Delta Kappa Phi  
 Eastern Orthodox Fellowship, 881-5584  
 Episcopal Student Association, 2517 W 42nd St, 922-0611  
 Gamma Delta, 500 Harvard SE  
 Hillel Foundation, 311 11th Ave SE, 333-6527  
 Hindu Association, 1114 13th Ave SE, 331-5707  
 Inter-Varsity Christian Fellowship, 1455 Fulham St, 646-5177  
 Kappa Kappa Lambda, 4428 30th Ave S, 722-7729  
 Kappa Phi  
 Lutheran Collegians, 4315 4th Ave S, 825-3487  
 Lutheran Student Association, 1813 University Ave SE, 331-1859  
 Lutheran Student Association, St Paul, 2317 Priscilla, St Paul,  
 645-1187  
 Mennonite Student Fellowship, 1919 5th Ave S  
 Minnesota Christian Fellowship, 414 8th St SE, 332-6004  
 Mormon Fellowship, 206 FoH, 373-5246  
 Muslim Students Association, 727 15th Ave SE, 331-2728  
 Newman Club, St Paul, 1466 Raymond Ave, St Paul, 645-7469  
 Newman Student Association, 1701 University Ave SE, 331-7101  
 North American Baptist Twin Cities Student Committee, 4615 Oliver N,  
 522-2560  
 Seventh-Day Adventist Student Fellowship, 645-5849  
 Sikh Study Circle, 2089 Carter Ave, St Paul, 644-6453  
 Student Religious Liberals, 608 Washington Ave SE, 331-7448  
 United Campus Christian Fellowship, Pioneer Hall, 373-6278  
 University Christian Foundation, 1507 University Ave SE, 331-5943  
 Wesley Foundation, 1026 5th St SE, 338-5803  
 Wesley Foundation, St Paul, 1387 N Cleveland Ave, St Paul, 644-4222  
 Young Men's Christian Association, 1425 University Ave SE, 331-1013  
 Young Women's Christian Association, 5929 Girard Ave S, 825-3369

**RECOGNITION AND HONORARY ORGANIZATIONS .**  
 Scholarship and/or Achievements

Alpha Epsilon  
 Alpha Epsilon Rho  
 Alpha Kappa Delta  
 Alpha Sigma Pi  
 Alpha Zeta  
 Beta Alpha Psi  
 Beta Gamma Sigma  
 Chi Epsilon  
 Delta Phi Delta  
 Delta Sigma Rho  
 Eta Kappa Nu  
 Evans Scholars  
 Omicron Nu  
 ORBS  
 Phi Sigma Phi  
 Pi Tau Sigma  
 Plumb Bob  
 Rho Chi  
 Sigma Delta Psi  
 Sigma Epsilon Sigma  
 Sigma Gamma Tau  
 Sigma Theta Tau  
 Tau Beta Pi  
 Undergraduate "M" Club

**Leadership**

Arrowhead Society  
 Chimes  
 Grey Friars  
 Iron Wedge  
 Mortar Board

**SPECIAL INTEREST ORGANIZATIONS**  
 Departmental and Professional

Accounting Club  
 Agricultural Economics and Business Club  
 Agricultural Education Club  
 American Institute of Aeronautics and Astronautics  
 American Institute of Chemical Engineers  
 American Institute of Industrial Engineers  
 American Institute of Mining, Metallurgical and Petroleum Engineers  
 American Pharmaceutical Association  
 American Society for Public Administration  
 American Society of Agricultural Engineers  
 American Society of Civil Engineers  
 American Society of Mechanical Engineers  
 American Veterinary Medical Association  
 Architectural Student Association  
 Army ROTC Cadet Regiment  
 Army ROTC Kadettes  
 Arnold Air Society  
 Block and Bridle  
 Business and Distributive Education Club  
 Business Women's Club  
 Classics Club  
 Dairy Science Club  
 Finance and Insurance Club  
 Forest Products Club  
 Forestry Club  
 Geology Club  
 Graduate Economics Club  
 High Crusaders Workshop  
 Home Economics Association  
 Horticulture Club  
 Humanist Club  
 Institute of Electrical and Electronic Engineers  
 Journalism Graduate Club  
 Jr Affiliates of the National Council of Teachers of English  
 Law Research Council  
 Men's Elementary Education Association  
 Minnesota Society for Parapsychological Research  
 Minnesota Student Mathematics Association  
 Minnesota Student Recreation Association  
 Mitchell Aerospace Society  
 Pershing Rifles  
 Philosophical Society  
 Physical Education Association, Women's  
 Physical Therapy Club  
 Plant Industry Club  
 Poultry Science Club  
 Punchinello Players  
 Scabbard and Blade  
 Sigma Alpha Eta  
 Society for the Advancement of Management  
 Special Education Club  
 Student American Medical Association  
 Student Association of Social Workers  
 Student Education Association  
 Student Occupational Therapy Association of the U of M  
 Technical Agriculture Club  
 Undergraduate Social Work Club  
 University Advertising Club  
 University Band Social Organization  
 University of Minnesota Collegiate Chapter of the Future Farmers of America  
 University of Minnesota Film Society  
 University of Minnesota Pre-Law Club  
 University of Minnesota Pre-Veterinary Medicine Club  
 University of Minnesota Radio and TV Guild  
 University of Minnesota Engineers  
 University of Minnesota Undergraduate Biology Club  
 Wildlife Managers Club  
 Young Life Workshop

**Language and Culture**

AIESEC Local Committee  
 African Students' Association  
 American Field Service  
 American Indian Student Council  
 Arab-American Club  
 British-American Club  
 Chinese Students' Association  
 Der Deutsch Verein (German Club)  
 Filipino-Minnesota Club  
 Habonim Labor Zionist Youth  
 Hong Kong International Association  
 Indo-American Club  
 Indonesian Student Association  
 International House Club  
 International Relations Club  
 Iranian Students' Association  
 Israel-America Club  
 Korean Student Association

**TO REACH HOSPITAL NUMBERS:**

From  
**MINNEAPOLIS CAMPUS PHONES**  
 Dial 192 then the listed  
 number

From  
**HOSPITAL PHONES**  
 Dial listed number

**FROM ALL OTHER PHONES**  
 Dial 339-7311  
 ask operat  
 list

La Brigata Italiana (Italian Club)  
Latin American Club (Club Latino Americano)  
Latvian Student Club  
Le Cercle Francais (French Club)  
Minnesota Careers International  
Nigerian Student Association  
Overseas Journalist Club  
Pakistan International Students Association  
Polish Club of the University of Minnesota  
Russian Club  
Scandinavian Academic Club  
Sceptics Club  
Student Zionist Organization  
Thai Student Association  
Turkish American Club  
Ukrainian Club  
University Japanese Association

#### Music and Fine Arts

Guild Student Group  
St Paul Campus Chorus  
University of Minnesota Men's Glee Club  
University of Minnesota Opera Workshop

#### Political and Social Action

Committee for Freedom in the Arts  
Committee to End the War in Viet Nam  
Committee to Oppose Deportation of Joseph Johnson  
The Forum  
Minnesota Students for Head  
Students for a Democratic Society  
Students for Fraser  
Students for Integration  
Students for Keith  
Students for Levander  
Students for Rolvaag  
University of Minnesota Committee to Aid the Bloomington Students  
University of Minnesota Edmund Burke Society of America  
University of Minnesota Republican Association  
University of Minnesota Society for Conservative Studies  
University of Minnesota Young Socialist Alliance  
University Socialist Labor Party Group  
Young Americans for Freedom  
Young Democratic Farmer Labor Club  
W E B Dubois Club

#### Recreation and Hobby

Minnesota Rovers  
S L Group  
St Paul Campus Gun Club  
University Folk Dancers  
University of Minnesota Archery Club  
University of Minnesota Crew Association  
University of Minnesota Figure Skating Club  
University of Minnesota Flying Club  
University of Minnesota Gopher Marksmen  
University of Minnesota Ski Club  
University of Minnesota Skydivers  
University of Minnesota Sports Car Club  
University of Minnesota Toastmaster's Club

#### Social Service

Alpha Phi Omega  
Gamma Sigma Sigma

#### Student-Faculty Honorary Societies

National Collegiate Players  
Phi Alpha Theta  
Psi Chi  
Xi Sigma Pi



# FOURTH NORTHWESTERN

**PRESENTS**

Fourth

Northwestern's

**"HANDY" Wesbank**

(Your Full Service Banker)



I'm the symbol of **FOURTH  
NORTHWESTERN NATIONAL BANK**

By car or by foot, I am easily accessible from any part of the campus. Service to me means more than the usual full range of services offered by a Bank — It means Courteous, Friendly attention to all of your financial needs.

***So why not let me serve you now?***

Lobby Hours  
9 - 2 M. - Th.  
9 - 2, 4 - 6:30 F.



**Fourth Northwestern  
National Bank**  
Cedar and Riverside  
Phone 339-8741

Motor Bank Hours  
9 - 5, M. - Th.  
9 - 6:30 F.

Member Federal Deposit Insurance Corporation

## Schmelz Bros., Inc.



**Volkswagen**  
Sales & Service  
New & Used  
**869-1492**

U.S. 494 at 78th & Penn Ave. So.  
Across from Ward's Southtown  
LARGE SELECTION OF FINE  
FOREIGN AND DOMESTIC USED CARS  
Used Car Phone: 866-6212

## Little Europe

**FOREIGN CAR CLINIC**  
... TWO LOCATIONS ...  
300 Johnson St. N.E.  
3300 Stinson Blvd. N.E.  
CALL . . . 789-9909

## EUROPE BOUND?

International  
336-8624  
Domestic  
336-3373



137 S. 7th St.  
MINNEAPOLIS

or see your travel agent

## ADVERTISING

MINNESOTA DAILY,  
11 Murphy Hall  
Display Ad Dept.—373-3385  
Want Ad Dept.—373-3385  
Accounting Dept.—373-5532

## AIRLINES

TRANS WORLD AIRLINES  
137 S. 7th St.—336-2619

## ART SUPPLIES

ART MATERIALS, INC.  
315 14th Ave. S.E., Mpls.  
331-6864

## AUTOMOBILE—RENTING & LEASING

ARROW RENT-A-CAR  
20 No. Second St.—332-4361

UNITED RENT-A-CAR  
155 Irving Ave. N.—377-2032

## AUTOMOBILE SALES & SERVICE

LITTLE EUROPE  
300 Johnson St. N.E.—331-9767  
3300 Stinson Blvd.—789-9909

RIVERSIDE TRANSMISSION  
1910 5th St. S.—335-8558

SCHMELZ BROTHERS VW  
Hwy. 494 & Penn Ave. S. 869-1492

WEST SIDE VOLKSWAGEN  
Hwy. 100 & S. Cedar Lake Road  
Minneapolis—377-4100

## BANKS

CAMDEN N.W. STATE BANK  
4141 Lyndale Ave. N.—529-9515

CENTRAL N.W. NATL. BANK  
2329 Central Ave. N.E.—781-9534

FOURTH N.W. NATL. BANK  
401 Cedar Ave.—339-8741

FIFTH N.W. NATL. BANK  
1455 W. Lake—827-5531

LAKE ST. OFFICE N.W. NATL.  
BANK  
3030 Nic. Ave.—823-8281

LINCOLN OFFICE N.W. NATL.  
BANK  
800 Henn. Ave.—335-3201



## VOLKSWAGEN

PORSCHE

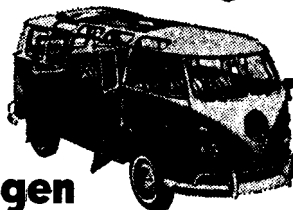

## West Side Volkswagen

Authorized Volkswagen & Porsche Agency

Highway 100 & Cedar Lake Rd.

377-4100

WHY PAY MORE?  
CALL . . .



# Arrow

## RENT-A-CAR

FREE DELIVERY & FREE MILEAGE  
ON WEEKLY RATES

ALL NEW . . .  
COMPACTS &  
FULL SIZE CARS

**332-4361**

20 NORTH SECOND STREET

# RENT A CAR

## IF YOU ARE 18 OR OVER

COMPACTS  
FULL SIZE CARS

# United

RENT A

## CAR & TRUCK

DOWNTOWN MINNEAPOLIS

NEW CARS  
DELUXE  
EQUIPMENT

CALL 377-2032  
or CALL 333-5323

**NORTHWESTERN NATIONAL  
BANK OF BLOOMINGTON-  
RICHFIELD**

78th St. & Penn Ave S.—866-4981

**N.W. NATL. BANK OF HOPKINS**  
1002 Exc. Ave. W., Hop.  
938-7691

**NORTHWESTERN NATIONAL  
BANK OF MINNEAPOLIS**  
620 Marq. Ave.—330-8123

**SECOND N.W. NATL. BANK**  
3430 Univ. Ave. S.E.—339-8871

**ST. ANTHONY FALLS OFFICE  
FIRST NATL. BANK OF MPLS.**  
328 E. Henn.—339-6881

**ST. ANTHONY PARK STATE  
BANK**  
2250 Como Ave. (St. Paul)  
646-7237

**THIRD N.W. NATL. BANK**  
416 E. Henn.—336-1711

**UNIVERSITY NATL. BANK**  
718 Wash. Ave. S.E., Mpls.  
331-5901

**BARBER SHOPS**

**BOB'S BARBER SHOP**  
1405 4th St. S.E.—338-9230

**DAVE'S BARBER SHOP**  
425-14th Ave. S.E.—331-9747

**GOPHER BARBER SHOP**  
814 Washington Ave. S.E.  
331-9878

**STADIUM BARBER SHOP**  
308 Oak St. S.E.—331-6579

**BEAUTY SCHOOLS**

**ROBINSON'S SCHOOL OF  
BEAUTY**  
1413 S.E. 4th St.—331-2007

**BEAUTY SHOPS**

**FINGER TIP BEAUTY SALON**  
13 S. 8th St., Hpls.—335-6759

**TWIST-N-TWIRL**  
1500 Como Ave. S.E.—331-2845

**BICYCLES—RETAIL,  
RENTAL, REPAIR**

**THE BIKE SHOP**  
215 Oak St. S.E.—331-3442

**Riverside  
Transmission  
Service**



- Volkswagen Repairs
- Repairing & Rebuilding Transmissions
- Tune-ups

1910 5th St. S.  
335-8558

**COMPLETE**

**Beauty  
Services**

- 6 Operators
- Open M-F till 9 pm
- New Stylings
- Tint Processing Machine



*Twist-N-Twirl*

**BEAUTY SALON**

Phone: 331-2845 1500 Como Ave. S.E.

*a Full Service  
Bank . . .*

*with your special  
needs in mind--  
Faculty, students  
and staff!*

Phone 339-6881



**ST. ANTHONY  
FALLS OFFICE  
First National Bank**

E. HENNEPIN & 4TH STREET

**FREE PARKING**

MEMBER FEDERAL DEPOSIT INSURANCE  
CORPORATION

**DOORS OPEN—9 A.M. TO 3 P.M. MON. - FRI.**

**FRIDAY EVENINGS 4:30 - 7:30**

**St. Anthony Park State Bank**

2250 Como Avenue St. Paul 8, Minnesota



Drive in open 8:30-4:00 p.m.

Fridays 8:30-7:30

**A Full Service Bank**

**Phone: 646-7237**

Member F.D.I.C.

- **ART MATERIALS**
- **DRAFTING and**
- **I. T. SUPPLIES**

**ART MATERIALS, INC.**

315 14th Ave. S.E. Minneapolis 331-6864

*Downstairs at Perine's*

**Come in and browse**

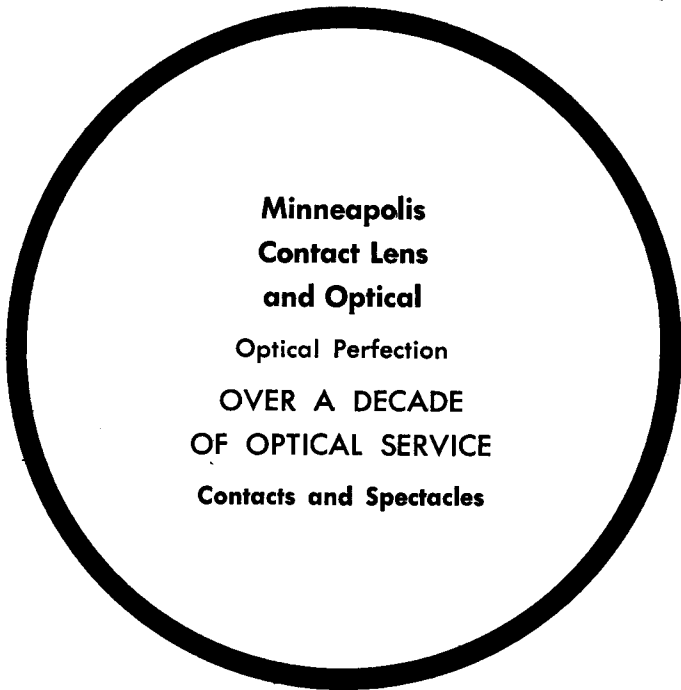

**Minneapolis  
Contact Lens  
and Optical**

Optical Perfection

**OVER A DECADE  
OF OPTICAL SERVICE**

**Contacts and Spectacles**

Our contact lenses haven't always been 99.50. But now that they are, stop and see us — trial fitting no obligation. We also have a complete line of frames for both fashion and sport.

2 CONVENIENT LOCATIONS

**DOWNTOWN**

Dayton Radisson Arcade  
27 S. 7th St. — 336-8673

**CAMPUS**

411 14th Ave. S.E.  
331-3165

**BOOKBINDERS**

ERICKSON BINDERY  
1308 5th St. S.E.—331-1502

**BOOK DEALERS**

HARVARD ST. BOOKSTORE  
520 Wash. Ave. S.E., Mpls.  
331-5832

MINN. COOP BOOKSTORE  
1501 University Ave. S.E.  
339-2768

MINNESOTA COOP JR.  
612 Washington Ave. S.E.  
331-7477

NICOLA BOOKSTORE  
13 E. Lake St.—824-5487

PERINE BOOK CO.  
315 14th Ave. S.E.—338-5618

SAVRAN'S PAPERBACKS  
301 Cedar Ave.—333-0098

**STADIUM BARBER SHOP**

308 Oak St. S.E.

Across from the Campus Theater  
Stop in for personalized haircuts

**331-6579**

**New & Used  
BOOKS**

*Available at*

**Perine's**

315 14th Ave. S.E.

338-5618

**The Campus Bookcenter  
in  
University Dinkytown**

**Typewriters**

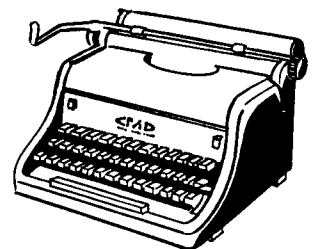

Phone 331-7477

**MINNESOTA CO-OP Jr.**  
612 WASHINGTON AVE. SE  
Between Harvard & Walnut

## CHECK CASHING SERVICE

UNIVERSITY CHECK CASHING  
BUREAU  
1318 4th S. S.E.—331-9251

## CHURCHES

BAHA'I CLUB  
377-4228

GRACE UNIVERSITY  
LUTHERAN CHURCH  
Harvard and Delaware S.E.  
331-2259

ONE RELIGION:  
BROTHERHOOD  
Joe Arnold, 16 Garden St.  
Cambridge, Mass. 02138

TRINITY LUTHERAN  
CONGREGATION  
2000 5th St. S.—333-2561

UNITED CAMPUS CHRISTIAN  
FELLOWSHIP  
Mpls. Campus: 331 17th Ave. S.E.  
339-0019

## CLEANERS

KAMPUS KLEANERS INC.  
1301 S.E. 4th St.—331-1053

THE TUB CLEANERS  
423 14th Ave. S.E.—338-4972

UNIVERSITY CLEANERS  
310 Oak St. S.E.—331-2122

## CONTACT LENSES

MINNEAPOLIS CONTACT LENS  
411 14th Ave. S.E.—331-3165

## COURT REPORTING

MINNESOTA SCHOOL OF  
BUSINESS  
24 So. 7th St.—338-6721

## CLOTHING, MEN'S

AL JOHNSON'S  
318 14th Ave. S.E.—338-3442

### MIDWAY BOOKSTORE

1579 University Ave - Phone 644-7605

### NICOLA BOOKSTORE

13 E. Lake (Lake & Nicollet) 824-5487  
Used Hardcover, Paperbacks and Magazines  
— We Buy, Sell and Trade —  
Out of Print Books

## GRACE UNIVERSITY LUTHERAN CHURCH

Harvard and Delaware S.E.  
Across from Centennial Hall  
1 Block So. of Washington Ave.  
331-2259

VINCENT L. HAWKINSON, Pastor  
Sunday Worship—9:15 & 10:45  
Communion—1st Sunday  
of the month  
Choir Rehearsal  
12:30 p.m. Sundays

## UNIVERSITY CHECK CASHING BUREAU

1318 FOURTH STREET SOUTHEAST  
MINNEAPOLIS 14, MINNESOTA

- CHECK CASHING
- MONEY ORDERS
- UTILITY BILL
- PAYMENT AGENCY
- TRAVELERS' CHECKS

FE. 1-9251



## Medicine Nursing Dentistry Public Health

Complete stock of text and  
reference books in the  
medical sciences.

and

Hundreds of titles in paperbacks  
for general reading.

*Harvard Street  
Bookstore*

Harvard and Washington S.E.  
331-5832

# TUB

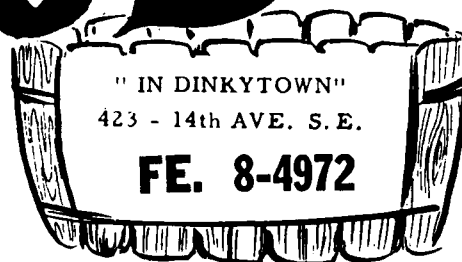

- Self Service  
Coin-op Laundry  
(Open 24 Hours)
- Professional  
Dry Cleaning
- Professional  
Shirt Laundry
- We Wash Serv-  
ice 8 lbs. 75c



## Open the Door to New Beauty!

Open the door to our Salon and you open the way to a blissful beauty experience. Designing fingers move with finesse as they curl and wave, cut and style, to accent your finest features, highlight your feminine charm. You'll love every minute of this Personalized Pampering . . . and it costs no more!

## Finger Tip Salons of Beauty

RADISSON RAMP  
339-4928

13 So. 8th St.  
335-6759

## NAMES of QUALITY

FROM



### MEN'S SHOP

H. Freeman  
Gordon Ford  
Cox-Moore  
Gant  
Linett  
Corbin

### WOMEN'S SHOP

Youth Guild  
Lady Gant  
Austin Hill  
Petti  
Gordon Ford

Conveniently Located for Every Student  
at the University

318 14th Ave. S.E. 338-3442

Open Thursday Evenings 'till 8:30

# the STORE



## in Dinkytown

### Adornment for Young Ladies

Hand Made Dresses ● Mary Quant  
Cosmetics ● Groovy Shoes ● Exclu-  
sive Blend Perfumes ● Sexy Sox/  
Tights ● Hand Made Leather Clothes  
& Bags ● Lady Van Heusen Things  
Purses That Swing ● Belts-Belts-  
Belts ● Hair Buckles ● Interesting  
Old Fripperies at This New Shop  
**338-8315**

HUNTLEY'S, LTD.  
616 Washington Ave. S.E. —  
331-4251

VARSITY TOGS  
1306 4th St. S.E.—331-7749

### CLOTHING, WOMEN'S

AL JOHNSON'S  
318 14th Ave. S.E.—331-5051

BISHOP'S CAMPUS FASHIONS  
1315 4th St. S.E.—331-1173

BISSELL'S  
618 Washington Ave. S.E.—  
338-2692

THE STORE  
319 14th Ave. S.E.—338-8315

### CREDIT UNIONS

STATE CAPITOL CREDIT UNION  
1407 University Ave. S.E.

### DIME STORES

DINKYTOWN DIME  
325 14th Ave. S.E. 332-4944

### DRUGGISTS—RETAIL

GRAY'S DRUGS  
329 14th Ave. S.E.—331-2955

HARVARD DRUGS  
600 Wash. Ave. S.E.—331-1626

### Sheffield's Florist

Assorted cut flowers, corsages,  
centerpieces and bouquets.  
City-wide delivery and telegraph delivery  
OAK & WASHINGTON S.E.  
331-2127 331-1955

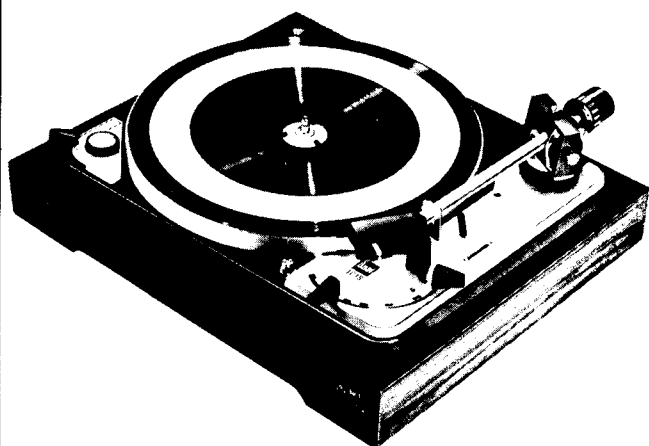

The  
Critic's  
Choice...

### DUAL AUTO/PROFESSIONAL TURNTABLES

Combine complete flexibility in single play and changer modes  
with exclusive precision performance and operating features  
as well as ease and precision in preparing tonearm for play.

From \$69.50

The New

## KEN - CRAFT Hi - Fi

in Stadium Village

714 Washington Ave. S.E.

331-6026

### VARSIITY TOGS

#### MEN'S WEAR

- VAN HEUSEN
- KANDAHAR
- INTERWOVEN
- GAME & LAKE
- JOCKEY
- H. D. LEE
- ENRO

106 4th St. S.E. 337-7749

Biggest Little Men's Store  
In Dinkytown

**EMPLOYMENT SERVICES**

EMPLOYERS OVERLOAD  
Foshay Tower Lobby—339-9411

**FLOWERS**

SHEFFIELD'S FLORIST  
Oak & Wash. S.E.—331-2127  
331-1955

**FORMAL WEAR**

KAMPUS KLEANERS, Inc.  
301 S.E. 4th St.—331-1053

**FURNITURE—NEW & USED**

THE BARTER MART  
117 W. Lake St.—827-3619

**GIFT SHOPS**

CRANE'S GIFT SHOP  
324 14th Ave. S.E.—331-5756

**GROCERY STORES**

MEYER'S SUPER MARKET  
1412 S.E. 5th St.—335-0491

VIRG & DON'S  
405 14th Ave. S.E.—333-6489

**HARDWARE**

SIMMS HARDWARE  
413 14th Ave. S.E.—331-1231

WILSON'S VILLAGE  
810-812-814 Wash. Ave. S.E.  
331-1341

**HI-FI**

KEN-CRAFT HI-FI  
714 Wash. Ave. S.E.—331-6026

GO WITH



**FOR THE BEST IN TEMPORARY EMPLOYMENT**  
Register at any of our offices for your choice of working hours.

MINNEAPOLIS  
Foshay Tower Lobby  
339-9411

SAINT PAUL  
First National Bank Bldg.  
224-3883

BLOOMINGTON  
9031 Penn Ave. So.  
888-7782

**EMPLOYERS OVERLOAD**  
EST. 1947

WATCH THE MINNESOTA DAILY FOR SPECIAL CAMPUS INTERVIEWS

*We Buy & Sell . . . .*

Used household furniture and appliances  
Used office furniture — desks, chairs,  
filing cabinets, etc.

**THE BARTER MART**

827-3691

117 W. LAKE STREET

Free Parking at Rear of Store

You will save a lot of money at our store. Come in. Get acquainted. See our prices.

Hours 9-6  
Mon., Thurs. & Fri. 'til 9

Free Delivery

**Prescriptions—Sundries—Notions**



- Cosmetics  
Revlon, Max Factor, Rubenstein
- Perfume  
Faberge, Lanvin, Chanel 5
- Men's Toiletries



**HARVARD**  
600 Wash. Ave. S.E.  
331-1626

**PRESCRIPTIONS**

**DRUGS**  
(Corner Harvard & Washington)

**SOUND OF MUSIC — THE PLACE TO BUY**

**THE FINEST STEREO COMPONENTS**

- Portable Stereo • Records • Tapes • Tubes and Parts
- TV • Radio • Cameras • Hifi Components • Tape Recorders

—( SEE US FOR SAVINGS )—

<b>SONY</b>	<b>DYNAKIT</b>	<b>BOGEN</b>	<b>AR</b>
<b>SHERWOOD</b>	<b>Wharefdale</b>	<b>NORELCO</b>	<b>ALTEC</b>
<b>TANDBERG</b>	<b>VIKING</b>	<b>GARRARD</b>	<b>SHURE</b>
<b>SHARPE</b>	<b>MARANTZ</b>	<b>EICO</b>	<b>KOSS</b>
<b>SCOTT</b>	<b>Elec. Voice</b>	<b>KLH</b>	<b>DUAL</b>
<b>ADC</b>	<b>McINTOSH</b>	<b>BARRON</b>	<b>KENWOOD</b>

**YOU ALWAYS SAVE MONEY AT**  
**SOUND of MUSIC**

3 LOCATIONS

**Dinkytown**  
404 14th Ave. S.E.  
Ph. 331-5252

**St. Paul**  
242 So. Hamline  
Ph. 698-3858

**Downtown**  
91 So. 10th Street  
Ph. 332-1421

**ANNOUNCING — ALL NEW**  
**"WILSON'S VILLAGE"**  
 810-812-814 Wash. Ave. S.E.  
 331-1341

**YOUR NEW FAMILY VILLAGE  
 OF SHOPS  
 FOR  
 HARDWARE, GIFTS, TOYS  
 BARBER SHOP AND  
 SHOE SERVICE**

**UNIVERSITY of  
 Minnesota**

**Official  
 Graduation Ring**



We also carry the  
 John Roberts Graduation Ring

**CAMPUS JEWELERS**  
 1319 4th St. S.E. 331-5121  
 319 14th Ave. S.E. 331-7529  
 808 Wash. Ave. S.E. 331-3435

**SOUND OF MUSIC**  
 242 S. Hamline, St. P.—698-3958  
 91 S. 10th St. ,Mpls.—332-1421  
 404 14th Ave. S.E.—331-5252

**ICE CREAM SHOPS**

**BRIDGEMAN'S CREAMERIES**  
 Dinkytown & Stadium Village

**BASKIN-ROBBINS 31 FLAVORS**  
 500 Washington Ave. S.E.—  
 331-9734

**INSURANCE—AUTO**

**A. G. STEINKE AGENCY**  
 2325 Hennepin—377-1234

**INSURANCE—LIFE**

**COLLEGE MASTER  
 FIDELITY UNION**  
 3404 University Ave. S.E.  
 339-7579

**JEWELRY—RETAIL**

**BECKUND JEWELERS**  
 1511 E. Lake St.—729-4034  
 Crystal Shopping Ctr.—537-4539

**CAMPUS JEWELERS**  
 1319 S.E. 4th St.—331-5121  
 319 14th Ave. S.E.—331-7529  
 808 Wash. Ave. S.E.—331-3435

**K. C. CORNELIUS JEWELRY**  
 324 Kresge Bldg.—335-6940

**RONALD JEWELERS**  
 433 Wabasha, St. Paul  
 224-7131

**LAUNDRIES**

**CAMPUS NORGE**  
 211 Oak St. S.E.—331-9745

**THE TUB COIN-OP. LAUNDRY**  
 423 14th Ave. S.E.—338-4972

**TUB LAUNDERETTE**  
 815 Wash. Ave. S.E.—338-9747

**LIQUOR STORES**

**KICK'S LIQUOR STORE**  
 1104 Wash. Ave. S.—333-3553

**ZIPP'S**  
 2618 Franklin Ave. S.—336-8686

**CollegeMaster**  
 ®

**THE COLLEGE PLAN  
 FOR THE COLLEGE MAN**



**SPECIAL BENEFITS AND RATES  
 FOR COLLEGE SENIORS & GRADUATE STUDENTS**

• LIFE • HEALTH • DISABILITY

**CAMPUS AGENCY... 3404 UNIVERSITY AVE. S.E. 339-4515**

**For Now and Forever...**

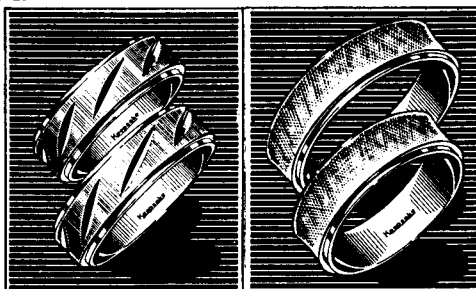

*Orange Blossom*  
 DIAMOND RINGS

**Keepsake®**  
 REGISTERED DIAMOND RINGS

**BECKLUND**



**STUDENT CREDIT — NO INTEREST**

**1511 EAST LAKE  
 MINNEAPOLIS  
 729-4034**

**CRYSTAL  
 SHOPPING CENTER  
 537-4539**

**OPEN EVENINGS**



## LOANS

ASSOCIATED LOAN CO.  
2928 Chicago S., Mpls. 825-2411  
Bloomington—881-5829  
St. Paul—222-5801  
E. St. Paul, 951 Payne Ave.  
774-6057

## MEN'S SHOES (SEE SHOES)

## MICROSCOPES—NEW, USED, REPAIR

ALBINSON, INC.  
520 4th Ave. So.—339-8731  
Wild Heerbrugg Microscopes

BOWER & HAACK  
1826 Como Ave. S.E.—331-5791

JOSEPH KLUEGEL COMPANY  
1821 Univ. Ave., (St. Paul)  
646-4773

LEGG OPTICS  
2072 Buford, St. Paul—646-2220

## MOTELS

GOPHER CAMPUS MOTOR  
LODGE  
925 S.E. 4th St., Mpls.—333-5313

## MOVING

BOYD TRANSFER & STORAGE  
400 E. Lake—823-5271

C.A.T. MOVING & STORAGE  
333 E. 78th St.—866-8481

## MUSICAL INSTRUMENTS— RETAIL

TRESTMAN MUSIC CENTER, Inc.  
6503 Nicollet Ave. S.—866-3481

PODIUM  
417 14th Ave. S.E., Mpls.  
332-9008

ROLLIE WILLIAMS MUSIC CO.  
4520 Excelsior Blvd., Mpls.  
927-8684

## OFFICE AND SCHOOL SUPPLIES

CRANE'S OFFICE & SCHOOL  
SUPPLY COMPANY  
1417 S.E. 4th St.—331-5969



*Creative  
Jewelers*  
DIAMONDS

FINE SELECTION  
K. C. CORNELIUS JEWELRY CO.  
324 KRESGE BLDG. 7th & NICOLLET 335-6940  
—Reasonable Student Rates—

## CAMPUS NORGE

LAUNDRY & CLEANING VILLAGE



- ★ 28 New Coin-Op Washers
- ★ 8 Norge Cleaners
- ★ Fast Pressing Service
- ★ Professional Dry Cleaning
- ★ Shirt Service

211 Oak St. S.E. 331-9745  
Across from the Football Stadium

# FASTEST

DELIVERY IN TOWN  
PARTICULARLY TO YOUR AREA  
KEG BEER HEADQUARTERS

# KICKS

LIQUORS

1104 Washington Ave. S. 333-3553

# Ronald JEWELERS of Saint Paul



The original dealer of  
REGISTERED  
**Keepsake**  
DIAMOND RINGS

FEATURING TWIN CITIES WIDEST SELECTION

Now at Two convenient locations:  
Ronald's White Bear Shopping Center call 429-6822  
Ronald's Downtown — 433 Wabasha call 224-7131  
OPEN EVERY WEEKDAY EVENING TILL 9:00 P.M.

- 1 ACME PRINTING & STATIONERY CO.**  
421 14th Ave. S.E.  
331-7878
- 2 AL JOHNSON'S CLOTHING**  
318 14th Ave. S.E.  
338-3442 — 331-5051
- 3 AL'S BREAKFAST (Dinkytown Branch)**  
413 14th Ave. S.E.  
332-9712
- 4 AMERICANS ABROAD**  
317 14th Ave. S.E.  
331-7909
- 5 ART MATERIALS, INC.**  
315 14th Ave. S.E.  
331-6864
- 6 BOB'S BARBER SHOP**  
1405 4th St. S.E.  
338-9230
- 7 BRIDGEMAN ICE CREAM STORE**  
326 14th Ave. S.E.  
331-2575
- 8 C. B. CHRISTIANSON REALTORS**  
1315 4th St. S.E.  
331-5961
- 9 CAMPUS COBBLER (Shoes)**  
321 14th Ave. S.E.  
338-3422
- 10 CENTURY CAMERA, INC.**  
1327 4th St. S.E.  
331-7777
- 11 COLOR TV & HI-FI**  
419 14th Ave. S.E.  
338-2777
- 12 CONTEMPORARY DANCE PLAYHOUSE**  
404 13th Ave. S.E.  
331-5311
- 13 DAVE'S BARBER SHOP**  
425 14th Ave. S.E.  
331-9747
- 14 DINKYTOWN DIME STORE**  
325 14th Ave. S.E.  
332-4944
- 15 DISCOUNT RECORDS**  
323 14th Ave. S.E.  
331-1374
- 16 ERICKSON'S BINDERY**  
1308 5th St. S.E.  
331-1502
- 17 GRAY'S CAMPUS DRUG STORE**  
329 14th Ave. S.E.  
331-2955
- 18 THE HOUSE OF HANSON (Grocery)**  
433 14th Ave. S.E.  
332-9342
- 19 KAMPUS KLEANERS, INC.**  
1301 4th St. S.E.  
331-1053
- 20 LOUGHRIDGE-BENGSTON, INC. (Photo)**  
411 14th Ave. S.E.  
331-9901
- 21 MEYER'S SUPER MARKET**  
1412 5th St. S.E.  
335-0491
- 22 PERINE BOOK CO.**  
315 14th Ave. S.E.  
338-5618
- 23 PODIUM MUSIC & TOBACCO SHOP**  
417 14th Ave. S.E.  
332-9008
- 24 ROBINSON BEAUTY SCHOOL & SALON**  
1413 4th St. S.E.  
331-2007
- 25 SAMMY D's (Restaurant)**  
1407 4th St. S.E.
- 26 SIMM'S HARDWARE**  
411-413 14th Ave. S.E.  
331-1231

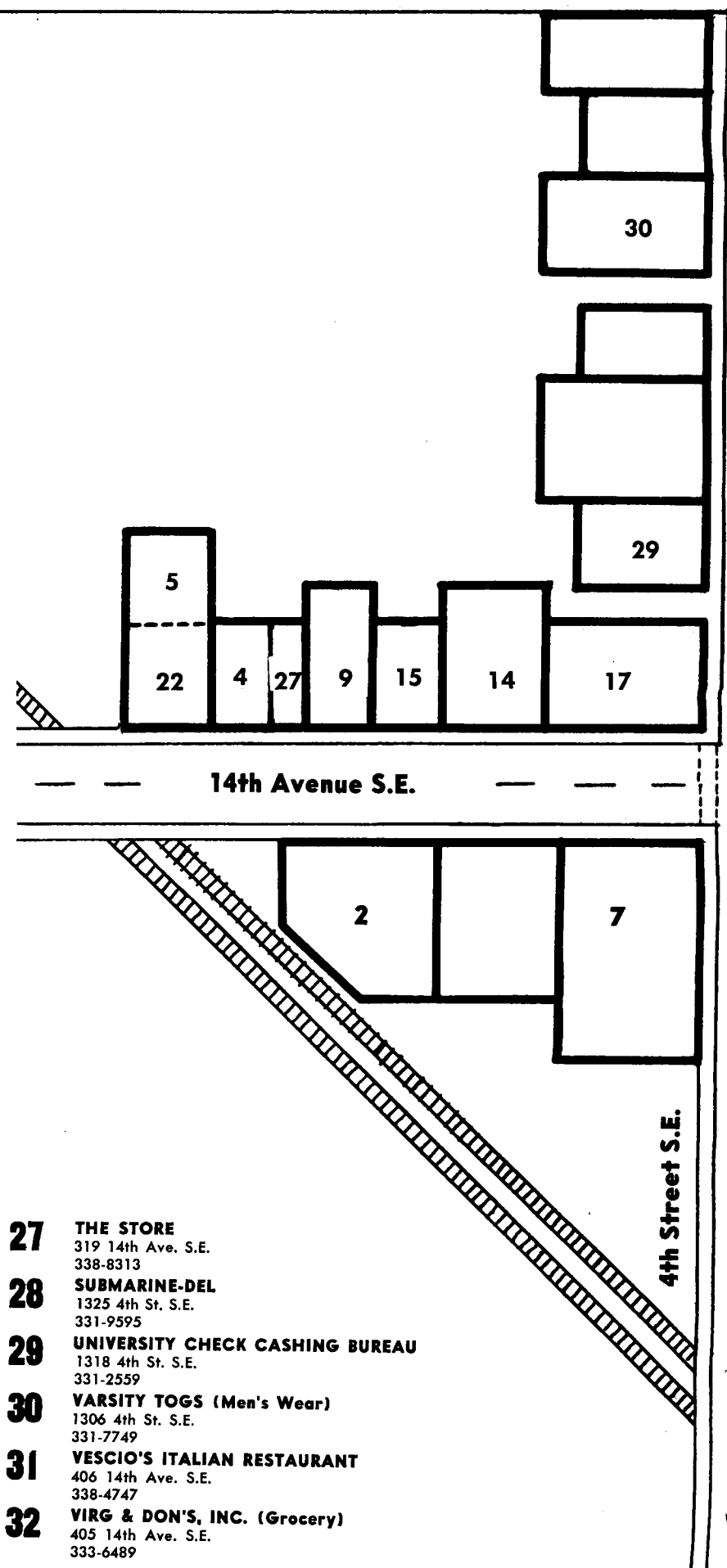

- 27 THE STORE**  
319 14th Ave. S.E.  
338-8313
- 28 SUBMARINE-DEL**  
1325 4th St. S.E.  
331-9595
- 29 UNIVERSITY CHECK CASHING BUREAU**  
1318 4th St. S.E.  
331-2559
- 30 VARSITY TOGS (Men's Wear)**  
1306 4th St. S.E.  
331-7749
- 31 VESCIO'S ITALIAN RESTAURANT**  
406 14th Ave. S.E.  
338-4747
- 32 VIRG & DON'S, INC. (Grocery)**  
405 14th Ave. S.E.  
333-6489

# STADIUM VILLAGE

1. **BASKIN-ROBBINS 31 FLAVORS**  
500 Washington Ave. S.E.  
331-9734
2. **THE BIKE SHOP**  
215 Oak St. S.E.  
331-3442
3. **BISSELL'S (Women's Wear)**  
618 Washington Ave. S.E.  
338-2692
4. **BRIDGMAN ICE CREAM STORE**  
800 Washington Ave. S.E.  
331-5356
5. **CAMPUS PIZZA**  
818 Washington Ave. S.E.  
331-7964
6. **HARVARD MARKET**  
602 Washington Ave. S.E.  
331-3593
7. **HARVARD ST. BOOKSTORE**  
Harvard & Washington S.E.  
331-5832
8. **HARVARD ST. DRUGS**  
600 Washington Ave. S.E.  
331-1626
9. **HUNTLEY'S LTD. (Men's Wear)**  
616 Washington Ave. S.E.  
331-4251
10. **MINNESOTA COOP JR.**  
612 Washington Ave. S.E.  
331-7477
11. **QUARTERBACK CLUB DRIVE-IN**  
219 Oak St. S.E.  
331-5288
12. **SHEFFIELD'S FLORIST**  
Oak & Washington Ave. S.E.  
331-1955
13. **SKI DEN**  
724 Washington Ave. S.E.  
331-2310
14. **SPORTSWORLD SKI & SCUBA**  
307 S.E. Oak St.  
331-7331
15. **SUBMARINE DEL**  
606 Washington Ave. S.E.  
332-9690
16. **TUB CLEANERS & LAUNDERS**  
815 Washington Ave. S.E.  
333-9747
17. **UNIVERSITY CLEANERS**  
310 Oak St. S.E.  
331-2122
18. **UNIVERSITY NATIONAL BANK**  
718 Washington Ave. S.E.  
331-5901
19. **WILSON'S HARDWARE**  
812 Washington Ave. S.E.  
331-1341

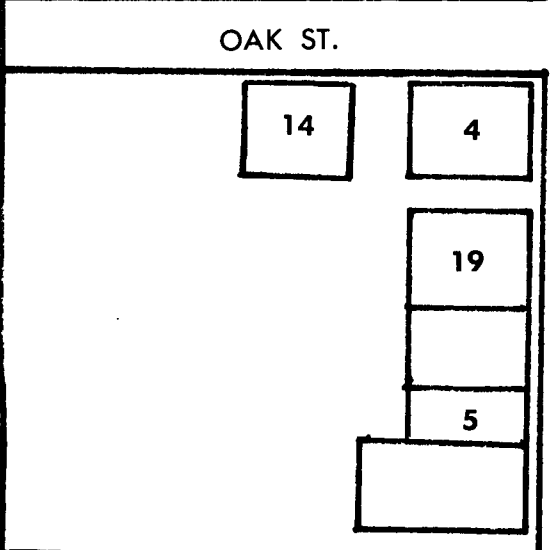
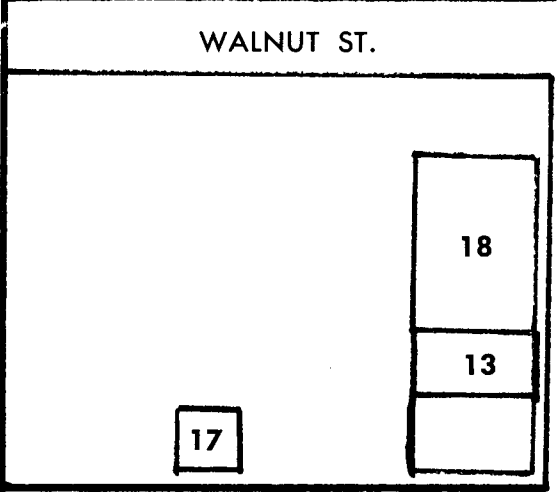
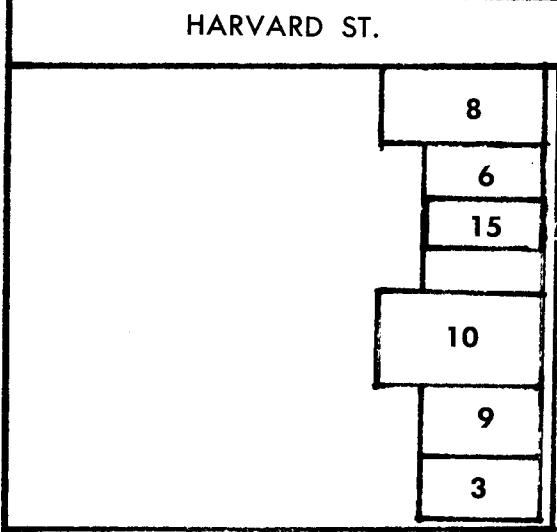
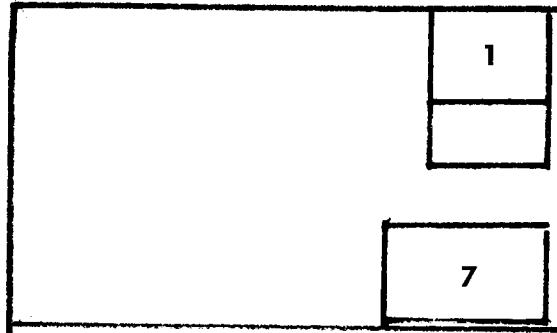

WASHINGTON AVE. S.E.

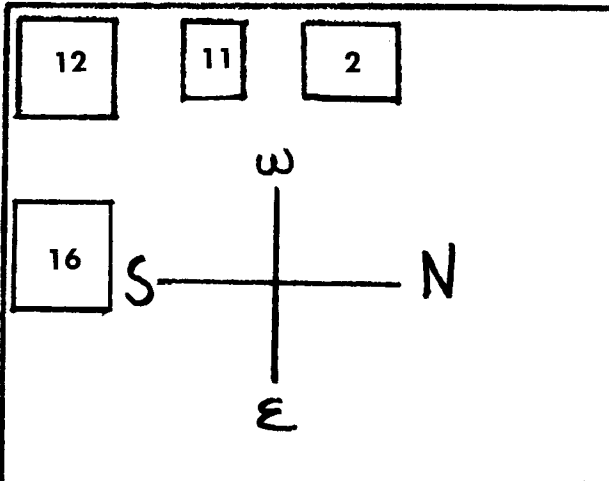

13th Avenue S.E.

19 12

8

# UNIVERSITY DINKYTOWN

16

28

10

20

32

26

3

23

11

1

13

18

14th Avenue S.E.

31

6

25

24

5th Street S.E.

21



*University of Minnesota*

15th Avenue S.E.

## PHOTOGRAPHERS

LOUGHRIDGE-BENGTSON INC.  
411 14th Ave. S.E.—331-9901

## PHOTOGRAPHIC EQUIPMENT

CENTURY CAMERA INC.  
1327 4th St. S.E.—331-7777

MINICUSTOM CAMERA  
306 Oak St. S.E.—331-5490

## PIZZA

CAMPUS PIZZA  
818 Wash. Ave. S.E.—331-7964

CHICKEN DELIGHT  
626 Central N.E.—338-7079

VALLI PIZZA  
412 14th Ave. S.E.—331-1361

## PRINTING

ACME PRINTING &  
STATIONERY CO.  
421 14th Ave. S.E.—331-7878

# BOWER & HAACK



MICROSCOPES

SALES AND SERVICE

Phone: FE. 1-5791

*Serving Medical and Veterinary Students for over 16 years.*  
1826 COMO AVE. S.E. HOME PHONE: SU. 4-3440 MINNEAPOLIS 14

## JOSEPH KLUegel COMPANY

# MICROSCOPES

## SALES AND SERVICE

NEW & USED

REICHERT — SWIFT — UNITRON

646-4773

1821 UNIVERSITY AVENUE  
ST. PAUL, MINN.

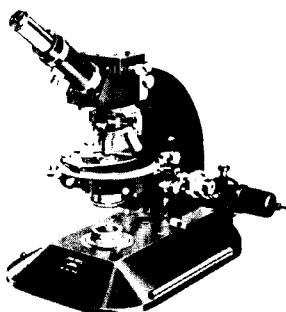

We Have The  
Nicest Guests!

## GOPHER CAMPUS MOTOR LODGE

Near U. of M.

One Block North of  
University Ave., on Hwy. 36  
925 SE. 4th St. Minneapolis 14  
Phone: 333-5313

## LEGG APPLIED OPTICS

REPAIR SERVICE - CONSULTING

ALL scientific optical instruments:

Microscopes      Binoculars  
Ophthalmic      Industrial

*Fast service — work guaranteed*

2072 Buford, St. Paul  
Bus. 646-2220      Res. 331-4951

Across from the St. Paul Campus  
**BUFORD AT CLEVELAND**



## LOANS

**\$50 to \$900**  
EMPLOYED STUDENTS  
CAN QUALIFY  
JUST PHONE  
TA 5-2411

## ASSOCIATED LOAN COMPANY

2928 CHICAGO AVE. SO.  
MPLS. — 825-2411

SIGNAL HILLS SHOPPING  
CENTER  
ST. PAUL — 222-5801

**\$400  
TO  
\$3000  
OR MORE**

## LOANS

TO CONSOLIDATE BILLS  
TO BUY A CAR  
FOR MEDICAL BILLS

## EAST - ST. PAUL LOAN & THRIFT

951 PAYNE AVENUE  
ST. PAUL — 774-6057

## STANDARD LOAN & THRIFT

BLOOMINGTON  
9612 LYNDALE AVE. S. 881-5829  
MINNEAPOLIS  
1001 W. BROADWAY 522-6674

Play  
Guitar or Banjo



Headquarters for folk song guitar enthusiasts.

Complete instruction and supplies.

Call WA 7-8684  
Rollie Williams Music Co.  
"The Guitar Store"  
4520 Excelsior Blvd.  
St. Louis Park, Minn. 55416



**PIPE SMOKERS!**  
FINEST QUALITY DOMESTIC & IMPORTED PIPES & TOBACCOS SMOKING ACCESSORIES PIPE REPAIR

**MUSICIANS!**  
MUSICAL SUPPLIES INSTRUMENTS SHEET MUSIC ACCESSORIES

**the PODIUM**  
417 14th Ave. S.E. • 332-9008

MIDWEST PRINTING CO.  
809 9th St. S.E.—331-7951

**REALTORS**

C. B. CHRISTIANSEN  
ASSOC. INC.  
1315 S.E. 4th St.—331-5961

**RECORDS, PHONOGRAPH**

DISCOUNT RECORDS  
323 14th Ave. S.E.—331-1374

SOUND OF MUSIC  
See listing under Hi-Fi

**RESTAURANTS**

AL'S BREAKFAST  
413 14th Ave. S.E.—332-9712

BEST STEAK HOUSE  
732 Washington Ave. S.E.  
331-9607

CAMPUS PIZZA  
818 Wash. Ave. S.E.—331-7964

CEDAR VILLAGE INN  
621 Cedar Ave.—338-9449

**Coffee House Extempore**  
2200 Riverside Ave.  
332-9623

**CEDAR VILLAGE INN**  
Good Food Always  
621 Cedar Ave.  
338-9449



**TRESTMAN**  
MUSIC CENTER

- Conn
- Buescher
- Standard
- Gibson
- Artley
- Roth
- Epiphone
- Ampeg
- Ludwig
- Framus
- Harmony
- Kimball

**PIANOS & ORGANS**

Free Lessons with Band  
Instrument Rentals



Guitars — Amps —  
Studios — Method Books  
— Repairs — Drums

WE BUY — SELL —  
TRADE — RENT  
NEW AND USED

866-3481  
6503 Nicollet Ave.

**THE COMPLETE RECORD SHOP**

★  
★  
★  
★  
★

LARGEST, MOST  
VARIED STOCK  
IN TWIN CITIES

LOWEST PRICES

CONVENIENTLY  
ON CAMPUS

**Discount**  
records inc.

★  
★

323 - 14th Ave. S.E.  
"Dinkytown" Phone 331-1374

**LOCAL • NATIONAL • WORLD-WIDE SERVICE**

•MOVING      •STORAGE  
•PACKING    •SHIPPING

Serving Mpls. & Suburbs Since 1892



FOR SOUND ADVICE—FREE ESTIMATE  
Call 823-5271

**BOYD TRANSFER & STORAGE CO.**

**Gaslight**  
Excellent Cuisine  
1420 Washington Ave. So.  
Parties & Groups

**MOVING & STORAGE**

Save with safety.  
47 yrs. of reasonable and reliable moving and packing service anywhere in the world  
M.P. 11282



Call 866-8481      333 E. 78th St.

**CHICKEN DELIGHT**  
626 Central Ave. N.E.—338-7079

**COFFEE HOUSE EXTEMPORE**  
2200 Riverside—332-9623

**GASLIGHT**  
1420 Washington Ave. So.  
339-9404

**QUARTERBACK CLUB**  
219 Oak St. S.E.—331-5288

**SAMMY D'S**  
1407 4th St. S.E.—331-9630

**VALLI PIZZA**  
412 14th Ave. S.E.—331-1361

**VESCIO'S**  
406 14th Ave. S.E.—338-4747

### **SCHOOLS**

**CONTEMPORARY DANCE  
PLAYHOUSE**  
404 13th Ave. S.E.—331-5311

**MINNEAPOLIS BUSINESS  
COLLEGE**  
84 S. 10th St.—332-4338

## **ONE RELIGION**

People are segregated into different faiths because the ancestors of each accepted the faith of the community where they happened to live, and each in turn accepted the faith of the family into which each happened to be born. Why not reject segregated religion and accept inclusive One Religion which offers one religion for all?

If interested, please send name and address to Joe Arnold, One Religion, 16 Garden Street, Cambridge, Massachusetts, 02138.

## **MINICUSTOM CAMERA SHOP & PROCESSING LAB**

Custom Developing  
Black and White Slides  
Direct Positive Film and Developing  
Rapid Service On All Photofinishing  
306 Oak St. S.E. 331-5490  
(across from Campus theater)

## **THE BEST STEAK HOUSE**

The Best Steaks in Town  
At Popular Prices: \$.69 - \$1.30

11:00 a.m. to 9:00 p.m. Daily

Oak & Washington S.E.  
(in the heart of Stadium Village)  
Minneapolis 55414

PHONE 331-9607

# **"Printers of the Minnesota Daily"** **MIDWEST PRINTING CO.**

**801 S.E. 9th ST., MINNEAPOLIS**

**PHONE: AC612 331-7951**

# **5 WEB PRESSES TO SERVE YOUR NEEDS**

● **WEB OFFSET**

● **WEB LETTERPRESS**

- **CATALOGS**
- **PUBLICATIONS**
- **CIRCULARS**
- **BINDING**
- **MAILING**

**CALL  
338-7079**

**★ DELIGHTS**

CHICKEN	1.49
SHRIMP	1.49
FISH	1.19
RIB	2.25

**FAST DELIVERY**

ON MINNEAPOLIS CAMPUS

★ FRESHLY MADE PIZZA  
FROM 99c

- ★ CHICKEN SNACK ..... 99c
- ★ SHRIMP SNACK ..... 99c

OPEN 7 DAYS A WEEK

MON.-THURS.: 4-11 p.m.  
FRIDAY: 4 p.m.-2 a.m.  
SATURDAY: 11 a.m.-2 a.m.  
SUNDAY: 11 a.m.-11 p.m.



DELIVERY WITHIN 2 MI

**CHICKEN DELIGHT**

626 CENTRAL N.E.

MINNESOTA SCHOOL  
OF BUSINESS

24 So. 7th St.—338-6721

NORTHWEST  
TECHNICAL INSTITUTE

7600 Hwy. 7—938-9111

NORTHWESTERN  
ELECTRONICS INSTITUTE  
3800 Minnehaha Ave.—721-2469

**SHOES—MEN'S & WOMEN'S**

AL JOHNSON'S  
318 14th Ave. S.E.—338-3442

CAMPUS COBBLER  
321 14th Ave. S.E.—338-3422

HUNTLEY'S, LTD.  
616 Wash. Ave. S.E.—331-4251

**SHOE REPAIR**

VILLAGE SHOE SERVICE  
814 Washington Ave. S.E.  
331-5240

**Campus Pizza**

818 Washington Ave. S.E.

WE DELIVER

331-7964

**MENU**

ALL PIES HAVE CHEESE

	Small	Medium	Large
CHEESE .....	\$1.00	\$1.60	\$2.05
BEEF .....	1.35	2.15	3.05
SAUSAGE .....	1.35	2.15	3.05
PEPPERONI .....	1.35	2.15	3.05
ANCHOVIES .....	1.50	2.25	3.05
GREEN PEPPERS .....	1.50	2.25	3.05
ONIONS .....	1.35	1.80	3.05
MUSHROOMS .....	1.50	2.35	3.15
TUNA .....	1.50	2.25	3.05
OLIVES .....	1.50	2.25	3.05
SHRIMP .....	1.50	2.25	3.05

**SPECIALS**

SAUSAGE & MUSHROOMS .....	\$1.90	\$2.65	\$3.55
SAUSAGE & ONION .....	1.50	2.25	3.25
SAUSAGE & GREEN PEPPERS .....	1.60	2.50	3.30
SAUSAGE & PEPPERONI .....	1.60	2.60	3.45
CAMPUS DELUXE .....	2.15	3.20	4.20

Open 4 P.M. 7 Days

plus Minnesota Sales Tax

FRI. & SAT. IN THE GROTTO



AT

**VALLI PIZZA**

MON.-THURS. .... 11 a.m.-2 a.m.  
FRI. & SAT. .... 11 a.m.-2:30 a.m.  
SUNDAY .... 11 a.m.-1:30 a.m.  
412 14th Ave. S.E. 331-1361  
Dinkytown We Deliver

**Quarterback  
Club Drive-In**

Headquarters for the  
finest in:

- HAMBURGERS
  - HOT DOGS
  - CHICKEN DINNERS
- 219 Oak St. S.E.  
331-5288

HOURS: 11 a.m. to 1 a.m. Fri. & Sat.  
11 a.m. to Midnight Sun.-Thurs.



## SKI EQUIPMENT & SUPPLIES

THE SKI DEN  
724 Washington—331-2310

THE SPORTSWORLD INC.  
307 S.E. Oak—331-7331

## SPORTING GOODS—RETAIL

THE SKI DEN  
724 Wash. Ave. S.E.—331-2310

THE SPORTSWORLD INC.  
307 S.E. Oak—331-7331

## STORAGE

BOYD TRANSFER & STORAGE  
400 E. Lake—823-5271

## TELEVISION, RADIO REPAIRS

COLOR TV  
419 14th Ave. S.E.—338-2777

## THEATERS

COOPER CINERAMA  
5755 Wayzata Blvd.—544-1506

# Shoes

for

College

Men & Women

Weejuns • Sebago • Sandler •  
Freeman • Hush Puppies •  
British Walkers • Tempos •  
Clarks • U.S. Keds •



# NORTHWEST TECHNICAL INSTITUTE

*a two-year private school  
granting the*

*Associate of Science  
DEGREE*

*in  
drafting and design technology*

**LOW INTEREST TUITION LOAN PROGRAM  
to qualified students**

an unprecedented demand exists  
**NATIONWIDE**  
for 2-year technical institute graduates

**REQUEST BULLETIN**

**7600 STATE HWY. 7  
MPLS., MINN. 55426 Phone 938-9111**

## YOUR FUTURE—? START WITH ELECTRONICS TECHNICIAN

TRAINING

We can help you prepare for a well-paid position or advancement in your present job. Phone, write or visit us for information on short courses, refresher courses, master courses, each planned to train you for one of the many jobs in this dynamic field of opportunity.

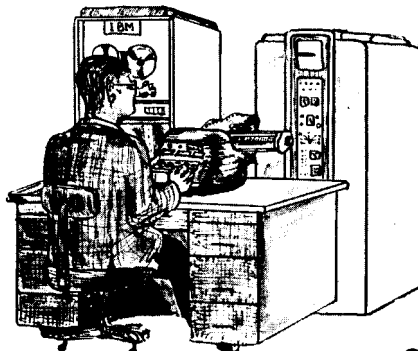

One Of The Largest Schools In  
The Country Devoted Exclusively  
To Teaching Electronics

### COURSES:

- ELECTRONICS TECHNOLOGY
- BUSINESS MACHINE TECHNOLOGY
- INDUSTRIAL ELECTRONICS
- COMPUTER TECHNICIAN
- COMMUNICATIONS ELECTRONICS
- RADIO-TELEVISION TECHNICIAN
- COMPUTER PROGRAMMING
- TRANSISTORS

**DAY AND EVENING CLASSES  
FREE PLACEMENT SERVICE**

**TELEPHONE 721-2469 OR WRITE  
FOR FREE CATALOG**

Approved for G.I. Training  
Approved for Student Loans

**Northwestern  
Electronics Institute**

— a non-profit school —  
3800 Minnehaha South Call 721-2469

# Why choose **MINNEAPOLIS** **BUSINESS COLLEGE?**

Our graduates will tell you these are  
just some of the reasons:

**Free use of textbooks** for all diploma courses. No big cash outlay for books, no surprise expenses. Compare!

**Personal attention** in smaller, more intimate classes. With new classes beginning each month, you're not just "a drop in the bucket." You're an individual!

**More intensive training** and a more thorough education for a profitable business career. Training with us is unsurpassed by any college or university in the Midwest. Because business training is our only business!

**Private tutoring free.** Those needing extra help receive it in private classes without paying one extra penny. Compare with others!

**Outstanding faculty** is rigorously selected for superior educational background. Our staff includes among others, lawyers and C.P.A.'s.

**Free placement service** for the rest of your life! Our Placement Department is at your service without charge throughout your career!

**Free refresher courses.** Our graduates may return any time for entire review of any completed course. No tuition charge.

**Part time jobs** available while you are enrolled at M.B.C.

Differences like these have made us leaders in business education since 1874. Why settle for less?

## Select your course:

Business Administration • Accounting (C.P.A.) • Salesmanship and Merchandising  
Speed Shorthand • Key Punch—IBM and Remington Rand Automation • Bookkeeping  
Machine • Private Secretarial • Medical Secretarial • General Clerical • Receptionist  
Secretarial • Office Machines • Comptometer • Data Processing, Wiring, Programming.

These elective courses are part of your basic curriculum at no extra charge:  
Pat Smiley Grooming and Personality Course • Executive Development Course (career  
training for young executives) • Reading Development.

Accredited—Accrediting Commission for Business Schools, Washington, D.C.  
Approved for Veteran Training

**CLASSES START FIRST MONDAY EACH MONTH  
DAY AND EVENING CLASSES**

Call now for free catalog, 332-4338

# **MINNEAPOLIS**

## **BUSINESS COLLEGE**

NICOLLET AT 10TH

AT THE TOP OF THE MALL

**EAST SIDE THEATRE**  
311 Ramsey—226-0625

## **TOBACCO SHOPS**

**THE PODIUM**  
417 14th Ave. S.E.—332-9008

## **TRAVEL AGENCIES**

**AAA WORLD WIDE TRAVEL  
AGENCY**  
13th St. at LaSalle Ave.  
332-0255

**AMERICANS ABROAD  
TRAVEL SERVICE**  
317 14th Ave. S.E.—331-7909

**AMERICAN EXPRESS**  
131 S. 7th St.—335-7777

**MERCURY TRAVEL SERVICE**  
352 Robert St., St. Paul—227-8217

## SEE THE **GRISWOLD**

**BOYS FOR TYPEWRITER:**

- RENTAL
- EXCHANGE
- SALES
- REPAIR

3111 Nicollet Open 9 to 9 TA. 7-4741

## **CRANE'S 2 Stores** in **Dinkytown**

Visit

## **CRANE'S GIFTS**

for Cards

A Treasure House of Gifts from  
all over the World

A Large Selection of Imports  
for all Occasions

## **CRANE'S GIFT STORE**

324 14th Ave. S.E.

and also

Shop **CRANE'S** for Office/School Supplies  
Typewriters

Luggage

Paper Bargains

Typewriters Cleaned

Only \$4.00 Incl. Ribbon

We take trades

## **CRANE'S OFFICE & SCHOOL SUPPLIES**

1417 4th St. S.E.

## TYPEWRITERS—RENTAL & REPAIR

AAA TYPEWRITER CO.

477 Cedar—224-7881

1006 Marquette Ave.—339-3086

Southdale Center—927-4421

GRISWOLD TYPEWRITER CO.

HERMES SALES & SERVICE

3111 Nicollet Ave.—827-4741

## TYPING SERVICES

DEPENDABLE THESIS TYPING,

Duplicating, Mimeographing—

Donalene—824-1003

## WOMEN'S SHOES

(SEE SHOES)

TYPEWRITERS SALES, RENTAL, REPAIRS  
BEST DEALS IN TOWN ON NEW & USED  
MACHINES. NORTHWEST'S LARGEST!  
YOUR OLYMPIA DEALER

**AAA** TYPEWRITER CO.

Special Student  
Rental,  
Purchase Plans

477 Cedar St. at 8th  
St. Paul—224-7881  
1006 Marquette—339-3086  
Southdale Center—927-4421

## It Pays to Buy From a Specialist

SKIING                      SPORTS APPAREL  
GOLF                        SPORTS FOOTWEAR  
TENNIS                      BACK PACKING  
TABLE TENNIS              LEVI'S  
                                  ATHLETIC SUPPLIES

We Fit You Correctly!  
Friendly, Personal Service

**The Ski Den**

SPORTING GOODS

724 Washington Av. S.E. 331-2310  
Next to University National Bank

- DRY CLEANING
- SHIRT LAUNDRY
- TUXEDO RENTALS

IN BY 10 — OUT BY 5  
Same Day Service

**KAMPUS  
KLEANERS**

1301 4th St. S.E. 331-1053

# EASTSIDE THEATRE

311 Ramsey 226-0625

ST. PAUL'S  
QUALITY  
THEATRE

Year-round  
Entertainment  
Call Dayton's or  
226-0625

## Mercury Travel Bureau

131 ENDICOTT ARCADE — ST PAUL

Europe by Air or Ship  
Eurail Pass

Tickets For Travel Anywhere

227-8217

## FREE SERVICE ON AIRLINE TICKETS

Call 331-1261 for PLANE RESERVATIONS

Or stop in at our convenient campus office.  
Tickets issued on all airlines at no extra  
charge. Charge accounts for faculty and  
staff. Call us for all travel needs:

- All-student Europe tours—\$397 to \$1320  
(join in Europe or travel over with group)
- Plane and ship tickets on all lines
- Car rental and hotel reservations
- Foreign travel for families, sabbaticals,  
etc.

AMERICANS ABROAD, INC.

317 14th Ave. S.E. (in Dinkytown)

Plane Tickets: 331-1261

Travel arrangements: 331-7909

# Cooper

5755 Wayzata Blvd.  
MINNEAPOLIS  
FREE PARKING

## CINERAMA

BOX OFFICE OPEN

9:30-9 daily; Noon-9

Sundays

## THEATER

SPECIAL ATTENTION GIVEN TO  
GROUPS!! For information, contact our  
director of special services by phone,

544-1506

# TRAVEL?

AMERICAN EXPRESS

*The Company for People who Travel*

## ESCORTED TOURS

Air and Steamship Transportation  
to all Parts of the World  
TRAVEL INCENTIVE TOURS

& GROUP MOVEMENTS

Individual, Fraternities, Sororities, Clubs,  
OUR SPECIALTY

131 So. 7th St.

335-7777

with over 400 Offices around the World

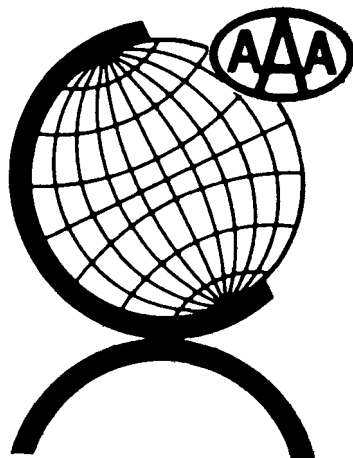

*Your Auto Club  
brings the world  
to you*



travel agency facilities are complete and  
world-wide . . . airline tickets, steamship  
tickets, tours, cruises, international driving  
licenses, foreign car information . . . you name it.  
Your experienced AAA counselor will arrange it for  
you.



not only takes care of all the details  
before you leave. It also takes care of  
you after you get there! 65 AAA offices  
and 350 representatives are spotted in major cities  
overseas. No matter where you go, it's like having a  
helpful friend always close as the nearest telephone.

TO PITTSBURGH . . . OR . . . TO PARIS

The Wise Traveler Goes AAA

Airline tickets, steamship tickets, tours, cruises, international driving licenses, foreign car  
information . . . you name it. Your experienced AAA counselor will arrange it for you.



World-wide Travel Agency

AUTOMOBILE CLUB OF MINNEAPOLIS

LaSalle at 13th Street, Minneapolis, Minnesota 55403

# Save Steps

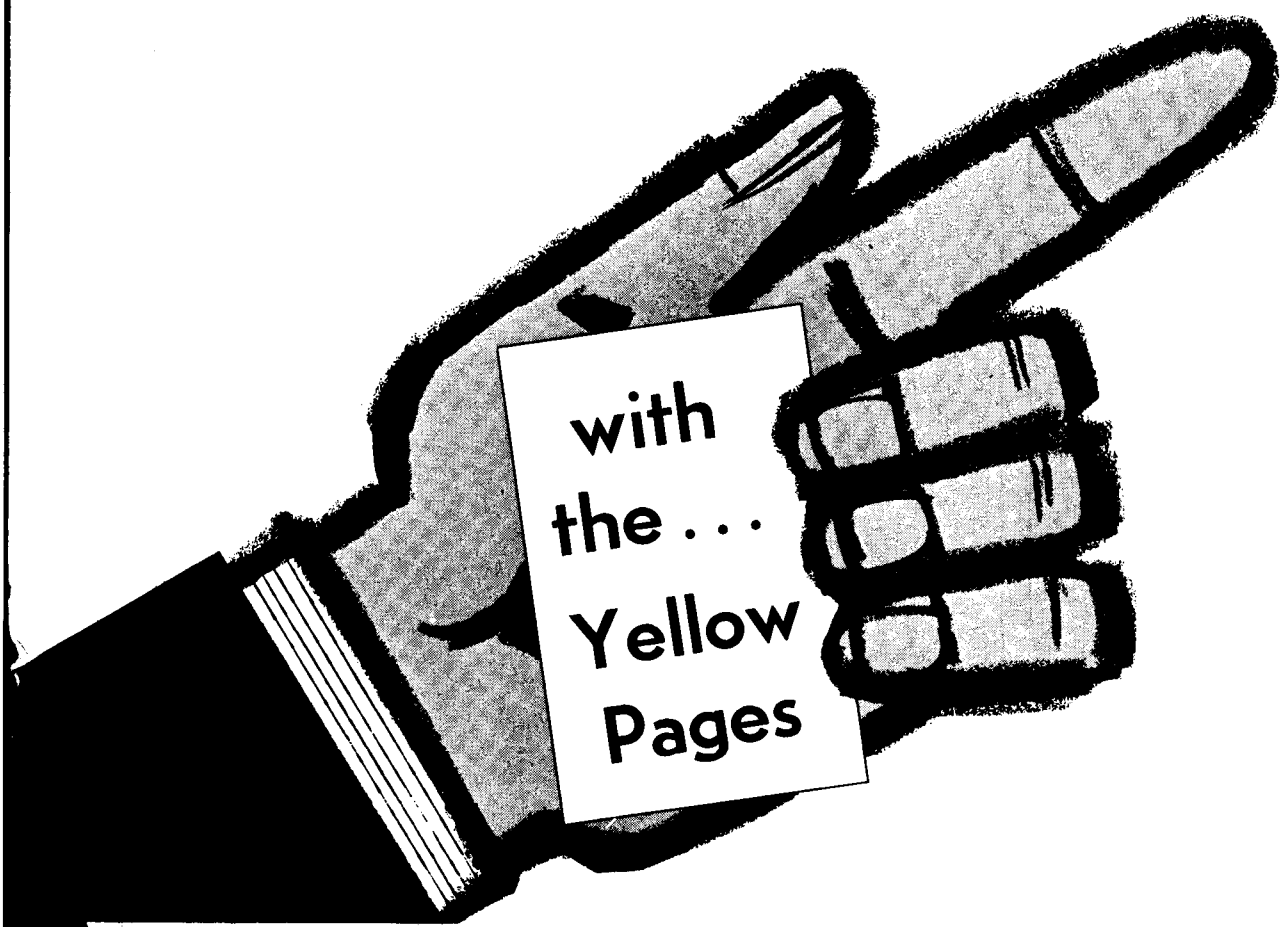

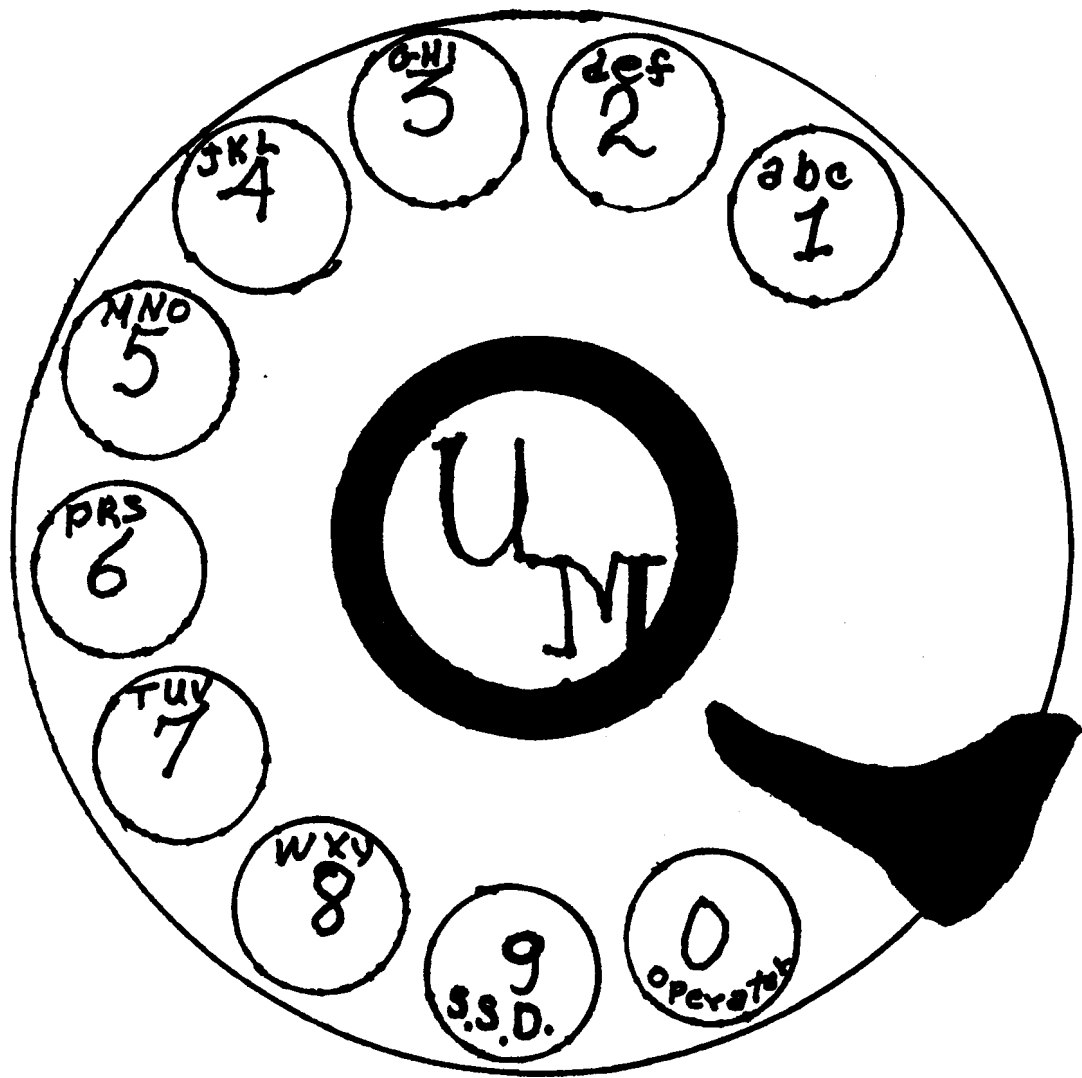

**UNIVERSITY**  
**of**

**MINNESOTA**

*Student-Staff*  
*Directory*

**Yellow Pages**

# ZIPPP'S LIQUOR STORE

2618 East Franklin



MR. ZIPPY SAYS:

FAST SERVICE WITH

**ZIPPP'S**

**FE 6-8686**



# MINNESOTA SCHOOL OF BUSINESS

## A PROFESSIONAL SCHOOL OF BUSINESS EDUCATION

Accredited by — The Accrediting Commission for Business Schools, Washington, D.C.  
Approved by — The State Department of Education for Veteran and Rehabilitation Training  
The National Shorthand Reporters Association

## COURSES OF STUDY

### SECRETARIAL

Executive  
Legal

Private  
Advertising  
College

Medical  
Receptionist

### BUSINESS ADMINISTRATION

With majors in — Business Management  
Accounting and Business Law  
Accounting, Law, and Automation

### COMPUTER PROGRAMMING

### OFFICE AUTOMATION COURSES

#### IBM Machine Training

Courses offered: Computer Programming; Tab Operation and Control Panel Wiring; and Key Punch.

All instructors are professionals in the field of automation. Students receive personal instruction plus "on-the-machine" training in our IBM machine laboratory, which includes an IBM 360 Computer on premises.

An aptitude analysis is required prior to enrollment and is given at our school without charge or obligation.

Automation Institute Courses are featured and are exclusive at this school.

Free nationwide placement assistance.

### ACCOUNTING AND MACHINES

### COURT REPORTING

with Stenograph\*

Financial rewards are exceptionally good for graduates of the Minnesota School of Business Court Reporting Course. Starting salaries are usually \$6,000.00 to \$8,000.00 per year. Employment opportunities are ample throughout the entire country for Official Court Reporters, freelance, or Federal Court Reporters. Graduates receive free placement service.

The Court Reporting Course of the Minnesota School of Business is approved by the National Shorthand Reporters Association.

\*The Stenograph—a silent word-at-a-time shorthand machine—is featured in this course.

#### Exclusive at MSB in this area

- Nancy Taylor Course—Personal development for ladies.
- Mr. Executive—Leadership development for men.
- PAR (Powereading)—Reading speed and comprehension.
- Automation Institute Courses.
- Speedwriting Shorthand (ABC).
- PBX Switchboard-Receptionist Training (Utt System).

**Free Lifetime Placement Privileges for All Graduates**

**Girls' Dormitory**

**New Classes Begin January, April, July, and September**

**Applications for Admission Must Be Submitted in Advance**

The Minnesota School of Business Bulletin of Courses will be sent upon request.

*Call 338-6721, or write the*

## MINNESOTA SCHOOL OF BUSINESS

24 South Seventh Street

Minneapolis, Minnesota 55402

Between Nicollet and Hennepin

# NOW...STATE CAPITOL CREDIT UNION'S UNIVERSITY SERVICE CENTER

HAS MOVED ON CAMPUS TO SERVICE ITS MEMBERS

OVER 16,000 FACULTY AND  
STAFF PERSONNEL CAN NOW  
OBTAIN PERSONAL FINANCIAL  
ASSISTANCE BY DIALING

# 331-5172

**ALSO...** Credit Union  
Representatives Now  
Located in These Locations

#### UNIVERSITY HOSPITAL

Room D-103  
Phone: 331-7609  
Hours: 2:00-5:00 Daily

#### WEST BANK

School of Business Admin. Tower  
Room 421  
Phone: 373-4919  
Hours: 12:30-1:00 & 4:00-5:00 Daily

#### ST. PAUL CAMPUS

Dining Center Bldg. - Room 139  
Phone: 646-8366  
Hours: 12:00-3:00 Daily

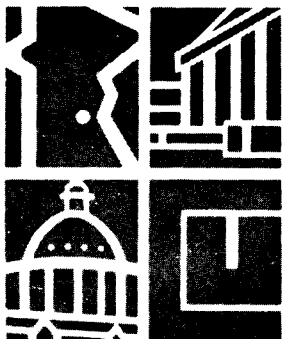
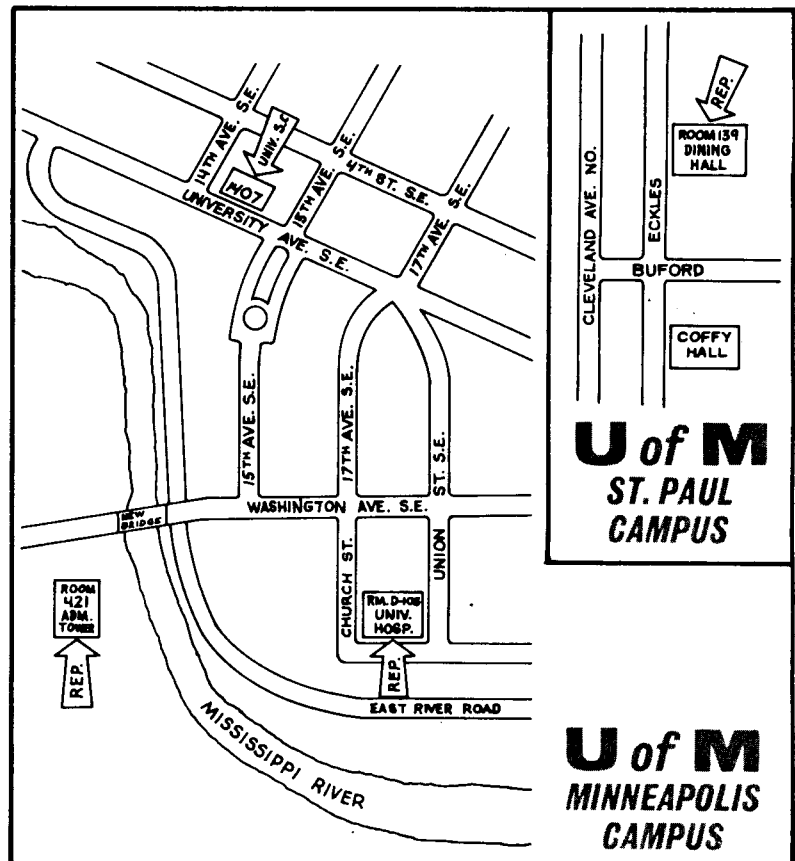

## UNIVERSITY SERVICE CENTER

1407 UNIVERSITY AVE. S.E.      PHONE 331-5172

Hours: 8:45-5:45 Daily ... 10th, 15th, 25th, 30th each month open till 6:30



**Feeling lost?**



## **Get a Northwestern Checkbook.**

You can budget your bread better with a checkbook. (And if broke at the end of the month, at least you'll know where the dough went.)

You get separate deposit slips, too. No cost when you make a deposit.

You get a fully itemized statement every

month. Shows every check, every deposit . . . not just totals.

You can deposit by mail if you don't dig downtown. We supply pre-addressed envelopes to save you the trip.



**Northwestern  
National  
Bank**

*May we help you today?*