

Images



1. Leon Battista Alberti, Santa Maria Novella, Florence, 1470¹



2. Andrea Palladio, Villa Rotunda, Fanzolo, Italy, 1550 (Sokolov²)

¹ Dillon, Meg. "Santa Maria Novella." Florence. March 19, 2015. Accessed February 28, 2016. <http://florenceforfree.co/2015/03/19/basilica-of-santa-maria-novella/>.

² Sokolov, Georgi. "Villa Emo." OpenBuildings. Accessed February 28, 2016. <http://openbuildings.com/buildings/villa-emo-profile-6969>.

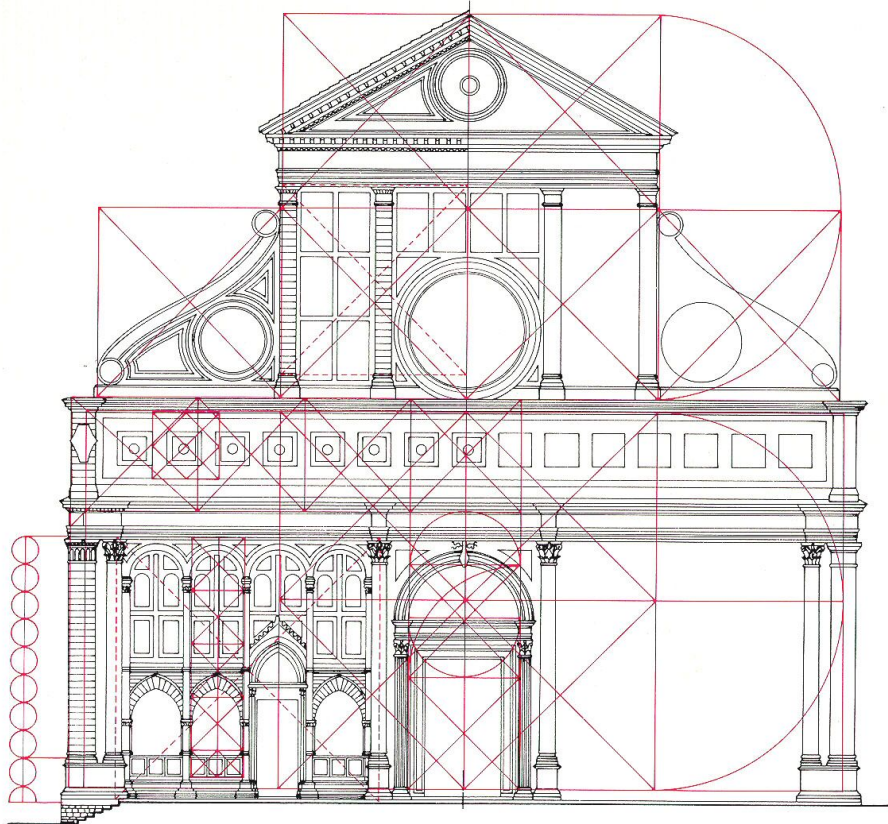

3. Leon Battista Alberti, Santa Maria Novella, Florence, 1470 (Partridge, L. W.³)

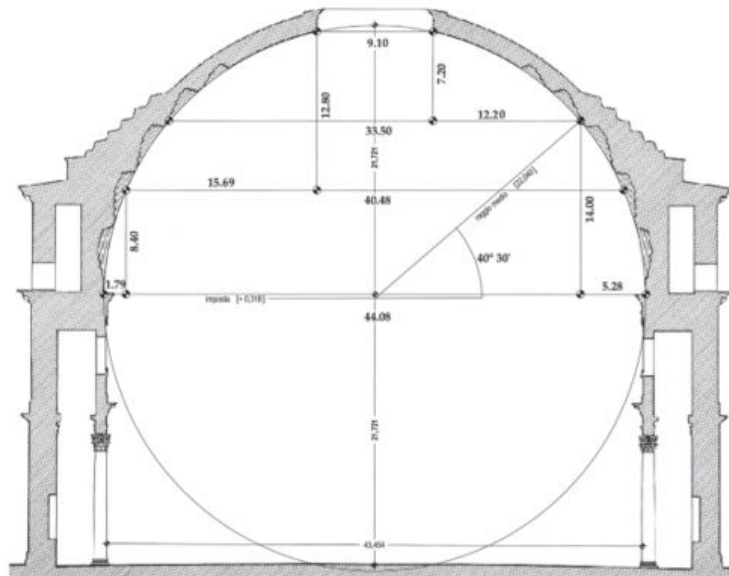

4. Hadrian, Pantheon, Rome, 126BC (Harrison, Alec⁴)

³ Partridge, L. W. (2009). *Art of Renaissance Florence, 1400-1600*. Berkeley: University of California Press.

⁴ Harrison, Alec. *The Pantheon*. 1990. Rome. Web. <[https://engineeringrome.wikispaces.com/Construction and Behavior of the Pantheon](https://engineeringrome.wikispaces.com/Construction+and+Behavior+of+the+Pantheon)>.

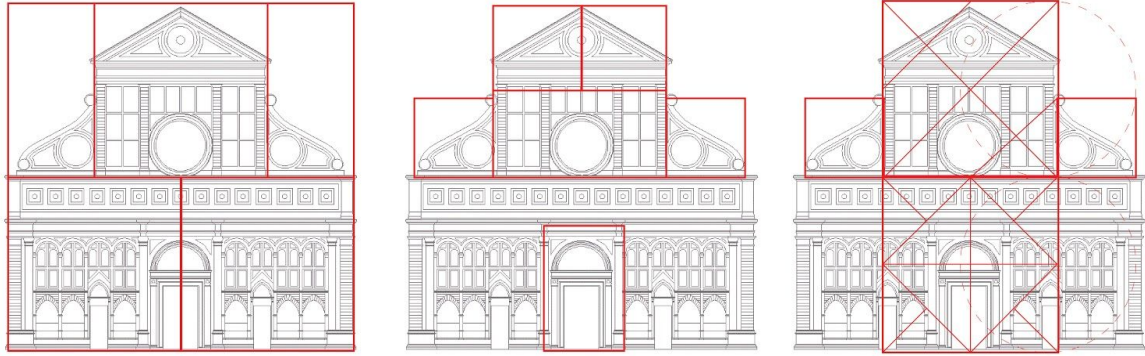

5. Leon Battista Alberti, Santa Maria Novella, Florence, 1470 (Matuke⁵)



6. Florentine Baptistery, Florence, 1059 (Balter, Andrew⁶)

⁵Matuke, Samantha. "Santa Maria Novella Facade." Digital image. This graphic was created by the author.

⁶ Balter, Anthony. Florentine Baptistery. Florence. Travel Through Italy. Web.

<<http://travelthroughitaly.com/baptistry/>>.

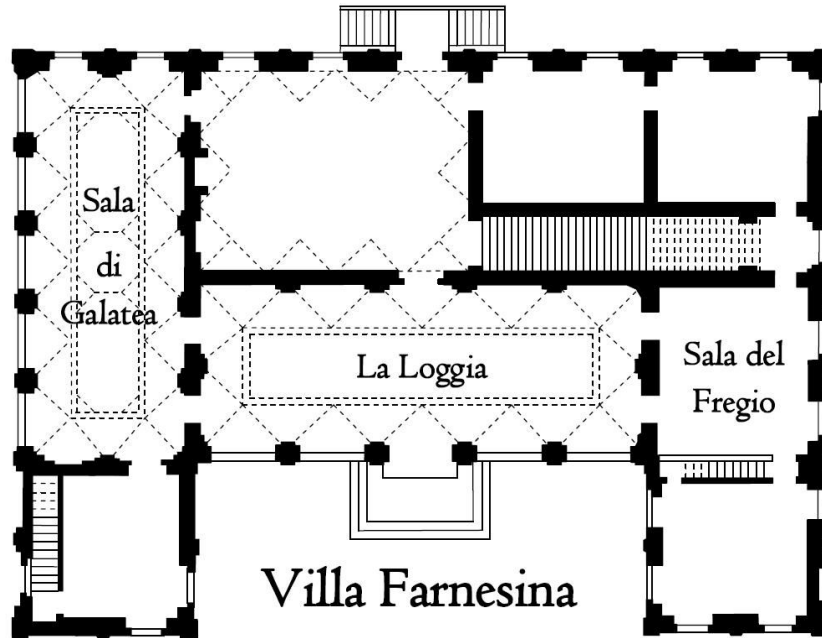

7. Peruzzi, Baldassarre, Villa Farnesina, Rome, 1506 (Mazeppa, Ryan⁷)

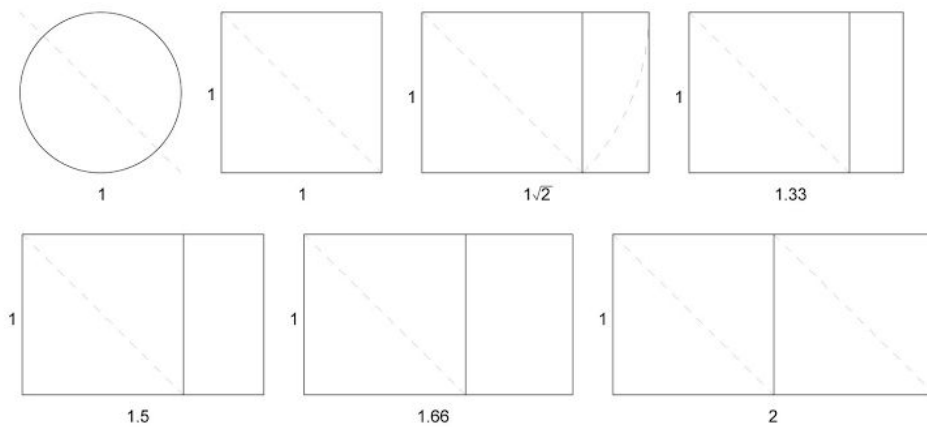

8. Palladian Room Proportions, (Lewis, Robert⁸)

⁷ Mazeppa, Ryan. *Villa Farnesina*. Rome. <http://www.brynmawr.edu/cities/Cities/wld/04360/04360m.html>. Web

⁸ Lewis, Robert. *Palladian Proportions*. Web.

<<https://happyarchitectureblog.wordpress.com/2010/06/21/3-0-academic-research-2/>>.

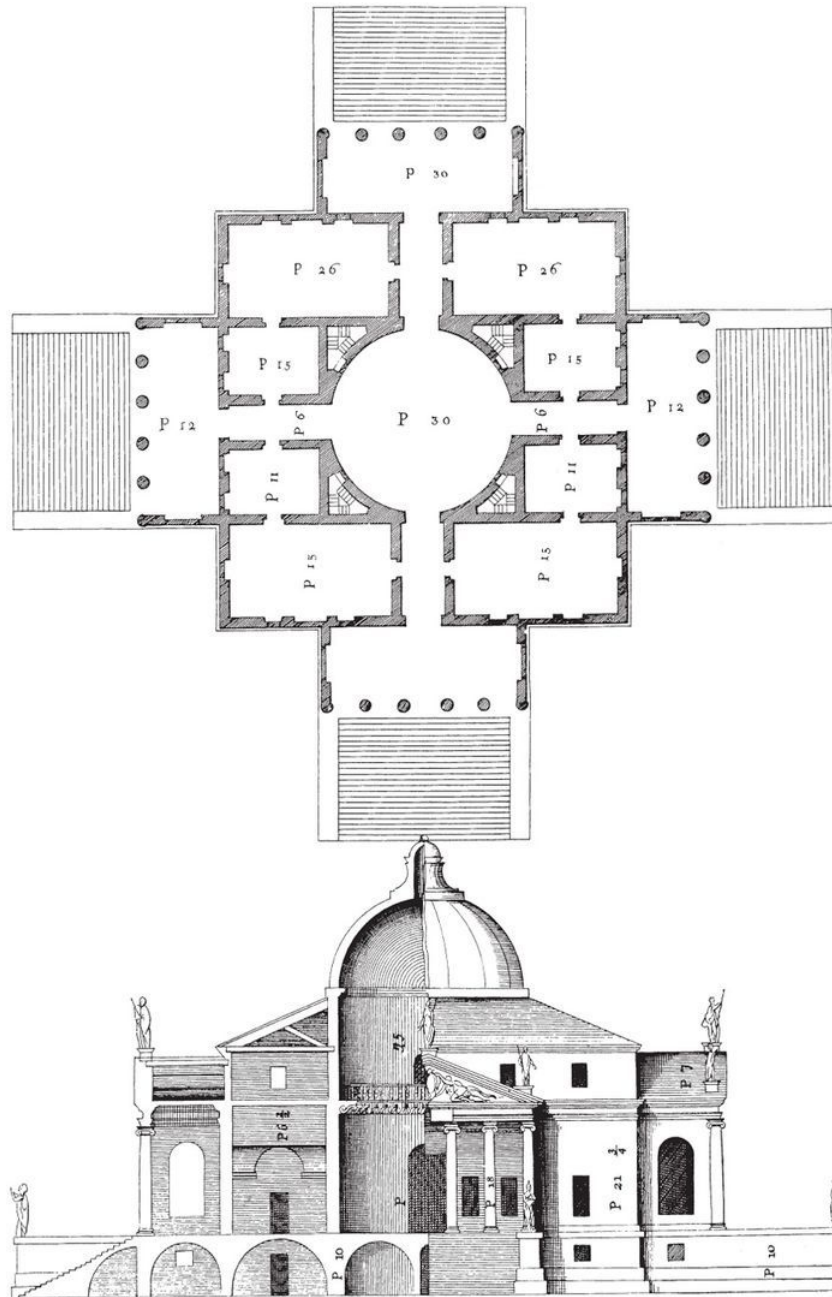

9. Andrea Palladio, Villa Rotonda, Vicenza, 1566 (Berzal, Javier⁹)

⁹ Berzal, Javier. *La Rotonda*. Khan Academy. Web.

<<https://www.khanacademy.org/humanities/renaissance-reformation/renaissance-venice/late-renaissance-venice/a/palladio-la-rotunda>>.

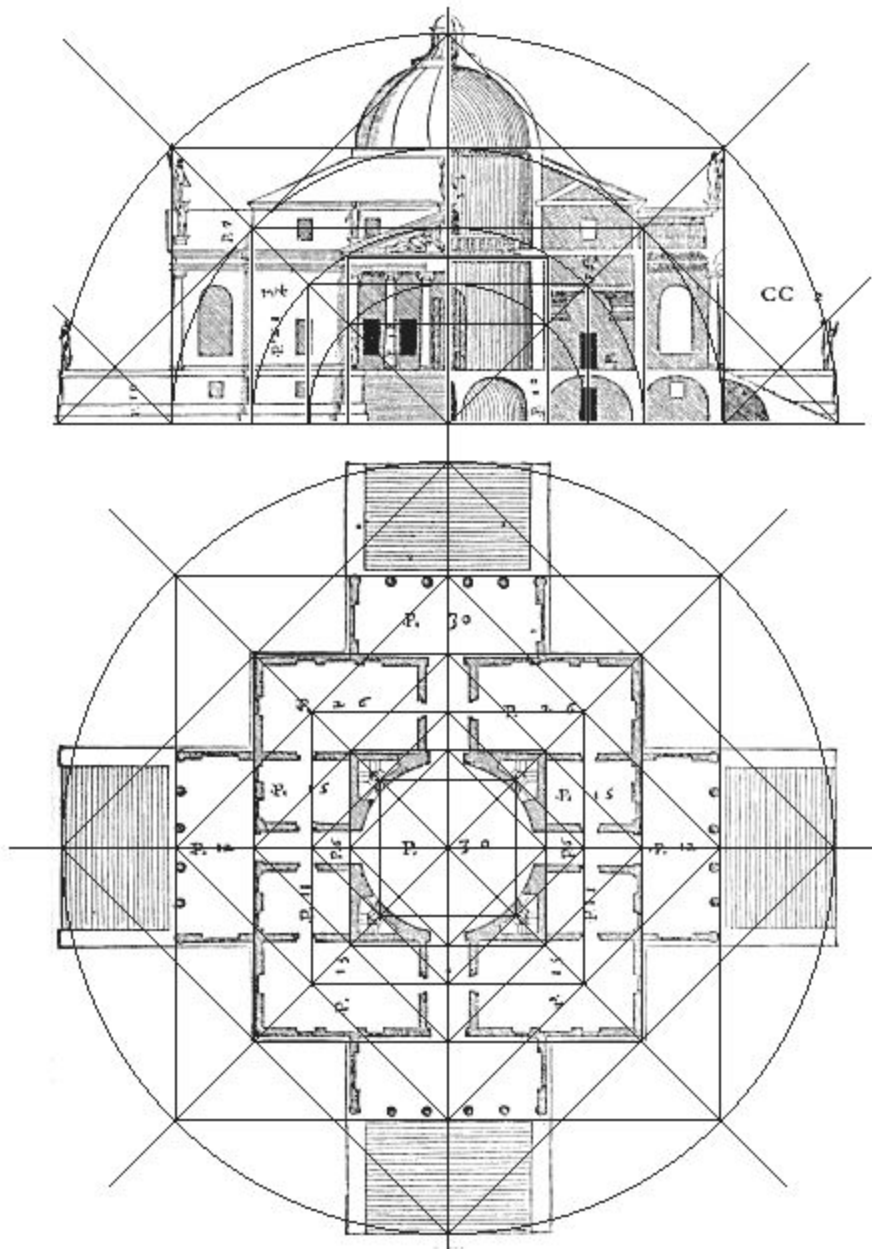

10. Andrea Palladio, Villa Rotunda, Vicenza, 1566 (Linden, Jane¹⁰)

¹⁰ "Selena En La Próxima Estación." Melioria. La Villa. Accessed April 30, 2016.
<http://selenaenlaproximaestacion.blogspot.com/2012/01/meliroria-la-villa.html>.