



The Design of a Minimal Sensor Configuration for a Cooperative Intersection Collision Avoidance System—Stop Sign Assist: CICAS-SSA Report #2

Final Report

Prepared by:

Alec Gorjestani
Arvind Menon
Pi-Ming Cheng
Craig Shankwitz
Max Donath

**Intelligent Vehicles Laboratory
Department of Mechanical Engineering
University of Minnesota**

CTS 10-32

Technical Report Documentation Page

1. Report No.		2. Government Accession No.		3. Recipient's Catalog No.	
4. Title and Subtitle The Design of a Minimal Sensor Configuration for a Cooperative Intersection Collision Avoidance System – Stop Sign Assist: CICAS-SSA Report #2				5. Report Date August 2010	
				6. Performing Organization Code	
7. Author(s) Alec Gorjestani, Arvind Menon, Pi-Ming Cheng, Craig Shankwitz, Max Donath				8. Performing Organization Report No. CTS Project #2006050	
9. Performing Organization Name and Address Department of Mechanical Engineering University of Minnesota 111 Church Street S.E. Minneapolis, Minnesota 55455				10. Work Unit No. (TRAIS)	
				11. Contract or Grant No.	
12. Sponsoring Agency Name and Address				13. Type of Report and Period Covered Work started March 2008. Draft report submitted to Mn/DOT: January 2009.	
				14. Sponsoring Agency Code	
15. Supplementary Notes					
16. Abstract The deployment of a Cooperative Intersection Collision Avoidance System – Stop Sign Assist (CICAS-SSA) can save lives by addressing the causal factor of crashes at rural thru-Stop intersection: drivers who stop on the minor leg of the intersection, improperly assess the gaps in the traffic on the major leg, proceed, and are then hit. The prototype CICAS-SSA system consisted of a network of sensors covering both the minor and the major legs of the intersection. Sensors on the minor road monitored the approach of vehicles and classified them based on their length and height. Sensors along the major road were arrayed to track vehicles (and the gaps between them) approaching the crossroads from 2000 feet away as a means to ensure that the tracking algorithm had sufficient time to “lock on” and track all approaching vehicles. Because cost is a primary concern for any highway safety application, the development of a “minimal sensor set” which would provide adequate safety performance for minimum cost was paramount to the success of the CICAS-SSA program. This report documents the development of this minimal sensor configuration.					
17. Key Word Rural highways, Unsignalized intersections, Highway safety, Collisions, Gap acceptance, Cooperative Intersection Collision Avoidance Systems-Stop Sign Assist (CICAS-SSA) program, Warning signs, Sensors, Traffic surveillance, Arterial highways, Secondary roads			18. Distribution Statement No restrictions. Document available from: National Technical Information Services, Springfield, Virginia 22161		
19. Security Classif. (of this report) Unclassified		20. Security Classif. (of this page) Unclassified		21. No. of Pages 61	22. Price

The Design of a Minimal Sensor Configuration for a Cooperative Intersection Collision Avoidance System – Stop Sign Assist: CICAS-SSA Report #2

Submitted to

Federal Highway Administration
U.S. Department of Transportation
1200 New Jersey Ave SE
Washington, DC 20590

Prepared by

Alec Gorjestani
Arvind Menon
Pi-Ming Cheng
Craig Shankwitz
Max Donath

Intelligent Vehicles Laboratory
Department of Mechanical Engineering
University of Minnesota
111 Church Street SE
Minneapolis, MN 55455

August 2010

In response to Cooperative Agreement Number DTFH61-07-H-00003

The contents of this report reflect the views of the authors, who are responsible for the facts and the accuracy of the information presented herein. The U.S. Government assumes no liability for the contents or use thereof. This report does not necessarily reflect the official views or policies of the Federal Highway Administration, the Minnesota Department of Transportation, or the University of Minnesota.

The authors, the Federal Highway Administration, the Minnesota Department of Transportation, the University of Minnesota, and the U.S. Government do not endorse products or manufacturers. Trade or manufacturers' names appear herein solely because they are considered essential to this report.

Acknowledgements

We would like to thank the Minnesota Department of Transportation (Mn/DOT) for help with installation and for providing guidance on roadside and site line regulations. Also deserving gratitude is Tom Shane and his crew for installing the electricity and data cables at the Hwy 52 test intersection.

This work is funded by the United States Department of Transportation Federal Highway Administration (US DOT FHWA) and MN/DOT through Cooperative Agreement DTFH61-07-H-00003, and by State Pooled Fund Project TPF-5(086).

Listed below are the currently available reports in the CICAS-SSA Report Series (as of August 2010):

Determination of the Alert and Warning Timing for the Cooperative Intersection Collision Avoidance System – Stop Sign Assist Using Macroscopic and Microscopic Data: CICAS-SSA Report #1

Prepared by: Alec Gorjestani, Arvind Menon, Pi-Ming Cheng, Craig Shankwitz, and Max Donath

The Design of a Minimal Sensor Configuration for a Cooperative Intersection Collision Avoidance System – Stop Sign Assist: CICAS-SSA Report #2

Prepared by: Alec Gorjestani, Arvind Menon, Pi-Ming Cheng, Craig Shankwitz, and Max Donath

Macroscopic Review of Driver Gap Acceptance and Rejection Behavior at Rural Thru-Stop Intersections in the U.S. – Data Collection Results in Eight States: CICAS-SSA Report #3

Prepared by: Alec Gorjestani, Arvind Menon, Pi-Ming Cheng, Bryan Newstrom, Craig Shankwitz, and Max Donath

Sign Comprehension, Considering Rotation and Location, Using Random Gap Simulation for Cooperative Intersection Collision Avoidance System – Stop Sign Assist: CICAS-SSA Report #4

Prepared by: Janet Creaser, Michael Manser, Michael Rakauskas, and Max Donath

Validation Study – On-Road Evaluation of the Cooperative Intersection Collision Avoidance System – Stop Sign Assist Sign: CICAS-SSA Report #5

Prepared by: Michael Rakauskas, Janet Creaser, Michael Manser, Justin Graving, and Max Donath

Additional reports will be added as they become available.

Table of Contents

Chapter 1 Introduction	1
Motivation	1
CICAS-SSA Surveillance System	2
Requirements of CICAS-SSA Sensors	4
Cost Consideration	4
Intrusive vs. Nonintrusive Sensing	5
Continuous vs. Point Sensing	5
Mounting Requirements	6
Power Considerations	6
Chapter 2 Vehicle Sensing Technologies	7
Inductive Loops	7
Vision	8
Passive Acoustic	9
Passive Infrared	10
Laser	11
OSI Autosense	11
SICK LMS221	11
Ibeo Lux	12
Radar	13
Delphi ACC3	14
Eaton VS-400	14
Wavetronix SmartSensor HD	15
Smartmicro UMRR	15
Candidates	16
Chapter 3 Minimal Sensor Configuration for the Mainline Surveillance System	17
Minimal Requirements for Surveillance System	17
Construction Costs	18
Minimal Sensor Set Using Eaton VS-400 or Delphi ACC3 77 GHz Radar	21
Minimal Sensor Set Using Ibeo Lux Scanning Laser	26
Minimal Sensor Set Using Smartmicro UMRR 24 GHz Radar	29
Chapter 4 Minor Road Sensing Cost Trade-Offs	34
Electrical Costs of Adaptive Display	34
Presence Detection on the Minor Road	36
Inductive Loops	37
Ibeo Lux Laser Scanner	39
Financial Analysis of Installing Minor Road Sensing	41
Using inductive loop detectors to monitor vehicle presence on minor road	41
Using Ibeo Lux to sense presence of vehicles on minor road	44
Extending Life Expectancy of Sign	47
References	48

List of Tables

Table 1: Cost estimates for the installation of a mainline surveillance system using the four candidate vehicle sensors on a rural four lane expressway thru-stop intersection	ES
Table 2: Cost estimates for the installation of a mainline surveillance system using the four candidate vehicle sensors on a rural two lane highway thru-stop intersection	ES
Table 3: Distance requirement of the surveillance system assuming speed of 10 mph above speed limit	17
Table 4: Actual construction costs for Hwy 52 intersection build provided by Shane Electric Co.	21
Table 5: Costs for equipment installed at each sensor station	21
Table 6: Minimal Surveillance System Costs for 77 GHz radar installed at rural four lane expressway thru-stop intersections	24
Table 7: Minimal surveillance system costs for 77GHz radar on rural two lane highway thru-stop intersection	25
Table 8: Minimal surveillance system costs for Ibeo Lux installed at a rural four lane expressway thru-stop intersection	27
Table 9: Minimal surveillance system costs for Ibeo Lux sensor at a rural two land road	29
Table 10: Minimal mainline surveillance system costs using Smartmicro UMRR on rural four lane expressway thru-stop intersection	31
Table 11: Minimal surveillance system costs using Smartmicro UMRR radar on a rural two lane highway thru-stop intersection.....	33
Table 12: Power consumption of one Adaptive 112 x 80 pixel display	35
Table 13: Yearly electricity cost of one Adaptive display based on current average cost of electricity.....	36
Table 14: Yearly cost savings if minor road and median sensors are installed so that the sign is turned off when minor road traffic is not present	36
Table 15: Percentage of time a minor road vehicle was detected at the intersection, one day period	42
Table 16: Net present value of installation minor road sensing vs. cost savings obtained by turning the signs off when no traffic present	43
Table 17: Net present value of installing inductive loop sensors on a rural 2 lane highway thru-stop intersection in order to reduce electricity costs running the DII signs.....	44
Table 18: Net present value of installing Ibeo Lux sensors at a rural four lane expressway thru-stop intersections to monitor presence of traffic on minor road, using various sensor cost	46
Table 19: Net present value of installing Ibeo Lux sensors at a rural two lane highway thru-stop intersection to monitor presence of traffic on minor road, using various sensor cost	47

List of Figures

Figure 1: Plan view of a typical instrumented rural four lane expressway intersection. Sensors are radar (yellow triangles indicate field of view and) scanning lidar (orange semicircles); all data is sent from sensor processors to the main central processor.....	3
Figure 2: Diagram showing definition of lane coverage for a CICAS-SSA range sensor	5
Figure 3: The SAS-1 sensor mounted in a side fire configuration can detect multiple lanes.....	10
Figure 4: Ibeo laserscanner price-volume-time curve	13
Figure 5: Probability Density Function of the range of speed of vehicles traveling on the mainline (US 52) that went straight through the intersection.....	18
Figure 6: Network topology of Hwy 52 intersection. A star topology was chosen for robustness. DSL modems facilitated long range network connection between central server and computer stations.	19
Figure 7: Minimal sensor surveillance system network topology. Daisy chained to reduce construction costs. Ethernet extenders (long distance) and Ethernet hubs (short distance) are employed for network connectivity to the central server. Microprocessors are used to interface with range sensor hardware.	20
Figure 8: Minimal sensor suite layout required for mainline surveillance system on rural four lane expressway thru-stop intersections using specifications for Delphi ACC3/Eaton VS-400 radar	22
Figure 9: Proposed minimal sensor surveillance system hardware layout for rural four lane expressway thru-stop intersections with Delphi ACC3/Eaton VS-400 radar.....	23
Figure 10: Minimal sensor suite layout required for mainline surveillance system on rural 2 lane highway thru-stop intersection using specifications for Delphi ACC3/Eaton VS-400 radar	24
Figure 11: Proposed minimal sensor surveillance system hardware layout for two lane roads with Delphi ACC3/Eaton VS-400 radar	25
Figure 12: Minimal sensor suite layout required for mainline surveillance system on rural four lane expressway thru-stop intersections using specifications for Ibeo Lux sensor	26
Figure 13: Proposed minimal sensor surveillance system hardware layout for rural four lane expressway thru-stop intersections using Ibeo Lux laser scanners.....	27
Figure 14: Minimal sensor suite layout required for mainline surveillance system on rural two lane highway thru-stop intersection using specifications for Ibeo Lux Sensor	28
Figure 15: Proposed minimal sensor surveillance system hardware layout for rural two lane highway thru-stop intersections with Ibeo Lux Sensor.....	29
Figure 16: Minimal sensor suite layout required for mainline surveillance system on rural four lane expressway thru-stop intersections using specifications for Smartmicro UMRR.....	30
Figure 17: Proposed minimal sensor surveillance system hardware layout using Smartmicro UMRR radar.....	31

Figure 18: Minimal sensor suite layout required for mainline surveillance system on rural two lane highway thru-stop intersection using specifications for Smartmicro UMRR radar.....	32
Figure 19: Proposed minimal sensor surveillance system hardware layout for rural two lane highway thru-stop intersection with Smartmicro UMRR radar.....	32
Figure 20: Bitmap representing the default DII state (no vehicles on mainline).....	35
Figure 21: Hardware layout of inductive loop installation of a four leg intersection, two lanes per approach.....	37
Figure 22: Hardware layout of proposed inductive loop installation of a rural four lane expressway thru-stop intersection.....	38
Figure 23: Hardware layout of proposed inductive loop installation on rural two lane highway thru-stop intersection	39
Figure 24: Proposed minor road vehicle presence detection sensor layout using Ibeo Lux, mounted on already existing posts, at rural four lane expressway thru-stop intersection. The field of view of the Lux is shown in green.....	40
Figure 25: Proposed minor road vehicle presence detection sensor layout using Ibeo Lux, mounted on already existing poles, on a rural two lane highway thru-stop intersection. The field of view of the Lux is shown in green.....	41

List of Pictures

Picture 1: Picture of the ADR600 signal processor	8
Picture 2: Picture of the Autoscope Solo camera.....	9
Picture 3: ASIM IR 250 series passive infrared sensor	11
Picture 4: Picture of the Sick LMS221	12
Picture 5: Picture of Ibeo Lux. The sensor is small, H85 x W128 X D83mm	12
Picture 6: Picture of the Delphi ACC3 radar	14
Picture 7: Picture of VS-400 radar.....	15
Picture 8: Picture of Wavetronix radar	15
Picture 9: Picture of Smartmicro UMRR radar.....	16

Executive Summary

A Cooperative Intersection Collision Avoidance System – Stop Sign Assist (CICAS-SSA) equipped intersection has the potential to save lives and injury by reducing crashes at thru-stop controlled intersections. The novel approach requires the sensing of every vehicle approaching the intersection on the major road and the calculation of each vehicle's dynamic state. This information allows the computation system to calculate gaps/lags for each vehicle so that the timing algorithm can trigger dynamic signs to display warnings and alerts to let minor road drivers know of unsafe gaps/lags. This additional information assists the minor road driver to decide whether it is safe to proceed.

This report focused on the surveillance system, the function of which is to detect every vehicle entering the intersection on the major road with enough accuracy so that state estimations can be made. Technical requirements of the surveillance system were based on previous research on the surveillance system, the Driver Infrastructure Interface (DII) and the timing algorithm. [8]. Prior work indicated that sensing on the minor road was not required and that sensing on the major road was required for up to 12 seconds for vehicles traveling 10 mph over the posted speed limit. Also, continuous vehicle state estimates were required at 10 Hz for timely trajectory estimation through the whole region of interest.

First, a scan of the current state of vehicle detecting sensors was conducted to discover the latest and best technology that meets the requirements of the CICAS-SSA surveillance system. Sensing technologies with short range were not selected because of the requirement of continuous coverage throughout the region of interest. That eliminated loop detectors and other functionally similar substitute technologies. Four vehicle-based sensors were determined to meet all the technical requirements and considered candidates for a CICAS-SSA surveillance system. Two 77 GHz automotive radar sensors were selected. The Eaton Vorad VS-400 and the Delphi ACC3 radar provide 150 meters of range to multiple vehicles at over 10 times per second. A 24 GHz radar from Smartmicro was also selected due to its long range (240 m) and wide field of view. Finally, a laser based sensor made by Ibeo was identified as a candidate. The Lux is a vehicle based system that has long range (200 m) and four parallel planes of detection. It also has multi-echo capability making it more robust to environmental conditions.

Two of the four candidate sensors were not yet available at the time this report was written. The VS-400 will be available with custom software written for the University of Minnesota by fall 2009. Production of the Ibeo Lux is scheduled for fall 2009. All four sensors will be tested at the test CICAS intersection at US Hwy 52 and Goodhue County Road 9 in Goodhue County before the proposed field operational test. The sensors will be tested in parallel and compared with the currently installed EVT-300 based surveillance.

Based on the technical specifications of the four candidate sensors, a minimal sensor configuration and cost estimate was determined for each of the four sensors for both a rural four lane expressway thru-stop intersection and a two lane rural two lane highway thru-stop intersection. For a rural four lane expressway thru-stop intersection, the total number of sensors required for 12 seconds of coverage in both directions is between four and six (two and three per leg) based on the selected sensor (Table 1). The cost of installing a minimal CICAS-SSA surveillance system is between \$48 K and \$109 K. The lowest cost estimate is based on

projected cost reductions of the Lux based on increased production volume. The three radar surveillance systems have a similar cost profile.

Table 1: Cost estimates for the installation of a mainline surveillance system using the four candidate vehicle sensors on a rural four lane expressway thru-stop intersection

Surveillance System Costs for Rural Expressway

Sensor	Number	Coverage	Cost (thousands)
Eaton VS-400	6	432 m, 12.9 s	\$ 64
Delphi ACC3	6	432 m, 12.9 s	\$ 64
Ibeo Lux	4	433 m, 12.9 s	\$ 106
Ibeo Lux*	4	433 m, 12.9 s	\$ 48
Smartmicro UMRR	4	445 m, 13.3 s	\$ 69

* Projected based on future sensor cost estimates from Ibeo

For a rural 2 lane highway thru-stop intersection, for all candidate sensors a total of four sensors were required to monitor the mainline (two per leg) for over twelve seconds (Table 2). The installation cost ranged between \$43 K and \$101 K with the current cost Ibeo Lux system the most costly and the projected future Ibeo Lux system as the least costly. The radar based system costs were between \$50 K and \$61 K.

Table 2: Cost estimates for the installation of a mainline surveillance system using the four candidate vehicle sensors on a rural two lane highway thru-stop intersection

Surveillance System Costs for Two Lane Road

Sensor	Number	Coverage	Cost (thousands)
Eaton VS-400	4	350 m, 12.0 s	\$ 50
Delphi ACC3	4	351 m, 12.0 s	\$ 50
Ibeo Lux	4	400 m, 13.8 s	\$ 101
Ibeo Lux*	4	401 m, 13.8 s	\$ 43
Smartmicro UMRR	4	440 m, 15.1 s	\$ 61

* Projected based on estimates from Ibeo

The work to develop the warning timing algorithm [8] revealed an insensitivity of the rejected gaps/lags to vehicle type, driver age, driver gender, time waiting for a gap and time of day. This means that the CICAS-SSA system does not strictly require minor road and median sensing. However, an analysis was conducted to determine whether it is worthwhile to install minor road surveillance so that the DII signs can be turned off at times when no vehicles are making a maneuver from the minor road. The idea is that presence detection on the minor road can help reduce energy costs because the LEDs can be turned off thereby saving electricity costs.

The electricity consumption of a sign is mainly due to its 26,880 LEDs. The maximum electricity draw occurs when a completely white image is displayed at 100% brightness. It was determined that for the typical DII image and accommodating for day/night brightness levels that the average electricity cost per year is \$961 per sign. Savings is highly dependent on the duty cycle, or the time the sign is not on (blackened). An analysis of data recorded at several different CICAS candidate intersections showed that the percentage of time vehicles were on the minor road during the daytime ranged between 20% and 60%.

The cost savings for different duty cycles was used and compared with the installation costs of inductive loops on the minor road. A Net Present Value (NPV) calculation showed that installing loop detectors for the purpose of saving electricity produces a negative NPV unless the duty cycle is 10% or less. Even at a 10% duty cycle the payoff period is 12 years. Since candidate CICAS intersections tend to have higher minor road traffic flows, a 10% duty cycle is unrealistic and that the electrical cost savings would not be worth the cost of median sensor installation. This held true for both rural four lane expressways and rural two lane highways.

An alternative to inductive loops is long range laser scanners. The Ibeo Lux shows promise as a minor road surveillance sensor because of its long range and ability to track slow moving and stationary vehicles. Long range allows flexible installation locations so that already installed sensor stations and DIIs can be used to greatly reduce installation costs. At its current cost of \$15 K, the net present value calculation is negative for the 20-year period in consideration. However, the projected price volume chart of the Lux provided by Ibeo shows that with increased production volume the cost of the Lux can be greatly reduced. If the Lux were to decrease in price to \$1000, installing Lux sensors to monitor the minor road would be economically rational. The payoff period is three years.

The analysis performed in this report shows that a CICAS-SSA surveillance system can be optimally deployed using one of several of the latest vehicle sensing technologies. The use of long-range vehicle sensors and the elimination of minor road sensing can reduce complexity and cost of the system. Cost estimation of the surveillance system is in the range of \$43 K to \$106 K and should reduce with economies of scale. The only additional cost is for the DIIs. The University of Minnesota acquired four DIIs for \$100 K and installed them at the US Hwy 52 and County Road 9 intersection in Minnesota. The addition of the DIIs to the surveillance system would provide a collision avoidance system with a realistic total cost of under \$200 K. This would make the CICAS-SSA system competitive with signalized intersections and provide traffic engineers with another tool to reduce intersection crashes.

Chapter 1

Introduction

Motivation

More than 30% of all vehicle crashes in the U.S. occur at intersections; these crashes result in nearly 9000 annual fatalities, or approximately 25% of all traffic fatalities. Moreover, these crashes lead to approximately 1.5 M injuries/year, accounting for approximately 50% of all traffic injuries.

In rural Minnesota, approximately one-third of all crashes occur at intersections. AASHTO recognized the significance of rural intersection crashes in its 1998 Strategic Highway Safety Plan [1] and identified the development and use of new technologies as a key initiative to address the problem of intersection crashes in [2], Objective 17.1.4: “Assist drivers in judging gap sizes at Unsignalized Intersections.”

To clearly define the rural intersection crash problem, an extensive review of both the Minnesota Crash Database and research reports quantifying the national problem was undertaken; the results are documented in [3]. This study of 3,700 Minnesota intersections shows that crashes at rural four lane expressway thru-stop intersections have similar crash and severity rates when compared to all rural thru-stop intersections. However, right angle crashes (which are most often related to gap selection) were observed to account for 36 percent of all crashes at the rural four lane expressway intersections. At rural four lane expressway intersections that have higher than expected crash rates, approximately 50 percent of the crashes are right angle crashes. Further investigation also found that drivers’ inability to recognize the intersection, and consequently run the “Stop” sign, was cause for only a small fraction of right angle crashes. *Gap selection is the predominant problem.*

This is consistent with other findings; Chovan et al. [4] found that the primary causal factors for drivers who stopped before entering the intersection were:

1. The driver looked but did not see the other vehicle (62.1 %)
2. The driver misjudged the gap size or velocity of the approaching vehicles (19.6 %),
3. The driver had an obstructed view (14.0 %), or
4. The roads were ice-covered (4.4 %).

Of these four driver errors, the first three can be described as either problems with gap detection or gap selection.

Crash analyses, including field visits and crash database reviews, for Michigan [5] North Carolina [6] and Wisconsin [7] have shown that in these states, poor gap acceptance on the part of the driver is the primary causal factor in approximately 60% of rural thru-Stop, right-angle intersection crashes.

Prior to CICAS-SSA, and its predecessor IDS, high rural intersection crash rates were addressed through the use of either a traffic control device or increased conspicuity of the intersection

itself. Improvements in conspicuity include additional and/or larger “Stop” signs, flashers, improved pavement markings, etc. However, neither of these approaches fully addresses the rural intersection crash problems. The addition of traffic control devices typically results in an exchange of right angle crashes (between major and minor road vehicles) for rear-end crashes (between vehicles on the major road). Improvements in intersection conspicuity failed to make an improvement in crash rates because conspicuity was never the problem. These two approaches represent the tools available to the traffic engineer to address the problem. Clearly, these two tools are insufficient to address the problem.

In order to improve rural intersection safety, new approaches are required. Responding to this need, CICAS-SSA is the manifestation of a technology-based approach to improving rural intersection safety. As was borne out in [3], the primary issue with rural four lane expressway thru-stop intersections exhibiting higher than expected crash rates is the poor *rejection* of unsafe gaps or gaps in traffic. Although often described as a gap acceptance program, the ultimate goal of the CICAS-SSA program is the assistance of drivers who may accept an unsafe gap. By providing assistance in the identification and rejection of unsafe gaps, rural intersection safety can be improved, while at the same time maintaining vehicular throughput on the major road. Safety improves without a capacity penalty.

Another goal of the CICAS-SSA program is to develop a system with a realistic probability of being deployed. This means that not only must the system help reduce intersection crashes, it must also be affordable so that state and local government agencies will install it at problematic intersections. This goal is the reason for this report, which is to analyze the minimal possible configuration of the system in order to reduce cost and complexity. The work herein describes the optimization of the surveillance system based on prior research and the current state of vehicle detection sensing.

CICAS-SSA Surveillance System

The CICAS-SSA system consists of two main subsystems; surveillance and warning. This report focuses on the surveillance system, which consists of networked vehicle detection sensors and a central processor at an intersection (Figure 1). The surveillance system is responsible for detecting all vehicles entering the region of detection and calculating the state of each vehicle in a timely and accurate manner. It determines the time to intersection of every vehicle on the major road and feeds this data to the computation subsystem in order to produce timely warnings to drivers.

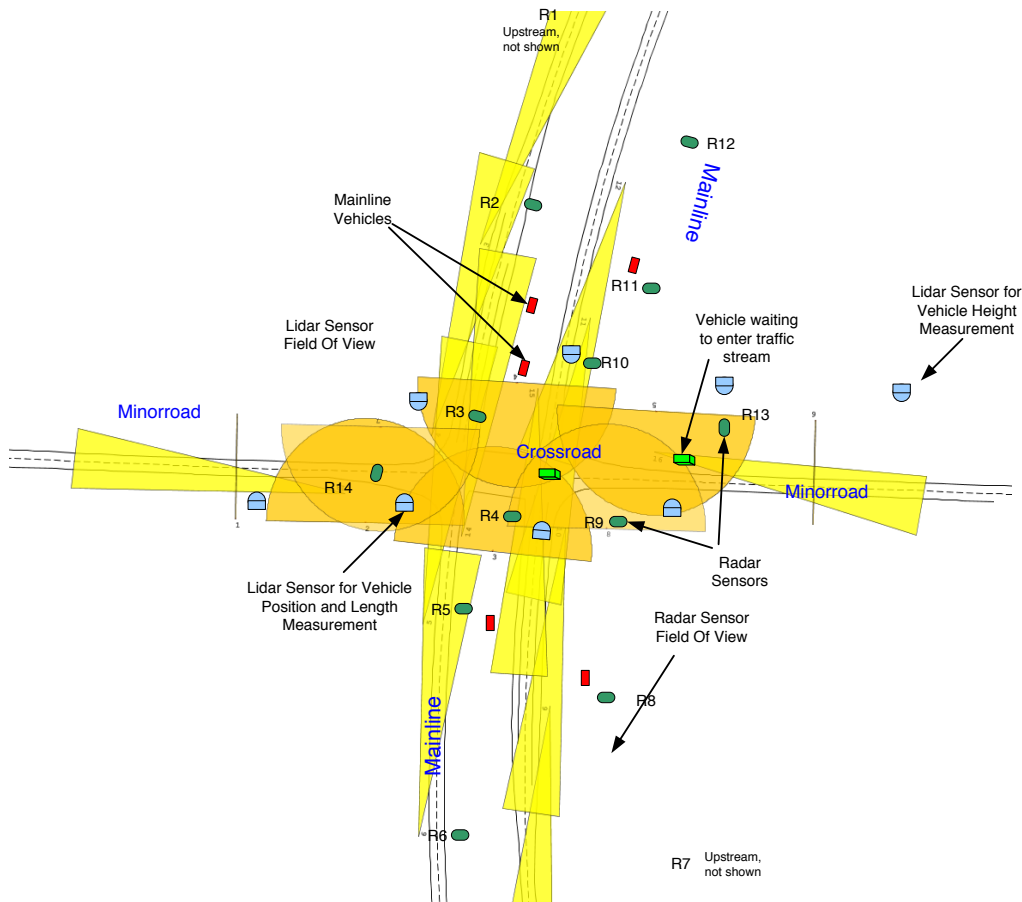

Figure 1: Plan view of a typical instrumented rural four lane expressway intersection. Sensors are radar (yellow triangles indicate field of view and) scanning lidar (orange semicircles); all data is sent from sensor processors to the main central processor.

The surveillance system consists of three subsystems; mainline, minor road and median. The mainline subsystem, as the name suggests, is responsible for the sensing of vehicles entering the intersection from the mainline road. The minor road subsystem monitors the minor road area for vehicles while the median subsystem detects vehicles in the median. The three subsystems provide vehicle state data (position, speed, lane of travel) to the central processor which merges, filters, and estimates the gaps and lags within the intersection region of interest.

When the project commenced, it was assumed that vehicle detection was necessary in the minor road and median areas. This is because it was assumed drivers of different age, gender and vehicle type would accept/reject different gaps. However, analysis of macroscopic and microscopic data revealed that the rejected gap behavior of drivers was insensitive to vehicle class, driver age and driver gender [8]. This work revealed that a CICAS-SSA system did not need to tailor the warning algorithm to different drivers and a generic timing algorithm is sufficient. This is a beneficial finding from a cost perspective as the elimination of the minor road and median subsystems allows a significant reduction in complexity and cost. Thus, this report will focus on optimization of the major road surveillance subsystem. The minor and median road subsystems will be discussed in a separate chapter when the analysis of CICAS-SSA power consumption trade-off is discussed.

The surveillance system is responsible for determining the state of the intersection in terms of gaps and lags. The mainline sensor system computes the position and speed of each vehicle within its coverage zone. The mainline vehicle state information is fed into the computation subsystem which computes the lags/gaps and determines if the instantaneous lag/gap is too small for safe entry. When unsafe conditions are detected, the driver is warned via a Driver Infrastructure Interface (DII) or by a in-vehicle interface.

Requirements of CICAS-SSA Sensors

Each surveillance subsystem has its own unique requirements. Thus, the sensor requirements are segregated based upon in which subsystem they will be employed. Even though minor road and median subsystems are not strictly required in a CICAS-SSA implementation, it is important to discuss their requirements for potential cost trade-offs discussed in a later chapter. What follows is a list of data requirements for each surveillance subsystem.

1. Mainline sensor data. The mainline sensor suite must provide vehicle trajectory data as specified below
 - a. Raw data: Vehicle speed, position,
 - i. Speed accuracy: +/- 0.5 MPH
 - ii. Position accuracy: +/- 15 feet longitudinal, +/- 3 feet lateral
 - b. Minimum coverage range
 - i. 12 seconds at 10 MPH over posted speed limit
 - c. Data rate: 10 Hz
 - d. Detection rate: > 99.99% per direction of travel per sensor within the sensor coverage range. (Multiple sensors drastically reduce the frequency with which a vehicle is not detected and tracked.)
2. Median sensor data.
 - a. Presence of vehicles in the median so that DII messages are consistent with presence of vehicles in the median.
 - b. Data rate: 10 Hz
 - c. Detection rate: 97%
3. Minor road sensor data
 - a. Presence of vehicles on the minor road so that DII messages are consistent with presence of vehicles in the minor road (some intersection geometries support right turn lanes for the minor road).
 - b. Data rate: 10 Hz
 - c. Detection rate: 97 %

Cost Consideration

The most important requirement of a candidate CICAS-SSA sensor is that it dependably meets the technical requirements. However, cost has to be a major consideration because if the whole system cost is high, deployment becomes more unlikely. The CICAS-SSA system was designed to be an alternative to current intersection safety solutions such as building interchanges and

installing conventional signals. The goal is that the deployable CICAS-SSA system be less costly than either alternative.

In order to normalize cost, a cost per lane meter metric has been employed. The cost per lane meter is cost divided by the length of lanes covered by one sensor. For example, an inductive loop detector can cover approximately 1 meter of lane, so the cost per lane meter is simply the cost to deploy the loop and required hardware. For other range sensors, the lane length is the sum of the length that the sensor's region of detection covers for each lane (Lane1 Coverage + Lane2 Coverage in Figure 2). This cost definition allows direct comparison of different sensor modality costs.

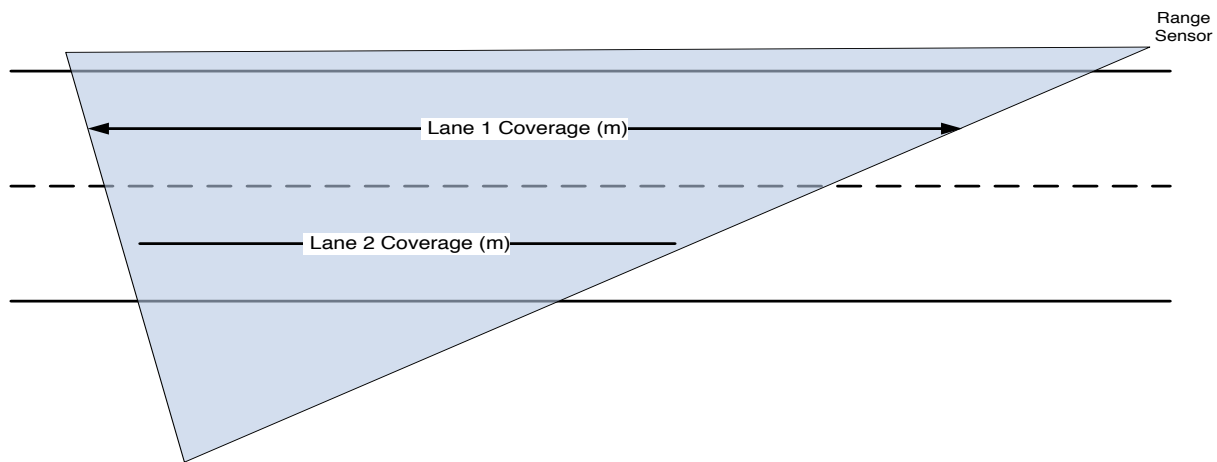

Figure 2: Diagram showing definition of lane coverage for a CICAS-SSA range sensor

Intrusive vs. Nonintrusive Sensing

Intrusive sensing for the purposes of this report is defined as sensors that make physical contact with the road. Nonintrusive sensing is defined as sensors that do not need to have physical contact with the road in order to sense vehicles. Traditional in-road vehicle sensing has been intrusive, for example, inductive loops and piezoelectric strips. While intrusive sensors will be considered for the CICAS-SSA system, their short range, durability and installation cost makes them less desirable in a CICAS-SSA application. Therefore, most of the focus of this report will be given to nonintrusive sensing.

Continuous vs. Point Sensing

The CICAS-SSA computation system requires that the target vehicles be sensed in a continuous manner. This is due to the dynamic nature of vehicles. Acceleration and deceleration cause significant changes in the time to intersection calculation, and therefore, continuous tracking is needed in the region of interest of the CICAS-SSA system. This makes point sensors like inductive loops, piezoelectric strips and single laser beam detection less desirable. Numerous single point detection sensors would be needed to continuously track vehicle in the region of

interest. Therefore, more emphasis will be given to sensors that provide a range of detection, lowering the cost per area of coverage.

Mounting Requirements

Some noncontact sensors require an overhead mounting while others require roadside mounting. The overhead mount location incurs greater cost than roadside mounting locations. This is due to the material and installation cost of the gantry. Roadside sensors with low mounting height requirements allow the use of inexpensive posts. Thus, the low height roadside mounting location is preferable for a CICAS-SSA system.

Power Considerations

Cost and safety are important considerations for a candidate CICAS-SSA sensor. After installation, energy cost is incurred and is usually the responsibility of the local DOT. Conversations with local DOT employees have indicated that electricity cost is a big part of their budget and is of concern. It is important that the CICAS-SSA system be as energy efficient as possible to lower the burden on the local DOT budget. Also, in general, it is preferable to use low voltage equipment close to the roadways. Fortunately, most of the sensors that meet the requirements for a CICAS-SSA system are low voltage (less than 13V).

Chapter 2

Vehicle Sensing Technologies

There are numerous types of vehicle sensors on the market. Candidate sensors have sensing strengths and limitations that are related by sensing modality. Each pertinent sensing modality was explored and the most promising sensors for a CICAS-SSA surveillance system were determined. The survey of off the shelf roadside vehicle sensors contained in this report is by no means complete. The intent of this technology scan is to provide a list of vehicle sensors that are possible candidates for a CICAS-SSA system then explain why the sensors should or should not be considered for testing. The previously listed requirements were used to guide the decision whether to consider a vehicle sensor as a candidate for the CICAS-SSA system. There are many off the shelf “traffic” detectors that do not match well with the CICAS-SSA requirements because they are designed for traffic flow applications. Thus, they are usually oriented perpendicular to the road, have a small region of coverage, relatively poor speed measurement accuracy, and often times do not provide low latency real time data. CICAS-SSA surveillance system requires continuous coverage over a long range, very accurate position and speed measurements, and low latency real time data. Automotive sensors do a better job of this as they are designed for real time collision warning/avoidance with a fast moving vehicle. Given the dynamic nature of their operation they tend to have long range, fast update rates, and very accurate range and speed measurements. For these reasons, more automotive vehicle sensors made the short list than roadside traffic sensors.

Inductive Loops

Inductive loops are a very popular form of vehicle detection. Inductive loops are installed in the road by sawing a rectangular pattern in the middle of a lane. The loop is connected to a roadside signal processor that detects inductance changes due to passing vehicles. Standard loop detectors provide only presence detection, but new more advanced loop systems provide axle count classification and speed measurements.

For example, the Idris advanced loop technology can provide the number of axles, vehicle type, speed and direction of vehicle movement in all traffic conditions. Quixote Traffic Corporation sells an advanced loop system called the ADR-6000. It employs the Idris loop technology and provides axle classification and speed. The Texas Transportation Institute at the Texas A&M University tested the ADR-6000 and reported the speed accuracy to be within 2 mph 99 percent of the time. They reported a classification error rate of 15 out of 1923 vehicles (0.8%) [9].



Picture 1: Picture of the ADR600 signal processor

Inductive loop technology is not well suited for a mainline CICAS-SSA sensor because of the small coverage range. A loop based mainline surveillance system would require many loops and the cost per lane meter is high. The cost of a double set (four loops) with controller and power is between \$3000 and \$8000, which is \$1500/m - \$4000/m of lane coverage (two loops per lane required for speed) [2].

Inductive loops may be applicable to the minor road if vehicle presence detection is required on the minor road. Also, if presence detection is required in the median, loops can be considered.

Vision

Vision vehicle detection systems use cameras and video processing algorithms to extract vehicle presence, speed and classification. The cameras can be mounted overhead or in a side fire configuration. Vision systems can cover multiple lanes of traffic with one camera and can simultaneously detect vehicles in multiple lanes.

Vision systems are a popular choice for arterial monitoring and many companies produce numerous products. Among them, the Autoscope Solo manufactured by Image Sensing Systems, Inc. is one of the most popular. In a 2002 report, Mn/DOT reported the test results of the Autoscope in both an overhead and side fire configuration. They reported that the traffic volume error was less than 3% while the speed error was near 6% for the two closest lanes [11].



Picture 2: Picture of the Autoscope Solo camera

While vision is robust in good lighting conditions, performance degrades in poor lighting conditions such as fog, rain and snow. Since an CICAS-SSA sensor must operate in all weather conditions and climates, vision is not an ideal CICAS-SSA sensor modality. In addition, the field of view of the vision system is generally small. There are numerous variables affecting the field of view of a vision detection system. Mounting height and distance from road, camera lens, image capture resolution and sensitivity, lighting, and image processing techniques all affect the effective coverage of a vision system. These will all vary per manufacturer and per installation. Mounting higher will increase the camera's field of view, but also increase the cost of installation. The effect on the cost per lane metric is complex and highly dependent on the variables of a particular installation. For a typical example, the cameras at the test intersection of US 52 and Goodhue County Road 9 have a six millimeter lens and a 1/3 inch CCD area and are mounted on 22 foot masts. They provide a field of view on the order of 10 meters in each lane. The cost of Autoscope is in the \$6K range, which results in cost per lane meter of approximately \$300/m for a two lane road. This does not include installation of a mast. The cost makes vision systems impractical for the mainline surveillance subsystem. If minor road or median detection is necessary, vision may be considered because only one system per leg should be needed. Also, detection in the median may be possible without the need for boring under the road.

Passive Acoustic

Passive acoustic sensors detect the acoustic signals motor vehicles create and radiate during operation. This sensor type is able to measure the presence, speed and classification of vehicles passing by using the sound wave patterns. Since the sensor is passive, it requires very little power. It is also relatively insensitive to weather conditions. Passive acoustic sensors generally are mounted road side, up high on a pole

The SAS-1 passive acoustic sensor from SmarTek is a popular sensor for roadway monitoring. It measures the presence, speed (down to 1.5 mph) and a three bin classification of vehicles in up to 5 lanes of traffic. The sensor must be installed on a mast next to the roadway, at least 20 ft above the road (<http://smarteksys.com/specs.htm>).

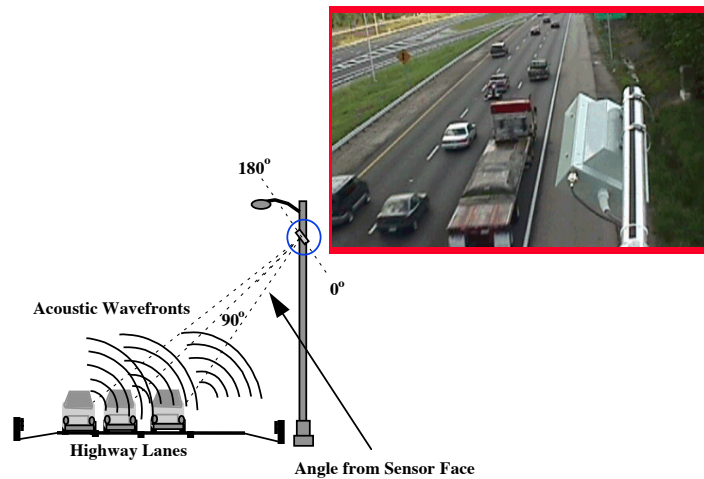

Figure 3: The SAS-1 sensor mounted in a side fire configuration can detect multiple lanes

The field of view is not stated, but the sensor is a replacement for pneumatic tubes or inductive loops, effectively operating as a point sensor. The cost of the SAS-1 is around \$3,500, not including the mast. Assuming a coverage area similar to a loop detector, the cost per lane meter is \$1750 for a two lane road. The short range field of view make the sensor less desirable for mainline sensing, but could be potentially used on the minor road or median if sensing there is desired.

Passive Infrared

Passive infrared sensors detect temperature differences between the pavement and the vehicle. They provide presence, speed and length of vehicles in multiple lanes. The detectors can operate in all conditions including heavy traffic and congestion. They are usually mounted either overhead or on the side of the road.

The ASIM series of passive infrared sensors measure vehicle length and the average speed of traffic. The IR 254 can be mounted over the road on a gantry or on the side of a road on a mast. It must be mounted between four and ten meters above the road. The field of view is limited and the sensor is designed to be a replacement for loop detectors. The sensor is only \$700 and assuming a loop like detection range of one meter, the cost per lane meter is \$350/m. This does not include the mast which would substantially increase the price. Passive infrared sensors are not ideal for the mainline surveillance system due to the small area of coverage. They could be used on the minor road if sensing there is desired.



Picture 3: ASIM IR 250 series passive infrared sensor

Laser

Laser based vehicle detection sensors emit pulses of light and measure the time it takes for the light to reflect off objects and return to the sensor. Using the known speed of light they measure a distance to the reflected object. The laser pulses are usually on a rotating platform which allows them to fan out from the sensor, creating a plane of distance measurements. More recently, multiple plane sensors have been introduced that provide a 3 dimensional map of the distance to objects surrounding the sensor.

Laser sensors provide very accurate range measurements but do not directly measure speed or length. Object processing algorithms can be used to calculate tracked objects' speed and vehicle classification. Laser scanners can be affected by poor weather conditions as the light can scatter off of rain drops and snowflakes.

OSI Autosense

OSI Laserscan makes the Autosense series of scanning laser vehicle detection sensors. The Autosense measures vehicle presence, speed and classification. Most models are designed to work in an overhead mounting position, although the 700 model can be used in a side fire position. Further inquiries into the 700 model revealed that it is designed for a toll application in which barriers provide a highly controlled environment. The sensor gets good reviews for its vehicle classification accuracy. However, due to the lack of a multi lane side mounted capability, the Autosense does not meet the CICAS-SSA surveillance system requirements.

SICK LMS221

The LMS221 is a 180 degree scanning laser sensor with a user selectable resolution of 0.25 – 1 degree. The maximum range is 80m for a highly reflective object and drops to 30m for a 10% reflective object. The range accuracy is 15mm. The sensor does not provide speed or vehicle classification. This can be calculated by clustering and tracking algorithms running on a computer. The nine kilogram sensor can be mounted on the side of the road at approximately bumper height, allowing standard U-channel to be used as a mounting post.

The cost of the LMS221 is \$7K, not including installation costs. The cost per lane meter is \$58/m for a two lane road. For 12 seconds of coverage the surveillance system would need 360 m of coverage on each leg for a vehicle traveling 30 m/s. This would require twelve sensors to cover the entire mainline region, costing \$84K in sensor costs alone. Additional costs would be incurred for the computers needed to process the scans and for the mounting mast and hardware. The LM221 would appear to be too costly for a mainline surveillance sensor. It is a candidate

for a minor road sensor because one sensor could track and classify on each minor road approach. It also could be used for median presence detection should it be desired.

The University of Minnesota has been using the LM221 at its CICAS-SSA test site at the intersection of US 52 and Goodhue County 9. The sensor has been used on the minor road approach to classify and track vehicles entering the mainline. It has thus far met the accuracy and reliability requirements for a CICAS-SSA minor road sensor.



Picture 4: Picture of the Sick LMS221

Ibeo Lux

Ibeo is a German company that is 90% owned by SICK. They make laser scanners for vehicle applications. Their newest sensor, the Lux, has a 100 degree field of view with a 200 m maximum range. The scan resolution ranges from 0.1 – 0.5 degree based on the user configuration settings. The Lux has four planes of scans that form a vertical field of view of 3.2 degrees. It also has a multi echo capability that allows it to be more robust to poor weather conditions.



Picture 5: Picture of Ibeo Lux. The sensor is small, H85 x W128 X D83mm

The Lux does all object processing internally. It provides tracked object information like position, speed, relative speed and vehicle classification. It provides this information at a rate of 12.5 Hz to 50 Hz based on the configuration settings.

Production of the Lux is scheduled for fall 2008 and is listed at 10 K Euros or approximately \$15K. That would provide a lane coverage cost of \$37.5/m. However, Ibeo states that the sensor was designed to be low cost in order to encourage adaptation by the automotive industry. Cost volume price projections provided by Ibeo indicate that with economies of scale that the Lux's price will drop to 380 Euros by 2010 and below 200 Euros with high sales volume (Figure 4). This would lower the lane coverage cost to \$1.5/m, making it an extremely low cost sensor.

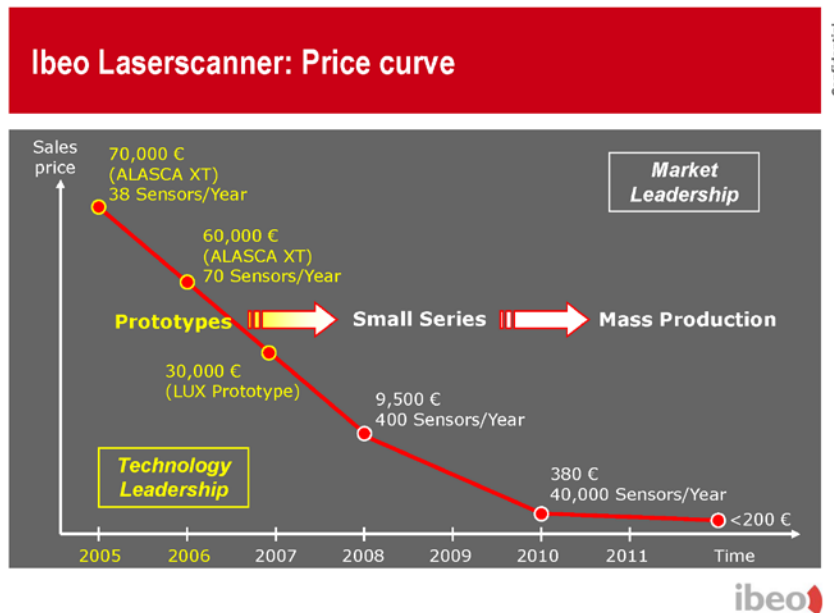

Figure 4: Ibeo laserscanner price-volume-time curve

The Lux would have to be evaluated in a roadside situation, especially in poor weather, to determine whether the listed specifications are met. The University of Minnesota has obtained the predecessor of the Lux, the Alasca. The Alasca has similar specifications as the Lux, except for a wider field of view of 150 degrees. Two sensors were obtained in fall 2007 and have been installed at the Hwy 52 test intersection. They are located in the median, sensing vehicle making maneuvers from the median. The sensor has performed well and meets the requirement of the minor road. The University of Minnesota plan to acquire the Lux in late 2008. At that time it will be evaluated for its suitability on the mainline. If it meets the mainline requirements and the sale volume increases as Ibeo projects, the Lux would be a very strong candidate for an CICAS-SSA mainline sensor. It also is a strong candidate for the minor road and median zone sensing since it classifies vehicles and has a long range.

Radar

Radar based vehicle detection sensors emit radio waves (usually between 1-100 GHz) and measure the frequency shift of the returning waves that have bounced off of moving objects. Two categories of vehicle detecting radar exist: roadside and vehicle mounted. The roadside radar is designed to be a noncontact replacement for loop detectors. Automobile radar is designed to detect vehicle for in-vehicle safety systems. While intended to be employed in a vehicle collision warning/avoidance system, the University of Minnesota has tested automotive radar in a road side configuration and found that the sensor works well in this configuration.

Delphi ACC3

The Delphi ACC3 radar operates at 77GHz and has been in production since 2004. It provides range, range rate and azimuth angle to multiple targets at 10Hz. It has a range of 150m, a 15 degree field of view, and a range rate accuracy of +/-0.5 m/s.

The sensor costs \$2K which is a lane coverage cost of \$10.60 for a two lane road. The unit needs to be mounted at bumper height, so inexpensive U-channel can be used as a mast. Since the specifications meet the requirements for an CICAS-SSA mainline sensor and the cost is reasonable, the ACC3 is a candidate for a mainline surveillance system. The sensor would not be suitable for the minor road or median subsystems because it does not provide vehicle classification and Doppler radar cannot detect very slow moving or stopped vehicles.

The University of Minnesota has acquired the ACC3 in order to test its performance as a roadside CICAS-SSA sensor at the Hwy 52 test intersection site.



Picture 6: Picture of the Delphi ACC3 radar

Eaton VS-400

Eaton Vorad's EVT-300 is a popular vehicle based radar that operates in the 24GHz K-band. The EVT-300 meets all mainline sensing requirements and thus the University of Minnesota chose it as the sensor with which to implement the mainline surveillance system at the US Hwy 52 and County Road 9 intersection. Unfortunately, production of the EVT-300 has stopped. Eaton has released a new radar, VS-400, that operates at 77GHz and has a range of 500 ft (152 m). It provides range, range rate and azimuth to up to 20 targets simultaneously. Eaton is working with the University of Minnesota to provide custom software for the roadside application. The software will be ready in fall 2008, at which time the new radar will be tested at the Hwy 52 test intersection.



Picture 7: Picture of VS-400 radar

Wavetronix SmartSensor HD

The SmartSensor HD by Wavetronix is designed as a roadside vehicle detector that can replace loop detectors. It measures the volume, speed, headway, gap, presence and classification of up to 10 traffic lanes simultaneously. The radar operates in the 24GHz K-band and has a range of up to 76.2m. The sensor must be mounted up high on a mast looking down and perpendicular to traffic.



Picture 8: Picture of Wavetronix radar

The sensor costs \$5K and is designed to operate in a side fire orientation, providing a small region of coverage and accordingly small lane coverage. It is a candidate for minor road and median sensing as it provides vehicle classification as well as presence detection.

Smartmicro UMRR

The German company Smartmicro makes customizable radar sensors. Their newest line, the UMRR, is user configurable and operates in the 24GHz K-band frequency. It provides range, range rate and azimuth to multiple targets. In a long range configuration, the maximum range is 240 m with an azimuth angle of +/- 20 degrees. The sensor cost is \$5000, which provides a lane coverage of cost of \$11.40 for a two lane road. Because of its long range and large azimuth, the sensor is ideal for the mainline. If the specifications prove accurate, the UMRR radar is a serious candidate for an intersection surveillance system. The University of Minnesota plans to acquire a long range UMRR and test it at the intersection of US Hwy 52 and County 9 in early 2009.



Picture 9: Picture of Smartmicro UMRR radar

Candidates

A scan of the current available off the shelf vehicle sensors revealed that automotive sensors most meet the needs of a CICAS-SSA surveillance system. This is due to their long range and roadside mounting position. The Eaton Vorad VS-400 and the Delphi ACC3 are the 77 GHz radar that are candidates for the mainline. The Smartmicro 24 GHz radar and the Ibeo Lux laser scanner will also be considered. All meet the requirements of long range, non-contact, continuous sensing with an update rate of 10 Hz or greater.

Chapter 3

Minimal Sensor Configuration for the Mainline Surveillance System

In the previous chapters, the requirements and candidate sensors were determined for the CICAS-SSA surveillance system. The analysis was performed at an individual sensor level. In this chapter the analysis is expanded to include the surveillance system as a whole; networked sensors and computation subsystem. The optimum minimal sensor configurations will be established for four lane rural four lane expressway thru-stop intersections and two lane rural two lane highway thru-stop intersections for each of the candidate CICAS target sensors.

Minimal Requirements for Surveillance System

The requirements for the surveillance system as a whole are determined by the DII and the warning timing algorithm. The DII has two states, one for alert and one for warning. The timing algorithm sets the alert to trigger at 11 seconds and the warning to trigger at 7.5 seconds [8]. Thus, the mainline surveillance system must have a region of detection greater than 11 seconds. The requirement for the minimum time to intersection coverage is 12 seconds to accommodate target acquisition delay and variances in maximum detection range. The time headway (t_h) is related to the distance to the intersection (d_{ti}) and the speed (v) of the vehicle by $t_h = d_{ti}/v$. To accommodate those who violate the maximum speed posting, the maximum speed is assumed to be ten mph greater than the speed limit. This defines the minimum coverage range of the surveillance system at each major leg (Table 3). It is the distance at which it would take a vehicle traveling at a constant ten miles per hour above the posted speed limit, 12 seconds to reach the intersection. The major road surveillance subsystem must have a tracking region sufficiently large to cover this distance from the intersection.

Table 3: Distance requirement of the surveillance system assuming speed of 10 mph above speed limit

Speed Limit		Assumed Maximum Speed		Time To Intersection	Distance To Intersection	
MPH	m/s	MPH	m/s	Sec	Feet	Meters
70	31.3	80	35.8	12	1408	429
65	29.1	75	33.5	12	1320	402
60	26.8	70	31.3	12	1232	376
55	24.6	65	29.1	12	1144	349
45	20.1	55	24.6	12	968	295

In addition to a minimal coverage range, the major leg surveillance system must provide continuous coverage within the region of interest all the way to the intersection. There can be small ‘holes’ in coverage as long as the tracking algorithm reliably estimates in between the gaps in coverage. Coverage gaps are more tolerable further away from the intersection as vehicles tend to maintain a relatively constant speed. Closer to the intersection turning vehicles reduce

their speed before entering the turn pockets. The coverage needs to be continuous in this region because decelerating vehicles are decreasing their speed and increasing the time gap (speed is in the denominator of time gap equation). Conversely, an accelerating vehicle will have a quickly decreasing time gap. Figure 5 shows that range of speed for vehicles traveling straight through the intersection on mainline of US 52 and 9. The range of speed is simply the maximum speed minus the minimum speed measured while the vehicle was on the mainline before crossing the intersection. Vehicles traveling straight through the intersection have some variance in speed as seen in Figure 5. While a majority of vehicles maintained a steady speed, some vehicles changed their speed up to 10 m/s. This supports the premise that continuous sensing is required even for vehicles going straight.

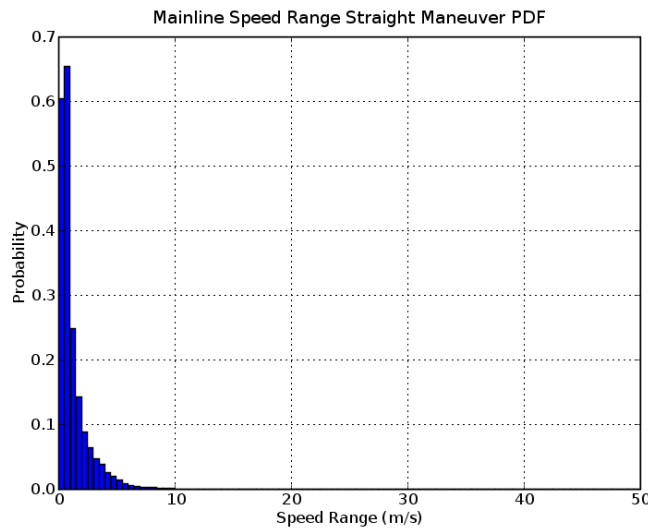

Figure 5: Probability Density Function of the range of speed of vehicles traveling on the mainline (US 52) that went straight through the intersection

Construction Costs

A major component CICAS-SSA cost is in the construction of the surveillance system. The main cost drivers are the trenching and boring for the data and power lines. Estimating these costs can be difficult when no previous similar effort has been undertaken; however, a surveillance system has already been constructed at Hwy 52 and County Road 9 near Cannon Falls Minnesota.

The University of Minnesota contracted with Shane Electric Company in the Spring of 2004. The design of the intersection was not optimized because the knowledge on how to design a novel surveillance system was limited and the surveillance system was designed to be a working intersection collision avoidance laboratory. Another difference in the design was necessitated by the unknown reliability of the hardware, some of which had never been used in this type of application. For this reason, a ring network topology was chosen (Figure 6). This networking scheme improves robustness against single point failures, but increases cost because it significantly increases cable run distance.

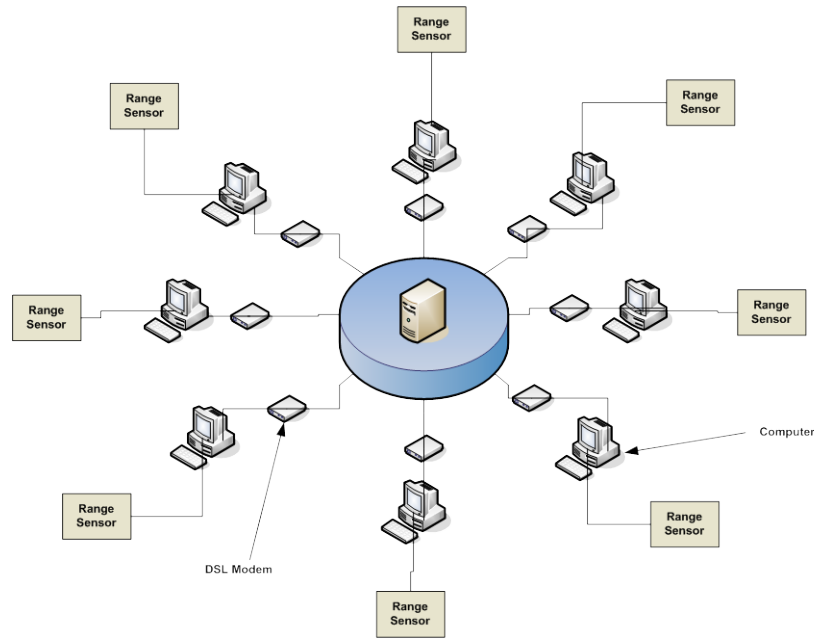

Figure 6: Network topology of Hwy 52 intersection. A star topology was chosen for robustness. DSL modems facilitated long range network connection between central server and computer stations.

For an optimized minimal sensor set surveillance system, a simpler network topology would reduce cost. A more linear, daisy chain, network topology was chosen for the minimal surveillance system because of the reduction in construction costs and the fact that real hardware tested at the Hwy 52 intersection proved extremely reliable (Figure 7). While more susceptible to point failure, the daisy chain approach offers similar system failure modes when compared with the ring topology because of the vastly reduced sensor overlap. The sensor layout will be described in more detail in the following sections of this chapter. It is sufficient here to understand that the spacing between sensors was increased for cost optimization so that a point failure would cause significant reduction in performance, regardless of the network topology. Fortunately, all failure modes can be remotely detected for service requests and that reliable hardware greatly reduces time between failures.

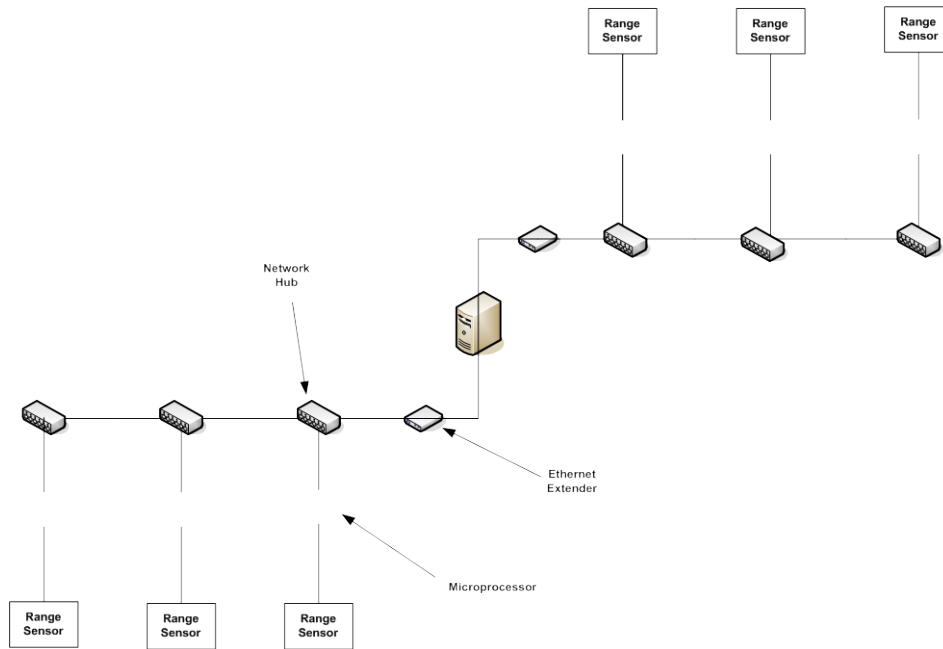

Figure 7: Minimal sensor surveillance system network topology. Daisy chained to reduce construction costs. Ethernet extenders (long distance) and Ethernet hubs (short distance) are employed for network connectivity to the central server. Microprocessors are used to interface with range sensor hardware.

Construction costs can be normalized so that the new sensor layout and network topology costs can be calculated. Based on actual costs from Shane Electric Company, the construction costs for boring, trenching, installing posts and sensor cabinets have been established (Table 4). Also, the equipment installed in each sensor cabinet has been priced in Table 5. Both of these tables will be used to construct a cost for each minimal sensor layout that follows.

Table 4: Actual construction costs for Hwy 52 intersection build provided by Shane Electric Co.

CONSTRUCTION COSTS			
	Cost Per Foot	Cost per Unit	
BORING			
2" Boring			
Boring costs	\$	9.00	
Conduit	\$	0.75	
Labor (Estimate)	\$	2.00	
Ethernet cable	\$	0.25	
3" Boring			
Boring costs	\$	10.00	
Conduit	\$	2.25	
Labor (Estimate)	\$	2.00	
Ethernet cable	\$	0.25	
TRENCHING			
Plowing	\$	3.00	
Labour	\$	2.00	
2" Conduit	\$	0.75	
3" Conduit	\$	2.25	
SENSOR STATION			
PVC Couplings	\$	20.00	
Circuit Breaker	\$	120.00	
Misc Hardware	\$	20.00	
Labor (Estimate)	\$	200.00	
Posts + Labor	\$	150.00	
		\$	510.00
U-Channel			
Material + Labor	\$	50.00	
Notes:	A 2" conduit is sufficient for our needs. Separate conduits will be used for power and data		

Table 5: Costs for equipment installed at each sensor station

Sensor Station Costs

Part		Cost
NEMA Enclosure	\$	200
Ethernet Extenders	\$	600
Ethernet Switch	\$	100
Microprocessor	\$	150
Power Supply	\$	100
	\$	1,150

Minimal Sensor Set Using Eaton VS-400 or Delphi ACC3 77 GHz Radar

The Eaton Vorad VS-400 and the Delphi ACC3 radar are candidates for the mainline surveillance system. They are both automotive radar operating at 77 GHz and have very similar specifications. The VS-400 is already in production but is not yet available to the University. The University has been working with Eaton and they have agreed to provide custom software for the intersection application. Estimates for the availability of the sensor with custom software in fall 2008 have been given. The University of Minnesota plans to obtain and test a VS-400 at the Hwy 52 test intersection.

The Delphi ACC3 has been in production for several years. The IV Lab has an ACC3 and have done preliminary tests at the Hwy 52 intersection. A full evaluation will occur simultaneously with the VS-400 so that the sensors can be compared under the same conditions.

Given that the sensors have almost identical specifications, an optimized minimal sensor layout was constructed using the specifications provided by the companies. Figure 8 shows an in-scale sensor layout that provides 12.9 seconds of coverage for a 65 mph speed limit rural two lane highway. The yellow triangles represent the radar sensor field of view based on the provided specifications. Note that the 12.9 seconds of coverage assumes a vehicle speed of 75 mph, as designated by the system requirements (10 mph greater than the speed limit). The minimal sensor set consists of six radar, three for each mainline leg. The gaps in coverage are minimal and are in areas where mainline traffic is likely to be flowing at a consistent speed. The critical area before both the right and left turn lane has continuous coverage.

Figure 9 shows the proposed hardware layout showing the cable runs and all the sensor stations and central cabinet. Three bores under the road would be required and two of the sensor stations are located in the median. The DIIs are not shown but they would be mounted close to power in the median as well as roadside.



Figure 8: Minimal sensor suite layout required for mainline surveillance system on rural four lane expressway thru-stop intersections using specifications for Delphi ACC3/Eaton VS-400 radar

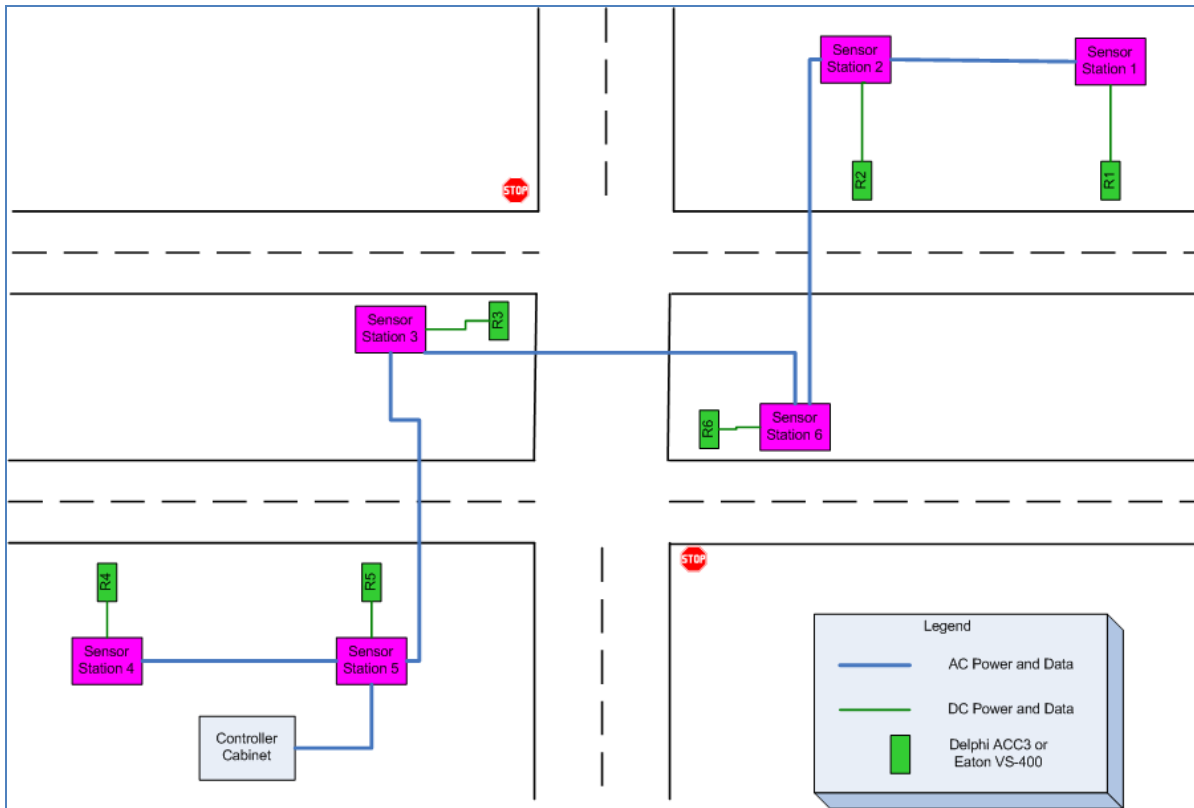

Figure 9: Proposed minimal sensor surveillance system hardware layout for rural four lane expressway thru-stop intersections with Delphi ACC3/Eaton VS-400 radar

Based on the sensor layout in Figure 8 and the hardware layout in Figure 9, cost estimates were determined using distances measured on the sensor layout. Based on the number of sensors and sensor stations, the distance to be bored and trenched, and central processor costs, the total estimated cost to install a mainline surveillance system using VS-400/ACC3 sensors is \$65 K. The cost assumes that the VS-400 and ACC3 is \$2000, which is based on a quote from Eaton and the actual cost for the Delphi. For the VS-400, the cost decreases to \$1200 with sufficient volume. It should be noted that all costs given in this report represent low volume orders unless otherwise stated. The total cost can be reduced further as economies of scale reduce the component costs as CICAS-SSA is deployed to many intersections.

Table 6: Minimal Surveillance System Costs for 77 GHz radar installed at rural four lane expressway thru-stop intersections

Surveillance System Costs for VS-400/ACC3

Construction	Cost per unit	Units	Cost
Boring	12	420 \$	5,040
Trenching	5.75	4000 \$	23,000
Sensor Station	1660	6 \$	9,960
Mounting	160	6 \$	960
Central Processor	13500	1 \$	13,500
Sensor	2000	6 \$	12,000
Total			\$ 64,460

The rural 2 lane highway thru-stop intersection provides the opportunity to further reduce the complexity and cost of a CICAS-SSA surveillance system. This is due to the lower speed limit (generally 55 mph) and the reduced area needed to be monitored. In the Intersection Pooled Fund project, a portable surveillance system was taken to the states of Wisconsin, Michigan, Iowa, North Carolina, Georgia, Nevada and California. The Michigan intersection near Grand Rapids is a two lane rural two lane highway and its geometry was used to design the minimal sensor configuration. Figure 10 shows the sensor layout and field of coverage using the Eaton VS-400 or the Delphi ACC3 radar. The mainline surveillance system achieves 12 seconds of coverage for a vehicle traveling 65 mph. Note that a reduction of two sensors was achieved due to the lower speed limit and the moving of the radar in the median to the corner of the intersection. There is a gap in coverage between the two radar in each leg. Previous research conducted at the Hwy 52 intersection showed that tracking vehicles between short ‘blind’ spots is reliable. The important area before the turn lane has continuous radar coverage.

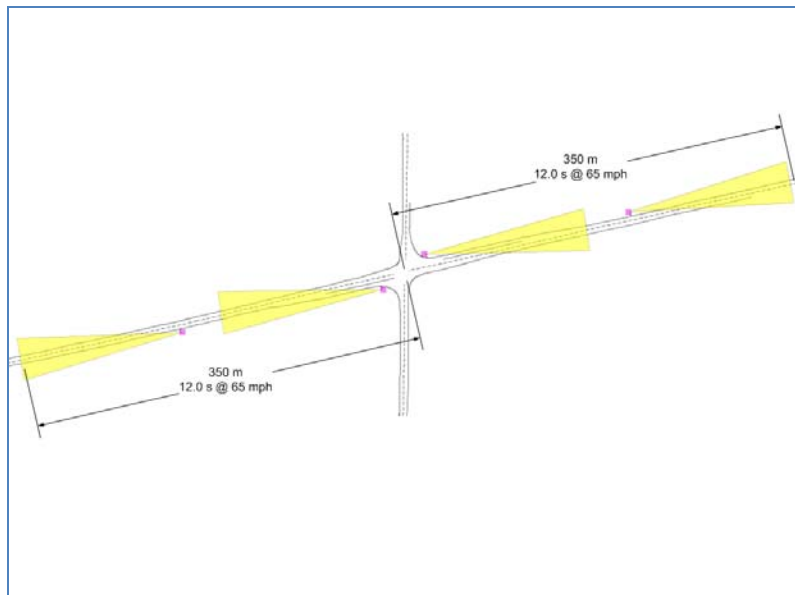

Figure 10: Minimal sensor suite layout required for mainline surveillance system on rural 2 lane highway thru-stop intersection using specifications for Delphi ACC3/Eaton VS-400 radar

The reduction in the number of sensors from six to four reduces the hardware requirements and makes the equipment layout simpler (Figure 11). Only two bores are needed and the distance of trenching is reduced. This helps reduce the installation cost to \$50 K (Table 7).

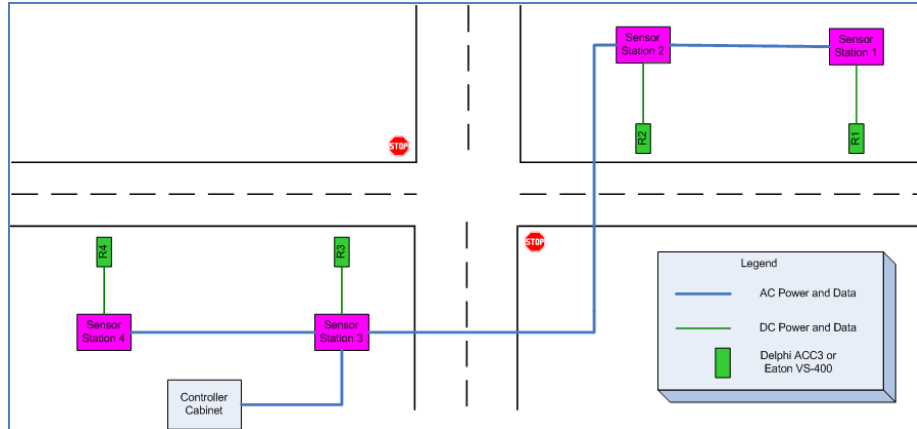

Figure 11: Proposed minimal sensor surveillance system hardware layout for two lane roads with Delphi ACC3/Eaton VS-400 radar

Table 7: Minimal surveillance system costs for 77GHz radar on rural two lane highway thru-stop intersection

Surveillance System Costs for VS-400/ACC3

Construction		Cost per unit	Units	Cost
	Boring	12	164	\$ 1,968
	Trenching	5.75	3308	\$ 19,021
Sensor Station		1660	4	\$ 6,640
Mounting		160	4	\$ 640
Central Processor		13500	1	\$ 13,500
Sensor		2000	4	\$ 8,000
Total				\$ 49,769

Minimal Sensor Set Using Ibeo Lux Scanning Laser

The Ibeo Lux sensor is an automotive laser scanner that detects the position and speed of multiple vehicles within its field of view. Mass production of the sensor is scheduled for fall 2008. Since the sensor is not available for evaluation in time for this report, the specifications provided by Ibeo will be used to determine its layout for the mainline surveillance system.

The long range (200m) and wide azimuth field of view (100 degrees) make the Lux an attractive sensor for the mainline. Figure 12 shows the minimal sensor layout consisting of four Lux sensors, two on each leg. The surveillance system provides 12.9 seconds of coverage at 75 mph. There are few holes in coverage and vehicles should be reliably and continuously sensed throughout the region of interest.

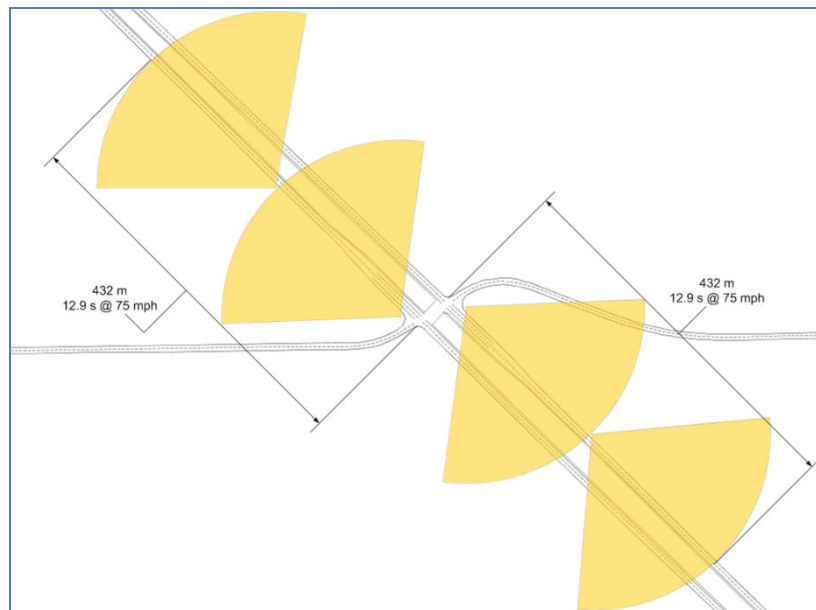

Figure 12: Minimal sensor suite layout required for mainline surveillance system on rural four lane expressway thru-stop intersections using specifications for Ibeo Lux sensor

The hardware layout is fairly simple and straightforward. The installation requires boring across both lanes of the highway in two places and a bore across the median. Power will be available in the locations where the DII would be installed, on both sides of the median and the two corners of the intersection where the sensors are mounted.

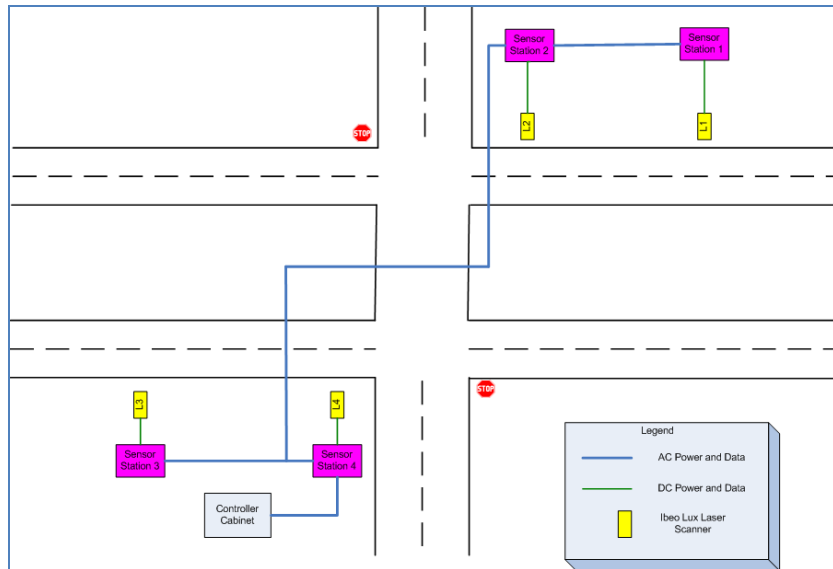

Figure 13: Proposed minimal sensor surveillance system hardware layout for rural four lane expressway thru-stop intersections using Ibeo Lux laser scanners

The current cost for a minimal sensor set installed at a rural four lane expressway thru-stop intersection using Ibeo Lux as the range sensor is shown in Table 8. The total cost for the installation of the surveillance system is currently \$106 K. With economies of scale Ibeo projects that the Lux will cost \$570 (380 €) in 2010. If this projection is met, the estimated system cost would decrease to \$48 K. This compares favorably with the 77 GHz radar on a rural four lane expressway which has an estimated cost of \$64 K.

Table 8: Minimal surveillance system costs for Ibeo Lux installed at a rural four lane expressway thru-stop intersection

Surveillance System Costs for Ibeo Lux

Construction	Cost per unit	Units	Cost
Boring	12	420 \$	5,040
Trenching	5.75	3530 \$	20,298
Sensor Station	1660	4 \$	6,640
Mounting	160	4 \$	640
Central Processor	13500	1 \$	13,500
Sensor	15000	4 \$	60,000
Total			\$ 106,118
Total (Projected Lux cost in 2010, \$570)			\$ 47,518

For a two lane rural two lane highway the slower speed allows a shorter coverage distance. The surveillance system should extend to beyond 360 m on the mainline. The Lux has a maximum range of 200 m, so using one Lux per major leg is not possible without introducing significant holes in coverage. Thus, the sensor layout for a rural 2 lane highway thru-stop intersection is

very similar to the sensor layout for a rural four lane expressway thru-stop intersection (Figure 14). The proposed surveillance system provides 400 m of coverage which corresponds to a 13.8 s time to intersection at 65 mph, meeting the minimum requirements.

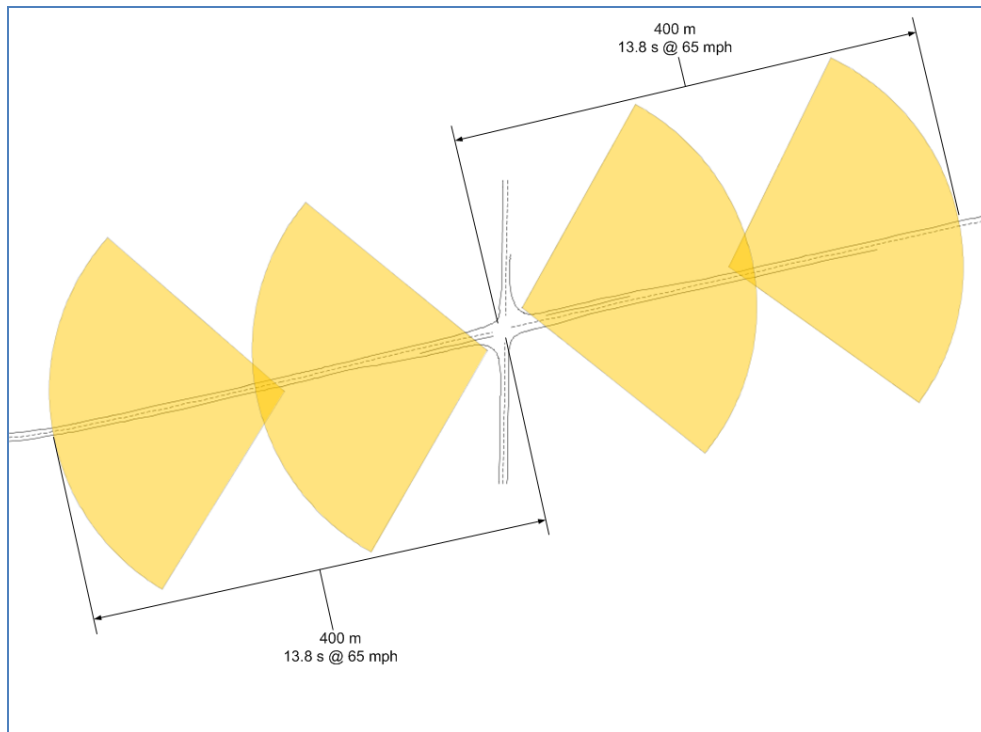

Figure 14: Minimal sensor suite layout required for mainline surveillance system on rural two lane highway thru-stop intersection using specifications for Ibeo Lux Sensor

The hardware layout of a surveillance system installed on a rural two lane highway thru-stop intersection using Lux sensors is shown in Figure 15. Two bores under the minor road are needed for power and data. A third bore may be needed if a DII is required in the upper left hand quadrant of the intersection. Since the DII for a rural 2 lane highway thru-stop intersection has not yet been developed, the location of the DII is unknown.

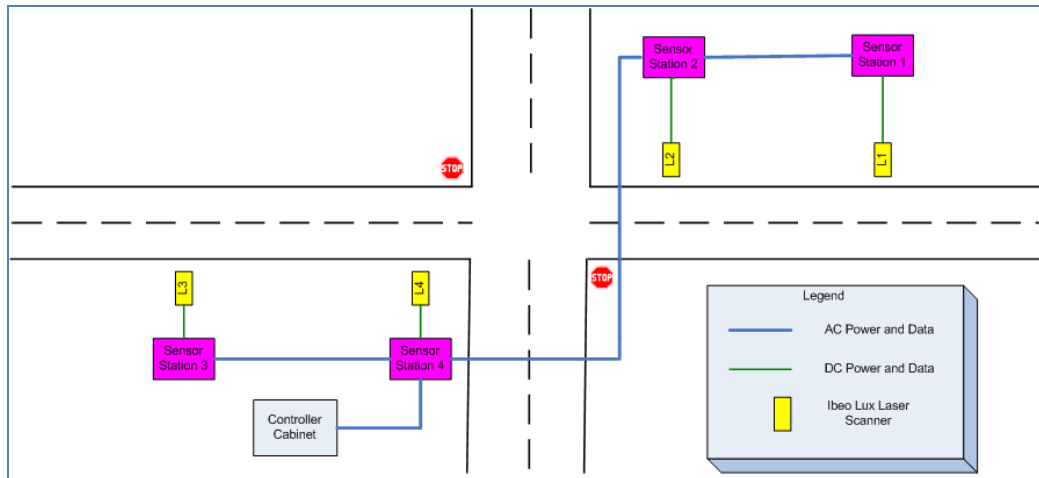

Figure 15: Proposed minimal sensor surveillance system hardware layout for rural two lane highway thru-stop intersections with Ibeo Lux Sensor

The cost of installing the proposed surveillance system on a rural 2 lane highway thru-stop intersection using Lux sensors is not significantly different from the rural four lane expressway thru-stop intersection because the same number of sensors and hence sensor stations are required (Table 9). The main savings occur in the reduced boring and trenching. The current estimated system cost is \$101 K and the 2010 projected cost based on the reduced Lux cost is \$43 K.

Table 9: Minimal surveillance system costs for Ibeo Lux sensor at a rural two land road

Surveillance System Costs for Ibeo Lux

Construction	Cost per unit	Units	Cost
Boring	12	164 \$	1,968
Trenching	5.75	3254 \$	18,711
Sensor Station	1660	4 \$	6,640
Mounting	160	4 \$	640
Central Processor	13500	1 \$	13,500
Sensor	15000	4 \$	60,000
Total		\$	101,459
Total (Projected Lux cost in 2010, \$570)		\$	42,859

Minimal Sensor Set Using Smartmicro UMRR 24 GHz Radar

Smartmicro is a German company that makes customizable radar solutions. They have a radar line called the UMRR which can be configured for short, medium or long range use. In the long range configuration the maximum range is stated to be 240 meters, making it an attractive candidate for a mainline sensor. Using the specifications provided by the company, a to-scale sensor layout was constructed (Figure 16). Due to the long range of the UMRR, only four radar sensors are needed (two per leg) to cover the whole mainline. The proposed sensor layout provides 445 m of coverage which corresponds to a time to intersection of 13.3 seconds at 75

mph. The UMRR has a wide field of view (± 20 deg.) which provides good coverage in both lanes.



Figure 16: Minimal sensor suite layout required for mainline surveillance system on rural four lane expressway thru-stop intersections using specifications for Smartmicro UMRR

The minimal hardware layout is shown in Figure 17. It is fairly straight forward and provides power runs to the median and to both quadrants of the intersection where the DII is located. It is very similar to the Ibeo Lux hardware layout because both sensors provide a long enough range and wide field of view so that only four sensors are needed.

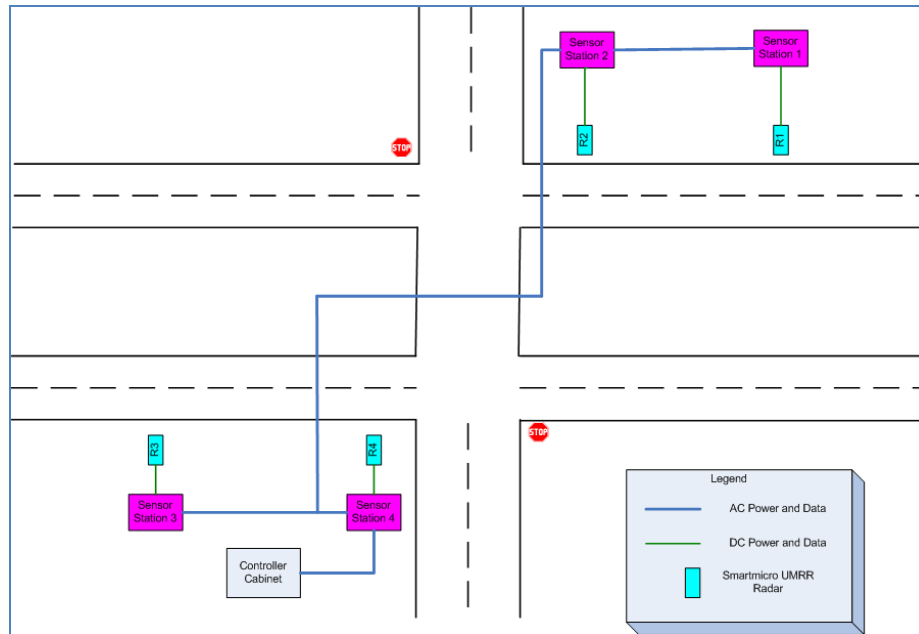

Figure 17: Proposed minimal sensor surveillance system hardware layout using Smartmicro UMRR radar

The costs of the Smartmicro UMRR is \$5000 in small volume. It is possible to license the radar design and build the radar at higher volume for a smaller cost. Given the low volume cost of the UMRR, the total estimated surveillance system cost for the rural four lane expressway thru-stop intersection surveillance system is \$69 K (Table 10). This is comparable to the 77 GHz system and less than the current Ibeo Lux system.

Table 10: Minimal mainline surveillance system costs using Smartmicro UMRR on rural four lane expressway thru-stop intersection

Surveillance System Costs for Smartmicro UMRR

Construction	Cost per unit	Units	Cost
Boring	12	420 \$	5,040
Trenching	5.75	4016 \$	23,092
Sensor Station	1660	4 \$	6,640
Mounting	160	4 \$	640
Central Processor	13500	1 \$	13,500
Sensor	5000	4 \$	20,000
Total		\$	68,912

For the rural two lane highway thru-stop intersection, the sensor layout is similar to the rural four lane expressway (Figure 18). Four sensors are required to cover 440 m which provide a time to intersection of 15.1 s at 65 mph. The coverage is continuous until right before the intersection where the tracking algorithm can estimate the needed parameters for the remaining area to the intersection.

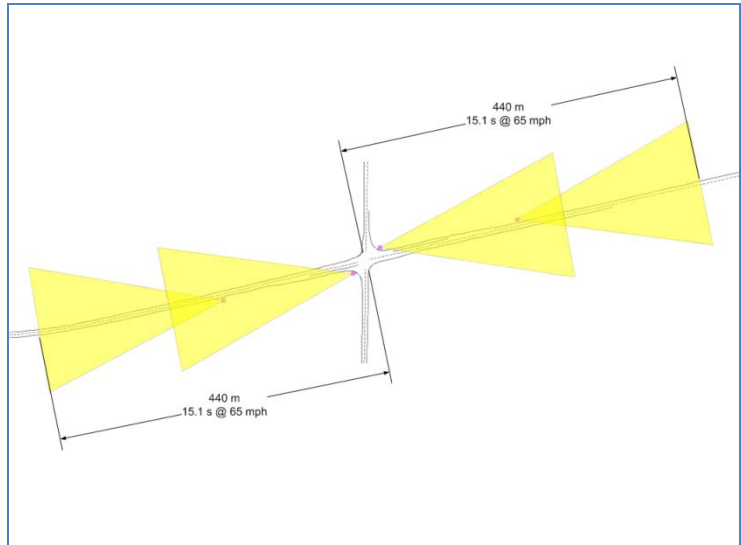

Figure 18: Minimal sensor suite layout required for mainline surveillance system on rural two lane highway thru-stop intersection using specifications for Smartmicro UMRR radar

The hardware layout for the rural 2 lane highway thru-stop intersection is very similar to the rural four lane expressway layout (Figure 19). Four sensor stations and the main controller cabinet are required. Two bores are required to provide power and data to both legs of the intersection.

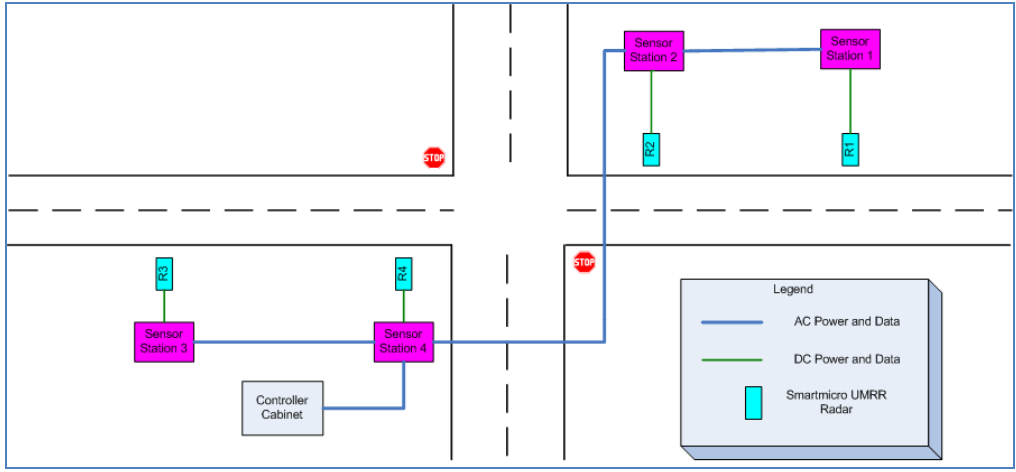

Figure 19: Proposed minimal sensor surveillance system hardware layout for rural two lane highway thru-stop intersection with Smartmicro UMRR radar

The total estimated cost of the proposed surveillance system using Smartmicro radar is given in Table 11. The main cost difference between the rural two lane highway and rural four lane

expressway configurations is in the boring, which is less for a two lane road because only two bores are needed and they are of shorter distance. The overall cost estimate is \$61 K.

Table 11: Minimal surveillance system costs using Smartmicro UMRR radar on a rural two lane highway thru-stop intersection

Surveillance System Costs for Smartmicro UMRR

Construction	Cost per unit	Units	Cost
Boring	12	164 \$	1,968
Trenching	5.75	3176 \$	18,262
Sensor Station	1660	4 \$	6,640
Mounting	160	4 \$	640
Central Processor	13500	1 \$	13,500
Sensor	5000	4 \$	20,000
Total		\$	61,010

Chapter 4

Minor Road Sensing Cost Trade-Offs

In the CICAS-SSA program one of the tasks was to determine the effect of various parameters on the timing of the DII and to come up with an algorithm to control the DIIs. The algorithm was developed by analyzing macroscopic accepted and rejected lag data from hundreds of thousands of vehicle maneuvers. Also, dozens of drivers of various age and gender drove through the Hwy 52 test intersection in an instrumented vehicle. This data set was analyzed to determine whether the DII needs to be customized to accommodate varying types of drivers [8].

The macroscopic analysis showed that rejected gap behavior was remarkably consistent for different vehicle types, time of day and time waiting for a gap. Furthermore, the differences between different intersections of the same geometry were small with regard to rejected gap cumulative density function.

The microscopic analysis was of finer granularity. The instrumented vehicle contained sensors to measure accelerator and brake pedal deployment as well as an inertial measurement unit to measure acceleration and rotation rates. In addition, a high accuracy DGPS receiver measured the position of the vehicle to decimeter accuracy. This detailed vehicle state information was merged with the infrastructure surveillance system data to more accurately measure various gaps/lags at different stages of a maneuver. The analysis revealed that there were insignificant differences in acceleration, gap acceptance, time to cross and lead (leftover) gap between drivers of different age and gender.

The macroscopic and microscopic studies had significant effects on the design of an optimized CICAS-SSA system. The fact that the system does not need to measure the vehicle size eliminates the need for vehicle classification sensing. Also important is the fact that the warning timing does not need to be customized to the individual, meaning that vehicle-infrastructure communication is not a strict requirement (although it could be implemented if desired). This greatly simplifies the CICAS-SSA system and reduces the overall cost.

There is still a reason why minor road and median sensing might be desired. The DIIs can be turned off (i.e. turned black) when no vehicles are at the minor road or median, reducing the electricity cost as each sign has 26,880 LEDs (112x80x3 pixels) and draws a considerable amount of power. In this chapter an analysis of the costs and benefits of implementing minor road and median sensing is conducted.

Electrical Costs of Adaptive Display

The prototype DII installed at the Hwy 52 test intersection is an Adaptive Displays AlphaEclipse Excite series 20mm pitch LED display. The display is a 112 by 80 pixel color LED display with an embedded PC that can communicate via Ethernet. The display has light sensors which provide feedback on the ambient light conditions so that adjustment of the sign brightness can be executed periodically.

The power draw of the display depends upon the image being displayed and the brightness setting based on the ambient light conditions. A white pixel is obtained by turning on the LEDs

of all three primary colors (red, green, blue) and thus draws the most power. The display brightness settings affect each pixel in all light modules (16x16 pixel block). Brightness is based on the light sensor readings and is 100% on a bright sunny day and 10% at night.

The maximum power draw of the DII is 2.59 kW and is based on an all white bitmap at 100% brightness (Table 12). The LED power draw is zero when the pixel is black because the background of the display is black and all three LEDs are turned off. Even though the embedded computer and electronics draw some power at all times, it is assumed in this analysis that this power draw is insignificant when compared to the power draw of the LEDs. The pixel brightness of the sign changes based on the loaded bitmap (warning condition). The default image has a white background and black pixels representing the roadway and text (Figure 20). For this analysis, it is assumed that the pixel whiteness (percentage of white pixels) is 71.6%, which represents the pixel whiteness of Figure 20. The average day in the year has 12 hours of light and 12 hours of dark. Assuming that the sign is at 100% brightness during the day and at 10% at night, the average power draw is roughly 1 kW. This results in an annual estimated electricity cost of \$983 per sign, based on the average cost of electricity for transportation applications¹ (Table 13).

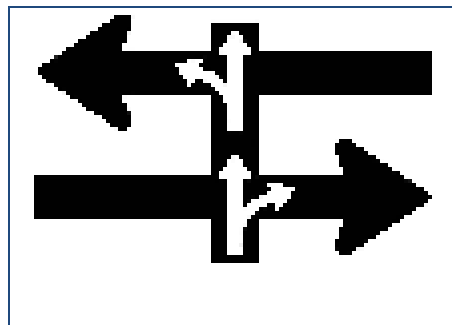

Figure 20: Bitmap representing the default DII state (no vehicles on mainline)

Table 12: Power consumption of one Adaptive 112 x 80 pixel display

Electrical Draw of Adaptec Display

Maximum Power Draw (kW)	2.59
Pixel Whiteness	0.716
Daytime Brightness	100%
Nighttime Brightness	10%
Average Brightness	55%
Daytime Power Draw (kW)	1.85444
Nighttime Power Draw (kW)	0.185444
Average Power Draw (kW/sign)	1.020

¹ http://www.eia.doe.gov/cneaf/electricity/epm/table5_6_a.html

Table 13: Yearly electricity cost of one Adaptive display based on current average cost of electricity

Yearly Electricity Cost of One Adaptec Display

Average Power Draw (kW)		1.02
Hours per year		8760
National Average Cost of Electricity (\$/kWhr)		0.11
Electrical Cost per Year	\$	983

The amount of electricity saved by installing sensors in the median and the minor road is related to what percentage of the time traffic is present on the minor road because the sign can be turned off (turned black) when no vehicles are present. This duty cycle will, of course, depend on traffic patterns at the candidate intersection. The duty cycle is also dependent upon the time of day as in general there are fewer vehicles at night than during the day. Furthermore, the power draw of the sign is significantly less at night (0.1813 kW) than during the day (1.813 kW). Taking these factors into account, the yearly estimated electricity cost savings by turning off the sign when no vehicles are present is calculated for different duty cycles and for day and night (Table 14). Notice that the majority of the cost savings occur during the day when the sign is at 100% brightness. Unfortunately, this is also the time of higher traffic densities.

Table 14: Yearly cost savings if minor road and median sensors are installed so that the sign is turned off when minor road traffic is not present

Yearly Cost Savings if Sign On Only When Traffic Present

Duty Cycle	Daytime	Nighttime
10%	\$786	\$79
20%	\$699	\$70
30%	\$611	\$61
40%	\$524	\$52
50%	\$437	\$44
60%	\$349	\$35
70%	\$262	\$26
80%	\$175	\$17
90%	\$87	\$9
100%	\$0	\$0

Presence Detection on the Minor Road

In order to save on electricity costs, the minor road may have presence detection on the minor road near the stop signs and in the median. When vehicles are present and at a known section of the intersection, the appropriate DIIs can be turned on; when vehicles leave the intersection they can be turned off. A logical candidate for presence detection is the inductive loop detector.

Inductive Loops

Inductive loops have been around for a long time and department of transportation personnel are familiar with the technology. The installation of inductive loops requires sawing into the surface of the road and trenching/boring the wire to a central cabinet, where loop detector cards determine the presence of vehicle directly above the loops. According to a report by the Federal Highway Administration, the cost of installing loops at the four legs of an intersection was \$9K – \$16 K in 2005 dollars [2]. This cost range given in the report was for installing loops on all four legs with a two lane approach. An example hardware layout of such an intersection is shown in Figure 21. There are eight loop detectors covering all eight approach lanes.

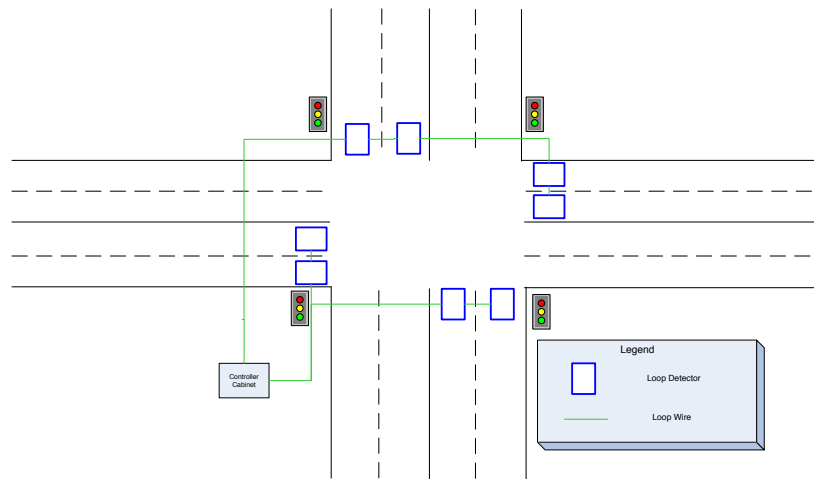

Figure 21: Hardware layout of inductive loop installation of a four leg intersection, two lanes per approach

In order to detect the presence of all minor road vehicles with loop detectors, all possible entry points must be detected. For a rural four lane expressway thru-stop intersection, the stop bar areas and the entry and exit areas of the median must be detected. Figure 22 shows a proposed inductive loop layout for a rural four lane expressway thru-stop intersection. Notice that there are two loops on the minor leg approach. This is because the DII should be turned on before the minor road vehicle reaches the stop sign. A second loop is needed at the stop bar to detect when the minor road vehicle leaves the stop bar area so that the near side DII can be darkened, assuming no vehicles are detected behind the vehicle that just left. It should be noted that Figure 21 depicts an intersection without turn pockets for right hand maneuvers. The presence of turn pockets will require two more loop detectors (one on each minor road approach) to detect when right hand turning vehicles leave the turn pocket and enter the major road.

In the median, two loop detectors are needed at the entry point for vehicles entering from the minor road as well as vehicles entering from the major road. The median on rural four lane expressway thru-stop intersections tends to be wide and is often times not painted with lane stripes, allowing multiple possible vehicle paths. Thus, two loop detectors per direction are needed in order to detect vehicles entering and leaving the median at various lateral positions. The far side DII needs to be turned on when the vehicle arrives at the first median loop. The second pair of median loops detects when the vehicle leaves the median and at that time the far side DII can be darkened, assuming no more vehicles are behind the departing vehicle in the

median. The loop detector layout for a rural four lane expressway thru-stop intersection requires twelve loop detectors in total, fourteen if the intersection contains right hand turn pockets.

Since the cost of installing eight loops at a four way intersection with two approaching lanes per leg was \$9 K - \$16 K in 2005 dollars, it is higher when adjusted for today's dollar. Also, eight loops are a minimum requirement only if the median is narrow enough to accommodate two lanes of traffic and there are no turn pockets, otherwise, up to six additional loops would be necessary (twelve in total if no right hand turn pockets, fourteen if right hand turn pockets). For these reasons, for this analysis, it is estimated that the installation cost of loop detectors on a rural four lane expressway thru-stop intersection for a CICAS-SSA system is \$20K. The added cost accounts for inflation and the installation of an additional four loops (six if there are right hand turn pockets).

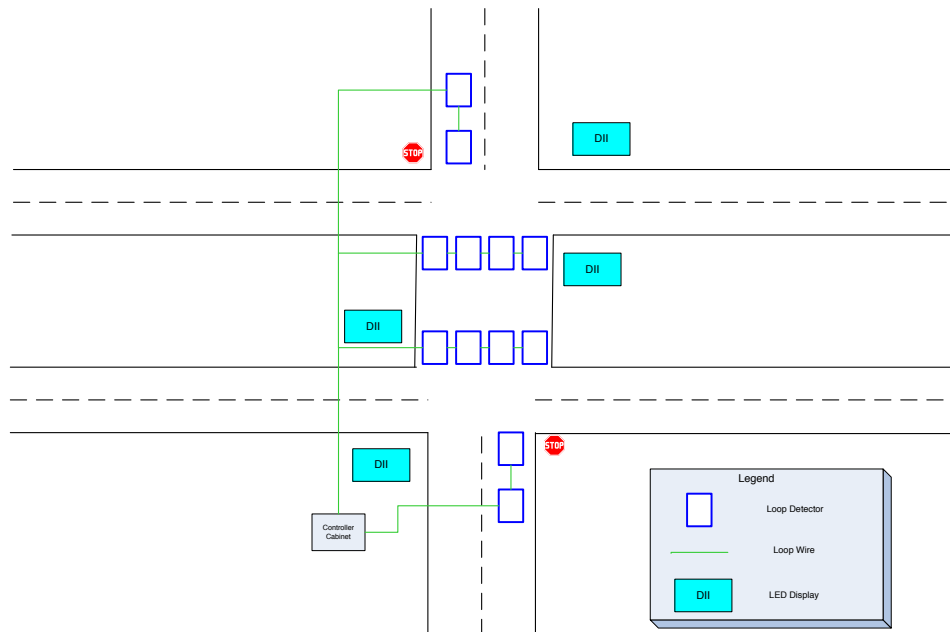

Figure 22: Hardware layout of proposed inductive loop installation of a rural four lane expressway thru-stop intersection

For a rural 2 lane highway thru-stop intersection only the area by the stop bars on the minor road need to be sensed. This simplifies the system and allows a reduction of the number of loops to four (Figure 23). Again, two loops are needed at each stop bar to allow the DII to be turned on before the minor road vehicle approaches the intersection and to sense when the vehicle leaves the stop bar. As with the rural four lane expressway thru-stop intersection, turn pockets necessitate the installation of an additional loop for each side. It is assumed that for this analysis that the installation of the four to six loops at a rural two lane highway thru-stop intersection is \$10K.

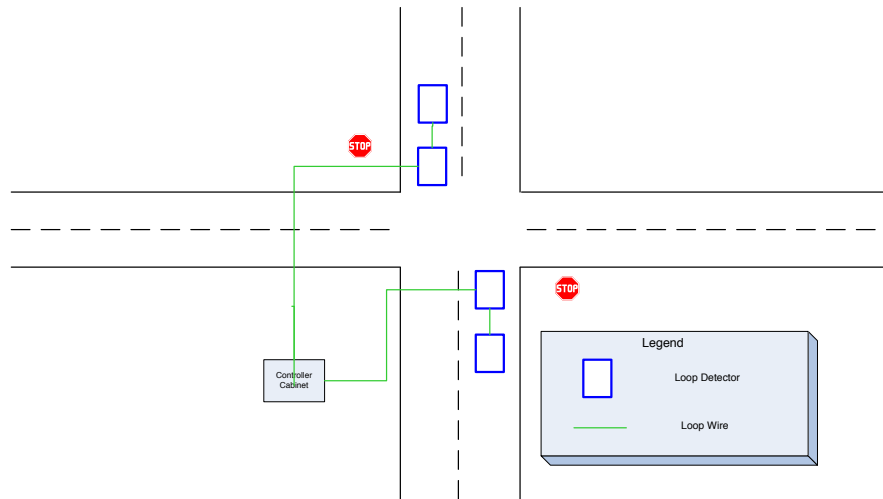

Figure 23: Hardware layout of proposed inductive loop installation on rural two lane highway thru-stop intersection

Ibeo Lux Laser Scanner

A promising candidate for presence detection on the minor road is the Ibeo Lux laser scanner. The reason it is attractive for this application is because of its long range, wide field of view and its ability to sense stopped and slow moving vehicles. It also is a non-contact sensor so that the roadway does not need to be disturbed and lanes of traffic do not need to be diverted during installation. Finally, because of its long range, the sensor can be mounted on existing CICAS-SSA equipment near the intersection, minimizing installation cost.

A possible sensor layout using the Lux as the presence detection sensor is shown in Figure 24. The Lux sensors are added to the sensor layout of the mainline surveillance system consisting of the Smartmicro UMRR radar previously discussed. To sense the stop bar region, the Lux is mounted on the same post as the UMRR radar, but pointed in the opposite direction, towards the stop bar region. For sensing vehicles in the median, the Lux is shown at the location of one of the near side DIIs. Since the radar sensor stations and the DIIs have power and data cables already run to them, the installation cost for this configuration is minimal. The main cost is incurred by the sensor.

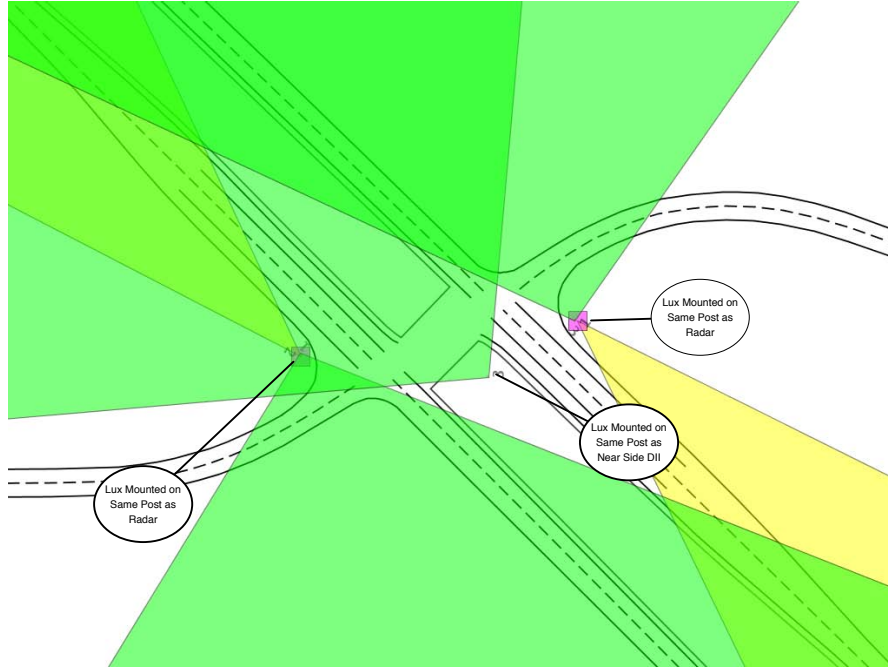

Figure 24: Proposed minor road vehicle presence detection sensor layout using Ibeo Lux, mounted on already existing posts, at rural four lane expressway thru-stop intersection. The field of view of the Lux is shown in green.

On a rural 2 lane highway thru-stop intersection, only two Ibeo Lux sensors would be needed because only the two areas near the stop bar on the minor road need presence detection (Figure 25). The Lux are mounted on the same post as the radar sensor monitoring the mainline. The Lux are pointed in the opposite direction towards the minor road. There is sufficient coverage to detect a vehicle arriving at the stop bar until it leaves.

An unintended benefit of using the Lux is that it has vehicle classification capabilities built in. This would allow customization of the DII message based on vehicle classification. As shown in the timing algorithm development report [8], vehicle classification is not a necessity because different class vehicles had little difference in gap rejection behavior. This is noted here for interest and completeness.

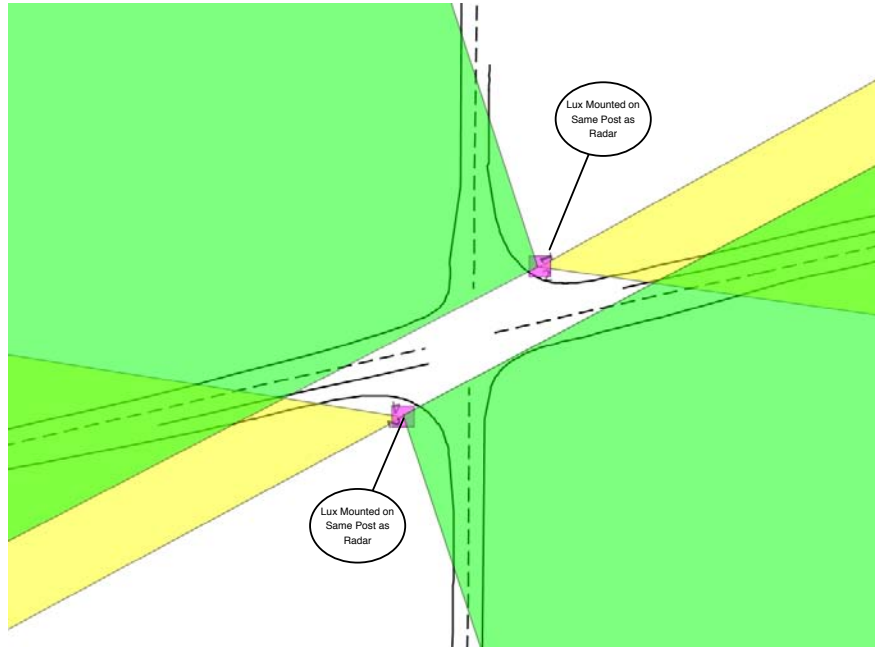

Figure 25: Proposed minor road vehicle presence detection sensor layout using Ibeo Lux, mounted on already existing poles, on a rural two lane highway thru-stop intersection. The field of view of the Lux is shown in green.

Since the Lux sensor in both the rural four lane expressway thru-stop and the rural two lane highway thru-stop intersections are mounted on existing infrastructure, the installation costs are minimal. Currently the Lux costs \$15 K, however, increased production volume should allow the cost of the Lux to decrease to \$570 (in 2010) based on Ibeo’s projections.

Financial Analysis of Installing Minor Road Sensing

The benefit of installing minor road sensing will be weighed with the cost for both loop detectors and Ibeo Lux systems. It is also assumed that electricity costs remain constant and at the current average rate of \$0.11 kW/Hr. Also, a discount rate of 5% is assumed. This is a fairly standard number representing a fairly safe investment alternative.

Using inductive loop detectors to monitor vehicle presence on minor road

For an inductive loop system, the yearly maintenance and operating cost of an intersection with four legs of two lane traffic is between \$0.9K - \$1.5K in 2005 dollars [10]. The rural four lane expressway minor road loop system called for at the very least eight loops (and more likely twelve to fourteen loops), the same as for the four leg – two lane intersection. It is reasonable to assume that the operating and maintenance cost is similar for both configurations, if not slightly higher for the rural four lane expressway thru-stop intersection if more than eight loops are required. For this analysis, it is assumed that the yearly operating and maintenance cost of the loop detector system is \$1.2K, in the middle of the range given in the FHWA Intelligent Transportation Systems benefits and costs report [10].

It was estimated that the cost of installing loop detectors at a rural four lane expressway thru-stop intersection was \$20 K. The cost savings from duty cycling the DIIs is strongly related to the average duty cycle. To get a ball park duty cycle, the time minor road vehicles were detected at

several intersections was collected. A twenty four hour period was selected and the time minor road vehicles were traveling through the intersection in each direction was added for both day and night. The percentage of time (duty cycle) a vehicle was on the minor road near the intersection was calculated (Table 15). For the US Hwy 52 intersection in Minnesota, 24.6% of the time a vehicle was on the minor road during the daytime. At night, 5.7% of the time a vehicle was on the minor road. As part of a pooled fund project, the University of Minnesota installed a temporary, portable intersection surveillance system in two other rural four lane expressway thru-stop intersections. The duty cycle for candidate rural four lane expressway thru-stop intersections in Wisconsin and North Carolina were calculated from data collected in the pooled fund project. The duty cycle ranged from 22% to 59% during the day and 3% to 9% at nighttime. Thus, for this analysis a range of duty cycles will be considered for the daytime (duty cycle is percentage of time DII is displaying an image); 10%, 30%, and 50%. The selected duty cycles cover a realistic range of traffic volume. At night, traffic drops off greatly so it is assumed that the duty cycle is 10%. The costs savings at night are minimal regardless of the duty cycle due to the 10% dimming of the DII in low ambient light conditions.

Table 15: Percentage of time a minor road vehicle was detected at the intersection, one day period

Rural Expressway	Daytime Duty Cycle	Nighttime Duty Cycle
MN 52	24.6%	5.7%
NC 74	22.2%	3.0%
WI 53	58.6%	9.1%

The net present value of installing loop detectors at a rural four lane expressway thru-stop intersection is shown in Table 16. For duty cycles greater or equal to 30%, the net present value is negative for over 20 years. For a 10% daytime duty cycle, the break even occurs in year 12.

Table 16: Net present value of installation minor road sensing vs. cost savings obtained by turning the signs off when no traffic present

Net Present Value of Installing Loop Detectors on Minor Leg of Rural Expressway

Cost of Installation	\$20,000				
Discount Rate	5%				
Operation & Maintenance Cost	\$1,200				
Daytime Duty Cycle	50%		30%		10%
Nighttime Duty Cycle	10%		10%		10%

	Cash Flow	NPV	Cash Flow	NPV	Cash Flow	NPV
Year 1	\$861	-\$19,180	\$1,560	-\$18,514	\$2,259	-\$17,849
Year 2	\$861	-\$18,398	\$1,560	-\$17,099	\$2,259	-\$15,799
Year 3	\$861	-\$17,654	\$1,560	-\$15,751	\$2,259	-\$13,848
Year 4	\$861	-\$16,945	\$1,560	-\$14,467	\$2,259	-\$11,989
Year 5	\$861	-\$16,270	\$1,560	-\$13,245	\$2,259	-\$10,219
Year 6	\$861	-\$15,627	\$1,560	-\$12,081	\$2,259	-\$8,534
Year 7	\$861	-\$15,015	\$1,560	-\$10,972	\$2,259	-\$6,928
Year 8	\$861	-\$14,432	\$1,560	-\$9,916	\$2,259	-\$5,399
Year 9	\$861	-\$13,877	\$1,560	-\$8,910	\$2,259	-\$3,943
Year 10	\$861	-\$13,348	\$1,560	-\$7,952	\$2,259	-\$2,556
Year 11	\$861	-\$12,844	\$1,560	-\$7,040	\$2,259	-\$1,235
Year 12	\$861	-\$12,365	\$1,560	-\$6,171	\$2,259	\$23
Year 13	\$861	-\$11,908	\$1,560	-\$5,343	\$2,259	\$1,221
Year 14	\$861	-\$11,473	\$1,560	-\$4,555	\$2,259	\$2,362
Year 15	\$861	-\$11,058	\$1,560	-\$3,805	\$2,259	\$3,448
Year 16	\$861	-\$10,664	\$1,560	-\$3,090	\$2,259	\$4,483
Year 17	\$861	-\$10,288	\$1,560	-\$2,409	\$2,259	\$5,469
Year 18	\$861	-\$9,930	\$1,560	-\$1,761	\$2,259	\$6,408
Year 19	\$861	-\$9,589	\$1,560	-\$1,144	\$2,259	\$7,302
Year 20	\$861	-\$9,264	\$1,560	-\$556	\$2,259	\$8,153

While it may be financially rational to install loop detectors when daytime traffic is at the intersection on the minor road 10% of the time, this low traffic volume is not characteristic of the high risk intersections CICAS-SSA was designed to support. It would appear that assuming a duty cycle of 10% when determining whether minor road sensing is needed underestimates the real duty cycle on candidate CICAS-SSA intersections and thus overestimates the cost savings from reduced electricity usage. Therefore, it is recommended that loop detectors not be installed at rural four lane expressway CICAS-SSA installed intersections.

For a rural two lane highway thru-stop intersection, the number of DIIs is halved because there is no median and hence no median DIIs. The number of installed loops is between four and six, at least half of the number needed on a rural four lane expressway thru-stop intersection. The installation cost is assumed to be \$10 K, half the cost of installation at a rural intersection. Also, operation and maintenance cost is also assumed to be half, given the reduction in the number of loops. Since the installation, operation and maintenance, and DII electricity cost is assumed half, the net present value calculation is similar to the rural four lane expressway thru-stop intersection (Table 17). For a duty cycle greater or equal to 30%, it is not recommended that loop detectors be installed. The breakeven for a 10% duty cycle occurs in year 12.

Table 17: Net present value of installing inductive loop sensors on a rural 2 lane highway thru-stop intersection in order to reduce electricity costs running the DII signs

Net Present Value of Installing Loop Detectors on Minor Leg of Two Lane Road

Cost of Installation	\$10,000		
Discount Rate	5%		
Operation & Maintenance Cc	\$600		
Daytime Duty Cycle	50%	30%	10%
Nighttime Duty Cycle	10%	10%	10%

	Savings	NPV	Savings	NPV	Savings	NPV
Year 1	\$431	-\$9,590	\$780	-\$9,257	\$1,130	-\$8,924
Year 2	\$431	-\$9,199	\$780	-\$8,549	\$1,130	-\$7,900
Year 3	\$431	-\$8,827	\$780	-\$7,875	\$1,130	-\$6,924
Year 4	\$431	-\$8,473	\$780	-\$7,234	\$1,130	-\$5,995
Year 5	\$431	-\$8,135	\$780	-\$6,622	\$1,130	-\$5,110
Year 6	\$431	-\$7,814	\$780	-\$6,040	\$1,130	-\$4,267
Year 7	\$431	-\$7,508	\$780	-\$5,486	\$1,130	-\$3,464
Year 8	\$431	-\$7,216	\$780	-\$4,958	\$1,130	-\$2,700
Year 9	\$431	-\$6,938	\$780	-\$4,455	\$1,130	-\$1,971
Year 10	\$431	-\$6,674	\$780	-\$3,976	\$1,130	-\$1,278
Year 11	\$431	-\$6,422	\$780	-\$3,520	\$1,130	-\$618
Year 12	\$431	-\$6,182	\$780	-\$3,085	\$1,130	\$11
Year 13	\$431	-\$5,954	\$780	-\$2,672	\$1,130	\$610
Year 14	\$431	-\$5,736	\$780	-\$2,278	\$1,130	\$1,181
Year 15	\$431	-\$5,529	\$780	-\$1,902	\$1,130	\$1,724
Year 16	\$431	-\$5,332	\$780	-\$1,545	\$1,130	\$2,242
Year 17	\$431	-\$5,144	\$780	-\$1,205	\$1,130	\$2,734
Year 18	\$431	-\$4,965	\$780	-\$881	\$1,130	\$3,204
Year 19	\$431	-\$4,794	\$780	-\$572	\$1,130	\$3,651
Year 20	\$431	-\$4,632	\$780	-\$278	\$1,130	\$4,077

A 10% duty cycle underestimates the amount of traffic at rural two lane highway thru-stop intersections. Again, through the pooled fund project the University of Minnesota collected data at two rural two lane highway thru-stop intersections in Michigan and Georgia. Data collected at the CICAS-SSA candidate intersections in Michigan and Georgia showed a daytime duty cycle of 36% and 57% respectively. Therefore, it is recommended that loop detectors not be installed at rural two lane highway thru-stop CICAS-SSA installed intersections.

Two Lane Major Roads	Daytime Duty Cycle	Nighttime Duty Cycle
MI 44	35.7%	24.2%
GA 411	56.7%	13.5%

Using Ibeo Lux to sense presence of vehicles on minor road

An alternative to installing inductive loops at a CICAS-SSA intersection to measure minor road vehicle presence is to install the Ibeo Lux laser scanner. The advantage of this approach is that the road does not need to be disturbed because laser is a non-contact sensor modality. In addition, the Lux’s long range allows generous mounting options. Mounting the sensor at already installed sensor stations greatly reduces installation cost because power and data are already available and therefore no trenching and boring are needed.

The drawback of the Lux sensor is its current cost of \$15,000. However, projections provided by Ibeo predict that with proper production volume that the cost of the sensor will reduce greatly (\$570, Figure 4). Various cost projections were used in a net present value analysis using Ibeo Lux sensors as a presence detection sensor.

In this analysis it is assumed that the discount rate is still 5% and that the daytime duty cycle is 30%. The annual operation and maintenance cost was reduced to \$500 because the sensor is not installed in the road it should require very infrequent maintenance. Three separate installation costs were used to determine the net present value of different Lux costs. Three Lux sensors are required to monitor both minor road stop bar areas and the median. At the current price of \$15K, it costs \$45K for three Lux sensors with \$2K added for installation, assuming it is mounted at a current sensor station. The next cost of \$24000 assumes the Lux sensor price approximately halves. Finally, it is assumed that the price of the Lux drops to \$1K with 2K added for installation for a total of \$5K.

It is clear from Table 18 that installing the Lux at a rural four lane expressway CICAS-SSA equipped intersection to turn off the DIIs when no minor road vehicles are present would result in a positive NPV if the price of the sensor decreases. At the current price, it is not worth installing the Lux-based vehicle presence detection system. However, if the sensor price is halved, the payoff occurs in year 16. If the sensors drops in price to \$1000, the project would be clearly worth it as the break even occurs in year 3.

Table 18: Net present value of installing Ibeo Lux sensors at a rural four lane expressway thru-stop intersections to monitor presence of traffic on minor road, using various sensor cost

Net Present Value of Installing Ibeo Lux on Minor Leg of Rural Expressway

Cost of Installation	\$47,000		\$ 24,000		\$ 5,000	
Discount Rate	5%					
Operation & Maintenance Cost	\$500					
Daytime Duty Cycle	30%		30%		30%	
Nighttime Duty Cycle	10%		10%		10%	
	Cash Flow	NPV	Cash Flow	NPV	Cash Flow	NPV
Year 1	\$2,260	-\$44,847	\$2,260	-\$21,847	\$2,260	-\$2,847
Year 2	\$2,260	-\$42,797	\$2,260	-\$19,797	\$2,260	-\$797
Year 3	\$2,260	-\$40,845	\$2,260	-\$17,845	\$2,260	\$1,155
Year 4	\$2,260	-\$38,985	\$2,260	-\$15,985	\$2,260	\$3,015
Year 5	\$2,260	-\$37,214	\$2,260	-\$14,214	\$2,260	\$4,786
Year 6	\$2,260	-\$35,528	\$2,260	-\$12,528	\$2,260	\$6,472
Year 7	\$2,260	-\$33,921	\$2,260	-\$10,921	\$2,260	\$8,079
Year 8	\$2,260	-\$32,391	\$2,260	-\$9,391	\$2,260	\$9,609
Year 9	\$2,260	-\$30,934	\$2,260	-\$7,934	\$2,260	\$11,066
Year 10	\$2,260	-\$29,547	\$2,260	-\$6,547	\$2,260	\$12,453
Year 11	\$2,260	-\$28,225	\$2,260	-\$5,225	\$2,260	\$13,775
Year 12	\$2,260	-\$26,967	\$2,260	-\$3,967	\$2,260	\$15,033
Year 13	\$2,260	-\$25,768	\$2,260	-\$2,768	\$2,260	\$16,232
Year 14	\$2,260	-\$24,626	\$2,260	-\$1,626	\$2,260	\$17,374
Year 15	\$2,260	-\$23,539	\$2,260	-\$539	\$2,260	\$18,461
Year 16	\$2,260	-\$22,504	\$2,260	\$496	\$2,260	\$19,496
Year 17	\$2,260	-\$21,518	\$2,260	\$1,482	\$2,260	\$20,482
Year 18	\$2,260	-\$20,578	\$2,260	\$2,422	\$2,260	\$21,422
Year 19	\$2,260	-\$19,684	\$2,260	\$3,316	\$2,260	\$22,316
Year 20	\$2,260	-\$18,832	\$2,260	\$4,168	\$2,260	\$23,168

For a rural 2 lane highway thru-stop intersection, only two Lux sensors would be required to monitor presence at the two stop bar locations. There are also only two DIIs in this CICAS-SSA configuration. The operation and maintenance cost is assumed to be 2/3 of the rural four lane expressway thru-stop intersections, or \$333. The NPV analysis shows that at 30% daytime duty cycle, the system is worth installing if the price of the Lux decreases to \$1000.

Table 19: Net present value of installing Ibeo Lux sensors at a rural two lane highway thru-stop intersection to monitor presence of traffic on minor road, using various sensor cost

Net Present Value of Installing Ibeo Lux on Minor Leg of Two Lane Major Road

Cost of Installation	\$32,000	\$	17,000	\$	3,000
Discount Rate	5%				
Operation & Maintenance Cc	\$333				
Daytime Duty Cycle	30%		30%		30%
Nighttime Duty Cycle	10%		10%		10%

	Cash Flow	NPV	Cash Flow	NPV	Cash Flow	NPV
Year 1	\$1,047	-\$31,003	\$1,047	-\$16,003	\$1,047	-\$2,003
Year 2	\$1,047	-\$30,054	\$1,047	-\$15,054	\$1,047	-\$1,054
Year 3	\$1,047	-\$29,149	\$1,047	-\$14,149	\$1,047	-\$149
Year 4	\$1,047	-\$28,288	\$1,047	-\$13,288	\$1,047	\$712
Year 5	\$1,047	-\$27,468	\$1,047	-\$12,468	\$1,047	\$1,532
Year 6	\$1,047	-\$26,687	\$1,047	-\$11,687	\$1,047	\$2,313
Year 7	\$1,047	-\$25,943	\$1,047	-\$10,943	\$1,047	\$3,057
Year 8	\$1,047	-\$25,234	\$1,047	-\$10,234	\$1,047	\$3,766
Year 9	\$1,047	-\$24,560	\$1,047	-\$9,560	\$1,047	\$4,440
Year 10	\$1,047	-\$23,917	\$1,047	-\$8,917	\$1,047	\$5,083
Year 11	\$1,047	-\$23,305	\$1,047	-\$8,305	\$1,047	\$5,695
Year 12	\$1,047	-\$22,722	\$1,047	-\$7,722	\$1,047	\$6,278
Year 13	\$1,047	-\$22,167	\$1,047	-\$7,167	\$1,047	\$6,833
Year 14	\$1,047	-\$21,638	\$1,047	-\$6,638	\$1,047	\$7,362
Year 15	\$1,047	-\$21,135	\$1,047	-\$6,135	\$1,047	\$7,865
Year 16	\$1,047	-\$20,655	\$1,047	-\$5,655	\$1,047	\$8,345
Year 17	\$1,047	-\$20,198	\$1,047	-\$5,198	\$1,047	\$8,802
Year 18	\$1,047	-\$19,763	\$1,047	-\$4,763	\$1,047	\$9,237
Year 19	\$1,047	-\$19,349	\$1,047	-\$4,349	\$1,047	\$9,651
Year 20	\$1,047	-\$18,955	\$1,047	-\$3,955	\$1,047	\$10,045

Extending Life Expectancy of Sign

Another reason to operate the DII only in the presence of a minor road or median positioned vehicle is to increase lifetime expectancy. Selectively turning on the LED sign would increase the life of the LEDs, but not of the other components. The computer and circuitry would continue to run, even when the LEDs are turned off. But the lifetime expectancy of the LEDs could be expanded by turning the DII off during periods of no traffic on the minor road and median.

The life expectancy of the LEDs in the Adaptive Excite line is 100,000 hours. Running at full brightness 24 hours a day would provide a life expectancy of 11.4 years. However, since the sign is not run at full brightness, but rather dimmed to 10% at night by pulse width modulation, the LEDs are on only 55% of the time. This increases the life expectancy to 20.8 years assuming the sign is on 100% of the time. It was assumed that it is sunny during the daytime so that the brightness setting is always 100%, but clearly this is not the case and so the realistic expected life of the LEDs should be longer than 20.8 years.

Using minor road sensing to only operate in the presence of minor road vehicles would increase life expectancy of the LEDs. Twenty plus years is a long time, however. In over twenty years, technologies, traffic patterns, energy costs can change significantly. It is therefore recommended to not install minor road sensing for the purpose of extending the life of the DII.

References

- [1] AASHTO *Strategic Highway Safety Plan*. American Association of State Highway and Transportation Officials. Washington, D.C., 1998.
- [2] T. Neuman, R. Pfefer, K. Slack, D. Harwood, I. Potts, D. Torbic, and E. Rabbani *NCHRP Report 500 (Volume 5): A Guide for Addressing Unsignalized Intersection Collisions*, TRB, National Research Council, Washington, D.C., 2003. http://gulliver.trb.org/publications/nchrp/nchrp_rpt_500v5.pdf.
- [3] H. Preston, R. Storm, M. Donath, and C. Shankwitz, *Review of Minnesota's Rural Intersection Crashes: Methodology for Identifying Intersections for Intersection Decision Support (IDS)*, Mn/DOT Final Report MN/RC-2004-31, St Paul, MN, 2004.
- [4] J.D. Chovan, L. Tijerina, J. A. Pierowicz, and D.L. Hendricks, *Examination of Unsignalized Intersection Straight Crossing Path Crashes and Potential IVHS Countermeasures*, Report DOT HS 808 152, DOT-VNTSC-NHTSA-94-2. Volpe National Transportation Systems Center, Washington, D.C., August 1994.
- [5] H. Preston, R. Storm, M. Donath, and C. Shankwitz, *Review of Michigan's Rural Intersection Crashes: Application of Methodology for Identifying Intersections for Intersection Decision Support (IDS)*, CH2MHill, Mn/DOT Final Report MN/RC-2006-33, St. Paul, MN, August 2006.
- [6] H. Preston, R. Storm, M. Donath, and C. Shankwitz, *Review of North Carolina's Rural Intersection Crashes: Application of Methodology for Identifying Intersections for Intersection Decision Support (IDS)*, CH2MHill, Mn/DOT Final Report MN/RC-2006-32, St. Paul, MN, August 2006.
- [7] H. Preston, R. Storm, C. Shankwitz, and M. Donath, *Review of Wisconsin's Rural Intersection Crashes: Application of Methodology for Identifying Intersections for Intersection Decision Support (IDS)*, CH2MHill, Mn/DOT Final Report MN/RC-2006-10, St. Paul, MN, April 2006.
- [8] A. Gorjestani, A. Menon, P. Cheng, C. Shankwitz, and M. Donath, *Determination of the Alert and Warning Timing for the Cooperative Intersection Collision Avoidance System – Stop Sign Assist Using Macroscopic and Microscopic Data: CICAS-SSA Report #1*, August 2010.
- [9] D. Middleton, R. Parker, *Summary Report on Evaluation of Vehicle Detection Systems*, Project Summary Report O-2119-S, Texas Transportation Institute, College Station, TX, June 2003.

- [10] R.P. Maccubbin, B.L. Staples, M.R. Mercer, F. Kabir, D.R. Abedon, J.A. Bunch, *Intelligent Transportation Systems Benefits, Costs, and Lessons Learned : 2005 Update*, Mitretek Systems, under contract to Federal Highway Administration, USDOT, Washington, D.C., May 2005.
- [11] Minnesota Department of Transportation Office of Traffic Engineering/ITS Section and SRF Consulting Group, Inc., “Evaluation of Non-intrusive Technologies for Traffic Detection”, St. Paul, MN, September 2002.