

High-energy amplitudes in $\mathcal{N} = 4$ SYM at the next-to-leading order

I. Balitsky

JLAB & ODU

Shifmania 15 May 09

- Regge limit in a conformal theory.
- High-energy scattering and Wilson lines.
- Evolution equation for color dipoles.
- Leading order: BK equation.
- Non-linear evolution equation in the NLO.
- $\mathcal{N} = 4$: study of 2-dim conformal invariance at high energies
- NLO BK kernel in $\mathcal{N} = 4$.
- NLO amplitude in $\mathcal{N} = 4$ SYM
- Conclusions.

Conformal four-point amplitude

Analog of QCD photon-photon scattering:

$$A(x, y, x', y') = (x - y)^4 (x' - y')^4 N_c^2 \langle \mathcal{O}(x) \mathcal{O}^\dagger(y) \mathcal{O}(x') \mathcal{O}^\dagger(y') \rangle$$

$\mathcal{O} = \text{Tr}\{Z^2\}$ ($Z = \frac{1}{\sqrt{2}}(\phi_1 + i\phi_2)$) - chiral primary operator

In a conformal theory the amplitude is a function of two conformal ratios

$$A = F(R, R')$$

$$R = \frac{(x - y)^2 (x' - y')^2}{(x - x')^2 (y - y')^2}, \quad R' = \frac{(x - y)^2 (x' - y')^2}{(x - y')^2 (x' - y)^2}$$

At large N_c

$$A(x, y, x', y') = A(g^2 N_c) \quad g^2 N_c = \lambda \quad \text{‘t Hooft coupling}$$

Conformal four-point amplitude

Analog of QCD photon-photon scattering:

$$A(x, y, x', y') = (x - y)^4 (x' - y')^4 N_c^2 \langle \mathcal{O}(x) \mathcal{O}^\dagger(y) \mathcal{O}(x') \mathcal{O}^\dagger(y') \rangle$$

$\mathcal{O} = \text{Tr}\{Z^2\}$ ($Z = \frac{1}{\sqrt{2}}(\phi_1 + i\phi_2)$) - chiral primary operator

In a conformal theory the amplitude is a function of two conformal ratios

$$A = F(R, R')$$

$$R = \frac{(x - y)^2 (x' - y')^2}{(x - x')^2 (y - y')^2}, \quad R' = \frac{(x - y)^2 (x' - y')^2}{(x - y')^2 (x' - y)^2}$$

At large N_c

$$A(x, y, x', y') = A(g^2 N_c) \quad g^2 N_c = \lambda - \text{'t Hooft coupling}$$

Our goal is the resummation of $(\lambda \ln s)^n$ at large energies in the next-to-leading approximation

$$(\lambda \ln s)^n (c_n^{\text{LO}} + c_n^{\text{NLO}} \lambda)$$

Regge limit in the coordinate space

Regge limit: $x_+ \rightarrow \rho x_+$, $x'_+ \rightarrow \rho x'_+$, $y_- \rightarrow \rho' y_-$, $y'_- \rightarrow \rho' y'_-$ $\rho, \rho' \rightarrow \infty$

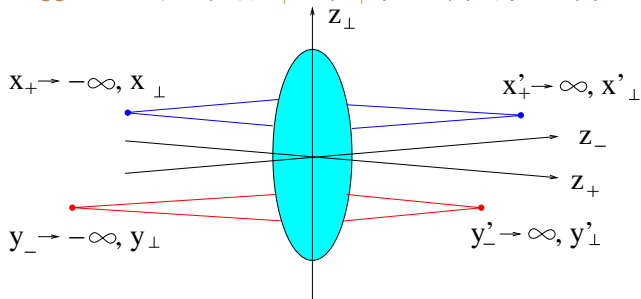

Full 4-dim conformal group: $A = F(R, r)$

$$R = \frac{(x-y)^2(x'-y')^2}{(x-x')^2(y-y')^2} \rightarrow \frac{\rho^2 \rho'^2 x_+ x'_+ y_- y'_-}{(x-x')_{\perp}^2 (y-y')_{\perp}^2} \rightarrow \infty$$

$$r = \frac{[(x-y)^2(x'-y')^2 - (x'-y)^2(x-y)^2]^2}{(x-x')^2(y-y')^2(x-y)^2(x'-y')^2}$$

$$\rightarrow \frac{[(x'-y')_{\perp}^2 x_+ y_- + x'_+ y'_- (x-y)_{\perp}^2 + x_+ y'_- (x'-y)_{\perp}^2 + x'_+ y_- (x-y')_{\perp}^2]^2}{(x-x')_{\perp}^2 (y-y')_{\perp}^2 x_+ x'_+ y_- y'_-}$$

4-dim conformal group versus $SL(2, C)$

Regge limit: $x_+ \rightarrow \rho x_+$, $x'_+ \rightarrow \rho x'_+$, $y_- \rightarrow \rho' y_-$, $y'_- \rightarrow \rho' y'_-$ $\rho, \rho' \rightarrow \infty$

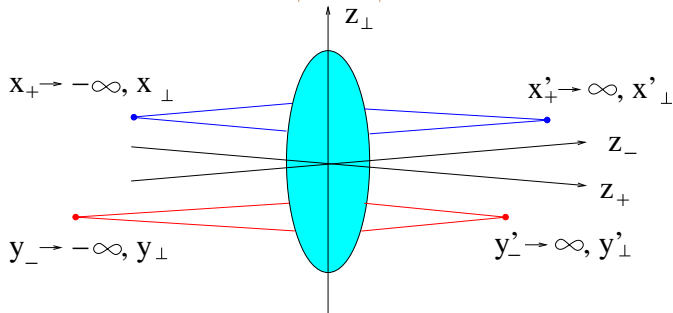

Regge limit symmetry: 2-dim conformal group $SL(2, C)$ formed from P_1, P_2, M^{12}, D, K_1 and K_2 which leave the plane $(0, 0, z_\perp)$ invariant.

$$A(x, y; x', y') \stackrel{s \rightarrow \infty}{=} \frac{i}{2} \int d\nu f_+(\omega(\lambda, \nu)) F(\lambda, \nu) \Omega(r, \nu) R^{\omega(\lambda, \nu)/2}$$

L. Cornalba (2007)

$$f_+(\omega) = \frac{e^{i\pi\omega} - 1}{\sin \pi\omega} \text{ - signature factor}$$

$\Omega(r, \nu)$ - solution of the eqn $(\square_{H_3} + \nu^2 + 1)\Omega(r, \nu) = 0$.

Explicit form:

$$\Omega(r, \nu) = \frac{\nu^2}{\pi^3} \int d^2z \left(\frac{\kappa^2}{(2\kappa \cdot \zeta)^2} \right)^{\frac{1}{2} + i\nu} \left(\frac{\kappa'^2}{(2\kappa' \cdot \zeta)^2} \right)^{\frac{1}{2} - i\nu}$$

$$\zeta = p_1 + \frac{z_\perp^2}{s} p_2 + z_\perp, \quad p_1^2 = p_2^2 = 0, \quad 2(p_1, p_2) = s$$

$$\kappa = \frac{1}{2x_+} (p_1 - \frac{x_\perp^2}{s} p_2 + x_\perp) - \frac{1}{2y_+} (p_1 - \frac{y_\perp^2}{s} p_2 + y_\perp), \quad \kappa^2 \kappa'^2 = \frac{1}{R}$$

$$\kappa' = \frac{1}{2x'_-} (p_1 - \frac{x'^2_\perp}{s} p_2 + x'_\perp) - \frac{1}{2y'_-} (p_1 - \frac{y'^2_\perp}{s} p_2 + y'_\perp), \quad 4(\kappa \cdot \kappa')^2 = \frac{r}{R}$$

The dynamics is described by $\omega(\lambda, \nu)$ and $F(\lambda, \nu)$.

$$A(x, y; x', y') \stackrel{s \rightarrow \infty}{\equiv} \frac{i}{2} \int d\nu f_+(\omega(\lambda, \nu)) F(\lambda, \nu) \Omega(r, \nu) R^{\omega(\lambda, \nu)/2}$$

Pomeron intercept $\omega(\nu, \lambda)$ is known in two limits:

$$1. \quad \lambda \rightarrow 0: \quad \omega(\nu, \lambda) = \frac{\lambda}{\pi} \chi(\nu) + \lambda^2 \omega_1(\nu) + \dots$$

$$\chi(\nu) = 2\psi(1) - \psi\left(\frac{1}{2} + i\nu\right) - \psi\left(\frac{1}{2} - i\nu\right) - \text{BFKL intercept,}$$

$\omega_1(\nu)$ - NLO BFKL intercept

Lipatov, Kotikov (2000)

$$2. \quad \lambda \rightarrow \infty: \quad \text{AdS/CFT} \quad \Rightarrow \quad \omega(\nu, \lambda) = 2 - \frac{\nu^2 + 4}{2\sqrt{\lambda}} + \dots$$

2 = graviton spin , next term -

Brower, Polchinski, Strassler, Tan (2006)

Cornalba, Costa, Penedones (2007)

$$A(x, y; x', y') \stackrel{s \rightarrow \infty}{=} \frac{i}{2} \int d\nu f_+(\omega(\lambda, \nu)) F(\lambda, \nu) \Omega(r, \nu) R^{\omega(\lambda, \nu)/2}$$

The function $F(\nu, \lambda)$ in two limits:

1. $\lambda \rightarrow 0$: $F(\nu, \lambda) = \lambda^2 F_0(\nu) + \lambda^3 F_1(\nu) + \dots$

$$F_0(\nu) = \frac{\pi \sinh \pi \nu}{4\nu \cosh^3 \pi \nu}$$

Cornalba, Costa, Penedones (2007)

$F_1(\nu) =$ see below

G. Chirilli and I.B. (2009)

2. $\lambda \rightarrow \infty$: $AdS/CFT \Rightarrow \omega(\nu, \lambda) = \pi^3 \nu^2 \frac{1 + \nu^2}{\sinh^2 \pi \nu} + \dots$

L.Cornalba (2007)

$$A(x, y; x', y') \stackrel{s \rightarrow \infty}{=} \frac{i}{2} \int d\nu f_+(\omega(\lambda, \nu)) F(\lambda, \nu) \Omega(r, \nu) R^{\omega(\lambda, \nu)/2}$$

The function $F(\nu, \lambda)$ in two limits:

1. $\lambda \rightarrow 0$: $F(\nu, \lambda) = \lambda^2 F_0(\nu) + \lambda^3 F_1(\nu) + \dots$

$$F_0(\nu) = \frac{\pi \sinh \pi \nu}{4\nu \cosh^3 \pi \nu}$$

Cornalba, Costa, Penedones (2007)

$F_1(\nu) =$ see below

G. Chirilli and I.B. (2009)

2. $\lambda \rightarrow \infty$: $AdS/CFT \Rightarrow \omega(\nu, \lambda) = \pi^3 \nu^2 \frac{1 + \nu^2}{\sinh^2 \pi \nu} + \dots$

L.Cornalba (2007)

Leningrad (LNPI) school:

A good paper is a paper where high-order Feynman diagrams are calculated.

$$A(x, y; x', y') \stackrel{s \rightarrow \infty}{=} \frac{i}{2} \int d\nu f_+(\omega(\lambda, \nu)) F(\lambda, \nu) \Omega(r, \nu) R^{\omega(\lambda, \nu)/2}$$

The function $F(\nu, \lambda)$ in two limits:

1. $\lambda \rightarrow 0$: $F(\nu, \lambda) = \lambda^2 F_0(\nu) + \lambda^3 F_1(\nu) + \dots$

$$F_0(\nu) = \frac{\pi \sinh \pi \nu}{4\nu \cosh^3 \pi \nu}$$

Cornalba, Costa, Penedones (2007)

$F_1(\nu) =$ see below

G. Chirilli and I.B. (2009)

2. $\lambda \rightarrow \infty$: $AdS/CFT \Rightarrow \omega(\nu, \lambda) = \pi^3 \nu^2 \frac{1 + \nu^2}{\sinh^2 \pi \nu} + \dots$

L.Cornalba (2007)

Leningrad (LNPI) school:

A good paper is a paper where high-order Feynman diagrams are calculated.

Moscow (ITEP) school: Do not calculate Feynman diagrams - think instead!

$$A(x, y; x', y') \stackrel{s \rightarrow \infty}{=} \frac{i}{2} \int d\nu f_+(\omega(\lambda, \nu)) F(\lambda, \nu) \Omega(r, \nu) R^{\omega(\lambda, \nu)/2}$$

The function $F(\nu, \lambda)$ in two limits:

1. $\lambda \rightarrow 0$: $F(\nu, \lambda) = \lambda^2 F_0(\nu) + \lambda^3 F_1(\nu) + \dots$

$$F_0(\nu) = \frac{\pi \sinh \pi \nu}{4\nu \cosh^3 \pi \nu}$$

Cornalba, Costa, Penedones (2007)

$F_1(\nu)$ = see below

G. Chirilli and I.B. (2009)

2. $\lambda \rightarrow \infty$: $AdS/CFT \Rightarrow \omega(\nu, \lambda) = \pi^3 \nu^2 \frac{1 + \nu^2}{\sinh^2 \pi \nu} + \dots$

L.Cornalba (2007)

We calculate $F_1(\nu)$ (and confirm $\omega_1(\nu)$) using the expansion of high-energy amplitudes in Wilson lines (color dipoles)

Light-cone expansion and DGLAP evolution in the NLO

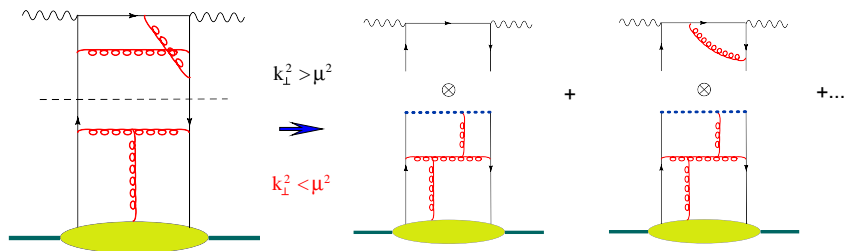

μ^2 - factorization scale (normalization point)

$k_{\perp}^2 > \mu^2$ - coefficient functions

$k_{\perp}^2 < \mu^2$ - matrix elements of light-ray operators (normalized at μ^2)

Light-cone expansion and DGLAP evolution in the NLO

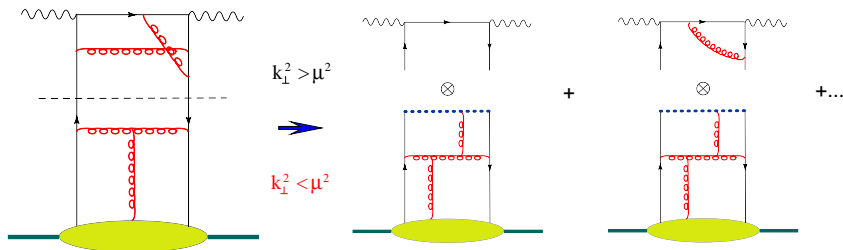

μ^2 - factorization scale (normalization point)

$k_{\perp}^2 > \mu^2$ - coefficient functions

$k_{\perp}^2 < \mu^2$ - matrix elements of light-ray operators (normalized at μ^2)

OPE in light-ray operators

$$(x - y)^2 \rightarrow 0$$

$$T\{j_{\mu}(x)j_{\nu}(y)\} = \frac{x_{\xi}}{2\pi^2 x^4} \left[1 + \frac{\alpha_s}{\pi} (\ln x^2 \mu^2 + C) \right] \bar{\psi}(x) \gamma_{\mu} \gamma^{\xi} \gamma_{\nu} [x, y] \psi(y) + \mathcal{O}\left(\frac{1}{x^2}\right)$$

$$[x, y] \equiv P e^{ig \int_0^1 du (x-y)^{\mu} A_{\mu}(ux + (1-u)y)} - \text{gauge link}$$

Light-cone expansion and DGLAP evolution in the NLO

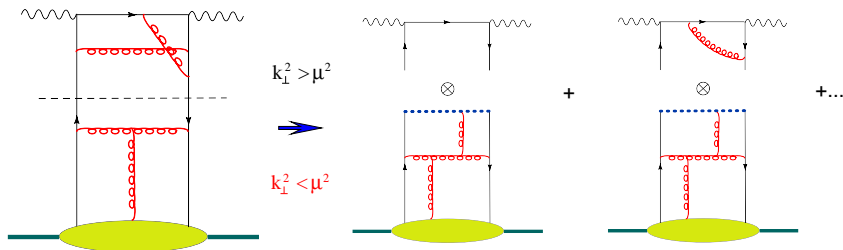

μ^2 - factorization scale (normalization point)

$k_{\perp}^2 > \mu^2$ - coefficient functions

$k_{\perp}^2 < \mu^2$ - matrix elements of light-ray operators (normalized at μ^2)

Renorm-group equation for light-ray operators \Rightarrow DGLAP evolution of parton densities
 $(x - y)^2 = 0$

$$\mu^2 \frac{d}{d\mu^2} \bar{\psi}(x)[x, y]\psi(y) = K_{\text{LO}} \bar{\psi}(x)[x, y]\psi(y) + \alpha_s K_{\text{NLO}} \bar{\psi}(x)[x, y]\psi(y)$$

Expansion of the amplitude in color dipoles in the NLO

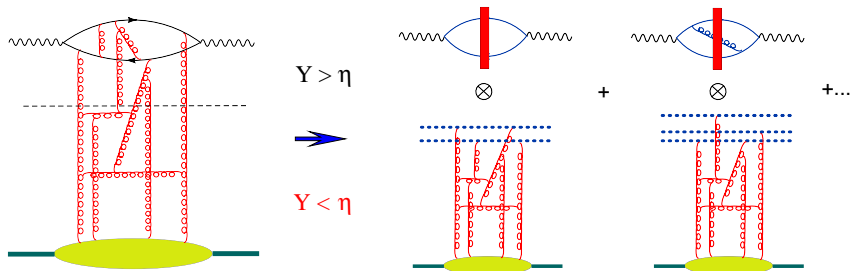

The high-energy operator expansion is

$$T\{\hat{\mathcal{O}}(x)\hat{\mathcal{O}}(y)\} = \int d^2z_1 d^2z_2 I^{\text{LO}}(z_1, z_2) \text{Tr}\{\hat{U}_{z_1}^\eta \hat{U}_{z_2}^{\dagger\eta}\} \\ + \int d^2z_1 d^2z_2 d^2z_3 I^{\text{NLO}}(z_1, z_2, z_3) \left[\frac{1}{N_c} \text{Tr}\{T^n \hat{U}_{z_1}^\eta \hat{U}_{z_3}^{\dagger\eta} T^n \hat{U}_{z_3}^\eta \hat{U}_{z_2}^{\dagger\eta}\} - \text{Tr}\{\hat{U}_{z_1}^\eta \hat{U}_{z_2}^{\dagger\eta}\} \right]$$

In the leading order - conf. invariant impact factor

$$I_{\text{LO}} = \frac{x_+^{-2} y_+^{-2}}{\pi^2 \mathcal{Z}_1^2 \mathcal{Z}_2^2}, \quad \mathcal{Z}_i \equiv \frac{(x - z_i)_\perp^2}{x_+} - \frac{(y - z_i)_\perp^2}{y_+}$$

CCP, 2007

Expansion of the amplitude in color dipoles in the NLO

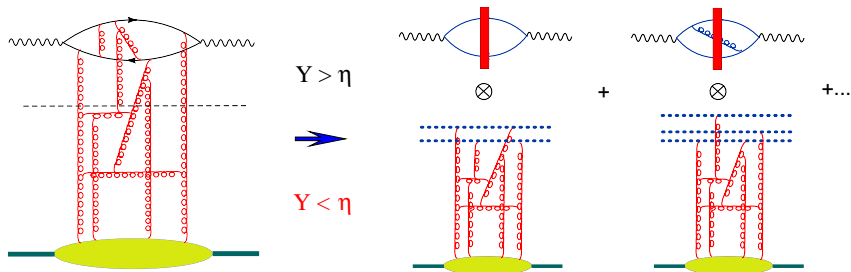

η - rapidity factorization scale

Rapidity $Y > \eta$ - coefficient function (“impact factor”)

Rapidity $Y < \eta$ - matrix elements of (light-like) Wilson lines with rapidity divergence cut by η

$$U_x^\eta = \text{Pexp} \left[ig \int_{-\infty}^{\infty} du p_1^\mu A_\mu^\eta(up_1 + x_\perp) \right]$$

$$A_\mu^\eta(x) = \int \frac{d^4 k}{(2\pi)^4} \theta(e^\eta - |\alpha_k|) e^{-ik \cdot x} A_\mu(k)$$

Spectator frame: propagation in the shock-wave background.



Each path is weighted with the gauge factor $P e^{ig \int dx_\mu A^\mu}$. Quarks and gluons do not have time to deviate in the transverse space \Rightarrow we can replace the gauge factor along the actual path with the one along the straight-line path.

Spectator frame: propagation in the shock-wave background.



Each path is weighted with the gauge factor $P e^{ig \int dx_\mu A^\mu}$. Quarks and gluons do not have time to deviate in the transverse space \Rightarrow we can replace the gauge factor along the actual path with the one along the straight-line path.



Spectator frame: propagation in the shock-wave background.



Each path is weighted with the gauge factor $P e^{ig \int dx_\mu A^\mu}$. Quarks and gluons do not have time to deviate in the transverse space \Rightarrow we can replace the gauge factor along the actual path with the one along the straight-line path.



[$x \rightarrow z$: free propagation] \times

Spectator frame: propagation in the shock-wave background.



Each path is weighted with the gauge factor $P e^{ig \int dx_\mu A^\mu}$. Quarks and gluons do not have time to deviate in the transverse space \Rightarrow we can replace the gauge factor along the actual path with the one along the straight-line path.



$[x \rightarrow z: \text{free propagation}] \times$
 $[U^{ab}(z_\perp) - \text{instantaneous interaction with the } \eta_1 < \eta_2 \text{ shock wave}] \times$

Spectator frame: propagation in the shock-wave background.



Each path is weighted with the gauge factor $P e^{ig \int dx_\mu A^\mu}$. Quarks and gluons do not have time to deviate in the transverse space \Rightarrow we can replace the gauge factor along the actual path with the one along the straight-line path.



$[x \rightarrow z: \text{free propagation}] \times$
 $[U^{ab}(z_\perp) - \text{instantaneous interaction with the } \eta < \eta_2 \text{ shock wave}] \times$
 $[z \rightarrow y: \text{free propagation}]$

NLO impact factor

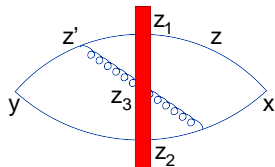

(a)

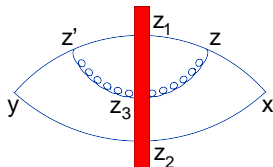

(b)

$$I^{\text{NLO}}(x, y; z_1, z_2, z_3; \eta) = -I^{\text{LO}} \times \frac{\lambda}{\pi^2} \frac{z_{13}^2}{z_{12}^2 z_{23}^2} \left[\ln \frac{\sigma s}{4} \mathcal{Z}_3 - \frac{i\pi}{2} + C \right]$$

The NLO impact factor is not Möbius invariant \Rightarrow the color dipole with the cutoff η is not invariant

However, if we define a composite operator (a - analog of μ^{-2} for usual OPE)

$$\begin{aligned} [\text{Tr}\{\hat{U}_{z_1}^\eta \hat{U}_{z_2}^{\dagger\eta}\}]^{\text{conf}} &= \text{Tr}\{\hat{U}_{z_1}^\eta \hat{U}_{z_2}^{\dagger\eta}\} \\ &+ \frac{\lambda}{2\pi^2} \int d^2 z_3 \frac{z_{12}^2}{z_{13}^2 z_{23}^2} [\text{Tr}\{T^n \hat{U}_{z_1}^\eta \hat{U}_{z_3}^{\dagger\eta} T^n \hat{U}_{z_3}^\eta \hat{U}_{z_2}^{\dagger\eta}\} - N_c \text{Tr}\{\hat{U}_{z_1}^\eta \hat{U}_{z_2}^{\dagger\eta}\}] \ln \frac{a z_{12}^2}{z_{13}^2 z_{23}^2} + O(\lambda^2) \end{aligned}$$

the impact factor becomes conformal in the NLO.

$$\begin{aligned}
 T\{\hat{\mathcal{O}}(x)\hat{\mathcal{O}}(y)\} &= \int d^2z_1 d^2z_2 I^{\text{LO}}(z_1, z_2) \text{Tr}\{\hat{U}_{z_1}^\eta \hat{U}_{z_2}^{\dagger\eta}\}^{\text{conf}} \\
 &+ \int d^2z_1 d^2z_2 d^2z_3 I^{\text{NLO}}(z_1, z_2, z_3) \left[\frac{1}{N_c} \text{Tr}\{T^n \hat{U}_{z_1}^\eta \hat{U}_{z_3}^{\dagger\eta} T^n \hat{U}_{z_3}^\eta \hat{U}_{z_2}^{\dagger\eta}\} - \text{Tr}\{\hat{U}_{z_1}^\eta \hat{U}_{z_2}^{\dagger\eta}\} \right] \\
 I^{\text{NLO}} &= -I^{\text{LO}} \frac{\lambda}{2\pi^2} \int dz_3 \frac{z_{12}^2}{z_{13}^2 z_{23}^2} \left[\ln \frac{z_{12}^2 e^{2\eta} a s^2}{z_{13}^2 z_{23}^2} \mathcal{Z}_3^2 - i\pi + 2C \right]
 \end{aligned}$$

The new NLO impact factor is conformally invariant

$\Rightarrow \text{Tr}\{\hat{U}_{z_1}^\eta \hat{U}_{z_2}^{\dagger\eta}\}^{\text{conf}}$ is Möbius invariant

We think that one can construct the composite conformal dipole operator order by order in perturbation theory.

Analogy: when the UV cutoff does not respect the symmetry of a local operator, the composite local renormalized operator in must be corrected by finite counterterms order by order in perturbation theory.

To get the evolution equation, consider the dipole with the rapidities up to η_1 and integrate over the gluons with rapidities $\eta_1 > \eta > \eta_2$. This integral gives the kernel of the evolution equation (multiplied by the dipole(s) with rapidities up to η_2).

Evolution equation for color dipoles

To get the evolution equation, consider the dipole with the rapidities up to η_1 and integrate over the gluons with rapidities $\eta_1 > \eta > \eta_2$. This integral gives the kernel of the evolution equation (multiplied by the dipole(s) with rapidities up to η_2).

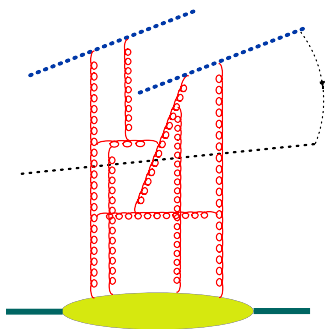

Evolution equation for color dipoles

To get the evolution equation, consider the dipole with the rapidities up to η_1 and integrate over the gluons with rapidities $\eta_1 > \eta > \eta_2$. This integral gives the kernel of the evolution equation (multiplied by the dipole(s) with rapidities up to η_2).

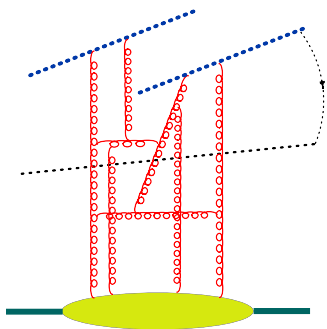

Evolution equation for color dipoles

To get the evolution equation, consider the dipole with the rapidities up to η_1 and integrate over the gluons with rapidities $\eta_1 > \eta > \eta_2$. This integral gives the kernel of the evolution equation (multiplied by the dipole(s) with rapidities up to η_2).

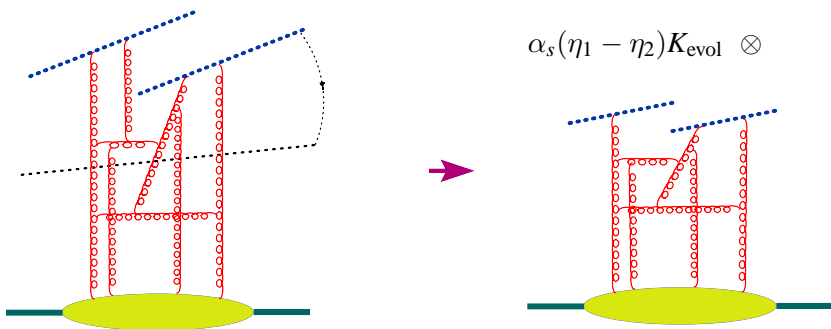

$$\frac{d}{d\eta} \text{Tr}\{\hat{U}_x \hat{U}_y^\dagger\} = K_{\text{LO}} \text{Tr}\{\hat{U}_x \hat{U}_y^\dagger\} + \dots \Rightarrow$$

$$\frac{d}{d\eta} \langle \text{Tr}\{\hat{U}_x \hat{U}_y^\dagger\} \rangle_{\text{shockwave}} = \langle K_{\text{LO}} \text{Tr}\{\hat{U}_x \hat{U}_y^\dagger\} \rangle_{\text{shockwave}}$$

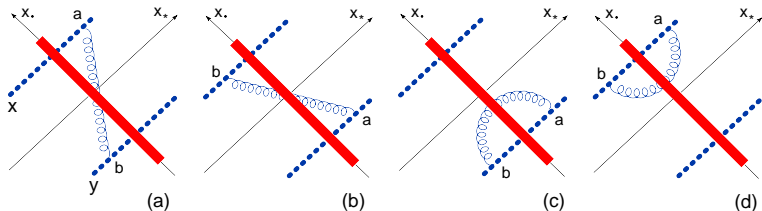

$$U_z^{ab} = \text{Tr}\{t^a U_z t^b U_z^\dagger\} \Rightarrow (U_x U_y^\dagger)^{\eta_1} \rightarrow (U_x U_y^\dagger)^{\eta_1} + \alpha_s (\eta_1 - \eta_2) (U_x U_z^\dagger U_z U_y^\dagger)^{\eta_2}$$

\Rightarrow Evolution equation is non-linear

Non linear evolution equation

$$\hat{\mathcal{U}}(x, y) \equiv 1 - \frac{1}{N_c} \text{Tr}\{\hat{U}(x_\perp) \hat{U}^\dagger(y_\perp)\}$$

Non linear evolution equation

$$\hat{U}(x, y) \equiv 1 - \frac{1}{N_c} \text{Tr}\{\hat{U}(x_\perp)\hat{U}^\dagger(y_\perp)\}$$

BK equation

$$\frac{d}{d\eta}\hat{U}(x, y) = \frac{\alpha_s N_c}{2\pi^2} \int \frac{d^2z}{(x-z)^2(y-z)^2} \left\{ \hat{U}(x, z) + \hat{U}(z, y) - \hat{U}(x, y) - \hat{U}(x, z)\hat{U}(z, y) \right\}$$

I. B. (1996), Yu. Kovchegov (1999)

Alternative approach: JIMWLK (1997-2000)

Non-linear evolution equation

$$\hat{U}(x, y) \equiv 1 - \frac{1}{N_c} \text{Tr}\{\hat{U}(x_\perp)\hat{U}^\dagger(y_\perp)\}$$

BK equation

$$\frac{d}{d\eta}\hat{U}(x, y) = \frac{\alpha_s N_c}{2\pi^2} \int \frac{d^2z}{(x-z)^2(y-z)^2} \left\{ \hat{U}(x, z) + \hat{U}(z, y) - \hat{U}(x, y) - \hat{U}(x, z)\hat{U}(z, y) \right\}$$

I. B. (1996), Yu. Kovchegov (1999)

Alternative approach: JIMWLK (1997-2000)

LLA for DIS in pQCD \Rightarrow BFKL

(LLA: $\alpha_s \ll 1, \alpha_s \eta \sim 1$)

Non-linear evolution equation

$$\hat{U}(x, y) \equiv 1 - \frac{1}{N_c} \text{Tr}\{\hat{U}(x_\perp)\hat{U}^\dagger(y_\perp)\}$$

BK equation

$$\frac{d}{d\eta}\hat{U}(x, y) = \frac{\alpha_s N_c}{2\pi^2} \int \frac{d^2z}{(x-z)^2(y-z)^2} \left\{ \hat{U}(x, z) + \hat{U}(z, y) - \hat{U}(x, y) - \hat{U}(x, z)\hat{U}(z, y) \right\}$$

I. B. (1996), Yu. Kovchegov (1999)

Alternative approach: JIMWLK (1997-2000)

LLA for DIS in pQCD \Rightarrow BFKL

(LLA: $\alpha_s \ll 1, \alpha_s \eta \sim 1$)

LLA for DIS in sQCD \Rightarrow BK eqn

(LLA: $\alpha_s \ll 1, \alpha_s \eta \sim 1, \alpha_s A^{1/3} \sim 1$)

(s for semiclassical)

Conformal invariance of the dipole kernel

Formally, a light-like Wilson line

$$[\infty p_1 + x_\perp, -\infty p_1 + x_\perp] = \text{Pexp} \left\{ ig \int_{-\infty}^{\infty} dx^+ A_+(x^+, x_\perp) \right\}$$

is invariant under inversion (with respect to the point with $x^- = 0$).

Conformal invariance of the dipole kernel

Formally, a light-like Wilson line

$$[\infty p_1 + x_\perp, -\infty p_1 + x_\perp] = \text{Pexp} \left\{ ig \int_{-\infty}^{\infty} dx^+ A_+(x^+, x_\perp) \right\}$$

is invariant under inversion (with respect to the point with $x^- = 0$).

Indeed,

$(x^+, x_\perp)^2 = -x_\perp^2 \Rightarrow$ after the inversion $x_\perp \rightarrow x_\perp/x_\perp^2$ and $x^+ \rightarrow x^+/x_\perp^2$

Conformal invariance of the dipole kernel

Formally, a light-like Wilson line

$$[\infty p_1 + x_\perp, -\infty p_1 + x_\perp] = \text{Pexp} \left\{ ig \int_{-\infty}^{\infty} dx^+ A_+(x^+, x_\perp) \right\}$$

is invariant under inversion (with respect to the point with $x^- = 0$).

Indeed,

$(x^+, x_\perp)^2 = -x_\perp^2 \Rightarrow$ after the inversion $x_\perp \rightarrow x_\perp/x_\perp^2$ and $x^+ \rightarrow x^+/x_\perp^2 \Rightarrow$

$$[\infty p_1 + x_\perp, -\infty p_1 + x_\perp] \rightarrow \text{Pexp} \left\{ ig \int_{-\infty}^{\infty} d\frac{x^+}{x_\perp^2} A_+\left(\frac{x^+}{x_\perp^2}, \frac{x_\perp}{x_\perp^2}\right) \right\} = [\infty p_1 + \frac{x_\perp}{x_\perp^2}, -\infty p_1 + \frac{x_\perp}{x_\perp^2}]$$

Conformal invariance of the dipole kernel

Formally, a light-like Wilson line

$$[\infty p_1 + x_\perp, -\infty p_1 + x_\perp] = \text{Pexp} \left\{ ig \int_{-\infty}^{\infty} dx^+ A_+(x^+, x_\perp) \right\}$$

is invariant under inversion (with respect to the point with $x^- = 0$).

Indeed,

$(x^+, x_\perp)^2 = -x_\perp^2 \Rightarrow$ after the inversion $x_\perp \rightarrow x_\perp/x_\perp^2$ and $x^+ \rightarrow x^+/x_\perp^2 \Rightarrow$

$$[\infty p_1 + x_\perp, -\infty p_1 + x_\perp] \rightarrow \text{Pexp} \left\{ ig \int_{-\infty}^{\infty} d\frac{x^+}{x_\perp^2} A_+\left(\frac{x^+}{x_\perp^2}, \frac{x_\perp}{x_\perp^2}\right) \right\} = [\infty p_1 + \frac{x_\perp}{x_\perp^2}, -\infty p_1 + \frac{x_\perp}{x_\perp^2}]$$

\Rightarrow The dipole kernel is invariant under the inversion $V(x_\perp) = U(x_\perp/x_\perp^2)$

$$\frac{d}{d\eta} \text{Tr}\{V_x V_y^\dagger\} = \frac{\alpha_s}{2\pi^2} \int \frac{d^2 z}{z^4} \frac{(x-y)^2 z^4}{(x-z)^2 (z-y)^2} [\text{Tr}\{V_x V_z^\dagger\} \text{Tr}\{V_z V_y^\dagger\} - N_c \text{Tr}\{V_x V_y^\dagger\}]$$

SL(2,C) for Wilson lines

$$\hat{S}_- \equiv \frac{i}{2}(K^1 + iK^2), \quad \hat{S}_0 \equiv \frac{i}{2}(D + iM^{12}), \quad \hat{S}_+ \equiv \frac{i}{2}(P^1 - iP^2)$$

$$[\hat{S}_0, \hat{S}_\pm] = \pm \hat{S}_\pm, \quad \frac{1}{2}[\hat{S}_+, \hat{S}_-] = \hat{S}_0,$$

$$[\hat{S}_-, \hat{U}(z, \bar{z})] = z^2 \partial_z \hat{U}(z, \bar{z}), \quad [\hat{S}_0, \hat{U}(z, \bar{z})] = z \partial_z \hat{U}(z, \bar{z}), \quad [\hat{S}_+, \hat{U}(z, \bar{z})] = -\partial_z \hat{U}(z, \bar{z})$$

$$z \equiv z^1 + iz^2, \quad \bar{z} \equiv z^1 - iz^2, \quad U(z_\perp) = U(z, \bar{z})$$

Conformal invariance of the dipole kernel

SL(2,C) for Wilson lines

$$\hat{S}_- \equiv \frac{i}{2}(K^1 + iK^2), \quad \hat{S}_0 \equiv \frac{i}{2}(D + iM^{12}), \quad \hat{S}_+ \equiv \frac{i}{2}(P^1 - iP^2)$$

$$[\hat{S}_0, \hat{S}_\pm] = \pm \hat{S}_\pm, \quad \frac{1}{2}[\hat{S}_+, \hat{S}_-] = \hat{S}_0,$$

$$[\hat{S}_-, \hat{U}(z, \bar{z})] = z^2 \partial_z \hat{U}(z, \bar{z}), \quad [\hat{S}_0, \hat{U}(z, \bar{z})] = z \partial_z \hat{U}(z, \bar{z}), \quad [\hat{S}_+, \hat{U}(z, \bar{z})] = -\partial_z \hat{U}(z, \bar{z})$$

$$z \equiv z^1 + iz^2, \quad \bar{z} \equiv z^1 - iz^2, \quad U(z_\perp) = U(z, \bar{z})$$

Conformal invariance of the evolution kernel

$$\frac{d}{d\eta} [\hat{S}_-, \text{Tr}\{U_x U_y^\dagger\}] = \frac{\alpha_s N_c}{2\pi^2} \int dz K(x, y, z) [\hat{S}_-, \text{Tr}\{U_x U_y^\dagger\} \text{Tr}\{U_x U_y^\dagger\}]$$
$$\Rightarrow \left[x^2 \frac{\partial}{\partial x} + y^2 \frac{\partial}{\partial y} + z^2 \frac{\partial}{\partial z} \right] K(x, y, z) = 0$$

Conformal invariance of the dipole kernel

SL(2,C) for Wilson lines

$$\hat{S}_- \equiv \frac{i}{2}(K^1 + iK^2), \quad \hat{S}_0 \equiv \frac{i}{2}(D + iM^{12}), \quad \hat{S}_+ \equiv \frac{i}{2}(P^1 - iP^2)$$

$$[\hat{S}_0, \hat{S}_\pm] = \pm \hat{S}_\pm, \quad \frac{1}{2}[\hat{S}_+, \hat{S}_-] = \hat{S}_0,$$

$$[\hat{S}_-, \hat{U}(z, \bar{z})] = z^2 \partial_z \hat{U}(z, \bar{z}), \quad [\hat{S}_0, \hat{U}(z, \bar{z})] = z \partial_z \hat{U}(z, \bar{z}), \quad [\hat{S}_+, \hat{U}(z, \bar{z})] = -\partial_z \hat{U}(z, \bar{z})$$

$$z \equiv z^1 + iz^2, \quad \bar{z} \equiv z^1 - iz^2, \quad U(z_\perp) = U(z, \bar{z})$$

Conformal invariance of the evolution kernel

$$\frac{d}{d\eta} [\hat{S}_-, \text{Tr}\{U_x U_y^\dagger\}] = \frac{\alpha_s N_c}{2\pi^2} \int dz K(x, y, z) [\hat{S}_-, \text{Tr}\{U_x U_y^\dagger\} \text{Tr}\{U_x U_y^\dagger\}]$$
$$\Rightarrow \left[x^2 \frac{\partial}{\partial x} + y^2 \frac{\partial}{\partial y} + z^2 \frac{\partial}{\partial z} \right] K(x, y, z) = 0$$

In the leading order - OK. In the NLO - ?

$$\begin{aligned} \frac{d}{d\eta} \text{Tr}\{U_x U_y^\dagger\} = & \int \frac{d^2 z}{2\pi^2} \left(\alpha_s \frac{(x-y)^2}{(x-z)^2 (z-y)^2} + \alpha_s^2 K_{NLO}(x, y, z) \right) [\text{Tr}\{U_x U_z^\dagger\} \text{Tr}\{U_z U_y^\dagger\} - N_c \text{Tr}\{U_z U_y^\dagger\}] + \\ & \alpha_s^2 \int d^2 z d^2 z' \left(K_4(x, y, z, z') \{U_x, U_{z'}^\dagger, U_z, U_y^\dagger\} + K_6(x, y, z, z') \{U_x, U_{z'}^\dagger, U_{z'}, U_z, U_z^\dagger, U_y^\dagger\} \right) \end{aligned}$$

K_{NLO} is the next-to-leading order correction to the dipole kernel and K_4 and K_6 are the coefficients in front of the (tree) four- and six-Wilson line operators with arbitrary white arrangements of color indices.

Definition of the NLO kernel

Operator equation

$$\frac{d}{d\eta} \text{Tr}\{\hat{U}_x \hat{U}_y^\dagger\} = \alpha_s K_{\text{LO}} \text{Tr}\{\hat{U}_x \hat{U}_y^\dagger\} + \alpha_s^2 K_{\text{NLO}} \text{Tr}\{\hat{U}_x \hat{U}_y^\dagger\} + \mathcal{O}(\alpha_s^3)$$

Definition of the NLO kernel

Operator equation

$$\frac{d}{d\eta} \text{Tr}\{\hat{U}_x \hat{U}_y^\dagger\} = \alpha_s K_{\text{LO}} \text{Tr}\{\hat{U}_x \hat{U}_y^\dagger\} + \alpha_s^2 K_{\text{NLO}} \text{Tr}\{\hat{U}_x \hat{U}_y^\dagger\} + \mathcal{O}(\alpha_s^3)$$

$$\alpha_s^2 K_{\text{NLO}} \text{Tr}\{\hat{U}_x \hat{U}_y^\dagger\} = \frac{d}{d\eta} \text{Tr}\{\hat{U}_x \hat{U}_y^\dagger\} - \alpha_s K_{\text{LO}} \text{Tr}\{\hat{U}_x \hat{U}_y^\dagger\} + \mathcal{O}(\alpha_s^3)$$

Definition of the NLO kernel

Operator equation

$$\frac{d}{d\eta} \text{Tr}\{\hat{U}_x \hat{U}_y^\dagger\} = \alpha_s K_{\text{LO}} \text{Tr}\{\hat{U}_x \hat{U}_y^\dagger\} + \alpha_s^2 K_{\text{NLO}} \text{Tr}\{\hat{U}_x \hat{U}_y^\dagger\} + O(\alpha_s^3)$$

$$\alpha_s^2 K_{\text{NLO}} \text{Tr}\{\hat{U}_x \hat{U}_y^\dagger\} = \frac{d}{d\eta} \text{Tr}\{\hat{U}_x \hat{U}_y^\dagger\} - \alpha_s K_{\text{LO}} \text{Tr}\{\hat{U}_x \hat{U}_y^\dagger\} + O(\alpha_s^3)$$

We calculate the “matrix element” of the r.h.s. in the shock-wave background

$$\langle \alpha_s^2 K_{\text{NLO}} \text{Tr}\{\hat{U}_x \hat{U}_y^\dagger\} \rangle = \frac{d}{d\eta} \langle \text{Tr}\{\hat{U}_x \hat{U}_y^\dagger\} \rangle - \langle \alpha_s K_{\text{LO}} \text{Tr}\{\hat{U}_x \hat{U}_y^\dagger\} \rangle + O(\alpha_s^3)$$

Definition of the NLO kernel

Operator equation

$$\frac{d}{d\eta} \text{Tr}\{\hat{U}_x \hat{U}_y^\dagger\} = \alpha_s K_{\text{LO}} \text{Tr}\{\hat{U}_x \hat{U}_y^\dagger\} + \alpha_s^2 K_{\text{NLO}} \text{Tr}\{\hat{U}_x \hat{U}_y^\dagger\} + O(\alpha_s^3)$$

$$\alpha_s^2 K_{\text{NLO}} \text{Tr}\{\hat{U}_x \hat{U}_y^\dagger\} = \frac{d}{d\eta} \text{Tr}\{\hat{U}_x \hat{U}_y^\dagger\} - \alpha_s K_{\text{LO}} \text{Tr}\{\hat{U}_x \hat{U}_y^\dagger\} + O(\alpha_s^3)$$

We calculate the “matrix element” of the r.h.s. in the shock-wave background

$$\langle \alpha_s^2 K_{\text{NLO}} \text{Tr}\{\hat{U}_x \hat{U}_y^\dagger\} \rangle = \frac{d}{d\eta} \langle \text{Tr}\{\hat{U}_x \hat{U}_y^\dagger\} \rangle - \langle \alpha_s K_{\text{LO}} \text{Tr}\{\hat{U}_x \hat{U}_y^\dagger\} \rangle + O(\alpha_s^3)$$

Subtraction of the (LO) contribution

$$\Rightarrow \left[\frac{1}{v} \right]_+ \text{prescription in the integrals over Feynman parameter } v$$

Typical integral

$$\int_0^1 dv \frac{1}{(k-p)_\perp^2 v + p_\perp^2 (1-v)} \left[\frac{1}{v} \right]_+ = \frac{1}{p_\perp^2} \ln \frac{(k-p)_\perp^2}{p_\perp^2}$$

Gluon part of the NLO BK kernel: diagrams

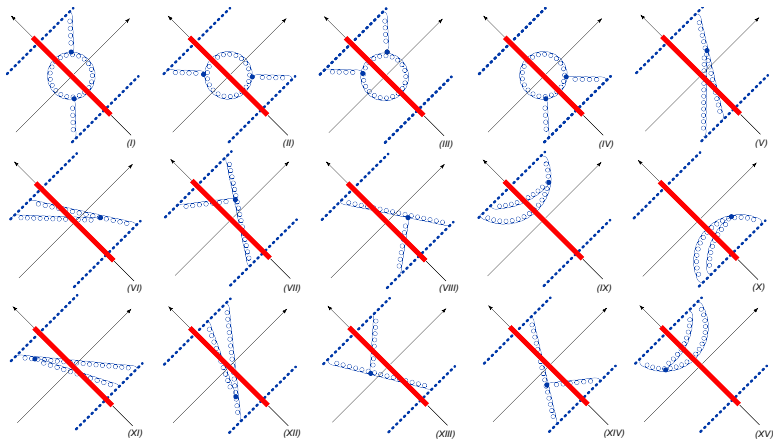

Diagrams for $1 \rightarrow 3$ dipoles transition

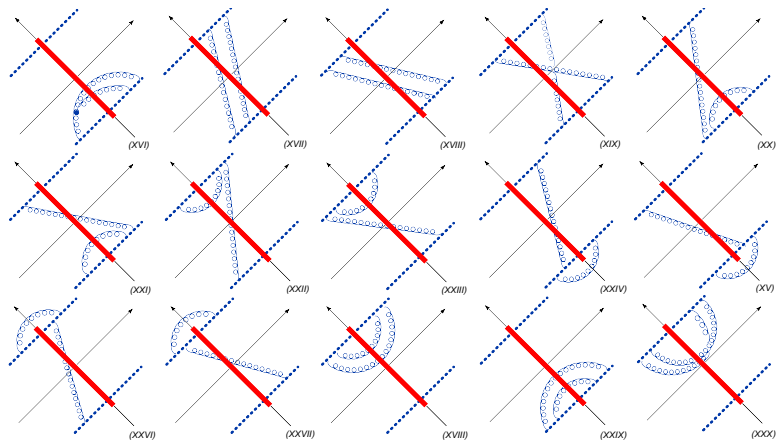

Diagrams for $1 \rightarrow 3$ dipoles transition

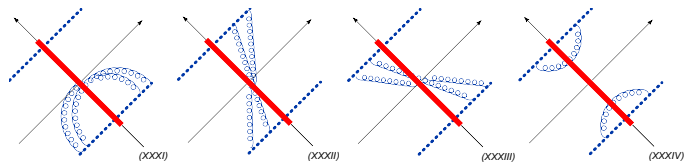

"Running coupling" diagrams

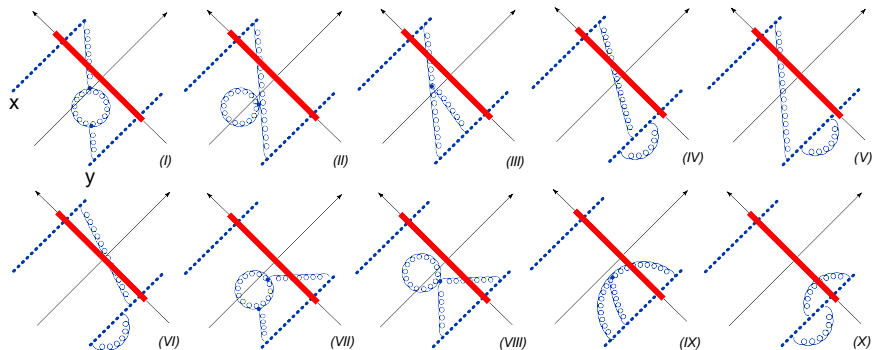

1 \rightarrow 2 dipole transition diagrams

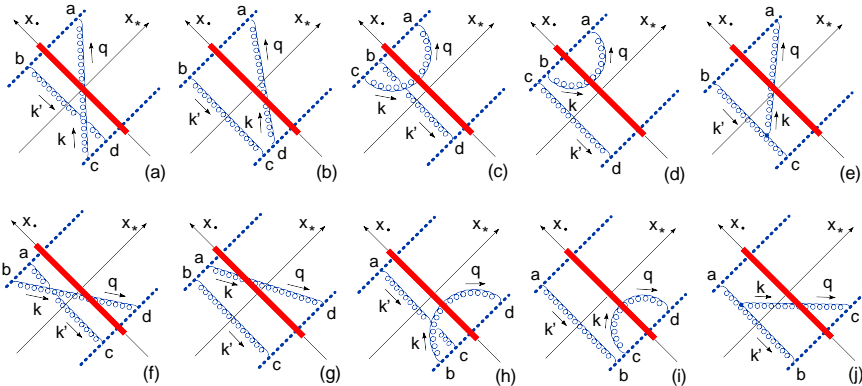

Scalar and gluino loops

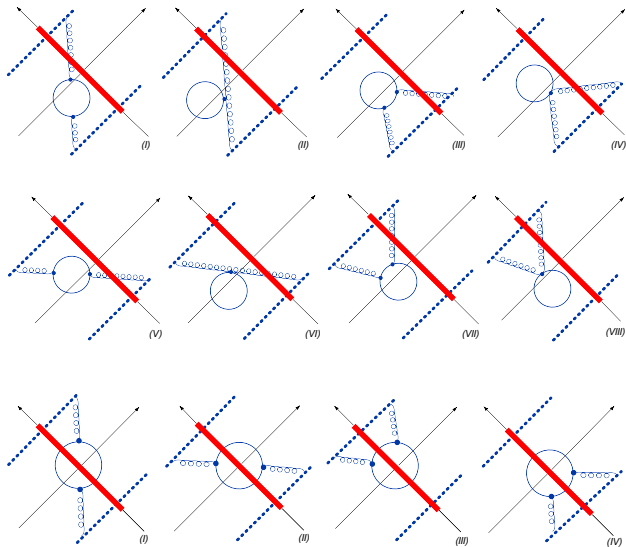

$$\begin{aligned}
& \frac{d}{d\eta} \text{Tr}\{\hat{U}_{z_1}^\eta \hat{U}_{z_2}^{\dagger\eta}\} \\
&= \frac{\alpha_s}{\pi^2} \int d^2 z_3 \frac{z_{12}^2}{z_{13}^2 z_{23}^2} \left\{ 1 - \frac{\alpha_s N_c}{4\pi} \left[\frac{\pi^2}{3} + 2 \ln \frac{z_{13}^2}{z_{12}^2} \ln \frac{z_{23}^2}{z_{12}^2} \right] \right\} \\
&\times [\text{Tr}\{T^a \hat{U}_{z_1}^\eta \hat{U}_{z_3}^{\dagger\eta} T^a \hat{U}_{z_3}^\eta \hat{U}_{z_2}^{\dagger\eta}\} - N_c \text{Tr}\{\hat{U}_{z_1}^\eta \hat{U}_{z_2}^{\dagger\eta}\}] \\
&- \frac{\alpha_s^2}{4\pi^4} \int \frac{d^2 z_3 d^2 z_4}{z_{34}^4} \frac{z_{12}^2 z_{34}^2}{z_{13}^2 z_{24}^2} \left[1 + \frac{z_{12}^2 z_{34}^2}{z_{13}^2 z_{24}^2 - z_{23}^2 z_{14}^2} \right] \ln \frac{z_{13}^2 z_{24}^2}{z_{14}^2 z_{23}^2} \\
&\times \text{Tr}\{[T^a, T^b] \hat{U}_{z_1}^\eta T^{a'} T^{b'} \hat{U}_{z_2}^{\dagger\eta} + T^b T^a \hat{U}_{z_1}^\eta [T^{b'}, T^{a'}] \hat{U}_{z_2}^{\dagger\eta}\} (\hat{U}_{z_3}^\eta)^{aa'} (\hat{U}_{z_4}^\eta - \hat{U}_{z_3}^\eta)^{bb'}
\end{aligned}$$

NLO kernel = **Non-conformal term** + **Conformal term**.

Non-conformal term is due to the non-invariant cutoff $\alpha < \sigma = e^{2\eta}$ in the rapidity of Wilson lines.

$$\begin{aligned}
 & \frac{d}{d\eta} \text{Tr}\{\hat{U}_{z_1}^\eta \hat{U}_{z_2}^{\dagger\eta}\} \\
 &= \frac{\alpha_s}{\pi^2} \int d^2 z_3 \frac{z_{12}^2}{z_{13}^2 z_{23}^2} \left\{ 1 - \frac{\alpha_s N_c}{4\pi} \left[\frac{\pi^2}{3} + 2 \ln \frac{z_{13}^2}{z_{12}^2} \ln \frac{z_{23}^2}{z_{12}^2} \right] \right\} \\
 & \times [\text{Tr}\{T^a \hat{U}_{z_1}^\eta \hat{U}_{z_3}^{\dagger\eta} T^a \hat{U}_{z_3}^\eta \hat{U}_{z_2}^{\dagger\eta}\} - N_c \text{Tr}\{\hat{U}_{z_1}^\eta \hat{U}_{z_2}^{\dagger\eta}\}] \\
 & - \frac{\alpha_s^2}{4\pi^4} \int \frac{d^2 z_3 d^2 z_4}{z_{34}^4} \frac{z_{12}^2 z_{34}^2}{z_{13}^2 z_{24}^2} \left[1 + \frac{z_{12}^2 z_{34}^2}{z_{13}^2 z_{24}^2 - z_{23}^2 z_{14}^2} \right] \ln \frac{z_{13}^2 z_{24}^2}{z_{14}^2 z_{23}^2} \\
 & \times \text{Tr}\{[T^a, T^b] \hat{U}_{z_1}^\eta T^{a'} T^{b'} \hat{U}_{z_2}^{\dagger\eta} + T^b T^a \hat{U}_{z_1}^\eta [T^{b'}, T^{a'}] \hat{U}_{z_2}^{\dagger\eta}\} (\hat{U}_{z_3}^\eta)^{aa'} (\hat{U}_{z_4}^\eta - \hat{U}_{z_3}^\eta)^{bb'}
 \end{aligned}$$

NLO kernel = **Non-conformal term** + **Conformal term**.

Non-conformal term is due to the non-invariant cutoff $\alpha < \sigma = e^{2\eta}$ in the rapidity of Wilson lines.

For the conformal composite dipole the result is Möbius invariant

$$\begin{aligned}
 & \frac{d}{d\eta} [\text{Tr}\{\hat{U}_{z_1}^\eta \hat{U}_{z_2}^{\dagger\eta}\}]^{\text{conf}} \\
 &= \frac{\alpha_s}{\pi^2} \int d^2 z_3 \frac{z_{12}^2}{z_{13}^2 z_{23}^2} \left[1 - \frac{\alpha_s N_c}{4\pi} \frac{\pi^2}{3} \right] [\text{Tr}\{T^a \hat{U}_{z_1}^\eta \hat{U}_{z_3}^{\dagger\eta} T^a \hat{U}_{z_3} \hat{U}_{z_2}^{\dagger\eta}\} - N_c \text{Tr}\{\hat{U}_{z_1}^\eta \hat{U}_{z_2}^{\dagger\eta}\}]^{\text{conf}} \\
 & - \frac{\alpha_s^2}{4\pi^4} \int d^2 z_3 d^2 z_4 \frac{z_{12}^2}{z_{13}^2 z_{24}^2 z_{34}^2} \left\{ 2 \ln \frac{z_{12}^2 z_{34}^2}{z_{14}^2 z_{23}^2} + \left[1 + \frac{z_{12}^2 z_{34}^2}{z_{13}^2 z_{24}^2 - z_{14}^2 z_{23}^2} \right] \ln \frac{z_{13}^2 z_{24}^2}{z_{14}^2 z_{23}^2} \right\} \\
 & \times \text{Tr}\{[T^a, T^b] \hat{U}_{z_1}^\eta T^{a'} T^{b'} \hat{U}_{z_2}^{\dagger\eta} + T^b T^a \hat{U}_{z_1}^\eta [T^{b'}, T^{a'}] \hat{U}_{z_2}^{\dagger\eta}\} [(\hat{U}_{z_3}^\eta)^{aa'} (\hat{U}_{z_4}^\eta)^{bb'} - (z_4 \rightarrow z_3)]
 \end{aligned}$$

Now Möbius invariant!

NLO BFKL equation in $\mathcal{N} = 4$ SYM

To find $A(x, y; x', y')$ we need the linearized (NLO BFKL) equation. With two-gluon accuracy

$$\hat{U}^\eta(x, y) = 1 - \frac{1}{N_c^2 - 1} \text{Tr}\{\hat{U}_x^\eta \hat{U}_y^{\dagger\eta}\}$$

Conformal dipole operator in the BFKL approximation

$$\hat{U}_{\text{conf}}^\eta(z_1, z_2) = \hat{U}^\eta(z_1, z_2) + \frac{\alpha_s N_c}{4\pi^2} \int d^2z \frac{z_{12}^2}{z_{13}^2 z_{23}^2} \ln \frac{az_{12}^2}{z_{13}^2 z_{23}^2} [\hat{U}^\eta(z_1, z_3) + \hat{U}^\eta(z_2, z_3) - \hat{U}^\eta(z_1, z_2)]$$

NLO BFKL equation in $\mathcal{N} = 4$ SYM

To find $A(x, y; x', y')$ we need the linearized (NLO BFKL) equation. With two-gluon accuracy

$$\hat{U}^\eta(x, y) = 1 - \frac{1}{N_c^2 - 1} \text{Tr}\{\hat{U}_x^\eta \hat{U}_y^{\dagger\eta}\}$$

Conformal dipole operator in the BFKL approximation

$$\hat{U}_{\text{conf}}^\eta(z_1, z_2) = \hat{U}^\eta(z_1, z_2) + \frac{\alpha_s N_c}{4\pi^2} \int d^2z \frac{z_{12}^2}{z_{13}^2 z_{23}^2} \ln \frac{az_{12}^2}{z_{13}^2 z_{23}^2} [\hat{U}^\eta(z_1, z_3) + \hat{U}^\eta(z_2, z_3) - \hat{U}^\eta(z_1, z_2)]$$

NLO BFKL

$$\begin{aligned} & \frac{d}{d\eta} \hat{U}_{\text{conf}}^\eta(z_1, z_2) \\ &= \frac{\alpha_s N_c}{2\pi^2} \int d^2z_3 \frac{z_{12}^2}{z_{13}^2 z_{23}^2} \left[1 - \frac{\alpha_s N_c}{4\pi} \frac{\pi^2}{3} \right] [\hat{U}_{\text{conf}}^\eta(z_1, z_3) + \hat{U}_{\text{conf}}^\eta(z_2, z_3) - \hat{U}_{\text{conf}}^\eta(z_1, z_2)] \\ &+ \frac{\alpha_s^2 N_c^2}{8\pi^4} \int \frac{d^2z_3 d^2z_4}{z_{34}^4} \frac{z_{12}^2 z_{34}^2}{z_{13}^2 z_{24}^2} \left\{ 2 \ln \frac{z_{12}^2 z_{34}^2}{z_{14}^2 z_{23}^2} + \left[1 + \frac{z_{12}^2 z_{34}^2}{z_{13}^2 z_{24}^2 - z_{14}^2 z_{23}^2} \right] \ln \frac{z_{13}^2 z_{24}^2}{z_{14}^2 z_{23}^2} \right\} \hat{U}_{\text{conf}}^\eta(z_3, z_4) \\ &+ \frac{3\alpha_s^2 N_c^2}{2\pi^3} \zeta(3) \hat{U}_{\text{conf}}^\eta(z_1, z_2) \end{aligned}$$

Pomeron intercept = the eigenvalue of the NLO BFKL equation

$$\omega(n, \nu) = \frac{\alpha_s N_c}{\pi} \left[\chi\left(n, \frac{1}{2} + i\nu\right) + \frac{\alpha_s N_c}{4\pi} \delta\left(n, \frac{1}{2} + i\nu\right) \right],$$

$$\delta(n, \gamma) = 6\zeta(3) - \frac{\pi^2}{3} \chi(n, \gamma) - \chi''(n, \gamma) - 2\Phi(n, \gamma) - 2\Phi(n, 1 - \gamma)$$

where

$$\chi(n, \gamma) = 2\psi(1) - \psi\left(\gamma + \frac{n}{2}\right) - \psi\left(1 - \gamma + \frac{n}{2}\right)$$

$$\Phi(n, \gamma) = \int_0^1 \frac{dt}{1+t} t^{\gamma-1+\frac{n}{2}} \left\{ \frac{\pi^2}{12} - \frac{1}{2} \psi'\left(\frac{n+1}{2}\right) - \text{Li}_2(t) - \text{Li}_2(-t) \right.$$

$$\left. - \left(\psi(n+1) - \psi(1) + \ln(1+t) + \sum_{k=1}^{\infty} \frac{(-t)^k}{k+n} \right) \ln t - \sum_{k=1}^{\infty} \frac{t^k}{(k+n)^2} [1 - (-1)^k] \right\}$$

Pomeron intercept = the eigenvalue of the NLO BFKL equation

$$\omega(n, \nu) = \frac{\alpha_s N_c}{\pi} \left[\chi\left(n, \frac{1}{2} + i\nu\right) + \frac{\alpha_s N_c}{4\pi} \delta\left(n, \frac{1}{2} + i\nu\right) \right],$$

$$\delta(n, \gamma) = 6\zeta(3) - \frac{\pi^2}{3} \chi(n, \gamma) - \chi''(n, \gamma) - 2\Phi(n, \gamma) - 2\Phi(n, 1 - \gamma)$$

where

$$\chi(n, \gamma) = 2\psi(1) - \psi\left(\gamma + \frac{n}{2}\right) - \psi\left(1 - \gamma + \frac{n}{2}\right)$$

$$\begin{aligned} \Phi(n, \gamma) = & \int_0^1 \frac{dt}{1+t} t^{\gamma-1+\frac{n}{2}} \left\{ \frac{\pi^2}{12} - \frac{1}{2} \psi'\left(\frac{n+1}{2}\right) - \text{Li}_2(t) - \text{Li}_2(-t) \right. \\ & \left. - \left(\psi(n+1) - \psi(1) + \ln(1+t) + \sum_{k=1}^{\infty} \frac{(-t)^k}{k+n} \right) \ln t - \sum_{k=1}^{\infty} \frac{t^k}{(k+n)^2} [1 - (-1)^k] \right\} \end{aligned}$$

Agrees with $j \rightarrow 1$ asymptotics of 3-loop splitting functions

Vogt, Moch, Vermaseren, (2003)

Impact factor should not scale with energy $\Rightarrow a = \frac{x+y+}{(x-y)^2}$ (analog of $\mu^2 = Q^2$ in DIS)

$$(x-y)^4 T\{\hat{O}(x)\hat{O}(y)\} = \frac{(x-y)^4}{\pi^2} \int d^2z_1 d^2z_2 \frac{(x+y+)^{-2}}{\mathcal{Z}_1^2 \mathcal{Z}_2^2} \left\{ \hat{U}^{\text{conf}} \right. \\ \left. - \frac{\lambda}{4\pi^2} \int \frac{d^2z_3 z_{12}^2}{z_{13}^2 z_{23}^2} \left[\ln \frac{x+y+z_{12}^2 e^{2\eta}}{(x-y)_\perp^2 z_{13}^2 z_{23}^2 \mathcal{Z}_3^2} - i\pi \right] [\hat{U}^{\text{conf}}(z_1, z_3) + \hat{U}^{\text{conf}}(z_2, z_3) - \hat{U}^{\text{conf}}(z_1, z_2)] \right\}$$

The projection onto the conformal eigenfunctions $\left(\frac{z_{12}^2}{z_{10}^2 z_{20}^2}\right)^\gamma$ ($\gamma = \frac{1}{2} + i\nu$)

Assembling NLO $F(\nu)$

Impact factor should not scale with energy $\Rightarrow a = \frac{x+y+}{(x-y)^2}$ (analog of $\mu^2 = Q^2$ in DIS)

$$(x-y)^4 T\{\hat{\mathcal{O}}(x)\hat{\mathcal{O}}(y)\} = \frac{(x-y)^4}{\pi^2} \int d^2z_1 d^2z_2 \frac{(x+y+)^{-2}}{\mathcal{Z}_1^2 \mathcal{Z}_2^2} \left\{ \hat{\mathcal{U}}^{\text{conf}} \right. \\ \left. - \frac{\lambda}{4\pi^2} \int \frac{d^2z_3 z_{12}^2}{z_{13}^2 z_{23}^2} \left[\ln \frac{x+y+z_{12}^2 e^{2\eta}}{(x-y)_\perp^2 z_{13}^2 z_{23}^2 z_3^2} - i\pi \right] [\hat{\mathcal{U}}^{\text{conf}}(z_1, z_3) + \hat{\mathcal{U}}^{\text{conf}}(z_2, z_3) - \hat{\mathcal{U}}^{\text{conf}}(z_1, z_2)] \right\}$$

The projection onto the conformal eigenfunctions $\left(\frac{z_{12}^2}{z_{10}^2 z_{20}^2}\right)^\gamma$ ($\gamma = \frac{1}{2} + i\nu$)

$$\int dz_1 dz_2 (x-y)^4 T\{\hat{\mathcal{O}}(x)\hat{\mathcal{O}}(y)\} \left(\frac{z_{12}^2}{z_{10}^2 z_{20}^2}\right)^\gamma = \left(\frac{\kappa^2}{(2\kappa \cdot \zeta_0)^2}\right)^\gamma [I_{\text{LO}}^A(\gamma) + I_{\text{NLO}}^A(\gamma)] \hat{\mathcal{U}}(z_0, \gamma),$$

$$\hat{\mathcal{U}}(z_0, \gamma) = \int d^2z_1 d^2z_2 \left(\frac{z_{12}^2}{z_{10}^2 z_{20}^2}\right)^\gamma \hat{\mathcal{U}}(z_1, z_2)$$

$$I_{\text{LO}}^A(\gamma) = \frac{\Gamma^2(1-\gamma)}{\Gamma(2-2\gamma)} \Gamma(1+\gamma) \Gamma(2-\gamma)$$

$$I_{\text{NLO}}^A(\gamma) = \frac{\lambda}{16\pi^2} I_{\text{LO}}^A \left[\chi^2(\gamma) - \psi'(\gamma) - \psi'(1-\gamma) - 2 + \frac{\pi^2}{3} - F(\gamma) - F(1-\gamma) \right]$$

Similarly

$$\int dz_1 dz_2 (x' - y')^4 T\{\hat{\mathcal{O}}(x')\hat{\mathcal{O}}(y')\} \left(\frac{z_{12}^2}{z_{10}^2 z_{20}^2}\right)^{1-\gamma} = \left(\frac{\kappa^2}{(2\kappa \cdot \zeta_0)^2}\right)^{1-\gamma} [I_{\text{LO}}^A(\gamma) + I_{\text{NLO}}^A(\gamma)] \hat{\mathcal{V}}(z_0),$$

$$\hat{\mathcal{V}}(z_0, \gamma) = \int d^2 z_1 d^2 z_2 \left(\frac{z_{12}^2}{z_{10}^2 z_{20}^2}\right)^\gamma \hat{\mathcal{V}}(z_1, z_2)$$

$$I_{\text{LO}}^B(\gamma) = \frac{\Gamma^2(1 + \gamma)}{\Gamma(2 + 2\gamma)} \Gamma(1 + \gamma) \Gamma(2 - \gamma)$$

$$I_{\text{NLO}}^B(\gamma) = \frac{\lambda}{16\pi^2} I_{\text{LO}}^B \left[\chi^2(\gamma) - \psi'(\gamma) - \psi'(1 - \gamma) - 2 + \frac{\pi^2}{3} - F(\gamma) - F(1 - \gamma) \right]$$

The last ingredient is the amplitude of scattering of two conformal dipoles ($\gamma \equiv \frac{1}{2} + i\nu$)

$$\langle \hat{\mathcal{U}}(z_0, \gamma) \hat{\mathcal{V}}(z'_0, \gamma) \rangle = \delta(\nu - \nu') \delta(z - z') R^{\frac{1}{2}\omega(\nu)} [A_{\text{LO}}(\gamma) + A_{\text{NLO}}(\gamma)]$$

$$A_{\text{LO}}(\gamma) = \frac{\Gamma(-\gamma)\Gamma(\gamma-1)}{\Gamma(1+\gamma)\Gamma(2-\gamma)}, \quad A_{\text{NLO}}(\gamma) = -\frac{\lambda}{4\pi^2} A_{\text{LO}} \left[\frac{\chi(\gamma)}{\gamma(1-\gamma)} - \frac{\pi^2}{3} \right]$$

The result is $F(\nu) = F_{\text{LO}}(\nu) + \lambda F_{\text{NLO}}(\nu) + \mathcal{O}(\lambda^2)$

$$F_{\text{LO}}(\nu) = I_{\text{LO}}^A(\nu) A_{\text{LO}}(\nu) I_{\text{LO}}^B(\nu),$$

$$F_{\text{NLO}}(\nu) = I_{\text{NLO}}^A(\nu) A_{\text{LO}}(\nu) I_{\text{LO}}^B + I_{\text{LO}}^A(\nu) A_{\text{NLO}}(\nu) I_{\text{LO}}^B + I_{\text{NLO}}^A(\nu) A_{\text{LO}}(\nu) I_{\text{NLO}}^B(\nu)$$

NLO evolution of composite “conformal” dipoles in QCD

$$\begin{aligned}
 \frac{d}{d\eta} \text{tr}\{U_x U_y^\dagger\} &= \frac{\alpha_s}{2\pi^2} \int d^2z \left([\text{tr}\{U_x U_z^\dagger\} \text{tr}\{U_z U_y^\dagger\} - N_c \text{tr}\{U_x U_y^\dagger\}] \right. \\
 &\times \frac{(x-y)^2}{X^2 Y^2} \left[1 + \frac{\alpha_s N_c}{4\pi} (b \ln(x-y)^2 \mu^2 + b \frac{X^2 - Y^2}{X^2 Y^2} \ln \frac{X^2}{Y^2} + \frac{67}{9} - \frac{\pi^2}{3}) \right] \\
 &+ \frac{\alpha_s}{4\pi^2} \int \frac{d^2z'}{(z-z')^4} \left\{ \left[-2 + \frac{X'^2 Y^2 + Y'^2 X^2 - 4(x-y)^2 (z-z')^2}{2(X'^2 Y^2 - Y'^2 X^2)} \ln \frac{X'^2 Y^2}{Y'^2 X^2} \right] \right. \\
 &\times [\text{tr}\{U_x U_z^\dagger\} \text{tr}\{U_z U_{z'}^\dagger\} \{U_{z'} U_y^\dagger\} - \text{tr}\{U_x U_z^\dagger U_{z'} U_y^\dagger U_z U_{z'}^\dagger\} - (z' \rightarrow z)] \\
 &+ \frac{(x-y)^2 (z-z')^2}{X^2 Y'^2} \left[2 \ln \frac{(x-y)^2 (z-z')^2}{X'^2 Y^2} + \left(1 + \frac{(x-y)^2 (z-z')^2}{X^2 Y'^2 - X'^2 Y^2} \right) \ln \frac{X^2 Y'^2}{X'^2 Y^2} \right] \\
 &\left. \times [\text{tr}\{U_x U_z^\dagger\} \text{tr}\{U_z U_{z'}^\dagger\} \{U_{z'} U_y^\dagger\} - \text{tr}\{U_x U_{z'}^\dagger U_z U_y^\dagger U_{z'} U_z^\dagger\} - (z' \rightarrow z)] \right\}
 \end{aligned}$$

$$b = \frac{11}{3} N_c - \frac{2}{3} n_f, \quad X \equiv x - z, \quad Y \equiv y - z, \quad X' \equiv x - z', \quad Y' \equiv y - z'$$

$K_{\text{NLO BK}}$ = Running coupling part + Conformal "non-analytic" (in j) part
 + Conformal analytic ($\mathcal{N} = 4$) part

Linearized $K_{\text{NLO BK}}$ reproduces the known result for the forward NLO BFKL kernel.

- High-energy operator expansion in Wilson lines works at the NLO level.

- High-energy operator expansion in Wilson lines works at the NLO level.
- The NLO BK kernel in for the evolution of conformal composite dipoles in $\mathcal{N} = 4$ SYM is Möbius invariant in the transverse plane.
- The NLO BK kernel agrees with NLO BFKL eigenvalues.
- The correlation function of four Z^2 operators is calculated at the NLO order.

Happy Birthday!