



Permeable Pavements in Cold Climates: State of the Art and Cold Climate Case Studies

John S. Gulliver, Principal Investigator
Department of Civil, Environmental, and Geo- Engineering
University of Minnesota

June 2015

Research Project
Final Report 2015-30

Minnesota
Department of
Transportation

**RESEARCH
SERVICES
&
LIBRARY**

**Office of
Transportation
System
Management**



To request this document in an alternative format call [651-366-4718](tel:651-366-4718) or [1-800-657-3774](tel:1-800-657-3774) (Greater Minnesota) or email your request to ADArequest.dot@state.mn.us. Please request at least one week in advance.

Technical Report Documentation Page

1. Report No. MN/RC 2015-30	2.	3. Recipients Accession No.	
4. Title and Subtitle Permeable Pavements in Cold Climates: State of the Art and Cold Climate Case Studies		5. Report Date June 2015	
		6.	
7. Author(s) Peter T. Weiss, Masoud Kayhanian, Lev Khazanovich, and John S. Gulliver		8. Performing Organization Report No.	
9. Performing Organization Name and Address St. Anthony Falls Laboratory University of Minnesota 2 Third Ave. SE Minneapolis, MN 55414		10. Project/Task/Work Unit No. CTS # 2014010	
		11. Contract (C) or Grant (G) No. (c) 99008 (wo) 99	
12. Sponsoring Organization Name and Address Local Road Research Board Minnesota Department of Transportation Research Services & Library 395 John Ireland Boulevard, MS 330 St. Paul, Minnesota 55155-1899		13. Type of Report and Period Covered Final Report	
		14. Sponsoring Agency Code	
15. Supplementary Notes http://www.lrrb.org/pdf/201530.pdf			
16. Abstract (Limit: 250 words) <p>This document is an extensive review of full-depth permeable pavements including porous asphalt, pervious concrete, and permeable interlocking concrete pavers (PICP). Also included is a brief section on articulated concrete blocks/mats. The main topics, which have been divided into chapters, include structural and mix design, hydrologic design, hydraulic performance (i.e. infiltration capacity), maintenance needs/frequency/actions, the impact of permeable pavement on water quality, results of a highway shoulder feasibility study, knowledge gaps, and several cold climate case studies from the United States and Canada.</p> <p>While progress has recently been made with the relatively new permeable pavement technology, researchers have also identified many unresolved issues that are not well understood. These include a methodology to measure subgrade infiltration rates, filling data gaps related to structural integrity, construction, and related issues associated with permeable pavements, determining what maintenance activities are most effective on various pavement types and how frequently specific maintenance actions should be performed, a better understanding of the processes involved in the observed reduction of contaminant concentrations in stormwater flowing through permeable pavements, and a better understanding of the performance of permeable pavements over a time frame that better corresponds with a life-span of 20 years.</p>			
17. Document Analysis/Descriptors Porous pavements, Frigid regions, Infiltration, Pavement design, Paving, Maintenance, Hydrologic cycle, Hydraulics, Water quality, Life cycle costing, Concrete blocks, Interlocking aggregates		18. Availability Statement No restrictions. Document available from: National Technical Information Services, Alexandria, Virginia 22312	
19. Security Class (this report) Unclassified	20. Security Class (this page) Unclassified	21. No. of Pages 375	22. Price

Permeable Pavements in Cold Climates: State of the Art and Cold Climate Case Studies

Final Report

Prepared by:

Peter T. Weiss
Department of Civil Engineering
Valparaiso University

Masoud Kayhanian
Department of Civil and Environmental Engineering
University of California-Davis

Lev Khazanovich
John S. Gulliver
Department of Civil, Environmental, and Geo- Engineering
University of Minnesota

June 2015

Published by:

Minnesota Department of Transportation
Research Services & Library
395 John Ireland Boulevard, MS 330
St. Paul, Minnesota 55155-1899

This report represents the results of research conducted by the authors and does not necessarily represent the views or policies of the Minnesota Local Road Research Board, the Minnesota Department of Transportation, or Valparaiso University, University of California-Davis, or the University of Minnesota. This report does not contain a standard or specified technique.

The authors, the Minnesota Local Road Research Board, the Minnesota Department of Transportation, and Valparaiso University, University of California-Davis, and the University of Minnesota do not endorse products or manufacturers. Any trade or manufacturers' names that may appear herein do so solely because they are considered essential to this report.

Acknowledgements

This project was funded by the Local Road Research Board (LRRB) and the Minnesota Department of Transportation (MnDOT). The authors acknowledge the guidance and direction from City of Shoreview, Minnesota Public Works Director, Mark Maloney, and the review and input from the technical advisory panel consisting of Tim Anderson (MnDOT), David Smith (ICPI), Jill Thomas (NAPA), Dr. Bernard Izevbekhai (MnDOT), Shongtao Dai (MnDOT), Klaton Eckles (Woodbury), Fred Corrigan (ARMM), Kristine Gaga (Roseville), Reid Wronski (River Falls, WI), Lois Eberhart (Minneapolis), Mary Vancura (Beton Consulting), and Project Coordinators Alan Rindels (MnDOT) and Nicholas Cruz (MnDOT).

Table of Contents

Chapter 1	Introduction.....	1
1.1	Background.....	1
1.2	Focus of this report	2
Chapter 2	Typical Mix Design, Cross Section Layers and Structural Design	3
2.1	Porous Asphalt Pavement	3
2.1.1	<i>Typical Cross Section Design.....</i>	<i>3</i>
2.1.2	<i>Structural Design.....</i>	<i>8</i>
2.2	Pervious Concrete Pavement	12
2.2.1	<i>Typical Aggregate Mix and Cross Section Design.....</i>	<i>12</i>
2.2.2	<i>Structural Design.....</i>	<i>20</i>
2.3	Interlocking Concrete Pavement.....	22
2.3.1	<i>Typical Aggregate Mix and Cross Section Design.....</i>	<i>22</i>
2.3.2	<i>Structural Design.....</i>	<i>23</i>
2.3.3	<i>Permeable Articulated Concrete Block/Mats.....</i>	<i>25</i>
Chapter 3	Hydrologic Design.....	30
3.1	Overview.....	30
3.2	Native Soil Infiltration Capacity.....	30
3.3	Methods for Determining Runoff Volumes and Reservoir Capacity.....	34
3.3.1	<i>The Curve Number Method.....</i>	<i>34</i>
3.3.2	<i>The Rational Method.....</i>	<i>35</i>
3.3.3	<i>Permeable Interlocking Concrete Pavers Method.....</i>	<i>36</i>
3.4	Los Angeles County Method	37
3.5	Computer Modeling.....	37
Chapter 4	Hydraulic Performance.....	38
4.1	Surface Infiltration Capacity.....	38
4.1.1	<i>Influence of Geotextile Fabrics on Infiltration Rate Capacity.....</i>	<i>41</i>
4.2	Winter Hydraulic Performance	41
4.3	Summary and Conclusions	41
Chapter 5	Maintenance and Related Issues.....	43
5.1	The Need for Maintenance to Prevent Clogging	43
5.2	Recommended Maintenance Frequency	44
5.3	Recommended Winter Sand and Salt Application.....	45
5.4	Summary and Conclusions	46
Chapter 6	Water Quality Benefits.....	47
6.1	Pollutants Generated from Permeable Pavements Itself.....	47
6.2	Physical, Chemical and Biological Characteristics of Subgrade Infiltrated Water.....	48
6.3	Summary and Conclusions	54
Chapter 7	Highway Shoulder Feasibility Studies	56
7.1	California Study.....	56

7.1.1	<i>Structural Performance</i>	56
7.1.2	<i>Hydrologic Performance</i>	57
7.1.3	<i>Clogging Simulation Performance</i>	58
7.1.4	<i>Life Cycle Cost Analysis</i>	59
7.2	NCHRP study	60
7.2.1	<i>Structural Design</i>	60
7.2.2	<i>Hydrologic Analysis</i>	60
7.2.3	<i>Maintenance and Related Activities</i>	61
7.2.4	<i>Feasibility Decision Matrix</i>	62
Chapter 8 Knowledge Gaps		63
8.1	Hydrologic Performance in Design	63
8.2	Structural integrity and construction	63
8.3	Cost and Effectiveness of Maintenance and Optimal Frequencies	64
8.4	Impact on Water Quality	65
8.5	Long-term performance evaluation	67
Chapter 9 Cold Climate Case Studies		70
9.1	State of Minnesota Experiences	70
9.1.1	<i>MnROAD Permeable Pavement Test Cells</i>	70
9.1.2	<i>Porous Asphalt Paired Intersections - Robbinsdale, MN</i>	85
9.1.3	<i>Woodbridge Neighborhood, Shoreview, MN</i>	94
9.1.4	<i>City of St. Paul</i>	100
9.1.5	<i>Ramsey Washington Metro Watershed District (RWMWD)</i>	103
9.2	Other States and Regional Experiences	104
9.2.1	<i>Denver, Colorado Experience</i>	104
9.2.2	<i>New Hampshire Experience</i>	116
9.2.3	<i>Washington King County Experience</i>	130
9.2.4	<i>Ontario, Canada, Experience</i>	132
References		140

Appendix A - Summary of Data Gaps and Research Study Suggestions Based on Research Area

Appendix B - Annotated Bibliography

List of Figures

Figure 2.1. Possible porous asphalt pavement cross-section as proposed by UNHSC (2009).....	4
Figure 2.2. Porous asphalt pavement cross-section presented by NAPA (2008).	4
Figure 2.3. Typical cross-section of pervious concrete pavement. Concrete surface layer is 15-25% voids, subbase is 20-40% voids, and subgrade is 5-20% voids (ACPA 2009).....	12
Figure 2.4. Typical cross-section of a permeable interlocking concrete paver system (Smith 2011).	22
Figure 2.5. Permeable articulated concrete block/mat A) installation and, B) completed project (Photos courtesy of University of Louisville and D. Buch, Pavedrain, LLC.).	27
Figure 2.6. Maintenance of permeable-articulated concrete block/mats with a Vac Head (Photo courtesy of University of Louisville and D. Buch, PaveDrain LLC.).	28
Figure 2.7. Permeable articulated concrete blocks/mats before (A) and after (B) cleaning with a Vac Head (Photo courtesy of University of Louisville and D. Buch, PaveDrain, LLC).....	29
Figure 3.1. One available design for using concrete pavers on sloped surfaces (ICPI 2011).	33
Figure 9.1. MnROAD test facility and cell locations. Cell 85 = pervious concrete on sand, cell 86 = porous asphalt on sand, , cell 87 = pervious controls, cell 88 = porous asphalt on clay, cell 89 = pervious concrete on clay, cell 39 = pervious concrete overlay. (Izevbekhai and Akkari 2011).	71
Figure 9.2. Cross-section of pervious concrete test cells (Izevbekhai and Akkari (2011)).	71
Figure 9.3. Average dissipated volumetric rates for pervious concrete cells over sand (cell 85) and clay (cell 89). Note: cell 39 is a porous overlay and not related to this review.	73
Figure 9.4. Change in dissipated volumetric rate (before and after second vacuuming) (Izevbekhai and Akkari (2011)).	75
Figure 9.5. Cross-section of porous asphalt pavements tested at MnROAD (Lebens and Troyer 2012).	78
Figure 9.6. Lowest flow measured at any porous asphalt test location (Lebens and Troyer 2012). Dashed, vertical lines correspond to dates the pavement surface was vacuumed.	79
Figure 9.7. Typical International Roughness Index values (Lebens and Troyer 2012).....	81
Figure 9.8. Average resilient moduli for final year of testing (Lebens and Troyer 2012).....	82
Figure 9.9. Porous asphalt study sites (Wenck 2014).	87
Figure 9.10. Test and control intersection locations. a) Site 1 on sand, b) Site 2 on clay (Wenck 2014).	88
Figure 9.11. Porous asphalt pavement cross-section (Wenck 2014).	89
Figure 9.12. Temperatures in porous pavement system at Site 1 (Wenck 2014).	91
Figure 9.13. Slush gathering and refreezing on the traditional asphalt at Site 1 on January 17, 2010 (Wenck 2014).....	92
Figure 9.14. Slush free porous asphalt on January 17, 2010 (Wenck 2014).	92
Figure 9.15. Saw cut joint in pervious concrete at Woodbridge neighborhood, Shoreview, MN (photo courtesy of M. Maloney, City of Shoreview).....	96
Figure 9.16. Dissipated volumetric rates of Shoreview, MN pervious concrete at various locations (Izevbekhai and Akkari 2011).	98

Figure 9.17. Change in dissipated volumetric rate of Shoreview, MN pervious concrete (Izevbekhai and Akkari 2011).	98
Figure 9.18. Typical cross-section in St. Paul alley project.....	101
Figure 9.19. Permeable paver cross section used on Victoria Street project.....	102
Figure 9.20. Aurora Wal-Mart pervious concrete parking lot in 2008 (photo courtesy of K. MacKenzie, UDFCD).	106
Figure 9.21. Denver Safeway pervious concrete parking lot in 2008 (photo courtesy of K. MacKenzie, UDFCD).	106
Figure 9.22. University Plaza pervious concrete parking lot in 2008 (photo courtesy of K. MacKenzie, UDFCD).	107
Figure 9.23. Pervious concrete parking lot at National Renewable Energy Lab in 2011. a) Deteriorated surface with loose aggregate, b) Close-up of parking stall (photos courtesy of K. MacKenzie, UDFCD).	110
Figure 9.24. Cross-section of porous asphalt pavement at the Denver Waste Management building (UDFCD 2011b).	111
Figure 9.25. Porous asphalt pavement at Denver Waste Management building after a light rain (photo courtesy of K. MacKenzie, UDFCD).	112
Figure 9.26. Pervious concrete at Lakewood City Shops maintenance building. AASHTO #67 mix is on the left and AASHTO #8 is on the right (UDFCD 2011a). A quarter is placed on the AASHTO #8 pavement for scale.	114
Figure 9.27. Recommended porous asphalt cross-section (UNHSC 2009).....	118
Figure 9.28. Comparison of porous asphalt and dense mix asphalt lot surface cover as a function of time. (a) PA lot at 11:20 a.m. and (b) PA lot 100 minutes later; (c) DMA lot at 11:20 a.m. and (d) DMA lot 100 minutes later (Roseen et al. 2014).	126
Figure 9.29. Typical PICP cross section (Roseen et al. 2013).....	127
Figure 9.30. Surface infiltration monitoring results (Roseen et al. 2013).	128
Figure 9.31. Pavement cross-section, a) Permeable interlocking concrete pavers, b) Pervious concrete (Drake 2013).....	133
Figure 9.32. Parking lot and permeable pavement cell schematic, ASH = conventional non-porous asphalt, AP = AquaPave pavers, EO = Eco-Optic pavers, PC = Pervious concrete (Drake 2013).	134

List of Tables

Table 2.1. Minimum recommended thickness of compacted asphalt layers (NAPA 2008).....	3
Table 2.2. Example open-graded asphalt mix (NAPA 2008). Application of mix sizes in the top row are provided in Table 2-3.....	6
Table 2.3. Potential applications for different open-graded mixes (NAPA 2008).	6
Table 2.4. Recommended aggregate gradations (UNHSC 2009).	7
Table 2.5. Recommend values of layer coefficient (NAPA 2008).	10
Table 2.6. Recommended minimum subbase and base thickness for PICP (Smith 2011).	24
Table 3.1. Pavement system selection guidance (InterPave 2010).	32
Table 9.1. Water sampling below pavement results compared to Minnesota Class 2 water quality standards (from Lebens and Troyer 2012).	80
Table 9.2. Aggregate gradation used in hot asphalt mix design.	101
Table 9.3. Maintenance activities recommended by UDFCD (2010).	113
Table 9.4. Water quality data for Lakewood Shops Maintenance building (UDFCD 2011a). Non-detect concentrations were assumed to be zero.	116
Table 9.5. Summary of hydrologic and water quality performance results from University of New Hampshire studies.	120
Table 9.6. Summary of maintenance strategies investigated and the related performance results from New Hampshire studies.....	123
Table 9.7. Surface infiltration statistics (Drake 2013).	135

Executive Summary

This document is an extensive review of full-depth permeable pavements including porous asphalt, pervious concrete, and permeable interlocking concrete pavers (PICP). Also included is a brief section on articulated concrete blocks/mats. The main topics, which have been divided into chapters, include structural and mix design, hydrologic design, hydraulic performance (i.e., infiltration capacity), maintenance needs/frequency/actions, the impact of permeable pavement on water quality, results of a highway shoulder feasibility study, knowledge gaps, and several cold climate case studies from the United States and Canada.

In general, a permeable pavement system consists of, from top to bottom, a surface layer of permeable pavement (i.e., asphalt, concrete, etc.), one or more layers of aggregate with void spaces as high as 40% that can store stormwater runoff until it infiltrates into the existing soil or is conveyed downstream by a drain tile. Variations in the number of layers, size and particle size distributions of aggregate, the presence of a geotextile fabric, and, of course, the top pavement layer are almost limitless. Although there can be a wide variation in pavement design, keys to a successful project almost always focus on proper construction and proper and regular maintenance.

When designing a permeable pavement two different designs are required. One design is for structural performance (i.e., pavement strength) and the other is for hydrologic performance (i.e., capacity to store the design rainfall event). With regard to structural design, there is not a standard design procedure that has been adopted across industries. Rather, each industry (i.e., porous asphalt, pervious concrete, etc.) has compiled existing information and incorporated it into its own industry-specific design process. For example, the American Concrete Paving Association (ACPA) uses a model called *PerviousPave*, which itself uses a concrete fatigue model developed for *StreetPave*. The National Asphalt Pavement Association (NAPA) uses the American Association of State Highway and Transportation Officials (AASHTO) design that incorporates a structural number for each layer of the permeable pavement system. ACPA recommends the use of a geosynthetic liner, whereas NAPA recommends a non-woven geotextile. In comparison, the structural design procedure used by the Interlocking Concrete Paving Institute (ICPI) also uses the AASHTO structural number method but its design procedures note that a geotextile fabric is optional.

Hydrologic design is more standard and is typically based on providing enough storage volume to temporarily store stormwater runoff from the design storm. The storage capacity of the entire permeable pavement system includes the capacity within the permeable pavement layer and the capacity within the base course, and it may also include underground storage tanks and/or above ground storage due to curbs.

With regard to hydraulic performance, the infiltration capacity of the permeable pavement top layer, although it decreases over time, is not typically the rate-limiting step. Infiltration rates are

typically limited by the infiltration rate into the existing sub-base. Some investigators have found that using a geotextile fabric between two layers within the pavement system can limit infiltration rates due to the collection of solids on the fabric that slows infiltration. Because of this, some authors recommend never using a geotextile fabric due to the risk of clogging. This same process, however, can improve the impact on water quality by increasing the amount of solid and solid-bound contaminants filtered by the system. If well constructed and maintained, permeable pavement systems can reduce peak runoff flow rates and runoff volumes. This is true even when installed over poorly draining soils, where runoff volumes were found to be reduced by 43%. It is also true throughout the winter, even in cold climates such as experienced in Minnesota, New Hampshire, and Canada, where infiltration rates have been found to be maintained year round. This is presumably due to air in the pavement system, which insulates the sub-base and prevents it from freezing.

Permeable pavement can improve the quality of stormwater runoff in large part due to the filtration of solids and solid-bound contaminants. The impact on dissolved contaminant removal, including phosphorus and nitrogen, is typically minimal. When focusing on contaminant total mass loads, permeable pavements can provide significant mass load reductions through infiltration and removal of the contaminant from the conveyance stream. In some cases contaminants may leach from materials within the pavement system and thereby degrade water quality. This effect is typically minimal after a year or two of operation. Finally, porous asphalt may improve water quality indirectly by allowing less salt application in winter months while maintaining the same levels of safety.

For a permeable pavement system to remain effective, regular maintenance is required. The major focus of maintenance is the removal of particles from the surface of the top pavement layer. Typically pressure washing with water and/or vacuuming has been found to be effective in at least partially restoring the infiltration capacity of the surface pavement. If, however, maintenance is not performed for extended periods of time, clogging may occur to such an extent that maintenance will be ineffective. Even with regular effective maintenance, the infiltration capacity of the permeable pavement layer will decrease due to clogging over time, but because infiltration capacity is initially orders of magnitude higher than other layers in the pavement system, it does not typically become the rate-limiting step.

Two feasibility studies regarding the use of permeable pavement for highway shoulders were reviewed. It was determined that, in most scenarios, full-depth permeable pavements for the shoulder retrofits are more cost-effective than currently practiced stormwater control measures. It was also determined that they can reduce negative environmental impacts.

Case studies on permeable pavement applications in cold climates provided several lessons learned. Comparative, three-year asphalt and concrete permeable pavement studies performed at MnRoad near St. Michael, Minnesota revealed a positive picture of porous asphalt and concrete pavements compared with conventional pavements, including resistance to loading, increased

skid resistance, and an increase in snow and ice melting rates. A paired asphalt intersection study in Robbinsdale, Minnesota indicated that unsalted permeable asphalt had similar performance to salted conventional asphalt and may be a viable alternative for reducing chloride loads to receiving water bodies. A pervious concrete installation in a residential subdivision in Shoreview, Minnesota has performed well over four years. Infiltration rates remain high and most areas have not experienced spalling, raveling, or other structural degradation. Raveling did occur near an entrance to the neighborhood that receives larger volumes of vehicular traffic than other areas of the neighborhood. A permeable asphalt parking lot at the Ramsey Washington Metro Watershed District office in Little Canada, Minnesota has performed well over 10 years. Some surface spalling occurred during the first summer of operation in the traffic lanes, but little has occurred since. Regenerative air sweeping without brushes is recommended for maintenance of the pavement's infiltration rate, because most of the clogging occurred in the upper quarter inch of the pavement. Case studies located outside of Minnesota include the greater Denver region, where four permeable concrete installations in 2004/2005 and one permeable asphalt installation in 2008 were documented. The experience gained was not positive, as most installations generally failed to perform according to their structural, hydrological, and water quality performance evaluation. Many of the failures were found to be related to mix design and construction methods. The University of New Hampshire Stormwater Center studied the application of permeable asphalt and permeable interlocking concrete pavers on parking lots, and compared both with traditional asphalt. When the entire permeable asphalt lot received 25% of the salt application of the traditional asphalt lot, there was no significant difference between the snow and ice cover on the two lots. Other experiences documented in Ontario, Canada, (permeable interlocking concrete pavers and pervious concrete) and a summary of concerns expressed by King County, Washington, regarding the use of permeable pavement are also summarized.

While progress has recently been made with the relatively new permeable pavement technology, researchers have also identified many unresolved issues that are not well understood. These include the following:

- A methodology to measure subgrade infiltration rates. This is an important design consideration because subgrade soils that will not infiltrate water at a prescribed rate or higher can significantly reduce the effectiveness of the permeable pavement system.
- Filling data gaps related to structural integrity, construction, and related issues associated with permeable pavements, including the effect of using various aggregates and other mix designs on the properties of pervious pavement, development methods to further increase the strength of pervious pavement, the amount of compaction energy input to pervious pavement and its impact on the strength, unit weight, permeability, and resistance to freeze-thaw cycling, and determination of standards for creating joints in pervious concrete.

- Determining what maintenance activities are most effective on various pavement types and how frequently specific maintenance actions should be performed to optimize performance and minimize costs.
- A better understanding of the processes involved in the observed reduction of contaminant concentrations in stormwater flowing through permeable pavements.
- A better understanding of the performance of permeable pavements over a time frame that better corresponds with a lifespan of 20 years.

Chapter 1 Introduction

1.1 Background

The term permeable pavement generally refers to a type of pavement that has several permeable layers and has the ability to store stormwater until it infiltrates through the subgrade soil. Depending on the type of surface pavement, permeable pavement can be referred to as porous asphalt, pervious concrete, or interlocking concrete pavers. Permeable pavements have the ability to reduce runoff volume and improve water quality. For this reason, many communities are now exploring their use as an alternative low impact development (LID) design for stormwater control measures (SCMs). The use of permeable pavements in practice, however, occurs under various hydrological and climatic conditions and is in the early development stage. There are many components to the permeable pavement system. These include the physical and structural stability of surface pavement, the ability to handle traffic speed and loads, the storage volume and aggregate depth beneath the pavement surface, the ability of the subgrade soil to infiltrate water, and maintenance requirements needed to maintain functionality. The quality of the permeable pavement system is highly dependent on the design specifications and construction practices used, as well as the maintenance practices.

At present, several leading industries have developed brief guidance documents for the design and implementation of permeable pavements based on surface pavement type. Design and construction of permeable pavement, regardless of the type of surface pavement, require structural and hydrologic analysis and both requirements should be satisfied in order for pavement to function properly. Generally, the structural design of the pavement is performed to determine the thickness of the aggregate depths that are necessary to support the intended design traffic while protecting the subgrade from permanent deformation. The hydrological design is performed to infiltrate rainwater and surface runoff through the pavement and hold and/or detain and filter the water to achieve the stormwater management objectives. An optimal permeable pavement design is one that is just strong enough to accommodate the design traffic activity and has the minimum porosity necessary to provide water quantity management (Smith 2011). Further consideration should be given to the ease and cost of maintenance.

While major progress has been made during the past ten years on the application of permeable pavements in parking lots and other commercial areas with low speed and light load traffic, there are still numerous other issues related to structural design, water quality, surface clogging and required maintenance that must be addressed before permeable pavements are fully implemented on local road and highway systems with higher speeds and heavier loads. Although research is continuing, it is in the embryonic stage and design standards and recommendations are continually under development and revision for all pavement industries.

1.2 Focus of this report

Several tasks are associated with the Minnesota Permeable Pavement Guidance Document that will be accomplished under four stages. The first stage was to perform a literature review on the implementation of permeable pavements; the second stage was related to the identification of data gaps, the third stage was related to developing a decision matrix for construction and implementation, and the fourth stage was related to preparing the final guidance document report. This document, which is intended to complete the first stage of the project that related to completing the literature review, is divided into two volumes. Volume 1, which is the focus of the current report, presents a summary of findings that have been organized in eight chapters with the following topics:

1. Introduction,
2. Typical Mix Design, Cross Section Layers and Structural Design,
3. Hydrologic Design,
4. Hydraulic Performance,
5. Maintenance and Related Issues
6. Water Quality Benefits,
7. Highway Shoulder Feasibility Studies,
8. Knowledge Gaps and
9. Cold Climate Case Studies.

Appendix A lists a summary of knowledge gaps and Appendix B is an annotated bibliography.

Chapter 2 Typical Mix Design, Cross Section Layers and Structural Design

Typically, in permeable pavement design there are two separate designs performed. One design is for structural performance and the other is for hydrologic performance. The more conservative of the two designs governs. At present, no specific standard design is available to cover the structural design aspects of all permeable pavements. Generally, each industry has tried to compile available existing information and used it for design of specific pavement. In addition, several different aggregate mix designs or cross sectional layer thicknesses have been suggested by each pavement industry. For this reason, this chapter summarizes the typical aggregate mix and cross section design and structural design process suggested by the three leading permeable pavement industries; namely asphalt, concrete and interlocking concrete pavers.

2.1 Porous Asphalt Pavement

2.1.1 Typical Cross Section Design

The National Asphalt Pavement Association (NAPA 2008) presents design and construction guidelines for porous asphalt pavements. A typical cross-section consists of the porous asphalt layer on top, a choker coarse, a stone subbase recharge bed, a non-woven geotextile fabric and uncompacted subgrade. NAPA (2008) recommended values for minimum compacted thickness of the asphalt surface are given in Table 2-1.

Table 2.1. Minimum recommended thickness of compacted asphalt layers (NAPA 2008).

Traffic Loading	Minimum Compacted Thickness (in)
Parking (little or no truck)	2.5
Residential trucks (some trucks)	4.0
Heavy Truck	6.0

A study conducted by the University of New Hampshire Stormwater Center (UNHSC 2009) included a discussion of the structural layers in the pavement system. UNHSC recommended that below the porous asphalt layer there should be a 4 to 8 inch choker layer of crushed stone (8 inches is preferred due to compaction issues with the porous asphalt), an 8 to 12 inch filter course layer of poorly graded sand, a 3 inch (minimum thickness) filter blanket (i.e. pea gravel), and a reservoir of course, crushed stone. This layering is shown schematically in Figure 2-1. The

optional bottom liner is recommended only for aquifer protection or to eliminate infiltration. A simpler cross-section that has been recommended by NAPA (2008) is shown in Figure 2-2.

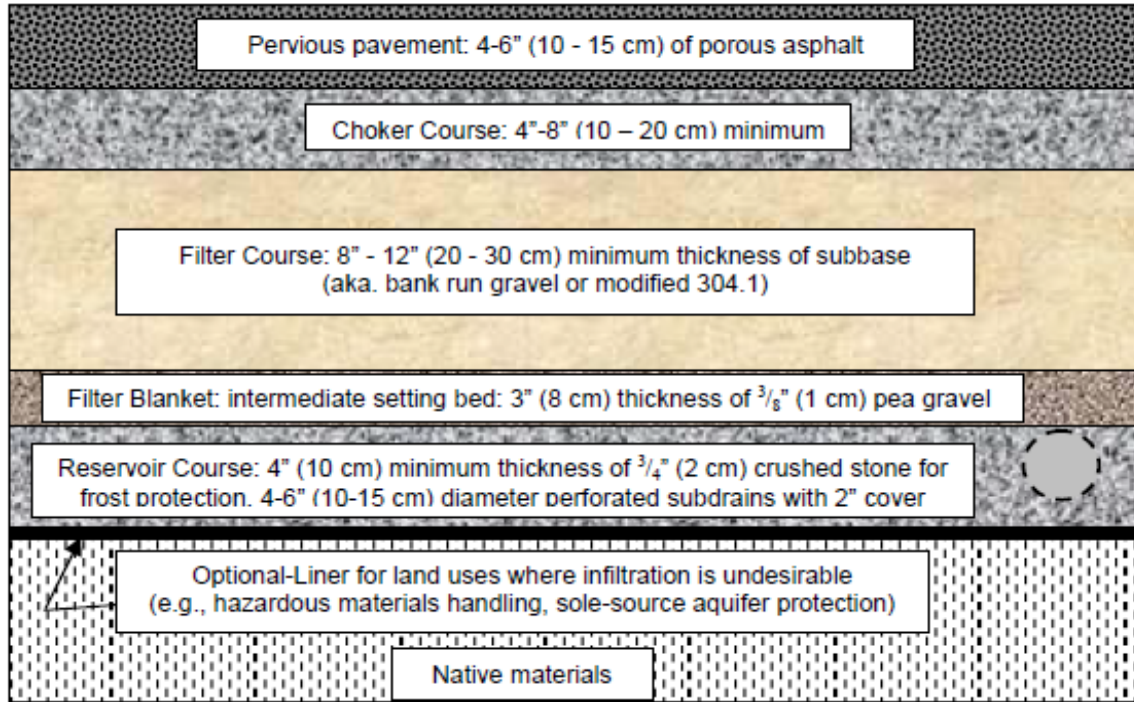

Figure 2.1. Possible porous asphalt pavement cross-section as proposed by UNHSC (2009).

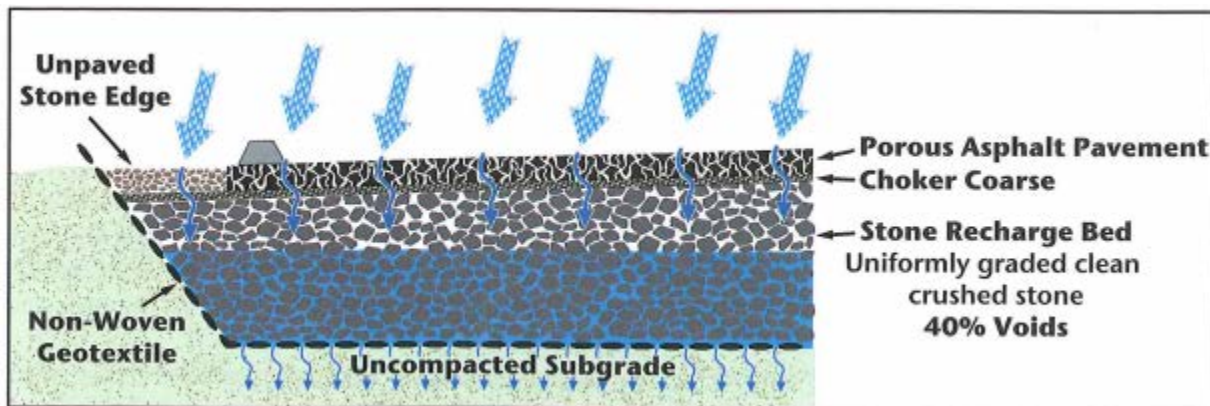

Figure 2.2. Porous asphalt pavement cross-section presented by NAPA (2008).

The asphalt mix typically consists of polymer-modified asphalt and sometimes includes fibers. The polymers and fibers help to reduce draindown and the polymers help to improve resistance to scuffing at high temperatures. The term “draindown” refers to the phenomenon in which pavement infiltration capacity reduces over time. It is often desired to reduce the draindown of porous asphalt by material modification such as adding polymers.

With regards to asphalt mix design, NAPA (2008) referred to some other NAPA documents on open graded friction courses (OGFC) but, because OGFCs are only a surface layer and not part of a full-depth porous asphalt system, those documents are not reviewed in this report. It is recommended to follow local DOT requirements and specifications and if there are none for the asphalt treated permeable base, the following properties should be met:

1. Sixteen percent minimum air voids,
2. An asphalt content of 5.75% by weight of the total mix,
3. Draindown of 0.3% maximum (in accordance with ASTM D6390-05),
4. To address moisture susceptibility, follow the approach used for dense mixes using the same aggregate and asphalt.

As an example of mix gradations, the Oregon DOT specifications are given and reproduced in Table 2-2. Also shown are potential applications for different open-graded mixes in Table 2-3.

Table 2.2. Example open-graded asphalt mix (NAPA 2008). Application of mix sizes in the top row are provided in Table 2-3.

Sieve	NAPA IS-115 (NAPA 2002)	3/8 inch* NMAS	Oregon DOT Specifications		
			1/2 inch NMAS	3/4 inch NMAS	ATPB
Percent Passing					
1" (25 mm)				99-100	99-100
0.75" (19 mm)	100	-	99-100	85-96	85-95
0.5" (12.5 mm)	85-100	99-100	90-98	55-71	35-65
0.375" (9.5 mm)	55-75	90-100	-	-	-
#4 (4.75 mm)	10-25	22-40	18-32	10-24	2-10
#8 (2.36 mm)	5-10	5-15	3-15	6-16	0-5
#200 (0.075 mm)	2-4	1-5	1-5	1-6	0-2

ATPB = Asphalt Treated Permeable Base

NMAS = Nominal Maximum Agregate Size

* From Asphalt Pavement Association of Oregon

Table 2.3. Potential applications for different open-graded mixes (NAPA 2008).

Mix Size	Application	Layer Thickness
0.375" (9.5 mm) Open Graded	Parking/Recreational Facilities	1.5 - 3.5 inches
1/2" (12.5 mm) Open Graded	Wearing Surface, Roads, Streets, Heavy Commercial	2.0 - 4.0 inches
0.75" (19 mm) Open Graded	Wearing Surface, Roads, Heavy Commercial	2.0 - 5.0 inches
0.75" (19 mm) ATPB	Base Course	3.0 - 6.0 inches

A study conducted by Jones et al. (2010) and Li et al. (2012) included testing different mix designs and aggregate gradations for permeability, moisture sensitivity, rutting resistance, raveling resistance, fatigue cracking resistance, and flexural stiffness. Furthermore, in the modeling portion of the research, results of strain calculations in asphalt were used to estimate

the thickness required to ensure the layer didn't fail due to fatigue. The following three types of porous asphalt were investigated: 1) 9.5 mm thick layer with conventional binders, 2) 9.5 mm thick layer with rubberized binders, and 3) 12.5 mm thick layer with polymer-modified asphalt, fibers, and lime.

Results specific to porous asphalt included:

1. Particle size distribution and the binder type are the two most important factors for selecting an appropriate mix,
2. Most hot-mix asphalts tested had sufficient permeability,
3. Rutting of the surface appeared to be a problem for a mix with conventional binder and one with a rubberized binder. Most of the mixes tested had sufficient resistance to raveling as compared to a dense-graded control.

In addition, the University of New Hampshire Stormwater Center (2009) provided recommended aggregate gradations, given in Table 2-4. Additional details related to these and additional topics such as the porous asphalt mix are given in UNHSC (2009).

Table 2.4. Recommended aggregate gradations (UNHSC 2009).

US Standard Sieve Size Inches/mm	Percent Passing (%)			
	Choker Course (AASHTO No. 57)	Filter Course (Modified NHDOT 304.1)	Reservoir Course (AASHTO No. 3)	Reservoir Course Alternative* (AASHTO No. 5)
6/150	-	100	-	
2½/63	-		100	-
2 /50	-		90 – 100	-
1½/37.5	100		35 – 70	100
1/25	95 - 100		0 – 15	90 – 100
¾/19	-		-	20 - 55
½/12.5	25 - 60		0 - 5	0 - 10
3/8/9.5	-		-	0 - 5
#4/4.75	0 - 10	70-100	-	
#8/2.36	0 - 5		-	
#200/0.075		0 – 6**		
% Compaction ASTM D698 / AASHTO T99	95	95	95	95

* Alternate gradations (e.g. AASHTO No. 5) may be accepted upon Engineer's approval.

** Preferably less than 4% fines

A study by Partl et al. (2003) focused on aggregate used in porous asphalt. Partl et al. (2003) reported that, by optimizing the gap in aggregate, a void ratio greater than 25% and an infiltration rate of at least 7 cm/s are possible.

Reports reviewed in NAPA (2008) indicated that untreated free-draining aggregate base properties are appropriate to use for porous asphalt stone recharge bed properties. NAPA (2008) acknowledges that it is not uncommon to recommend that the bottom of the recharge subbase be placed below the depth of winter frost penetration, but this practice has come into question recently due to successful installations that did not follow this practice. A University of New Hampshire publication recommended that the depth of bed be 65% of the frost depth (UNHSC 2009).

The aggregate used for the recharge bed should be clean, crushed stone with little to no fines and a minimum void ratio of 40%. Typically, AASHTO No. 3 stone is specified but AASHTO No. 1 or 2 stones have also been used. If AASHTO No. 3 is used for the recharge bed it has been found that AASHTO No. 57 works well for the choker course. If a different size stone is used for the recharge bed, the choker coarse size must be adjusted accordingly. To prevent fines from entering the subbase, non-woven geotextile filter fabric is typically placed between the subgrade layer and underlying soil. Finally, the subgrade is uncompacted to allow for infiltration.

2.1.2 Structural Design

The American Association of State Highway and Transportation Officials (AASHTO) structural design guidelines for flexible pavements are often used for the design of porous asphalt and permeable interlocking concrete pavement (AASHTO 1993). The AASHTO pavement structural design method is summarized using the following equation:

$$\text{Log } W = Z_R \times S_0 + 9.36 \times \log(\text{SN} + 1) - 0.02 + \frac{\log \left[\frac{P_i - P_t}{P_i - 1.5} \right]}{0.4 + \frac{1094}{(\text{SN} + 1)^{5.19}}} + 2.32 \times \log(M_R) - 8.07 \quad 2-1$$

where W = design traffic load in equivalent single axle loads (ESALs), Z_R = standard normal deviation associated with reliability level \mathcal{R} , S_0 = standard deviation, SN = structural number of the pavement, where $\text{SN} = \sum a_i d_i$, a_i = structural layer coefficient, d_i = layer thickness, P_i = initial serviceability, P_t = terminal serviceability, and M_R = subgrade resilient modulus.

All parameters assume Imperial (i.e. non-SI) units. These parameters can be explained further. To begin, the AASHTO design procedure characterizes traffic loads in terms of Equivalent Single Axle Loads (ESALs). One ESAL is represented as the application of a single 80 kN (18,000 lb) axle load. Permeable pavements in North America have typically been designed for applications not exceeding about 1 million ESALs (Smith 2011). Design procedures have

recently been developed in Europe that accommodates ESAL loadings of 10 million (Interpave 2010). Highway pavements are typically designed for ESAL loading on the order of 5 to 100 million ESALs. Shoulders, however, receive much less traffic unless they are utilized, for example, for expanded capacity during rush hour. A typical shoulder pavement would be exposed to much fewer than 100,000 ESALs during its design life. It should be noted that procedures used by a particular agency to calculate ESALs will be required. This may include differences in the calculation of ESALs for flexible and rigid pavements.

The design reliability level (\mathcal{R} , which can be considered as a factor of safety) is the reliability level selected by the designer to take into account the probability that the pavement, as designed, may not provide satisfactory service during the intended period of service. The increase in the design reliability level results in more substantial (stronger) pavement with a higher probability that the pavement will perform as designed. For the AASHTO design procedure, the higher the selected reliability and standard deviation, the higher the design ESALs used in the design and the thicker the pavement design for a specified loading. Critical facilities are typically assigned reliability factors of 95 percent or higher. Low traffic volume roadways and less critical facilities may be assigned reliability values of 75 percent or less. For permeable shoulder pavements, a reliability factor in the order of 80 percent ($Z_R = -0.841$) would be considered appropriate. This represents a low-to-medium level of reliability.

The overall standard deviation (S_0) takes into account the variability associated with design and construction inputs, including variability and material properties, subgrade, traffic, and environmental exposure. Other factors that contribute to the overall standard deviation include lack-of-fit of the AASHTO model and replicate section errors (errors due to other unaccounted factors). For shoulder pavements, a standard deviation of 0.44 ft is appropriate for flexible pavements and pavers and 0.34 feet for rigid pavements.

The Structural Number (SN) of the pavement is a dimensionless value that represents the “strength” of a pavement section. It is determined by multiplying the thickness of a pavement layer (d_i) by its layer coefficient (a_i) which is a representation of the strength of the layer and then summing this value for all layers. The higher the SN, the stronger the pavement section.

The layer coefficient (a_i) is a measure of the strength of an individual layer. This value typically ranges from about 0.06 for subbase layers to 0.44 for bound layers such as asphalt concrete layers. NAPA (2008) recommended values for layer coefficients of the porous asphalt surface and bases are given in Table 2-5. In Oregon the DOT design guide calls for layer coefficients to be 0.42 for open-graded mixes and 0.24 for asphalt treated permeable base (ATPB). In Vermont the recommended value is 0.33 for the layer coefficient of ATPB.

Other studies, however, recommended lower layer coefficient values for permeable pavement layers. Porous asphalt concrete is produced by modifying the aggregate gradation to permit water to flow through the pavement. In doing so, the strength of the layer is reduced. As such,

Hein et al. (2013a) recommended a lower layer coefficient for porous asphalt as compared the previously mentioned recommendations. The recommended value by Hein et al. (2013a) is in the range of 0.2 to 0.3 (Hein et al. 2013a). A similar reduction applies to open graded base and subbase layers (Hein et al. 2013a). One study in Oregon found ATPB layer coefficients to be between 0.14 and 0.19, whereas six other states use values of between 0.20 and 0.30, and ten states assign values to be equivalent to aggregate base values (NAPA 2008). Hein et al. (2013a) recommended layer coefficient for open graded aggregate base to be between 0.06 and 0.09, which is again lower than most other recommended values.

Table 2.5. Recommend values of layer coefficient (NAPA 2008).

Material	Layer Coefficient
Porous Asphalt	0.4 – 0.42
Asphalt Treated Permeable Base (ATPB)	0.3 – 0.35
Porous Aggregate Base	0.1 – 0.14

P_i is the initial serviceability of the as-constructed pavement. For the design of both flexible and rigid pavements, the AASHTO Guide (1993) uses present serviceability index (PSI). This index was developed through regressions between slope variance measurements, key distress types (rutting, alligator cracking, and patching for flexible pavements and cracking and patching for rigid pavements), and subjective present serviceability ratings (PSR). The index, like PSR, is based on a scale of zero to five, with zero representing a completely failed pavement and five representing a perfectly even and unblemished pavement. The initial serviceability of a new highway pavement would typically range from about 4.1 to 4.5. An initial serviceability of 4.2 would be considered reasonable for a shoulder pavement.

P_t is the terminal serviceability of the pavement or the point in time at which rehabilitation of the pavement would be considered necessary to keep it in a serviceable condition. The terminal serviceability is typically higher for more important pavement sections such as interstate highways that are subjected to more frequent traffic. Terminal serviceability for highway lanes is typically between 2.2 and 3.2. A value of 2.5 would be considered reasonable for shoulder pavements.

The characterization of subgrade soils (M_R) is one of the most challenging parts of pavement design. Subgrade soil consists of native soil left after the removal of the existing overlying material, as well as soils used as earth borrow to construct embankment fills or to replace existing unsuitable soils. The objective of the subgrade construction is to provide a uniform foundation for the pavement structure. The ability of subgrade soil to support a pavement structure is characterized by its laboratory-determined M_R . The design modulus used in the

AASHTO design (1993) is based on the support capability determined after the subgrade material has been ‘soaked’ for 96 hours (i.e. saturated). The AASHTO design equation is very sensitive to this input. The common approach in providing guidance in the selection of resilient modulus is to group soil types into common categories and assign typical M_R values to each category. The selection of an appropriate design value for M_R depends on a number of factors and a suitably qualified geotechnical engineer should be consulted for its determination. In general, coarse grained soils such as sands and gravels have higher M_R values than fine grained soils such as silts and clays. As such, the required pavement thickness for a given traffic level is higher for fine grained soils.

The characterization of the subgrade is not only for structural design purposes. It is also important if one of the goals of the permeable pavement design is to infiltrate water into the subgrade. It is important to establish the relationship between soil permeability and in-situ soil density achieved during construction. This is important to establish a relationship between subgrade infiltration capability and the structural capacity necessary to support the design traffic. For example, a resilient modulus determined at a soil compaction level of 95% of the standard Proctor maximum dry density will have lower infiltration capacity and higher structural capacity than a resilient modulus determined at a soil compaction level of 90%. Further, in the event that the field density is less than the design density, it may be necessary to decrease the design resilient modulus, which decreases the structural capacity especially when the soil is saturated, requiring a thicker pavement structure.

It should be noted that some of the current permeable pavement design documents require that, to promote infiltration, the subgrade not be compacted. This would be very difficult to achieve in a highway construction environment as a uniform subgrade cross-section is desirable to provide lateral drainage and it would be very difficult to control the movement of construction equipment, which would tend to compact the subgrade during construction operations. This would tend to cause lateral flow out of the system rather than downward vertical flow into the subgrade. A geotechnical engineer should be consulted for further detailed information.

One structural application that was evaluated by NAPA (2008) was a roadway constructed by the Arizona DOT in Chandler, AZ. The roadway consisted of 6 inches of open-graded asphalt on top of 6 inches of asphalt-treated permeable base (ATPB), which was placed on top of 8 inches of open-graded subbase that acted as the storage reservoir. The pavement was designed with structural coefficients of 0.40 for the open-graded surface, 0.20 for the ATPB and 0.11 for the open-graded subbase. The resilient modulus of pavement cores was determined to be 180 ksi for the open-graded asphalt and 560 ksi for the dense-graded asphalt. In 2008, 22 years after it was constructed, the pavement was still functioning well.

2.2 Pervious Concrete Pavement

2.2.1. Typical Aggregate Mix and Cross Section Design

The American Concrete Pavement Association (ACPA) gives a general overview of using pervious concrete pavement for stormwater management (ACPA 2009). Pervious concrete is described as a mix of "specially formulated hydraulic cementitious materials, water, and uniform open-graded coarse aggregate (e.g., ASTM C33 Size numbers 5, 56, 67, 8, and 89)," which, when designed and installed properly, has a void space of 15% or more. It is suggested that pervious concrete has potential applications around buildings, in parking lots, low volume roads, and on highway shoulders and medians. A typical cross-section is given in Figure 2-3 in which the subbase is a stone reservoir that can store a finite volume of water. Drain tiles (not shown) can be added below the pavement to convey water downstream in the stormwater management system.

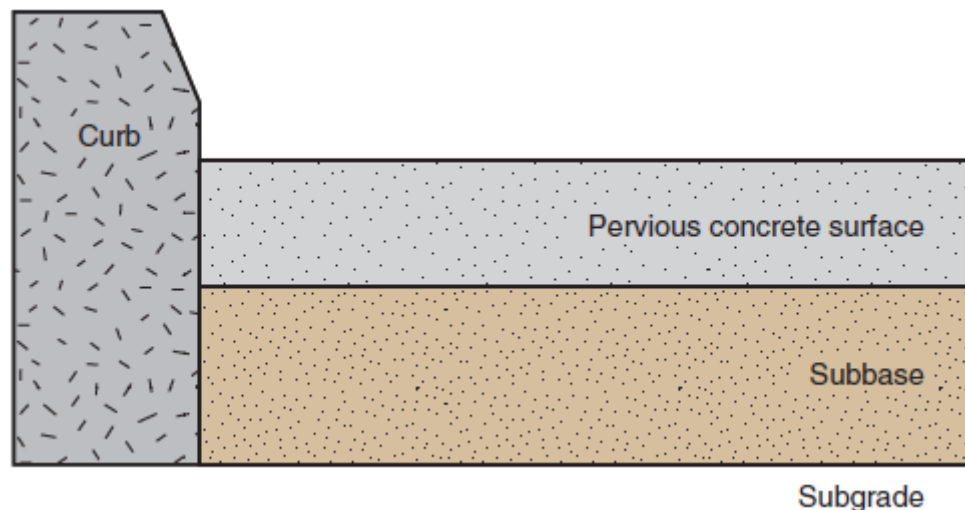

Figure 2.3. Typical cross-section of pervious concrete pavement. Concrete surface layer is 15-25% voids, subbase is 20-40% voids, and subgrade is 5-20% voids (ACPA 2009).

The American Concrete Institute (ACI) states that aggregate is typically single sized or course aggregate between 3/8 inch and 3/4 inch and all aggregates should meet ASTM D448 and C33/C33M (ACI 2010). Rounded and crushed aggregate, both normal and lightweight have been used but flaky or elongated aggregate should not be used. Aggregates should also be hard, clean, and have no coating. Portland cement conforming to ASTM C150/C150M, C595/C595M, or C1157/C1157M should be used as the main binder with supplementary materials such as fly ash, blast-furnace slag, and silica fume being acceptable, although Kevern et al. (2008) recommended that fly ash use be restricted to 10% and silica fume to 5% replacement. Water-to-cement ratios should be low and typically range from 0.26 to 0.40; Kevern et al. (2008) specifically targeted 0.32 to improve workability and density. If the water content is too high the paste may drain and

clog the pore system. Finally, water-reducing, retarding, accelerators, and air-entraining admixtures can be used but should meet all relevant requirements and ASTM standards.

Typical mix proportions for pervious concrete are 450 to 700 lb/yd³ of cementitious materials and 2000 to 2500 lb/yd³ of aggregate, at a water:cement ratio of 0.27 to 0.34, aggregate:cement ratio of 4 to 4.5:1, and a fine:coarse aggregate ratio of zero to 1:1 (Tennis et al. 2004). ACI (2010) suggested repeated trial-and-error efforts that involve developing different mix proportions under laboratory settings and testing them in the field until the desired behavior is achieved. Overall, the goal would be to obtain a balance between voids, strength, paste content, and workability. With regards to concrete strength, ACI (2010) made some general comments but provided no specific design details. For more information on trial batch proportioning, the reader is referred to ACI (2010), which describes various methods, and Sonbei and Bassuoni (2013), which used statistical modeling to estimate the impact of design variables on resulting density, void ratio, infiltration rate, and compressive strength.

The Colorado Ready Mixed Concrete Association (CRMCA 2009) recommended that coarse aggregate conform to ASTM C33 and fine aggregate complying with ASTM C33 make up 4% to 8% of the total aggregate weight. The combined coarse and fine aggregates shall have at least 10% passing the #4 sieve. The document noted that research has suggested that additional sand increases resistance to freeze-thaw cycles, durability, and strength while maintaining enough infiltration capacity; this result is supported by observations made in Henderson and Tighe (2012). Furthermore, CRMCA recommended that the mixture have a density of 105 lb/ft³ to 130 lb/ft³ and should conform to ASTM C29. The void content should be from 15% to 25%, the water to cement ratio shall be 0.26 to 0.35, and the cementitious content shall be from 450 lb/yd³ to 550 lb/yd³. The document also gave other specifications related to admixtures, fly ash, placing and finishing, curing, etc.

It should be noted that there have been more innovative approaches to pervious concrete mix designs that featured the use of supplementary cementitious materials and recycled aggregates. This work included studies by Ravindrarajah and Yukari (2010) and Sata et al. (2013). Ravindrarajah and Yukari (2010) examined the use of high-levels of fly ash to replace cement in pervious concrete and recommended that measures be taken to insure that adequate strength levels are preserved if high levels of fly ash (as much as 50%) are used. Likewise, Sata et al. (2013) found that the use of a geopolymer concrete as a basis for pervious pavement could be used, but steps should be taken to account for significantly lower strength than would be present using conventional concretes.

Several studies have investigated pervious concrete properties, and some of them have been reviewed in ACI (2010) recommendations. These studies, however, are not all conclusive and cannot be solely used to design mixes. Rather they show general trends. For example, a study by Meininger (1988) showed a drop in compressive strength from over 5000 psi at an air content between 5% and 10% to just over 1000 psi at an air content between 25% and 30%. Flexural

strength can range from 150 to 550 psi (Tennis et al. 2004). Results cannot be applied universally, however, because the tests only investigated two aggregate sizes at a range of aggregate gradations and compaction efforts but did not investigate the impact of a host of other variables. Other summaries showed an increase in compressive strength with unit weight (Mulligan 2005), a drop in air content with an increase in water:cement ratio (Meininger 1988), a drop in flexural strength with an increase in air content (Meininger 1988), and an increase in flexural strength with an increase in compressive strength (Meininger 1988).

Crouch et al. (undated) investigated three gradations of crushed limestone and two gradations of gravel in the laboratory to determine the impact of the aggregate and the compaction effort on the compressive strength of pervious concrete. Four field samples were also obtained and tested. The following conclusions were reached:

1. For a constant paste amount and character, effective air void content appeared to be a function of three factors: 1) compactive effort, 2) aggregate particle shape and surface texture, and 3) aggregate uniformity coefficient. Smoother and rounder aggregates, for the same compactive effort, resulted in lower voids and void content decreased as the uniformity coefficient increased,
2. For a consistent paste amount and character, the compressive strength of pervious concrete appeared to be a function of 1) effective air void content, and 2) gradation fineness modulus. As void content and aggregate fineness modulus increased the compressive strength decreased,
3. A low cementitious content, a uniform aggregate gradation, and high compactive effort can produce pervious concrete with permeability values higher than 142 in/hr and compressive strengths greater than 3000 psi.

The freeze-thaw durability of pervious concrete can be a major factor in its overall performance, especially given that studies such as Kevern et al. (2009) on the thermal profile of pervious concrete pavements have found that pervious pavements can demonstrate a more rapid heating and cooling cycle as compared to traditional concrete pavements. Schaefer et al. (2006) investigated various mix designs in order to develop a pervious concrete mix with sufficient infiltration capacity, strength, and freeze-thaw durability. Various concrete mixes with different sizes and types of aggregate, binder content, and admixtures were investigated and evaluated. Aggregates of river gravel and crushed limestone were also investigated. River gravel sizes were 0.5 inch, 0.375 inch, and no. 4 size (100% passing the 0.375 inch sieve and 100% retained on the no. 4 sieve). Crushed limestone (0.375 inch) and pea gravel were also included in the research. Schaefer et al. (2006) measured the porosity, permeability, strength, and freeze-thaw durability of all the mixes that were investigated. The following results/conclusions were obtained:

1. Mixes with only a single size aggregate have high permeability but insufficient strength,

2. Addition of a small fraction of sand to the mix increased strength and freeze-thaw resistance. It also lowered permeability,
3. Adding sand and latex to the mix increased strength (compared to mixes with a single sized aggregate) but mixes in which only sand was added had a higher strength,
4. Mixes with a small percentage of sand showed 2% mass loss after 300 freeze-thaw cycles,
5. Low compaction reduced compressive strength, split strength, and unit weight but increased permeability,
6. A binder to aggregate ratio of 0.21 and a water:cement ratio of 0.27 was determined to be the optimum in terms of strength, permeability, and void ratio,
7. In terms of seven-day strength, the optimum latex content was determined to be 10%,
8. Mixes with larger aggregate size had higher void ratios,
9. Aggregate with higher abrasion resistance resulted in high strength concrete,
10. The compressive strength and unit weight decreased linearly as the void ratio increased,
11. Permeability increased exponentially as the void ratio increased, with a rapid increase in permeability at void ratios greater than 25%,
12. At regular compaction energy, mixes with void ratios between 15% and 19% had seven-day compressive strengths ranging from 3,300 to 2,900 psi, permeabilities ranging from 135 to 240 in/hr, and unit weights from 127 to 132 pcf. The split strength was about 12% of the compressive strength,
13. A mass loss of about 15% indicated a terminal serviceability for a pavement.

Yang et al. (2006) expanded on the durability study conducted by Schaefer et al. (2006) to examine the influence of moisture conditions on freeze-thaw durability, with a positive correlation between saturation levels during curing and freeze-thaw durability. In a laboratory study simulating field conditions on pervious concrete specimens, Yang (2011) found that the inclusion of polypropylene fibers increased durability and that the application of salt to specimens decreased durability.

A recent laboratory test conducted by UCPRC (Jones et al. 2010, Li et al. 2012) found a clear relationship between aggregate grading, cement content, water-to-cement ratio, and strength and permeability. All specimens tested exceeded permeability requirements, suggesting that adjustments can be made to optimize mixes while still maintaining adequate permeability.

ACI (2010) reported that void content is highly dependent on aggregate gradation, cementitious material content, water:cement ratio, and compactive effort. It is also stated that a range of porosities can be achieved by blending two different size aggregates. If this is done, however, the larger aggregate should be less than ~2.5 times the size of the smaller aggregate or else the smaller aggregate may fill in the voids and reduce permeability.

The pore size in pervious concrete is also an important parameter as it affects properties such as permeability and sound adsorption. Larger sized aggregate produced larger pores and increased

permeability. Pore structure also impacted pervious concrete properties. Low et al. (2008) determined that aggregate size, aggregate-cement (A/C) ratio, and water-cement ratio greatly impacted pore structure. In addition, percolation rate (or permeability) is directly related to the porosity and the pore size of pervious concrete. It has been reported (Meininger 1988) that a porosity of 15% is required to achieve a permeability of 1 cm/s.

Tests have shown that entraining air in the cement paste can improve durability. Wanielista and Chopra (2007a) also determined other relationships such as unit weight as a function of strength and porosity and permeability as a function of A/C ratio, among others. Wanielista and Chopra (2007a) also investigated existing pervious concrete systems to gather information regarding long-term performance and vitality. Wanielista and Chopra (2007a) reached the following conclusions:

1. An A/C ratio less than 5 in combination with a water:cement ratio from 0.35 to 0.39 resulted in the highest compressive strength without jeopardizing permeability,
2. Higher A/C ratios did not have enough cement,
3. Higher water:cement ratios eliminated void spaces,
4. The energy applied to the pervious concrete was 1,544 kN-m/m³ (modified Proctor). Higher compaction energy did not reduce permeability but it increased compressive strength,
5. The compressive strengths obtained would support traffic loads up to 40 tons.

Toughness, as measured by ASTM C1399, can be improved by adding synthetic fibers. One study (SI Concrete Systems 2002) found that fibers 1.5 to 2.0 inches in length were most effective in increasing toughness. Shrinkage, which is typically around 200×10^{-6} , is about one-half of what typically occurs in conventional concrete (Tennis et al. 2004).

For quality control, Tennis et al. (2004) recommend using unit weight or bulk density because other properties, such as slump and cylinder strength tests, don't have much meaning for pervious concrete. Strengths are a function of void content and placement methods and it's difficult to accurately represent field placement in a cylinder test. Unit weights are expected to be 70% of traditional concrete mixes.

The voids in pervious concrete can provide freeze-thaw resistance if these voids drain before freezing. Air entrained in the paste can also improve freeze-thaw resistance. Placing the pervious concrete over at least 6 inches of drainable rock base is recommended in freeze-thaw environments (Tennis et al. 2004).

Laboratory tests were performed by Wanielista and Chopra (2007a) who investigated the effect of varying components of pervious concrete on strength and, by using the test results and studying existing pervious concrete pavements, determined the traffic loads and volumes that pervious concrete can withstand. They used aggregate with a specific gravity of 2.36 and a unit

weight of 147.5 lb/ft³. Concrete cylinders with different properties and different permeability were constructed. Water:cement ratios were varied from 0.32 to 0.52 by weight, aggregate cement ratios varied from 4 to 7 by volume. Resulting permeability values ranged from zero to 2688 in/hr and specific gravity values ranged from 1.95 to 2.36.

In an effort to develop preliminary specifications for pervious concrete, the Maryland Department of Transportation conducted investigations to enhance the structural performance and durability of pervious concrete (Amde and Rogge 2013). This was accomplished through testing different admixtures (cellulose fibers, a delayed set modifier, and a viscosity modifier). Specimens developed from different mix designs were tested for density, void content, compressive strength, split tensile strength, permeability, freeze-thaw durability, and abrasion resistance. Freeze-thaw testing was performed at 100%, 50%, and 0% saturation. The cellulose fiber admixture had the greatest impact on concrete durability due to the fibers ability to help hold the aggregate/paste mix together. Both abrasion resistance and freeze-thaw durability increased with the addition of cellulose fibers, although the result regarding abrasion is contradicted by Wu et al. (2011) and should thus be considered with caution. The delayed set modifier reduced permeability because more concrete paste settled to the bottom and developed a less pervious layer. The viscosity modifier resulted in a mix that was easier to handle but had little other impact.

Prior to construction, the subbase must be smoothed and compacted. Compaction to a density of 90% to 95% is often recommended but it is noted that increased compaction decreased permeability.

In order to prevent drying, it was recommended that the subgrade be moist (but without standing water) just prior to pervious concrete placement (Tennis et al. 2004). ACI (2010), like other documents, stated a typical subgrade compaction of 90% of the Standard Proctor Maximum Dry Density in order to maintain infiltration capacity. The subgrade soil, however, should be considered because compacting clayey soils to 90% can essentially eliminate infiltration whereas compacting some sandy soils to 100% has no impact on infiltration. Regardless of the extent of compaction specified, it is important to field test the base and subgrade after compaction to ensure that it meets the desired objectives with respect to infiltration and structural integrity.

Pervious concrete mixes should be placed as quickly as possible because they typically have almost no excess water in the mix and can dry out quickly. This can lead to reduced strength and, in the future, raveling of the concrete. Edge forms, as used with conventional concrete, should be used and concrete should be placed as close to its final location as possible to minimize workmanship. After deposition of concrete it should be cut with a concrete hand rake to a rough elevation and care should be taken to maintain the intended voids. ACI (2010) also discussed other construction techniques such as riser strips, placing equipment, miscellaneous tools, and how to place new pervious concrete next to an existing section that has already been placed.

Construction joints, having a sawcut depth of one-fourth to one-third the thickness of the pavement should be installed (Tennis et al. 2004). A spacing of 20 ft or more being typical. It was also recommended that joints be installed in fresh concrete with special tools. A specially designed compacting roller-jointer with a blade that is at least one-fourth the thickness of the slab and has enough mass to create a clean joint is recommended. The roller should also produce a rounded edge so that square edges, which have a greater tendency to ravel, can be avoided. Other applications, however, such as the Shoreview, MN case study presented in Chapter 8, have found saw-cut joints perform well. In addition, handling time between mixing and placement should be one hour, although this can be extended to 1.5 hours by use of appropriate admixtures (Tennis, et al. 2004).

The curing cover should be placed no later than 20 minutes after concrete placement in ideal, high humidity conditions. For other environments, the cover should be placed sooner. Cover material should be heavy-duty polyethylene that meets ASTM C171 requirements and should cover the entire width of concrete. All measures should be taken to accomplish the construction process quickly to prevent the concrete surface from drying. Concrete should be allowed 7 to 10 days to cure, depending on the use of admixtures. In cold weather, however, curing times may need to be extended. Like other documents, ACI (2010) recommended placing concrete only when temperatures are expected to be above 40°F. Curing blankets may also be used in times of cold weather.

Pervious concrete cannot be pumped, so site access is an important aspect of any job. Placement should be continuous and spreading and strikeoff should be rapid. Conventional formwork is used as is mechanical vibration and manual screeds. Manual screeds must be used with caution, however, as they can cause tears in stiff mixes. Strike off should occur about 0.5 to 0.75 inches above the desired final height to allow for compaction. Compaction is typically done with a steel roller and should be completed within 15 minutes of placement. Compaction is typically the last step as normal floating and trowel operations reduce the permeability of the surface.

Kevern et al. (2006) described methods related to pervious concrete that were used in practice and also discussed a study that determined field level checks for pervious concrete quality control and assurance. Finishing and compaction were listed as the most important steps in producing a durable concrete pavement. Typically, pervious concrete was placed and struck off 0.75 to 1 inch above forms by means of a shim and vibratory screen. After removing the shims the concrete was compacted using a weighted roller. Roller screeds were also used and discussed in Kevern et al. (2006). Other methods investigated and/or discussed included a hand-held vibrating screed to strike off the concrete and the use of an asphalt paver to place pervious concrete. It was also mentioned that a standard edging tool can minimize raveling.

Although joints can be either cut or formed, Kevern et al. (2006) listed formed joints (e.g. via a joint roller) as the preferred method. The study resulted in the following conclusions:

1. Although many methods exist to place and finish pervious concrete, the impact of construction methods on long-term durability is not well understood,
2. Compaction energy can be used to balance strength and permeability, and
3. Compaction energy plays a crucial role with respect to freeze-thaw durability.

The impact of compaction energy on pervious concrete void ratio, compressive strength, tensile strength, unit weight, and freeze-thaw durability was investigated by Suleiman et al. (undated). Single sized crushed limestone and river gravel were investigated. The study found that decreasing compaction energy reduced compressive strength, split strength, and unit weight but increased permeability. Furthermore, samples prepared with regular compaction energy when subject to freeze-thaw cycles experienced aggregate failure while those prepared with low compaction energy failed through aggregate and paste. Suleiman et al. concluded that compaction effort had a significant impact on freeze-thaw durability.

Offenberg (2005) presented an overview of producing pervious concrete and offered troubleshooting suggestions. Four key aspects were presented as being critical to producing a successful pervious concrete section. They were 1) a uniform and properly compacted subgrade, 2) using the correct amount of water, 3) subjecting the pavement to appropriate levels of compaction, and 4) proper curing.

It was suggested that compaction of subgrade be performed to 92% to 96% of the modified Proctor maximum density for sandy subgrades. With regards to the amount of water in the mix, visual inspection for the presence of open pore spaces in compacted concrete and a light sheen from free water in the mix were noted as valuable clues that indicate proper water content. Offenberg (2005) suggested that the concrete supplier take some responsibility for this and that truck drivers be trained to have an understanding of the basics of pervious concrete.

In addition to construction guidelines, some agencies and researchers have developed reports detailing recommended specifications. The Colorado Ready Mixed Concrete Association (CRMCA 2009) developed a report to assist designers in specifying pervious concrete pavements. It is not all-inclusive and does not address design with respect to infiltration of stormwater. In particular, it was written to address design and construction questions related to freeze-thaw cycles, seasonal temperature changes, and Colorado's extremely dry weather. It should be noted, however, that many projects designed and constructed according to these guidelines failed. Thus, these guidelines were not successful in ensuring successful projects. They are worth reviewing, however, at least for comparison to other guidelines and recommendations. Rolling compaction that spans the width of the placed section and exerts a minimum pressure of 10 psi was recommended. Joints, if desired, should be constructed by rolling or forming. For rolled joints, a "pizza cutter" roller was recommended. Joint material should be 0.25 or 0.50 inch flexible foam joint material with a relative density of 1.7 or higher that meets listed ASTM specifications. Although joints can be omitted if random cracking is preferred, CRMCA (2009) specified that if

joints are installed they should be at regular intervals spaced at 20 feet or less. CRMCA recommended that pervious concrete should only be placed between April 1 and November 1 and should not be placed if the temperature is expected to be 40 °F or lower or 90 °F or higher in the seven days following placement. Pervious concrete should also not be placed on frozen subgrade. During curing, the concrete should be covered with polyethylene sheeting that is at least 6 mil thick. CRMCA (2009) also discussed in detail other moisture loss control measures.

2.2.2. Structural Design

The American Concrete Pavement Association has adopted a structural design methodology and incorporated it into software called PerviousPave (ACPA). This software determines the minimum required thickness of the pervious concrete layer and the required thickness of the subbase/reservoir layer but does not address other aspects such as the subgrade. Many studies have investigated the strength of pervious concrete but no well-accepted fatigue equation has been developed. As a result, PerviousPave uses the enhanced concrete fatigue model that was developed for StreetPave (a software package for the structural design of conventional concrete pavements). This approach was also suggested by a publication at the 2007 Annual Meeting of the Transportation Research Board and a 2008 publication in the Journal of Green Building. PerviousPave assumes fatigue is the sole failure criteria for structural design. In the process the total fatigue damage is given as:

$$FD_{total} = FD_{single} + FD_{tandem} + FD_{tridem} \quad 2-2$$

where FD_{total} is total fatigue damage (%), FD_{single} is the fatigue damage from single axle loads (%), FD_{tandem} is the fatigue damage from tandem axle loads (%), and FD_{tridem} is the fatigue damage from tridem axle loads (%). Fatigue damage for each axle type in Equation 2-2 is given by Miner's damage hypothesis, which is:

$$FD = \frac{n}{N_f} \quad 2-3$$

where n is the number of load applications (calculated from user traffic data) and N_f is the allowable applications to failure. The value of N_f is estimated by:

$$\log(N_f) = \left[\frac{-SR^{-10,24} \log(1 - P)}{0.0112} \right]^{0,217} \quad 2-4$$

where SR is the stress ratio (% , to be defined later) and P is the probability of failure (%). The value of P is estimated by:

$$P = 1 - \mathcal{R} * \frac{SC}{50} \quad 2-5$$

where \mathcal{R} is the design reliability (%) and SC is the percent slabs cracked at the end of the pavement life (assumed to be 15% in the program). More detail on \mathcal{R} and reliability concepts can be found in Section 1.3.2.1 and the discussion of AASHTO 1993 design for porous asphalt and interlocking concrete pavements.

In Equation 2-4, SR represents the ratio of the equivalent stress, σ_{eq} , to the flexural strength of the concrete (psi), where:

$$\sigma_{eq} = \frac{6 * M}{h_c^2} * f_1 * f_2 * f_3 * f_4 \quad 2-6$$

and where M is the equivalent moment (psi), h_c = concrete pavement thickness (in), f_1 is an adjustment factor for the effect of axle loads and contact area, f_2 is an adjustment factor for the effect of shoulder, f_3 is an adjustment factor to account for the effect of truck wheel placement at the slab edge, and f_4 is a factor to adjust for an approximately 23.5% increase in concrete strength with age and variation in material. Detailed equations and/or values for each adjustment factor and M are given in APCA (undated). PerviousPave incrementally increases the thickness of the pavement, h , and calculates FD_{total} for each axle type and load group until FD_{total} reaches 100%, the limiting structural design criterion. ACPA (2009) also stated that the bottom of the stone subbase layer should be below the frost line when installation is in cold climates, and at least 3 feet (1 m) above the seasonally high ground water table.

The University of California Pavement Research Center (UCPRC) conducted a study to develop an alternative mechanistic-empirical (ME) design method (Jones et al. 2010, Li et al 2012). Results of simulation study showed that all required pavement structures were less than 5 feet in total thickness and most concrete slabs were less than 1.5 feet for the heaviest traffic. Thus, all simulated pavements were considered feasible.

In areas subject to freeze-thaw cycles, the American Concrete Institute (ACI) recommended the use of a gravel base (ACI 2010). If a rock base for stormwater storage is to be used, a geotextile fabric should be placed between the rock and the subgrade. The National Ready Mixed Concrete Association (NRMCA) recommended joint spacing of no more than 20 feet, while spacing of up to 45 feet have been reported without shrinkage cracking. Some researchers recommend shorter joint spacing of 15 feet (Kevern et al. 2006).

2.3 Interlocking Concrete Pavement

2.3.1 Typical Aggregate Mix and Cross Section Design

The Interlocking Concrete Pavement Institute (ICPI) presented design advice for permeable, interlocking, concrete pavements (PICP) (Smith 2011). These pavers have joints or openings that are filled with permeable material that allows water to infiltrate across the pavement surface and can reduce runoff volume and improve water quality. The joints and/or openings typically cover about 5% to 15% of the total pavement surface area. A typical cross-section of a PICP system is shown in Figure 2-4.

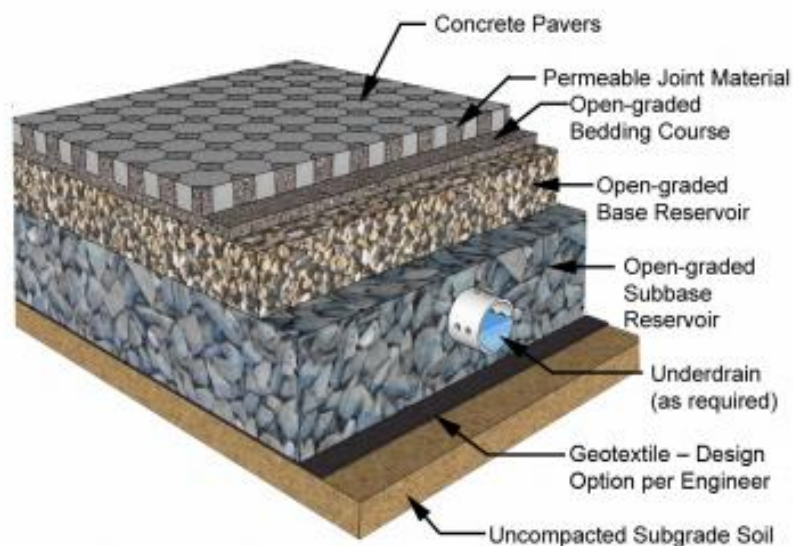

Figure 2.4. Typical cross-section of a permeable interlocking concrete paver system (Smith 2011).

The layers of materials in Figure 2-4, from top to bottom, consist of the concrete pavers, open-graded bedding course, open-graded base reservoir, open-graded subbase reservoir (with underdrain, if necessary), geotextile fabric (optional), and the subgrade soil. The open-graded bedding course is usually 2 inches thick, consists of small size aggregate (usually ASTM No. 8 or smaller) that allows infiltration, and provides a level bed for the pavers. The open-graded base reservoir is also permeable, is usually 4 inches thick, and consists of crushed stones from 0.5 to 1.0 inch in size. The open-graded subbase reservoir usually consists of stones from 2 to 3 inches in size and the thickness of this layer depends on water storage requirements and traffic loads. If the native soils underlying the PICP system do not provide adequate infiltration, the open-graded subbase reservoir may include a perforated underdrain (as shown) to convey water out of the

system. Finally, a geotextile fabric may be placed between the open-graded subbase layer and the uncompacted subgrade soil. The purpose of the geotextile layer is to separate the sub-base reservoir from the natural soil and to prevent fines from migrating into the layers above. Concrete pavers should conform to the American Society for Testing and Materials, ASTM C 936 in the United States.

2.3.2 Structural Design

The structural design of PICP developed by the Interlocking Concrete Pavement Institute (ICPI) (Smith 2011) followed the AASHTO 1993 method detailed above in Section 2.1.2. In this method a minimum required structural number (SN) is determined from expected ESALs, soil properties, moisture, and climate conditions. SN values range from 2 to 10. Based on its strength or stiffness, each layer of the pavement is assigned a layer coefficient. The thickness of each layer is multiplied by its layer coefficient and all such products are summed with the requirement being that the sum equal or exceed the SN.

Prior to design, the soil strength and/or stability under the proposed PICP must be quantified using the resilient modulus (M_R), California Bearing Ratio (CBR), or resistance (R-value). Minimum acceptable values are as follows: $M_R = 6,500$ psi (per AASHTO T-307), CBR = 4% (96-hour soaked per ASTM d 1883 or AASHTO T 193), and for R-value = 9 (per ASTM D 2844 or AASHTO T-190). If soils need to be compacted or otherwise treated to increase strength, infiltration rates to be used in the hydrologic design should be measured after treatment. Also, the number of equivalent single axle loads (ESALs) the pavement will experience over its lifetime (typically 20 years) must be estimated. A detailed discussion of ESALs is beyond the scope of this report but, as previously described, an ESAL is the equivalent loading caused by one 18,000 kip truck axle. Because PICP is used mostly for parking lots and residential streets, estimated values of ESALs are typically relatively low. Even so, PICP has proven durable in applications that experience heavier truck traffic such as fire stations and commercial parking lots.

Open-graded materials used in PCIP typically have lower layer coefficients (see Section 2.1) than their dense-graded counterparts and values may be further reduced by 40% to 70% due to saturation, which will occur when water is stored in the void spaces. Because of the lower strength of open-graded base courses, these layers typically must be thicker than when designed with dense-graded aggregate. Because stability of the aggregate can be increased by adding underdrains, they are typically recommended. Layer coefficients values for pavers and the bedding layer in PICP, which are typically 3.125 inches thick and placed on a 2 inch thick bedding layer of ASTM No. 8, 9, or 89 stone, have been estimated to range from 0.20 to 0.40 with 0.30 being a commonly accepted value.

Open-graded bases should have less than 2% fines and typically have densities of 95 to 120 lb/ft³ and porosities greater than 30%. When the PICP will experience vehicle loads, joint, bedding, base, and subbase aggregates should be crushed with no less than 90% fractured faces (i.e. 90%

of the aggregate should have angular/fractured sides) and a minimum Los Angeles (LA) abrasion < 40 (per ASTM C131 and C535) (Burak 2004). Base and subbase materials are recommended to have minimum values of 0.32 for porosity and 80% for California Bearing Ratio (CBR), and Burak (2004) recommended that base materials conform to ASTM No. 57 crushed aggregate. Smith (2011) reviewed a German study (Zement 2003) that recommended a conservative minimum resilient modulus for base materials of 14,500 psi and a minimum soil subgrade M_R value of 6,500 psi (i.e. CBR = 4.3%). Smith (2011) went on to report recommended minimum PICP subbase and base thicknesses which are reproduced in Table 2-6.

Table 2.6. Recommended minimum subbase and base thickness for PICP (Smith 2011).

Pedestrian	Soaked CBR (R-value)	4 (9)	5 (11)	6 (12.5)	7 (14)	8 (15.5)	9 (17)	10 (18)
	Resilient Modulus, psi (Mpa)	6,205 (43)	7,157 (49)	8,043 (55)	8,877 (61)	9,669 (67)	10,426 (72)	11,153 (77)
	Base thickness, in. (mm) ASTM No. 57	6 (150)						
Vehicular	Soaked CBR (R-value)	4 (9)	5 (11)	6 (12.5)	7 (14)	8 (15.5)	9 (17)	10 (18)
	Resilient Modulus, psi (Mpa)	6,205 (43)	7,157 (49)	8,043 (55)	8,877 (61)	9,669 (67)	10,426 (72)	11,153 (77)
Lifetime ESALs (Traffic Index)								
50,000 (6.3) and Residential Driveways	Base thickness, in. (mm) ASTM No. 57	4 (100)						
	Subbase thickness in. (mm) ASTM No. 2	6 (150)						
100,000 (6.8)	Base thickness, in. (mm) ASTM No. 57	4 (100)						
	Subbase thickness in. (mm) ASTM No. 2	8 (200)	6 (150)					
200,000 (7.4)	Base thickness, in. (mm) ASTM No. 57	4 (100)	4 (100)					
	Subbase thickness in. (mm) ASTM No. 2	13 (325)	11 (275)	9 (225)	7 (175)	6 (150)		
300,000 (7.8)	Base thickness, in. (mm) ASTM No. 57	4 (100)	4 (100)	4 (100)	4 (100)	4 (100)		
	Subbase thickness in. (mm) ASTM No. 2	16 (400)	14 (350)	12 (300)	10 (250)	9 (225)	8 (200)	7 (175)
400,000 (8.1)	Base thickness, in. (mm) ASTM No. 57	4 (100)	4 (100)	4 (100)	4 (100)	4 (100)	4 (100)	4 (100)
	Subbase thickness in. (mm) ASTM No. 2	19 (475)	16 (400)	14 (350)	12 (300)	11 (275)	10 (250)	9 (225)
500,000 (8.3)	Base thickness, in. (mm) ASTM No. 57	4 (100)	4 (100)	4 (100)	4 (100)	4 (100)	4 (100)	4 (100)
	Subbase thickness in. (mm) ASTM No. 2	21 (525)	18 (450)	16 (400)	14 (350)	12 (300)	11 (275)	10 (250)
600,000 (8.5)	Base thickness, in. (mm) ASTM No. 57	4 (100)	4 (100)	4 (100)	4 (100)	4 (100)	4 (100)	4 (100)
	Subbase thickness in. (mm) ASTM No. 2	22 (550)	19 (475)	17 (425)	15 (375)	14 (350)	12 (300)	11 (275)
700,000 (8.6)	Base thickness, in. (mm) ASTM No. 57	4 (100)	4 (100)	4 (100)	4 (100)	4 (100)	4 (100)	4 (100)
	Subbase thickness in. (mm) ASTM No. 2	24 (600)	21 (525)	18 (450)	17 (425)	15 (375)	14 (350)	12 (300)
800,000 (8.8)	Base thickness, in. (mm) ASTM No. 57	4 (100)	4 (100)	4 (100)	4 (100)	4 (100)	4 (100)	4 (100)
	Subbase thickness in. (mm) ASTM No. 2	25 (625)	22 (550)	20 (500)	18 (450)	16 (400)	15 (375)	13 (325)
900,000 (8.9)	Base thickness, in. (mm) ASTM No. 57	4 (100)	4 (100)	4 (100)	4 (100)	4 (100)	4 (100)	4 (100)
	Subbase thickness in. (mm) ASTM No. 2	26 (650)	23 (575)	21 (525)	19 (475)	17 (425)	16 (400)	14 (350)
1,000,000 (9)	Base thickness, in. (mm) ASTM No. 57	4 (100)	4 (100)	4 (100)	4 (100)	4 (100)	4 (100)	4 (100)
	Subbase thickness in. (mm) ASTM No. 2	27 (675)	24 (600)	21 (525)	19 (475)	18 (425)	16 (400)	15 (375)

The reported values in Table 2-6 assumed a confidence level of 80%, that 10% of the traffic was commercial vehicles, and that commercial vehicles had an ESAL of two. Layer coefficients for ASTM No. 57 stone were assumed to be 0.09 (i.e. $M_R = 19,300$ psi) and for ASTM No. 2 stone the assumed value is 0.06 ($M_R = 12,800$ psi). Typically, PCIP that will be used only for pedestrians uses only ASTM No. 57 stone with a minimum thickness of 6 inches unless a greater

value is required for water storage. Residential driveways were reported as having subbases of ASTM No. 2 stone at least 6 inches thick over a 4 inch ASTM No. 57 base, with some designs using only ASTM No. 57 stone for both base and subbase.

ICPI publishes structural and hydrologic design software called Permeable Design Pro. The structural inputs and calculations rely on the AASHTO 1993 flexible pavement design method described above. The event-based hydrologic model was developed from a non-proprietary FHWA model called Drainage Requirements in Pavements or DRIP (Mallela et al. 2002). The software includes pipe designs for detention/outflow in low infiltration soils and enables calculation of runoff volumes contributed from adjacent surfaces. The program includes a library of rainfall data for the U.S. and Canada, and an option for user input of various rainfall frequencies.

2.3.3 Permeable Articulated Concrete Block/Mats

Permeable articulated concrete block/mats (P-ACBMs) have historically been used for stabilization and erosion control (Pan et al. 2013, Grace 2005) but are now being used for road, parking, and other surfaces as a SCM due to their ability to infiltrate runoff. P-ACBMs are similar to permeable interlocking concrete pavers except that they are taller (over 5.5 inches tall), heavier, and have no material (e.g. aggregate) placed in their joints. Sometimes the blocks are strung together by cables so that they form mats that can be placed as units (Figure 2-5). In other applications, the blocks are placed individually and are not attached by cables. When used, the only purpose of the cables is to facilitate placement, they are not needed for durability of the pavement structure or any other purpose.

Little information is available in the literature regarding the use of P-ACBMs as a stormwater management practice. Similar to PICPs, they are placed over an aggregate reservoir and water can infiltrate from the pavement surface to the reservoir by passing between the blocks. As mentioned previously, the joints between individual blocks is not filled with aggregate but rather the joints remain open.

Recommended maintenance activities include regular (i.e. bi-monthly) visual inspections (during a rain event) to ensure surface infiltration rates are adequate and vacuuming with a Vac Head to remove debris accumulated in the joints (Figure 2-6), when necessary. In one study of PaveDrain P-ACBMs by the University of Louisville that investigated surface infiltration rates before and after maintenance, vacuuming with a Vac Head was determined to be a long-term effective maintenance action. The Vac Head was strong enough to clean the joints of collected debris (Figure 2-7). A street vacuum sweeper was deemed not to be effective because it did not fully clean the deep (over 5.5 inch) joints. Wetting the pavement prior to vacuuming did increase the effectiveness of the street vacuum sweeper but this maintenance action was not pursued due to the added difficulty and logistics of wetting the surface compared to the relative simplicity of using a Vac Head (D. Buch, personal communication, May 28, 2014). Cleaning the joints with a jet of air was also investigated and found to be initially effective but the effectiveness decreased

in subsequent applications. It was thought that the jet of air pushed debris further into the pavement structure and that this caused the reduction in surface infiltration over time (D. Buch, personal communication, May 28, 2014).

Kazemi et al. (2013) investigated the hydraulic performance of this permeable pavement system and found that, when clogged, the system captured 30-40% of runoff volumes and that proper maintenance completely restored infiltration capacity. Kazemi et al. (2013) also noted, however, that after the first year of use the infiltration into the subgrade of the systems had dropped to 80% of their initial performance. The drop, it was noted, could be due to the accumulation of sediments at the bottom of the deep trench. If so, this could decrease vertical infiltration rates and limit the storage capacity of the system. Overall volume reduction values were not stated.

P-ACBMs have recently been installed in northern Indiana, Maryland, Kentucky and Virginia. The City of Shoreview, MN recently installed P-ACBMs on a road in the summer of 2014.



A)



B)

Figure 2.5. Permeable articulated concrete block/mat A) installation and, B) completed project (Photos courtesy of University of Louisville and D. Buch, Pavedrain, LLC.).



Figure 2.6. Maintenance of permeable-articulated concrete block/mats with a Vac Head (Photo courtesy of University of Louisville and D. Buch, PaveDrain LLC.).

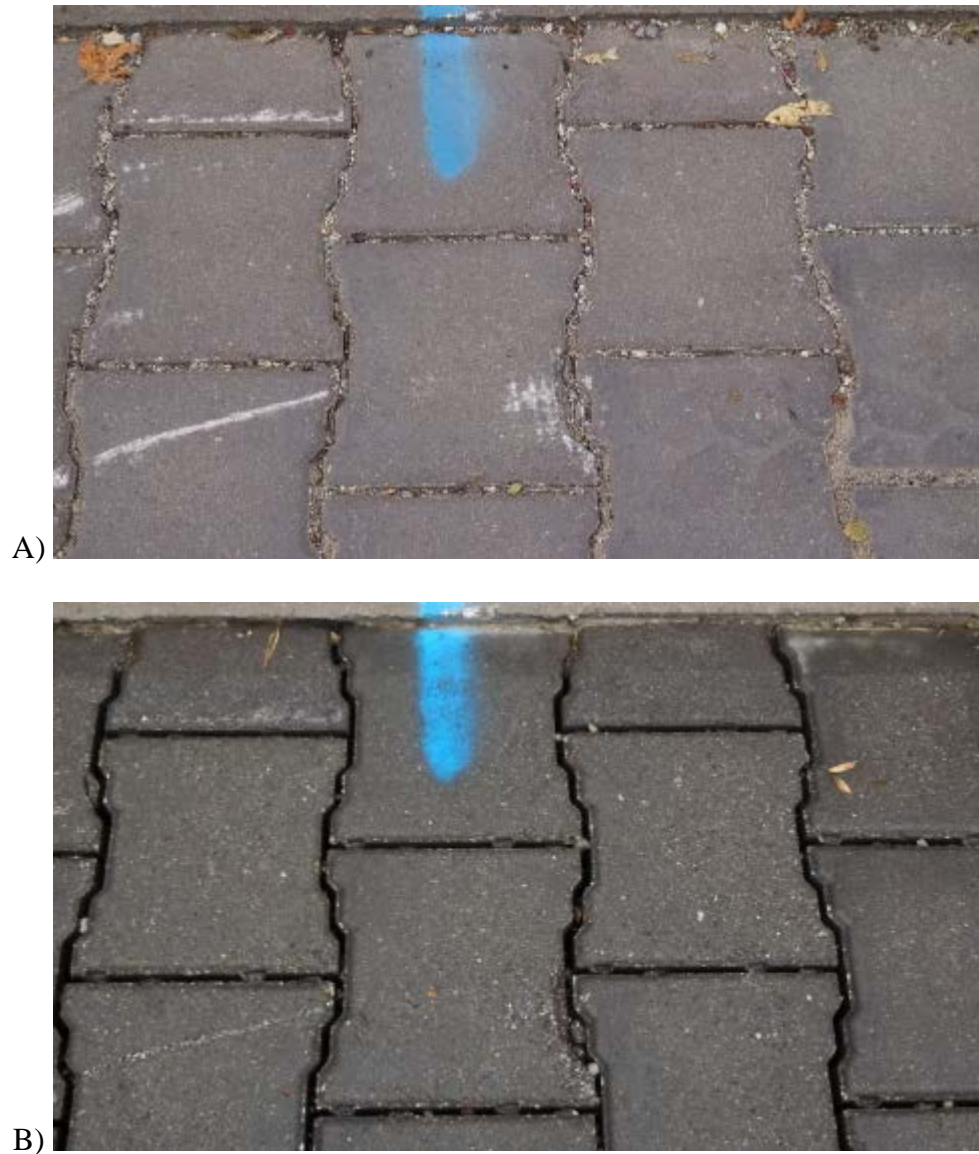

Figure 2.7. Permeable articulated concrete blocks/mats before (A) and after (B) cleaning with a Vac Head (Photo courtesy of University of Louisville and D. Buch, PaveDrain, LLC).

Chapter 3 Hydrologic Design

As previously indicated, both structural design and hydrologic design must be performed in order to determine an adequate aggregate depth that is both strong enough to carry expected vehicular loads and large enough to provide the necessary storage capacity for the design runoff volume. At present, there is no standard hydrologic design that is used for all types of permeable pavements. Rather, different methods have been suggested or proposed by different industries and researchers. This chapter summarizes the hydrologic design processes suggested by the leading permeable pavement industry organizations for their pavement type and also presents other hydrologic design methods suggested or performed by other researchers.

3.1 Overview

If the surface of a permeable pavement is well maintained, infiltration through the surface of the pavement will not be a limiting step. Thus, hydrologic design is typically based on the storage volume provided to temporarily store stormwater runoff. The storage capacity of the entire permeable pavement system includes the capacity within the permeable pavement layer, the capacity within the base course and, in some circumstances, it may also include underground storage tanks and/or above ground storage due to curbs. In general, the hydrologic design process determines the required thickness of the layers within the permeable pavement system so that the pavement structure will have the capacity to temporarily store runoff from the design runoff event. Once obtained, the thickness is compared to the thickness obtained from the structural design procedure and the more conservative value (i.e. thicker) is selected for design.

Additionally, permeable pavement systems should also be designed so that they can infiltrate or drain the design runoff volume from the system within the desired time. The infiltration capacity of the subgrade is therefore important, because it could be the limiting rate in the system. This chapter presents design methods and other related design considerations relating to the hydraulics of permeable pavement systems.

3.2 Native Soil Infiltration Capacity

The infiltration capacity of on-site, native soils will affect the design of a permeable pavement system. Thus, a thorough soil investigation must be performed to determine if the soil is adequate for permeable pavement with regards to infiltration rate and capacity. Also, depending on the infiltration capacity of the native soil, permeable pavement systems may contain underdrains located in the aggregate reservoir layer. The underdrains are designed to collect and convey infiltrated water out of the permeable pavement structure.

ACPA (2009) indicated that pervious concrete is best suited for soils with minimum infiltration rates of 0.5 in./hr but that in areas with poorly draining natural soils pervious concrete can still be used as long as the systems are designed properly. Modified designs for poorly draining soils

typically included a rock-filled trench under the pavement and/or drain tiles to convey the infiltrated water downstream in the conveyance system.

NAPA (2008) stated that native soils with infiltration rates of 0.1 to 10 inches/hour are reported as working the best and that infiltration systems work best on upland soils.

According to Smith (2011), permeable interlocking concrete pavers (PICP) can be designed with or without underdrains. If the system does not contain an underdrain it is referred to as a full subgrade infiltration system. Such systems are typically placed over high infiltration soils such as gravels and sands with perimeter drains allow water to exit the system when overflows occur. Systems with underdrains in the open-graded subbase layer are referred to as partial infiltration systems. Although infiltration into the subgrade can occur, the natural soils at the site are much less permeable and the system relies on underdrains to convey a significant fraction of infiltrated water downstream. The height of the underdrains can be set to control the depth of water stored in the open-graded subbase layer. The stored water will then infiltrate over time. In this design, water is typically stored for 24 to 48 hours, which may enable nutrient reduction via denitrification (Smith 2011).

Some PICP systems may have no subgrade infiltration whatsoever due to very low permeable soils or restrictions on contaminant loading to soils. If subgrade infiltration must be eliminated an impermeable liner can be used underneath the entire PICP system. A distance of 1 ft between the barrier and the seasonal high water table is typically recommended (Smith 2011). Also, to protect the barrier, a geotextile fabric can be placed between the impermeable barrier and the subbase.

InterPave (2010) also differentiates between systems based on the fraction of infiltration desired. Total infiltration systems have no underdrains to convey water out of the system and are designed to fully infiltrate the design storm. Partial infiltration systems have underdrains included in the subbase so that some water passes through the underdrain and out of the system and some water still infiltrates into the underlying soil. Systems with no infiltration have underdrains with an impermeable layer on top of the underlying soil so that no water infiltrates into the soil. Based on the permeability of the subgrade (i.e. underlying soils), InterPave (2010) gave guidance with regards to the appropriateness of each kind of system as shown in Table 3-1. If either systems A or B are to be selected, the groundwater table must be more than 1 meter below the bottom of the subbase.

Table 3.1. Pavement system selection guidance (InterPave 2010).

		System A total infiltration	System B partial infiltration	System C no infiltration
permeability of subgrade defined by coefficient of permeability k (m/s)	10^{-6} to 10^{-3}	✓	✓	✓
	10^{-8} to 10^{-6}	X	✓	✓
	10^{-10} to 10^{-8}	X	X	✓
highest recorded water table within 1000mm of formation level		X	X	✓
pollutants present in subgrade		X	X	✓

For pervious concrete on steep slopes (applications on slopes up to 16% have been successful), it is recommended that trenches that run across the sloping surface be installed and that the trenches be lined with impermeable polyethylene sheeting and filled with rock (ACPA 2009). Pipes or drain tiles, which are optional, can be placed in the trenches in order to allow water to leave the trench.

For PICP applications on slopes greater than 2%, designs should include flow barriers that retain water in the open-graded subbase (ICPI 2011). One typical design is shown in Figure 3-1. The volume available for water storage, which is shown as the hatched area, can be estimated from the geometry of the site.

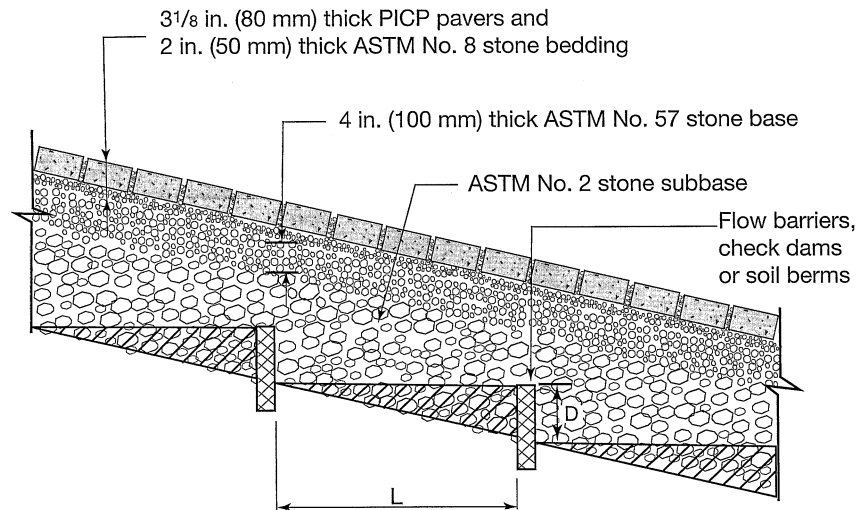

Figure 3.1. One available design for using concrete pavers on sloped surfaces (ICPI 2011).

InterPave (2010) also stated that adjustments to the available storage volume should be made if the pavement will be sloped. These adjustments are similar in nature to those recommended by other industry organizations (ACPA 2009 , ICPI 2011). Further adjustments, based on ratios of land areas, need to be made if the permeable pavement receives runoff from adjacent areas.

For porous asphalt design, NAPA (2008) lists other hydrological design recommendations as follows:

1. Soils should be investigated prior to design (a detailed soil investigation process is outlined in NAPA 2008),
2. The minimum depth to bedrock or the seasonal high water table should be greater than two feet,
3. The bottom of the infiltration area should be flat to maximize the infiltration area,
4. Maximum surface slopes should be 5%. If slopes are steeper, berms should be used,
5. The maximum ratio of impervious to pervious area should be 5:1 but over carbonate soils with a risk of sinkholes, the maximum ratio should be 3:1. In known sinkhole areas porous asphalt should not be used,
6. An overflow systems should be included that will prevent water in the stone bed from rising to the pavement level,
7. An alternate pathway for water to enter the stone subbase (recharge) layer should be provided in case the surface becomes clogged,
8. The stone bed should drain within 12 to 72 hours.

The stone beds are typically between 12 and 36 inches in depth and approximately 40% voids. This means that between 4.8 and 14.4 inches of water, which is usually more than the design storm depth, may be stored in the bed. Thus, water from adjacent areas may be included in the runoff to be stored within the pavement system. If runoff is directed towards the porous asphalt system, pretreatment may be necessary.

The measurement of subgrade infiltration rates are not a topic covered in the permeable pavement literature. However, this is an important topic, because subgrade soils that will not infiltrate water at a prescribed rate or higher can significantly reduce the effectiveness of the PP system. It would be preferred if the native subgrade soil permeability could be measured before the PP system is designed, because this is an important design parameter. The required use of underdrains and the effectiveness of the PP system as a pollution prevention device, for example, depend upon effective subgrade (native soil) measurements that can be used to estimate as-built infiltration rates.

3.3 Methods for Determining Runoff Volumes and Reservoir Capacity

In order to design a permeable pavement system so that it has sufficient capacity to temporarily store the design runoff volume, the design runoff and reservoir capacity must be determined. No standard method is used and generally various permeable pavement industries have suggested and/or adopted different hydrological design approaches for permeable pavement design. For example, NAPA (2008) does not give design details and only suggests general items that must be considered. Some of the common methods that have been used to determine runoff volumes and reservoir capacity are discussed below.

3.3.1 The Curve Number Method

Leming et al. (2007) and NAPA (2008) state that the Curve Number method is an appropriate method when the main purpose of the pervious concrete system is to reduce runoff volume. As described in NCRS (1986) the Curve Number method estimates the depth of runoff using the following equation.

$$Q^* = \frac{(P-0.2S)^2}{(P+0.8S)} \quad (3-1)$$

where Q^* = runoff depth (inches), P = precipitation depth (inches), S = maximum basin storage after runoff begins (inches) = $(1000/CN) - 10$, and CN = composite curve number for the site. The CN is based on soil type and land use and values can be found in NCRS (1986).

Leming et al. (2007) suggested that the pervious concrete system should be able to infiltrate most or all of the 2 year return period, 24 hour storm and that the performance of the system should be checked for at least the 10 year, 24 hour storm; but that local requirements may dictate the design storm to be used. It is also suggested to use the NCRS (1986) rainfall distribution.

In the Curve Number method, the hourly rainfall as described by the design storm is mathematically applied to the watershed of the pervious concrete system. Equation 3-1 is then used to calculate the hourly incremental depth of rain that falls on adjacent areas that ends up as runoff. By adding these volumes to the rain falling on the pervious concrete and accounting for infiltration into the underlying soil, the total volume of water to be stored in the pervious concrete system can be calculated. Travel time is not incorporated into the design method. This makes the calculations simpler and the results conservative. The runoff process is computed for the entire rain event or until the storage capacity of the system has been exceeded. If the storage volume is exceeded, surface runoff will be generated from the pervious concrete system. Hydrologic soil groups (HSG) A and B are listed as best suited for permeable pavements, but it is also stated that soil groups C and D can be used with special care (e.g. drain tiles, etc.). For examples of this design method see Lemming et al. (2007).

Schwartz (2010) presented pervious concrete design criteria for freeze-thaw protection and water drawdown. Freeze-thaw protection is based upon the premise that the minimum design thickness (of subbase) required to satisfy freeze-thaw durability is such that the maximum water surface elevation is contained within the subbase when the design storm is routed through the system.

3.3.2 The Rational Method

The Rational method, which estimates the peak flow rate and not a depth or volume of runoff, is as follows.

$$Q = CiA \quad (3-2)$$

where Q = the peak flow rate of runoff (ft^3/s), C = the runoff coefficient for the surface (from zero to 1.0), and A = watershed area (acres).

The duration of the design storm should be set equal to the time of concentration of the watershed and runoff coefficients may vary based on the return period of the design storm (e.g. values of C increase for higher return period storms).

Although NAPA (2008) stated that the Rational method is generally not recommended for determining runoff volumes when designing permeable pavements, others claim it may be used under certain circumstances. For example, according to Leming et al. (2007), the Rational method may provide accurate results when used to estimate the peak runoff flow rates onto simple pervious concrete systems. Leming et al. (2007) note, however, that some of the advantages of using pervious concrete may not be evident in the design and analysis and that with complex systems the Rational method may not be acceptable because it will not capture some hydrological features.

No other guidance or information regarding the design process using the Rational method is given in Leming (2007). Presumably, once a value of peak flow has been obtained, the designer must determine if the peak flow rate can be infiltrated by the pervious concrete system.

3.3.3 Permeable Interlocking Concrete Pavers Method

When determining the runoff volume for a PICP system, Smith (2011) discussed additional considerations that must be incorporated into the design process. For example, the surface area of PICPs should be considered 100% pervious because, when functioning properly, all water that lands on the surface will infiltrate through the joints and/or open spaces. Initial infiltration rates depend on the infiltration rates of the joint material and underlying layers. Joint material is typically ASTM No. 8 stone that can have infiltration rates in excess of 2000 in/hr.

Smith (2011) stated that the maximum allowable storage time must first be determined. This helps ensure the subgrade will not be saturated for too long. With this time limit and the value of final infiltration rate into the soil, f , the maximum allowable base/subbase depth can be estimated to be:

$$d_{max} = \frac{fT_s}{V_r} \quad (3-3)$$

where d_{max} = maximum base/subbase depth, f = final infiltration rate into the subgrade soil, T_s = maximum storage time, V_r = void ratio of the base/subbase (typically 0.4). Equation 3-3 is conservative, because the final infiltration rate is typically the lowest over a given period, and is typically close to the saturated hydraulic conductivity.

For systems without underdrains, Smith (2011) developed two equations for the volume of water stored in the base and subbase. One was based on runoff rates, direct precipitation onto, and infiltration through the permeable pavement and the other was based solely on pavement geometry. These equations were set equal to each other and rearranged to give:

$$A_p = \frac{\Delta Q_c A_c}{V_r d_p - P + fT} \quad (3-4)$$

$$d_p = \frac{\Delta Q_c R + P - fT}{V_r} \quad (3-5)$$

where A_p = horizontal surface area of permeable pavement, ΔQ_c = runoff from watershed flowing on to permeable pavement, A_c = contributing watershed area, V_r = void ratio of crushed stone base and subbase (typically 0.4), d_p = depth of crushed stone base and subbase (does not include bedding course or pavers), R = ratio of the contributing area to the permeable pavement area, P = design storm depth, f = final infiltration rate into the underlying soil, and T = effective filling time of the base and subbase layers. For NRCS Type II storms, the effective fill time is generally assumed to be 2 hours and equations 3-4 and 3-5 are used to design the PICP by first using equation 3-5 to determine d_p and using this value in equation 3-4 to determine the minimum pavement area required, A_p .

If the depth of pavement required exceeds the maximum depth of pavement allowed, d_{max} , then underdrains should be included in the design and the system will be a partial subgrade infiltration system. If underdrains are used, the design process is similar as previously described except that

the number of underdrains is estimated and the above equations are modified to incorporate outflow through the underdrains. Smith (2011) gives more details and thorough design examples for both full subgrade infiltration and partial subgrade infiltration systems. Other design considerations discussed include soil compaction, geotextiles, runoff estimates, and water quality improvement.

Smith (2011) also presents a design, construction and maintenance examples. One reviewed study that investigated PICP systems (Beecham 2009) that were eight to ten years old and never received maintenance found infiltration rates between 0.5 and 37.5 in/hr. Other studies (Borgwardt 1994, 1995, 1997, 2006) found that infiltration rates decrease by 75% to 90% during the first few years. A study by Kim et al. (2013) simulated accelerated sediment loadings for various permeable jointing stone sizes between the concrete paving units. The study demonstrated that even with significant sediment loads, surface infiltration continues. To maintain a conservative surface infiltration rate that can be used by industry as a trigger for cleaning, PICP recommended a minimum surface infiltration rate of 10 in/hr.

3.4 Los Angeles County Method

The American Concrete Paving Association (ACPA 2009) describes an available computer program, *PerviousPave*, which incorporates a hydrologic design process that is based on the Los Angeles County Method (LADPW 2002). This method incorporates hydrologic design in conjunction with structural design. The required concrete thickness (as determined by the structural design) is maintained during the hydrologic design and the sub-base thickness is adjusted until the entire system can store the design storm water volume. The user can choose whether the entire design volume will be stored in the voids of the sub-base layer or if the void spaces of the pervious concrete layer and storage volume available above the pervious concrete up to the curb height will be used for storage. Given the permeability or infiltration rate into the soil, the program also checks to make sure the system can infiltrate the design volume in the desired time. For the actual equations used in the design, see ACPA (undated).

3.5 Computer Modeling

Hydrologic design can also be performed using various computer models such as Storm Water Management Model (SWMM) and Hydrologic Engineering Center - Hydrologic Modeling System (HEC-HMS) which have been developed by U.S. Environmental Protection Agency and the U.S. Army Corp of Engineers, respectively. Other computer models may be used as well. For example, HYDRUS was used in a simulation study performed by the researchers at the University of California (Chai et al. 2012, Li et al. 2012).

Chapter 4 Hydraulic Performance

Permeable pavements are often used as a stormwater management practice because of their ability to infiltrate stormwater runoff. To perform this function, the surface layer of the pavement must allow water to pass through to the underlying layers of the pavement structure, which can occur in pervious concrete and porous asphalt because the air voids in the pavement are interconnected and water can travel from the surface, through the voids, to the bottom of the pavement layer and eventually to the underlying natural soils. Permeable interlocking concrete pavers (PICP), which are typically non-permeable blocks, are different in that they allow water to pass through the space (or joints) between the blocks, not through voids in the blocks themselves. Of course, if infiltrated runoff is to reach the original existing soil, the underlying layers of the pavement structure such as bedding layers, choker courses, and geotextile fabrics, if used, must also have the ability to pass water. The ability of permeable pavement systems to infiltrate water has been the subject of the studies summarized in this chapter.

4.1 Surface Infiltration Capacity

Almost all studies have concluded that permeable pavements that have been constructed well and receive regular maintenance will have the ability to reduce peak runoff flow rates and infiltrate a significant fraction of runoff volume. For example, Huang et al. (2012) found that PICPs reduced peak flows by 21%. Bean et al. (2004) suggested permeable pavements can reduce runoff volume if the following conditions are met, 1) the underlying soil is sandy or loamy sand, 2) there is no high water table, 3) the pavement receives regular maintenance, 4) the pavement is properly constructed, 5) the pavement surface is flat, and 6) there are no over burdening loads. Drake (2013), however, showed that volume and peak flow reduction is possible even if the underlying soil is not sandy or loamy sand. In Drake (2013) permeable pavement systems constructed with underdrains that had valves for restricting outflow reduced peak flows by over 90% and reduced runoff volumes by 43% even though they were constructed over clayey soils. Also, contrary to Bean et al. (2004), Gonzalez and Angullo (2008) found that permeable interlocking concrete pavements (PICP) on a 2% slope that were clogged with construction debris still infiltrated 81% of a 50 mm/hr rainfall and 90% of a 25 mm/hr rainfall. The variability in results can be attributed to differences in permeable pavements, construction methods, clogging, rainfall patterns, and other variables.

Brattebo and Booth (2003) investigated PICPs that had been in service for over six years and found that almost all rainwater reaching the pavers still infiltrated. No mention was made of maintenance history and the investigation took place in the Pacific Northwest where rainfall intensities are typically low. Li et al. (2013a) investigated infiltration rates of PICP, pervious concrete, and pervious asphalt and concluded that PICP had the highest infiltration rates (1800 cm/hr), pervious concrete the second highest (~1100 cm/hr), and porous asphalt the lowest (360

cm/hr). Results should be expected to vary because infiltration rates depend on materials, mix designs, construction techniques, maintenance received, etc. For example, Haselbach et al. (2006) stated that pervious concrete can typically infiltrate at 720 cm/hr (which still ranks second to the PICP rate found by Li et al. 2013a), but, as discussed below, Gilbert and Clausen (2006) determined the infiltration of a PICP to be a couple of orders of magnitude lower.

Wardynski et al. (2013) investigated a PICP parking lot with different underground drainage configurations. The parking lot was divided into three cells with varying aggregate depths (deep, medium, and shallow internal water storage) and drainage configurations. The conventional cell had a 25 cm thick aggregate layer for water storage with an underdrain at the bottom of this layer, the shallow cell was identical except that the drain was located at the top of the aggregate storage layer, and the deep cell had a 56 cm thick aggregate storage layer with an underdrain located 25 cm below the top of the aggregate layer. The shallow and deep cells reduced runoff volumes by 99.6% and 100%, respectively, while the conventional cell achieved only 7% volume reduction.

Gilbert and Clausen (2006) found that the PICPs they investigated had infiltration rates of over 11 cm/hr but that infiltration rates decreased slightly over time, probably due to fine particle clogging. Of course different permeable pavements and even different PICPs will have different infiltration capabilities. Other factors such as PICP spacing and joint material also affect infiltration rates but, in general, infiltration rates have been found sufficient to eliminate or significantly reduce surface runoff. Also, infiltration capacity can vary significantly even on the surface of a single permeable pavement. For example, Lucke and Beecham (2011) found that although the amount of potentially clogging sediment varied by 56% over 12 test locations, the infiltration rate at those same locations varied by over a factor of 10^4 (from 0.6 to 13,23 cm/hr).

Even if some area of a permeable pavement is severely clogged and cannot infiltrate runoff, other areas of the pavement can usually compensate for clogged area so the pavement is still functional. For example, the traffic lanes of the porous asphalt parking lot at the office of the Ramsey Washington Metro Watershed District (RWMWD) in Minnesota are severely clogged so they no longer infiltrate water. The pavement, however, is still fully functional because runoff from the traffic lanes infiltrates through the pavement in other areas, such as the parking stalls. In fact, only two overflow events have been recorded in its eight years of existence (see RWMWD case study in Chapter 9 of Volume 1). Similarly, Chai et al. (2012) concluded that permeable pavement highway shoulders can be effective in capturing highway runoff from traffic lanes. In order to capture all rain falling on a California highway, Chai et al. (2012) estimated that the aggregate base storage layer would have to be from 0.13 meters to 3.0 meters thick, depending upon the subgrade infiltration rate and the impervious:pervious surface area ratio.

Haselbach et al. (2006) experimentally determined the infiltration rate of pervious concrete covered with sand (from 1.3 to 5.0 cm thick) to be 14 cm/hr, which is similar to the 100 year, 30 minute rainstorm intensity in the southeastern United States. Thus, for simulated rainfalls, the pervious concrete generated no runoff for rainfalls corresponding to return periods of up to 100

years if the pavement received only direct rainfall. If the pavement received runoff from adjacent areas, however, runoff did occur.

Chopra et al. (2010) determined measured infiltration rates of pervious concrete cores from eight different parking lots ranged from 1 to 577 cm/hr. The underlying soil at these sites were found to have infiltration rates from zero to 90 cm/hr. Chopra et al. (2010) concluded that clogging could occur because of particles in the pervious concrete or at the underlying soil. Mata and Leming (2013) determined that sand particles, trapped at the surface of the pervious concrete pavements, caused a reduction in infiltration capacity and that clayey and silty material passed through the pavement and was retained by geotextile fabrics at the bottom. Although the silts and clays on the geotextile did not cause clogging, Mata and Leming (2013) stated that the layer of accumulated fines must be accounted for in the design process. Boving et al. (2008) found that geotextiles slowed infiltration into porous asphalt.

In a separate study, Tyner et al. (2009) investigated the effectiveness of underlying soil modification techniques on the ability of pervious concrete systems to infiltrate water. Three different techniques were investigated, 1) Installing trenches filled with aggregate in the underlying soil, 2) Ripping the underlying soil, and 3) Drilling boreholes in the underlying soil and backfilling the holes with sand. The trench technique was found to be superior to the other two methods, although all three methods were able to drain the design volume of water within three days.

Other issues may affect the infiltration capacity of permeable pavements. For example, Shu et al. (2011) found that concrete mixes containing limestone aggregate and latex admixtures may be stronger but they also have lower porosity and infiltration capacity. In general, reducing the air voids of a pervious concrete pavement will make it stronger but it will also reduce infiltration rate. Also, pavement use can affect permeable pavement infiltration capacity. For example, traffic lanes generally have lower capacity than parking stalls because more sediment typically falls on traffic lanes as compared to parking stalls (Henderson and Tighe 2012). Kayhanian et al. (2012b) found infiltration capacity to vary by up to 1000 times between parking spaces and traffic lanes and determined that the most important factors affecting infiltration capacity were pavement age and the amount of accumulated fine sediment (< 38 microns). In an investigation of porous asphalt pavements, Boving et al. (2008) observed low infiltration rates in high traffic areas and snow storage areas. Most likely the low infiltration rates were caused by particle accumulation, however, porous asphalt can also experience clogging through compression and a reduction of void content (Coleri et al. 2013). Drake et al. (2013) also noted that there is some indication that vegetation (plant growth and leaf litter) may help sustain infiltration (James and Gerrits 2003).

Although infiltration capacity is important and the subject of many studies, Henderson and Tighe (2012) state that infiltration capacity was not the determining factor in the overall performance of

the pervious concrete systems which they investigated. Rather, mix designs and construction methods were more critical as they greatly impacted the durability of the pavement surface.

4.1.1 Influence of Geotextile Fabrics on Infiltration Rate Capacity

In a literature review paper Drake et al. (2013) noted that field studies (Boving et al. 2008) and lab studies (Yong et al. 2008, Brown et al. 2009) have indicated that incorporating geotextiles in the design of permeable pavements can reduce infiltration rates by accumulating sediment on the geotextile. Also, Yong et al. (2013) noted that a concrete paver clogged at the geotextile layer. Because geotextiles can cause clogging, the University of New Hampshire Stormwater Center no longer recommends the use of filter fabrics or geotextiles in their design recommendations for porous asphalt pavements (UNHSC 2009). Imran et al. (2013), however, performed a literature review and concluded that geotextile fabric can increase pollutant retention capability, enhance biodegradation, and prevent the transport of fines to lower layers. Scholz (2013) reviewed literature and found that it suggests that any such water quality improvement is due to the retention of solid particles (and associated particle-bound pollutants) on the fabric. Other contaminants not associated with solids (e.g. chloride) were essentially unaffected.

4.2 Winter Hydraulic Performance

Studies that have investigated the winter performance of permeable pavements have generally found that they retain their infiltration capability throughout the winter. Gunderson (2008), in a review of work done at the University of New Hampshire Stormwater Center (UNHSC), stated that freeze-thaw is not an issue impacting permeable pavements or infiltration and that the subbase, if well-drained, remains open in the winter. In fact, Gunderson (2008) stated that infiltration rates of a porous asphalt system were consistently higher in the winter than in the summer. The observed pattern was cyclical and was attributed to binder expansion from summer heat and a corresponding reduction in void content.

Houle (2008), also from the UNHSC, reported that frost depths of 27 inches did not decrease infiltration rates. And Roseen et al. (2012), monitored a porous asphalt parking lot for over 4 years in a cold winter climate. Frost penetration of up to 71 cm was observed and there was no decrease in infiltration capacity or any impact from frost heave. Kevern et al. (2009) found that air in the aggregate layer provided insulation that warms the pavement and underlying soils, delaying frost formation. Similar findings are reported in Wenck (2014). For more details on winter performance see the corresponding case studies in Chapter 8 of Volume 1.

4.3 Summary and Conclusions

The performance of pervious concrete, porous asphalt, and permeable interlocking concrete pavers (PICP) with respect to infiltration of runoff, reduction of peak flows, and reduction of runoff volumes is documented in the literature. With proper mix design and construction practices permeable pavements can provide year round significant reduction of stormwater

runoff volumes and peak flows. Furthermore, with proper maintenance this performance can be maintained long-term (i.e. years).

The infiltration capacity of permeable pavements typically decreases over time due to clogging. Clogging can result from solid particles blocking and/or filling pore spaces within the permeable pavement itself, the accumulation of fines within the pavement structure (e.g. at the bedding layer or geotextile fabric, if used), or from compression of the pavement (i.e. asphalt), which reduces void spaces and permeability. Even if the infiltration capacity is reduced over time, with proper maintenance a well constructed permeable pavement will have a large enough initial infiltration capacity such that long-term infiltration capacities will still be significantly higher than most rainfall intensities. Thus, if the system is designed for direct rainfall only, no runoff would be expected. If the system was designed to accept runoff from adjacent areas, runoff may occur and the reduced infiltration rate should be accounted for in the design of the permeable pavement and the total stormwater management system.

Finally, well-drained permeable pavements can be effective throughout the winter in cold climates. Air provides insulation, which keeps the pavement structure relatively warm and the pore spaces free of ice. This allows infiltration to occur in the winter and minimizes any possible effects of frost heave.

Chapter 5 Maintenance and Related Issues

Permeable pavements, as with any stormwater management practice, require regular maintenance in order to remain effective. Questions arise, however, with regards to what maintenance activities are most effective, what frequencies are optimal, and other related items such as cost. This chapter summarizes publications that try to answer one or more of the above questions.

5.1 The Need for Maintenance to Prevent Clogging

Regular maintenance of permeable pavement must be performed if the long-term ability of the pavement to infiltrate water is to be maintained (Bean et al. 2004, Briggs 2006, Chai et al. 2012, Al-Rubaei et al. 2013). Permeable pavements can become clogged with particles and this can reduce infiltration rates. Because permeable pavements typically have high initial infiltration rates compared to rainfall intensities, clogging would have to be severe for the pavement to lose its functionality (Chai et al. 2012). Also, full restoration to initial infiltration rates is not necessary for a permeable pavement to remain effective. Without regular maintenance, however, clogging can reduce infiltration rates to unacceptable levels or prevent infiltration altogether.

Some have found that particle clogging usually occurs in the upper layer of the pavement (Kayhanian et al. 2012a, Mata and Leming 2012, Yong et al. 2013). Lucke and Beecham (2011), however, found that over 90% of the trapped sediment in a PICP system occurred in the top two layers, which were the pavement and bedding (2-5 mm sized aggregate) and most of the 90% was in the bedding layer. It should be noted that the pavement cross-section contained a geotextile fabric between the stone bedding and base, which is not recommended by ICPI. The collection of fines in the top two layers may be attributed to PICP, which typically has joint spaces that can pass larger particles than pervious concrete or porous asphalt. Most of the fines (< 33 microns), however, were not retained in the upper two layers but rather migrated past these layers and were retained by the geotextile fabric. In addition, Chopra et al. (2010) found that clogging by particles in pervious concrete may be just as likely at the underlying soil or in the pervious concrete itself. Thus, results have varied and this indicates that there is no single location or depth within the pavement where clogging typically occurs. Clogging processes will depend on characteristics of the pavement (e.g. void content, pore size, the presence of a choker or bedding course) and the solids that reach the pavement.

Particles that cause clogging may originate from pavement wear due to tire friction (Ferguson 2005), erosion from adjacent areas, washoff from automobile undercarriages during rain storms, or the application of sand during the winter months. Sanding of permeable pavements is typically not recommended. Even without the application of sand during the winter months, solid particles will reach the surface of permeable pavements. Vehicles can carry solids to the pavement from other roads that have been sanded, trees and vegetation can drop organic matter that can be

ground into the pavement by vehicles, and, as noted by Ferguson (2005), car tires can generate small pavement particles on the surface of the pavement. Thus, permeable pavements must be maintained to remove these particles and reduce the impact of clogging.

Another mechanism for clogging in porous asphalt is drawdown, which can occur on hot days when the asphalt binder becomes less viscous and drains towards the bottom of the pavement (Ferguson 2005). Roseen et al. (2012) suggests that the drop in infiltration capacity of a porous asphalt parking lot observed the first summer after construction was likely due to binder drawdown. A mix design that minimizes binder drawdown can help minimize clogging (Gunderson 2008) and the addition of fibers or polymer additives to the mix can be used to minimize drawdown (NAPA 2003).

Gunderson (2008) reported that binder can swell during the hot summer months and that this process will also cause a reduction in infiltration capacity even if drawdown does not occur. This phenomenon has been shown to repeat in a cyclical fashion with infiltration rates increasing in the winter and decreasing in the summer. Decreased infiltration rates will persist as long as temperatures remain high but increase again as temperatures drop.

Asphalt may also clog due to deformation of the asphalt pavement under heavy loads. This reduces air voids in the pavement and reduces the pavements infiltration capacity (Coleri et al. 2013).

5.2 Recommended Maintenance Frequency

Due to clogging, regular maintenance to remove the particles causing clogging is required. Power washing and/or vacuum sweeping are the two most recommended maintenance activities (Golroo and Tighe 2012b, Drake 2013) along with preventing sediment from adjacent areas from washing onto the pavement (Chai et al. 2012). Recommended frequency of maintenance ranges from at least annually (Drake 2013) to two to four times per year (Gunderson 2008).

Many have investigated the effectiveness of pressure washing and/or vacuuming and found that these techniques can often at least partially restore the infiltration capacity of a permeable pavement. Al-Rubaei et al. (2013) investigated the effectiveness of pressure washing and vacuuming on two older porous asphalt pavements. This combination was found to increase average infiltration rates from 0.50 mm/min to 3.48 mm/min on one of the porous asphalt pavements but it had no effect on the other. The difference was attributed to the fact that the pavement on which it was effective had received regular maintenance (pressure washing, vacuuming, and annual sweeping) over its time in service whereas the other pavement had not. Al-Rubaei et al. (2013) also stated that mechanical sweeping is not an adequate maintenance practice for porous asphalt.

Chopra et al. (2010) found that for pervious concrete that has become clogged, pressure washing was more effective than vacuum sweeping although Mata and Leming (2012) found that vacuum sweeping could partially restore the infiltration capacity of pervious concrete. Drake (2013)

found that vacuuming was effective at one pervious concrete site investigated but not at another. Drake (2013) found, however, that vacuuming and pressure washing can at least partially restore infiltration rates. Hein et al. (2013b) found that pressure washing and vacuuming were both effective initial cleaning methods but that pressure washing followed by vacuuming followed by a second round of pressure washing was significantly more effective at restoring infiltration rates of clogged pervious concrete pavements.

It has also been noted that in some cases vacuuming could not remove the particles causing the clogging (Chopra et al. 2010) and that high pressure washing may push particles further into the pavement (Chopra et al. 2010, Henderson and Tighe 2012). Henderson and Tighe (2012) noted that agitating debris in the voids of a pavement is an important aspect of effective maintenance and that sweeping a pervious concrete pavement with a stiff household broom and rinsing the pavement with a garden hose was effective. It was also noted that it is extremely difficult to restore infiltration rates to initial values of a pavement that had low initial infiltration rates. Low initial infiltration rates are likely due to poor mix design and/or improper construction.

Drake (2013) found that PICP does benefit from vacuum sweeping and Bean et al. (2004) recommends vacuum sweeping PICP at least once a year, and for concrete grid pavements, filling resulting void spaces with sand, as needed.

5.3 Recommended Winter Sand and Salt Application

As previously stated, it has been recommended not to apply sand to permeable pavements because the sand particles can clog the pavement and reduce infiltration rates (Al-Rubaei et al. 2013). Huang et al. (2012) found that winter sanding reduced the infiltration capacity of PICP from over 7500 mm/hr to less than 500 mm/hr. Henderson and Tighe (2012), however, investigated pervious concrete installations and found that winter maintenance of salt and sand application did not affect the infiltration rate after 22 months of service if the concrete had initially high infiltration rates. No mention was made, however, of the long-term effects of sanding on infiltration rates and generally it is recommended to avoid sand application.

Studies assessing necessary salt application on permeable pavements for winter safety have found that permeable pavements typically require less salt loads for the same level of safety and/or bare roadway as their non-permeable counterparts. Roseen et al. (2014), for example, concluded that 64 to 77% less salt was needed for a porous asphalt parking lot to maintain surface conditions of the same quality or better of a non-porous asphalt lot. Compared to non-permeable pavements, Houle (2008) found that salt application could be reduced by 75% for porous asphalt and that permeable pavements have higher skid resistance values in the winter. Wenck (2014) found that unsalted, porous asphalt sections had a similar amount of bare pavement compared to salted, conventional asphalt sections but also noted that there was a lag from two to several hours in the appearance of bare pavement on the porous asphalt.

A lower necessary salt load is attributed to the fact that permeable pavements can retain their infiltration capacity throughout the winter, even in cold climates (Roseen et al. 2014). This allows melt water to infiltrate rather than collect on the surface of the pavement.

5.4 Summary and Conclusions

Typically maintenance actions for permeable pavements are intended to remove particles that cause clogging and thereby increase infiltration rates. Different investigators have experienced different results when assessing the effectiveness of maintenance activities on permeable pavements. In fact, even within a single study results have varied greatly. These differences can be attributed to different permeable pavement types (i.e. asphalt, concrete, PICP), different mix designs, different construction techniques, differences in prior maintenance activities, different pavement uses, and differences within a single pavement (e.g. the pavement is not homogeneous).

All agree, however, that regular maintenance is required if the long-term performance of a permeable pavement is to be maintained. Typical maintenance activities include pressure washing and vacuuming. Mechanical sweeping is generally not recommended because, rather than remove particles from the pavement, it will push particles farther into the pavement. Also, to avoid potential clogging, the application of sand is not typically recommended. Finally, required salt loads have been found to be lower than requirements for conventional pavements.

The recommended frequency of pressure washing and/or vacuuming is at least once per year, but a higher frequency may be needed depending on site and weather conditions. For example, a permeable pavement in a residential setting with a large number of trees may require maintenance after large wind events if the trees drop a large amount of organics onto the pavement.

From our review we determined that performing maintenance activities is generally effective, but expected to be highly variable due to different pavement locations, histories, and types. Without regular maintenance, however, most permeable pavements will eventually fail to infiltrate water.

Chapter 6 Water Quality Benefits

The application of full depth permeable pavement in parking lots, commercial and residential driveways, and roadway shoulders can provide water quality and related benefits in several ways that include, but are not limited to 1) a reduction in the temperature increase and pollutants discharged into nearby surface water and streams, 2) reduction of pollutant mass loads through runoff infiltration into the subgrade soil, 3) recharge of the groundwater table, 4) significant economic impact for treatment and clean-up when the stormwater collection system is commingled with the sanitary sewage, particularly when the system is overwhelmed during high precipitation events, and 5) cost benefits in urban area when land availability is insufficient to accommodate the use of conventional SCMs. This section of the report is organized to summarize the water quality related literature with respect to:

1. Pollutants generated from permeable pavements itself,
2. Physical, chemical and biological characteristics of sub-grade infiltrated water,
3. Water quality concern with respect to groundwater pollution,
4. Summary of water quality benefits.

6.1 Pollutants Generated from Permeable Pavements Itself

When evaluating the water quality of infiltrated water, particularly with respect to groundwater pollution, one question to be addressed is the type and concentration of pollutant generated from permeable pavement materials itself. For example, will any pollutant be generated by the surface pavement material? To address this question, controlled laboratory experiments were performed by researchers from the University of California at Davis who evaluated the leachate generated from a range of open- and dense-graded concrete and asphalt pavements. Each specimen was also artificially aged and the leachate results were compared with fresh specimens. The results showed that the contaminant contributions to leachate were generally extremely low, except for dissolved chromium from a few sources of cement (Signore et al, 2008; Kayhanian et al. 2009a, Kayhanian et al. 2009b). The laboratory study performed by Kayhanian et al. (2010) concluded that the major source of pollutants measured from road surface runoff is mostly associated with vehicles and airborne deposition. For example, one pollutant of concern detected in highway runoff is poly-aromatic hydrocarbons (PAHs), which were not detected during the controlled laboratory study. PAH compounds at low concentrations, however, were reported in urban and highway runoff and found to be related to the combustion of transportation fuels (Lau et al. 2005, Kang et al. 2009). Other organic and inorganic pollutants measured in runoff from highway surfaces that are mostly associated with anthropogenic sources can be obtained from a recent review article prepared by Kayhanian et al. (2012b)

6.2 Physical, Chemical and Biological Characteristics of Subgrade Infiltrated Water

As previously discussed, most full depth permeable pavement systems are designed and constructed to capture the design storm based on local stormwater management criteria. The captured water is usually stored in a subgrade aggregate base and eventually infiltrates into the subgrade soil. Design drawdown times usually ranges from 48 to 72 hours. Extra water that cannot be retained within the subgrade aggregate base during a storm event will be discharged as effluent. Depending on the subgrade soil infiltration capacity, perforated pipes are sometimes installed within the aggregate reservoir layer (above native subbase soil) to allow the discharge of effluent. Therefore, a majority of water quality characteristics (physical, chemical, and biological) that have been investigated by researchers is based on the sampling and analysis of subgrade effluent water. Results of such studies are summarized below.

Drake et. al (2012) investigated the water quality aspects of three different types of permeable pavements (two permeable interlocking pavers and pervious concrete). The study was conducted at the Toronto and Region Conservation Authority's Living City Campus, about 5 miles north of Toronto, Canada. An existing parking area was replaced so that there were four cells, each about 2500 ft² in surface area. Two cells were constructed with permeable interlocking concrete pavers (AquaPave ® and Eco-Optiloc ®), one cell with pervious concrete, and one with conventional impermeable asphalt. Drake et al. (2012) concluded that all stormwater that infiltrated through any of the porous pavements had significantly reduced mean and median event mean concentrations (as compared to the traditional asphalt lot) for suspended solids, oil and grease, ammonia-ammonium nitrogen, nitrite, total Kjeldahl nitrogen, total phosphorus, chloride, calcium, copper, iron, manganese, and zinc. It was also noted that pH, alkalinity, conductivity and temperature were also affected by the permeable pavement. The average pH of effluent from the pervious concrete lot was 9.2. For the PICP lots the average was 8.3. The influent pH was not reported.

In a study performed by Wanielista and Chopra (2007b), water samples were collected from the bottom of the storage reservoir of a pervious concrete pavement and concentrations of nitrate and orthophosphate were compared with surface runoff concentrations. On average, the concentrations of nitrate and orthophosphate from the pervious concrete pavement were lower.

St. John and Horner (1997) performed a study in the State of Washington to compare the quality of water produced from conventional asphalt and porous asphalt shoulders on a two-lane roadway with an average daily traffic count of about 9,000 vehicles in each direction. Results showed that 1) total suspended solids (TSS) EMC from the porous asphalt shoulder was 75% lower than the conventional asphalt, 2) the average turbidity from the porous asphalt shoulders was over 50% less than that of the conventional asphalt shoulder, 3) the average chemical oxygen demand (COD) EMC values from the porous asphalt shoulders were 51% lower than the average COD EMC from the conventional asphalt shoulder, 4) COD and BOD loads from

porous asphalt shoulders were 94% and 84% lower than the average COD and BOD load from the conventional asphalt shoulder, respectively, 5) total phosphorus (TP) loads from the asphalt shoulders were 94% lower than runoff load from the conventional asphalt shoulder, 6) orthophosphorus loads were 90% lower in the porous asphalt shoulder runoff as compared to the load from the conventional asphalt shoulder, 7) total zinc and copper loads from the porous asphalt shoulder were all at least 90% lower than the load from the conventional asphalt shoulder, and 8) porous asphalt shoulders were more effective at removing soluble pollutants, especially orthophosphorus, as compared to conventional asphalt shoulders.

Roseen et al. (2009) monitored six different low impact development (LID) designs including porous asphalt at the University of New Hampshire Stormwater Center for two years (and 27 runoff events) to assess winter performance. Influent and effluent samples were analyzed for total suspended solids (TSS), total petroleum hydrocarbons-diesel (TPH-D), dissolved inorganic nitrogen (DIN, comprised of nitrate, nitrite, and ammonia), total phosphorous (TP), and total zinc (TZn). Performance differences between winter and summer seasons were determined by grouping data according to the month of collection (May to October = Summer, November to April = Winter). The water quality improvements were measured through pollutant removal efficiency and effective ratio. Based on event mean concentrations, Roseen et al. (2009) concluded that porous asphalt has a “high” level of concentration reduction (except for dissolved nitrogen) during the winter and performance was not reduced by frozen filter media.

In a separate investigation, Roseen et al. (2012) monitored a porous asphalt test section (with an area of 464 m²) in a parking lot at the University of New Hampshire Stormwater Center for four years to assess hydraulic performance and impact on water quality. Results of this study showed that peak flows were reduced by 90% and the majority of total suspended solids, petroleum hydrocarbons, and zinc effluent values were below detection limits. Dissolved anions, such as nitrate and chloride, experienced no removal, and the phosphorus removal efficiency was 42%.

Wardynski et al. (2013) monitored a permeable interlocking concrete paver (PICP) parking lot in North Carolina for one year to assess the impact the pavers had on stormwater temperature and thermal load export. The parking lot had an area of 239 m² and was divided into three cells with varying aggregate depths (deep, medium and shallow internal water storage) and drainage configurations. The shallow and deep cells had the largest stormwater volume reductions (99.6 and 100%, respectively) while a conventionally drained cell had a volume reduction of 7%. Thermal loads for the deep, shallow and conventionally drained cells were reduced in direct proportion to the corresponding volume reduction. Median effluent temperature from the conventionally drained cell exceeded the critical trout temperature of 21°C during 8 of the 54 events that were monitored. Effluent temperatures for the two cells with internal water storage never exceeded the critical trout temperature. Temperature profiles indicated that the pavers can buffer the impact of high runoff temperatures. During cold winter months the temperature of the subsurface soils never reached freezing. Thus, the authors concluded, frost heave of such pavers should not be expected in similar climates.

Huang et al. (2012) investigated the impact of a concrete inter-locking paver (UNI Eco-Optic ®) on stormwater runoff reduction (peak flows and total volume) and water quality characteristics. The research was performed by monitoring artificially generated rainfall-runoff events from a test cell in Calgary, Alberta during the winter. The impact on water quality focused on total suspended solids (TSS), total phosphorus (TP), total nitrogen (TN), copper (Cu), lead (Pb), and zinc (Zn). Overall, the pavers improved the quality of the runoff with average concentration-based removal rates of 91%, 78%, 6%, 68%, 65% and 55%, for TSS, TP, TN, Cu, Pb, and Zn, respectively.

Boving et al. (2008) investigated the characteristics of infiltrated stormwater pollutants (organic, inorganic, and bacteria) immediately below a porous asphalt parking lot. To investigate the impact on water quality, deep and shallow sampling ports were installed below low and high traffic areas of the porous asphalt and one sampling port was installed just outside the lot. Bacteria and biochemical oxygen demand (BOD) was not detected in any infiltrated water and polycyclic aromatic hydrocarbons (PAH) were found at levels near the detection limit. Nitrate and phosphate from the porous asphalt surface leached into the ground at a rate of 0.45–0.84 g/m²-year. A multi-species tracer test determined the retention capacity of the porous asphalt system to be 90% for metals and 27% for nutrients. Contaminant concentrations observed in water samples taken below the pavement varied with the season. Higher nitrate and phosphorus concentrations were observed during the spring and fall (periods of fertilizer application) while metal and chloride concentrations were higher in later winter and early spring (periods of high road salt application). In addition, comparing PAH flux through the porous asphalt parking lot system to fluxes observed on conventional roads in the region and the results of a tracer study indicated that the porous pavement structure removed PAH's or at least impedes or retards PAH transport.

Brattebo and Booth (2003) investigated the water quality performance of four commercially available permeable pavers (Grasspave ®, Gravelpave ®, Turfstone ®, UNI Eco-Stone ®) used in a parking lot over six years. The study site was located in the Pacific Northwest, which typically has low intensity rainfalls and was not subject to extended periods of below freezing weather. Monitoring results showed that infiltrated runoff had significantly lower levels of Cu and Zn than the runoff from the adjacent asphalt parking area. In all samples but four, concentrations of Cu and Zn in infiltrated water were below toxic levels. Whereas almost all runoff samples had Cu and Zn concentrations above toxic levels. Hardness and conductivity of the infiltrated water was higher than surface runoff concentrations. Compared to infiltrated water collected five years ago, the recent infiltrated water samples had significantly lower concentrations of Zn but higher concentrations of Cu and Pb. Although motor oil was found in 89% of the runoff samples from the asphalt area, none of the infiltrated water samples contained motor oil.

Drake et al. (2013) noted that hydrocarbons are also retained in permeable pavement systems. The removal of oils and greases often results in concentrations less than detection limits. With

regards to nitrogen, it has been reported that permeable pavement systems provide suitable conditions for nitrification (ammonium to nitrate) but it has also been observed that total nitrogen concentrations can be higher in permeable pavement effluent than in conventional asphalt runoff or atmospheric deposition. Particulate bound phosphorus can be removed by filtration within the pavement structure. Several studies have observed that most particulate pollutants are retained either at the surface or within the first few centimeters below the surface within the pores.

The Drake et al. (2013) review also indicated that porous pavements tend to raise the pH of infiltrated water from acidic to values between 8 and 9.5. Although Drake et al. (2013) did not differentiate between the types of permeable pavements, an increase in pH is typically associated with pervious concrete. Because most metals are less soluble at higher pH's, this may also cause metals to precipitate. Studies have been conducted on the impact that certain design variations have on water quality. Examples include geotextiles, which may affect ammonium and orthophosphate removal (Tota-Maharaj and Scholz 2010), phosphorus absorbing materials, anaerobic zones (may decrease nitrate concentrations), sand layers, which may decrease nitrate/nitrite and total nitrogen concentrations of effluent (Collins et al. 2010), and crushed brick, limestone, and basalt. The former two have been shown to have more metal removal than the latter (Fach and Geiger 2005).

Collins et al. (2010) monitored four permeable pavements and a conventional asphalt pavement for seven months to determine the performance of each with respect to stormwater runoff quality. The permeable pavements investigated were pervious concrete, two permeable interlocking concrete pavers (joints filled with small aggregate), and a concrete grid paver filled with sand. Due to poorly draining native soils at the site, all systems included a crushed stone base that contained a perforated drain pipe. Composite, flow-weighted samples of runoff discharged from the permeable pavement systems were analyzed for pH, total nitrogen, nitrite/nitrate nitrogen, ammonium, and organic nitrogen concentrations and loads.

Results indicated that the pH of the permeable pavement effluent was higher than runoff from the asphalt pavement with pervious concrete having the highest pH. Ammonium and total Kjeldahl nitrogen concentrations corresponding to the permeable pavements were lower than those corresponding to traditional asphalt. Except for the concrete grid pavers, the nitrite/nitrate concentrations were higher than that of the asphalt pavement. The authors attributed this to nitrification occurring in the permeable pavement system. Collins et al. (2010) concluded that all four permeable pavements performed similarly with respect to nitrogen removal and that the removal efficiency was similar to that of a sand filter treatment.

Thomle (2010) investigated the temporal pH change of stormwater that had come in contact with pervious concrete that aged under various air restrictions. Pervious concrete specimens were prepared in the laboratory and exposed to three different levels of ambient air restriction. The pH of specimens was assessed by either infiltrating tap or deionized water through the specimens or

by soaking the specimens in tap or deionized water. The study also investigated the decline in pH of water in contact with pervious concrete exposed to carbonate laden water. Results showed that the pH of water exposed to concrete decreases due to carbonation. In this process the hydroxide anion associated with calcium hydroxide is replaced with a carbonate anion and forms calcium carbonate. Minerals in the tap water help lessen the impact of the concrete and, as a result, the pH did not rise as much as in deionized water. It is expected that, for most typical field conditions, the pH values will decline to acceptable values in less than one year. In the carbonate laden water tests, the pH of water exposed to concrete that had previously been exposed to carbonate laden water decreased more quickly when exposed to ambient air.

Gilbert and Clausen (2006) compared the quality of stormwater runoff produced from replicated asphalt, permeable paver, and crushed-stone driveways. Flow-weighted composite samples were analyzed once a week for water quality parameters such as total suspended solids, total Kjeldahl nitrogen, nitrate-nitrogen, ammonia-nitrogen, total phosphorus, copper, lead, and zinc. Compared to the asphalt pavement, the permeable paver runoff contained significantly lower concentrations of all pollutants.

In a laboratory study Mbanaso et al. (2013) investigated the effect of adding glyphosate-containing herbicides on hydrocarbon retention and biodegradation within permeable pavements. The glyphosate-containing herbicides appeared to reduce hydrocarbon retention by geotextiles by pushing oils through the pavement systems. Permeable pavement systems with only oil added discharged effluent with a hydrocarbon concentration of up to 24.5 mg/L whereas systems with oil and herbicide added had effluent with hydrocarbon concentrations of up to 73.2 mg/L. The authors note that some of the increase is probably due to the fact that the herbicide itself contains hydrocarbons. The herbicide also reduced the ability of the geotextile to retain metals. When glyphosate-containing hydrocarbons were added, high concentrations of Pb, Cu, and Zn were found in the effluent from the permeable pavement. The herbicide also stimulated populations of bacteria and fungi and increased their population, thus increasing the number of organic degraders.

Pratt et al. (1999) performed a full-scale laboratory study of a permeable pavement system with concrete pavers in a bed of gravel to investigate its ability to retain and treat petroleum-based contaminants. The gravel, which extended 20 mm below the pavers, was placed on top of a geotextile which was placed on top of 600 mm of 20-50 mm diameter crushed granite. The entire unit rested on and was supported by another layer of geotextile and an underlying stainless steel mesh. The test section was subject to long-term, low level hydrocarbon loading at rates that would be typically experienced by urban roads and/or parking lots. Only clean motor oil, which has low poly-aromatic hydrocarbon (PAH) concentrations, was applied. Water quality was monitored over several months to determine the ability of the pavement system to retain and treat the petroleum-based contaminants. Results indicated that a permeable pavement can sustain microbial populations such that the subgrade structure acts as an *in situ* bioreactor with regards

to petroleum based contaminants. Petroleum contamination in the effluent was reduced to 2.4% of what was applied (reduced from an influent concentration of 900 g/m²-year to an effluent concentration of 22 g/m²-year). A limiting factor in the reduction of petroleum appears to be nutrient supply but a slow-release fertilizer was used to supply nutrients to the pavement structure, which enabled petroleum degradation to be sustained. Any fertilizer must be controlled and used with caution, however, as release of nutrients could reduce water quality of downstream receiving bodies. Also, because only clean motor oil was applied, the study did not investigate the potential for degradation of PAHs within the pavement structure.

Fan et al. (2013) investigated the microbial structure and activity in soil under several permeable pavements. Two soil layers were collected (aggregate and soil bases) under a permeable asphalt, concrete brick, concrete-glass block, and JW pavement. A JW pavement is a newly designed pervious concrete pavement with high load bearing properties and permeability. Each soil layer was evaluated for granulometry, water content, pH, total organic carbon, total nitrogen, enzymatic activities, community-level physiological profiles, and phylogenetic bacterial diversity. The results indicated that the amount and diversity of bacterial communities and the activation and versatility of microbial activities were related to the total organic carbon content of the pavements. JW pavement had microbial compositions and activities much stronger than those under the other pavements (except for fungi and actinobacteria). Bacteria under the JW pavement were also more abundant and diverse and the soil there indicated more activated and versatile microbial metabolism in all substrates and some types of functional guilds. The authors attributed these results to a looser structure and higher water and total organic carbon content within the soil.

In addition to the pollutant reduction observed from the above full depth permeable pavement study, researchers also documented water quality benefits from the use of open graded friction course (OGFC) pavements (Barrett et al. 2006; Roseen et al. 2012). An OGFC pavement is a thin layer of permeable pavement (usually asphalt) that is constructed over an existing conventional asphalt or concrete pavement. It has been speculated that OGFC pavement can reduce runoff contaminant concentrations by filtration within the pore structure of the pavement and reduced water velocities within the pavement. Low water velocities can only transport smaller particles as compared to higher velocities on the surface of non-permeable pavements and water that is splashed due to vehicles (Barrett et al. 2006).

Water Quality Concerns With Respect to Groundwater Pollution

As indicated previously, particulate pollutants can typically be captured by subgrade soil and their movement to groundwater will be slow and transport to the ground water will require substantial time (100 years or more depending on groundwater table, soil physiochemical characteristics and infiltration rate). While the natural filtering that occurs in the soil removes a majority of particle-bound inorganic and organic contaminates, there may be an increased risk of ground water contamination from regulated dissolved pollutants. For this reason the US EPA

(1999) does not recommend the use of permeable pavements in locations near ground water supplies that are used for drinking water.

A few researchers made conclusions on groundwater impact based on their results obtained from infiltrated water sampling and analysis. For example, from tracer tests, Boving et al. (2008) showed that contaminant concentrations are reduced as water infiltrates through the pavement structure and from that they concluded the potential for groundwater contamination was minimal. Another study by Van Seters (2007) with the Toronto and Region Conservation Authority examined soil pollutant levels under six permeable interlocking concrete pavements in the Toronto region from 1 to 16 years old under and just outside these pavements. The study found that:

”The quality of permeable pavement sediment samples (the subgrade, or in some cases the lower base course) was compared to samples taken from nearby reference sites to assess whether or not infiltration of road runoff contaminants had contaminated underlying soils. Results showed little variation in sediment quality with depth. Average permeable pavement concentrations were either similar to or lower than sediment concentrations from the reference sites..., with no obvious relationship to pavement age, design or soil type. The one notable exception among the selected variables...was chloride, which is highly soluble and does not bind to soils like most other roadway contaminants. Chloride accumulates in the subgrade over time, but would be expected to eventually leach from the soil into groundwater.”

Finally, Pitt et al. (1996) notes that, with the exception of chloride, the transport of pollutant (particularly particle-bound) to groundwater is unlikely.

At present, however, long term monitoring data to assess the pollutant transport to groundwater do not exist in the literature. While no data has been published yet, the US EPA has been conducting long-term monitoring of groundwater concentrations below porous asphalt, pervious concrete, and PICP at a 100-car employee parking lot at their Edison, NJ National Risk Assessment Laboratories (Rowe et al. 2010). When published, this should provide some insight into the fate of pollutants in soils and groundwater.

6.3 Summary and Conclusions

Water quality data collected from various sources has revealed a wide range of physical, chemical and biological characteristics of discharge effluent for parameters such as TSS, turbidity, temperature, pH, Cl, Ca, Cd, Mn, Fe, Cu, Pb, Zn, NH₃, NO₃, NO₂, TKN, Ortho-P, TP, TN, Oil and Grease, pesticides, TPH, PAH, COD, BOD, TOC, pathogens (mostly as fecal bacteria), and phylogenetic bacteria. Such monitoring studies were performed under different climates and geographic areas with different pavement types and overall designs (e.g. use of

geotextiles, underdrains, etc.). Hence, a meaningful comparison of results between studies is difficult.

Of course, permeable pavements are capable of removing nearly 100% of pollutant mass loads to surface waters if no surface runoff is generated. Since surface runoff is rarely generated, pollutant mass loads discharged to surface waters is typically low. In most cases, effluent concentrations of solids and particle-bound metals were 50% to 60% lower than the concentration of the same pollutants from conventional pavement surface runoff. The exception would be dissolved chloride, which was shown to have higher effluent concentrations in areas where salt was applied for winter deicing.

It has been reported that permeable pavement systems provide suitable conditions for nitrification (ammonium to nitrate) but the removal efficiency of total nitrogen can be negligible or, in some cases, concentrations can be higher than concentrations corresponding to runoff from conventional, non-porous asphalt. It should be noted that Maestre and Pitt (2005) found, in an analysis of data collected under the National Pollutant Discharge Elimination System, that nitrate and nitrite concentrations in urban runoff are rarely greater than the maximum concentration limit of 10 mg/L for drinking water. Similar results were found by Nieber, et al. (2014). Also, particulate bound phosphorus can be removed by filtration within the pavement structure, but the removal of dissolved phosphorus will be minimal. The removal efficiency of most organic compounds indicated by O&G, COD, BOD, TPH, PAHs were dependent on the biological activities of microbial populations within the pavement subsurface, which may be limited by the availability of nutrients and moisture. . Since the permeable pavement system is drained, the freeze-thaw cycle typically does not influence drainage. Finally, the pH of the infiltrated water can increase to basic levels (8 to 9.5) with pervious concrete pavements.

One study performed under controlled laboratory conditions showed that, except for dissolved chromium, the concentration of nearly all organic and inorganic pollutants generated from asphalt and concrete pavement were below detection limits. Therefore, all pollutants measured in pavement surface runoff or from discharged infiltrated water can be considered to be from anthropogenic sources. For this reason, we can conclude that the permeable pavement itself is typically not the source of any pollutant and their long-term contribution to groundwater contamination is minimal. In addition, a majority of particle-bound pollutants were captured within the upper sub-surface or within the subgrade soil.

Chapter 7 Highway Shoulder Feasibility Studies

Two known studies have taken place in the United States that investigated the feasibility of using permeable shoulders on highways for the management of stormwater runoff. The findings related to the hydrological design, structural design, construction and maintenance issues as well as life cycle cost analysis and a feasibility decision matrix are briefly described below.

7.1 California Study

This study was performed by the University of California Pavement Research Center (UCPRC) at the Davis campus for the Caltrans Division of Environmental Analysis. The focus of this study was to measure relevant parameters in the laboratory and use them as input for a computer model which simulated the structural and hydrologic performance of permeable pavements (particularly under medium speed and heavy load). Model results were used to evaluate structural and hydraulic performance. Results related to structural design, hydrologic design, and clogging and maintenance are summarized below.

7.1.1 Structural Performance

In developing pavement designs the mechanistic-empirical (ME) approach was used rather than the R-value design method as assumptions in the latter are not appropriate for fully permeable pavements (Jones et al. 2010, Li et al. 2012). Several design parameters were tested for subgrade soils and base course aggregate in the lab and used as input parameters in simulation studies. These parameters include: Atterberg Limits, density-moisture relationships, permeability, and resilient modulus, among others. Also, tests were performed to determine permanent deformation of subgrade soils and dynamic cone penetrometer (DCP) tests were performed on base course materials.

Permeable pavements of both hot mix asphalt and Portland Cement concrete mixes were tested. Different mix designs and aggregate gradations were tested for hot mix asphalt with regard to permeability, moisture sensitivity, rutting resistance, raveling resistance, fatigue cracking resistance, and flexural stiffness. Open-graded Portland Cement concrete mixes were tested for modulus of rupture.

In the modeling portion of the research, results of stress calculations in concrete and strain calculations in asphalt were used to estimate the thickness required to ensure the layer didn't fail due to fatigue. Nonlinear layer elastic theory was used to estimate the stiffness of the granular base. This was then used to estimate the shear stress to strength ratios in the subgrade. These results were used to develop structural design tables that can be used with hydraulic performance results (see below) to determine the required layer thickness. Design input variables were subgrade permeability, truck traffic level (i.e. traffic index), climate/region, traffic speed, design storm for the climates/regions, and the number of adjacent impermeable lanes.

Two recommended design layouts were proposed and, based on that, numerous simulations were performed. Results from the computer modeling indicated that:

- Using the mechanistic-empirical design equations can be an effective way of determining the required thickness of fully permeable pavements so they are strong enough to carry heavy truck traffic,
- All required pavement structures were less than 5 ft in total thickness and most concrete slabs were less than 1.5 ft for the heaviest traffic. Thus, all pavements were considered feasible,
- Design cross-sections for shoulder retrofits of highways and low speed traffic areas are feasible as determined by construction and maintenance experts after review.

7.1.2 Hydrologic Performance

The focus of the hydraulic performance study was to determine the required aggregate depth of highway shoulders in order to provide adequate hydraulic capacity to capture the generated design rainfall volume. The hydraulic performance was assessed by solving Richards' equation using a commercially available *HYDRUS* software program that is based on unsaturated flow theory. Rainstorms of 2, 50, and 100 year return periods were modeled and simulations were performed for three different climate regions (north with high rainfall, central with medium rainfall, and south with low rainfall) in California. The aggregate permeability was assumed to be constant at 10^{-1} cm/s and the subgrade permeability varied from constant values of 10^{-3} cm/s to 10^{-6} cm/s. Rainfall data, soil data, and other parameters were used as input data for *HYDRUS* in order to determine the required aggregate depth to capture the runoff volume from expected design storms. When performing the hydraulic simulations the following assumptions were made:

- Rain water infiltrated downward in the vertical direction with no lateral flow,
- Traffic lanes were impervious and all rainfall was directed towards permeable shoulders,
- Travel times between the location of runoff generation and infiltration were small compared to infiltration times,
- Rain intercepted by vehicles, lost as spray or evaporation was ignored,
- The water table was low and did not impact infiltration,
- There was no clogging of the surface layer,
- The top surface was at atmospheric conditions,
- There was no flux through the right or left side (i.e. rain water infiltrated vertically downward),
- At the bottom of the permeable pavements there was no pressure head and thus the system experienced free drainage,
- The initial water content of the soil was or was close to the residual water content.

Results obtained from hydraulic performance simulations showed that:

1. For most average storm designs an aggregate thickness of about 1 m was sufficient to capture the entire runoff generated from average rainfall in California. The highest aggregate depth under high rainfall was found to be about 3 m,
2. Required aggregate thickness was influenced by climate, storm recurrence interval, subgrade soil saturated hydraulic conductivity, aggregate void ratio, number of traffic lanes, and boundary conditions,
3. Higher rainfall amounts (and longer recurrence intervals) required larger aggregate thickness depths but the difference in required aggregate thickness for the 50 and 100 year storms was not significant,
4. Natural rainfall data input generated slightly thicker aggregate base depths as compared to synthetic rainfall data,
5. Native subgrade soil saturated hydraulic conductivity (soil permeability) was the factor that had the greatest impact on calculating the subgrade aggregate thickness. Native subgrade soil saturated hydraulic conductivity values less than 10^{-5} cm/s was an important factor that made full depth permeable pavement impractical,
6. Highway surface area and number of traffic lanes also impacted the required aggregate thickness. Increasing traffic lanes from 2 to 4, increased the required aggregate thickness by 100%.

Additional detail information on hydraulic performance evaluation can be obtained from Kayhanian et al. (2010) and Chai et al. (2012).

7.1.3 Clogging Simulation Performance

To perform this simulation, three different clogging profiles were considered and it was assumed that the surface permeability of the upper 5 cm (2 in.) of HMA-O and PCC-O pavement was reduced to 1/100 of its original value. It was assumed that if there was no reduction in porosity in the upper surface of the pavement, the average porosity would have been about 25 percent. With this porosity the saturated hydraulic conductivity of PCC-O was estimated to be about 0.1 cm/sec (Kayhanian et al. 2010). In theory, a rainfall of about 360 cm/hr (141 in. /hr) would be needed to create surface runoff from either the HMA-O or PCC-O pavements. This amount of rainfall is unusual and will likely never occur. Surface runoff, however, can be generated when a significant portion of surface air voids are reduced due to clogging.

The permeability of twenty-three porous asphalt and pervious concrete parking lots was measured and used as a basis to determine the clogging and surface infiltration of each parking lot. The parking lot age varied from less than a year to eight years old. Large variability was observed in permeability measurements within each parking lot and among all parking lots. In general, the average permeability in older parking lots was lower than newer parking lots; indicating possible surface clogging and the importance of maintenance (Kayhanian et al. 2012a).

Theoretically, surface overflow will occur when the porosity of the upper surface layer of pavement decreases and when the surface hydraulic conductivity reaches a value less than the

rainfall intensity. The maximum rainfall intensity for the Sacramento area is about 10^{-3} cm/sec. Therefore, the surface pavement hydraulic conductivity must decrease to 1 percent of its original values in order for surface runoff to occur, if there is no run-on water (permeable shoulders). If the ratio of impermeable to permeable area is three with permeable shoulders, the surface pavement hydraulic conductivity would need to decrease to 4 percent of its original value in order for surface runoff from the shoulder to occur. To investigate this aspect of the clogging issues, several simulations without run-on water were performed with surface saturated conductivity values ranging from 1 to 5 percent of their original values. The clogging simulation results showed that no overflow failure occurred until the saturated hydraulic conductivity reached about 1 percent of the original saturated hydraulic conductivity value.

Since there was no field investigation involved with this project, no specific maintenance schedule was recommended. It was specified, however, that the full depth permeable pavement must be regularly cleaned in order to assure continuous permeability and infiltration of surface runoff through the pavement and base layers. Additional detailed information on permeability measurements and scanning evaluation of core samples can be obtained from Kayhanian et al. (2010), Kayhanian et al. (2012a), and Manahiloh et al. (2012).

7.1.4 Life Cycle Cost Analysis

A Life-Cycle Cost Analysis was performed to evaluate the net present value economic costs of stormwater management alternatives. When performing the life-cycle cost analysis it was assumed that the fully permeable pavements that were simulated carried out the same function with regards to stormwater treatment (both runoff volume and water quality) as the other alternative SCMs. The full depth permeable pavements shoulder retrofit was considered for a high and low speed highways. The life-cycle cost analysis determined the net present value of the basic elements and included the analysis period, discount rate, costs, and salvage value. Most of the material and construction cost related to permeable pavement shoulder retrofits was obtained from local pavement construction companies. All costs were converted to the net present value and compared to other currently available stormwater management practices. The cost of permeable pavement shoulder retrofits was compared with the cost of conventional SCMs that were obtained from Caltrans pilot SCM retrofit study (Caltrans 2003).

Results showed that fully permeable pavements for the shoulder retrofits are more cost-effective than currently practiced SCMs in most scenarios. Fully permeable shoulders draining one lane of conventional asphalt had a net present value of about two-thirds of the next lowest cost alternative SCM and fully permeable shoulders draining three lanes were about half the cost. In addition, a study performed by Houle et al. (2013) concluded that low impact development systems including permeable pavements, as compared to conventional treatment systems, have generally lower marginal maintenance burdens (as measured by cost and personnel hours).

7.2 NCHRP study

An NCHRP project evaluated the suitability of using permeable pavement for roadway shoulder applications (Hein et al. 2013a). This project was initiated to provide an alternative method for traditional BMPs for highway runoff stormwater runoff management. If designed and constructed properly, permeable pavement shoulders can minimize environmental impacts by 1) reducing stormwater runoff volume and associated flooding and 2) treating or removing pollutants by allowing stormwater to infiltrate through the pavement in a manner similar to pre-development hydrologic conditions. Under this stormwater management program, the water from the surface of the roadway would flow onto the permeable shoulder and downward through the pavement into a stone reservoir. The stone reservoir would then temporarily store the runoff until it infiltrated into the roadway subgrade soils and/or was discharged to other stormwater conveyance and treatment systems.

The final NCHRP report evaluated the existing literature and, based on available information, identified some of the key design, construction, implementation and maintenance features of permeable pavement shoulder design. In addition, the NCHRP report also included the development of a decision matrix to properly select suitable permeable pavement sites and it identified current data gaps and suggested topics for future study. Some of the relevant information related to permeable shoulder design is summarized below.

7.2.1 Structural Design

Recommended structural design by Hein, et al. (2013a) follows equation 2-1. Additional detail on structural design can be obtained in annotated bibliography (Volume 2) and the NCHRP final report (Hein et al. 2013a).

7.2.2 Hydrologic Analysis

The NCHRP report recommends numerous stormwater models that could be used to complete the hydrological design for permeable shoulder pavements. Depending on the hydrologic design goals, one of the following models is recommended by NCHRP:

Simple volumetric runoff estimation methods. These models generate an estimated runoff volume for a specified design storm depth, but do not assign a hydrograph “shape” to this runoff volume. Examples include the NRCS Curve Number method, the volumetric runoff coefficient method, and others.

Event-based hydrograph estimation methods. These models generate an estimated runoff hydrograph for a specified design storm. Examples include the Watershed Hydrology Program (WinTR-20), Small Watershed Hydrology (Win TR-55), Santa Barbara Unit Hydrograph (SBUH), HEC-1 Flood Hydrograph Package, HydroCAD Stormwater Modelling (HydroCAD), and others.

Continuous simulation modeling programs. These models generate long term runoff hydrographs from multiple storms based on a real observed continuous rainfall record and other hydrologic inputs; many also have the capability to route the hydrograph through stormwater management facilities that conduct continuous analysis of transient inflows, outflows, and storage levels. Examples include the USEPA Stormwater Management Model (SWMM), the Hydrologic Engineering Center Hydrologic Modeling System (HEC-HMS), Source Loading and Management Model for Windows (WinSLAMM), Integrated Design Evaluation and Assessment of Loadings (IDEAL), others.

7.2.3 Maintenance and Related Activities

Several preventive maintenance activities were recommended to ensure the functional integrity of the permeable shoulder pavement. Some of the recommended activities relevant to permeable shoulder design are summarized below:

- Permeability checks should be completed using standard infiltration tests, (ASTM C1701-09 and ASTM C1781-13),
- Visual inspection of clogging and durability should be performed,
- Inspect permeable pavements after major rain events to ensure pavement structural integrity and surface infiltration,
- Perform vacuum sweeping at regular intervals in high risk areas, such as areas where sources of sediment or organic debris are higher, and/or where the ratio of tributary to pervious area is high. Twice per year is recommended and should be increased in areas subject to higher concentrations and deposition rates of dust and debris, biomass loading, etc. (Henderson and Tighe 2011). Restore any joint filler loss for PICP,
- Properly maintain upstream landscaping to minimize run-on of sediment and debris,
- Maintain drainage pathways from upstream pervious and landscaped areas to minimize potential for run-on to pavement,
- Inspect and clean all outlet structures to ensure positive water flow from the permeable pavement,
- Provide inspection ports and regularly monitor drainage rates of the stone reservoir to identify if clogging of underlying soils or outlet structures has occurred; remedy to avoid damage associated with extended ponding below the roadway,
- Eliminate the use of sand for winter maintenance activities,
- Clearing snow after every storm is recommended. Special plow blades can be used but are not necessary. Raised snow plow blades are not recommended and any bouncing movement of the vehicle may result in damage to the permeable pavement surface (UNHSC 2009),
- Clearing of snow completely from the permeable pavement surface,
- Limit the use of winter deicing chemicals for sensitive vegetation areas, sensitive receiving waters, or for pavements designed to capture and reuse water.

7.2.4 Feasibility Decision Matrix

To assist in evaluating the suitability of projects for the use of permeable shoulders, a project suitability matrix (template) was developed (Hein et al. 2013a) which could be tailored for individual user needs. The matrix included the three consideration groups of primary, secondary and other considerations with appropriate weighting factors for each group. In order to determine the total score for a prospective permeable pavement shoulder project, each of the primary, secondary and other considerations was given a category weighting of 60, 30 and 10 points, respectively. When considering the primary factors, there was a preference for selecting projects where funding was available, where there were minimal environmental issues, and where there was sufficient depth to the water table to provide adequate drainage. In terms of secondary factors, there was a clear mandate for stormwater quality and quantity improvements with minimal maintenance and operational concerns. The “other” considerations category provided a minimal contribution to the decision weighting. These weighting factors can be adjusted by DOTs to better reflect their goals and objectives.

Within each group, the individual consideration items were also given weighting factors. Each factor should be assessed using specific criteria of the owner’s needs and expectations for the project. Once the factor is rated, the total scores are summed on a scale of 0 to 100. A total score evaluation metric was suggested as well. The suggested metric was if the total scores less than 65, the project is not to be considered a good candidate for permeable shoulders. If the total scores between 65 and 75, the project can be considered for permeable shoulders. If the score is over 75, the project is well suited for permeable shoulders. This scoring evaluation could be vetted by DOTs and adjusted as necessary based on local conditions and objectives.

Chapter 8 Knowledge Gaps

The literature reviewed in this report has provided new information, knowledge, and understanding regarding the application of permeable pavements in cold climates. As noticed from the previous chapters, in recent years the amount of literature has increased exponentially, providing information on the strength, design, performance, maintenance, and various other topics regarding permeable pavements. While progress has been made with this relatively new pavement technology, researchers have also identified many unresolved issues that are not well understood. This chapter summarizes, by topic, some of the most important and/or most common unresolved knowledge gaps which need to be further investigated and better understood in order to optimize the application of permeable pavements. Topics discussed include: (1) hydrologic performance in design, (2) structural integrity and construction, (3) cost and effectiveness of maintenance and optimal frequency, (4) impact on water quality, and (5) long-term performance evaluation.

For a bulleted list of knowledge gaps, please see Appendix A.

8.1 Hydrologic Performance in Design

The measurement of subgrade infiltration rates are not a topic covered in the permeable pavement literature. This is, however, an important design consideration because subgrade soils that will not infiltrate water at a prescribed rate or higher can significantly reduce the effectiveness of the PP system. It would be preferred if the native subgrade soil permeability could be measured before the PP system is designed, because this is an important design parameter. The required use of underdrains and the effectiveness of the PP system as a pollution prevention device, for example, depend upon effective subgrade (native soil) measurements that can be used to estimate as-built infiltration rates.

8.2 Structural integrity and construction

Other data gaps regarding structural integrity, construction, and related issues associated with permeable pavements that must be further investigated and that have been identified in the literature include:

- The effect of using various aggregates (including recycled) and other mix designs on the properties of pervious concrete (Schaefer et al. 2006, Wanielista and Chopra 2007b, ACI 2010, Vancura et al. 2010, Amde and Rogge 2013),
- Determination of site/design specific advantages and disadvantages of and the development of standard guidelines for the use of geotextiles (Scholz 2013),
- Development of other methods that can increase the strength of pervious concrete (Schaefer et al. 2006, ACI 2010),

- The development of non-destructive test methods and standard test methods to measure pervious concrete properties (Delatte et al. 2007, ACI 2010, Amde and Rogge 2013),
- A better understanding of the pore structure to determine material based performance design standards (ACI 2010) and to help explain the need for entrained air bubbles at water:cement ratios of 0.27 as found by Vancura et al. (2010),
- A better understanding of pavement fatigue and the development of fatigue models (Vancura et al. 2010, Amde and Rogge 2013)
- Determination of optimum curing methods for pervious concrete (Amde and Rogge 2013),
- Determination of standards for creating joints in pervious concrete (e.g. saw-cut or rolled), and,
- The amount of compaction energy input to pervious concrete and its impact on the strength, unit weight, permeability, and resistance to freeze-thaw cycling of the concrete (Suleiman et al. undated, Kevern et al. (2006), Schaefer et al. (2006), and Wanielista and Chopra (2007b).

8.3 Cost and Effectiveness of Maintenance and Optimal Frequencies

Maintenance is one of the areas that require a better understanding and additional data collection in order to perform a life cycle cost assessment. This topic was also identified as an area of need by several authors independently of a life cycle cost analysis. Important issues include determining what maintenance activities are most effective on various pavement types and how frequently specific maintenance actions should be performed in order to optimize performance and minimize costs.

Chopra et al. (2007), for instance, investigated pressure washing, vacuuming, and a combination of these techniques with regards to their effectiveness of restoring surface infiltration capacity but stated that other methods of maintenance, including high volume flushing, should be investigated. High volume flushing, however, was not described or discussed further. Drake (2013) simply stated that maintenance requirements must be better understood.

Kayhanian et al. (2010) suggested that various cleaning methods be used and the impact of regular maintenance on the clogging of permeable pavements (and maintaining surface infiltration capacity) be assessed. For example, given a permeable pavement type, what methods are most appropriate for dislodging particles and removing particles. With regards to maintenance of vegetation, Drake (2013) stated that 1) the effect of vegetation on permeable pavement performance and, 2) the control of weeds must be better understood.

In addition to required maintenance actions and frequencies, Drake (2013) noted that the associated costs of such maintenance actions are needed to perform an accurate life cycle cost analysis. Such costs are also needed by practitioners, municipalities, etc. in order to more accurately plan future budgets.

Some authors have investigated the potential reduction in winter salt application rates that may be possible with permeable pavements. For example, Drake et al. (2012) and Drake (2013) noted that more research is needed to determine winter salting requirements on permeable pavements. Houle (2008) noted that other maintenance items such as salt brines and non-chloride salts should be investigated to determine their performance and required loading rates. Thus, required loading rates of anti-icing agents are relatively unknown as is their effectiveness.

Pavements, including permeable pavements, at some point during their design life typically require some form of patching. It has been suggested that patching can be performed with conventional, non-permeable pavement. For example, PDEP (2006) suggested that this can be done as long as the patch is not more than 50 ft² in surface area. Others, such as UDFCD (2010) suggest using non-pervious concrete for patching pervious concrete as long as the total patch area is not more than 10% of the total pervious concrete area. There is a need to determine if these suggestions are optimal and under what circumstances they are optimal and/or effective. Also, there is a need to determine if a permeable pavement structure in need of repair can be patched with a permeable pavement and, if so, how this is best performed. The infiltration capacity of a permeable pavement system will decrease over time due to particles that clog the system or due to compression and deformation of the pavement surface caused by heavy traffic loads. Particle clogging can occur at or near the surface of the pavement or at some depth below the surface. The location of particle clogging can depend on particle size, pavement pore opening size, and the presence of a geotextile fabric. Clogging reduces the pavements ability to infiltrate surface runoff and often necessitates maintenance. Thus, clogging is a critical issue with any permeable pavement system.

St. John and Horner (1997) suggested that the potential for clogging of porous asphalt shoulders be quantitatively investigated. Kayhanian et al. (2010) note that various cleaning methods should be investigated and the impact of regular maintenance on clogging should be assessed. Drake (2013) stated that clogging must be better understood to allow accurate life cycle cost estimates to be made and Drake et al. (2013) suggested that designs that minimize clogging should be developed. Several techniques including permeability measurement, core sample scanning, etc. have been used to assess surface pavement clogging. There is no standard method, however, that is available to evaluate surface clogging and this topic deserves further consideration because of its implication on the overall and sustainable use of permeable pavements.

8.4 Impact on Water Quality

Permeable pavements have demonstrated the ability to reduce contaminant concentrations in stormwater runoff and, through infiltration, can further reduce contaminant mass loads. The processes involved in this reduction, however, are not well understood and some contaminants, such as total nitrogen and dissolved phosphorus, are minimally removed if at all.

For example, Boving et al. (2008) noted that although contaminant concentrations were reduced as water infiltrated through the porous asphalt pavement structure, more research is needed to

determine what caused the reduction (i.e. asphalt, trapped particles, etc.). Collins et al. (2010) suggested isolating the underlying soils from the pavement structure in order to gain a better understanding of the water quality response within the pavement structure.

Drake et al. (2013) identified the following key issues regarding the impact of permeable pavements on water quality that need to be better understood.

1. A more thorough understanding of the fate and transport of nitrogen in porous pavements. For example, when nitrogen has been found to leach from a porous pavement system the source is unknown,
2. A better understanding of the long-term fate and transport of phosphorus. For example, particulate phosphorus can be removed in permeable pavement structures but it is not known if the phosphorus can be released at some later time,
3. The effect of pavement system design and materials in the system on water quality,
4. Pavement designs that optimize pollutant retention and minimize clogging are lacking and should be developed,

Imran et al. (2013) also investigated pollutant removal but focused on bioretention and biodegradation in the permeable pavement system. Key issues identified as knowledge gaps for further investigation include:

1. The biodegradation process in permeable pavements (e.g. species, dispersal, and colonization rate),
2. Processes involved in the removal/retention of nutrients,
3. Knowledge of the optimum environment for biodegradation for various organisms,
4. The relationship between temperature profiles, biodegradation, and microorganism life cycles,
5. Media mixes that enhance bioretention,
6. The performance of filter media in sumps at the bottom of permeable pavement structures,
7. The processes involved in the removal and leaching of phosphorus within permeable pavements.

Leaching of contaminants into stormwater from pavement materials can also impact water quality (Drake et al. 2012) but this process is not well understood. Leaching may originate from materials used to construct the pavement system or from previously retained contaminants that are released. Drake et al. (2012) noted that the long-term impact of leaching is not known and Drake et al. (2013) stated that, when nitrogen leaching occurs, the source of nitrogen is unknown. Imran et al. (2013) stated that a better understanding of the leaching (and removal) of phosphorus

is needed. If permeable pavements are to be used to reduce contaminants in an effective manner, the leaching of materials from permeable pavement systems must be better understood.

In a controlled laboratory study, Kayhanian et al. (2009, 2010) determined that contaminant leaching is of little concern for most water quality parameters from both asphalt and concrete pavement surface materials. One exception was high concentrations of dissolved chromium related to permeable concrete pavement that appeared to be associated with cement. At present no water quality standard has been established for dissolved chromium and only hexavalent chromium (Cr VI) is regulated for drinking water. It is not clear what fraction of measured dissolved chromium was Cr(VI) or if Cr(VI) can be detected in runoff during storm event. This topic may be important when evaluating the impact on groundwater used as a drinking water source.

Temperature variations beneath the surface of a permeable pavement have been shown to be smaller than beneath conventional pavement structures (Kevern et al. 2009, Rowe et al. 2010, Wenck 2014). For example, during cold winter periods the temperatures beneath a permeable pavement may be warmer than those of a corresponding non-permeable pavement. In the summer during hot weather, the temperature remains cooler in the permeable pavement system. Wardynski et al. (2013) showed that pavers can buffer the thermal impact of warm stormwater runoff. A better understanding of the temperature profiles in permeable pavements is needed to determine the impact on snow and ice cover on the pavement (Houle 2008) and other variables. Boyer (2011) suggested that more accurate mapping of temperature profiles in pervious concrete systems is needed and that a model of temperature gains and losses should be developed to help understand the processes involved in the heating and cooling of pervious concrete.

Thermal processes in permeable pavements may also lessen the impact of the heat island effect, which is when developed areas are warmer than surrounding areas, which may be reduced by permeable pavements due to evaporation. Li et al. (2013a) suggested that field studies to determine materials (such as reflective paint) that can generate high evaporation rates be performed. Li et al. (2013a) also suggested performing field studies to determine the effect of permeable pavement on building energy requirements. ACI (2010) and Boyer (2011) also stated that this is an area that needs better understanding.

8.5 Long-term performance evaluation

Many studies have investigated the performance of permeable pavements with regards to structural integrity, resistance to freeze-thaw cycling, peak flow and runoff volume reduction, and impact on water quality, among other topics. These studies, however, typically span several months to a few years and hence do not provide the information needed to evaluate the long-term performance of the permeable pavement. Therefore, a better understanding of the performance of permeable pavements over a longer time frame that corresponds with a life-span of 20 years or more is needed.

Investigators that have emphasized the need for long-term evaluation based on specific topics include:

- Chopra et al. (2007) who investigated the permeability of pervious concrete and concluded that the decrease in permeability over time must be better understood,
- Wanielista and Chopra (2007a) who suggested that traffic studies with accurate traffic volumes and loadings be incorporated to determine how these variables impact the long-term performance of pervious pavement including performance related to strength and permeability,
- Boving et al. (2008) who investigated the water quality impact of porous asphalt pavements but noted that the lots investigated were three years old or less and long-term performance was not confirmed,
- Vancura et al. (2010) who suggested that pervious concrete sites be monitored over time to develop a better understanding of their long-term performance and degradation,
- Drake et al. (2012) who stated that more research is needed to determine how the characteristics of permeable pavements change over time,
- Drake (2013) who stated the long-term performance of permeable pavements in cold climates must be better understood,
- Drake et al. (2013) who stated the need for the development of models that can accurately predict the loss of infiltration capacity over the long-term,
- Houle (2008) who also noted that infiltration rates should be monitored over the long-term to determine the long-term performance of pervious concrete and porous asphalt, and
- Scholz (2013) who stated that long-term testing is needed to determine the impact of geotextiles.

Closely related to long-term performance of permeable pavements is a life cycle cost analysis, which determines the overall project costs over the lifetime of the project. This analysis can be used to help minimize total project costs and more accurately compare the cost of permeable pavements to traditional pavements. Life cycle cost analysis can especially play an important role when considering the application of permeable pavement as a SCM. Costs associated with construction, routine maintenance, rehabilitation, etc. should be incorporated. Thus, in order to perform an accurate life cycle cost analysis, the long-term performance of the system must be thoroughly understood.

Publications that identified life cycle cost analysis as an important issue or one that needs more development and/or research include:

- Houle (2008) who identified the need for life cycle cost comparisons between various permeable pavements and between traditional non-permeable pavements,

- Jones et al. (2010) who stated that a life cycle cost analysis should be performed for all potential projects and results should drive the selection of pavement type,
- Boyer (2011) who stated the a life cycle analysis that included environmental, energy, and economic considerations should be performed,
- Li et al. (2012) who suggested that, after more data collection, a life cycle cost analysis should be performed on test sections and demonstration projects being investigated,
- Drake et al. (2013) and Drake (2013) who noted the need for accurate life cycle costs,
- Li et al. (2013a) who stated the need for a detailed life cycle environmental assessment, which incorporates environmental costs of the project.

Chapter 9 Cold Climate Case Studies

This chapter presents case studies from permeable pavement applications in cold climates. The case studies are divided into two sections, the first being case studies from within the State of Minnesota and the second from outside of Minnesota. To the extent possible, each case study is organized by providing the information related to: focus of the project, construction and mix design, structural and physical performance, hydrologic performance and water quality, maintenance, and lessons learned.

9.1 State of Minnesota Experiences

9.1.1 MnROAD Permeable Pavement Test Cells

Permeable pavement test cells, all constructed to industry standards, were tested at the Minnesota Department of Transportation MnROAD research facility. The cells were constructed as part of the low volume road segment, which is a 2.5 mile, 2 lane, closed loop road. To simulate low volume traffic, one 18 wheel, 5 axle truck with trailer was driven on the inside lane for 80 laps every day during the course of the study. The outer lane was not subject to significant traffic loading. As a result, differences between the inner and outer lanes can be attributed to the impact of environmental effects and traffic loading (inner lane) versus the impact of only the environment (outer lane).

Cell 85 is a pervious concrete pavement over non-compacted sand and cell 89 is a pervious concrete pavement over non-compacted clayey soil. Cell 86 is a porous (PA) asphalt cell over sand and cell 88 is a porous asphalt cell over clay. For reference, cell 87 is a standard, non-porous asphalt pavement. The pervious concrete test cells (and other test cells) are shown in the aerial photograph of Figure 9-1 (note that the location of each cell is indicated by the number on the pavement).



Figure 9.1. MnROAD test facility and cell locations. Cell 85 = pervious concrete on sand, cell 86 = porous asphalt on sand, , cell 87 = pervious controls, cell 88 = porous asphalt on clay, cell 89 = pervious concrete on clay, cell 39 = pervious concrete overlay. (Izevbekhai and Akkari 2011).

9.1.1.1 Pervious Concrete Test Cells

Cells 85 and 89 are seven inch thick, full-depth pervious concrete constructed to industry standards. Beneath the pervious concrete pavement layer each cell has, from top to bottom, 4 inches of railroad ballast, 8 inches of gap-graded aggregate, and a geotextile fabric (Type V) on top of the underlying soil. The cells are identical except for the underlying natural soil; cell 85 was constructed on granular soil and cell 89 on clayey soil. A cross-section of the pervious concrete pavement is shown in Figure 9-2.

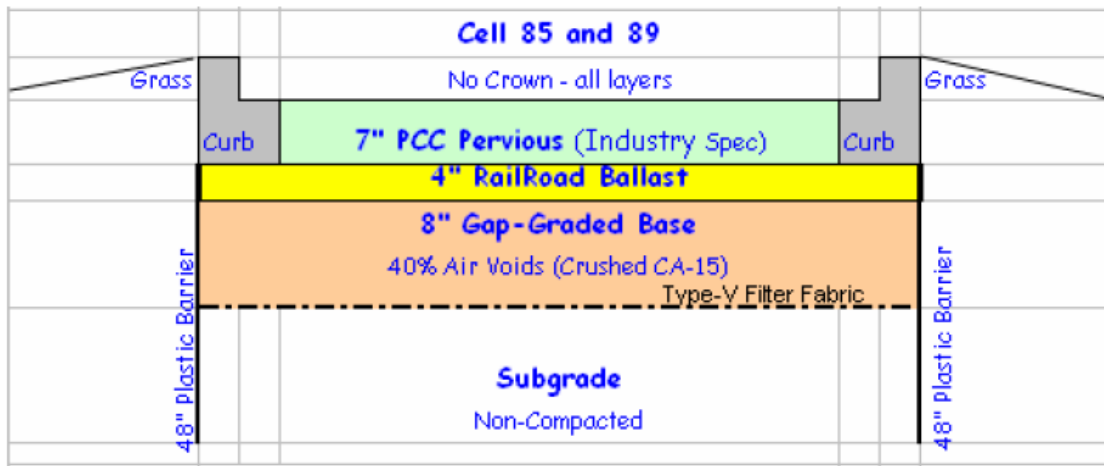

Figure 9.2. Cross-section of pervious concrete test cells (Izevbekhai and Akkari (2011)).

The pervious concrete, which was designed to have a porosity of 15-18%, a unit weight of less than 135 lb/ft³ and a seven-day flexural strength of 300 psi, was constructed with fixed form pavers and roller compaction.

Tests were conducted on the cells to evaluate the international roughness index, surface rating, surface texture, friction number, noise, dissipated volumetric rate, clogging characteristics, pavement surface deflection, temperature and moisture. The performance of pervious concrete cells was assessed based on: (1) hydrology, (2) structural integrity and (3) clogging and maintenance.

Major emphasis was given to structural and physical performance of both pervious concrete and porous asphalt test cells and hence the hydrology and water quality monitoring was not a priority of this project. Nevertheless, hydrological aspects, especially with regards to dissipating water flow volume, was measured in order to assess clogging and maintenance requirements. Due to concern about the impact permeable pavements may have on groundwater quality and based on limited resources, only groundwater samples associated with the porous asphalt test cells were analyzed for various water quality parameters. Results were compared with existing water quality standards in the State of Minnesota. The comparative water quality and the long-term impact on groundwater, however, need to be further investigated and verified for all permeable pavements.

9.1.1.2 Hydrologic Performance

The hydrologic characteristics were measured based on dissipated volumetric rate, which is similar to the infiltration rate as summarized here. Values of dissipated volumetric rate (DVR) were obtained for several locations on each test cell. The values were obtained by using a 90 centimeter long, six inch diameter cylinder placed vertically and sealed (with a duct seal compound) to the pavement. To conduct the test the cylinder was filled with water and allowed to drain until steady flow developed. Once steady flow was established, the time it took for water to drain from an elevation of 37 cm to 11 cm was recorded and used in equation 9-1 to determine the dissipated volumetric rate. It should be noted that the dissipated volumetric rate is not a measure of permeability but rather it is an indicator of pavement infiltration capacity.

$$\text{Dissipated Volumetric Rate} = \frac{(\text{Initial Head} - \text{Final Head}) * \text{Cross-sectional area}}{\text{measured flow time}} \quad 9-1$$

Values of DVR varied greatly from location to location, even on the same test cell. Thus, average values were computed for each cell. As may be expected and as shown in Figure 9-3, on all test dates the pervious cell over sand (cell 85) had a greater average DVR than the pervious concrete cell over clay (cell 87).

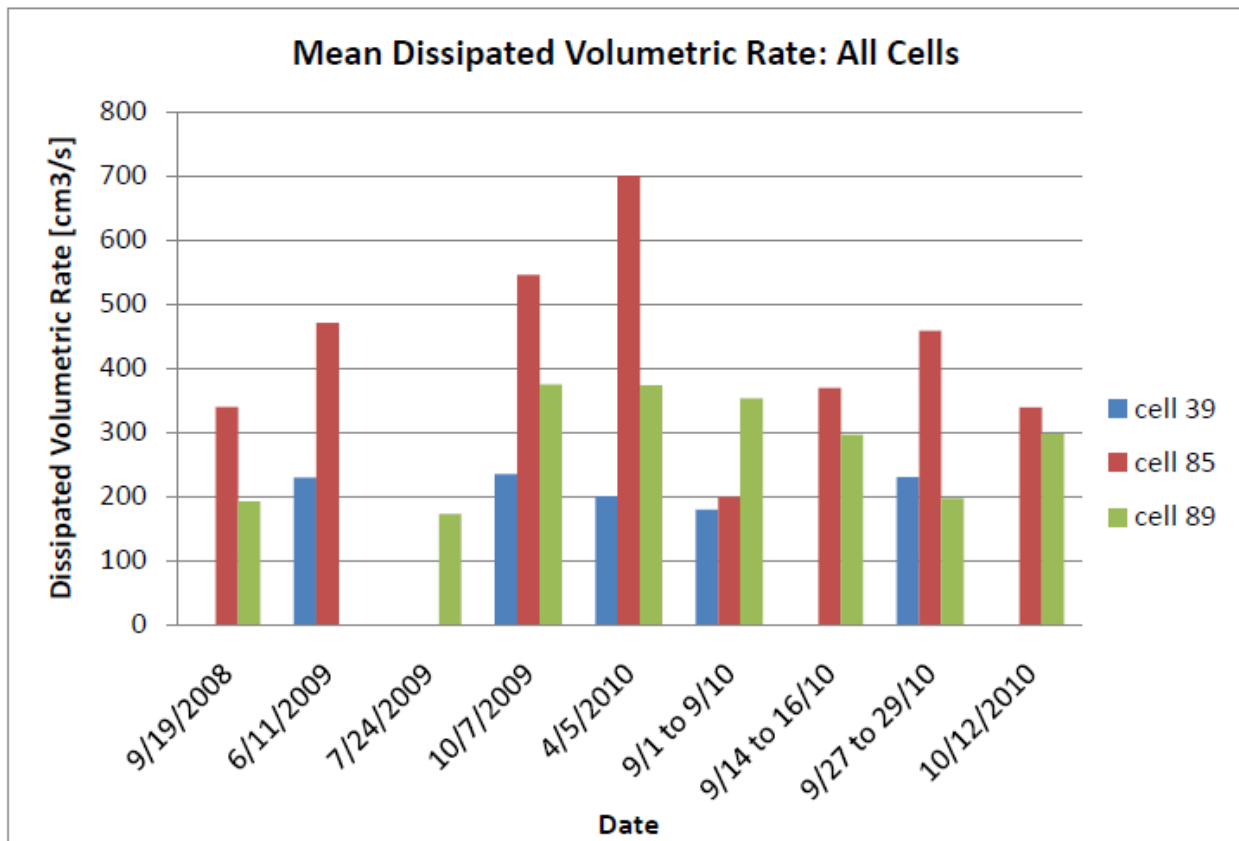

Figure 9.3. Average dissipated volumetric rates for pervious concrete cells over sand (cell 85) and clay (cell 89). Note: cell 39 is a porous overlay and not related to this review.

As can be noted, the units in Figure 9-3 for dissipated volumetric rate is different than infiltration rate which is expressed as unit depth per time (e.g., cm/s). The infiltration rate or permeability can be measured using the newly developed standard method ASTM 1701 (Li et al. 2012). This new ASTM method may be used for different test cell locations. This new test method can also be used as a basis for clogging investigation and maintenance performance.

9.1.1.3 Structural and Physical Performance

Parameters measured to assess the structural and physical performance of pervious concrete cells include: international roughness index (IRI), surface roughness (SR), density, deflection, and temperature. The average international roughness index (IRI) in Minnesota is 1.4m/km on interstates and 1.7 m/km on non-interstates. According to the Federal Highway Administration (FHWA), an IRI less than 1.5 is considered "good condition" and an IRI of less than 2.6 is considered to be "acceptable." The IRI values measured on the pervious concrete test cells were mostly between 3 and 5 with a maximum value of 6.5. These values are above the FHWA limit for an "acceptable" pavement, which could be due to the different kind of pavement used. It was noted that there was no distinct variation in IRI with season but IRI was lowest in the first two tests for all cells. This suggests that raveling and weathering made the pavement rougher over time.

A surface roughness (SR) rating of four is considered to be a pavement in perfect condition and a value of less than two is considered to be a pavement in poor condition that is in need of repair. In Minnesota the average SR value for concrete pavements is 3.3. All SR values measured on the pervious concrete cells were above 3.5. This indicates that the pervious concrete cells have a better than average ride quality. The SR for all cells decreased in September of 2009, suggesting again that raveling and weathering had detrimentally impacted the pavements.

Density measurements on both lanes of both cells (85 and 89) revealed that the lanes have similar densities and, even at a confidence interval of 75%, the densities of the inside and outside lanes cannot be said to be statistically different. Due to the fact that the inside lane is subject to daily truck traffic and the outside lane is not, results indicate that traffic loading does not affect the density of full-depth pervious concrete.

The pervious cells experienced more deflection in the falling weight deflectometer measurements than conventional concrete. In cell 85 the outside lane had higher deflections than the inside lane but in cell 89 the opposite was true. This suggests that deflection is not necessarily dependent on traffic loading. Also, surface deflection was highly variable between seasons, with the minimum deflections typically occurring in the fall and winter.

Temperature sensors within the pervious concrete cells revealed that the pervious concrete had more uniform temperature gradients throughout the pavement structure as compared to conventional concrete. This may be beneficial because large temperature gradients can cause warping and stresses. Also, the data suggests that the pervious concrete cells experienced less freeze-thaw cycles than conventional concrete. Finally, moisture was found to freeze at greater depths in the pervious concrete cells.

9.1.1.4 *Clogging and Maintenance Performance*

To determine the impact that vacuuming the pervious concrete surface has on infiltration capability, DVR measurements were made both just prior to vacuuming and just after vacuuming on two occasions. By comparing pre- and post-vacuuming DVR values, the impact of this maintenance activity on the pavement was quantified. In November of 2009 when the pervious concrete cells were about 1 year old and in good condition, a Relikor vacuum truck was used on cells 85 and 89 and the difference in DVR (before and after vacuuming) was determined at one location in each cell. Although the Relikor truck had brushes, the brushes were not used because they can push solids into the pore spaces and exacerbate clogging. In November 2010 the cells were vacuumed a second time and the impact on DVR was determined at a total of 12 locations on cells 85, 89, and on a pervious concrete overlay (cell 39). Overall during the course of this investigation the cells were very clean and had no evidence of surface distress.

On cell 85 the first vacuuming had no impact on DVR, as the measured drain time before and after vacuuming was six seconds in both instances. On cell 89 the measured drain time before vacuuming was 17 seconds and afterwards it was 15.5 seconds, which is a decrease in time (or

an increase in DVR) of about 9%. Any improvement in infiltration capability was attributed to removal of raveled surface aggregate.

For the second cleaning, the DVR at some locations increased but others decreased after vacuuming. Figure 9-4 shows the change in DVR at each of the 12 test locations.

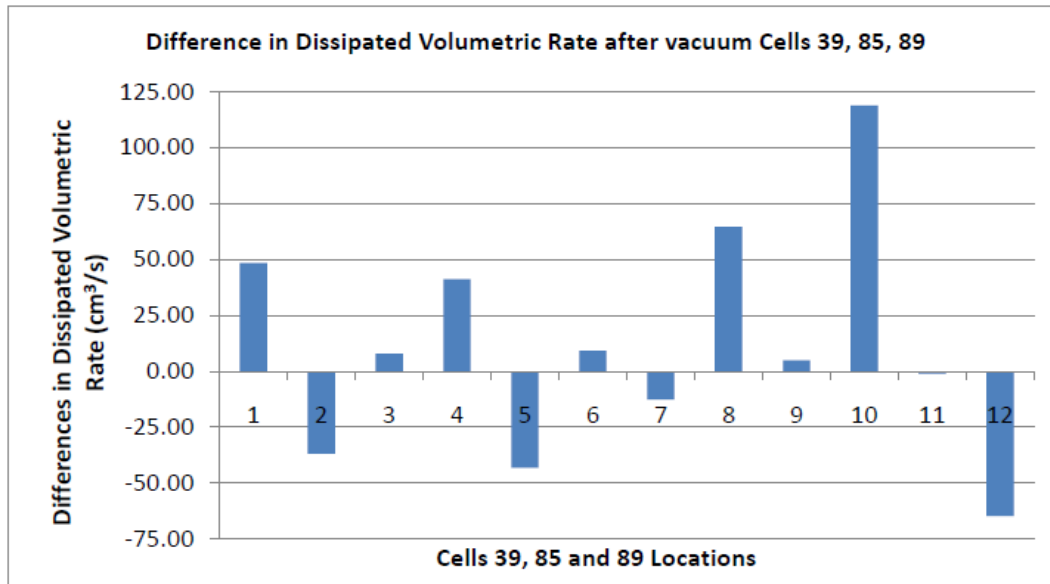

Figure 9.4. Change in dissipated volumetric rate (before and after second vacuuming) (Izevbekhai and Akkari (2011)).

Interpretation of the data for the first and second cleaning do not indicate there is a clear beneficial impact on infiltration capability from vacuuming the surface. Thus, the data do not support the notion that vacuuming can restore infiltration capacity of a pervious concrete surface. Furthermore, the large variation in DVR values, even within one cell, suggests that the mix was highly variable and of uneven consistency within a single cell. Based on these results, Izevbekhai and Akkari (2011) recommended vacuuming pervious pavements twice per year.

Inspection of the pavement and the contents of the vacuum receptacle revealed that the most common clogging compound in the MnROAD test cells were particles from pavement raveling, which were in various stages of fragmentation. Some cities have found organic particles, which may shrink or swell with moisture content, to be more prevalent. Other studies have found that silt particles, transported onto the pavement surface by vehicles are most common (Fwa et al. 2001). Another possible cause of clogging is the reduction in void content due to heavy traffic loading.

Izevbekhai and Akkari (2011) state that a pervious pavement that is not maintained for 4 years will become clogged and that the original void content cannot be restored if the pavement is in service for extended periods. Furthermore, clogging can lead to pavement degradation when water that becomes trapped in the pores, freezes, expands, and damages the pavement when

expanding. If regularly maintained by vacuuming, however, Izevbekhai and Akkari (2012) state that the porosity and infiltration capability of the pavement can be maintained. If the clogging is due to a reduction in void content due to traffic loads, however, vacuuming will not help restore or maintain infiltration capability.

9.1.1.5 *Lessons learned from MnROAD Pervious Concrete Test Cells*

The pervious concrete test cells at MnROAD have been monitored and tested for over two years. Results of hydrological, structural and maintenance performance revealed a positive picture of pervious pavements and, in general, the test cells performed well compared with conventional concrete pavements. Inconclusive results were obtained in certain topics that need additional investigation. The following conclusions were drawn from MnROAD pervious concrete project:

1. IRI values on both pervious concrete test cells are significantly higher (i.e. worse) than FHWA standards for acceptable pavements but the cells had excellent surface ratings,
2. The dissipated volumetric rate varied substantially within a given cell. This suggests uneven consistency within the pavements,
3. The dissipated volumetric rate was generally higher in the cell over sand (cell 85) than the cell over clay (cell 89),
4. Full-depth, pervious concrete cells had a reduced temperature gradient throughout the pavement, base, and subgrade. Results indicated they also may have experienced less freeze-thaw cycling,
5. Vacuuming of pervious pavements more than twice per year is more effective than lighter maintenance schedules and this frequency can maintain pervious pavements at acceptable levels over time. Infiltration capacities can be maintained with such a schedule,
6. Raveling may be caused by freeze-thaw cycling of clogged pavements. Maintaining/vacuuming the pavement can reduce raveling,
7. Pervious pavements can be effectively designed with traditional methods such as that in the AASHTO 1993 method or the Mechanistic Empirical Design Guide method,
8. Programs such as ISLAB can accurately analyze pervious concrete pavements,
9. Falling weight deflectometer (FWD) deflections are higher in pervious concrete pavements than conventional concrete, but it is not known how this affects durability.

9.1.1.6 Porous Asphalt Test Cells

Two porous asphalt (PA) test cells and one conventional, dense-graded asphalt test cell (cell 87) were constructed, monitored, and tested at the MnROAD low volume road test facility (see Figure 9-1). The two PA test cells were identical except that one was constructed on top of sand (cell 86) and one on top of clay (cell 88). Test loading began in December 2008 and testing and data collection continued until December 2011. At the time the report was completed (Lebens and Troyer 2012), the pavement had been subjected to approximately 40,000 equivalent single axle loads (ESAL's).

The porous asphalt test sections were constructed according to MnDOT (modified) Specification 2360-Porous Asphalt, which is based on the National Center for Asphalt Technology (NCAT 2000) Method, with some modifications. The NCAT method specifies minimum asphalt content, maximum drawdown, 17 to 19% voids, maximum abrasion loss, and retained tensile strength ratio, among other requirements.

The specifications for the PA test cells at MnROAD included the following (Lebens and Troyer 2012):

- Minimum asphalt content 5.5% - 6.5% by weight
- No recycled material
- Mix Gradation; 100% passing $\frac{3}{4}$, 75% retained on #4 (no Class B aggregates allowed)
- LA Rattler Loss <35% for any individual source.
- Mineral Filler allowed / Maximum Draindown < 3%
- Coarse Aggregate Angularity >55% (No Fine Aggregate Angularity Spec)
- Coarse Aggregate Absorption <2%
- Voids in Coarse Aggregate (VCA); $VCA_{max} < VCA_{drc}$, where VCA_{max} = Maximum VCA, VCA_{drc} = Voids in coarse aggregate in dry-rodded condition,
- Flat & Elongated Particles < 5 (5:1 ratio)
- Maximum Clay Content, Maximum Spall, % Lumps retained on #4
- Air Voids; 17 - 19% (ensures permeability)
- Placement of Asphalt at > 50°F ambient temperature, 275°F minimum mix laydown temperature
- Modified Lottman test; tensile strength ratio (TSR) > 80%
- Mix Storage; 90 minutes maximum
- Mix to be placed with a track paver only
- 10-ton steel wheeled non-vibratory rollers only (1 or 2 passes)
- No vehicular traffic on finished surface for > 24hrs, prevent contamination of pavement surface

Modifications to the NCAT method included using no recycled material (for better mix control), use of only class A aggregate (for better resilience under heavy loading), and the use of a PG70-28 binder (because the original binder, PG64-34, did not meet the TSR>80% requirement).

The PA cross-sections, from top to bottom, consisted of 6 inches of porous hot mix asphalt, 4 inches of railroad ballast, 10 inches of gap-graded base, a Type-5 filter fabric, and the natural sand or clay soil. A schematic of the cross-section is shown in Figure 9-5.

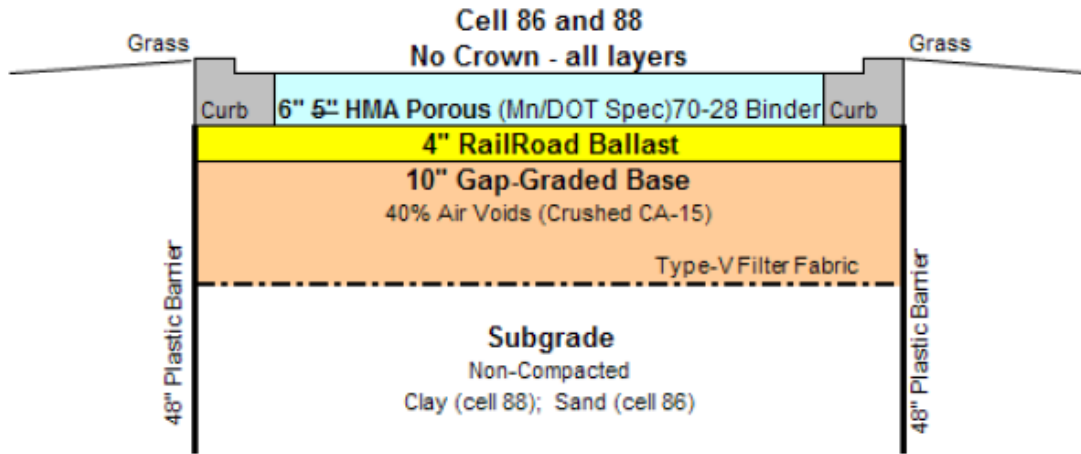

Figure 9.5. Cross-section of porous asphalt pavements tested at MnROAD (Lebens and Troyer 2012).

The testing categories used for evaluating the performance of pervious concrete were also applied to the PA test cells as described below. In addition, the impact the porous asphalt cells had on water quality was investigated.

9.1.1.7 Hydrology and Water Quality Performance

The infiltration capability of the porous asphalt cells was quantified in a similar manner as the pervious concrete cells. Tests were performed on both lanes on both cells and, as a measure of pavement functionality, the minimum flow rate at any test location on a pavement was tracked (Figure 9-6). As supported by Figure 9-6, typically the average infiltration flow rate gradually decreased over time. One exception, however, was the overall increase in this measurement for the outside lane of cell 88.

This could be explained by the fact that during construction soil was spilled onto the pavement surface in the outside lane of cell 88. Although attempts were made to remove the soil, some particles may have initially remained on or in the pavement and slowed infiltration. These same particles could have then been removed or washed off naturally (i.e. wind, rain, etc.) causing an increase in infiltration flow rate. Also, due to the slight raveling that has been observed, it was

thought that some of the clogging may be due to raveling particles but the outside lane (that experience less raveling) experienced a similar decrease.

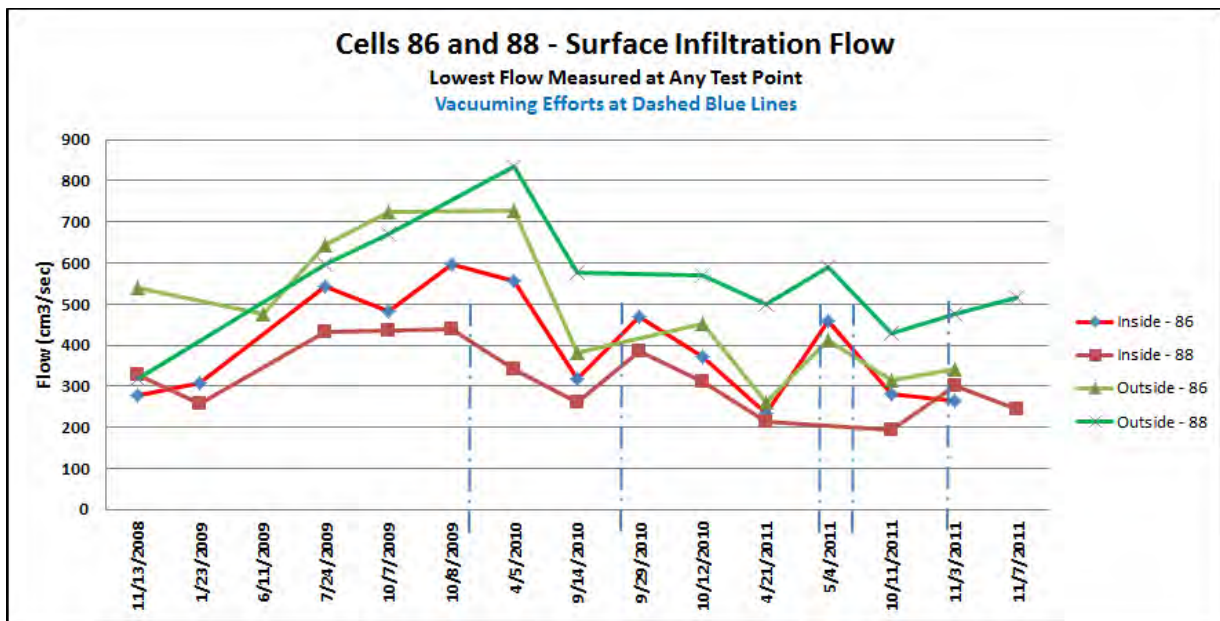

Figure 9.6. Lowest flow measured at any porous asphalt test location (Lebens and Troyer 2012). Dashed, vertical lines correspond to dates the pavement surface was vacuumed.

Although Figure 9-6 shows the lowest flow measurement at any test point, the overall trend also exhibited a decrease in flow rate over time. The lowest measured flow rate, however, corresponded to an infiltration rate of 0.6 in/sec, a value that would be more than adequate to handle a large rainfall event.

Water samples beneath the pavement of each test cell were collected and analyzed for potential contamination. Results were compared to those for Class 2 waters in Minnesota (Table 9-1), which are classified as waters for fishing and swimming. Results listed for cells 86 and 88 are average values computed from data in Lebens and Troyer (2012). In the case when a value was below the detection limit, the value used to calculate the average was assumed to be half of the detection limit.

Baseline groundwater sampling revealed that background concentrations were within the acceptable range of water quality standards and, for the tested constituents, concentrations in pavement runoff were typically lower than those in the groundwater. Groundwater samples taken below cell 86, however, had higher turbidity, copper, and lead than the baseline water samples of two test wells. The porous asphalt cells appear to lower concentrations of copper and zinc. Also, although chloride concentrations were far below the water quality standard, the chloride

concentration continually increased over time until 2011 when no salt was applied during the winter. It is important to note that similar water quality monitoring data was not obtained for concrete cells and hence any comparative water quality performance is not possible.

Table 9.1. Water sampling below pavement results compared to Minnesota Class 2 water quality standards (from Lebens and Troyer 2012).

Parameter	Standard	Cell 86	Cell 88
Turbidity, Naphthalene turbidity units (NTU)	10-25	35.32	78
Suspended volatile solids (mg/L)	NA	4.33	4.05
Suspended solids (mg/L)	rivers 10-65	58.83	59
Solids, total volatile (mg/L)	NA	125.33	73
Solids, total (mg/L)	NA	573.33	365
Nitrate+nitrite nitrogen, Total (mg/L)	NA	2.77	1.1
Kjeldahl nitrogen, total (mg/L)	NA	0.39	0.785
Phosphorus, total (mg/L as P)	12-30	0.13	0.313
Chloride, total (mg/L)	860	113.98	35.9
Chromium (ug/L)	984	7.63	10.5
Copper (µg/L)	9.2	17.87	28
Iron, total (µg/L)	NA	3006.67	3500
Lead (µg/L)	34	1.59	1.7
Mercury (µg/L)	6.9	0.04	0.03
Nickel (µg/L)	789	7.62	5.65
Zinc (µg/L)	65	8.80	7.5
Temperature (°C above for stream)	5	20.83	20.755
Temperature (°C above for lake)	3		
pH	8.5	7.19	9.115

9.1.1.8 Structural and Physical Performance

Similar to the pervious concrete test cells, the porous asphalt test cells were evaluated based on several measurements including: IRI, SR, skid resistance, density, deflection and temperature. Over the course of the study the IRI values for all three asphalt cells changed very little (Figure 9-7). The porous asphalt cells were consistently rougher than the standard dense-graded asphalt cell and cell 88 (clay) was always slightly rougher than cell 86 (sand). It was thought that roller marks put in the pavement of cell 88 during construction resulted in it being rougher than cell 86.

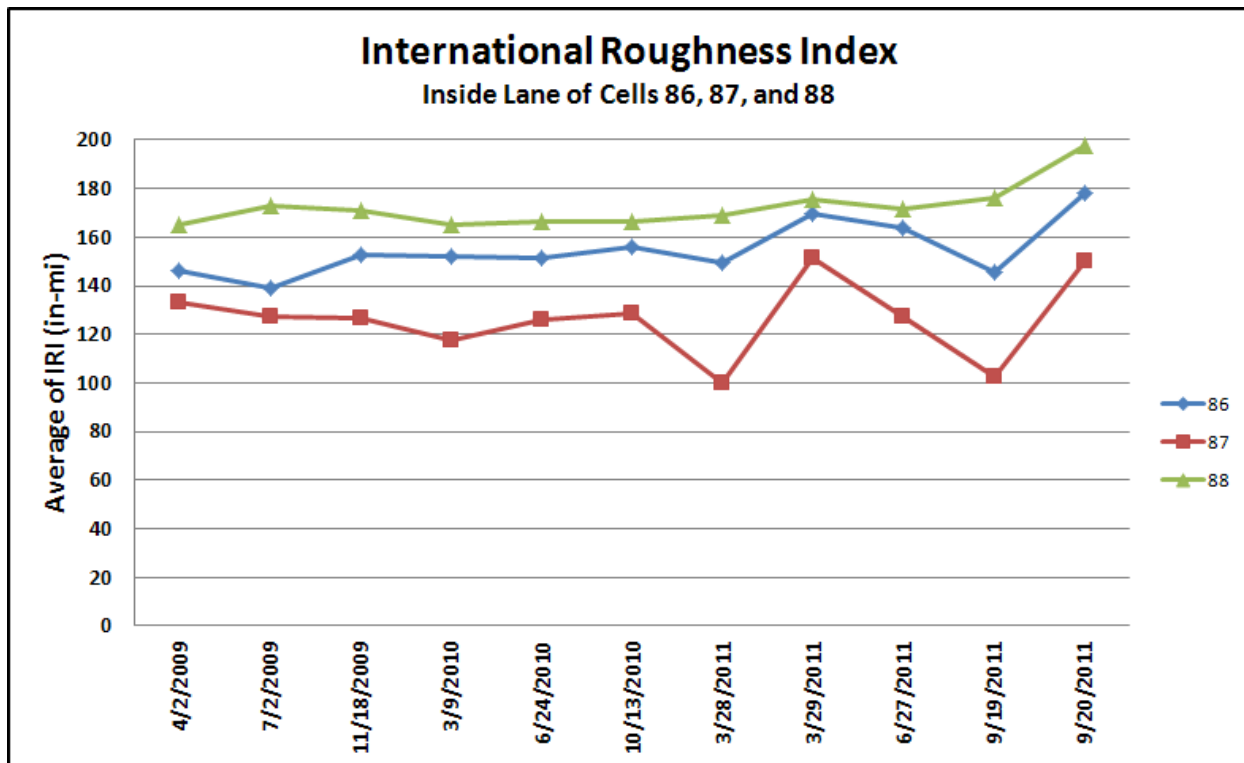

Figure 9.7. Typical International Roughness Index values (Lebens and Troyer 2012).

With regards to skid resistance, both porous asphalt cells had adequate friction numbers (FN) using both smooth and ribbed tires as both pavements had overall average FN's of approximately 50. The conventional dense-graded asphalt cell had FN values less than those of the PA pavements, with the smooth tire FN's being only 50 to 60% of corresponding PA values.

In early 2009 minor surface raveling was observed in patches on the loaded lane of the porous asphalt test cells. Pavement cores revealed that in areas of raveling the pavement was consistent in void content and density from top to bottom and there was no indication of pavement drawdown. Air voids were measured to be 23%, which was higher than the specified content. It was noted that, based on observations, the rate of raveling slowed down after the first few hot days of summer in 2009. Lebens and Troyer (2012) noted that there was likely temperature segregation of the asphalt mix during construction and that this could have led to localized, insufficient compaction, and the isolated patches of raveling.

Rutting has been observed on all three cells but the amount of rutting on the standard dense-graded pavement (<0.16 inch) was much less than that of the porous asphalt pavements (approximately 0.60 inches, on average, for both cells).

Transverse pavement profiles revealed that all three cells experience seasonal vertical distortion. Causes could be the heavy truck loads, movement of base material, and the influence of frost. In 2011, after approximately three years of loading, inspection revealed no longitudinal or transverse

cracking. The unloaded lanes showed only minor raveling and scuffs from snow plow blades and the standard hot mix asphalt reference cell had no cracking, raveling, or signs of distress.

Density is a strong indicator of void content and has been correlated to structural capacity and lifespan of asphalt pavements. Overall, the densities of the PA pavements were about 120 lb/ft³ and the dense mix asphalt pavement had a density of about 142 lb/ft³. Cells 86 and 88 had similar densities over the course of the study with the density of the outside lane of both cells increasing slightly over the testing period. The increase in density in all cases, however, was less than 10% and was typically less than 5%. The outside lane of the dense-graded, hot mix asphalt cell also increased density from about 138 lb/ft³ to 145 lb/ft³. Densities of the inside lane of the porous asphalt pavements increased initially but then either dropped or leveled off. In theory, part of the increase in density of the inside lane could be due to pavement consolidation from the heavy traffic loading but the density of the unloaded, outside lane increased at a slightly higher rate. The minor increases might also be due to clogging and vehicle traffic may clean the pavement surface through tire induced suction and wind, which would lower the density of the traffic loaded lane.

Falling weight deflectometer (FWD) data was collected from 2009 through 2011 on cells 86 and 88 and used to back calculate the resilient moduli of the pavement. The average results for the final year, 2011, are shown in Figure 9-8.

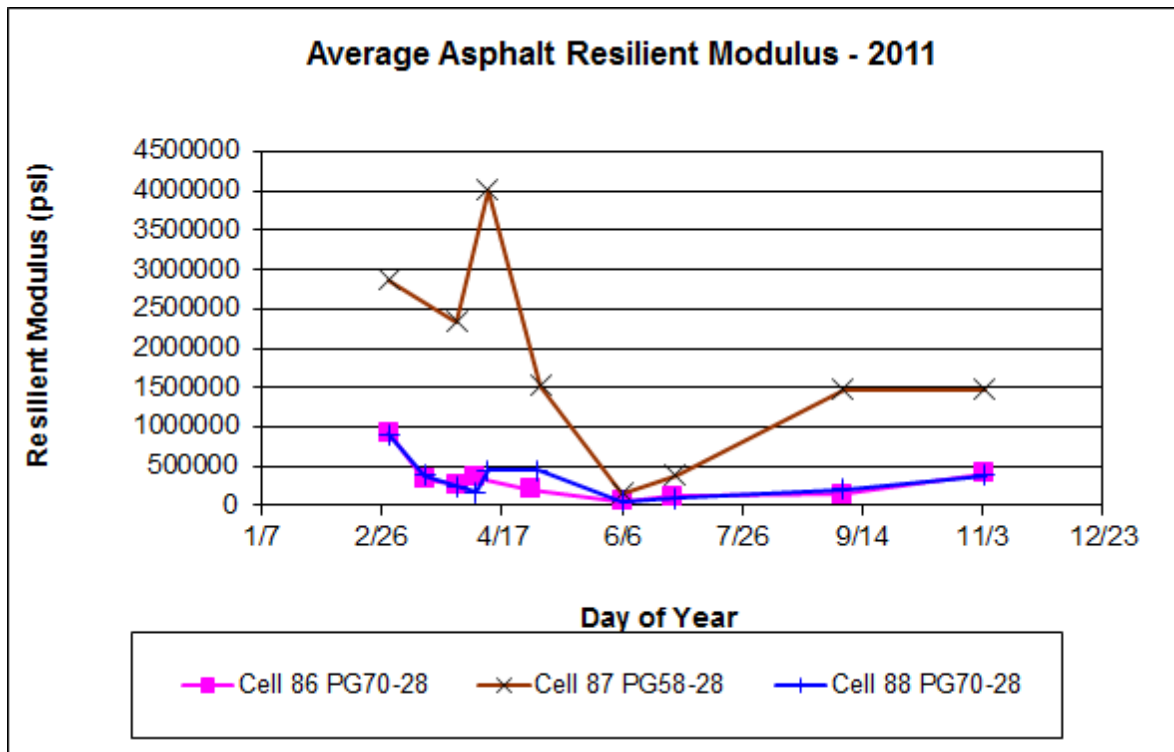

Figure 9.8. Average resilient moduli for final year of testing (Lebens and Troyer 2012).

The resilient moduli for the porous asphalt pavements indicated that these pavements were not as stiff as the dense-graded asphalt. The porous pavements, however, were stiff enough to support

the heavy truck loading they experienced. This lack of stiffness may also be at least part of the reason for the lack of cracking observed in the porous pavements.

Temperature monitoring revealed that the porous asphalt internal temperatures rose above freezing several times over the winter months and, in the spring, also rose much faster than the dense graded, conventional asphalt pavement. In the porous asphalt systems (both cell 86 and 88) the temperature 24 inches below the surface more closely followed the surface temperature as compared to the same measurement in the conventional HMA cell. This is most likely due to the fact that permeable pavements provide more heat transfer between the pavement and the subsurface.

9.1.1.9 *Clogging and Maintenance Performance*

As with the pervious concrete pavements, a Reliakor vacuum truck (with brushes not in use) was used to vacuum the porous asphalt test cells. The first vacuuming occurred in 2009 when the pavement was approximately one year old and in good condition except for isolated patches of raveling. Inspection of the solids in the vacuum truck after vacuuming revealed that a small amount of fine aggregate particles were removed from the porous asphalt cells but almost nothing was removed from the dense-graded, conventional asphalt.

The effect of vacuuming was quantified by comparing flow times of the DVR infiltration tests. In 2009 after the first vacuuming session, flow times decreases by 30 and 23% in cells 86 and 88, respectively. In 2010, after the second vacuuming, the flow time in the outside lane of cell 88 increased by 15%. It was thought that this latter, unexpected result was due to the fact that the pavement was still relatively new and very clean and it was almost impossible to place the testing unit in the exact same location for both the post-vacuuming and pre-vacuuming tests. A minor change in location could result in differing flow times.

In 2011 vacuuming did not improve infiltration capability (i.e. decrease flow times) in the loaded lanes but did so in the non-loaded lanes. Rather, vacuuming appeared to increase flow times on the loaded lanes. This effect is not understood nor is it explained in Lebens and Troyer (2012). As mentioned previously, the increase in flow times in the loaded lanes may be due to a decrease in void content due to the heavy loading. This could be investigated further by CT scans of core samples. When clogging occurs due to a decrease in void content, vacuuming will not improve infiltration.

9.1.1.10 *Lessons learned from MnROAD Porous Asphalt Test Cells*

The porous asphalt test cells at MnROAD were tested and monitored for over three years. Results of hydrological, structural and maintenance performance revealed positive picture of porous asphalt pavements and in general the test cells performed well compared with conventional concrete pavements. Inconclusive results were obtained in certain topics that need additional investigation. The following conclusions were drawn from MnROAD porous asphalt project:

1. Despite the heavy truck loading, the porous asphalt pavements performed well. Observed significant pavement distress was limited to rutting in the loaded lane and shallow surface raveling,
2. PG70-28 binder, a higher temperature, polymer modified binder that is not typically used with porous asphalt, was selected because it performed better than the NCAT 2000 specified PG63-34 binder in the Lottman (TSR) tests,
3. A lightly rolled, two-layer base (4 inches of railroad ballast over 10 inches of CA-15 aggregate) was used to address stability issues with the CA-15 aggregate. This approach is atypical but the system appears to have performed well, indicating that slight compaction of the base had no significant negative impact on performance,
4. The applied loads and clogging do not appear to cause a substantial increase in pavement density,
5. Pavement volumetric rate capacity appears to decrease with time (even with regular maintenance) but the porous asphalt cells was adequate to infiltrate large rainfall events (i.e. lowest pavement equivalent infiltration measured was 0.5 in/s),
6. Raveling in the top one inch of pavement has progressed steadily but initial raveling appeared to be due to mixture temperature segregation and the rate of raveling appeared to slow after high summer temperatures,
7. No cracking or significant distress has been observed in any of the two porous asphalt cells or the reference cell of dense-graded HMA,
8. Average rutting on the PA cells was about 0.60 inches and on the dense-graded reference cell rutting was less than 0.16 inch. These rutting depths were affected by ~1 inch mid-lane settlement and seasonal variability in transverse profile elevation across the entire loaded lane,
9. Construction requirements led to a longitudinal roughness (IRI) on the PA cells of 140 inch/mile, which is relatively high,
10. The resilient modulus of the dense-graded HMA pavement (cell 87) was significantly higher than the PA cells. The stiffness of the PA pavements increased in the fall and decreased in the spring,
11. The clay subgrade appears to reduce PA stiffness, possibly due to slowing drainage,
12. Strain in the PA cell over clay were more than the PA cell over sand and the PA strain, in general, was up to 2 times that experienced by the conventional, dense-graded asphalt cell,
13. The average PA skid resistance value was about 50, which is considered good. Also, due to water being removed from the surface through infiltration, smooth tire skid resistance was about 50% higher on PA than the conventional asphalt,
14. The benefits of vacuuming to restore PA permeability were difficult to quantify, however this maintenance action did show some positive impact on maintaining/restoring infiltration capability,

15. Snow and ice appear to melt more quickly and surface moisture appears to disappear more quickly on PA pavements than on conventional asphalt, especially when in the sun. This is true even in low ambient and freezing sub-surface temperatures. This may allow for a reduction in salt loads on PA pavements,
16. In late winter, internal temperatures of PA pavements increases more quickly than standard HMA,
17. Water quality sampling/monitoring indicates that PA reduces copper and zinc concentrations,
18. Chloride concentrations in groundwater below the PA cells continually increased over time but were below water quality standards for Minnesota Class 2 waters. Chloride concentrations did not decrease until 2011 when salt application was halted.

9.1.2 Porous Asphalt Paired Intersections - Robbinsdale, MN

9.1.2.1 *Background and Project Objectives*

The primary objective of this paired intersection study was to evaluate possible reductions in salt loads on porous asphalt pavements. Additional objectives were to evaluate the durability, maintenance needs, and water quality and quantity benefits from porous asphalt. The driving force for this study was Shingle Creek in Hennepin County, MN, which is listed as an impaired water body for biota, low dissolved oxygen, and excess chloride. Eighty-five percent of the chloride load to Shingle Creek originates as road salt (NaCl) applied by public municipalities for winter ice control. The remaining portion of the chloride load is likely from salt used in parking lots, sidewalks, etc.

The chloride Total Maximum Daily Load (TMDL) study for Shingle Creek found that chloride loading must be reduced by 81% for Shingle Creek not to exceed the chronic exposure limit of 0.23 mg/L over four days or the acute limit of 0.86 mg/L. Thus, this project was initiated by evaluating the use of porous asphalt as an alternative method to reduce winter salt application while maintaining public safety and achieving the chloride TMDL goals.

To achieve the stated goals of the study, two porous asphalt pavement intersection were constructed: one over a sand subbase and the other over a clay subbase. Each site was relatively clear of tree cover and each had a nearby control or reference intersection that was constructed with conventional dense-graded asphalt. The porous asphalt sections were not salted during the winter and the conventional asphalt sections were salted as usual. The sites were monitored and observations were recorded for three winter seasons.

9.1.2.2 *Test Sites Mix Design and Construction*

The locations of each site are shown in Figure 9-9. Site 1 was constructed in 2009 and had a sand subgrade that had an infiltration rate of more than 1.5 inch/hour (0.001 cm/s). Site 2 was constructed in 2010 and had a clay subgrade that had minimal infiltration. The exact location of the test and control intersections at each site are given in Figure 9-10. The test section of Site 1

was at the intersection of 41st Avenue North and Abbott Avenue North with the control section one intersection to the east at 41st Avenue North and Zenith Avenue North. The test section of Site 2 was at the intersection of 27th Avenue North and Ewing Avenue North with the control section one block to the east at of 27th Avenue North and McNair Drive North.

The porous asphalt sections were designed to store the 2 year return period rainfall in the underlying reservoir layer. The cross-section of the permeable pavement consisted of, from top to bottom, a four inch thick, full-depth porous asphalt layer, a two inch thick choker course consisting of 0.5 inch crushed stone, a 12 inch thick reservoir layer of 1.5 to 2.5 inch granitic stones with a porosity of 35 to 40%, and a geotextile fabric on top of the subgrade. An overflow drain pipe that conveyed water to a nearby catch basin was also placed near the top of the reservoir layer. The cross-section is shown in Figure 9-11.

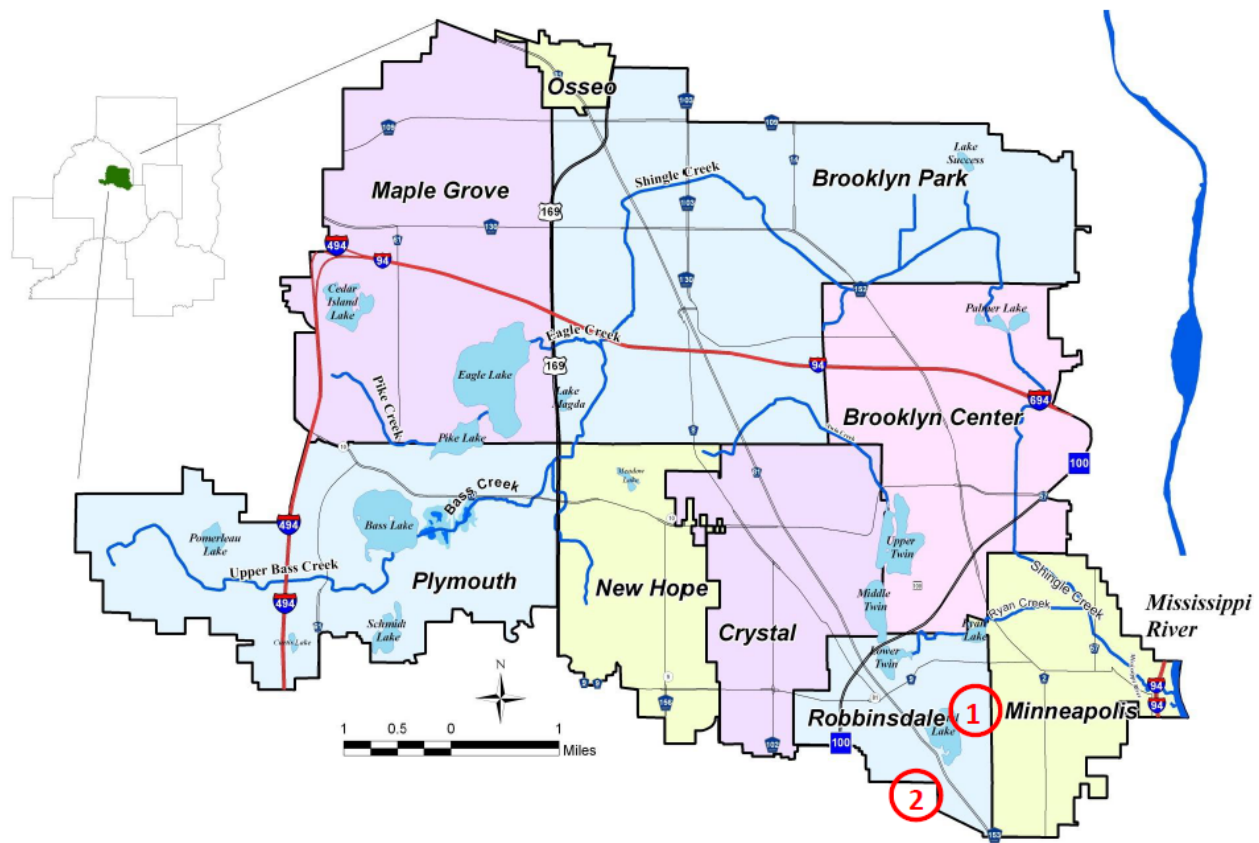
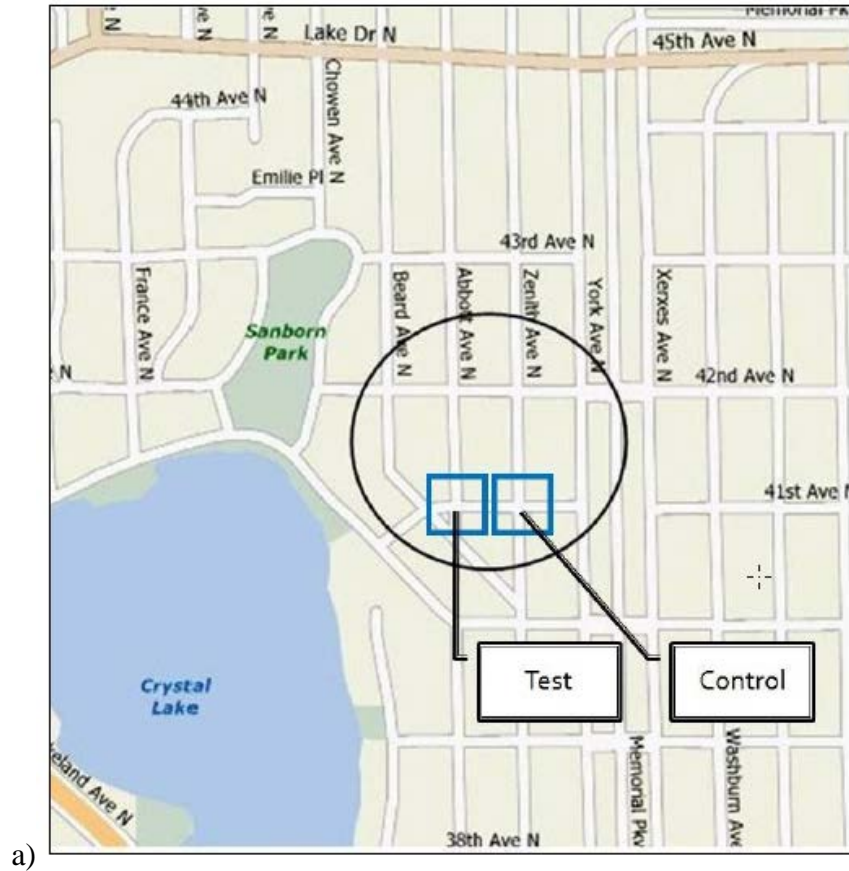
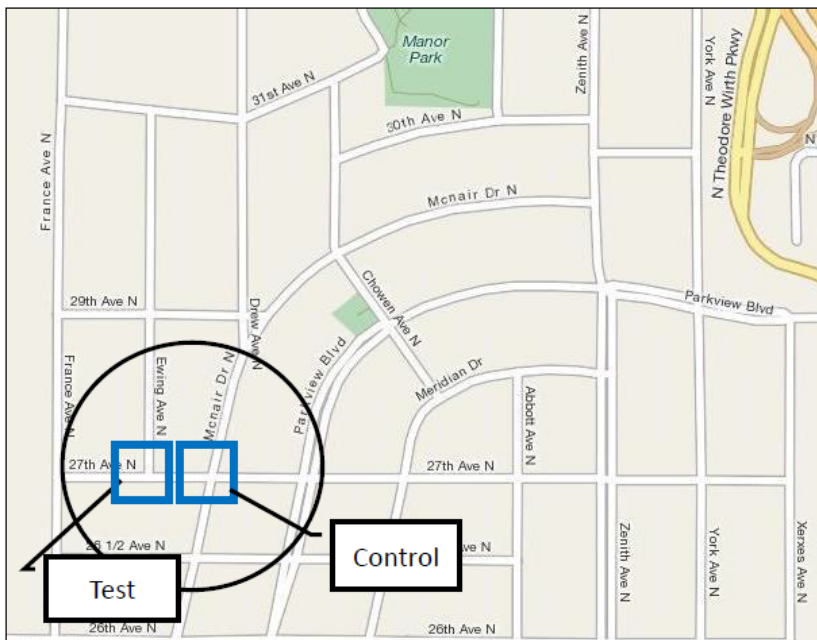

Figure 9.9. Porous asphalt study sites (Wenck 2014).



a)



b)

Figure 9.10. Test and control intersection locations. a) Site 1 on sand, b) Site 2 on clay (Wenck 2014).

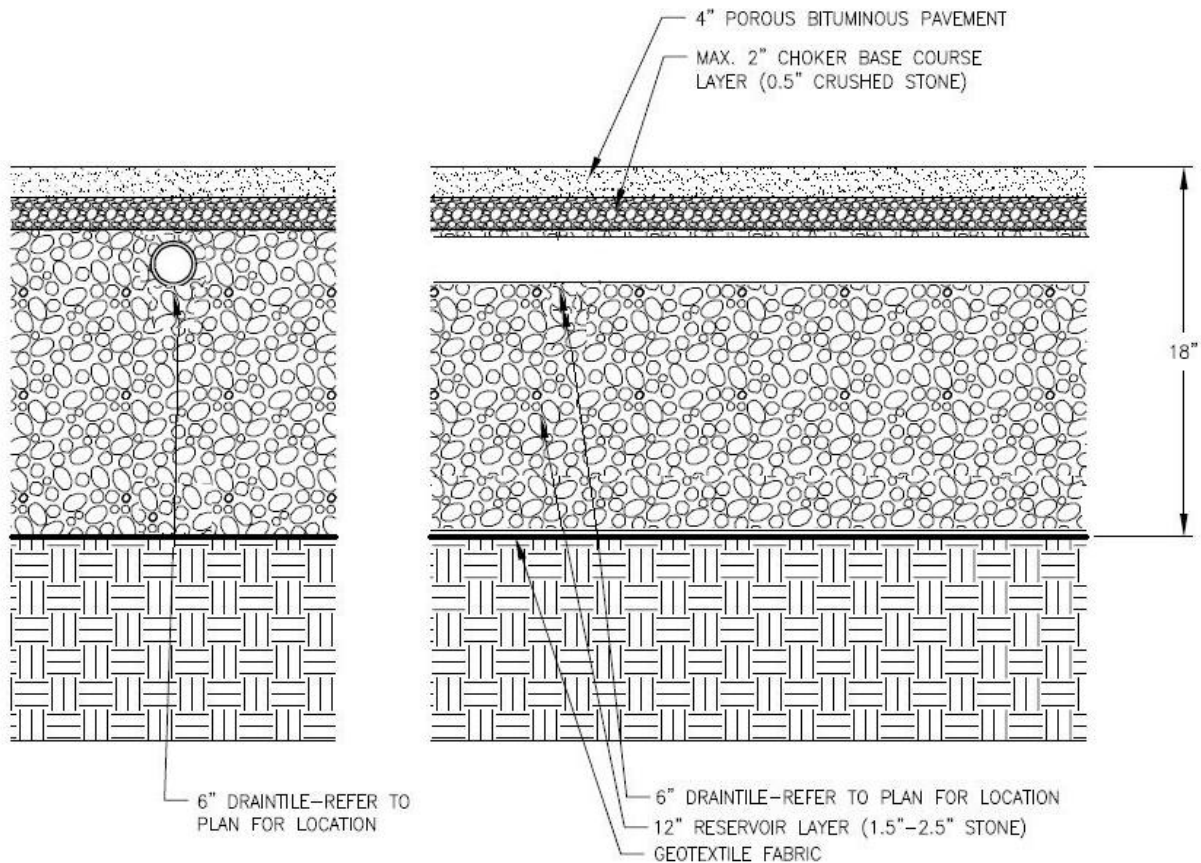

Figure 9.11. Porous asphalt pavement cross-section (Wenck 2014).

The asphalt mix design was prepared by the Minnesota Asphalt Pavement Association (MAPA) in consultation with porous asphalt experts. The resulting mix used harder aggregates (instead of shale) to minimize aggregate moisture absorption and reduce the potential for freeze-thaw heaving. Porous asphalt mixes typically have a low amount of fines in the mix and, thus, are more subject to drawdown in the truck and in place before rolling. Thus, to minimize drawdown potential, a more viscous binder with an added synthetic cellulose fiber was used. No additional details on mix design were available.

The porous asphalt sections were constructed by different contractors but both were experienced in working with porous asphalt pavements. In the truck the bituminous was between 285 and 310 °F and, when laid, temperatures were from 250 to 275 °F. Due to high temperatures, rolling was not performed until about two hours after the asphalt was laid.

Each porous asphalt section was approximately 150 feet long and 28 feet wide for a total area of about 4200 square feet. The cost of the porous asphalt installation at Site 1 was \$42,670 and at Site 2 it was \$32,200. The difference in cost is likely due to the fact that at Site 1 construction

was negotiated as part of a change order and at Site 2 the contract was awarded to the low bidder. Although the cost of the conventional pavement installations was not given, it was noted that most of any increase in cost of the porous asphalt sections would be due to the specialty asphalt and the cost of the special rock used in the reservoir, which was about 25% more expensive than the class 5 aggregate that is typically specified.

Temperature sensors were installed at various pavement depths to monitor temperatures on 15 minutes intervals. Sensors were also installed to record the volume of water in the porous pavement reservoir layer. In addition, sampling equipment was installed to monitor water quality of any overflow exiting a drainpipe, and cameras were used to document snow and ice build-up on the pavements.

9.1.2.3 *Hydrology and Water Quality Performance*

Nearly all snowmelt runoff was infiltrated on Site 1. In site 2, some overflow was observed. However, the discharged water sampling was inconsistent and any water quality analysis results were found to be inconclusive with respect to percent load or concentration reductions. Therefore, a majority of the pavement performance was evaluated based on temperature measurements related to reservoir, pavement surface, surface temperature and solar radiation. Results showed that the reservoir temperature in both porous asphalt systems were, during winter months, consistently warmer than the pavement temperature. For example, the temperature at the bottom of the reservoir at Site 1 (top line of Figure 9-12) never were colder than a few degrees Celsius below zero even when the near surface temperatures were much colder. This trend was evident at both sites for both winters that were monitored, although the temperature patterns at Site 2 were less pronounced. During the spring season the reverse was true, in which the bottom of the reservoir was slightly cooler than the pavement surface and air temperatures.

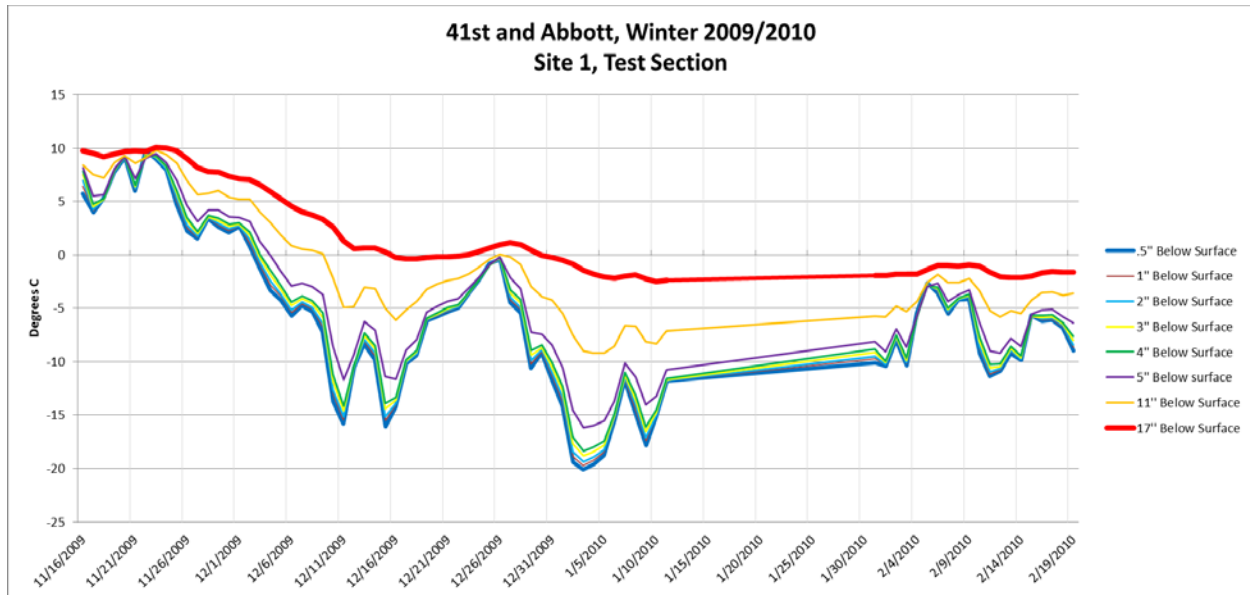

Figure 9.12. Temperatures in porous pavement system at Site 1 (Wenck 2014).

The trend of the reservoir temperature being warmer than the air and pavement temperatures during the winter and cooler during the spring was attributed to the air within the voids of the reservoir layer. During the winter, that air tends to insulate the reservoir and minimize freezing while in the spring it tends to keep reservoir temperatures cooler than air temperatures. The insulating effect may also be, in part, due to the air within voids of the sand subgrade. The warmer temperatures within the reservoir during the winter occur because subgrade soils are warmer than the surface temperatures throughout most of the winter. This suggests that throughout much of the winter the subgrade may be able to infiltrate snowmelt and rainfall runoff and hence preventing the runoff to be discharged into receiving waters and will help to reduce the chloride mass loading. In addition, the surface of the traditional pavements tended to be slushier and the slush would refreeze later in the day when the sun lowered (Figure 9-13). On the porous asphalt sections, however, slush tended to infiltrate and not refreeze on the pavement (Figure 9-14). Overall, this tended to make the amount of bare pavement on the porous test sections comparable to the amount on the conventional asphalt sections, even though the porous test sections were not salted.



Figure 9.13. Slush gathering and refreezing on the traditional asphalt at Site 1 on January 17, 2010 (Wenck 2014).



Figure 9.14. Slush free porous asphalt on January 17, 2010 (Wenck 2014).

Beside the reservoir temperature, both the ambient air temperatures and incoming solar radiation were investigated to determine if one or both of these variables influences the amount of bare pavement on porous or conventional asphalt. Pavement surface temperatures mimicked air temperatures and the warmer air temperatures were correlated with the amount of bare pavement. There was no distinction between the response of the porous and conventional asphalt sections, however, as both had similar melting responses to ambient air temperatures. This was also true of incoming solar radiation. One factor that did appear to explain the variability in the amount of bare pavement was the temperature at a depth of 17 to 18 inches in the porous asphalt sections and the temperature at 18 inches depth in the conventional asphalt sections.

From the existing monitoring data, Wenck (2014) concluded that the unsalted porous asphalt pavement sections had comparable amounts of bare pavement as the salted, traditional, dense-graded asphalt sections. However, heat transfer requires some time, and there was a lag of two or more hours for the melt to begin on porous asphalt compared with the salted conventional pavements. This may make porous pavements less acceptable to the public, although several hours are often required for salting activities to occur on many streets.

9.1.2.4 *Maintenance Performance*

Regular maintenance was performed on the porous asphalt sections by using regenerative air sweeping in the spring and fall. There was some evidence of pavement raveling and parts of the pavements were patched using conventional, dense-graded, non-porous asphalt. The exact amount and frequency of patching was not specified. However, due to the large infiltration capacity observed from the remaining porous asphalt area, the patching did not severely impact the overall infiltration performance of the porous asphalt sections.

Based on the available maintenance observation data, Wenck (2014) concluded that the porous asphalt sections performed as designed and the current maintenance strategy appears to be adequate.

9.1.2.5 *Lessons Learned from the Robbinsdale Paired Intersection Study*

The Robbinsdale paired intersections study monitoring results from the past three winter seasons showed that the porous asphalt sections have performed comparably to the conventional asphalt control sections. Lessons learned and conclusions drawn from the current monitoring data and observations information are summarized below:

1. The unsalted, porous asphalt sections had a similar amount of bare pavement compared to salted, conventional asphalt sections but there was a lag from two to several hours in the bare pavement on the porous asphalt,
2. The porous pavement over sand subgrade was more effective for ice control compared to the porous pavement on clay subgrade,
3. Due to the fact that porous asphalt on sand can infiltrate all or most of the runoff, porous asphalt on sand is more effective at improving water quality than porous asphalt on clay,

4. The temperature at depth (17-18 inches in porous asphalt and 18 inches in traditional asphalt) appeared to be an indicator of the amount of bare pavement on the surface,
5. During three winters, the porous asphalt sections have proven to be durable with respect to the existing snow plow management without any additional equipment or operational adjustments,
6. Both pavements at Site 1 had no visual signs of distress. Using the Standard Rating System for Asphalt Pavements both pavements at Site 1 scored a perfect score of 100 out of 100. Both pavements at Site 2 scored a 99 out of 100. The conventional, control section lost one point due to drainage deficiencies and the porous asphalt section lost one point due to signs of excess binder,
7. Effective maintenance on the porous asphalt sections appears to be vacuuming twice per year and patching with traditional asphalt, as necessary,
8. Site 1 appeared to infiltrate 100% of the runoff it received over the course of the study. In site 2, discharge overflow was observed frequently but water sampling was inconsistent and any water quality analysis was found to be inconclusive with respect to percent load or concentration reductions,
9. Porous asphalt intersections have potential as an ice-control management practice but applications may be limited by subgrade drainage.

9.1.3 Woodbridge Neighborhood, Shoreview, MN

9.1.3.1 *Overview and Focus of the Project*

In the summer of 2009 the City of Shoreview, MN replaced conventional asphalt roads in the Woodbridge neighborhood with pervious concrete. Pervious concrete was chosen as the best alternative, compared with other treatment options such as underground treatment units, underground filtration chambers, and a conventional detention pond, that could sufficiently manage stormwater runoff from the site to nearby Lake Owassa.

Factors used for selecting the use of pervious concrete included:

1. Underlying soils were sandy with infiltration rates of 3 in/hr or more,
2. A hydrologic analysis revealed that a course aggregate drainage layer in the pavement system could contain enough stormwater to eliminate the need for discharge to Lake Owassa,
3. A stormwater collection and conveyance system could be eliminated,
4. Traffic volumes on the road are relatively low,
5. Considering full life cycle costs, the costs of conventional asphalt with a traditional storm drainage system and pervious concrete were essentially equal.

9.1.3.2 Pervious Concrete Mix Design and Construction

The pervious concrete, which had outfall concrete curb and gutter on each side, varied from 15 to 21 feet wide, 7 inches thick, with a coarse aggregate drainage layer under the pervious concrete. The concrete aggregate was 3/8 inch stone and the coarse aggregate drainage layer consisted of 1.5 inch stone (i.e. railroad ballast) and was 18-30 inches thick. In addition, a geotextile fabric was placed between the coarse aggregate drainage layer and the subsoil. The concrete mix had a density of 125 lb/ft³ and 21% (+/- 3%) air voids. The drainage layer was 40% voids and (it was noted that) the angularity of the drainage layer aggregate provided a much more stable base for placement of the pervious concrete. The city's experience with rounded aggregate was that the aggregate tended to be pushed outwards by the wheels of construction equipment whereas the large, coarse, angular aggregate did not move in such a way.

Immediately after placement, a tri-roller screed, which exerted approximately 8,000 lbs of force on the concrete, was used to consolidate the pervious concrete and provide a smoother, finished surface. Subsequent visual inspection of pavement cores indicated that the top 2 inches of the pervious concrete were more compacted than the rest of the concrete. An estimate of interconnected void volume of 32 cores indicated that 17 had higher void volume on the surface, 13 had no measureable difference in void volume and 2 had lower void volume on the surface (Vancura 2010). Within one minute of being consolidated by the roller screed, a curing blanket (Ultracure ®) was placed on top of the concrete. The curing blanket, which remained on the concrete for seven days, had a water absorbing material on the lower side, in contact with the concrete, and an impermeable poly backing on the upper side. When placed, the curing blanket was pulled from a container of water so it was fully saturated and placed on top of the concrete. The water absorbing material provided water to the concrete as it cured and the poly backing prevented moisture leaving through evaporation. It was also noted that during the curing period there were at least a few periods of rain, which may have aided the curing process.

One to two days after pouring, joints were cut into the pervious concrete with a diamond tip blade. No raveling or spalling of the concrete near the sawn joints has been observed. Saw cut joints are recommended for two reasons, 1) rolling joints deforms the pervious concrete and increases the surface area of the pervious concrete at the joint, which may cause more evaporation and affect the curing process, and 2) rolling joints has the potential to create a lip or obstruction that may be damaged by a snow plow blade. Figure 9-15 shows a close-up picture of a saw cut joint.



Figure 9.15. Saw cut joint in pervious concrete at Woodbridge neighborhood, Shoreview, MN (photo courtesy of M. Maloney, City of Shoreview).

After placement, it was observed that crews manually tooled the pervious concrete to create a clean looking margin in locations near the curb and gutter. Working pervious concrete tends to cause compaction, which can reduce or eliminate infiltration capacity. Pooling of water on the pavement surface has been observed in the areas where the concrete was hand worked. Thus, it is recommended that the concrete not be worked in that manner.

Although the roller screed worked well in straight sections, some difficulty was encountered when moving the equipment around curves. In some instances, the equipment had to be physically moved or "walked" around a curve or corner. This involved picking up and moving the outer end of the screed forward so the screed as a whole could navigate the corner. Later, an impervious area (approximately 10 ft by 15 ft) in the pervious concrete in a corner was observed. It is believed that there is some association between the methods employed when navigating the corner and the impervious area of the pavement. All straight sections of pavement were found to be highly permeable.

9.1.3.3 *Water Quality and Hydrology*

In an effort to allow for samples of infiltrated water to be collected, three sampling wells were installed over 40 feet below the ground surface in the vicinity of the pervious concrete system prior to construction. Some samples were collected and analyzed by the Minnesota Department of Health to provide a baseline during the first year the project was in use. Based on available literature, most pollutants are typically filtered, adsorbed, or otherwise retained in the upper 30 to

50 cm of soil. Groundwater contamination, especially at a depth of 40 feet, would not be expected to occur soon after a permeable pavement installation. Groundwater contamination could occur, however, in the future when the soils capacity to adsorb contaminants is exhausted. The time required for this to occur depends highly on soil characteristics and contaminant loads but typically ranges from years to hundreds of years. Thus, periodic monitoring of wells for potential contamination would provide valuable information.

Testing by Izevbekhai and Akkari (2011) indicate high variability in the ability of the pervious concrete to infiltrate runoff, which suggests uneven material consistency of the concrete. The testing determined the dissipated volumetric rate (DVR) of the pavement at several different locations (Figure 9-16). The DVR, which is considered an indicator of the pavements ability to infiltrate water, is not a direct measure of permeability or hydraulic conductivity but rather is a falling head test in which the average flow rate of water into the surface of the pavement is determined. Although the DVR measurements do not follow the now available ASTM C1701 permeability test for pervious concrete (Li et al. 2013), the results do indicate infiltration rates of the pavement system. Most locations exhibited a DVR of over one hundred cubic centimeters per second, which would be more than enough to infiltrate runoff from large rainstorms. Some locations, however, appeared to be clogged. especially near the edges where manual working occurred and the Owasso2 test locations where the corner placement techniques may have reduced infiltration capability as previously discussed.

Figure 9-17 shows the change in DVR at each test location from 2010 to 2011. Izevbekhai and Akkari (2011) suggested that the drop in DVR was due to clogging of the pore structure, which may have been due to raveling at the surface or other debris entering the pavement.

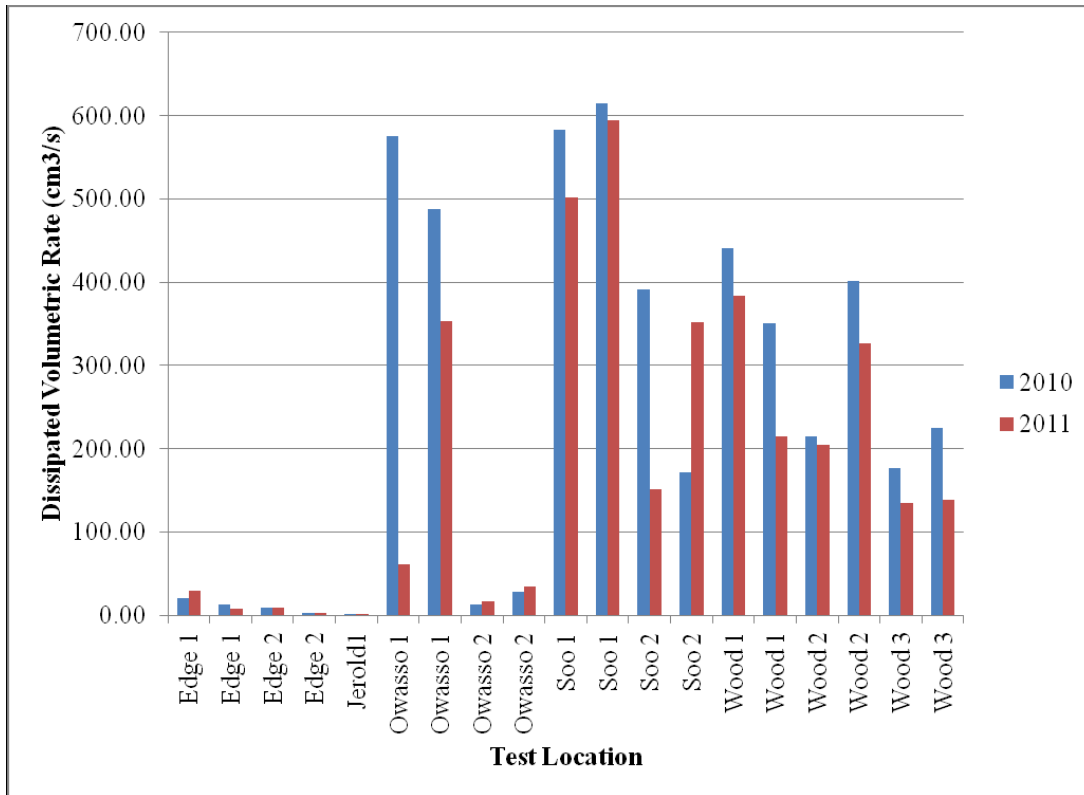

Figure 9.16. Dissipated volumetric rates of Shoreview, MN pervious concrete at various locations (Izevbekhai and Akkari 2011).

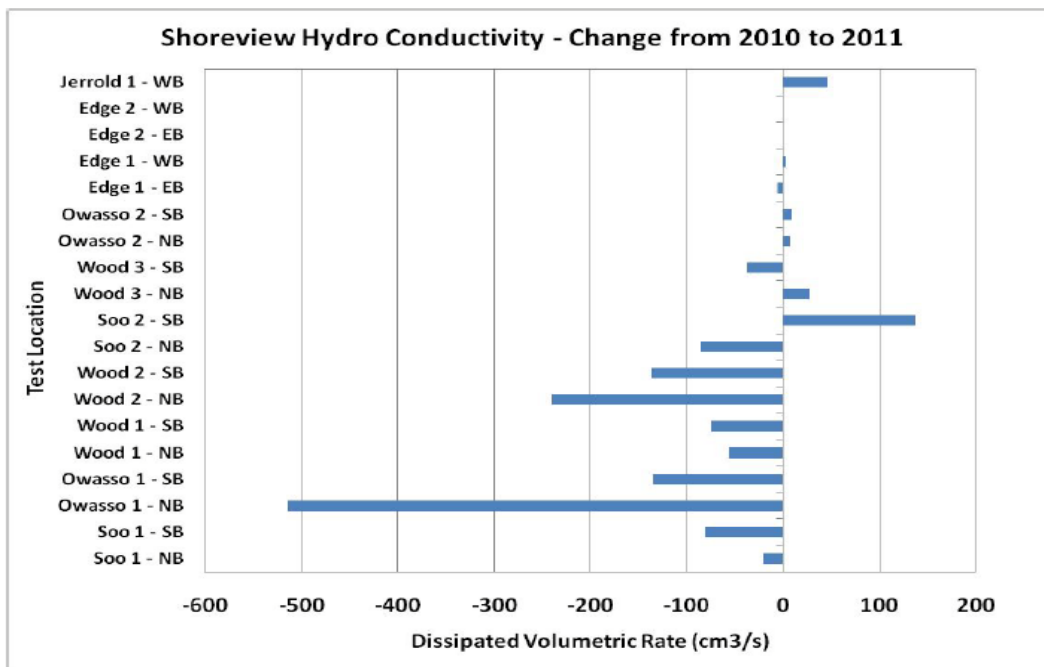

Figure 9.17. Change in dissipated volumetric rate of Shoreview, MN pervious concrete (Izevbekhai and Akkari 2011).

9.1.3.4 *Maintenance Performance*

Based on field tests, the city has determined that regenerative air sweeper provided adequate surface cleaning, maintaining infiltration rates of 300-500 in/hr in most areas. Brushes were not used on the surface as they were determined to mostly push debris deeper into the concrete, exacerbating clogging. Regenerative air sweeping has been performed, on average, once every six weeks. Sweeping is performed after large wind storms as the wind tends to cause more organic debris to fall onto the concrete surface. Visual observation of debris found in the pavement has indicated that organics are the main source of particles and that clogging occurs mostly in the top 0.25 inches of pavement.

During the winter months, sand and salt are not applied to the concrete, the road surface is simply plowed by a one-ton pickup truck with a regular snow plow blade (i.e. not rubber tipped). Road widths and tree clearance do not allow for larger trucks to snow plow the roads.

9.1.3.5 *Lessons Learned*

Overall, the pervious concrete project in Shoreview has performed well in the harsh Minnesota climate. Infiltration rates remain high and most areas have not experience spalling, raveling, or other structural degradation. Two areas, however, have experienced raveling. Both of these areas are located near an entrance to the neighborhood and receive larger volumes of vehicular traffic than other areas of the neighborhood. Also, the nearby roads receive large salt applications during the winter months and vehicles entering the neighborhood most likely transport salt with them when they enter. It is possible that the higher salt concentrations have lead to the structural failure of the pervious concrete at these locations. Also, one of the areas that has experienced raveling is near a T-intersection that experiences a lot of turning traffic, and tire abrasion from vehicle turns may have contributed to the pavement deterioration at that location. The raveled area makes up 1% of the total pervious concrete area. In the future when maintenance is performed and these raveled sections will be replaced with conventional concrete when needed.

After four complete Minnesota winters the pervious concrete roads in the Woodbridge neighborhood in Shoreview, MN have no unusual operational issues and the system is performing as intended. Major lessons learned and experience gained from the Shoreview pervious concrete project are summarized below:

1. Construction practices and curing are important considerations that can help improve chances of having a successful pervious concrete application.
2. During pavement placement the equipment had to be "walked" around the corner and this area did not infiltrate water well.
3. A roller screed was used successfully to finish the surface of the pavement.
4. Pervious concrete should not be manually worked by hand as this will reduce or eliminate void spaces and infiltration capability.
5. Curing should include placing a saturated curing blanket on top of the freshly placed concrete. The curing blanket provides moisture to the concrete during the curing process and helps minimize evaporation.

6. Saw cut joints minimized the chances of obtrusions being caught and sheared off when the surface is plowed to remove snow and also allows the entire concrete placement to cure uniformly.
7. Large and angular reservoir aggregate resists motion and provides a more stable surface for construction equipment and the other layers of the pervious concrete system.
8. Salt or other de-icing agents were not applied during the winter, Snow was removed manually with a one-ton pick-up truck and attached snow plow.
9. Infiltration capacity has been maintained at satisfactory levels by vacuuming with a regenerative air sweeper about once every six weeks. Vacuuming may occur more frequently or as needed after storms with high winds, as these events tend to cause more organics from trees and other vegetation to drop or be blown onto the road surface.
10. Brushes were not used as part of sweeping because brushes may exacerbate clogging by pushing particles into the pavement.
11. Organics were the main source of clogging, which typically occurred in the top quarter inch of the pavement surface.
12. Salt (transported to the pavement by vehicles) and heavy vehicle use (including turning vehicles) seems to have caused pavement degeneration in specific and isolated areas.

9.1.4 City of St. Paul

Two recent permeable pavement applications within the City of St. Paul are discussed below. Even though the projects are quite recent and the long term durability and success of the projects are not known, valuable information and experiences have been gained. These are summarized below.

9.1.4.1 Porous Asphalt Alley

In November of 2012 the City of St. Paul, Minnesota installed a 920 square yard porous asphalt alley near the intersection of Snelling Avenue and Minnehaha Avenue. A typical alley cross-section is shown in Figure 9-18. The aggregate in the asphalt mix had a gradation as shown in Table 9-2, an asphalt content of 6.3%, and a specific voids ratio of 18.0%.

The 4 ft reservoir/base layer was excavated until glacial till was reached and, in some areas, that required excavation down to a depth of several feet or more. The reservoir storage layer was backfilled with crushed, angular quarry rock with a low limestone component. Angular aggregate is recommended (as opposed to round and/or smooth rocks) when structural stability is necessary. The reservoir was designed to have a storage capacity of approximately 13,000 ft³, although the local watershed district regulation caps stormwater storage credit to a volume that is equivalent to 2 inches over the impervious watershed area, which amounts to about 7000 ft³.

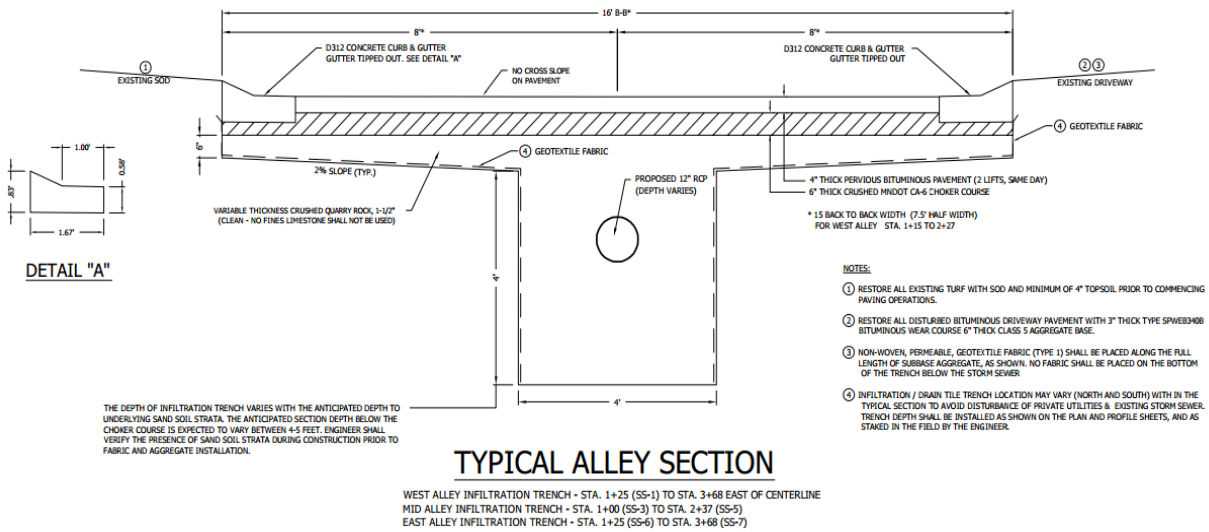

Figure 9.18. Typical cross-section in St. Paul alley project.

Table 9.2. Aggregate gradation used in hot asphalt mix design.

Sieve Size	Percent Passing
3/4 inch	100
1/2 inch	96
3/8 inch	55
#4	10
#8	8
#200	2.1

Prior to construction the existing soil infiltration rate was determined at two locations using a double-ring infiltrometer in accordance with ASTM method D3385. Infiltration rates obtained were 29.0 in/hr and 59.1 in/hr, which were deemed acceptable. Infiltration rates into the porous asphalt pavement at 9 locations were determined in the summer of 2013 according to ASTM C1701. Values ranged from 10 in/hr to 1203 in/hr with an average of 233 in/hr and a standard deviation of 362 in/hr. About one month prior to the infiltration measurements the alley was swept with an Elgin Pelican street sweeper, which is a standard broom sweeper. In August and October of 2013 the porous asphalt pavement was swept again, but this time with an Elgin Crosswind sweeper, which is a regenerative air sweeper. No other infiltration tests have been

performed since construction so the effectiveness of the maintenance efforts could not be determined.

9.1.4.2 Permeable Paver Parking Area

The City of St. Paul has installed permeable pavers in a parking area on Victoria Street between Jasmine Avenue and Orchard Avenue. The system receives runoff from the street and adjacent properties. Limited design and/or construction information was available, other than a typical cross section (Figure 9-19) and a plan/profile drawing.

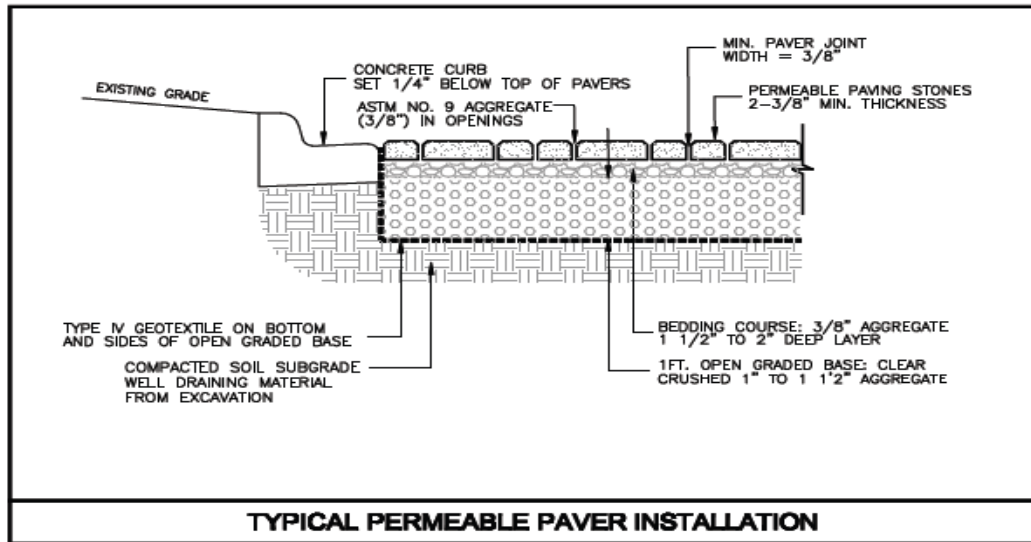

Figure 9.19. Permeable paver cross section used on Victoria Street project.

In order to maintain the system, the City of St. Paul has developed a draft document containing Standard Operating Procedures that includes primary and secondary operational procedures.

Primary operational procedures are:

1. Inspection before and after sweeping that identifies:
 - Heaving or warping of pavement surface
 - Damaged or misaligned pavers
 - Excess sediment or debris on surface and, if so, how much
 - Condition of drainage spaces between the pavers
2. Sweeping of the pavement surface twice per year using a regenerative air sweeper
3. Proper disposal of collected solid waste material

II. Secondary operational procedures are:

1. Replacement of pavers that are damaged or missing
2. Backfill with 3/8 inch stone when drainage spaces are 1 inch low, on average, throughout the entire area
3. Avoidance of winter sanding
4. Consideration of street sweeping a third time

Assessment of the system also includes determining the infiltration rate once every two years. At present the lessons learned and experienced gained from this project is limited because no monitoring and maintenance performance data is available.

9.1.5 Ramsey Washington Metro Watershed District (RWMWD)

The Ramsey Washington Metro Watershed District has been involved in projects using permeable pavements. Two such projects are discussed below.

9.1.5.1 *Permeable Asphalt Parking Lot at RWMWD Offices*

The parking lot at the RWMWD offices was redone in 2005 with porous asphalt pavement. The pavement has performed adequately over its life. Some spalling was observed over the first summer, apparently due to friction from tires of turning vehicles as it was only observed in the main travel lane. Water levels in the reservoir under the pavement have been monitored for eight years and only two over-flow events have been recorded over that time.

At about three to four years of age, it was observed that the center drive lane was infiltrating water due to clogging. Overall, however, the system still infiltrated water adequately. This was because water from the center drive lane would travel towards the pavement edge and infiltrate at other locations (e.g. in the parking stalls). Thus, even though the center drive lane was no longer performing effectively, the rest of the pavement had the ability to compensate for lack of infiltration in the clogged center area.

Regenerative air sweepers without brushes have been used for maintenance (typically twice a year). Initially maintenance was performed mechanically with brushes, but this was found to only push materials into the pavement. Regenerative air sweeping seems to improve infiltration capability but does not pull clogging material out of the pavement. The cost of using the regenerative air sweeper on the 18 stall parking lot was estimated to be approximately two hundred dollars per sweeping. It has also been noted that oblique pressure washing helps restore infiltration capacity but the pavement quickly clogs afterwards.

9.1.5.2 *Porous asphalt cul-de-sacs in Woodbury*

Two cul-de-sacs were installed in Woodbury in 2005. Total runoff and some water quality parameters were monitored for the first two years after installation but there is no pre-installation data to use as a comparison.

After installation it was noted that, due to the curb being tilted inward, water did not flow onto the pavement but instead travelled down the curb to a catch basin. The curb was reinstalled to prevent this from happening and, although the reinstallation has helped, water still trickles down the curb after smaller events.

Typically the pavement is subject to oblique pressure washing and vacuuming to restore infiltration capacity. Clogging is typically due to grass clipping, leaves, and a little sediment that is in the first quarter-inch of the surface.

9.1.5.3 *Lessons Learned*

The following lessons have been learned:

1. Regenerate air sweeping and pressure washing can at least partially restore infiltration rates of porous asphalt pavements,
2. Mechanical brushes or brooms can push material into the pavement rather than remove it,
3. Clogging was mostly due to organic matter from adjacent vegetation and clogging usually occurred in the upper quarter inch of pavement.

9.2 Other States and Regional Experiences

This section discusses additional experiences gained from the applications of permeable pavement in other cold climate areas within the United States (i.e., Colorado, New Hampshire, and the State of Washington) and Canada.

9.2.1 Denver, Colorado Experience

9.2.1.1 *Background*

The Urban Drainage and Flood Control District (UDFCD) from Colorado has experience with permeable pavements dating back to at least 1994 when grid pavers were installed in the Lakewood City Shops maintenance buildings parking lot. Since then the UDFCD has been involved with the installation, monitoring, and testing of several other porous asphalt and pervious concrete pavement sections. This case study presents a summary of some of these installations, their performance, and the lessons learned. The impact on water quality of some of these sites has also been investigated through monitoring and analysis of stormwater influent and effluent samples. A summary of water quality impact of two such sites is also presented.

9.2.1.2 *Pervious Concrete Installations*

Although there are many more pervious concrete installations within the UDFCD region, the below listed projects are some of the initial projects for which information is available.

1. 2004 - Pervious concrete in the parking lot of a Wal-Mart in Aurora, CO
2. 2004/05 - Pervious concrete in the parking lot of a Safeway grocery store in Denver, CO
3. 2005 - Pervious concrete at the Lakewood City Shops maintenance buildings
4. 2005 - Pervious concrete in the parking lot of the University Plaza

Information on the mix designs and the cross-sections used in the above listed projects are not available. The only related information available is that of admixtures used in the Lakewood City Shops installation. Those admixtures were PolyHeed Mid-Range Water Reducer (improves workability, enhances late age strength), DELVO Hydration Stabilizer (improves workability

time), air entraining admixture (improves durability), and Rheomac Viscosity Modifying Admixture (improves flowability, keeps concrete from segregating, and reduces paste drain down).

9.2.1.3 *Structural and Hydraulic Performance of Pervious Concrete Installations*

By 2008, some problems were noticed with the structural performance of most pervious concrete installations as outlined below.

1. Raveling was observed at the joints in the Aurora Wal-Mart parking lot (Figure 9-20). At least some of these joints were noted to be saw cut.
2. Surface erosion in the Denver Safeway parking lot (Figure 9-21)
3. Surface erosion of the University Plaza parking lot (Figure 9-22)



Figure 9.20. Aurora Wal-Mart pervious concrete parking lot in 2008 (photo courtesy of K. MacKenzie, UDFCD).



Figure 9.21. Denver Safeway pervious concrete parking lot in 2008 (photo courtesy of K. MacKenzie, UDFCD).

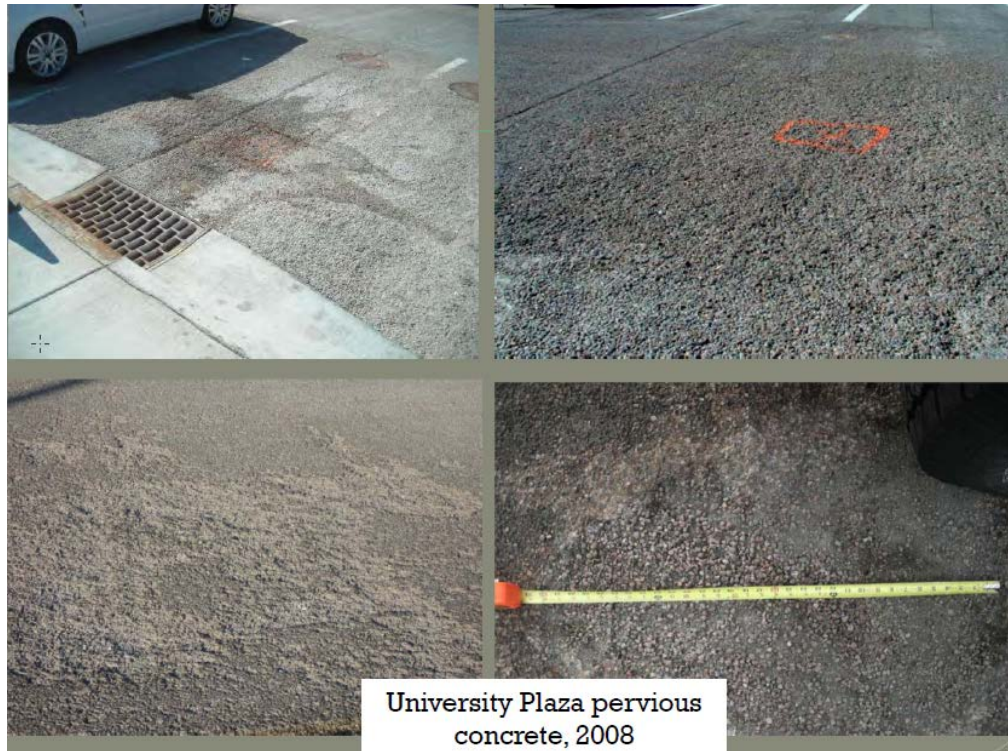

Figure 9.22. University Plaza pervious concrete parking lot in 2008 (photo courtesy of K. MacKenzie, UDFCD).

The failure of pervious concrete pavement installations and the lack of successful structural performance in Colorado led the UDFCD to issue a June 2008 moratorium on the use of additional pervious concrete installation until further investigation.

The UDFCD hired CTL Thompson, Inc. to investigate select pervious concrete parking lots in the Denver Metro area to determine the cause or causes of the pervious concrete failure. Through field observations, pavement sample collection, and laboratory testing, possible causes of the pervious concrete failure were determined to be as follows:

1. Lack of uniformity in the void content,
2. Poor air entrainment in the cement paste,
3. High chloride content (both applied to the surface for deicing and carried in by vehicles),
4. Consolidation of cement paste in the lower half of the pervious concrete cross-section.

This led to an impermeable lower layer, the collection of water in the upper layer, and frost wedging in the upper layer.

Additional possible causes of the pervious concrete failures were deemed to be:

1. Placement during adverse weather (i.e. too hot or too cold),
2. Loss of hydration water during curing.

Based on results from the CTL Thompson study, the UDFCD worked with Colorado Ready Mix Concrete Association (CRMA) to develop the following guidance document: "Specifiers Guide for Pervious Pavement Design" and, in August 2009, lifted the moratorium on pervious concrete.

Key elements in the new design guidelines specification include the following:

1. Pervious concrete must have 6% ASTM C33 sand content,
2. Placement cannot occur when the temperature during the initial cure will be greater than 90 °F or less than 40 °F,
3. The pavement cannot dry out during the curing process. It must be fogged with water and covered with plastic,
4. Rolling compaction shall be achieved using a motorized or hydraulically actuated, rotating, weighted, tube screed that spans the width of the section placed and exerts a minimum vertical pressure of 10 psi (69 kPa) on the concrete,
5. Cross rolling shall be performed using a roller specifically designed to smooth and compact pervious concrete,
6. Cross rolling should be performed using the minimum number of passes required to achieve an acceptable surface. Over working the concrete surface will close voids and limit porosity,
7. Contraction joints shall be constructed by rolling or forming, if the owner desires joints. The sawing of joints is discouraged due to the sediment introduced into the pavement and the increased probability of raveling along the joints. Rolled joints shall be formed using a 'pizza cutter roller' to which a beveled fin with a minimum depth of ¼ the thickness of the pavement has been attached around the circumference of the roller,
8. Joint material shall be ¼ inch or ½ inch (6 mm or 13 mm) flexible foam expansion joint with relative density of 1.7 or higher, meeting ASTM D 4819-88, or vinyl expansion joint in compliance with ASTM D 1751 or ASTM D 1752.

In 2009 a pervious concrete demonstration pad was constructed according to the new design specifications (specified above) at the National Renewable Energy Laboratory (NREL) in Golden, CO. In 2011, after only two years of service, the surface of this pervious concrete was heavily deteriorated as shown in Figure 9-23.

As a result of the structural failure at the NREL site with new design specifications and with the unfavorable structural performances from the other sites using old design guidelines, the UDFCD issued a memo in a January 2013 to remove pervious concrete as a possible SCM from their stormwater SCM manual. This decision will stand until the pervious concrete industry demonstrates that a pervious concrete installation in Colorado can perform at least for five years with no sign of failure.

9.2.1.4 *Structural and Hydraulic Performance of Porous Asphalt Installations*

The most well documented porous asphalt installation by the UDFCD is that of a section of parking lot at the Denver Waste Management Building installed in 2008. The porous asphalt pavement consisted of 2.5 inches of open-graded hot mix asphalt on the surface, a course aggregate reservoir, a filter layer consisting of ASTM C33 sand, and an underdrain layer, all as shown in Figure 9-24. All aggregate material in the asphalt was to pass the 0.5 inch sieve. The reservoir layer consisted of larger aggregate that also provided structural support. The filter layer, which was added to improve water quality of the effluent, consisted of sand.

After construction it was noted that the porous asphalt section of the parking lot had more ice cover than the conventional asphalt portions. Also, the pavement did not appear to be infiltrating water at the expected rate (see Figure 9-25).

Infiltration capacity testing (according to ASTM C1701) revealed that the porous asphalt had an infiltration capacity less than the required 20 in/hr minimum as set by the UDFCD. Maintenance actions of sweeping, vacuuming, pressure washing with a hand wand, and pressure washing with a fire hose did not increase the infiltration capacity to the minimum required value of 20 in/hr.

As a result of the poor infiltration capacity and the inability of typical maintenance actions to increase this capacity, cores of the porous asphalt were extracted and inspected. Analysis revealed that the porous asphalt was in fact constructed to the design specifications (e.g. about 17% void space, an aggregate gradation slightly finer than designed, and "near target" asphalt content).



a)



b)

Figure 9.23. Pervious concrete parking lot at National Renewable Energy Lab in 2011. a) Deteriorated surface with loose aggregate, b) Close-up of parking stall (photos courtesy of K. MacKenzie, UDFCD).

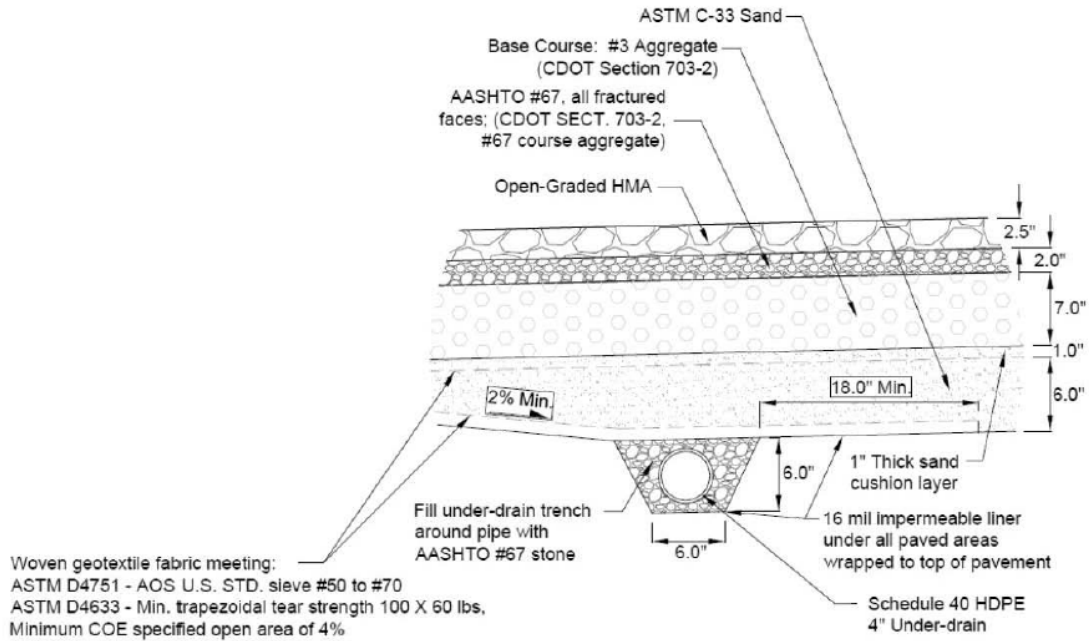

Figure 9.24. Cross-section of porous asphalt pavement at the Denver Waste Management building (UDFCD 2011b).



Figure 9.25. Porous asphalt pavement at Denver Waste Management building after a light rain (photo courtesy of K. MacKenzie, UDFCD).

Infiltration capacity data that was collected for other porous asphalt sites in the region revealed that more than half of these sites did not meet the minimum required infiltration capacity of 20 in/hr. As a result of this and the fact that the infiltration capacity at the Denver Waste Management building could not be increased with available methods (as discussed above), the UDFCD does not recommend the use of porous asphalt as a SCM.

9.2.1.5 *Maintenance Performance related to both Porous Asphalt and Pervious Concrete Installations*

The UDFCD recommended maintenance activities specific to permeable pavements in their Urban Storm Drainage Criteria Manual (2009). Maintenance actions, frequency and the related comments for maintenance of pervious concrete and porous asphalt are summarized in Table 9-3.

Table 9.3. Maintenance activities recommended by UDFCD (2010).

Maintenance Action	Frequency	Comments
Inspection	at least 1/yr	Either during a rain event or with garden hose. Document with photographs/videos. Can use ASTM C1701 to determine infiltration capacity
Debris removal	as needed	Use vacuum or regenerative air sweeper to help restore infiltration. Power washing/blowing should be attempted prior to partial replacement of pervious concrete because saw cutting may cause raveling at joints.
Snow/ice removal	as needed	Pervious concrete: Mechanical snow/ice removal only. Do not use liquid or solid deicers or sand.
		Porous asphalt: Mechanical snow/ice removal is preferred. Do not use sand. Liquid or solid deicers should be used sparingly.
Pavement replacement	as needed	Pervious concrete: Avoid, if possible. If patched, patches should extend to existing isolated joints. Conventional concrete may be used as patch material as long as 90% of the original pervious surface area is maintained.
		Porous asphalt: Conventional asphalt may be used as patch material as long as 90% of the original pervious surface area is maintained.

Specific maintenance actions and experience gained from the pervious concrete parking lot at Lakewood Shops maintenance buildings in Lakewood, CO is briefly described below.

Prior to performing any maintenance actions water was poured on to the pervious concrete surface. Although infiltration was not quantitatively measured, visual observation revealed that most of the water ran off the surface and did not infiltrate the concrete. The first maintenance action performed on the pervious concrete was vacuum sweeping with an Elgin Megawind vacuum sweeper. This sweeper passed over a clogged test area two times and water was again poured onto the pavement surface with no noticeable difference or increase in infiltration. Again, most of the water appeared to run off the surface.

Part of the pavement was then pressure washed with a hand wand and the vacuum sweeper was again passed over the surface twice. Visual observation revealed that the pavement looked cleaner than adjacent areas and, when water was again applied to the surface, the infiltration rate appeared to be more than adequate (i.e. > 20 in/hr is considered the required minimum infiltration rate).

In May 2012 the UDFCD estimated that pressure washing and vacuum sweeping the entire ~2000 square foot pervious concrete pavement would take about eight hours and cost approximately \$1200. Currently, the UDFCD hires a private company to use a regenerative air sweeper on the surface two times per year, once in April and once in October. Each sweeping event takes about 2 hours and costs about \$250.

9.2.1.6 Water Quality Monitoring

The UDFCD has monitored water quality for the pervious concrete that was installed within the parking lot at the Lakewood City maintenance facility sites in Colorado. Two different pervious concrete sections were constructed at this site. One using AASHTO #67 aggregate in the concrete mix and one using a smaller aggregate gradation, AASHTO #8 (Figure 9-26). In addition, another section of the parking lot consisted of conventional dense mix asphalt that served as the control/reference site for the comparison. Both pavements received similar traffic loads and rainfalls.



Figure 9.26. Pervious concrete at Lakewood City Shops maintenance building. AASHTO #67 mix is on the left and AASHTO #8 is on the right (UDFCD 2011a). A quarter is placed on the AASHTO #8 pavement for scale.

The pervious concrete section received runoff from 7077 square feet of adjacent impervious area. This resulted in a ratio of impervious tributary area to pervious concrete of 3.5 to 1, which is higher than the UDFCD recommended maximum value of 2 to 1.

Water flow volume and the related water quality samples were collected by means of automatic samplers. Water flow volume measurement revealed that the pervious concrete reduced runoff volumes between 24 and 38%. However, inconsistencies in flow volumes between the reference site and pervious concrete site as well as between the volume of rain falling on the reference site and the measured volume of runoff (e.g. more measured runoff than measured rainfall), suggest inaccuracies in the flow data.

The concentration of effluent for total suspended solids, total phosphorus, total Kjeldahl nitrogen, and chemical oxygen demand was significantly lower from the pervious concrete than from the

reference site. Many other water quality parameters were investigated with many appearing to be reduced by the pervious concrete. Mean and median values (for combined years of data) of some of the most common water quality parameters are presented in Table 9-4. Only statistically significant differences are listed in Table 9-4. For all results, see UDFCD (2011a). It also should be noted that over the five years of study, the pH of the effluent was consistently increased to above 9 with no downward trend over time.

9.2.1.7 *Lessons Learned*

The experience gained from various porous asphalt and pervious concrete installations in Colorado was not positive. Most installations generally failed to perform according to their structural, hydrological and water quality performance evaluation. Many of the failures were found to be related to mix design and construction methods. Maintenance of these pavements was found to be expensive and sometimes did not improve the infiltration capacity. Because of repeated bad experiences, until further improvement in design and construction, UDFCD does not recommend these types of pavements to be considered as a SCM in the current stormwater manual.

**Table 9.4. Water quality data for Lakewood Shops Maintenance building (UDFCD 2011a).
Non-detect concentrations were assumed to be zero.**

Parameter		Reference Lot	Pervious Concrete	Parameter		Reference Lot	Pervious Concrete
Alkalinity (mg/L)	Median	85	78	Dissolved Copper (ug/L)	Median	5.0	6.2
	Mean	139	111		Mean	5.4	7.3
Chemical Oxygen Demand (mg/L)	Median	18	98	Total Copper (ug/L)	Median	10	10
	Mean	30	106		Mean	11.6	12.8
Chloride (mg/L)	Median	4	50	Dissolved Zinc (ug/L)	Median	11.9	0
	Mean	8	51		Mean	17.4	3.22
Conductivity (umho/cm)	Median	73	87	Total Zinc (ug/L)	Median	47	0
	Mean	124	87		Mean	58	13
pH	Median	6.5	9.4	Dissolved Cadmium (ug/L)	Median	0	0
	Mean	6.8	9.17		Mean	0.084	0.079
Total Organic Carbon (mg/L)	Median	14.0	14.9	Total Cadmium (ug/L)	Median	0	0
	Mean	18.8	14.6		Mean	0.09	0.03
Dissolved Chromium (ug/L)	Median	0	2.2	Dissolved Lead (ug/L)	Median	0	0
	Mean	0.016	2.0		Mean	0.045	0
Total Chromium (ug/L)	Median	0	0	Total Lead (ug/L)	Median	0	0
	Mean	1.7	2.1		Mean	3.2	0.2
Dissolved Manganese (ug/L)	Median	13.4	2.8	Dissolved Phosphorus (mg/L)	Median	0.04	0.05
	Mean	22.9	4.1		Mean	0.05	0.05
Total Manganese (ug/L)	Median	53	43	Total Phosphorus (mg/L)	Median	0.16	0.1
	Mean	76	65		Mean	0.22	0.13
Dissolved Nickel (ug/L)	Median	0	0	Nitrite + Nitrate (mg/L)	Median	0.63	1.65
	Mean	0.89	0.16		Mean	0.74	1.73
Total Nickel (ug/L)	Median	1.8	1.1	Total Susp Solids (mg/L)	Median	64	28.5
	Mean	2.6	0.9		Mean	196	43

9.2.2 New Hampshire Experience

Research projects investigating the use of porous asphalt pavement and permeable interlocking concrete pavement (PICP) in cold climates have been performed at the University of New Hampshire Stormwater Center. This section presents a summary of that work.

9.2.2.1 Porous Asphalt Study

In order to investigate the structural and hydraulic performance of porous asphalt and its impact on stormwater quality, researchers at the University of New Hampshire Stormwater Center (UNHSC) constructed side-by-side, hydraulically separated porous asphalt and conventional asphalt parking lots on campus. The porous asphalt lot contained 17 parking spaces and occupied an area of 5000 ft². The traditional (or dense mix asphalt) lot, which was constructed at the same time as the porous asphalt lot, is the same size and was constructed to serve as a control for the study. An existing, 9 acre dense mix asphalt lot adjacent to the two previously mentioned, smaller lots served as an additional reference for the research.

9.2.2.1.1 Mix Design and Pavement Cross Section Specifications

The cross-section of the porous asphalt lot consisted of, from the existing ground upwards, 21 inches of a stone reservoir with underdrains, 24 inches of a bank-run gravel filter course, 4 inches of a stone choker course, and 4 inches of porous asphalt that was placed in one lift. The filter course is not always included in porous asphalt systems but was included because studies have shown that it can significantly improve the water quality of effluent. This porous asphalt system was designed and constructed according to specifications that were developed by UNHSC. These specifications are available online (UNHSC 2009) and are summarized below.

According to experts at the UNHSC, the two most critical aspects that can help insure a successful, long-term porous asphalt system are proper construction and proper maintenance. The UNHSC (2009) design specifications, which were written to help increase the chances of a successful project, include:

Weather limitations: Only construct a porous asphalt system between mid-March and mid-November. Also, the actual ground temperature should be 50°F or above and the ambient air temperature in the shade away from any artificial heat source shall be 60°F or higher. Finally, paving should not occur when rain is in the days forecast.

Cross-section: The recommended cross-section for a porous asphalt system is shown in Figure 9-27.

The choker course shall meet AASHTO No. 57 gradation, have a maximum wash loss of 0.5%, a minimum durability index of 35, and a maximum abrasion loss of 10% for 100 revolutions and 50% for 500 revolutions.

The filter course shall have a hydraulic conductivity (as determined by ASTM D2434) of 10 to 60 ft/day at 95% standard proctor compaction. The filter course is also known as bank-run gravel or modified NHDOT 304.1.

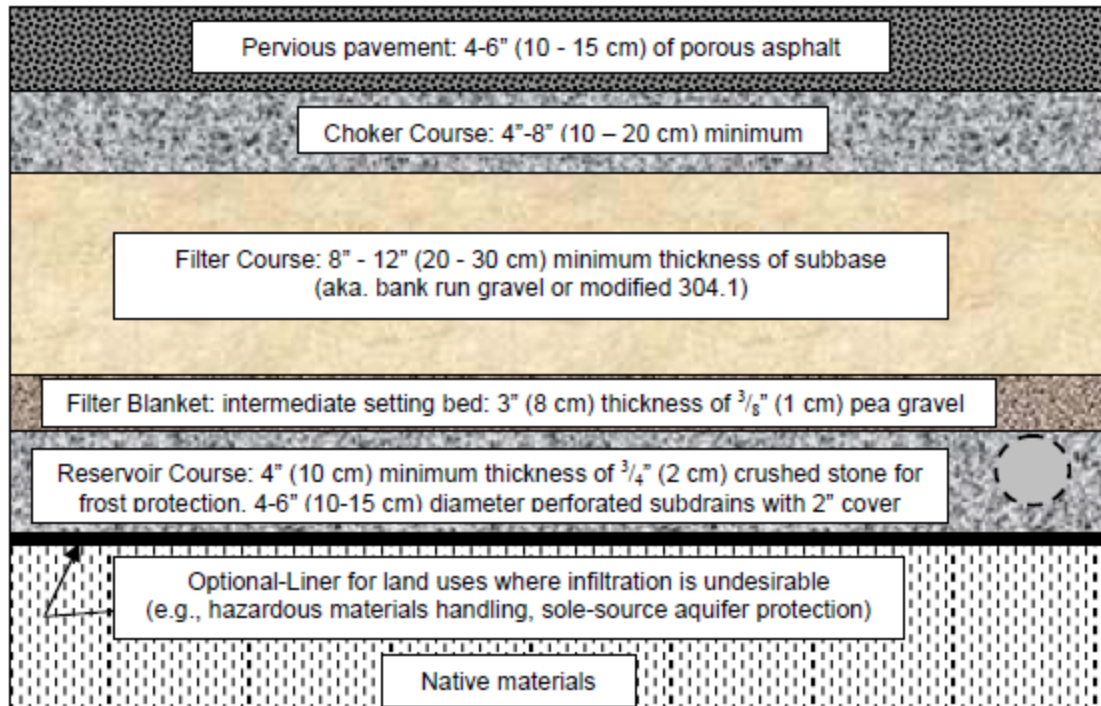

Figure 9.27. Recommended porous asphalt cross-section (UNHSC 2009).

The filter blanket material below the filter course exists to prevent fines from the filter course from migrating into the reservoir course. Thus, the aggregate size of the filter blanket should be bigger than the filter course but smaller than the reservoir aggregate. Typically 3/8 inch pea gravel is acceptable but the gradation of the filter blanket material depends on the gradations of both the filter course and reservoir course.

The reservoir course shall be a minimum of 4 inches thick (if underlying soils are hydrologic soil group A) and 8 inches if subdrains are to be included in this layer. If underdrains are included they shall be at least 4 inches from the bottom of the reservoir course. For the PA parking lot in this study there was a 21 inch stone reservoir with underdrains located 12 inches above the bottom.

A bottom liner is optional and only recommended to prevent infiltration, such as when aquifer protection is desired. Filter fabrics or geotextiles are typically not recommended as these can cause premature failure due to clogging. Instead, if desired, a graded stone filter blanket is recommended. If soils have low permeability, however, filter fabrics could be used around the perimeter of the pavement system (but not within the subbase). The parking lot for this study, included a non-woven geotextile along the bottom and sides of the system. As previously stated, however, fabric on the bottom may cause clogging and this is no longer recommended. Fabrics may be necessary on the bottom, however, if the underlying soils have low load bearing capacity. Consult UNHSC (2009) for additional details regarding aggregates and other design parameters.

The mix design was 18% voids and 5.8% asphalt content. The mix design as specified by UNHSC (2009) calls for modified performance grade asphalt binder, coarse and fine aggregates, and optional additives (e.g. silicone, fibers, fatty amines, etc.). Materials must meet requirements published by the National Asphalt Pavement Association in their Design, Construction, and Maintenance of Open-Graded Friction Courses, Information Series 115 (2002).

The asphalt mix is to be modified with polymer or fiber addition and, for maximum durability, should be two grades stiffer than that required for dense mix asphalt for parking lots. UNHSC (2009) gives much more detailed information and options regarding the mix design, preparation, placement, construction, and quality assurance and control, etc. that are beyond the scope of this document but are important to the design and construction of a successful porous asphalt system. Thus, the reader may wish to consult UNHSC (2009) for those details.

9.2.2.1.2 Hydrology and Water Quality Performance

The porous asphalt parking lot was monitored to assess hydraulic performance and impact on water quality (Roseen et al. 2012). Surface infiltration capacity was measured at three locations over the course of the study and frost penetration was measured every month during the winter. Reported water quality data, however, was for a 15 month span from April 2005 to June 2006. Rainfall depths were measured as was the water quality from the adjacent impervious watershed, which was influent to the PA lot, and compared directly to the PA effluent, which was sampled at the downstream end of the underdrain system.

A water balance was performed over an 18 month time span by comparing precipitation and effluent volumes. Hydrographs were also analyzed and the impact of the PA system was quantified through use of parameters such as the peak flow reduction coefficient, lag time, and lag coefficient.

In a separate study on this same lot, Briggs et al. (2008) tested surface infiltration rates at the three locations investigated by Roseen et al. (2012) plus twenty additional locations. These tests were completed in two days in September 2007 after the PA parking lot had been in service for three years with no maintenance.

Table 9-5 summarizes results related to hydrologic and water quality performance.

Table 9.5. Summary of hydrologic and water quality performance results from University of New Hampshire studies.

<i>Reference</i>	<i>Summary of findings</i>
<i>Roseen et al. (2012)</i>	<ul style="list-style-type: none"> • Infiltration capacity did not decrease during the winter months • Infiltration capacity decreased during the first summer, possibly due to binder breakdown in high summer temperatures • The initial decrease in infiltration capacity rebounded when temperatures decreased • Over the course of the study infiltration capacity decreased due to lack of maintenance • Frost penetration in the porous asphalt lot were much deeper than that in the dense mix asphalt lot • The frequency of thaw periods and the rate of thaw were much greater in the porous asphalt lot • For both monitored winters the porous asphalt lot thawed almost 30 days before the dense mix asphalt lot • The porous asphalt lot reduced peak flow and increased lag time and the lag coefficient for all monitored rainfall events • The porous asphalt lot did not experience surface runoff during the course of the study (including during a 5 inch rainfall event) • Specific conductivity and pH was significantly higher in porous asphalt effluent as compared to influent • There was no statistical difference in porous asphalt influent and effluent dissolved oxygen and temperature • Nitrate concentrations were typically higher in porous asphalt effluent as compared to influent • There was no statistical difference in phosphorus concentrations between porous asphalt influent and effluent • Total petroleum hydrocarbons concentrations were reduced to below detection limits by porous asphalt for most events
<i>Briggs et al. (2008)</i>	<ul style="list-style-type: none"> • The mean infiltration capacity of 23 test locations was about 1700 in/hr even though the pavement had never received maintenance in its three year life • Construction methods, even by the same contractor, can affect porous asphalt performance.

During the first year at two of the three locations, the surface infiltration capacity was greater in the winter than in the summer (*Roseen et. al. 2012*). The mean infiltration capacity of those two locations was 1210 and 679 in/hr. The third location was not constructed properly and as a result had low void content and a corresponding low infiltration capacity (<100 in/hr). The decline in infiltration capacity during the first summer after installation could be due to asphalt binder drawdown brought on by high summer temperatures. The PA mix did not include any fibers or polymer modifiers to minimize drawdown. The summer decrease in infiltration capacity was only observed during the first summer after installation, the following two summers did not exhibit a significant decrease in infiltration capacity. Also, the initial decrease in infiltration capacity did rebound once the weather cooled. Overall, there was no decrease in infiltration capacity during the winter months. There was, however, an overall decrease in infiltration capacity at all three locations over the course of the study due to lack of maintenance.

The mean infiltration capacity of the 23 test locations by Briggs et al. (2008) was about 1700 in/hr (standard deviation = 710 in/hr), which is high considering the lot had been in service for three years and never received maintenance. One of the test locations was classified as clogged (defined to be an infiltration capacity less than 55 in/hr) and standing water was occasionally observed in this area. Overall, the infiltration capacity was deemed to be excellent for 90 to 95% of the PA pavement.

There appeared to be some correlation between void content and pavement pull (i.e. the strip of asphalt as it was laid down during construction) suggesting that construction methods, even by the same contractor, can affect pavement performance. It was noted however, that close inspection revealed that sediment clogging affected infiltration capacities much more than any production or construction difference. Measurements revealed that frost penetration into the PA system was significantly deeper (~27 inches max) than that of the reference DMA lot (~18 inches max). The frequency of thaw periods and rate of thaw was also greater in the PA lot with the PA lot freezing and thawing completely many times over the winter months. Winter thaw events were typically the result of warmer temperatures and rainfall that infiltrated and thawed the PA media. For both monitored winters, the PA lot thawed completely almost 30 days before the DMA reference lot.

With regards to hydrologic performance, the PA lot reduced peak flow and increased the lag time and lag coefficient for all monitored rainfall events, including large storms (e.g. 2.5 inches of rain in 24 hours). Standard pavement flow rates averaged about 45,900 ft³/s-mi² compared to the PA average flow rate of ~53 ft³/s-mi². The average increase in lag time for the PA pavement was 1275 minutes.

For all monitored events, including a 5 inch rainfall, the PA pavement experienced no surface runoff as all effluent left the site via the underdrains. Overall, the water balance revealed that about 25% of all the water entering the PA system (~43,000 ft³) infiltrated into the underlying hydrologic soil type C soils.

Specific conductivity, dissolved oxygen, pH, and temperature was monitored for 17 rainfall events. Specific conductivity was higher in the effluent (average = 1180 uS/cm) than in the influent (average = 415 uS/cm). Effluent dissolved oxygen was lower than influent levels but the difference was not substantial. Effluent pH (7.1) was higher than influent (6.1) and there was no significant difference in influent and effluent median temperatures.

Concentrations of some typical stormwater pollutants were also investigated. Nitrate concentrations were significantly higher in the effluent than the influent for 15 of the 17 storm events. In the two events with lower effluent nitrate concentrations little treatment was observed. Total phosphorus exhibited no significant difference between influent (average = 0.10 mg/L) and effluent (average = 0.08 mg/L). Total petroleum hydrocarbons, however, were reduced to below detection limits for all but one of the monitored events. With half the detection limit assumed to be the concentration for samples reported as below detection limit (as was done with all water quality parameters), the average influent concentration of petroleum hydrocarbons was 1970 µg/L compared to an average effluent concentration of 166 µg/L. Total suspended solids reduction was also statistically significant with an average influent concentration of 54 mg/L and an average effluent concentration of 6 mg/L.

9.2.2.1.3 Maintenance Strategies and Performance Results

Roseen et al. (2014) and Briggs, et al. (2008) investigated different aspects of maintenance for the same porous asphalt parking lot. Their strategies and findings are summarized in Table 9-6.

The impact of different winter maintenance strategies was investigated over two winter seasons (2006-2008) and 48 storms (Roseen et al. 2014). The response to deicing strategies was quantified by measuring skid resistance, degree of snow and ice cover on the parking lots, recoverable chloride loads, and effective salt loads. The winter climate (January through March) in the study area is cold with average temperatures near 28°F and daily maximum and minimum temperatures of 38 °F and 17 °F, respectively. Precipitation from January through March is normally 16 inches and snowfall is 63 inches.

Maintenance Practices

Salt was applied to both the porous asphalt (PA) and dense mix asphalt (DMA) parking lots prior to snowfall events and during or following the event in combination with snow removal. For the first two years a salt-sand mix (10% sand by weight) was applied. Salt application (standard rock salt with less than 10% fines) was done in a manner consistent with typical municipal applications with a standard rate of three pounds of salt for each 1000 ft² of surface area. For the first winter, each lot was divided into four equal areas and in each lot one area received 100%, 50%, 25%, and 0% of the standard salt application rate. For the second winter the entire PA lot received 25% of the standard salt load and the DMA lot received 100%.

Table 9.6. Summary of maintenance strategies investigated and the related performance results from New Hampshire studies.

<i>Reference</i>	<i>Maintenance Topic</i>	<i>Description</i>
<i>Roseen et al. (2012)</i>	Strategies	<ul style="list-style-type: none"> The impact of various salt application rates on deicing was investigated
	Summary of findings	<ul style="list-style-type: none"> The porous asphalt lot was typically free of snow and ice before the dense mix asphalt lot For the same salt application rate, snow and ice on the dense mix asphalt lot was at least three times greater than the porous asphalt lot Porous asphalt areas that received 100% and 50% of the typical municipal salt application rate had consistently low snow and ice cover When the porous asphalt lot received 25% the salt application rate of the dense mix asphalt lot there was no significant difference in snow and ice cover between the two lots The porous asphalt lot had a higher skid resistance than the dense mix asphalt lot Salt loads could be reduced by 64% on the porous asphalt lot with no decrease in safety When porous pavements freeze they can still maintain a high infiltration capacity
<i>Briggs et al. (2008)</i>	Strategies	<ul style="list-style-type: none"> Pressure washing and vacuuming after three years of use and two years of sand application
	Summary of findings	<ul style="list-style-type: none"> Application of sand decreased infiltration capacity Pavement particles were sheared off by snow plow blade Pressure washing and vacuuming effectively removed embedded sediment from clogged areas

Observations and Measurements

To document visual observations, photographs were taken of the lots before, during, and after snowfall events.

The application of sand decreased the surface infiltration capacity of the PA pavement (Briggs, et al. 2008). Also, scrapes from pavement particles that were sheared off by the snow plow blade

were observed in the surface of the PA pavement after the winter. These particles could also have lead to clogging as they break down and potentially fill void spaces within the pavement.

Briggs et al. (2008) also reported that September 2007 maintenance activity that involved a combination of detergent/surfactant application, pressure washing, and vacuuming (with an Elgin Whirlwind MV) was effective in removing embedded sediments from clogged areas. Pressure washing was only performed on significantly clogged areas using a low-pressure hand wand (515 psi) that was held so the jet of water struck the pavement at a low angle.

Skid resistance measurements were taken at locations throughout the parking lots using a British pendulum skid resistance tester (Roseen, et al. 2014) and results were presented as a British pendulum number (BPN). A higher BPN corresponds to a higher skid resistance. Each skid resistance measurement was classified according to the surface cover that existed on the pavement at the time of measurement (i.e. dry, wet, snow, slush, compacted snow, ice). The amount and type of cover in each area was also recorded.

Lessons Learned

The following items are a summary of findings, observations, and statements taken from Roseen et al. (2014) and Briggs, et al. (2008) regarding winter maintenance of porous asphalt systems:

1. The success of a porous asphalt application depends on the pavement design and construction techniques and, after construction, maintenance,
2. Pressure washing and vacuuming can effectively remove particles in the porous asphalt that are causing clogging,
3. Porous asphalt can significantly reduce runoff flow rates and volumes, even on low infiltration soils,
4. Infiltration capacity of porous pavement can be maintained through the winter and freezing conditions,
5. Infiltration capacity may decrease in the summer due to binder breakdown.
6. As long as plowing occurred soon after the end of a snowfall event, it was common for the PA lot to be free of snow and ice earlier than the DMA lot (see Figure 9-28),
7. Standing water was never observed on the PA lot,
8. PA pavements can perform well in cold climates and freeze-thaw cycling does not significantly affect structural or hydrology functions or visibly change the pavement,
9. Porous pavements freeze during the winter but the frozen media can maintain a high infiltration capacity,
10. Freezing rain events will create ice on both PA and DMA pavements when air temperatures are near freezing. When temperatures are above freezing, as was the case in this study, the PA system typically responded with ice melt more quickly than the DMA system,

11. Some events, such as freezing rain, required equal salt loads for both the PA and DMA lot,
12. For both pavements, as the salt application decreased, snow and ice cover increased,
13. For the same salt application rate, snow and ice cover on the DMA lot was at least three times greater than that on the PA lot,
14. Snow and ice cover on the PA lot was less than that on the DMA lot for 60% of the events and the same for 12% of the events,
15. The PA areas that received 100% and 50% of the typical municipal salt application rate had consistently low snow and ice cover,
16. During the second year when the entire PA lot received 25% of the salt application of the DMA lot, there was no significant difference between the snow and ice cover on the PA and DMA lots,
17. PA had a higher skid resistance than DMA for wet, snow, and compacted snow covered pavement (likely due to its large aggregate gradation and irregular surface),
18. The median skid resistance value for the PA lot during the second winter was 8% higher than that of the DMA lot even though the PA lot received only 25% of the salt load of that received by the DMA lot,
19. The regular, adjacent lot that received standard maintenance from UNH ground crews also had a skid resistance value less than the PA lot,
20. Skid resistance values were converted to weighted values to account for the percent of snow and ice cover (i.e. surface type) at each measurement location. Weighted skid resistance values between the two lots were slightly different suggesting that a PA lot that receives 25% of the salt load of a DMA lot may be as safe as the DMA lot,
21. Porous asphalt can increase the specific conductance, pH, and nitrate concentrations of stormwater,
22. Porous asphalt can greatly reduce petroleum hydrocarbon concentrations of stormwater

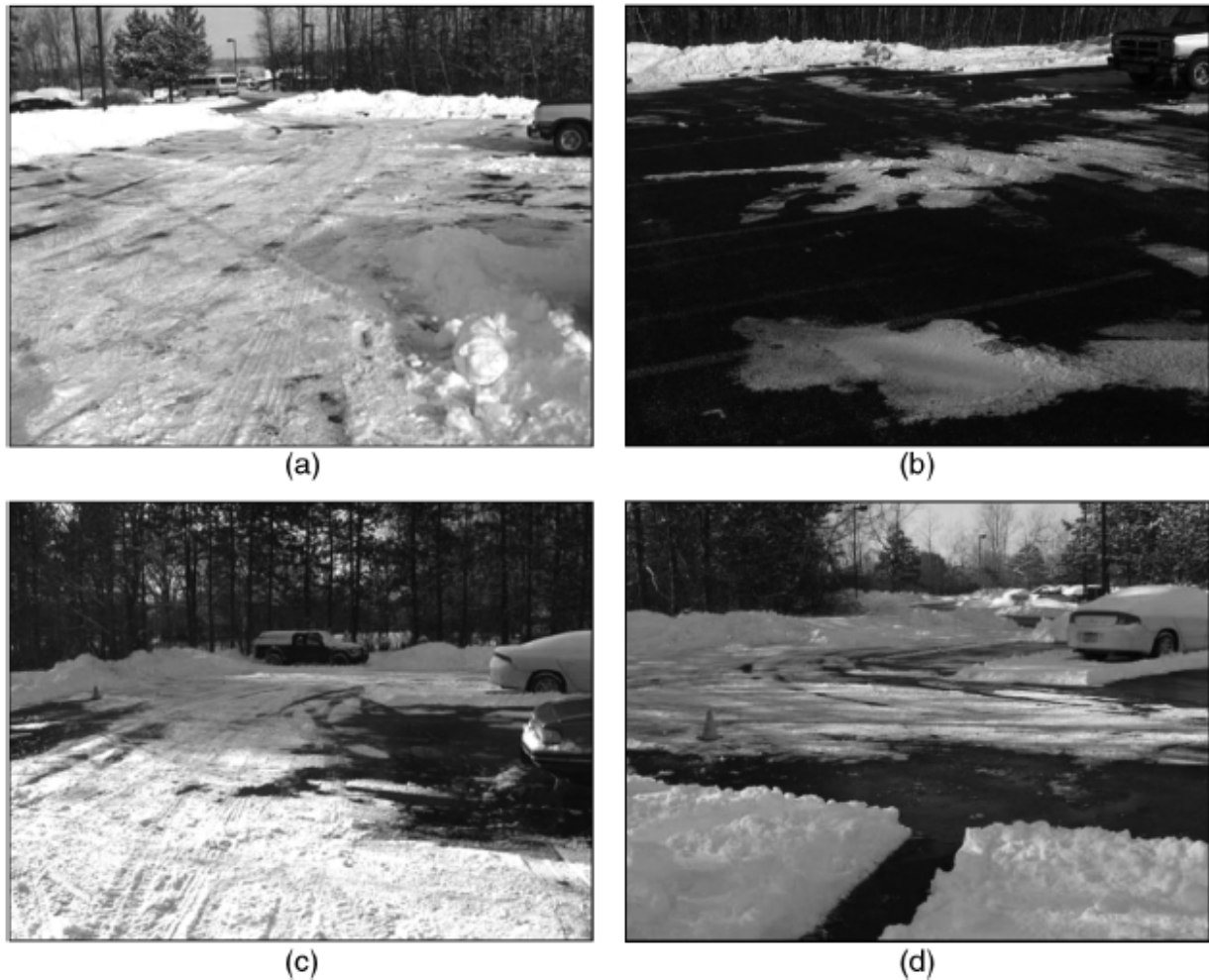

Figure 9.28. Comparison of porous asphalt and dense mix asphalt lot surface cover as a function of time. (a) PA lot at 11:20 a.m. and (b) PA lot 100 minutes later; (c) DMA lot at 11:20 a.m. and (d) DMA lot 100 minutes later (Roseen et al. 2014).

9.2.2.2 Permeable Interlocking Concrete Pavement Study

In order to investigate the performance of PICP in cold climates the University of New Hampshire Stormwater Center (UNHSC) converted a road and an adjoining parking lot on campus from standard asphalt to PICP (Roseen et al. 2013). Relevant project objectives included 1) performance of the system with respect to surface infiltration rates, 2) performance of the system with respect to runoff volume reduction, 3) the impact on water quality and, 4) the thermal performance of the system compared to other pavement types. The PICP system, which was monitored from October 2010 through April 2012, received direct rainfall and, in some locations, run-on from adjacent areas.

9.2.2.2.1 PICP Design and Cross-section

An ICPI recommended cross section (Figure 9-29) was used for the roadway and a modified section with reservoir was used for the parking area. From top down the cross section consisted

of concrete pavers, a 2 inch thick bedding course of ASTM No. 8 aggregate, a 4 inch thick open graded base layer of No. 57 aggregate, a variable thickness stone subbase layer of ASTM No. 2 aggregate, and native soils. The native soils were sandy loam with an infiltration capacity of approximately 3 inch/hr. Perforated underdrains were placed 4 inches above the native soils. Additional details are provided in Rosen et al. (2013). Paver joints were filled with No. 8 aggregate.

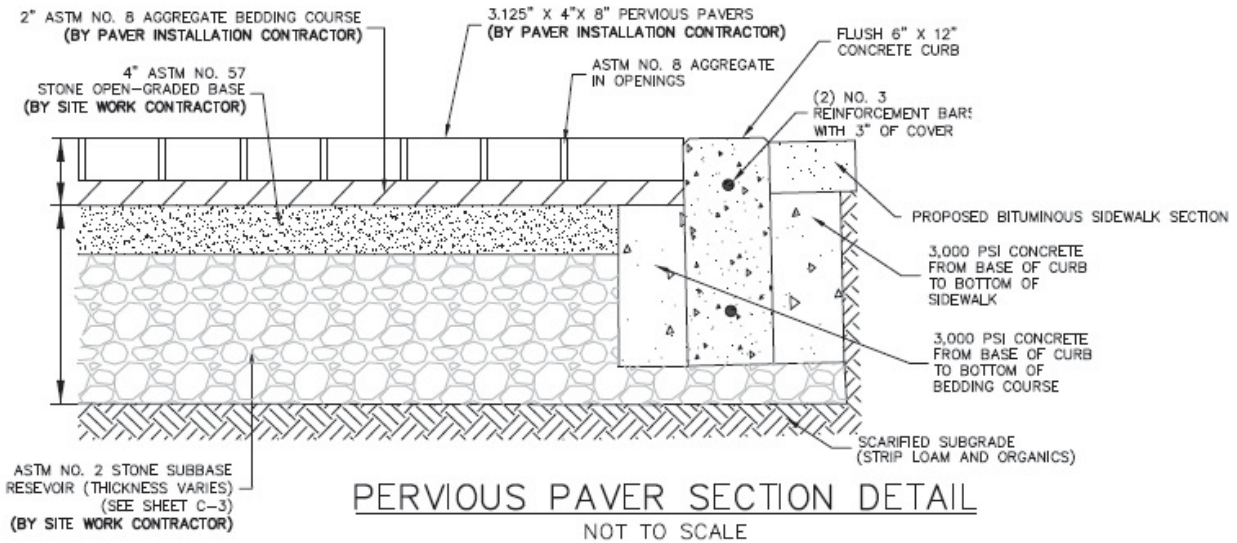

Figure 9.29. Typical PICP cross section (Rosen et al. 2013).

9.2.2.2.2 Hydrology and Water Quality Performance

Surface infiltration rates on the pavement were monitored at three locations throughout the duration of the study using a test similar to ASTM C 1701 for pervious concrete. Location 1, which represents a high use area, was near the entrance to the PICP parking lot and received run-on from a nearby impervious roadway, sediment from vehicles entering the lot, and organic debris from two deciduous trees. Location 2 had less vehicular traffic, less impervious run-on, and was subject to pine needles dropping on the surface from a nearby evergreen tree. Location 3 was located in a parking stall with little traffic and received no significant organic debris. Results of the surface infiltration tests are shown in Figure 9-30.

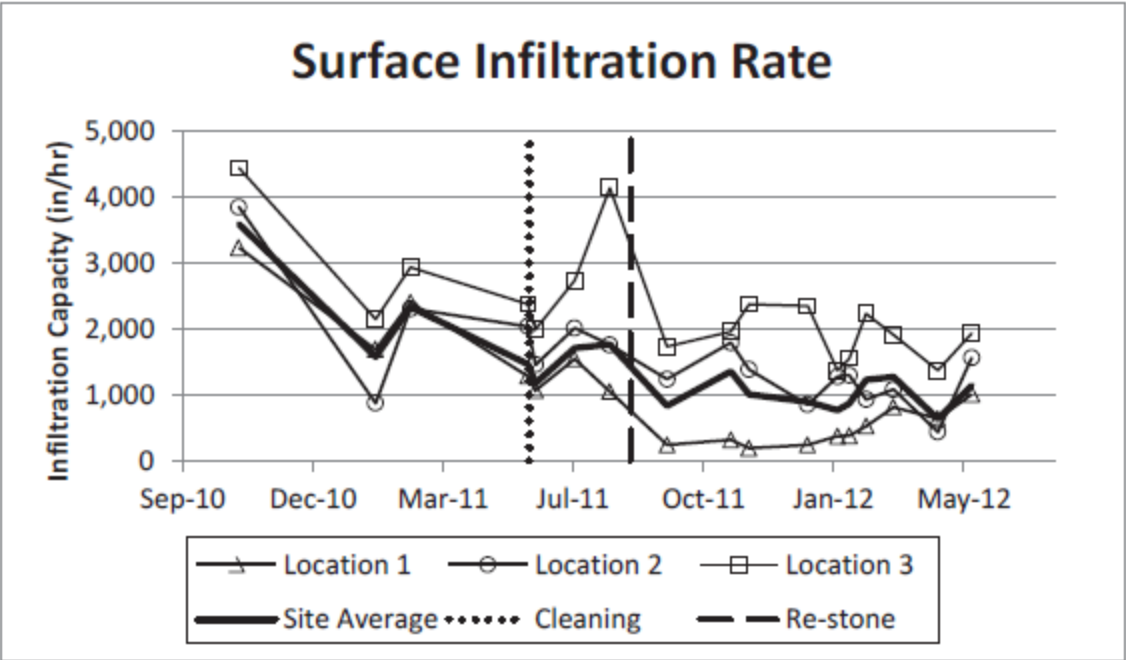

Figure 9.30. Surface infiltration monitoring results (Roseen et al. 2013).

Surface infiltration rates generally decreased over time. After cleaning (vertical dotted line) surface infiltration rates increased but, when additional stone was added to the paver joints (to be discussed later), infiltration rates decreased. The average infiltration rate hovered near 1,000 in/hr, which is more than adequate to infiltrate any reasonable design storm. The surface infiltration rate at Location 1, however, did drop much lower. Numeric values are not reported in Roseen et al. (2013) but from Figure 9-30 it appears values dropped to near 100 in/hr, which should still accommodate any design storm.

Over the study period 26 storms were monitored and the overall volume reduction for the system was determined to be greater than 95%. Compared to surface runoff discharge, contaminant mass load reductions for solids, total zinc, total petroleum hydrocarbons, and nutrients (total phosphorus, total nitrogen) were all found to be over 95% as well. The mass load reduction was achieved due to volume reduction and not a reduction in contaminant concentrations.

The PICP system was also found to be slightly cooler than porous asphalt, pervious concrete, and traditional dense mix asphalt.

9.2.2.2.3 Maintenance Strategies and Performance Results

Pavement cleaning was first attempted in the fall of 2010 with a regenerative air sweeper. The sweeper, however, removed excessive amounts of stone (No. 8 aggregate) from the paver joints and a decision was made to stop sweeping until clogging became more of an issue.

In the spring of 2011, a second vacuum cleaning with a regenerative air sweeper was performed on three areas with significant clogging. The clogged areas had received 1) leaves that became packed in the joints, 2) pine needles that became packed in the joints, and 3) sediment from an adjacent run-on area that clogged the joints. The regenerative air sweeper was not effective in removing the particles from the paver joints. In an attempt to dislodge particles from the paver joints, a leaf blower and pressure washer were used. This dislodged some particles in an upper layer but did not dislodge particles further down in the joints, which were found to also consist of trash and sticks. As before, the air sweeper also dislodged stones from the paver joints.

At this time it was observed that, although winter plowing and freeze-thaw cycling did not dislodge any of the pavers, many of the pavers were loose and wobbly. In August 2011, in an effort to stabilize the pavers, No. 8 aggregate was added to the paver joints. This successfully stabilized the pavers but decreased surface infiltration rates as previously discussed.

As noted by Smith and Hunt (2010) if a regenerative air sweeper is not used regularly, a full vacuum machine is required to clear paver joints of sediment and debris. These machines are stronger, however, and also remove stone joint material. Thus, after using a full vacuum sweeper the stone must be replaced.

Lessons Learned

This study provided valuable and practical information regarding the use of PICP in cold climates. Lessons learned include the following:

1. Surface infiltration rates decreased significantly over time but remained large enough to infiltrate typical design storms,
2. After winter many pavers became loose but loose pavers were successfully stabilized by addition additional joint material (No. 8 aggregate),
3. Pollutant mass load reductions were significant (>95%) and were achieved by runoff volume reductions (also >95%),
4. With minimal clogging, regenerative air sweepers also removed desired joint material,
5. With substantial clogging, regenerative air sweeping did not effectively restore surface infiltration rates,
6. With substantial clogging, full vacuum sweepers were more effective at removing material in the paver joints that caused clogging but also removed No. 8 aggregate that had to be replaced,
7. The notion that regenerative air sweeping should be frequent (Smith and Hunt 2010) was supported.

9.2.3 Washington King County Experience

No specific case study was performed in the state of Washington. Some issues of concern regarding the use of permeable pavements were raised, however, by the King County Road Service Division from the State of Washington. It may be useful for other states to know or learn this information when considering a permeable pavement road application. Thus, the content of relevant information regarding these issues that was presented in a technical memo is summarized below.

The Memo was written on June 13, 2011 in response to a Washington State Department of Ecology proposal requiring the use of permeable pavement when a new or replaced roadway surface is created by projects that are subject to drainage review. The memo expresses many concerns about the widespread use of permeable pavements and communicates specific design requirements and/or situations in which permeable pavement should not be used, in the opinion of the King County Road Services Division. Unfortunately, the negative views are mostly speculative and not backed by fact and proper references related to design, monitoring or maintenance experience gained from studies performed in Washington or elsewhere. A summary of the concerns, opinions, and recommendations indicated in the King County Road Service Division memo are as follows:

1. Porous asphalt does not perform well under medium to heavy traffic but studies have indicated it may perform well in applications related to pedestrian walkways, driveways, parking lots, and low volume roads. It is suggested that locations in Kings County where permeable pavement might be successful include dead-end cul-de-sacs that service no more than 16 lots if soil conditions are conducive to drainage. The memo, however, added numerous situations in which porous asphalt would not be feasible in cul-de-sacs. Those conditions are summarized below:
 - a. The area is a landslide hazard area
 - b. Geotechnical evaluation recommends avoiding infiltration
 - c. The site is within 100 feet of a contaminated site or abandoned landfill
 - d. The site is within 100 feet of a drinking water well or spring
 - e. The site is within 10 feet of a small, on-site sewage disposal drainfield
 - f. The site cannot be designed with a pavement slope less than 5%
 - g. For pollution generating sites, the native soils do not meet treatment criteria
 - h. The site will likely have long-term sediment deposition even after construction
 - i. The site is down slope of areas likely to contribute sediment
 - j. There is a risk of concentrated pollutant spills
 - k. Seasonal high groundwater creates prolonged saturated conditions at or near the surface
 - l. Fill soils that become unstable when saturated are used
 - m. Sand is applied to road surfaces for winter road safety

- n. The porous asphalt would compromise nearby non-porous asphalt pavements or threaten nearby basements
 - o. Underground utilities or underground storage tanks would be threatened.
2. The majority of existing permeable pavements studies are related to parking lots and roads with no traffic or very low speed traffic with low traffic volumes.
 3. Granular capping and subbase layers must be strong enough to provide an adequate construction platform for the overlying pavement layers.
 4. The necessary air voids in the asphalt layer and the infiltration of water into the underlying soil reduces the pavements strength and ability to resist traffic loads. This will also create maintenance and safety issues.
 5. Widespread use of porous asphalt will increase maintenance needs and costs associated with maintenance and pavement repair.
 6. Porous asphalt is more susceptible to damage and wear from studded tires.
 7. Sanding will decrease infiltration capability (according to the Washington DOT, some data indicates a 96% decrease in hydraulic conductivity on pavements treated with sand and salt). Added note: most industry and published work recommend no application of sand on permeable pavement.
 8. Porous asphalt will crack more quickly than dense-graded asphalt. Note: This was not found to be true in the MnROAD study, section 9.1.1.
 9. Maintenance will include patching with dense-graded asphalt and this will create a "patch work" road surface.
 10. Porous asphalt roads would have to be overlaid in a shorter time frame to prevent overall failure but, due to limited funds, this may not occur as needed. The result would be failed and unsafe roads.
 11. Due to durability issues, porous asphalt has the risk of total replacement at the end of its life.
 12. Porous asphalt must be inspected and cleaned regularly using specialized equipment. This will increase costs due to equipment, personnel time, and other resources (e.g. gas).
 13. Porous asphalt and associated infiltration of stormwater may negatively affect underground utilities. The risk of associated liabilities may be too steep for agencies to assume.
 14. Porous asphalt is more open to the air and therefore more susceptible to oxidation damage. This will cause the porous asphalt to crack and ravel more quickly.
 15. The structural number (used in structural design) of porous asphalt is about one-half of that of conventional asphalt. Thus, porous asphalt pavements must be thicker and will be more expensive.
 16. Porous asphalt pavements will have shorter life-cycles and more maintenance needs than conventional asphalt pavements.
 17. A designed water conveyance system may still be required and this will increase the cost of porous asphalt systems even more.

18. There are no standards to test the quality of the porous asphalt.
19. Porous asphalt requires special asphalt oil that may be difficult to obtain.

The King county memo acknowledged that more investigation and research into porous asphalt is needed before widespread usage in the state of Washington. As noted by the experiences gained in Minnesota, New Hampshire, and Colorado, and additional experience gained from Ontario, Canada (see below), some of issues raised in the King County Road Services Division memo have been addressed while some still require further investigation.

9.2.4 Ontario, Canada, Experience

9.2.4.1 Focus of the Project

Drake (2013) investigated the performance of three permeable pavements systems (AquaPave[®], Eco-Optic[®], and Hydromedia[®] pervious concrete) over low permeability soil by monitoring them for over two years. Performance of the permeable pavements was also compared to a control impervious asphalt site. Study objectives were:

1. Identify variables that affect design (such as material, traffic, and maintenance) and assess their impact on the long term function and performance of permeable pavements,
2. Compare the performance of two interlocking permeable concrete pavers, pervious concrete, and traditional, dense-graded asphalt with respect to overall function, hydrology, and water quality,
3. Asses the use of permeable pavement over low permeability soils and determine underdrain requirements,
4. Evaluate the performance of the permeable pavements for two years and identify critical cold climate issues (e.g. winter maintenance and durability),
5. Evaluate and compare the effectiveness of different maintenance practices,
6. Recommend design and operation and maintenance practices to improve permeable pavement performance.

Rainfall events were monitoring as was stormwater runoff and water that had infiltrated into the permeable pavement cells. Monitoring was conducted for 22 months and lasted from September 2010 to June 2012.

9.2.4.2 Permeable Pavements Test Sections Design and Construction

Permeable pavement test sections for each of the permeable pavements investigated were installed in a parking lot at the Kortright Centre for Conservation in Vaughan, Ontario. Each test section (or cell), which were installed in the fall of 2009 and the spring of 2010, had a capacity for eight to ten parked vehicles and was 230 to 233 m² in size. There was one cell for each of the previously mentioned permeable pavements with the fourth cell being traditional, non-porous asphalt.

The cells are separated hydraulically by an above ground curb that extends into the ground and down to the native soils. Under each cell two aggregate reservoirs, one of 19 mm clear stone and the other of 60 mm clear stone, provided runoff storage capacity. The combined depth of the two reservoir layers was at least 40 cm at every location. A typical cross-section is shown in Figure 9-31.

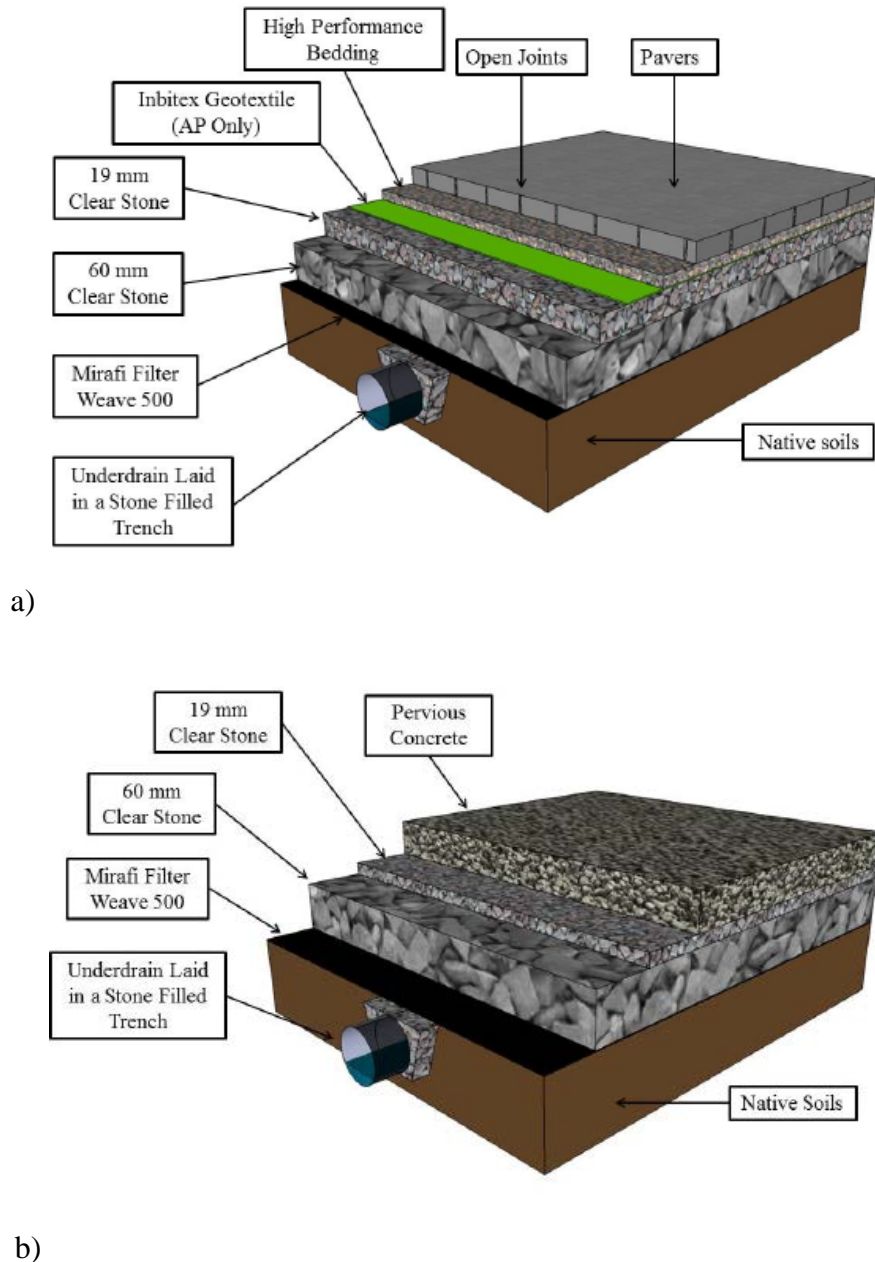

Figure 9.31. Pavement cross-section, a) Permeable interlocking concrete pavers, b) Pervious concrete (Drake 2013).

The AquaPave pavers had 3 to 4 mm wide joints with Engineered Joint Stabilizer (diameter 2-3 mm and fitness modulus of 2.47) and an ASTM No. 9 bedding. Also included in the AquaPave cell was an Inbitex ® geotextile placed between the bedding and aggregate layers. The apparent size opening of the geotextile was 0.145 mm and it had an average flow rate of 4800 L/m²-minute. The Eco-Optic pavers ® had 13 to 14 cm wide joints and used ASTM No. 9 aggregate for bedding and joint material. The Hydromedia ® pervious concrete was supplied by Lafarge. The parking lot and cells are shown schematically in Figure 9-32. Each cell was also drained by a 100 mm diameter perforated drain pipe that was placed in a trench cut into the native soil and backfilled with 19 mm clear stone aggregate. Infiltrated water collected by the drain pipe under each permeable pavement cell was transported by solid pipe to a sampling vault. Each vegetated area shown was about five to six meters wide and about half of the total vegetated area sloped towards the parking lot. Other details regarding the design of the site can be found in Drake (2013).

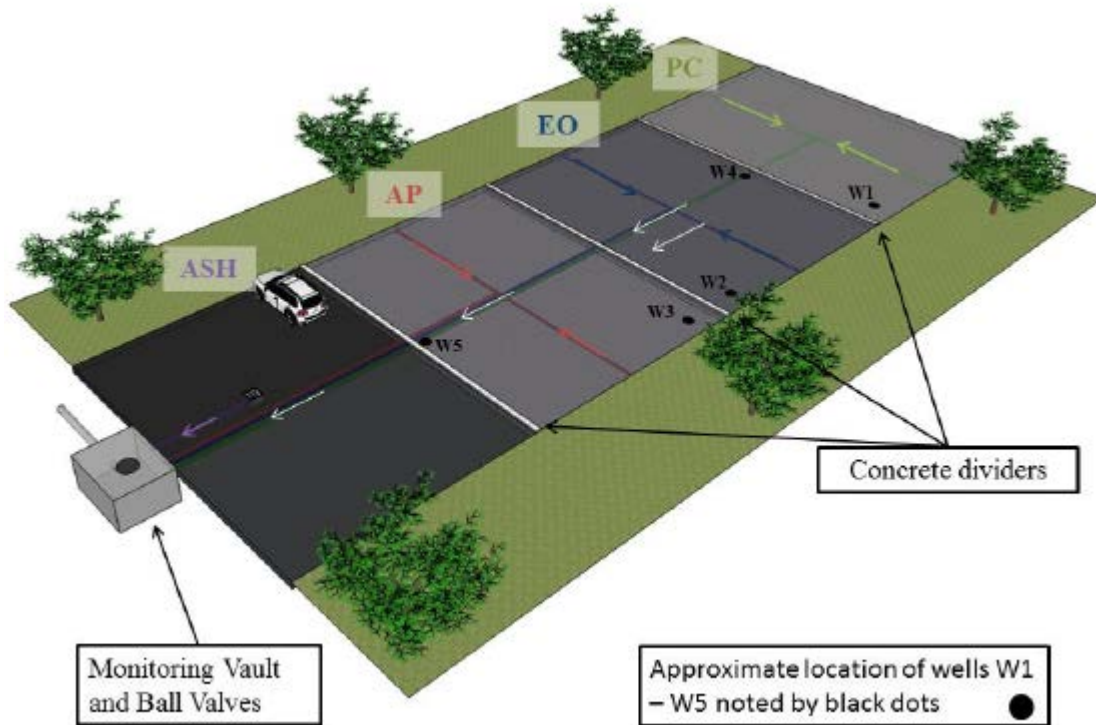

Figure 9.32. Parking lot and permeable pavement cell schematic, ASH = conventional non-porous asphalt, AP = AquaPave pavers, EO = Eco-Optic pavers, PC = Pervious concrete (Drake 2013).

9.2.4.3 Hydrology and Water Quality Performance

During the 22 month monitoring period there were 164 rain or snow events with a total of 1483 mm of recorded precipitation. Outflow was measured in 127 of the 164 events. The largest intensity rainfall event was 9.1 cm/hr (≈ 3.6 in/hr) over five minutes and the largest intensity rainfall event that was successfully monitored was 2.2 cm/hr (≈ 0.9 in/hr). During the winter salt was applied to the pavement surface and the lot was plowed. Snow was pushed to and off the four corners of the lot and kept on the vegetated areas.

Over the course of the study the permeable pavements experienced no surface runoff. Surface infiltration rates for the permeable pavements varied but all decreased over the 22 month study period. Some variability in surface infiltration rates were observed during the monitoring years, as indicated in Table 9-7. After two years of use the median surface infiltration rates for the permeable pavements were: AquaPave = 20 cm/hr, Eco-Optic = 94 cm/hr, and pervious concrete = 1072 cm/hr, all of which were much more than the largest rainfall intensity recorded for the site.

Table 9.7. Surface infiltration statistics (Drake 2013).

Year	Statistic	AP	EO	PC
2010	Range	38-419	140-945	460-5700
	Median	155	504	2120
	Mean	151	520	2330
	Std Dev	93	267	1330
2011	Range	35-341	40-711	123-5364
	Median	118	230	1340
	Mean	136	294	1790
	Std Dev	85	221	1460
2012	Range	<5-164	6-382	21-4580
	Median	20	94	1070
	Mean	34	140	1360
	Std Dev	41	117	1150

Visual observations indicate that the AquaPave pavers experienced ponding melt water on occasion while there was no mention of similar ponding on the other permeable pavements. One possible explanation is that the more narrow joints of the AquaPave system may have been more susceptible to icing. Also, winter maintenance on the lot was sporadic and it is not known if ponding would have occurred if plowing and salt application had been more regular. Ponding, however, was also observed on the AquaPave pavers during some intense summer storms. All ponded water eventually infiltrated. This ponding may have been impacted by overflow from an adjacent catch basin.

The hydrologic performance of the permeable pavement systems were evaluated by restricting the outflow using valves on the underdrains beneath the pavement. This approach led to the (1)

elimination of runoff for rainfalls of less than 7 mm, (2) reduction of peak flows by 91%, and (3) reduction of total runoff volume by 43%. The amount of volume reduction for individual events was highly dependent on season, rainfall characteristics, and conditions prior to the event. For example, negative volume reductions were observed during long periods of thawing and typically these negative events were preceded by events with large positive volume reductions. Also, PICP sites with vegetation growing in the joints did not experience higher infiltration rates than locations without vegetation. Mid-day runoff from the conventional non-porous asphalt section during winter months was typical, but such runoff was never observed from the permeable pavement cells.

Drake (2013) concluded that, although some individual events may experience an increase in runoff volume during thawing, permeable pavements with underdrains over low permeability soils can, overall, reduce runoff volumes. This was evidenced by the 43% volume reduction observed over the course of this study. In addition to a reduction of outflow volume, outflow from the systems occurred less often, at slower rates, and for longer durations than the non-porous asphalt test section.

With regards to water quality, the permeable pavements reduced effluent concentrations and mass loading of total suspended solids, nutrients, hydrocarbons, and most metals. Also, pollutant concentrations from the pavement structure itself (i.e. construction materials) were found to significantly decrease after a season of rainfall.

During the winter the application of salt (and sanding of nearby roads) significantly changes the characteristics of stormwater runoff and the permeable pavement effluent and monitoring results were different during the winter as compared to spring and summer months.

During the spring and summer, effluent from the permeable pavements contained 80% less total suspended solids (TSS) than direct runoff from the non-porous asphalt lot. The permeable pavements also retained 65 to 93% of the copper, iron, manganese, and zinc mass loads and nitrogen and phosphorus concentrations and mass loads were also reduced. Construction materials were found to increase concentrations of some contaminants (such as strontium and potassium) but initial concentrations decreased by at least 50% over two years.

During the winter months, permeable pavement effluent had TSS concentrations 90% lower than direct runoff from the non-porous asphalt section. Over the two winters that were monitored the permeable pavements reduced sodium and chloride loads by over 89%. Nutrient levels in the surface runoff increased during the winter months. Total nitrogen and total phosphorus concentrations were typically 50% lower in the permeable pavement effluent and results indicated that denitrification may be present in the permeable pavement systems during the winter. The reduction in metal concentrations continued through the winter months but more investigation is needed to determine the risk of metal release and remobilization.

Other findings were:

1. The pervious concrete and permeable interlocking concrete pavers behaved similarly with respect to hydrology. Most differences were attributed to construction practices rather than the products themselves,
2. The pervious concrete and permeable interlocking concrete pavers behaved similarly with respect to water quality for most pollutants but not all. The permeable pavements investigated all removed high amount of solids, most metals, and nutrients and significantly reduced the occurrence of detectable levels of hydrocarbons,
3. As with other studies, the permeable pavements did not require the application of salt during the winter as often as the traditional asphalt surface,
4. Differences in metal concentrations were attributed to specific aggregates and/or material in the pavement itself. Such metals were Ba, Ca, Cr, and Sr, among others,
5. All three pavements increased pH and, during non-winter months, also increased conductivity and dissolved solids,
6. The pH of the pervious concrete effluent decreased exponentially over the first and second year (typically from near 10 or 11 to around 8.5),
7. The range of effluent pH values measured for each permeable pavement investigated were as follows: Conventional asphalt: 6.8-7.9, AquaPave pavers: 8.1-8.7, Eco-Optic pavers: 8.1-8.6, pervious concrete: 8.5-10,
8. Nutrient concentrations in effluent from all three pavements were much different. This was attributed to different transformation and removal processes occurring in each system. Although not investigated by Drake (2013), transformation and removal differences could be due to aerobic or anaerobic conditions and whether or not denitrification can be sustained within the pavement system,
9. Areas with established vegetation within the joints of PICP did not have higher surface infiltration capacities. The influence of vegetation on infiltration rates and runoff quality is not well understood.

9.2.4.4 . Maintenance Performance

Drake (2013) also investigated the maintenance performance of these new test cells and some other permeable pavements in the region. The older permeable pavements in the region had experienced various degrees of clogging. Maintenance practices such as vacuuming indicated that small-scale equipment for vacuum sweeping and pressure washing have good potential to restore, at least in part, surface infiltration capacity.

Street sweeping trucks with suction-based sweeping partially restored infiltration capacity on permeable interlocking concrete pavers. Vacuum sweeping also improved the hydraulic performance of a pervious concrete pavement that had experienced a severe loss of permeability but, overall, maintenance of severely clogged pavements was less successful and more variable.

Other findings related to maintenance performance were as follows:

1. No impact of freeze-thaw cycling on the durability was observed,
2. Small-size equipment for vacuum cleaning and pressure washing have potential to increase infiltration capacity,
3. After two years of use, PICP benefited from vacuum sweeping,
4. Full-sized sweeping trucks used suction-based sweeping to partially restore infiltration capacity of PICP,
5. At one site, vacuum sweeping increased infiltration capacity of pervious concrete but at another it had no impact,
6. Annual vacuum cleaning of PICP is recommended,
7. Even though vacuum sweeping did not significantly impact pervious concrete hydraulic performance, annual sweeping is recommended as a preventative measure,
8. Clogging occurred at different rates and generated different maintenance needs. The rate of surface clogging was inversely related to the size of the surface opening,
9. Traffic and loading rates significantly impact long-term surface infiltration capacity. Higher traffic counts lead to more rapid clogging, and
10. Low areas that received runoff from other areas experienced more clogging.

9.2.4.5 . Recommendations to Fill Data Gaps

Overall, the study performed by Drake (2013) demonstrated that permeable pavements with underdrains on low permeability soils can have positive impacts on stormwater quality and reduce runoff volumes throughout the entire year. However, there are several issues that are still unresolved and identified by Drake (2013) for further investigation as summarized below:

1. Accurate and reliable life-cycle cost analysis of permeable pavements are needed. To do this, proven maintenance activities and their costs are needed,
2. The ability of permeable pavements to sustain benefits on a large, watershed scale must be understood and demonstrated,
3. Assessment tools are needed for decision support for policy makers and developers,
4. More demonstration of performance of permeable pavements in low permeability soils is needed and the impact of varying boundary conditions on infiltration must be better understood,
5. The impact on water quality must be evaluated with methods that are more telling than event mean concentrations (such as total pollutant loads), more accurately include data that is below detection limits, and include a frequency analysis,
6. The process of reduced permeability (i.e. clogging) must be better understood to allow for a more accurate life-cycle cost analysis,
7. The effect of vegetation on permeable pavement performance and the control of weeds must be better understood,
8. Maintenance requirements must be better understood,

9. The performance of permeable pavements over long time scales must be better understood,
10. Investigation into techniques to dislodge particles causing clogging are needed as this would increase the effectiveness of vacuum sweeping and regenerative air sweeping,
11. Further research is needed to determine the performance of permeable pavements in cold weather over long-term time scales, and
12. Further research is needed to determine how/if permeable pavements can provide safe conditions with lower salt application rates than traditional pavements.

References

- AASHTO (American Association of State Highway and Transportation Officials). 1993. *Guide for Design of Pavement Structures*, AASHTO, Washington, D.C., USA.
- ACPA (American Concrete Paving Association). Undated. *PerviousPave-Background, Purpose, Assumptions and Equations*. Washington, D.C., USA.
- ACPA (American Concrete Paving Association). 2009. *Stormwater management with pervious concrete pavement*. ACPA, Skokie, IL, USA.
- Al-Rubaei, A.M, Stenglein, A.L, Viklander, M., Blecken, G.T. 2013. "Long-term hydraulic performance of porous asphalt pavements in northern Sweden." *Journal of Irrigation and Drainage Engineering*, 139(6): 499-505.
- Barrett, M.E., Kearfott, P., and Malina, J.F. 2006. "Stormwater quality benefits of a porous friction course and its effect on pollutant removal by roadside shoulders." *Water Environment Research*, 78(11): 2177-2185.
- Bean, E.Z., Hunt, W.F., Bidelspach, D.A., and Burak, R.J. 2004. "Study on the surface infiltration rate of permeable pavements." *Proceedings of the 1st Water and Environment Specialty Conference of the Canadian Society for Civil Engineering*, June 2-5, Saskatoon, Saskatchewan, Canada.
- Beecham, S., Pezzaniti, D., Myers, B., Shackel, B., and Pearson, A. 2009. "Experience in the application of permeable interlocking concrete pavements in Australia." *Proceedings of the 9th International Conference on Concrete Block Paving*, Buenos Aires, Argentina, Argentinean Concrete Block Association, October Cordoba, Argentina.
- Borgwardt, S., 1994. *Tests performed on the Uni Eco-stone pavements of various ages - Expert opinion*, Institute for Planning Green Spaces and for Landscape Architecture, University of Hanover, Germany.
- Borgwardt, S., 1995. *Suitable beddings for paving blocks permeable to water*. Betonwerk + Fertigteil-Technik (Concrete Precasting Plant and Technology, Germany).
- Borgwardt, S. 1997. *Performance and fields of application for permeable paving systems*. Betonwerk + Fertigteil-Technik (Concrete Precasting Plant and Technology, pp. 100-105, Germany).
- Borgwardt, S., 2006. Long-term in-situ infiltration performance of permeable concrete block pavement. *Proceedings of the 8th International Conference of Concrete Block Paving*, San Francisco, CA, USA. Interlocking Concrete Pavement Institute Foundation for Education and Research, November, Herndon, Virginia, USA.

- Boving, T., Stolt, M., Augenstern, J. and Brosnan, B. 2008. "Potential for localized groundwater contamination in a porous pavement parking lot setting in Rhode Island." *Environ. Geol.* 55 (3): 571–582.
- Brattebo, B.O., and Booth, D.B. 2003. "Long-term stormwater quantity and quality performance of permeable pavement systems." *Water Research*, 37(18): 4369–4376.
- Briggs, J.F. 2006. *Performance assessment of porous asphalt for stormwater treatment*. M.S. Thesis. University of New Hampshire, Durham, NH, USA.
- Brown, C., Chu, A., van Duin, B. and Valeo, C. 2009. "Characteristics of sediment removal in two types of permeable pavement." *Water Qual. Res. J. Can.* 44 (1): 59–70.
- Caltrans. 2003. *Caltrans retrofit program final report*. Caltrans Division of Environmental Analysis, Report No. CTSW - RT - 01 – 050, Sacramento, CA, USA.
- Chai, L., Kayhanian, M., Givens, B., Harvey, J.T., and Jones, D. 2012. "Hydraulic performance of fully permeable highway shoulder for storm water runoff management." *Journal of Environmental Engineering*, 138(7): 711-722.
- Chopra, M., Kakuturu, S., Ballock, C., Spence, J., and Wanielista, M. 2010. "Effect of Rejuvenation Methods on the Infiltration Rates of Pervious Concrete Pavements." *Journal of Hydrologic Engineering*, 15(6): 426-433.
- Coleri, E., Kayhanian, M., Harvey, J.T., Yang, K., and Boone, J.M. 2013. "Clogging evaluation of open graded friction course pavements tested under rainfall and heavy vehicle simulators." *Journal of Environmental Management*, 129: 164-172.
- Collins, K.A., Hunt, W.F, and Hathaway, J.M. 2010. "Side-by-side comparison of nitrogen species removal for four types of permeable pavement and standard asphalt in eastern North Carolina," *Journal of Hydrologic Engineering*, 15(6): 512-521.
- Drake, J., Bradford, A., Van Seeters, T., and MacMillan, G. 2012. *Evaluation of permeable pavements in cold climates*. Toronto and Region Conservation Authority, Toronto, Canada.
- Drake, J. 2013. *Performance and operation of partial infiltration permeable pavement systems in the Ontario climate*. Ph.D. Thesis, University of Guelph, Guelph, Ontario, Canada.
- Drake, J., Bradford, A., and Marsalek, J. 2013. "Review of environmental performance of permeable pavement systems: state of the knowledge." *Water Quality Research Journal of Canada*, 48(3): 203-222.
- Fach, S. and Geiger, W. 2005. "Effective pollutant retention capacity of permeable pavements for infiltrated road runoffs determined by laboratory tests." *Water Science and Technology*, 51(2): 37–45.

- Fan, L.F., Chen, J.W., Wang, S.F., Chen, T.H., Chen, C.P., Chao, W.L., and Hsieh, H.L. 2013. "Microbial Community Structure and Activity under Various Pervious Pavements." *Journal of Environmental Engineering*, Published online, 10.1061/(ASCE)EE.1943-7870.0000798.
- Fassman, E. and Blackbourn, S. 2013. "Urban runoff mitigation by a permeable pavement system over impermeable soils." *Journal of Hydrologic Engineering*, 15(6): 475-485.
- Ferguson, B. 2005. *Porous Pavements*. Taylor & Francis, New York, NY, USA. ISBN-13: 978-0849326707.
- Fwa, T.F., Tana, S.A., Chuaia, C.T., and Guwea, Y.K. 2001. "Expedient permeability measurement for pervious pavement surface." *International Journal of Pavement Engineering*, 2(4): 259-270.
- Gilbert, J.K., and Clausen, J.C. 2006. "Stormwater runoff quality and quantity from asphalt, paver, and crushed stone driveways in Connecticut." *Water Research*, 40(4): 826-832.
- Golroo, A., and Tighe, S.L., 2012b. "Pervious concrete pavement performance modeling: an empirical approach in cold climates." *Canadian Journal of Civil Engineering*, 39(10): 1100-1112.
- González-Angullo, N., Castro, D., Rodríguez-Hernández, J., and Davies, J.W. 2008. "Runoff infiltration to permeable paving in clogged conditions." *Urban Water Journal*, 5(2): 117-124.
- Grace, R.A. 2005. "Marine outfall performance. II: Stabilization and case studies." *Journal of Performance of Constructed Facilities*. 19(4): 359-369.
- Gunderson, J. 2008. "Pervious pavements: New findings about their functionality and performance in cold climates." *Stormwater Magazine*. September 2008.
- Haselbach, L.M., and Freeman, R.M. 2006. "Vertical porosity distributions in pervious concrete pavement." *ACI Materials Journal*. 103(6): 452.
- Hein, D., Strecker E., Poresky A., and Roseen R. 2013a. *Permeable shoulders with stone reservoirs*. American Association of State Highway and Transportation Officials (AASHTO), NCHRP Project 25-25, Task 82, National Cooperative Highway Research Program, Transportation Research Board, Washington, DC.
- Hein, M.F., Dougherty, M., and Hobbs, T., 2013b. "Cleaning Methods for Pervious Concrete Pavements." *International Journal of Construction Education and Research*. 9(2): 102-116.

- Henderson, V., and Tighe, S. 2012. "Evaluation of pervious concrete pavement performance in cold weather climates." *International Journal of Pavement Engineering*. 13(3): 197-208.
- Houle, K. 2008. "Winter performance assessment of permeable pavements - A comparative study of porous asphalt, pervious concrete, and conventional asphalt in a northern climate." M.S. Thesis. University of New Hampshire, Durham, NH, USA.
- Houle, J., Roseen, R., Ballestero, T., Puls, T., and Sherrard, J., Jr. 2013. "Comparison of maintenance cost, labor demands, and system performance for LID and conventional stormwater management." *J. Environ. Eng.*, 139(7): 932–938.
- Huang, J., Valeo, C., He, J., and Chu, A. 2012. "Winter performance of inter-locking pavers- stormwater quantity and quality." *Water*. 4(4): 995-2008.
- Imran, H. M., Akib, S., and Karim, M.R. 2013. "Permeable pavement and stormwater management systems: a review." *Environmental Technology*, 13(18): 2649-3656.
- InterPave. 2010. *Permeable Pavements: Guide to the design, construction and maintenance of concrete block permeable pavements*. InterPave, Leicester, England.
- Izevbekhai, B.I., and Akkari, A. 2011. *Pervious concrete cells on MnROAD low-volume road*. Minnesota Department of Transportation report no. MN/RC 2011-23, St. Paul, MN, USA.
- James, W., and Gerrits, C. 2003. "Maintenance of infiltration in modular interlocking concrete pavers with external drainage cells." *Practical modeling of Urban Water Systems*. CHI Publishers, Guelph. pp 417-435.
- Jones, D., Harvey, J., Li, H., Wang, T., Wu R., and Campbell, B. 2010. *Laboratory testing and Modeling for Structural Performance of Fully Permeable Pavements under Heavy Traffic*. Report number CTSW-RT-10-249.04 California Department of Transportation, Sacramento, CA.
- Kang J-H, Lau, S.L., Kayhanian, M., and Stenstrom, M.K. 2009. "Characteristics of highway stormwater runoff in Los Angeles: metals and PAHs." *Water Environment Research*. 81(3): 308-318.
- Kayhanian M., Chai L., and Givens B. 2010. *Laboratory testing and simulation for hydraulic performance of fully permeable pavements*. Report number CTSW-RT-10-247.03 California Department of Transportation, Sacramento, CA.
- Kayhanian, M, Vichare, A., Green, P., Alaimo, C., Hwang, H-M, Signore, J.M. Troxler, M., Jones, D., and Harvey, J. 2009a. "Water quality evaluation of leachate produced from pavement specimens under controlled laboratory conditions." *Journal of Road Materials and Pavement Design*, 11(1): 9-28.

- Kayhanian, M., Vichare, A., Green, P., and Harvey, J. 2009b. "Leachability of dissolved chromium from asphalt and concrete surfacing materials." *Journal of Environmental Management*, 90(11): 3574-3580.
- Kayhanian, M., Anderson, D., Harvey, J.T., Jones, D., and Muhunthan, B. 2012a. "Permeability measurement and scan imaging to assess clogging of pervious concrete pavements in parking lots." *Journal of Environmental Management*, 95:114-123.
- Kayhanian, M., Fruchtman, B., Gulliver, J.S., Montanaro, C., and Raniere, E. 2012b. "Review of highway runoff characteristics: comparative analysis and universal implications." *Water Research*, 46(20): 6609-6624.
- Kevern, J.T., Schaefer, V.R., and Wang, K. 2009. "Temperature Behavior of Pervious Concrete Systems." *Journal of the Transportation Research Board*, 2098: 94-101.
- Kim, J.Y., Slater, C., and Gil, C. 2013. *Investigation of Hydraulic Capacity and Water Quality Modification of Stormwater by Permeable Interlocking Concrete Pavement (PICP)*, Department of Environmental and Civil Engineering, Florida Gulf Coast University, Fort Myers, FL.
- LADPW (Los Angeles County Department of Public Works). 2002. *Development planning for storm water management*. Los Angeles County, 2002.
- Lau S. L., M. Kayhanian, and Stenstrom, M.K. 2005. "PAHs and organic pollutants in highway runoff." Paper 7F5, *Proceedings of the IAW-ASPIRE Conference*, July 10-15, Singapore.
- Lebens, M.A., and Troyer, B. 2012. *Porous Asphalt Pavement Performance in Cold Regions*, Minnesota Department of Transportation (MnDOT), St. Paul, MN, USA.
- Leming, M.L., Malcom, H.R., and Tennis, P.D. 2007. *Hydrologic Design of Pervious Concrete*, Portland Cement Association (PCA), Skokie, IL, USA.
- Li, H., Jones, D., and Harvey, J. 2012. Development of mechanistic-empirical design procedure for fully permeable pavement under heavy traffic. *Transportation Research Record*. 2305: 83-94.
- Li, H., Harvey, J.T., Holland, T.J., and Kayhanian, M. 2013. "The use of reflective and permeable pavements as a potential practice for heat island mitigation and stormwater management." *Environmental Research Letters*. 8: 1-14.
- Lucke, T., and Beecham, S. 2011. "Field investigation of clogging in a permeable pavement system." *Building Research and Information*, 39(6): 603-615.
- Maestre, M., and Pitt, R. 2005. *A Compilation and Analysis of NPDES Stormwater Monitoring Information*, Office of Water, U.S. Environmental Protection Agency, Washington, D.C., USA.

- Mallela, J., Larson, G., Wyatt, T., Hall, J., and Barker, W. 2002. *User's Guide for, Drainage Requirements In Pavements – Drip 2.0 Microcomputer Program*, Report No. FHWA-IF-02-05C, Office of Pavement Technology, Federal Highway Administration, Washington, DC.
- Manahiloh, K.N., Muhunthan, B., Kayhanian, M., and Gebremariam, S.Y. 2012. "X-Ray computed tomography and nondestructive evaluation of clogging in porous concrete field samples." *Journal of Materials in Civil Engineering*. 24(8): 1103-1109.
- Massoudieh, A., and Ginn, T. R. 2008. "Modeling colloid-enhanced contaminant transport in stormwater infiltration basin BMPs" *Vadose Zone Journal*. 7(4): 1261-1268.
- Mata, L.A., and Leming, M.L. 2012. "Vertical Distribution of Sediments in Pervious Concrete Pavement Systems." *ACI Materials Journal*. 109(2): 149-155.
- Mbanaso, F.U., Coupe, S.J., Charlesworth, S.M., and Nnadi, E.O. 2013. "Laboratory-based experiments to investigate the impact of glyphosate-containing herbicide on pollution attenuation and biodegradation in a model pervious paving system." *Chemosphere*, 90(2): 737-746.
- NAPA (National Asphalt Pavement Association). 2002. *Open-Graded Asphalt Friction Courses, Design, Construction & Maintenance*. Report IS-115, NAPA, Lanham, MD, USA.
- NAPA (National Asphalt Pavement Association). 2008. *Porous asphalt pavements for stormwater management, Design, Construction and maintenance guide*. Information Series 131, NAPA, Lanham, MD, USA.
- NRCS (National Resource Conservation Service, U.S. Department of Agriculture). 1986. *Urban hydrology for small watersheds*, TR 55, NRCS, Washington DC.
- Nieber, J.L., Arika, C.N., Lahti, L., Gulliver, J.S., and Weiss, P.T. 2014. *The Impact of Stormwater Infiltration Practices on Groundwater Quality*, Report to the Metropolitan Council, University of Minnesota, Minneapolis, MN, USA.
- Pan, Y., Li, L., and Amini, F. 2013. "Influence of Three Levee-Strengthening Systems on Overtopping Hydraulic Parameters and Hydraulic Equivalency Analysis between Steady and Intermittent Overtopping." *Journal of Waterways Port Coastal and Ocean*, 139(4): 256-266.
- Pitt, R., Clark, S., Parmer, K., and Field, R. 1996. *Groundwater Contamination from Stormwater Infiltration*. Ann Arbor Press, Inc., Chelsea, MI, USA.
- Pratt, C.J., Newman, A.P., and Bond, P.C. 1999. "Mineral oil bio-degradations within a permeable pavement: Long term observations." *Water Science and Technology*. 39(2): 103-109.

- Roseen, R.M., Ballestero, T.P., Houle, J.J., Avellaneda, P., Briggs, J., Fowler, G., and Wildey, R. 2009. "Seasonal performance variations for storm-water management systems in cold climate conditions." *Journal of Environmental Engineering*. 135(3): 128-137.
- Roseen, R.M., Ballestero, T.P., Houle, J.J., Avellaneda, P., Briggs, J., and Houle, K.M. 2012. "Water quality and hydrologic performance of a porous asphalt pavement as a storm-water treatment strategy in a cold climate." *Journal of Environmental Engineering*. 138(1): 81-89.
- Roseen, R.M., Houle, J.J., Puls, T.A., and Ballestero, T.P. 2013. *Final report on cold climate permeable interlocking concrete pavement test facility at the University of New Hampshire Stormwater Center*, UNHSC, Durham, NH.
- Roseen, R.M., Ballestero, T.P., Houle, K.M., Heath, D., and Houle, J.J. 2014. "Assessment of winter maintenance of porous asphalt and its function for chloride source control," *Journal of Transportation Engineering*. 140(2): 1-8.
- Rowe, A. A., Borst, M., O'Connor, T.P., and Stander, E.K. 2010. "Permeable pavement demonstration at the Edison Environmental Center," in *Proceedings, Low Impact Development 2010: Redefining Water in the City*, 2010 ASCE, April, Reston, VA.
- St. John, M.S., and Horner, R.R. 1997. *Effect of Road Shoulder Treatments on Highway Runoff Quality and Quantity*, Washington State Transportation Center, University of Washington, Seattle, WA.
- Scholz, M., 2013. "Water Quality Improvement Performance of Geotextiles Within Permeable Pavement Systems: A Critical Review." *Water*. 5: 462-479.
- Schwartz, S.S. 2010. "Effective CN and hydrologic design of pervious concrete storm-water systems." *Journal of Hydrologic Engineering*, 15(6): 465-474.
- Shu, X., Huang, B., Wu, H., Dong, Q., and Burdette, E.G. 2011. "Performance comparison of laboratory and field produced pervious concrete mixtures." *Construction and Building Materials*. 25: 3187-3192.
- SI Concrete Systems. 2002. *Fiber-Reinforced Pervious Concrete*. Project 2120-36, SI Concrete Systems, Chattanooga, TN.
- Signore J., Harvey, J., Kayhanian, M., Santero, N., Wu, R., Troxler, M., and Farshidi, F. 2008. *Performance evaluation of permeable pavements for water quality under heavy traffic*. Caltrans Division of Environmental Analysis, Sacramento, CA, USA.
- Smith, David R. 2011. *Permeable Interlocking Concrete Pavements, 4th edition*. Interlocking Concrete Pavement Institute (ICPI), Herndon, VA, USA.
- Smith, D. and Hunt, B. 2010. *Structural/hydrologic design and maintenance of permeable interlocking concrete pavements*. Green Streets and Highways, Denver, CO, ASCE.

- Thomle, J.N. 2010. "The Declining pH of Waters Exposed to Pervious Concrete." MS Thesis, Department of Civil and Environmental Engineering, Washington State University, Pullman, WA, USA.
- Tota-Maharaj, K., and Scholz, M. 2010. "Efficiency of permeable pavement systems for the removal of urban runoff pollutants under varying environmental conditions." *Environmental Progress and Sustainable Energy*. 29(3): 358–369.
- Tyner, J.S., Wright, W.C., and Dobbs, P.A. 2009. "Increasing exfiltration from pervious concrete and temperature monitoring." *Journal of Environmental Management*. 90(8): 2636-2641.
- Urban Drainage and Flood Control District (UDFCD). 2010. *Urban Storm Drainage Criteria Manual, version 3*. Urban Drainage and Flood Control District, Denver, CO.
- Urban Drainage and Flood Control District (UDFCD). 2011a. *Stormwater Quality Monitoring Report Permeable Interlocking Concrete Pavement (PICP) at Denver Wastewater Management Building Denver, Colorado 2008-2010*. UDFCD, Denver, CO, USA.
- Urban Drainage and Flood Control District (UDFCD). 2011b. *Stormwater Quality Monitoring Report Porous Asphalt at Denver Wastewater Management Building Denver, Colorado 2008-2010*. UDFCD, Denver, CO, USA.
- UNHSC (University of New Hampshire Stormwater Center). 2009. *UNHSC Design specifications for porous asphalt pavement and infiltration beds*. University of New Hampshire, Durham, NH, USA.
- Van Seters, T. 2007. *Performance Evaluation of Permeable Pavement and a Bioretention Swale Seneca College, King City, Ontario*, Interim Report #3, Toronto and Region Conservation Authority, Vaughn, Ontario.
- Vancura, M.E., 2010. *Performance Evaluation, Impermeability Remediation, and Structural Analysis of Pervious Concrete Pavements*. Plan B Project Report, University of Minnesota, Minneapolis, MN, USA.
- Wanielista, M., and Chopra, M. 2007. *Performance Assessment of a Pervious Concrete Pavement Used as a Shoulder for an Interstate Rest Area Parking Lot*. Stormwater Management Academy, University of Central Florida, Orlando, FL, USA.
- Wardynski, B.J., Winston, R.J., and Hunt, W.F., 2013. "Internal water storage enhances exfiltration and thermal load reduction from permeable pavement in the North Carolina mountains." *Journal of Environmental Engineering*. 139(2): 187-195.
- Wenck Associates, Inc. 2014. *Porous pavement paired intersection study*, Shingle Creek Watershed Management Commission, City of Robbinsdale, MN, and the Minnesota Pollution Control Agency, Maple Plain, MN, USA.

- Yong, C., Deletic, A., Fletcher, T. and Grace, M. 2008. "The clogging behaviour and treatment efficiency of a range of porous pavements." *Proceedings from the 11th International Conference on Urban Drainage*. August-September, Edinburgh, Scotland.
- Yong, C.F., McCarthy, D.T., and Deletic, A. 2013. "Predicting physical clogging of porous and permeable pavements." *Journal of Hydrology*. 481: 48-55.
- Zement. 2003. *Regenwasserversickerung durch Pflasterflächen, Bauerberatung Zement-Merkblatt strassenbau*, bundesverband der Deutsche Zementindustrie e.v., www.bdzement.de, June, Koln, Germany, S 15.

Appendix A
Summary of Data Gaps and Research Study Suggestions Based on Research Area

Structure

Data Gap Area	Reference	Suggested Research Topic(s)
Structure	Lampe et al., 2004	<ul style="list-style-type: none"> • Aggregate grading and performance under load. • Performance of geo-synthetic fabric in PP construction. • Specifications for geotextiles (where to install? What type? To maximize pollutant capture. • Structural analysis under load when subgrade soil is wet and saturated.
	Kevern et al. (2006)	<ul style="list-style-type: none"> • Effect of different construction methods and compaction energy on the freeze thaw durability of various mix designs.
	Schaefer et al., 2006	<ul style="list-style-type: none"> • Evaluate how compaction energy effects pervious concrete properties (e.g. strength, void ratio, permeability, freeze-thaw durability) to develop standard construction method.
	Wanielista and Chopra, 2007	<ul style="list-style-type: none"> • Investigate the impact of accurate traffic volumes and loadings to determine how such variables impact the long term performance of pervious pavement.
	Delatte et al, 2007	<ul style="list-style-type: none"> • Develop in-situ test methods to measure strength, thickness, and void ratio of in place pervious concrete so that cores do not have to be taken.
	Kayhanian et al., 2010	<ul style="list-style-type: none"> • HVS or bus route test sections to evaluate structural performance under heavy load and load speed.
	Jones at al., 2010	<ul style="list-style-type: none"> • Life cycle cost analysis based on pavement type and materials. • Standard compaction method for subgrade aggregate. • Design of pervious concrete pavement using lower aggregate size and higher cement content. • Use of modified polymer in HMA-O mix to reduce the likely risk of raveling, rutting, and cracking.
	ACI, 2010	<ul style="list-style-type: none"> • Understanding of the pore structure in order to determine material based performance design standards. • Development of non-destructive test methods. • Standard method to measure fatigue. • Freeze-thaw and cold climate applications performance.
	Vancura et al., 2010	<ul style="list-style-type: none"> • Full-scale field testing studies to assess the applicability of the StreetPave model to pervious concrete systems. • Monitoring over time to develop a better understanding of the long-term performance of pervious concrete. • Effect of lightweight aggregate on pervious concrete performance. • Develop and calibrate a fatigue model for pervious concrete.
	Drake et al., 2012	<ul style="list-style-type: none"> • Test methods of evaluating dislodging material from permeable pavement surfaces. • Long-term performance evaluation, especially in cold climate. • Impact of heavy traffic and loading on permeable pavement.

Structure (continued)

Data Gap Area	Reference	Suggested Research Topic(s)
Structure (continued)	Amde and Rogge, 2013	<ul style="list-style-type: none"> • Develop a non-destructive test to determine the uniform level of compaction throughout a pervious concrete sample • Fatigue investigation of pervious concrete under light and medium traffic situations. • Impact of recycled aggregate on pervious concrete properties.
	Li et al (2012)	<ul style="list-style-type: none"> • Validate mechanistic design with field demonstration. • Perform life-cycle cost and environmental life cycle analysis.
	Drake et al (2013)	<ul style="list-style-type: none"> • Life-cycle cost analysis.
	Li et al (2013a)	<ul style="list-style-type: none"> • Structural performance under traffic loading.
	Scholz (2013)	<ul style="list-style-type: none"> • Long-term testing on the impact of geotextiles with underground testing units to mimic actual field conditions.
	Houle (2008)	<ul style="list-style-type: none"> • Full life-cycle costs analysis to compare permeable pavements amongst themselves and with traditional pavements.
	Boyer (2011)	<ul style="list-style-type: none"> • Perform a life cycle analysis including environmental, energy, and economic considerations.
	Drake (2013)	<ul style="list-style-type: none"> • Accurate and reliable life-cycle cost analysis of permeable pavements with proven maintenance activities and their costs. • Benefit of permeable pavement on watershed-scale.

Hydraulics/Water Quality

Data Gap Area	Reference	Suggested Research Topic(s)
Hydraulic/ Water Quality	St. John and Horner, 1997	<ul style="list-style-type: none"> Evaluate aggregate mix design as a source of pollution?
	Lampe et al., 2004	<ul style="list-style-type: none"> Impact on groundwater quality based on flow rate, pollutant type and load.
	Wanielista et al., 2007	<ul style="list-style-type: none"> Developing a test method for measuring the infiltration rate of the underlying gravel reservoir. Developing a mass balance model, capable of simulating unsaturated flow within the underlying soil to the water table.
	Kayhanian et al., 2010	<ul style="list-style-type: none"> Evaluate hydraulic performance under heavy load and low speed under HVS or bus route test sections using real or simulated rainfall. Develop a user-friendly infiltration model to assess the short and long-term impact of possible pollutants on groundwater.
	ACI, 2010	<ul style="list-style-type: none"> Effect of water with high sulfate concentrations or acidic water on the durability of pervious concrete. Urban heat island effect and thermal properties.
	Vancura et al., 2010	<ul style="list-style-type: none"> Evaluation of freeze-thaw damage due to the lack of paste hydration or the lack of a standard air void distribution.
	Drake et al., 2012	<ul style="list-style-type: none"> Use raised pipe or control valves to increase infiltration and reduce effluent volume. Testing on leachate of materials from pervious pavements.
	Boving et al (2008)	<ul style="list-style-type: none"> Pollutant removal within pavement structure (i.e. asphalt, trapped particles in aggregate, etc.) Long-term water quality monitoring.
	Collins et al (2010)	<ul style="list-style-type: none"> Isolate the underlying soils to investigate and gain a better understanding of the water quality response within the pavement system.
	Drake et al (2013)	<ul style="list-style-type: none"> Nitrogen fate and transport in porous pavement. Long-term fate and transport of the phosphorus (i.e., does it become mobile later?). Impact of design and materials used on water quality. Impact of infiltration on groundwater quality. Impact of permeable pavement on watershed-scale.
	Imran et al (2013)	<ul style="list-style-type: none"> Investigation of biodegradation process in permeable pavements (species, dispersal, and colonization rate). Removal/retention of nutrient within permeable pavements. Optimum environment for biodegradation for various organisms. Study of temperature profiles, biodegradation, and microorganism life cycles. Study of different media mixes to enhance bio-retention. Performance of filter media in sumps at the bottom of permeable pavement structures. Removal and leaching of phosphorus within permeable pavements.
	Li et al (2013a)	<ul style="list-style-type: none"> Impact of permeable pavement on urban heat island.

Hydraulics/Water Quality (continued)

Data Gap Area	Reference	Suggested Research Topic(s)
Hydraulic/ Water Quality (continued)	Scholz (2013)	<ul style="list-style-type: none"> • Performance evaluation of different or modified geotextile for organic and trace elements removal
	Briggs (2006)	<ul style="list-style-type: none"> • Improved method of infiltration to minimize leaking. • Pavement cores analysis to determine the extent that binder drawdown affected infiltration • Infiltration capacity prior to and after cleaning to determine the impact of maintenance activities • Optimize winter maintenance by minimizing the application of deicers and sand • Impact on groundwater quality • Better record of chloride application rates
	Houle (2008)	<ul style="list-style-type: none"> • Long-term infiltration rate
	Thomle (2010)	<ul style="list-style-type: none"> • Quantification of the amount of carbon sequestered in the specimens when exposed to carbonate laden waters
	Boyer (2011)	<ul style="list-style-type: none"> • Temperature and materials property profile to investigate the urban heat island effect • A model to measure the temperature gain and loss when evaluating the heating and cooling of previous concrete • Perform a study to measure the amount of water retained in the pervious concrete layer after a rainfall event and also the evaporation and cooling effect of this water
	Drake (2013)	<ul style="list-style-type: none"> • Water quality evaluation by using load vs. concentration; include data below detection limit and frequency analysis

Maintenance/Clogging

Data Gap Area	Reference	Suggested Research Topic(s)
	Briggs (2006)	<ul style="list-style-type: none"> • Improved method of infiltration to minimize leaking when measuring surface permeability. • Infiltration capacity (permeability) prior to and after cleaning to determine the impact of maintenance activities
Maintenance/ Clogging	St. John and Horner, 1997	<ul style="list-style-type: none"> • Quantitative evaluation of clogging
	Lampe et al., 2004	<ul style="list-style-type: none"> • Cleaning equipment and maintenance intervals for clogging
	Chopra et al., 2007	<ul style="list-style-type: none"> • Permeability measurement over time • High volume flushing
	Kayhanian et al., 2010	<ul style="list-style-type: none"> • Evaluate various cleaning methods to remove clogging.
	Drake et al., 2012	<ul style="list-style-type: none"> • Cleaning frequency • The need for salt application on permeable pavement
	Drake et al (2013)	<ul style="list-style-type: none"> • Pavement design that optimize pollutant retention and minimize clogging
	Houle (2008)	<ul style="list-style-type: none"> • Chloride retention and export amount • Non-chloride salts investigation to determine their performance and required loading rates • Measure vertical temperature profiles below the ground surface as well as groundwater elevations to determine if latent heat from the ground and infiltrated water can melt snow and ice in or on the pavement
	Drake (2013)	<ul style="list-style-type: none"> • Techniques to dislodge particles causing clogging are needed as this would increase the effectiveness of vacuum sweeping and regenerative air sweeping • Performance of permeable pavements in cold weather over long-term time scales

Decision Making Tool

Data Gap Area	Reference	Suggested Research Topic(s)
Decision Making Tool	Drake et al (2013)	<ul style="list-style-type: none">• Develop a decision making tool for sustainable implementation of permeable pavement
	Drake (2013)	<ul style="list-style-type: none">• Develop decision making tool in support of policy makers and developers

Appendix B
Annotated Bibliography

Appendix B Table of Contents

Appendix B Table of Contents	1
Appendix B List of Figures.....	16
Appendix B List of Tables	17
Acronyms, Abbreviations and Symbols	18
Definition of Terminologies Commonly used in the Literature	23
B1 Introduction	24
B1.1 Background	24
B1.2 Focus of the interim report	24
B1.3 Organization of the interim report.....	24
B2 Review of Existing Industry Manuals.....	26
B2.1 American Concrete Paving Association (ACPA 2009, undated).....	26
B2.1.1 Focus of the Project.....	26
B2.1.2 Structural and Design Aspects	27
B2.1.3 Water Quality and Hydrology	28
B2.1.4 Maintenance	30
B2.2 National Asphalt Pavement Association (NAPA 2008)	30
B2.2.1 Focus of the Project.....	30
B2.2.2 Structural and Design Aspects	31
B2.2.3 Water Quality and Hydrology	34
B2.2.4 Maintenance	36
B2.3 Interlocking Concrete Pavement Institute (ICPI 2011).....	36
B2.3.1 Focus of the Project.....	36
B2.3.2 Structural and Design Aspects	37
B2.3.3 Water Quality and Hydrology	41
B2.3.4 Maintenance	44
B2.4 Portland Cement Association (PCA 2007). Hydrology Design of Pervious Concrete	44
B2.4.1 2.4.1 Focus of the Project.....	44
B2.4.2 2.4.2 Water Quality and Hydrology	44
B2.5 InterPave (2010). Permeable Pavements: Guide to the design, construction and maintenance of concrete block permeable pavements.....	46

B2.5.1 Focus of the Project.....	46
B2.5.2 Structural and Design Aspects	46
B2.5.3 Water Quality and Hydrology	46
B3 Review of Technical Reports	48
B3.1 ACPA (undated B). Cement-Treated Permeable Base for Heavy-Traffic Concrete Pavements	48
B3.1.1 Focus of the Project.....	48
B3.1.2 Structural and Design Aspects	48
B3.1.3 Construction Practices.....	49
B3.1.4 Maintenance	49
B3.2 Concrete Promotional Group (undated). Handbook for Pervious Concrete Certification	49
B3.2.1 Focus of the Project.....	49
B3.2.2 Structural and Design Aspects	49
B3.2.3 Maintenance	50
B3.3 Crouch et al. (undated). Pervious Portland Cement Concrete Compressive Strength in the Laboratory and the Field.....	51
B3.3.1 Focus of the Report	51
B3.3.2 Structural and Design Aspects	51
B3.4 Izevbekhai (undated). Acoustic properties of clogged pervious concrete pavements	51
B3.4.1 Focus of the Project.....	51
B3.4.2 Maintenance	52
B3.4.3 Conclusions	52
B3.5 Suleiman et al (undated). Effect of Compaction Energy on Pervious Concrete Properties	52
B3.5.1 Focus of the Report	53
B3.5.2 Structural and Design Aspects	53
B3.5.3 Identified Data Gaps and Research Suggestions.....	53
B3.6 St. John and Hornder (1997). Washington Report on the Effect of Road Shoulder Treatments on Runoff Quantity and Quality	53
B3.6.1 Focus of the Project.....	53
B3.6.2 Water Quality and Hydrology	53
B3.6.3 Identified Data Gaps and Research Suggestions.....	56

B3.7 Lampe et al (2004). Report on Monitoring to Determine Performance and Whole-life Costs.....	56
B3.7.1 Focus of the Project.....	56
B3.7.2 Structural and Design Aspects	57
B3.7.3 Water Quality and Hydrology	57
B3.7.4 Maintenance	57
B3.8 NRMCA (2004). Freeze-Thaw Resistance of Pervious Concrete.....	57
B3.8.1 Focus of the Project.....	58
B3.8.2 Structural and Design Aspects	58
B3.9 Tennis et al (2004). Pervious Concrete Pavements.....	58
B3.9.1 Focus of the Project.....	58
B3.9.2 Properties and Mix Design.....	58
B3.9.3 Structural and Design Aspects	59
B3.9.4 Construction	59
B3.9.5 Maintenance	60
B3.10 Lampe et al (2005). Report on Performance and Whole Life Cycle Costs.....	60
B3.10.1 Focus of the Project.....	60
B3.10.2 Cost.....	60
B3.10.3 Maintenance	61
B3.11 Offenberg 2005. Producing Pervious Pavements.....	61
B3.11.1 Focus of the Report	62
B3.11.2 Construction	62
B3.12 Kevern et al 2006. Pervious Concrete Construction: Methods and Quality Control	62
B3.12.1 Focus of the Report	62
B3.12.2 Construction	63
B3.12.3 Compaction Study at Iowa State University	63
B3.12.4 Identified Data Gaps and Research Suggestions.....	63
B3.13 Pennsylvania Department of Environmental Protection (2006). Stormwater BMP Manual	63
B3.13.1 Focus of the Project.....	63
B3.13.2 Structural and Design Aspects	64

B3.13.3 Maintenance	64
B3.14 Schaefer et al (2006). Mix Design Development for Pervious Concrete in Cold Weather Climates.	65
B3.14.1 Focus of the Project.....	65
B3.14.2 Mix Design.....	65
B3.14.3 Identified Data Gaps and Research Suggestions.....	66
B3.15 Chopra et al. (2007). Construction and Maintenance Assessment of Pervious Concrete Pavements	66
B3.15.1 Focus of the Project.....	66
B3.15.2 Maintenance	67
B3.15.3 Identified Data Gaps and Research Suggestions.....	67
B3.16 Delatte et al. (2007). Portland Cement Pervious Concrete Pavement: Field Performance Investigation on Parking Lot and Roadway Pavements-Final Report	67
B3.16.1 Focus of the Project.....	68
B3.16.2 Conclusions	68
B3.16.3 Identified Data Gaps and Research Suggestions.....	68
B3.17 Wanielista et al (2007). Hydraulic Performance Assessment of Pervious Concrete Pavements for Stormwater Management Credit.	69
B3.17.1 Focus of the Project.....	69
B3.17.2 Water Quality and Hydrology.....	69
B3.17.3 Identified Data Gaps and Research Suggestions.....	69
B3.18 Wanielista and Chopra (2007a). Florida Department of Transportation Report on the Compressive Strength of Pervious Concrete	70
B3.18.1 Focus of the Project.....	70
B3.18.2 Structural and Design Aspects	70
B3.18.3 Water Quality and Hydrology.....	72
B3.18.4 Identified Data Gaps and Research Suggestions.....	73
B3.19 Worel et al (2007). MnRoad Pervious Concrete Sidewalk Project.....	73
B3.19.1 Focus of the Project.....	73
B3.19.2 Structural and Design Aspects	74
B3.19.3 Identified Data Gaps and Research Suggestions.....	77

B3.20 Colorado Ready Mixed Concrete Association (2009). Specifier’s guide for pervious concrete pavement design	78
B3.20.1 Focus of the Project.....	78
B3.20.2 Structural and Design Aspects	78
B3.21 3.21 McGowen et al (2009). Report on Water Quality Issues in Highway Management	79
B3.21.1 Focus of the Report	79
B3.21.2 Maintenance	79
B3.22 University of New Hampshire Stormwater Center (2009). Design specifications for porous asphalt pavement and infiltration beds.....	79
B3.22.1 Focus of the Project.....	79
B3.22.2 Structural and Design Aspects	80
B3.23 American Concrete Institute (2010). Report on Pervious Concrete.....	81
B3.23.1 Focus of the Project.....	81
B3.23.2 Structural and Design Aspects	81
B3.23.3 Maintenance	84
B3.23.4 Identified Data Gaps and Research Suggestions.....	85
B3.24 Jones et al (2010). Caltrans Report on Structural Performance of Fully Permeable Pavements	85
B3.24.1 Focus of the Project.....	85
B3.24.2 Structural Performance Results.....	86
B3.24.3 Life Cycle Cost Analysis.....	89
B3.24.4 Identified Data Gaps and Research Suggestions.....	90
B3.25 Kayhanian et al. (2010). Caltrans Report on Hydraulic Performance of Fully Permeable Pavements	91
B3.25.1 Focus of the Project.....	91
B3.25.2 Hydraulic Performance Results.....	92
B3.25.3 Clogging Simulation Results.....	94
B3.25.4 Identified Data Gaps and Research Suggestions.....	96
B3.26 Urban Drainage Flood Control District (2010). Urban Storm Drainage Criteria Manual	96
B3.26.1 Focus of the Project.....	96

B3.26.2 Maintenance	97
B3.27 Vancura et al. (2010). Performance Evaluation of In-Service Pervious Concrete Pavements in Cold Weather-Final Report	97
B3.27.1 Focus of the Project.....	97
B3.27.2 Structural and Design Aspects	98
B3.27.3 Identified Data Gaps and Research Suggestions.....	98
B3.28 Izevbekhai and Akkari (2011). Pervious Concrete Test Cells at MnROAD Low Volume Road	98
B3.28.1 Focus of the Project.....	99
B3.28.2 Structural and Design Aspects	99
B3.28.3 Water Quality and Hydrology.....	102
B3.28.4 Maintenance	102
B3.29 Urban Drainage and Flood Control District (2011a). Stormwater Quality Monitoring Report Permeable Interlocking Concrete Pavement (PICP).....	102
B3.29.1 Focus of the Project.....	103
B3.29.2 Design Aspects.....	103
B3.29.3 Water Quality and Hydrology.....	103
B3.29.4 Maintenance	104
B3.30 Urban Drainage and Flood Control District (2011b). Stormwater Quality Monitoring Report Porous Asphalt	104
B3.30.1 Focus of the Project.....	104
B3.30.2 Structural and Design Aspects	104
B3.30.3 Water Quality and Hydrology.....	104
B3.30.4 Maintenance	105
B3.31 Drake et al (2012). Report on the Evaluation of Permeable Pavements in Canada.....	106
B3.31.1 Focus of the Project.....	107
B3.31.2 Surface Infiltration	107
B3.31.3 Water Quality and Hydrology.....	109
B3.31.4 Maintenance	111
B3.31.5 Identified Data Gaps and Research Suggestions.....	112
B3.32 Amde and Rogge (2013). Development of high quality pervious concrete specifications for Maryland conditions.....	113

B3.32.1 Focus of the Project.....	113
B3.32.2 Structural and Design Aspects	114
B3.32.3 Identified Data Gaps and Research Suggestions.....	114
B3.33 Hein et al (2013a). NCHRP Report on Permeable Shoulders with Stone Reservoirs .	115
B3.33.1 Focus of the Project.....	115
B3.33.2 Structural and Hydrological Design of Permeable Pavements	115
B3.33.3 Conceptual Design Configurations	122
B3.33.4 Permeable Shoulder Pavement Maintenance Guidelines.....	123
B3.33.5 Permeable Shoulder Feasibility Decision Matrix.....	124
B4 Conference Proceedings and Peer Reviewed Journal Papers Publications.....	125
B4.1 Pratt et al (1999). Mineral oil bio-degradations within a permeable pavement: Long term observations	125
B4.1.1 Focus of the Project.....	125
B4.1.2 Hydrology and Water Quality Performance.....	125
B4.2 Dierkes et al (1999). Heavy Metal Retention within a Porous Pavement Structure	126
B4.2.1 Focus of the Project.....	126
B4.2.2 Hydrology and Water Quality Performance.....	126
B4.3 Brattebo and Booth (2003). Long-term stormwater quantity and quality performance of permeable pavement systems.....	127
B4.3.1 Focus of the Project.....	127
B4.3.2 Structural Design Performance	127
B4.3.3 Hydrology and Water Quality Performance.....	127
B4.4 Bean et al. (2004). Study on the surface infiltration rate of permeable pavements	128
B4.4.1 Focus of the Project.....	128
B4.4.2 Hydrology and Water Quality Performance.....	128
B4.4.3 Maintenance Performance.....	129
B4.5 Burak (2004). Permeable Interlocking Concrete Pavements - Selection, Design, Construction and Maintenance	129
B4.5.1 Focus of the Project.....	129
B4.5.2 Mix Design and Structural Design Performance.....	129
B4.6 Gilbert and Clausen (2006). Stormwater runoff quality and quantity from asphalt, paver, and crushed stone driveways in Connecticut	131

B4.6.1 Focus of the Project.....	131
B4.6.2 Hydrology and Water Quality Performance.....	131
B4.7 Haselbach et al (2006). Permeability predictions for sand-clogged Portland cement pervious concrete pavement systems	131
B4.7.1 Focus of the Project.....	132
B4.7.2 Hydrologic (infiltration Capacity) Performance	132
B4.8 Yang et al (2006). Influence of Moisture Conditions on Freeze and Thaw Durability of Portland Cement Pervious Concrete	132
B4.8.1 Focus of the Project.....	132
B4.8.2 Mix Design and Structural Design Performance.....	132
B4.9 Boving et al (2008). Potential for localized groundwater contamination in a porous pavement parking lot.....	133
B4.9.1 Focus of the Project.....	133
B4.9.2 Hydrology and Water Quality Performance.....	133
B4.9.3 Maintenance Performance.....	134
B4.9.4 Recommendations for Future Research Suggestions	134
B4.10 Gonzalez-Angullo et al (2008). Runoff Infiltration to Permeable Paving in Clogged Conditions.....	134
B4.10.1 Focus of the Project.....	134
B4.10.2 Hydrologic Performance	135
B4.11 Kevern et al (2008). Pervious Concrete in Severe Exposures.....	135
B4.11.1 Focus of the Project.....	135
B4.11.2 Mix Design and Structural Design Performance.....	135
B4.12 Kevern et al (2009). Temperature Behavior of Pervious Concrete Systems	136
B4.12.1 Focus of the Project.....	136
B4.12.2 Hydrology and Water Quality Performance.....	136
B4.13 Roseen et al. (2009). Seasonal Performance Variations for Storm-Water Management Systems in Cold Climate Conditions	137
B4.13.1 Focus of the Project.....	137
B4.13.2 Water Quality Performance.....	137
B4.14 Tyner et al (2009). Increasing exfiltration from pervious concrete and temperature monitoring.....	138

B4.14.1 Focus of the Project.....	138
B4.14.2 Hydrology and Water Quality Performance.....	138
B4.15 Chopra et al (2010). Effect of Rejuvenation Methods on the Infiltration Rates of Pervious Concrete Pavements.....	138
B4.15.1 Focus of the Project.....	139
B4.15.2 Hydrologic (Infiltration Capacity) Performance.....	139
B4.15.3 Maintenance Performance.....	139
B4.16 Collins et al (2010). Side-by-side comparison of nitrogen species removal for four types of permeable pavement and standard asphalt in eastern North Carolina.....	139
B4.16.1 Focus of the Project.....	139
B4.16.2 Hydrology and Water Quality Performance.....	140
B4.16.3 Recommended Research Topic for Future Investigation.....	140
B4.17 Rowe et al (2010). Permeable Pavement Demonstration at the Edison Environmental Center.....	140
B4.17.1 Focus of the Project.....	140
B4.17.2 Water Quality Performance.....	141
B4.18 Ravindrarajah and Yukari (2010). Environmentally friendly concrete for sustainable construction.....	142
B4.18.1 Focus of the Project.....	142
B4.18.2 Mix Design and Structural Design Performance.....	143
B4.19 Schwartz (2010). Effective CN and hydrologic design of pervious concrete storm-water systems.....	143
B4.19.1 Focus of the Project.....	143
B4.19.2 Hydrology and Water Quality Performance.....	143
B4.20 Lucke and Beecham (2011). Field investigation of clogging in a permeable pavement system.....	144
B4.20.1 Focus of the Project.....	144
B4.20.2 Hydrology and Water Quality Performance.....	144
B4.20.3 Shu et al (2011). Performance comparison of laboratory and field produced pervious concrete mixtures.....	145
B4.20.4 Focus of the Project.....	145
B4.20.5 Mix Design and Structural Design Performance.....	145

B4.21 Wu et al (2011). Laboratory evaluation of abrasion resistance of Portland Cement pervious concrete	146
B4.21.1 Focus of the Project.....	146
B4.21.2 Design Mix and Structural Design Performance.....	146
B4.22 Yang (2011). Freezing and thawing durability of pervious concrete under simulated field conditions.....	146
B4.22.1 Focus of the Project.....	146
B4.22.2 Mix Design and Structural Design Performance.....	147
B4.23 Chai, et al (2012). Paper on Permeable Highway Shoulders	147
B4.23.1 Focus of the Project.....	147
B4.23.2 Hydrologic Simulation Performance Results	147
B4.24 Golroo and Tighe (2012a). Pervious Concrete Pavement Performance Modeling Using the Bayesian Statistical Technique	149
B4.24.1 Focus of the Project.....	149
B4.24.2 Structural Design (Modeling) Performance	149
B4.25 Golroo and Tighe (2012b). Pervious concrete pavement performance modeling: an empirical approach in cold climates	149
B4.25.1 Focus of the Project.....	150
B4.25.2 Structural Design (Modeling) Performance	150
B4.26 Henderson and Tighe (2012). Evaluation of Pervious Concrete Pavement Performance in Cold Weather Climates	150
B4.26.1 Focus of the Project.....	151
B4.26.2 Mix Design and Structural Performance	151
B4.26.3 Hydrology and Water Quality Performance.....	151
B4.26.4 Maintenance Performance.....	152
B4.27 Huang et al (2012). Winter performance of inter-locking pavers-stormwater quantity and quality.....	152
B4.27.1 Focus of the Project.....	152
B4.27.2 Hydrology and Water Quality Performance.....	153
B4.28 Kayhanian et al (2012). Permeability measurement and scan imaging to assess clogging of pervious concrete pavements in parking lots.....	153
B4.28.1 Focus of the Project.....	154
B4.28.2 Hydrologic (infiltration Capacity) Performance	154

B4.29 Kevern (2012). Pervious concrete shoulders for stormwater management	154
B4.29.1 Focus of the Project.....	154
B4.29.2 Mix Design, Construction and Structural Design Performance	154
B4.30 Li et al (2012). Development of mechanistic-empirical design procedure for fully permeable pavement under heavy traffic	155
B4.30.1 Focus of the Project.....	156
B4.30.2 Structural Design and Simulations Performance	156
B4.30.3 Recommended Research Topics for Future Investigations.....	156
B4.31 Manahiloh et al (2012). X-Ray computed tomography and nondestructive evaluation of clogging in porous concrete field samples.....	156
B4.31.1 Focus of the Project.....	157
B4.31.2 Maintenance (Clogging) Performance	157
B4.32 Mata and Leming (2012). Vertical Distribution of Sediments in Pervious Concrete Pavement Systems	157
B4.32.1 Focus of the Project.....	157
B4.32.2 Hydrologic (Infiltration Capacity)Performance	157
B4.32.3 Maintenance (Clogging) Performance	157
B4.33 Roseen et al (2012). Water Quality and Hydrologic Performance of a Porous Asphalt Pavement as a Storm-Water Treatment Strategy in a Cold Climate.....	158
B4.33.1 Focus of the Project.....	158
B4.33.2 Hydrology and Water Quality Results	158
B4.34 Sumanasooriya et al (2012). Particle Packing-Based Material Design Methodology for Pervious Concretes.....	158
B4.34.1 Focus of the Project.....	159
B4.34.2 Mix design and Structural Design Performance	159
B4.35 Welker et al (2012). A side-by-side comparison of pervious concrete and porous asphalt	159
B4.35.1 Focus of the Project.....	159
B4.35.2 Water Quality Performance.....	160
B4.35.3 The only water quality parameter that was found to be different between the two pavements was pH, with the pervious concrete pavement having a lower pH. Over the yearlong study the pavements wore well with no significant signs of wear.....	160
B4.35.4 Structural Design Performance	160

B4.35.5 There were some signs of surface wear. Survey results of parking lot users, however, revealed perceptions were favorable with regards to esthetics, performance, and overall opinion on permeable pavements.	160
B4.35.6 Maintenance Performance.....	160
B4.35.7 Survey results indicated there were signs of clogging on the parking lots.	160
B4.36 Al-Rubaei et al. (2013). Long-Term Hydraulic Performance of Porous Asphalt Pavements in Northern Sweden	160
B4.36.1 Focus of the Project.....	160
B4.36.2 Infiltration Performance	160
B4.36.3 Maintenance Performance.....	161
B4.37 Coleri et al (2013). Clogging evaluation of open graded friction course pavements tested under rainfall and heavy vehicle simulators	161
B4.37.1 Focus of the Project.....	161
B4.37.2 Hydrologic Performance	162
B4.37.3 Mix Design and Structural Performance	162
B4.38 Drake et al (2013). Review of Environmental Performance of Permeable Pavement Systems: State of the Knowledge	162
B4.38.1 Focus of the Report	162
B4.38.2 Hydrology and Water Quality Performance.....	162
B4.38.3 Maintenance Performance.....	167
B4.38.4 Recommended Research Topics for Future Investigations.....	169
B4.39 Fan et al (2013). Microbial Community Structure and Activity under Various Pervious Pavements	170
B4.39.1 Focus of the Project.....	170
B4.39.2 Water Quality Performance.....	170
B4.40 Hein et al 2013b. Cleaning Methods for Pervious Concrete Pavements	171
B4.40.1 Focus of the Project.....	171
B4.40.2 Maintenance Performance.....	171
B4.41 Imran et al (2013). Permeable Pavement and Stormwater Management Systems: A Review	171
B4.41.1 Focus of the Project.....	171
B4.41.2 Hydrology and Water Quality Performance.....	172
B4.41.3 Recommendations for Future Research Investigation	172

B4.42 Li et al (2013a). The use of reflective and permeable pavements as a potential practice for heat island mitigation and stormwater management	172
B4.42.1 Focus of the Project.....	173
B4.42.2 Hydrologic (infiltration Capacity) Performance	173
B4.42.3 Mix Design and Structural Performance.....	173
B4.42.4 Albedo (Pavement cooling or Heat Island) Performance.....	173
B4.42.5 Recommended Research Topics for Future Investigation	173
B4.43 Li et al (2013b). Comparative field permeability measurement of permeable pavements using ASTM C1701 and NCAT permeameter methods.....	174
B4.43.1 Focus of the Project.....	174
B4.43.2 Hydrologic (Infiltration Capacity) Performance.....	174
B4.44 Mbanaso et al (2013). Laboratory-based experiments to investigate the impact of glyphosate-containing herbicide on pollution attenuation and biodegradation in a model pervious paving system.....	174
B4.44.1 Focus of the Project.....	175
B4.44.2 Hydrology and Water Quality Performance.....	175
B4.45 Sata et al (2013). Properties of pervious geopolymer concrete using recycled aggregates	175
B4.45.1 Focus of the Project.....	175
B4.45.2 Mix Design and Structural Design Performance.....	175
B4.46 Scholz (2013). Water Quality Improvement Performance of Geotextiles Within Permeable Pavement Systems: A Critical Review	176
B4.46.1 Focus of the Project.....	176
B4.46.2 Water Quality Performance.....	176
B4.46.3 Recommended Research Topics for Future Investigations.....	177
B4.47 Sonebi and Bassuoni (2013). Investigating the effect of mixture design parameters on pervious concrete by statistical modeling.....	177
B4.47.1 Focus of the Project.....	177
B4.47.2 Mix Design and Structural Design Performance.....	177
B4.48 Wardynski et al (2013). Internal Water Storage Enhances Exfiltration and Thermal Load Reduction from Permeable Pavement in the North Carolina Mountains	178
B4.48.1 Focus of the Project.....	178
B4.48.2 Hydrology and Water Quality Performance.....	178

B4.49 Yong et al (2013). Predicting physical clogging of porous and permeable pavements	179
B4.49.1 Focus of the Project.....	179
B4.49.2 Maintenance (Clogging) Performance	179
B4.50 Sañudo-Fontaneda et al (2014). Study on Field Study of Infiltration Capacity Reduction of Porous Mixture Surfaces	179
B4.50.1 Focus of the Project.....	179
B4.50.2 Infiltration and Hydraulic Performance	180
B5 Books and Other Publications	182
B5.1 Chopra et al (undated). Hydraulic Performance of Pervious Concrete Pavements.	182
B5.1.1 Focus of the Project.....	182
B5.1.2 Mix Design and Structural Design Performance.....	182
B5.1.3 Hydrology (infiltration Capacity) Performance	183
B5.2 Ferguson (2005). Porous Pavements	183
B5.2.1 Focus of the Book	183
B5.2.2 Mix Design, Construction and Structural and Design Aspects.....	183
B5.2.3 Hydrological Design Aspects and	184
B5.2.4 Water Quality and Environmental Concerns	184
B5.2.5 Maintenance Issues	184
B5.2.6 Costs.....	184
B5.3 Briggs (2006). Performance Assessment of Porous Asphalt for Stormwater Treatment	184
B5.3.1 Focus of the Project.....	185
B5.3.2 Mix Design, Construction and Structural Design Performance.....	185
B5.3.3 Hydrology and Water Quality Performance.....	185
B5.3.4 Conclusions	185
B5.3.5 Recommendations for Future Research Investigation	186
B5.4 Gunderson (2008). Pervious pavements: New findings about their functionality and performance in cold climates	186
B5.4.1 Focus of the Project.....	186
B5.4.2 Mix Design and Structural Design Performance.....	186
B5.4.3 Hydrology and Water Quality Performance.....	187
B5.4.4 Maintenance (Clogging) Performance	187

B5.4.5 Costs Comparison	187
B5.5 Houle (2008). Winter performance assessment of permeable pavements	187
B5.5.1 Focus of the Project.....	188
B5.5.2 Hydrologic Performance	188
B5.5.3 Maintenance Performance.....	188
B5.5.4 Recommendations for Future Research Investigation	188
B5.6 Thomle (2010). The Declining pH of Waters Exposed to Pervious Concrete.....	189
B5.6.1 Focus of the Project.....	189
B5.6.2 Hydrology and Water Quality Performance.....	189
B5.6.3 Recommended Research Topics for Future Investigations.....	189
B5.7 Boyer (2011). Preliminary analysis of summertime heat storage in traditional versus pervious concrete systems.....	189
B5.7.1 Focus of the Project.....	190
B5.7.2 Urban Heat Island (Solar Reflective Index) Performance	190
B5.7.3 Recommended Research Topics for Future Investigations.....	190
B5.8 Drake (2013). Performance and operation of partial infiltration permeable pavement systems in the Ontario climate	191
B5.8.1 Focus of the Project.....	191
B5.8.2 Hydrology and Water Quality Performance.....	191
B5.8.3 Cold Weather Operation Performance	192
B5.8.4 Maintenance Performance.....	192
B5.8.5 Recommended Research Topics for Future Investigation	193
B6 Appendix B References.....	195

Appendix B List of Figures

Figure B2-1. Typical cross-section of pervious concrete pavement. Concrete surface layer is 15-25% voids, subbase is 20-40% voids, and subgrade is 5-20% voids (ACPA 2009).	27
Figure B2-2. Elevation (top) and plan (bottom) views of typical pervious concrete installation on a steep slope (ACPA 2009).....	29
Figure B2-3. Typical porous asphalt cross-section (NAPA 2008)	31
Figure B2-4. Typical cross-section of a permeable interlocking concrete paver system (Smith 2011).	37
Figure B2-5. PICP design flow chart (ICPI 2011).....	38
Figure B2-6. One available design for using concrete pavers on sloped surfaces (ICPI 2011). ..	42
Figure B3-1. Compressive strength of pervious concrete as a function of time for different A/C and W/C ratios (Wanielista and Chopra 2007a).	71
Figure B3-2. Typical parking lot cross-section as recommended by UNHSC (2009).	80
Figure B3-3. Proposed fully permeable pavement shoulder retrofit design configuration 1 (Jones et al. 2010).	88
Figure B3-4. Proposed fully permeable pavement shoulder retrofit design configuration 2 (Jones et al. 2010).	89
Figure B3-5. Cost comparison for BMP and fully permeable pavement (low and high cost options) (Jones et al. 2010).	90
Figure B3-6. Procedure flow chart used in hydraulic performance simulation (Kayhanian et al. 2010).	93
Figure B3-7. Graphic illustration of three clogging surface profiles (Kayhanian et al. 2010).	94
Figure B3-8. Porosity profile of an actual PCC-O core sample compared with estimated porosity profile without maintenance after further use (Kayhanian et al. 2010).	95
Figure B3-9. Porous asphalt infiltration rates (UDFCD 2011b).....	106
Figure B3-10. Structural and hydrological design flowchart (Hein et al. 2013a).....	116
Figure B3-11. Conceptual permeable shoulder design configurations (Hein et al. 2013a).....	123
Figure B4-1. Influent and effluent concentrations of metals in the synthetic runoff with corresponding percent retentions (Dierkes et al. 1999).	127
Figure B4-2. Average temperature readings at the surface of each permeable pavement and overlying air temperature (Rowe et al. 2010).	142
Figure B4-3. Inflow and outflow hydrographs for inter-locking concrete pavers (Huang et a. 2012).	153
Figure B4-4. (A) Scheme of the eighteen car parking bays analyzed; and (B) measurement zones selected within each car park bay and LCS on-site (Sañudo-Fontaneda et al. 2014).....	180
Figure B4-5. Box-plots of the average values of permeability in each measurement zone of parking bays (Sañudo-Fontaneda et al. 2014).....	181

Appendix B List of Tables

Table B2-1. Typical Maintenance Activities for Pervious Concrete Pavement (ACPA 2009)...	30
Table B2-2. Recommend values of layer coefficient (NAPA 2008).....	32
Table B2-3. Minimum recommended thickness of compacted asphalt layer (NAPA 2008).	32
Table B2-4. Example open-graded asphalt mix (NAPA 2008).....	33
Table B2-5. Potential applications for different open-graded mixes (NAPA 2008).	34
Table B2-6. Removal efficiency of full depth permeable pavement systems reviewed by NAPA (2008).....	35
Table B2-7. Recommended minimum subbase and base thickness for PICP (Smith 2011).	40
Table B2-8. Pavement system selection guidance (InterPave 2010).....	47
Table B3-1. Porous asphalt aggregate gradation used in St. John and Horner (1997).	54
Table B3-2. Permeable pavement costs (Lampe et al. 2005).	61
Table B3-3. Dimensions and materials of pervious concrete sidewalks (Worel et al. 2007).	75
Table B3-4. Mix design proportions (Worel et al. 2007).	76
Table B3-5. Recommended aggregate gradations (UNHSC 2009).....	81
Table B3-6. Typical maintenance plan for pervious concrete (ACI 2010).....	84
Table B3-7. Variability in surface infiltration rates for different pavements (Drake et al. 2012).	108
Table B3-8. Change in surface infiltration rate for different pavement between 2010 and 2012 (Drake et al. 2012).	109
Table B3-9. Total mass and MLR of various pollutants for different permeable pavements (Drake et al 2012).	110
Table B3-10. Infiltration rates before and after maintenance (Drake et al. 2012).....	112
Table B4-1. Seasonal performance of porous asphalt (Roseen et al. 2006)	137
Table B4-2. Mix design used for first pervious shoulder in US (Kevern 2012).....	155
Table B4-3. Hydrologic performance of permeable pavements (Drake et al. 2013).....	163
Table B4-4. Infiltration capacity of older permeable pavements (Drake et al. 2013)	165
Table B4-5. Removal rates of metals and solids (Drake et al. 2013)	166
Table B4-6. Studies investigating the impact of maintenance (Drake et al. 2013)	168
Table B4-7. Other studies on maintenance (Drake et al. 2013).....	168

Acronyms, Abbreviations and Symbols

<i>Acronyms and Abbreviations</i>	
AASHTO	American association of state highway and transportation officials
ACPA	American Concrete Pavement Association
APA	Asphalt pavement analyzer
ASTM	American Standard Testing Methods
ATIRC	Advanced transportation infrastructure research center
ATPB	Asphalt treated pavement base
BMP	Best management practice
Caltrans	California Department of Transportation
CBR	California bearing ratio
CN	Curve number
CPG	Concrete Promotional Group
CRMCA	Colorado Ready Mixed Concrete Association
CT	X-ray computed tomography
DCP	Dynamic cone penetrometer
DOT	Department of transportation
EMC	Event mean concentration
EPA	Environmental protection agency
ER	Efficiency ratio
ESAL	Equivalent single axle load
FHWA	Federal highway administration
FWD	Falling head deflectometer
HEC	Hydrologic engineering center
HMA-O	Hot mixed asphalt-open graded
HMS	Hydrologic modeling system

HSG	Hydrology soil group
HVS	Heavy vehicle simulator
ICPB	Interlocking concrete pavement block
ICPI	Interlocking Concrete Pavement Institute
IDEAL	Integrated design evaluation and assessment of loading
IRI	International roughness index
LCA	Life cycle analysis
LCCA	Life cycle cost analysis
LID	Low impact development
ME	Mechanistic-empirical
MLR	Multiple linear regression or mass loading reduction
MnDOT	Minnesota department of transportation
MnRoad	Minnesota's Cold Weather Road Research Facility
NAPA	National Asphalt Pavement Association
NCAT	National center for asphalt technology
NPV	Net present value
NRCS	Natural Resources Conservation Services
OBSI	On board sound intensity
OGFC	Open graded friction course
PCC-O	Portland cement concrete-open graded
PCDI	Pervious concrete distress index
PDEP	Pennsylvania Department of Environmental Protection
PICP	Permeable interlocking concrete pavement
PSI	Pound per square inch (pressure)
PSR	Pressure serviceability readings
RE	Removal efficiency

RMC	Ready mixed concrete
SBUH	Santa Barbara unit hydrograph
SN	Structural number
SUDS	Sustainable urban drainage system
SWMM	Stormwater management model
UCD	University of California
UCPRC	University of California pavement research center
UDFCD	Urban Drainage and Flood Control District
UDFCD	Urban drainage and flood control district
UNHSC	University of New Hampshire stormwater center
USEPA	United States Environmental Protection Agency
<i>Symbols</i>	
A_c	Contributing watershed area
a_i	Structural layer coefficient
A_p	Horizontal surface area of permeable pavement
Ba	Barium
BOD	Biological oxygen demand
Ca	Calcium
Cd	Cadmium
Cl	Chloride
COD	Chemical oxygen demand
Cr	Chromium
Cu	Copper
d_i	Layer thickness
DIN	Dissolved inorganic nitrogen
d_{max}	Maximum allowable base/subbase depth

d_p	Depth of crushed stone base and subbase
f	Final infiltration rate into the underlying soil
Fe	Iron
FD_{single}	Fatigue damage from single axle loads (%)
FD_{tandem}	Fatigue damage from tandem axle loads (%)
FD_{total}	Total fatigue damage (%)
FD_{tridem}	Fatigue damage from tridem axle loads (%)
L_{total}	Total mass loads
M_r	Resilient modules
Mn	Manganese
MR	Subgrade resilient modules or flexural strength of concrete
n	Number of load application
Nf	Allowable applications before failure
NH_3	Ammonia
NH_4	Ammonium
NO_3	Nitrite
NO_2	nitrate
O&G	Oil and grease
Ortho-P	Ortho phosphorous
P	Design storm depth or Probability of failure
Pb	lead
p_i	Initial serviceability
p_t	Terminal serviceability
R	Resistance or reliability
S_0	Standard deviation
SC	Percent slabs cracked at the end of design life

SN	Structural number of the pavement = $\sum a_i \times d_i$
SR	Stress ratio
Sr	Strontium
T	Effective filling time of the base and subbase layers, or age of pavement in years
TKN	Total Kjeldahl nitrogen
TN	Total nitrogen
TOC	Total organic carbon
TP	Total phosphorus
TPH	Total petroleum hydrocarbon
TPH-D	Total petroleum hydrocarbon-diesel
T _s	Maximum allowable storage time
TSS	Total suspended solids
TZn	Total zinc
V _r	Void ratio of the base/subbase
W	Design traffic load in equivalent single axle loads (ESALs)
Zn	zinc
ZR	Standard normal deviate for reliability "R"
ΔQ_c	Runoff from watershed flowing onto permeable pavement
μ	Micron, which is 1/1000 mm
$\mu\text{g/L}$	Microgram per liter
σ_{eq}	Equivalent stress

Definition of Terminologies Commonly used in the Literature

Clogging: Anything that causes the gaps or void space in a permeable pavement to be reduced. Typically this occurs due to solids accumulating in void spaces or compaction of voids due to loading.

Open Graded Friction Course (OGFC): A layer of permeable asphalt or concrete typically 1-2 inches thick that is placed on top of an existing asphalt pavement. This is often done to reduce noise, increase friction, and reduce splash and spray during rainfall events. **Pervious Concrete:** Pavement with cement binder with larger aggregate size providing higher void content and allowing water to infiltrate through pavement. This definition is always associated with concrete pavement.

Permeable Interlocking Concrete Pavement (PICP): For the purpose of this report, any concrete block paver that allows water to infiltrate vertically downward through the pores of the concrete block or through the joints between pairs of concrete blocks is considered a PICP. Walker (2012) has further defined different kinds of PICPs as defined in this section.

Permeable Pavers: Individual solid concrete or brick blocks that are not permeable. The blocks are separated by joints filled with aggregate. Water can pass through the joints but does not pass through the blocks (Walker 2012).

Permeable Pavement: This definition applies to all pavement type defined above and usually implies that the water will infiltrate through or around the pavement with no or minimum overflow water.

Pervious Pavers: Pavers that are themselves permeable and allow water to pass through the block itself (Walker 2012).

Porous Asphalt: Pavement with asphalt binder (conventional or modified asphalt binder) with larger aggregate size providing higher void content and allowing water to infiltrate through pavement. This definition is always associated with asphalt pavement.

Porous Pavers: A grid system of blocks that are cellular in that there are open areas in the middle of and/or adjacent to each block. The blocks themselves are not permeable but the open areas, which are typically filled with dirt, sand, or gravel, allow water to pass through the grid system. The open areas also may allow vegetation to grow, which may provide additional stabilization (Walker 2012).

B1 Introduction

B1.1 Background

The term permeable pavement generally refers to a type of pavement that has several permeable layers and has the ability to store stormwater until it infiltrates through the subgrade soil. Depending on the type of surface pavement, permeable pavement can be referred as porous asphalt, pervious concrete, or interlocking concrete pavers. Permeable pavements have the ability to reduce stormwater runoff volume and improve water quality. For this reason, many communities are exploring their use as a stormwater management practice. The use of permeable pavements in practice, however, occurs under various hydrological and climatic conditions and is in the early development stage. Thus many questions remain unanswered.

There are many aspects to the construction and long term performance of a permeable pavement system. These include the design of the surface pavement and the underlying layers of storage volume, the ability of the surrounding soil to infiltrate water, construction practices, and maintenance requirements needed to maintain functionality. The quality of the permeable pavement system is highly dependent on the design specifications and construction practices used, as well as the maintenance practices. At present, several leading industries have developed brief guidance documents for the design and implementation of permeable pavements. Numerous questions related to structural performance, hydraulic performance, clogging, and maintenance remain unanswered, however, and these must be addressed before permeable pavements are fully implemented on local road and highway systems. Researchers are trying to address specific questions related to permeable pavements. For example, researchers in Minnesota have assessed the structural viability of permeable pavements in the Minnesota climate (Rohne and Izevbekhai 2009, Eller 2010, Vancura, et al. 2010). Numerous other researchers have investigated other aspects of permeable pavements. This document summarizes the published work of these investigations.

B1.2 Focus of the interim report

The Minnesota permeable pavement guidance document project was undertaken to fulfill six tasks. The first and second tasks of the study were to: 1) perform a literature review on documentation related to the implementation of permeable pavements, and 2) call and visit practitioners throughout North America who have experience with permeable pavement design and maintenance. The second task is closely related to first task, thus, the due dates for both tasks were the same. This interim report is prepared to fulfill both of the previously mentioned tasks.

B1.3 Organization of the interim report

This report is organized with the following major headings:

1. Introduction
2. Review of existing industry manuals

3. Review of technical reports
4. Review of peer reviewed publications, conference proceedings, etc.
5. Review of graduate school theses, books, and other publications

The introduction chapter presents background information, the focus of the report, and the report organization. Chapters 2 through 5 are review chapters that summarize findings related to structural, hydraulic (hydrology and water quality), and maintenance aspects of permeable pavements that have been published in reliable sources (e.g. industry manuals, technical reports, peer reviewed publications, and others). In some cases information is relevant but cannot be easily categorized as structural, hydraulic, or maintenance related. Such information is designated as "other."

B2 Review of Existing Industry Manuals

This chapter reviews primary design manuals and other publications related to the design of permeable pavements that have been produced by the permeable pavement industry.

B2.1 American Concrete Paving Association (ACPA 2009, undated)

ACPA (American Concrete Paving Association). 2009. *Stormwater management with pervious concrete pavement*. ACPA, Skokie, IL, USA.

American Concrete Pavement Association (ACPA). Undated. *PerviousPave-Background, Purpose, Assumptions and Equations*. Washington, D.C., USA.

Structure	Hydraulic	Maintenance	Other
<input checked="" type="checkbox"/>	<input checked="" type="checkbox"/>	<input checked="" type="checkbox"/>	

B2.1.1 Focus of the Project

The American Concrete Paving Association (ACPA) gives a general overview for using pervious concrete pavement for stormwater management (ACPA 2009). Pervious concrete is described as a mix of "specially formulated hydraulic cementitious materials, water, and uniform open-graded coarse aggregate (e.g., ASTM C33 Size numbers 5, 56, 67, 8, and 89)," which, when designed and installed properly, has a void space of 15% or more. It is suggested that pervious concrete has potential applications around buildings, in parking lots, low volume roads, and on highway shoulders and medians. A typical cross-section is given in Figure B2.1 in which the subbase is a stone reservoir that can store a finite volume of water. Not shown in the figure is a geosynthetic liner that the ACPA that should be placed below the subbase in order to prevent preferential flow paths and keep the bottom flat. Drain tiles (not shown) can be added below the pavement to convey water downstream in the stormwater management system.

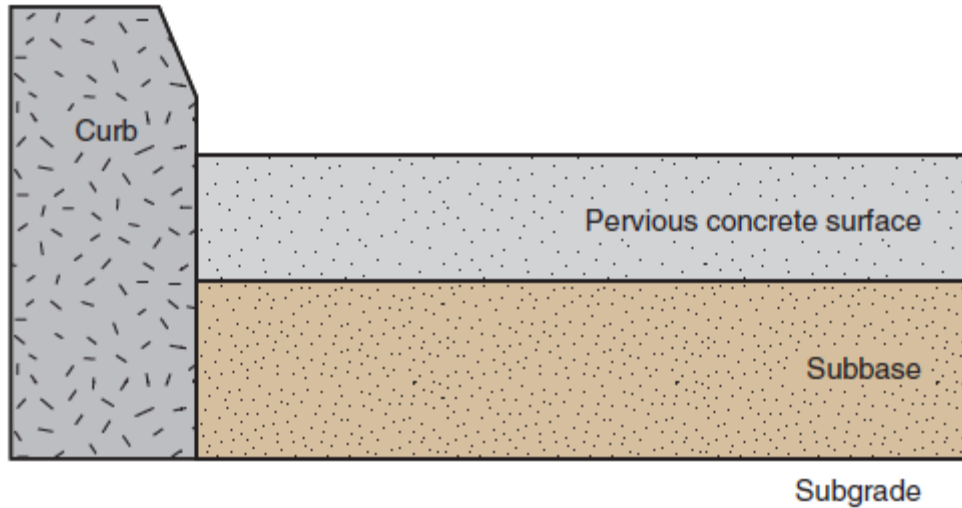

Figure B2-1. Typical cross-section of pervious concrete pavement. Concrete surface layer is 15-25% voids, subbase is 20-40% voids, and subgrade is 5-20% voids (ACPA 2009).

B2.1.2 Structural and Design Aspects

The American Concrete Pavement Association has adopted a structural design methodology and incorporated it into software called *PerviousPave* (ACPA undated A). This software determines the minimum required thickness of the pervious concrete layer and the required thickness of the subbase/reservoir layer but does not address other aspects such as the subgrade. Many studies have investigated the strength of pervious concrete but no well-accepted fatigue equation has been developed. As a result, *PerviousPave* uses the enhanced concrete fatigue model that was developed for *StreetPave* (a software package for the structural design of conventional concrete pavements). This approach was also suggested by a publication at the 2007 Annual Meeting of the Transportation Research Board and a 2008 publication in the *Journal of Green Building*. ACPA (undated A) details the design process which assumes fatigue is the sole failure criteria for structural design. In the process the total fatigue damage is given as:

$$FD_{total} = FD_{single} + FD_{tandem} + FD_{tridem} \quad 2-1$$

where, FD_{total} = total fatigue damage (%), FD_{single} = fatigue damage from single axle loads (%), FD_{tandem} = fatigue damage from tandem axle loads (%), and FD_{tridem} = fatigue damage from tridem axle loads (%). Fatigue damage for each axle type in Equation 2-1 is given by Miner's damage hypothesis, which is:

$$FD = \frac{n}{N_f} \quad 2-2$$

where, n = number of load applications (calculated from user traffic data), and N_f = allowable applications to failure. The value of N_f is estimated by:

$$\log N_f = \left[\frac{-SR^{-10.24} \log(1-P)}{0.0112} \right]^{0.217} \quad 2-3$$

where, SR = stress ratio (%), and P = probability of failure (%). The value of P is estimated by:

$$P = 1 - R * \frac{SC}{50} \quad 2-4$$

where, R = reliability as input by the user (%), and SC = percent slabs cracked at the end of the pavements life (assumed to be 15% in the program). In equation 2-3 the stress ratio, SR, is the equivalent stress (psi) divided by the flexural strength of the concrete (psi). The equivalent stress is given by:

$$\sigma_{eq} = \frac{6 * M}{h_c^2} * f_1 * f_2 * f_3 * f_4 \quad 2-5$$

where, σ_{eq} = equivalent stress (psi), M = equivalent moment (psi), h_c = concrete pavement thickness (in), f_1 = adjustment factor for the effect of axle loads and contact area, f_2 = adjustment factor for a slab with no concrete shoulder, f_3 = adjustment factor to account for the effect of truck wheel placement at the slab edge, f_4 = adjustment to adjust for approximately 23.5% increase in concrete strength with age and variation in material. Detailed equations and/or values for each adjustment factor and M are given in APCA (undated). *PerviousPave* incrementally increases the thickness of pavement, h, and calculates FD_{total} for each axle type and load group until FD_{total} reaches 100%, the limiting structural design criterion.

ACPA (2009) also states that the bottom of the stone subbase layer should be below the frost line when installation is in cold climates and at least 3 ft (1 m) above the seasonally high ground water table,

B2.1.3 Water Quality and Hydrology

ACPA(2009) states that the bottom of the stone subbase layer should be at least 100 ft (30 m) away from drinking water wells.

ACPA (2009) indicates that pervious concrete is best suited for soils with minimum infiltration rates of 0.5 in./hr (13 mm/hr) but that in areas with poorly draining natural soils they can still be used as long as they are designed properly. Modified designs for poorly draining soils typically include a rock-filled trench under the pavement and/or drain tiles to convey the infiltrated water downstream in the conveyance system.

For pervious concrete on steep slopes (applications on slopes up to 16% have been successful), it is recommended that trenches be installed that run across the sloping surface and that the trenches be lined with visqueen (a durable polyethylene sheeting) and filled with rock. Pipes or drain tiles, which are deemed as optional, can be placed in the trenches in order to allow water to leave the trench. A schematic of such a system is shown in Figure B2.2.

ACPA's program, *PerviousPave*, also incorporates a hydrologic design process that is based on the Los Angeles County Method (LADPW 2002). This method incorporates hydrologic design in conjunction with structural design. The required concrete thickness (as determined by the structural design) is maintained during the hydrologic design and the subbase thickness is adjusted until the entire system can store the design storm runoff volume. The user can choose whether the entire design volume will be stored in the voids of the subbase layer or if the void spaces of the pervious concrete layer and storage volume available above the pervious concrete (up to the curb height) will be used to store water. Given the permeability or infiltration rate into the soil, the program also checks to make sure the system can infiltrate the design volume in the desired time. For the actual equations used in the design see ACPA (undated).

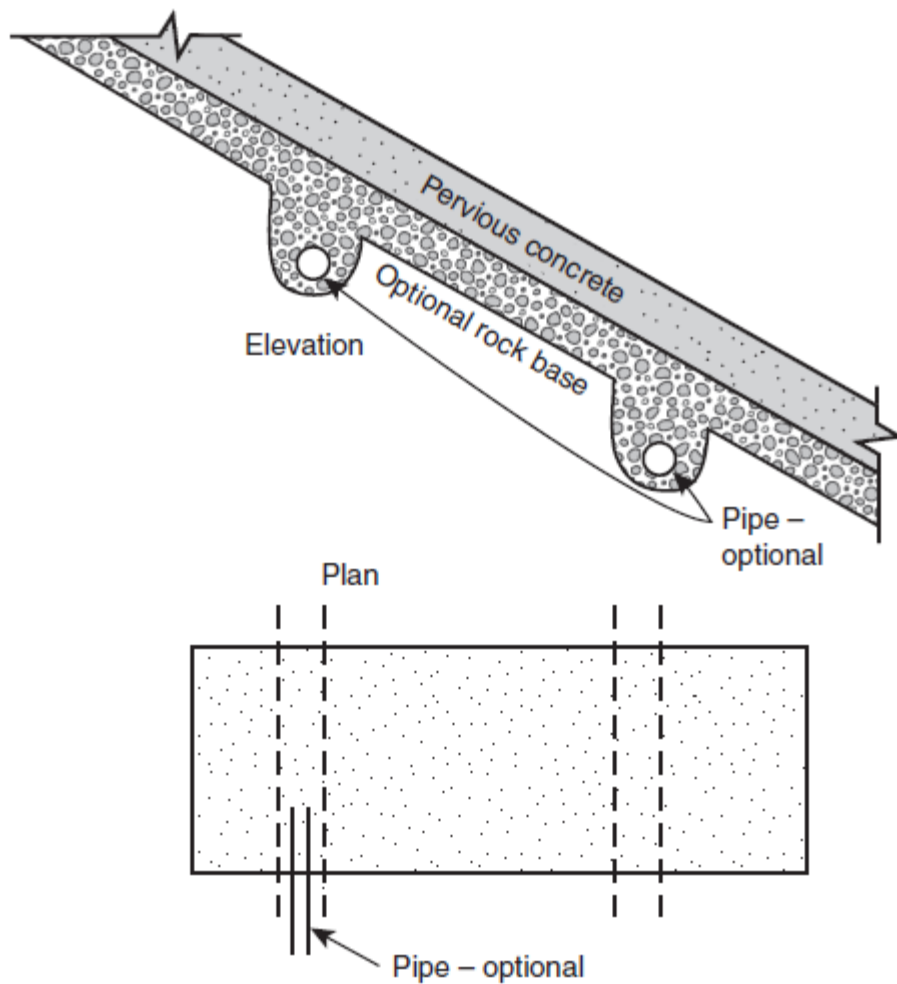

Figure B2-2. Elevation (top) and plan (bottom) views of typical pervious concrete installation on a steep slope (ACPA 2009).

B2.1.4 Maintenance

ACPA (2009) suggests that pervious concrete systems should be designed so that runoff from nearby soil areas do not transport solids to the system because this could clog the pervious concrete. It also suggests that all pervious concrete systems have some form of stormwater management pretreatment system in place and notes that care must be taken in cold regions where sand is applied to roadways during the winter months as this, too, could decrease infiltration rates. The application of deicing materials may be reduced with pervious concrete because melted snow and ice may infiltrate rather than remain on the surface and refreeze. Infiltration of water during the winter months may cause frost heave but designs with an adequate subbase layer and minimize the risk.

ACPA (2009) suggests that a maintenance agreement be in place that describes how to conduct routine maintenance and that signs be posted in the area identifying the pervious concrete. Maintenance schedules must be followed at all times and typical maintenance activities and frequency are given in Table B2-1. ACPA (2009) also states that vacuuming of the pervious concrete surface is preferred to pressure washing but that one of these should be performed at least annually and more often if needed.

Table B2-1. Typical Maintenance Activities for Pervious Concrete Pavement (ACPA 2009).

Activity	Schedule
Avoid sealing or repaving with impervious materials	N/A
Ensure that the pavement area is clean of debris	
Ensure that the pavement dewaterers between storms	As needed
Ensure that the pavement area is clean of sediments	
Mow upland and adjacent areas, and seed bare areas	As needed
Vacuum/sweep the pavement surface to keep it free of sediment	
Inspect the surface for deterioration or spalling	Annually

B2.2 National Asphalt Pavement Association (NAPA 2008)

NAPA (National Asphalt Pavement Association). 2008. *Porous asphalt pavements for stormwater management, Design, Construction and maintenance guide*. NAPA, Lanham, MD, USA.

Structure	Hydraulic	Maintenance	Other
<input checked="" type="checkbox"/>	<input checked="" type="checkbox"/>	<input checked="" type="checkbox"/>	

B2.2.1 Focus of the Project

NAPA (2008) presents design and construction guidelines for porous asphalt pavements. A typical cross-section, shown schematically in Figure B2.3, consists of uncompacted subgrade, a non-woven geotextile fabric, a stone subbase recharge bed, a choker coarse that is no more than 1 inch thick, and the porous asphalt layer on top.

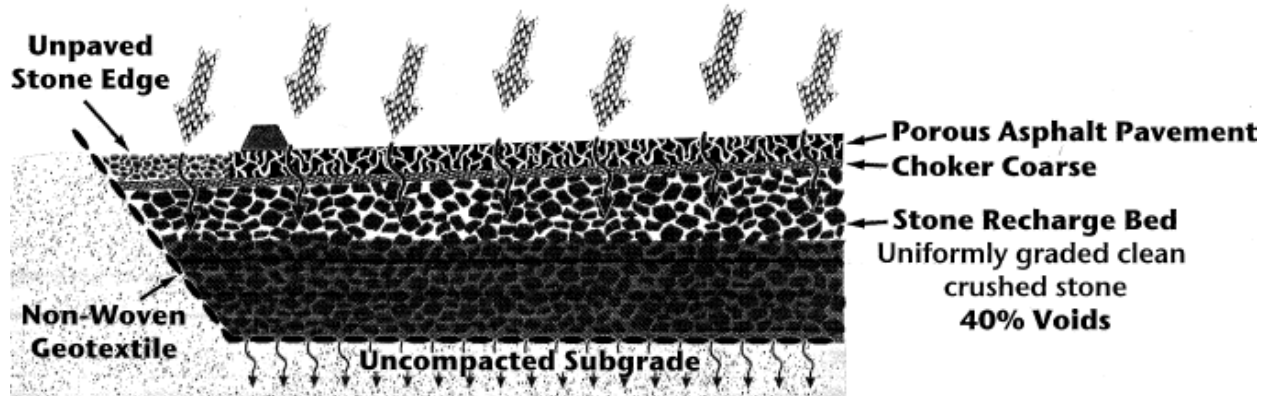

Figure B2-3. Typical porous asphalt cross-section (NAPA 2008)

The subgrade is uncompacted to allow for infiltration, the geotextile fabric prevents fines from entering the system, the stone recharge bed is 40% voids and allows for water storage, and the choker coarse stabilizes the surface for paving equipment.

B2.2.2 Structural and Design Aspects

At the time the NAPA (2008) report was written, most applications of porous asphalt were designed to carry light automobile traffic only and, in these situations, the structural requirements are not significant. In this situation the design is based solely on hydrologic criteria is enough to carry the traffic loads.

One structural application discussed in NAPA (2008) was a roadway constructed by the Arizona DOT in Chandler, AZ. The roadway consisted of 6 inches of open-graded asphalt on top of 6 inches of asphalt-treated permeable base (ATPB) which was placed on top of 8 inches of open-graded subbase that acted as the storage reservoir. In 2008, 22 years after it was constructed, the pavement was still functioning well.

The pavement was designed with structural coefficients of 0.40 for the open-graded surface, 0.20 for the ATPB, and 0.11 for the open-graded subbase. Typical values are 0.44 for dense-graded asphalt and 0.14 for dense-graded aggregate base and others report that 1.7 inches of an open-graded asphalt surface is equivalent to 1.0 inches of dense-graded asphalt. The resilient modulus of pavement cores were determined to be 180 ksi for the open-graded asphalt and 560 ksi for the dense-graded asphalt.

Other reports reviewed in NAPA (2008) indicate that, in the design process, untreated free-draining aggregate base properties are appropriate to use for porous asphalt stone recharge bed properties. One study in Oregon found ATPB layer coefficients to be between 0.14 and 0.19, whereas six other states use values of between 0.20 and 0.30, and ten states assign values to be equivalent to aggregate base values. In Oregon the DOT design guide calls for layer coefficients to be 0.42 for open-graded mixes and 0.24 for ATPB. In Vermont the recommended value is

0.33 for the layer coefficient of ATPB. NAPA (2008) recommended values for layer coefficients and minimum compacted thickness of the asphalt surface are given in Tables 2-2 and 2-3, respectively.

Table B2-2. Recommend values of layer coefficient (NAPA 2008).

Material	Layer Coefficient
Porous Asphalt	0.40 - 0.42
Asphalt Treated Permeable Base (ATPB)	0.30 - 0.35
Porous Aggregate Base	0.10 - 0.14

Table B2-3. Minimum recommended thickness of compacted asphalt layer (NAPA 2008).

Traffic Loading	Minimum Compacted Thickness (in)
Parking <i>(little or no trucks)</i>	2.5
Residential Street <i>(some trucks)</i>	4.0
Heavy Truck	6.0

B2.2.2.1 Frost Heave

NAPA (2008) acknowledges that it is not uncommon to recommend that the bottom of the recharge subbase be placed below the depth of winter frost penetration but that this practice has come into question recently due to successful installations that did not follow this practice. A University of New Hampshire publication (UNHSC 2009) recommends the depth of bed be 65% of the frost depth.

B2.2.2.2 Materials

To prevent fines from entering the subbase, NAPA (2008) states that a non-woven geotextile filter fabric is typically placed between the subgrade layer and underlying soil (it should be noted, however, that other documents to be discussed later suggest that a geotextile later can collect fines and cause clogging). The aggregate used for the recharge bed should be clean, crushed stone with little to no fines and a minimum void ratio of 40%. Typically, AASHTO No. 3 stone is specified but AASHTO No. 1 or 2 have also been used. If AASHTO No. 3 is used for the recharge bed it has been found that AASHTO No. 57 works well for the choker coarse. If a different size stone is used for the recharge bed, the choker coarse size must be adjusted accordingly.

The asphalt mix typically consists of polymer-modified asphalt and sometimes includes fibers. The polymers and fibers help to reduce draindown and the polymers help to improve resistance to scuffing at high temperatures. With regards to asphalt mix design, NAPA (2008) refers to some other NAPA documents on open graded friction courses (OGFC) but, because OGFCs are only a surface layer and not part of a full-depth porous asphalt system, those documents are not reviewed in this report. It is recommended to follow local DOT requirements and specifications and if there are none for asphalt treated permeable base, the following properties should be met:

1. Sixteen percent minimum air voids,
2. An asphalt content of 5.75% by weight of the total mix,
3. Draindown of 0.3% maximum,
4. To address moisture susceptibility follow the approach used for dense mixes using the same aggregate and asphalt,

As an example of mix gradations, the Oregon DOT specifications are given and reproduced here in Table B2-4. Also shown are potential applications for different open-graded mixes in Table B2-5.

Table B2-4. Example open-graded asphalt mix (NAPA 2008).

Sieve	NAPA IS-115	Oregon DOT Specifications			
		3/8 inch	1/2 inch	3/4 inch	ATPB
	Percent Passing				
1" (25 mm)				99-100	99-100
0.75" (19 mm)	100	-	99-100	85-96	85-95
0.5" (12.5 mm)	85-100	99-100	90-98	55-71	35-65
0.375" (9.5 mm)	55-75	90-100	-	-	-
#4 (4.75 mm)	10-25	22-40	18-32	10-24	2-10
#8 (2.36 mm)	5-10	5-15	3-15	6-16	0-5
#200 (0.075 mm)	2-4	1-5	1-5	1-6	0-2

Table B2-5. Potential applications for different open-graded mixes (NAPA 2008).

Mix Size	Application	Layer Thickness
0.375" (9.5 mm) Open Graded	Parking/Recreational Facilities	1.5 - 3.5 inches
1/2" (12.5 mm) Open Graded	Wearing Surface, Roads, Streets, Heavy Commercial	2.0 - 4.0 inches
0.75" (19 mm) Open Graded	Wearing Surface, Roads, Heavy Commercial	2.0 - 5.0 inches
0.75" (19 mm) ATPB	Base Course	3.0 - 6.0 inches

B2.2.3 Water Quality and Hydrology

NAPA (2008) states that sampling on porous asphalt systems has been limited but available data indicate high removal for TSS, metals, and oils and grease. Results from some studies are given in the report and those studies on full depth porous asphalt are summarized here. One report (Cahill et al. 2005) compares the performance (as removal efficiency in percent) of two infiltration trenches to two porous paving systems simply called "Porous Paving 1" and "Porous Paving 2." The porous pavings are not specified to be asphalt and may be reviewed simply to show the effectiveness of permeable pavements. In a second study, this one by the University of New Hampshire Stormwater Center (2007), the performance of a porous asphalt parking lot is reviewed. Due to poorly draining native soils, the parking lot system contained underdrains that conveyed the infiltrated water downstream in the system. In both cases it is not clear if removal efficiency is calculated based on event mean concentration (EMC), mass load, or some other basis. Table B2-6 summarizes the results of both studies.

With regard to hydrologic considerations during the design process, details are not given. Rather, general items to consider are reviewed. For example, the text states that native soils with infiltration rates of 0.1 to 10 inches/hour are reported as working the best and it is stated that infiltration systems work best on upland soils. Also, for determining runoff amounts, the curve number (CN) is recommended but the rational method is not. With regards to the CN method, hydrologic soil groups (HSG) A and B are listed as best suited for permeable pavements, but it is also stated that soil groups C and D can be used with special care (e.g. drain tiles, etc.). Other design criteria related to hydrology are:

1. Soils should be investigated prior to design (a detailed soil investigation process is outlined),
2. The minimum depth to bedrock or the seasonal high water table should be greater than two feet,

3. The bottom of the infiltration area should be flat to maximize the infiltration area
4. Maximum surface slopes should be 5%. If slopes are steeper, berms should be used between parking areas,
5. The maximum ratio of impervious to pervious area should be 5:1 but over carbonate soils with a risk of sinkholes maximum ratio should be 3:1. In known sinkhole areas porous asphalt should not be used,
6. An overflow systems should be included that will prevent water in the stone bed from rising to the pavement level,
7. An alternate pathway for water to enter the stone subbase (recharge) layer should be provided in case the surface becomes clogged,
8. The stone bed should drain within 12 to 72 hours.

The stone beds are typically between 12 and 36 inches in depth and approximately 40% voids. This means that between 4.8 and 14.4 inches of water, which is usually more than the design storm depth, may be stored in the bed. Thus, water from adjacent areas may be included in the storage (as long as the reservoir has sufficient capacity) but if runoff is directed towards the porous asphalt system, pretreatment may be necessary.

Table B2-6. Removal efficiency of full depth permeable pavement systems reviewed by NAPA (2008).

Water Quality Parameter	Porous Paving 1	Porous Paving 2	Porous Asphalt at UNH
Total Suspended Solids (TSS)	95	89	99
Total Phosphorus (TP)	71	65	38
Total Nitrogen (TN)	--	83	--
Total Organic Compounds (TOC)	--	82	--
Lead (Pb)	50	98	--
Zinc (Zn)	62	99	96
Cadmium (Cd)	33	--	--
Copper (Cu)	42	--	--
Total Petroleum Hydrocarbons in Diesel Range	--	--	99

NAPA (2008) states that:

"The water quality treatment performance of the porous asphalt lot generally has been excellent. It consistently exceeds EPA's recommended level of removal of total suspended solids, and meets regional ambient water quality criteria for petroleum hydrocarbons and zinc. Researchers observed limited phosphorus treatment and none for nitrogen, which is consistent with other non-vegetated infiltration systems."

With regards to chloride, no removal was observed but it was determined that porous asphalt could reduce the amount of salt needed for winter maintenance to a value between zero and 25% of what is typically required.

B2.2.4 Maintenance

As with any stormwater management practice, maintenance is critical. According to NAPA (2008), the most common cause of failure of asphalt pavements is the failure to control silts entering the site and associated clogging. Also, it is noted that the pavement must not be seal-coated and sand or ash must not be used for snow and ice control.

Maintenance plans call for inspections several times in the first few months after construction and at least once a year after that. Inspections should be performed after large storm events so that the drainage of the system can be evaluated. Vacuum sweeping of the porous asphalt surface is also recommended at least twice per year. Finally, damaged areas can be replaced with non-porous asphalt as long as the total non-porous area does not exceed 10% of the total paved area.

B2.3 Interlocking Concrete Pavement Institute (ICPI 2011).

Smith, David R. 2011. *Permeable Interlocking Concrete Pavements, 4th edition*. Interlocking Concrete Pavement Institute (ICPI), Herndon, VA, USA.

Structure	Hydraulic	Maintenance	Other
<input checked="" type="checkbox"/>	<input checked="" type="checkbox"/>	<input checked="" type="checkbox"/>	

B2.3.1 Focus of the Project

The Interlocking Concrete Pavement Institute (ICPI) presents design, specification, construction, and maintenance advice for permeable interlocking concrete pavements (PICP) (Smith 2011). These pavers, which can significantly reduce runoff volume and improve water quality, have joints or openings that are filled with permeable material that allows water to infiltrate across the pavement surface. The joints and/or openings typically cover about 5% to 15% of the total pavement surface area. A typical cross-section of a PICP system is shown in Figure B2-4.

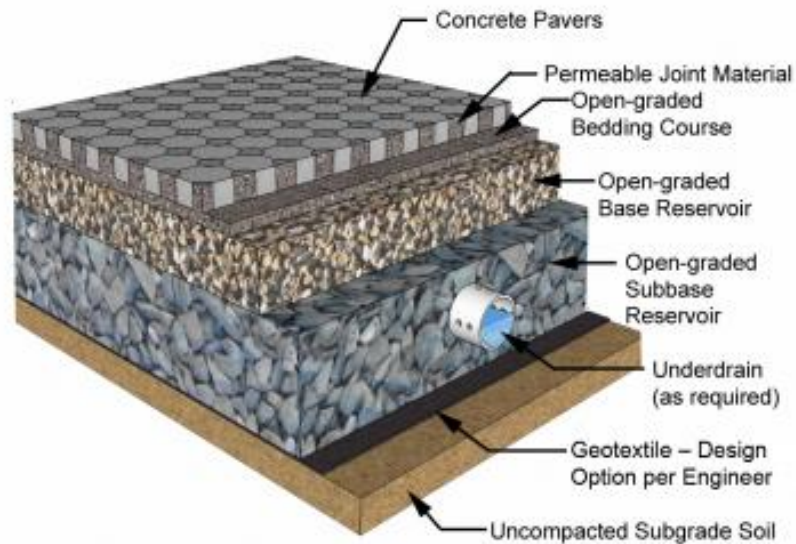

Figure B2-4. Typical cross-section of a permeable interlocking concrete paver system (Smith 2011).

The layers of materials in Figure B2-4, from top to bottom, consist of the concrete pavers, open-graded bedding course, open-graded base reservoir, open-graded subbase reservoir (with underdrain, if necessary), geotextile fabric (optional), and the subgrade soil. The open-graded bedding course is usually 2 inches thick, consists of small size aggregate (usually ASTM No. 8 or smaller) that allows infiltration, and provides a level bed for the pavers. The open-graded base reservoir is also permeable, is usually 4 inches thick, and consists of crushed stones from 0.5 to 1.0 inch in size. The open-graded subbase reservoir usually consists of stones from 2 to 3 inches in size and the thickness of this layer depends on water storage requirements and expected traffic loads. If the native soils underlying the PICP system do not provide adequate infiltration, the open-graded subbase reservoir may include a perforated underdrain (as shown) to convey water out of the system. Finally, a geotextile fabric may be placed between the open-graded subbase layer and the uncompacted subgrade soil. The purpose of the geotextile layer is to separate the system from the natural soil and to prevent fines from migrating into the layers above (some have recommended against the use of geotextile fabric because it may collect fines and limit infiltration, NHSWC, 2009). Concrete pavers should conform to the American Society for Testing and Materials, ASTM C 936 in the United States.

B2.3.2 Structural and Design Aspects

The design of PICP consists of both structural and hydrological components as shown in Figure B2-5 below. In brief, the pavement is designed twice. Once based on structural/loading requirements and once on hydrological requirements, with the thicker of the two resulting sections being selected. This literature review section covers the structural design process while the hydrological design process is covered in a later section.

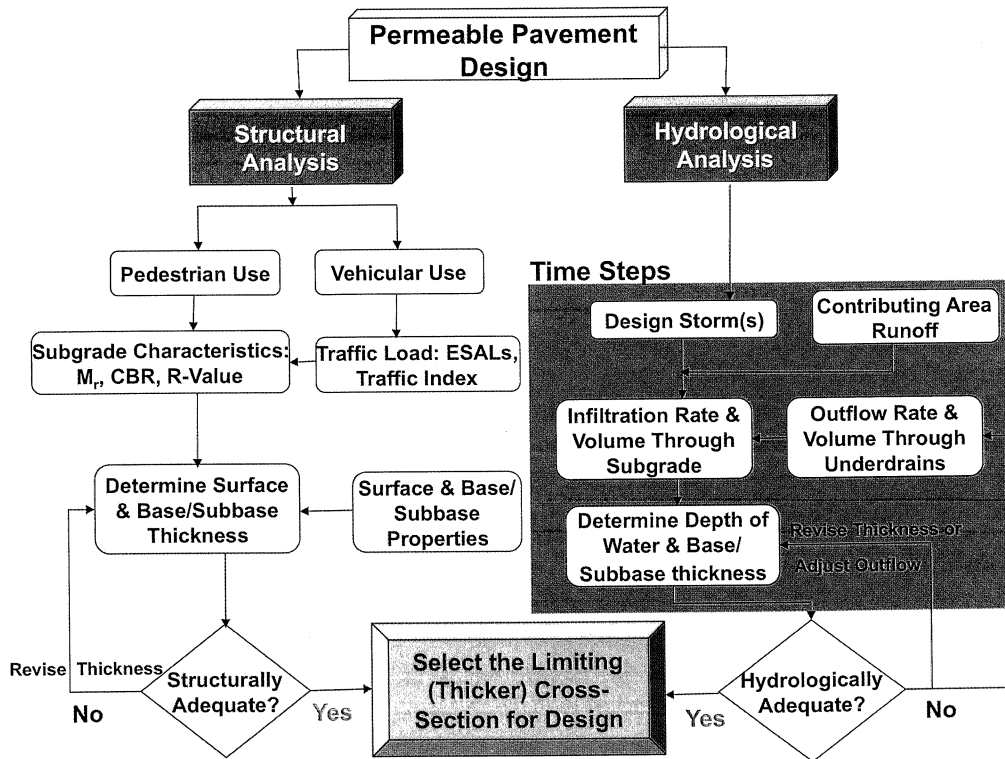

Figure B2-5. PICP design flow chart (ICPI 2011).

B2.3.2.1 Traffic Loads

Design of a PICP system requires that the number of equivalent single axle loads (ESAL) the pavement will experience over its lifetime (typically 20 years) be estimated. A detailed discussion of ESALs is beyond the scope of this report but, in brief, an ESAL is the equivalent loading caused by one 18,000 kip truck axle. Because PICP is used mostly for parking lots and residential streets, estimated values of ESALs are typically relatively low. Even so, PICP has proven durable in applications that experience heavier truck traffic such as fire stations and commercial parking lots.

B2.3.2.2 Subgrade Characteristics

Prior to design, the soil strength and/or stability under the proposed PICP must be quantified using the resilient modulus (M_r), California Bearing Ratio (CBR), or resistance (R-value). Minimum acceptable values are as follows: $M_r = 6,500$ psi (per AASHTO T-307), CBR = 4% (96-hour soaked per ASTM d 1883 or AASHTO T 193), and for R-value = 9 (per ASTM D 2844 or AAASHTO T-190). If soils need to be compacted or otherwise treated to increase strength, infiltration rates to be used in the hydrologic design should be measured after treatment.

B2.3.2.3 Structural Design

Smith (2011) recommends using the method described in AASHTO's Guide for Design of Pavement Structures (AASHTO 1993) for the design of PICP. This method uses a structural

number (SN), which can range from 2 to 10. In this method a minimum required SN is determined from expected ESALs, soil properties, moisture, and climate conditions. Based on its strength or stiffness, each layer of the pavement is assigned a layer coefficient. The thickness of each layer is multiplied by its layer coefficient and all such products are summed with the requirement being that the sum equal or exceed the SN.

Open-graded materials used in PCIP typically have lower layer coefficients than their dense-graded counterparts and values may be further reduced by 40% to 70% upon saturation, which will occur when water is stored in the void spaces. Because of the lower strength of open-graded base courses, these layers typically must be thicker than when designed with dense-graded aggregate. Because stability of the aggregate can be increased by adding underdrains, they are typically recommended. Layer coefficients values for PICP, which are typically 3.125 inches thick and placed over a 2 inch thick bedding layer of ASTM No. 8, 9, or 89 stone, have been estimated to range from 0.20 to 0.40 with 0.30 being a commonly accepted value.

Open-graded bases should have less than 2% fines and typically have densities of 95 to 120 lb/ft³ and porosities greater than 30%. When the PICP will experience vehicle loads, joint, bedding, base, and subbase aggregates should be crushed with no less than 90% fractured faces and a minimum Los Angeles (LA) abrasion value of less than 40 (per ASTM C131 and C535). Base and subbase materials are recommended to have minimum values of 0.32 for porosity and 80% for CBR.

Smith (2011) reviews a German study (Zement 2003) that recommends a conservative minimum resilient modulus for base materials of 14,500 psi and a minimum soil subgrade M_r value of 6,500 psi (i.e. CBR = 4.3%). Smith (2011) goes on to report recommended minimum PICP subbase and base thickness which are reproduced in Table B2-7. The reported values assume a confidence level of 80%, that the traffic is 10% commercial vehicles, and that each commercial vehicle has an ESAL of 2. The layer coefficient for ASTM No. 57 stone is assumed to be 0.09 (i.e. $M_r = 19,300$ psi) and for ASTM No. 2 stone the assumed value is 0.06 ($M_r = 12,800$ psi). Pedestrian only PICP uses only ASTM No. 57 stone with a minimum thickness of 6 inches unless a greater value is required for water storage. Residential driveways are reported as having subbase of ASTM No 2 stone at least 6 inches thick over a 4 inch ASTM No. 57 base, with some designs using only ASTM No. 57 stone for both base and subbase.

Table B2-7. Recommended minimum subbase and base thickness for PICP (Smith 2011).

Pedestrian	Soaked CBR (R-value)	4 (9)	5 (11)	6 (12.5)	7 (14)	8 (15.5)	9 (17)	10 (18)
	Resilient Modulus, psi (Mpa)	6,205 (43)	7,157 (49)	8,043 (55)	8,877 (61)	9,669 (67)	10,426 (72)	11,153 (77)
	Base thickness, in. (mm) ASTM No. 57	6 (150)						
Vehicular	Soaked CBR (R-value)	4 (9)	5 (11)	6 (12.5)	7 (14)	8 (15.5)	9 (17)	10 (18)
	Resilient Modulus, psi (Mpa)	6,205 (43)	7,157 (49)	8,043 (55)	8,877 (61)	9,669 (67)	10,426 (72)	11,153 (77)
Lifetime ESALs (Traffic Index)								
50,000 (6.3) and Residential Driveways	Base thickness, in. (mm) ASTM No. 57	4 (100)						
	Subbase thickness in. (mm) ASTM No. 2	6 (150)						
100,000 (6.8)	Base thickness, in. (mm) ASTM No. 57	4 (100)						
	Subbase thickness in. (mm) ASTM No. 2	8 (200)	6 (150)					
200,000 (7.4)	Base thickness, in. (mm) ASTM No. 57	4 (100)	4 (100)					
	Subbase thickness in. (mm) ASTM No. 2	13 (325)	11 (275)	9 (225)	7 (175)	6 (150)		
300,000 (7.8)	Base thickness, in. (mm) ASTM No. 57	4 (100)	4 (100)	4 (100)	4 (100)	4 (100)		
	Subbase thickness in. (mm) ASTM No. 2	16 (400)	14 (350)	12 (300)	10 (250)	9 (225)	8 (200)	7 (175)
400,000 (8.1)	Base thickness, in. (mm) ASTM No. 57	4 (100)	4 (100)	4 (100)	4 (100)	4 (100)	4 (100)	4 (100)
	Subbase thickness in. (mm) ASTM No. 2	19 (475)	16 (400)	14 (350)	12 (300)	11 (275)	10 (250)	9 (225)
500,000 (8.3)	Base thickness, in. (mm) ASTM No. 57	4 (100)	4 (100)	4 (100)	4 (100)	4 (100)	4 (100)	4 (100)
	Subbase thickness in. (mm) ASTM No. 2	21 (525)	18 (450)	16 (400)	14 (350)	12 (300)	11 (275)	10 (250)
600,000 (8.5)	Base thickness, in. (mm) ASTM No. 57	4 (100)	4 (100)	4 (100)	4 (100)	4 (100)	4 (100)	4 (100)
	Subbase thickness in. (mm) ASTM No. 2	22 (550)	19 (475)	17 (425)	15 (375)	14 (350)	12 (300)	11 (275)
700,000 (8.6)	Base thickness, in. (mm) ASTM No. 57	4 (100)	4 (100)	4 (100)	4 (100)	4 (100)	4 (100)	4 (100)
	Subbase thickness in. (mm) ASTM No. 2	24 (600)	21 (525)	18 (450)	17 (425)	15 (375)	14 (350)	12 (300)
800,000 (8.8)	Base thickness, in. (mm) ASTM No. 57	4 (100)	4 (100)	4 (100)	4 (100)	4 (100)	4 (100)	4 (100)
	Subbase thickness in. (mm) ASTM No. 2	25 (625)	22 (550)	20 (500)	18 (450)	16 (400)	15 (375)	13 (325)
900,000 (8.9)	Base thickness, in. (mm) ASTM No. 57	4 (100)	4 (100)	4 (100)	4 (100)	4 (100)	4 (100)	4 (100)
	Subbase thickness in. (mm) ASTM No. 2	26 (650)	23 (575)	21 (525)	19 (475)	17 (425)	16 (400)	14 (350)
1,000,000 (9)	Base thickness, in. (mm) ASTM No. 57	4 (100)	4 (100)	4 (100)	4 (100)	4 (100)	4 (100)	4 (100)
	Subbase thickness in. (mm) ASTM No. 2	27 (675)	24 (600)	21 (525)	19 (475)	18 (425)	16 (400)	15 (375)

B2.3.2.4 Design in Cold Climates

Studies on the use of PICP and other permeable pavements in cold climates has indicated that the open-graded bases tend to retain heat and act as an insulating layer that can prevent or delay frost formation (Smith 2011). Smith (2011) also reviewed studies that demonstrated the insulating affect can also reduce the amount of required de-icing agents applied during the winter months.

The only study reviewed by Smith (2011) that was on the use of PICP in cold climates was performed by the City of Chicago Department of Transportation during the winter of 2008-2009. During this time ambient air temperatures were monitored in the upper, middle, and lower sections of PICP on Maxwell Street Market Plaza. One the coldest day when temperatures reached -7° F the coldest temperatures measured in the upper, middle, and lower sections were 33.4 °F, 34.1 °F, and 38.6 °F, respectively.

If chloride concentrations in the runoff and/or groundwater are potential problems, designs can be modified in an attempt to minimize the impact of chlorides. For example, runoff can be

diverted away from the pavement via pipes in the base/subbase. This requires that pipe valves be adjusted each winter and spring and also eliminates the treatment of runoff.

It is also recommended that in areas where the frost depth exceeds 3 ft, PICP be set back from the subgrade of roads by at least 20 ft. This will reduce the potential of negative impacts on the PICP from frost lenses and heaving of the soil under the road. In areas where space limitations prevent such a design, vertical impermeable liners and perforated underdrains along the side of PICP adjacent to the roadway may be used to lessen the impact of frost.

B2.3.3 Water Quality and Hydrology

PICP systems can be designed with or without an underdrain. If the system does not contain an underdrain it is referred to as a full exfiltration system. Such systems are typically placed over high infiltration soils such as gravels and sands and perimeter drains allow water to exit the system when overflows occur. Systems with underdrains in the open-graded subbase layer are referred to as partial infiltration systems. Although infiltration into the subgrade can occur, the natural soils at the site are much less permeable and the system relies on underdrains to convey a significant fraction of infiltrated water downstream. The elevation of the underdrains controls the depth of water stored in the open-graded subbase layer, which infiltrates over time. In this design, water is typically stored for 24 to 48 hours, which can enable nutrient reduction via denitrification.

Some systems may have no exfiltration whatsoever due to very low permeable soils or restrictions on contaminant loading to soils. If exfiltration must be eliminated an impermeable liner can be used underneath the entire PICP system. A distance of 1 ft between the barrier and the seasonal high water table is typically recommended. Also, to protect the barrier, a geotextile fabric can be placed between the impermeable barrier and the subbase.

For PICP applications on slopes greater than 2%, designs should include flow barriers that retain water in the open-graded subbase. One typical design is shown in Figure B2-6. The volume available for water storage, which is shown as the hatched area, can be estimated from simple geometry.

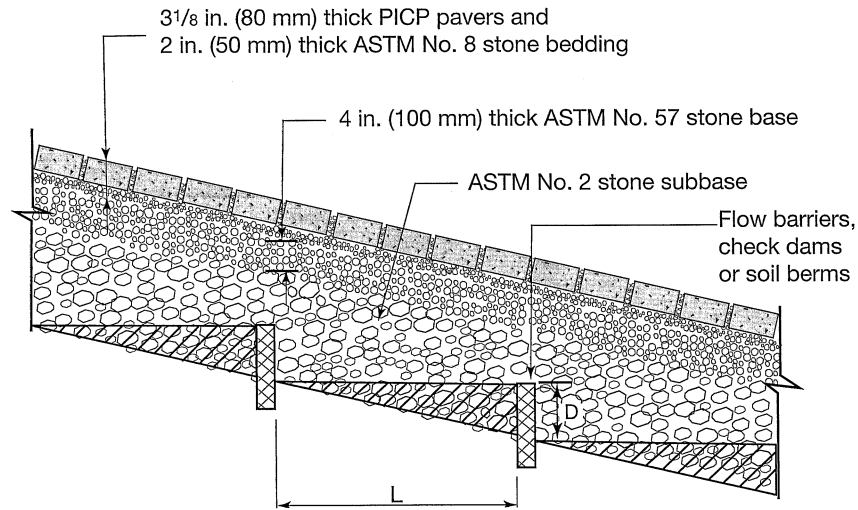

Figure B2-6. One available design for using concrete pavers on sloped surfaces (ICPI 2011).

When performing hydrologic analysis, the surface area of PICPs should be considered 100% pervious because, when functioning properly, all water that lands on the surface will infiltrate through the joints and/or open spaces. Initial infiltration rates depends on the infiltration rates of the joint material and underlying layers. Joint material is typically ASTM No. 8 stone that can have infiltration rates in excess of 2000 in/hr. Long-term infiltration rates depend on maintenance activity and frequency and the solid loadings onto the PICP surface. One reviewed study that investigated PICP systems that were eight to ten years old and never received maintenance found that they have infiltration rates between 0.5 and 37.5 in/hr (Beecham 2009). Other studies (Borgwardt 1994, 1995, 1997, 2006) found that infiltration rates decrease by 75% to 90% during the first few years. A recommended conservative design value for a maintained PICP system is 10 in/hr.

When designing an PICP, the design storm and watershed area must be obtained to determine the volume of runoff for which the system must be designed. Also, a thorough soil investigation must be performed to determine if the soil is adequate for PICP with regards to infiltration capacity, strength, compaction requirements, etc.

Assuming a design water volume has been obtained and the soil is adequate for PICP, the following design procedure can be used for systems that contain no underdrains (i.e. full exfiltration systems). The maximum allowable storage time must first be determined. This helps ensure the subgrade is not saturated for too long. With this time limit and the value of final infiltration rate into the soil, f , the maximum allowable base/subbase depth can be estimated to be:

$$d_{max} = \frac{fT_s}{v_r} \quad 2-6$$

where d_{\max} = maximum allowable base/subbase depth, f = final infiltration rate into the soil, T_s = maximum allowable storage time, V_r = void ratio of the base/subbase (typically 0.4).

To calculate the area of permeable pavement, A_p , required and the depth of open-graded base and subbase, d_p , Smith (2011) develops two equations for the volume of water stored in the base and subbase. One is based on runoff rates, direct precipitation onto, and infiltration through the permeable pavement and the other is based solely on pavement geometry. Setting these equations equal to each other and rearranging enabled the following equations to be developed:

$$A_p = \frac{\Delta Q_c A_c}{V_r d_p - P + fT} \quad 2-7$$

$$d_p = \frac{\Delta Q_c R + P - fT}{V_r} \quad 2-8$$

where A_p = horizontal surface area of permeable pavement (ft^2), ΔQ_c = runoff from watershed flowing on to permeable pavement (ft), A_c = contributing watershed area (ft^2), V_r = void ratio of crushed stone base and subbase (typically 0.4), d_p = depth of crushed stone base and subbase (ft) (does not include bedding course or pavers), R = ratio of the contributing area to the permeable pavement area, P = design storm depth (ft), f = final infiltration rate into the underlying soil (ft/hr), and T = effective filling time of the base and subbase layers (hr). For NRCS Type II storms, the effective fill time is generally assumed to be 2 hours and equations 2-7 and 2-8 are used to design the PICP by first using equation 2-8 to determine d_p and using this value in equation 2-7 to determine the minimum pavement area required, A_p .

If the depth of pavement required exceeds the maximum depth of pavement allowed, d_{\max} , then underdrains should be included in the design and the system will be a partial exfiltration system. If underdrains are used, the design process is similar except that the number of underdrains needs to be estimated and the above equations are modified to incorporate outflow through the underdrains. Smith (2011) gives more details and thorough design examples for both full exfiltration and partial exfiltration systems. Other design considerations discussed include soil compaction, geotextiles, runoff estimates, and water quality improvement.

With regards to improving water quality, PICP reduces mass loads primarily through infiltration although some filtration and sedimentation can occur in the aggregate layers. Sandy soils have a larger capacity for infiltration but typically cannot remove as much dissolved metal ions as clays. Clays, on the other hand, have a lower infiltration capacity than sands. One report reviewed (Debo and Reese 1995) recommended that stormwater infiltrate through at least 18 inches of soil that has a minimum cation exchange capacity of 5 milliequivalents per 100 g of dry soil.

Additional treatment by or in PICP can occur via bacteria treatment in the aggregate base/subbase layers and underlying soil. Several studies were reviewed that demonstrated the ability of PICP to reduce contaminants such as TSS, metals, oil drippings, and nutrients.

B2.3.4 Maintenance

Although it is usually recommended not to apply sand to the surface of permeable pavements, Smith (2011) recommends that, if sand has been applied for traction during the winter months, it should be removed by vacuuming the surface in the spring. Otherwise, if sand fills the joints and/or open spaces, it could reduce infiltration. Also, if salts are applied, it is recommended to monitor chloride concentrations in groundwater below the PICP. Finally, regardless of whether sand has been applied or not, maintenance should include annual inspection in the spring.

B2.4 Portland Cement Association (PCA 2007). Hydrology Design of Pervious Concrete

Leming, M.L., Malcom, H.R., Tennis, P.D. 2007. *Hydrologic Design of Pervious Concrete*, Portland Cement Association (PCA), Skokie, IL, USA.

Structure	Hydraulic	Maintenance	Other
	<input checked="" type="checkbox"/>		

B2.4.1 2.4.1 Focus of the Project

An overview of design methods for determining the hydrological performance of pervious concrete is provided. The publication is intended to provide assistance to design and permitting professionals as well as land developers and owners.

B2.4.2 2.4.2 Water Quality and Hydrology

Leming et al. (2007) states that for the design storm stormwater runoff should not occur due to low infiltration capacity of the pervious concrete or insufficient storage volume for water within the pervious concrete system. If the pervious concrete surface is well maintained, the infiltration capacity of the pervious concrete will be much higher than the underlying soil and, as a result, the infiltration capacity of the pervious concrete will not be a critical design parameter. The storage capacity of the pervious concrete system will, however, be a critical design factor because it must be large enough to store a required runoff volume.

The storage capacity of the entire pervious concrete system includes the capacity within the pervious concrete layer, the capacity within the base course and, in some circumstances, may also include storage due to curbs and/or underground storage tanks.

To determine runoff volumes, Leming et al. (2007) recommends using the method described in Technical Release 55 (i.e. TR-55) by the National Resource Conservation Service (NRCS 1986). This method is commonly called the Curve Number method. According to Leming et al. (2007) the Rational method may also provide accurate results under certain circumstances. Both methods are discussed below.

B2.4.2.1 The Curve Number Method

Leming et al. (2007) claim the Curve Number method is the most appropriate method when the main purpose of the pervious concrete system is to reduce runoff volume. As described in NCRS (1986) the Curve Number method estimates the depth of runoff using the following equation.

$$Q^* = \frac{(P-0.2S)^2}{(P+0.8S)} \quad 2-9$$

where Q^* = runoff depth (inches), P = precipitation depth (inches), S = maximum basin storage after runoff begins (inches) = $(1000/CN) - 10$, and CN = composite curve number for the site. The CN is based on soil type and land use and values can be found in NCRS (1986).

Leming et al. (2007) suggests that the pervious concrete system should be able to infiltrate most or all of the 2 year return period, 24 hour storm and that the performance of the system should be checked for at least the 10 year, 24 hour storm. It must be noted, however, that local requirements may dictate the design storm to be used.

In the Curve Number method, the hourly rainfall as described by the design storm is mathematically applied to the watershed of the pervious concrete system. Leming et al. (2007) suggests using the NCRS (1986) rainfall distribution. Equation 2-9 is then used to calculate the hourly incremental depth of rain that falls on adjacent areas that ends up as runoff. By adding runoff volumes from adjacent areas to the rain falling directly on the pervious concrete and accounting for infiltration into the underlying soil, the total volume of water to be stored in the pervious concrete system can be calculated. Travel time is not incorporated into the design method but this makes the calculations simpler and the results conservative. This process is completed for the entire rain event or until the storage capacity of the system has been exceeded. If the storage volume is exceeded, surface runoff will be generated from the pervious concrete system. If this is not desirable or acceptable, the pervious concrete system must be redesigned so that the storage volume is not exceeded. For examples of this design method see Lemming et al. (2007).

B2.4.2.2 The Rational Method

According to Leming et al. (2007) the Rational method can provide acceptable results when used to estimate the peak runoff flow rate onto simple pervious concrete systems but some of the advantages of using pervious concrete may not be evident in the design and analysis. Also, with complex systems the Rational method may not be acceptable because it will not capture some hydrological features.

The Rational method, which estimates the peak flow rate and not a depth or volume of runoff, is as follows.

$$Q = CiA \quad 2-10$$

where Q = the peak flow rate of runoff (ft^3/s), C = the runoff coefficient for the surface (from zero to 1.0), and A = watershed area (acres).

The duration of the design storm should be set equal to the time of concentration of the watershed and runoff coefficients may vary based on the return period of the design storm (e.g. values of C increase for higher return period storms).

No other guidance or information regarding the design process using the Rational method is given in Leming (2007). Presumably, once a value of peak flow has been obtained, the designer can determine if the peak flow rate can be infiltrated by the pervious concrete system.

B2.5 InterPave (2010). Permeable Pavements: Guide to the design, construction and maintenance of concrete block permeable pavements

InterPave. 2010. *Permeable Pavements: Guide to the design, construction and maintenance of concrete block permeable pavements*. Leicester, England.

Structure	Hydraulic	Maintenance	Other
<input checked="" type="checkbox"/>	<input checked="" type="checkbox"/>	<input checked="" type="checkbox"/>	

B2.5.1 Focus of the Project

InterPave (2010) provides guidance for engineers/designers, planners, and other decision making professionals in the design, construction, and maintenance of concrete block pavers. Similar to other design procedures, design considerations are divided into two parts, one for structural considerations and one for hydrologic considerations. The more conservative of the two designs is the one that governs.

B2.5.2 Structural and Design Aspects

The structural design process outlined in InterPave (2010) uses a series of tables and charts to guide the user to a final pavement design. Different pavement cross-sections are provided and the user selects one based on the expected traffic loads. Each cross-section dictates the thickness of each layer within the pavement system. If the underlying soils have a low California Bearing Ratio value, the thickness of the some layers are adjusted accordingly, again using values from a provided table. In a final step, InterPave (2010) provides guidelines for protecting the pavement from construction traffic such as using the capping layer as a road surface during construction or placing a temporary layer of sacrificial geotextile and hardcore on the permeable subbase.

B2.5.3 Water Quality and Hydrology

The publication differentiates between total infiltration, partial infiltration, and no infiltration systems. Total infiltration systems have no underdrains to convey water out of the system because they are designed to fully infiltrate the design storm. Partial infiltration systems have underdrains included in the subbase so that some water passes through the underdrain and out of the system and some water still infiltrates into the underlying soil. Systems with no infiltration

have underdrains with an impermeable layer on top of the underlying soil so that no water infiltrates into the soil but rather all water is conveyed out of the system by the underdrains. Based on the permeability of the subgrade (i.e. underlying soils), InterPave (2010) gives guidance with regards to the appropriateness of each kind of system as shown in Table B2-8. If either systems A or B are to be selected, the groundwater table must be more than 1 meter below the bottom of the subbase.

InterPave (2010) was published in England and focuses on permeable pavement design there. Guidance is given for determining design rainfall events in England and, given the rainfall depth, tables provide required subbase thicknesses. Adjustments to the available storage volume are to be made if the pavement will be sloped. These adjustments are based on geometry and are much like those of other publications already reviewed. Further adjustments, based on ratios of land areas, are made if the permeable pavement receives runoff from adjacent areas.

Table B2-8. Pavement system selection guidance (InterPave 2010).

		System A total infiltration	System B partial infiltration	System C no infiltration
permeability of subgrade defined by coefficient of permeability k (m/s)	10 ⁻⁶ to 10 ⁻³	✓	✓	✓
	10 ⁻⁸ to 10 ⁻⁶	X	✓	✓
	10 ⁻¹⁰ to 10 ⁻⁸	X	X	✓
highest recorded water table within 1000mm of formation level		X	X	✓
pollutants present in subgrade		X	X	✓

B3 Review of Technical Reports

This chapter reviews technical (non-design) reports on permeable pavements that have been published by or for entities such as industry organizations, government agencies, academic and research units, and commercial organizations. The reviews presented in this chapter are those that are readily available to the public and have been produced by credible sources.

B3.1 ACPA (undated B). Cement-Treated Permeable Base for Heavy-Traffic Concrete Pavements

ACPA (American Concrete Paving Association). undated B. Concrete Information: Cement treated permeable base for heavy-traffic concrete pavements. ACPA, Arlington Heights, IL, USA.

Structure	Hydraulic	Maintenance	Other
<input checked="" type="checkbox"/>			

B3.1.1 Focus of the Project

ACPA (undated B) discusses adding cement to the permeable base course in order to provide more strength to pervious concrete for situations that will be subject to heavy construction traffic loads.

B3.1.2 Structural and Design Aspects

In one study (Hall 1994) it was found that concrete-treated permeable bases have compressive strengths (at 7 days) from 150 to 600 psi. The permeable base is a layer of typically open-graded aggregate placed below the pervious concrete. Typical gradations are shown in Table B3-1. This base allows water to pass through to the existing soil and also provides storage volume for rainwater runoff. The strength of the permeable base layer can be significantly increased by adding cement and water to the aggregates. Cement content can range from 150 to 300 lb per cubic yard, with 200 lb per cubic yard being common. For light truck traffic, lower cement content can be used (i.e. 150 lb per cubic yard) and for heavier truck traffic higher cement content (250 lb per cubic yard) can be used. Typical water:cement ratios are 0.36 to 0.37, but it has been suggested that the water:cement ratio selected should be based on workability rather than strength. A separate geotextile layer is also used between the permeable base and the subgrade and lateral drainage pipes can be placed near the edge of the pavement to drain the pavement and convey infiltrated water downstream.

Table B3-1. Typical Gradations for Cement-Treated Permeable Bases (ACPA undated B).

Sieve Size	Percent Passing				
	No. 57 Stone	No. 67 Stone	Virginia	California	Nevada
1 1/2 in. (37.5 mm)	100			100	
1 in. (25.0 mm)	95-100	100	100	88-100	100
3/4 in. (19.0 mm)		90-100		x ± 15*	90-100
1/2 in. (12.7 mm)	25-60		25-50		
3/8 in. (9.5 mm)		20 - 55		x ± 15*	20-55
No. 4 (4.75 mm)	0-10	0-10	0-10	0-16	0-10
No. 8 (2.36 mm)	0-5	0-5	0-5	0-6	0-5
No. 200 (75 µm)					0-2

B3.1.3 Construction Practices

The cement-treated permeable base must be compacted by vibrating plates or screeds with the objective of solidly seating the material on the subgrade. Curing is usually done by spraying with a fine mist of water several times a day.

The thickness of pervious concrete can range from 3 to 6 inches with 4 inches being the most common. Also, edgedrains may also be installed if necessary.

B3.1.4 Maintenance

Edgedrains and outlets, if present, must be inspected and maintained at regularly scheduled intervals in order to retain system effectiveness.

B3.2 Concrete Promotional Group (undated). Handbook for Pervious Concrete Certification

CPG (Concrete Promotional Group). Undated. *Handbook for Pervious Concrete Certification in Greater Kansas City*. CPG, Overland Park, KS, USA.

Structure	Hydraulic	Maintenance	Other
<input checked="" type="checkbox"/>		<input checked="" type="checkbox"/>	

B3.2.1 Focus of the Project

CPG (undated) has developed a handbook for pervious concrete certification in the Kansas City area. The handbook lists guidelines and specifications for design and construction of pervious concrete. Portions relevant to this document are summarized herein. Various other suggestions and specifications are given with respect to admixtures, aggregates, construction, joints, etc. and the reader should keep in mind that only a brief overview is listed here.

B3.2.2 Structural and Design Aspects

Suggestions for the design of pervious concrete are:

1. The bottom of the rock base that acts as a reservoir should be flat, if possible. When construction is on a sloped surface, trenches or check dams built into the soil or subgrade can be used to hold back the flow of water beneath the surface of the pervious concrete,
2. Driving lanes should be paved with regular concrete; pervious concrete can be used in parking stalls,
3. The existing subgrade should not be compacted. Fill can be compacted to 92%,
4. Filter fabric (4 oz. non-woven) shall be placed between the subgrade and base and up the side to the surface, and may continue up and over the surrounding soils for 2 to 3 ft,
5. Pervious concrete 6 inches thick is common for parking spots and 8 inches is common for residential streets,
6. Jointing pervious concrete is similar to conventional concrete but saws should not be used,
7. One-quarter to 0.50 inch aggregate is preferred with a specific gravity greater than 2.5 and an adsorption less than 2.5,
8. Rounded and angular aggregate have different advantages and disadvantages but both can be used,
9. Do not use hot water because it can render admixtures useless,
10. Placement should only occur between April 1 and November 1,
11. The temperature shall not be expected to exceed 90°F or be expected to drop below 40°F for at least 7 days after placement,
12. Joints are spaced (in feet) at twice the pavement thickness in inches. For example, a 5 inch thick pavement would have joints spaced every 10 ft. But joints should never be spaced at greater than 15 ft,
13. Curing must take place within 3 to 5 minutes behind the screed,
14. To cure, spray the surface with soybean oil and cover with minimum 6 mil poly sheeting,
15. After curing, the concrete can be cross-rolled to work out bumps, etc. Cross-rolling is done over the poly sheeting used to cure the concrete and can be performed over joints.

B3.2.3 Maintenance

CPG (undated) states that vacuuming and wet vacuuming have been the most successful maintenance technique for surface cleaning. While power washing can be helpful, a high pressure was is not recommended because it can loosen aggregate.

During winter months, CPG (undated) claims there is no reason to use deicers because there is no standing water on the surface and snow and ice does not refreeze because it moves into the base and subbase.

B3.3 Crouch et al. (undated). Pervious Portland Cement Concrete Compressive Strength in the Laboratory and the Field

Crouch, L.K., Smith, N., Walker, A.C., Dunn, T.R., A. Sparkman. Undated. Pervious PCC compressive strength in the laboratory and the field: The effects of aggregate properties and compactive effort.

Structure	Hydraulic	Maintenance	Other
<input checked="" type="checkbox"/>			

B3.3.1 Focus of the Report

Three gradations of crushed limestone and two gradations of gravel were investigated in the laboratory to determine the impact of the aggregate and the compaction effort on the compressive strength of pervious concrete. Four field samples were also obtained and tested.

B3.3.2 Structural and Design Aspects

Crouch et al. (undated) reached the following conclusions:

1. For a constant paste amount and character, effective air void content appears to be a function of three factors: 1) compactive effort, 2) aggregate particle shape and surface texture, and 3) aggregate uniformity coefficient. Smoother and rounder aggregates, for the same compactive effort, result in lower voids and void content decreases as the uniformity coefficient increases.
2. For a consistent paste amount and character, the compressive strength of pervious concrete appears to be a function of 1) effective air void content, and 2) gradation fineness modulus. As void content and aggregate fineness modulus increase, the compressive strength decreases.
3. A low cementitious content, a uniform aggregate gradation, and high compactive effort can produce pervious concrete with infiltration capacity values higher than 142 in/hr and compressive strengths greater than 3000 psi.

B3.4 Izevbekhai (undated). Acoustic properties of clogged pervious concrete pavements

Izevbekhai, B. undated. Acoustic properties of clogged pervious concrete pavements.

Structure	Hydraulic	Maintenance	Other
		<input checked="" type="checkbox"/>	<input checked="" type="checkbox"/>

B3.4.1 Focus of the Project

This undated publication evaluates the effect of clogging and the efficacy of simple maintenance practices to mitigate clogging. Written by Dr. Izevbekhai, a concrete research operations engineer for MnDOT, this report focuses on pervious concrete applications in Minnesota and their corresponding maintenance strategies.

B3.4.2 Maintenance

Winter application of sand and salt is not used for the Minnesota pervious concrete applications discussed by Izevbekhai (undated), instead the pavements are plowed (or groomed for snowmobile use). In extreme cases, however, test cells at MnROAD do receive light applications of salt in addition to plowing. Non-winter maintenance typically includes vacuuming and regenerative air sweeping of pervious concrete surfaces.

Maintenance activities for a pervious concrete boat ramp in Detroit Lakes includes, in addition to grooming, sweeping of debris during the spring thaw and monthly sweeping during the non-winter months.

The City of Shoreview vacuums their pervious concrete streets monthly and also provides monthly sweeping of larger debris such as leaves. Shoreview also has an extensive outreach plan that educates residents about practices that may clog pervious concrete (e.g. sodding and seeding).

B3.4.3 Conclusions

Izevbekhai (undated) reached the following conclusions:

1. Clogging reduces the acoustic properties of pervious pavements and colloidal (or plastic clogging agents) such as clay have the worst clogging effects,
2. Clogging increases the tortuosity of pervious concrete and decreases the sound absorption capability of pervious concrete. The original sound adsorption (SA) coefficient can be restored with vacuuming,
3. Clogging and lead to more freeze-thaw damage by trapping water in the pervious concrete,
4. Permeability of pervious concrete can be at least partially restored by vacuuming. But if vacuuming does not occur for an extended period of time, the pervious concrete can experience damage and the original void content cannot be restored,
5. Any pervious concrete should be subject to the best maintenance practices available to minimize clogging. The maintenance plan of the City of Shoreview, MN can be followed.

B3.5 Suleiman et al (undated). Effect of Compaction Energy on Pervious Concrete Properties

Suleiman, M.T., Kevern, J., Schaefer, V.R., K. Wang. undated. Effect of compaction energy on pervious concrete properties.

Structure	Hydraulic	Maintenance	Other
<input checked="" type="checkbox"/>			

B3.5.1 Focus of the Report

The impact of compaction energy on pervious concrete void ratio, compressive strength, tensile strength, unit weight, and freeze-thaw durability was investigated by researchers at Iowa State University. Single sized crushed limestone and river gravel were investigated

B3.5.2 Structural and Design Aspects

Suleiman et al. (undated) reached the following conclusions:

1. Decreasing compaction energy reduces compressive strength, split strength, and unit weight but increases permeability,
2. When subject to freeze-thaw cycles samples prepared with regular compaction energy experienced aggregate failure while those prepared with low compaction energy failed through aggregate and paste,
3. Compaction effort has a significant impact on freeze-thaw durability.

B3.5.3 Identified Data Gaps and Research Suggestions

Suleiman et al. (undated) suggested that further research into the effect of compaction energy on pervious concrete properties should be performed.

B3.6 St. John and Hornder (1997). Washington Report on the Effect of Road Shoulder Treatments on Runoff Quantity and Quality

St. John, M.S., Horner, R.R. 1997. *Effect of Road Shoulder Treatments on Highway Runoff Quality and Quantity*, Washington State Transportation Center, University of Washington, Seattle, WA. Report WA-RD 429.1.

Structure	Hydraulic	Maintenance	Other
	<input checked="" type="checkbox"/>		

B3.6.1 Focus of the Project

The focus of this project was to investigate the effect of different shoulder surfaces on stormwater runoff volumes and quality. Conventional asphalt, gravel, and porous asphalt shoulders were tested on a heavily traveled (average daily traffic of about 9,000 vehicles in each direction), two-lane road in the State of Washington. The pertinent results related to hydrology and water quality are summarized below.

B3.6.2 Water Quality and Hydrology

The shoulder segments tested in this study received runoff from the adjacent roadway and rain that fell directly on the segment. Flow-weighted composite samples of runoff were collected after the water left the shoulder. The research involved sampling storms greater than or equal to 0.25 inches of rain as well as controlled experiments with simulated rainfall to determine runoff coefficients of each shoulder material. The soil under all shoulder test segments was assumed to

be the same because it was all fill material brought in during construction of the road and, based on tests at the site, consisted of about 30% gravel, 62% sand, and 8% fines. The water table was determined to be 4 ft below the ground surface.

The gravel shoulder consisted of 0.50 to 0.75 inch diameter crushed gravel with a depth of 3 inches. The conventional asphalt test sections used densely graded aggregate and were paved according to typical paving specifications and compacted to a depth of 3 inches. The asphalt binder specified was AR-4000 and was 3.5% to 4.0% of the mix. The porous asphalt sections also used AR-4000 binder at 3.5% to 4.0%, had an aggregate gradation as specified in Table B3-1, and were lightly compacted to a depth of 3.5 inches. Infiltration tests using a single ring infiltrometer found average infiltration rates of 12.3 in/hr and 1750 in/hr for the gravel and porous asphalt sections, respectively.

Eleven rainfall events with depths ranging from 0.30 inches to 1.5 inches were monitored over a nine month period with flow-weighted composite samples collected from each of the shoulder test sections. Nine of the 11 events occurred between November and April and were classified as "wet season" events. Also, simulated rainfall event experiments were performed in order to determine runoff coefficients of each of the surfaces.

Table B3-1. Porous asphalt aggregate gradation used in St. John and Horner (1997).

Sieve	Percent Passing
1/2 inch	100
3/8 inch	95-100
1/4 inch	19-46
#8	0-28
#40	0-16
#200	0-5

The gravel and porous asphalt sections reduced runoff volume by 30% and 85%, respectively as compared to conventional asphalt. Overall, during wet season runoff events the gravel shoulder reduced pollutant loads 10% to 70% (as compared to conventional asphalt) with the exception of orthophosphorus, which increased by almost 30%. Solid and pollutant loads from the porous asphalt shoulders were reduced by more than 90% with removal rates in both cases being highest for pollutants associated with total suspended solids.

A summary of water quality related results follows:

- All three shoulder sections had lower average wet season event mean concentrations (EMC) of solids and pollutants as compared to the road runoff. The road area was larger

than the shoulder area of each section so this could have been due, at least in part, to dilution,

- The pollutant and solid EMCs of all test sections were 3 to 15 times higher after sanding events,
- Solid and pollutant EMCs were up to 17 times higher for the summer runoff event as compared to average wet season values. This could have been due to a 17 day dry period before the summer rainfall event in which pollutants may have accumulated,
- Total suspended solids (TSS) EMC from the porous asphalt shoulder was 75% lower than that of the conventional asphalt while the TSS EMC from the gravel shoulder was 10% higher,
- Wet season TSS loads for gravel and porous asphalt were 74% and 3%, respectively of the conventional asphalt shoulder load,
- The TSS loads from the sanding event were, for the gravel and porous asphalt shoulders, respectively, 50% and 23% of the TSS load from the conventional asphalt shoulder,
- The TSS load for the gravel and porous asphalt shoulders from the summer runoff event were 106% and 34%, respectively, as compared to the conventional asphalt load,
- Turbidity levels from all test sections was well correlated with TSS concentrations,
- The average turbidity from the porous asphalt shoulders was over 50% less than that of the conventional asphalt shoulder. Due to large variance, however, the difference was not statistically different,
- Biochemical oxygen demand (BOD) average wet season concentrations were higher in runoff from the gravel (6.1 mg/L) and porous asphalt (6.7 mg/L) shoulders as compared to the conventional asphalt shoulder (5.5 mg/L). The differences, however, were not statistically significant,
- Average wet season chemical oxygen demand (COD) EMC values from the gravel and porous asphalt shoulders were 37% and 51% lower, respectively, than the average COD EMC from the conventional asphalt shoulder. This difference was deemed statistically significant,
- Wet season COD loads from the gravel and porous asphalt shoulders were 56% and 94% lower, respectively, than the average COD load from the conventional asphalt shoulder. BOD loads were 21% and 84% lower, respectively,
- No definitive conclusions could be reached regarding dry season and the sanding event data because only one data point for each scenario was obtained,
- Wet season total phosphorus (TP) loads from the gravel and asphalt shoulders were 81% and 6% of the load, respectively, of the conventional asphalt shoulder,
- Wet season orthophosphorus loads were 30% higher in the gravel shoulder runoff and 90% lower in the porous asphalt shoulder runoff as compared to the load from the conventional asphalt shoulder,

- The wet season lead, zinc, and copper loads from the porous asphalt shoulder were all at least 90% lower than the load from the conventional asphalt shoulder whereas loads from the gravel shoulder were 7% to 70% lower,
- After one year of use the porous asphalt shoulder showed no signs of clogging. It maintained its infiltration rate of 1750 in/hr. The gravel shoulders, however, were beginning to erode,
- Runoff from the shoulders was not toxic.

St. John and Horner (1997) concluded the following:

- Porous asphalt shoulders have a greater potential to reduce 1) runoff volumes, 2) peak flows, and 3) solid and pollutant concentrations as compared to gravel and conventional asphalt shoulders.
- Porous asphalt shoulders are more effective at removing soluble pollutants, especially orthophosphorus, as compared to gravel and conventional asphalt shoulders.
- Removal of particulate and soluble pollutants by porous asphalt shoulders can be attributed to infiltration.

B3.6.3 Identified Data Gaps and Research Suggestions

Recommendations for future research include:

- The potential for clogging of porous asphalt shoulders should be quantitatively evaluated.
- If experiments indicate that porous asphalt shoulders will not totally clog in five years or less, a program to install such shoulders should be implemented.
- If gravel shoulders are to be used, the mix should be revised so that the gravel is not a source of phosphorus.
- Extractions on new asphalt mix should be conducted to determine if it is a source of phosphorus.

B3.7 Lampe et al (2004). Report on Monitoring to Determine Performance and Whole-life Costs

Lampe, L., Andrews, H., Martin, P., Barrett, M., Jefferies, C., Woods-Ballard, B., Kellagher, R., and M. Hollon (2004). *Post-project Monitoring of BMPs/SUDs to Determine Performance and Whole-Life Costs: Phase 2*. Prepared for WERF, AwwaRF, and UKWIR. Report No. 01-CTS-21T.

Structure	Hydraulic	Maintenance	Other
<input checked="" type="checkbox"/>	<input checked="" type="checkbox"/>	<input checked="" type="checkbox"/>	

B3.7.1 Focus of the Project

Lampe et al. (2004) includes a literature review and information from survey of stormwater authorities and organizations in the United States and the United Kingdom that identified the

most commonly used BMPs/SUDS. The availability of cost and performance data was also determined. Information related to permeable pavements is reviewed herein.

B3.7.2 Structural and Design Aspects

The review by Lampe et al. (2004) revealed the following research needs related to structural and design:

- Investigation of the relationship between aggregate grading and performance under load,
- Determining the performance of geosynthetic structures,
- Development of standard specifications for materials and installation,
- Development of specifications for geotextiles (if and/or where they should be installed, if used what types would maximize pollutant capture),
- Determination of installation costs.

B3.7.3 Water Quality and Hydrology

The review by Lampe et al. (2004) revealed the following research needs related to water quality and hydrology:

- Investigation related to the performance of saturated subgrades,
- Determining the effects of vertical and horizontal attenuation processes through the granular subfill and by evaporation,
- Investigation into the water quality aspects of porous pavements, including the effects of polluted runoff, pollutant loadings and how it varies with season, impact of pollutants on groundwater and soil

B3.7.4 Maintenance

The review by Lampe et al. (2004) revealed the following research needs related to maintenance of permeable pavements:

- Determination of optimal methods of block replacement (for PICP),
- Determination of a typical useful life,
- Determination of the effect of maintenance on whole-life performance,
- Determination of the effect of various operation and maintenance intervals, equipment, and techniques.

B3.8 NRMCA (2004). Freeze-Thaw Resistance of Pervious Concrete

NRMCA (National Ready Mix Concrete Association). 2004. Freeze-thaw resistance of pervious concrete. National Ready Mix Concrete Association, Silver Spring, MD, USA.

Structure	Hydraulic	Maintenance	Other
<input checked="" type="checkbox"/>	<input checked="" type="checkbox"/>		<input checked="" type="checkbox"/>

B3.8.1 Focus of the Project

NRMCA (2004) discusses the freeze-thaw impact on pervious concrete and gives design recommendations based on typical climate conditions.

B3.8.2 Structural and Design Aspects

Recommendations are given based on climate. Typical conditions in Minnesota would be classified as "Hard wet freeze" conditions because the ground stays frozen for long periods of time and there can be precipitation during this time. As a result, the pervious concrete can become fully saturated. In such conditions the following suggestions, in order of preference, are made:

1. Include an 8 to 24 inch thick layer of clean aggregate base below the concrete,
2. Use an air-entraining admixture in the paste, and
3. Install a perforated PVC pipe in the aggregate base to drain infiltrated water.

All three measures do not necessarily need to be used in combination on a single project.

NRMCA (2007) also lists several case studies. Only one, however, was located in a "Hard wet freeze" region. That particular case study was a side walk on the Penn State campus that experiences, on average, 120 freeze-thaw cycles a year. Also the average daily temperature is typically below freezing for 90 days. The sidewalk, which was constructed in 1999, consists of a 4 inch thick pervious concrete layer and an 8 inch subbase layer made up of large, washed aggregate. The performance of the sidewalk has been good even though very little maintenance had been performed on the concrete.

B3.9 Tennis et al (2004). Pervious Concrete Pavements

Tennis, P., Leming, M., Akers, D. 2004. Pervious Concrete Pavements, EB302.02, Portland Cement Association, Skokie, Illinois, and National Ready Mixed Concrete Association, Silver Spring, Maryland, USA, 36 pages.

Structure	Hydraulic	Maintenance	Other
<input checked="" type="checkbox"/>		<input checked="" type="checkbox"/>	

B3.9.1 Focus of the Project

Tennis et al. (2004) presents information on the uses, benefits, properties, design, and maintenance of pervious concrete for stormwater management. Topics relevant to this report are summarized herein.

B3.9.2 Properties and Mix Design

For quality control, Tennis et al. (2004) recommend using unit weight or bulk density because other properties, such as slump and cylinder strength tests, don't have much meaning for

pervious concrete. For example, strengths are a function of void content and placement methods and it's difficult to accurately represent field placement in a cylinder test. Unit weights are expected to be 70% of traditional concrete mixes.

The density of pervious concrete is typically 100 to 125 lb/ft³ and permeability can range from 288 to 770 in/hr with values of 1650 in/hr or higher measured in some laboratory tests. A typical compressive strength value is 2500 psi but values can range from 500 to 4000 psi and flexural strength can range from 150 to 550 psi. Shrinkage, which is typically around 200×10^{-6} , is about one-half of what typically occurs in conventional concrete.

The voids in pervious concrete can provide freeze-thaw resistance if these voids drain before freezing. Air entrained in the paste can also improve freeze-thaw resistance and placing the pervious concrete over at least 6 inches of drainable rock base is recommended in freeze-thaw environments.

Typical mix proportions for pervious concrete are 450 to 700 lb/yd³ of cementitious materials, 2000 to 2500 lb/yd³ of aggregate, at water:cement ratio of 0.27 to 0.34, aggregate:cement ratio of 4 to 4.5:1, and a fine:coarse aggregate ratio of zero to 1:1.

B3.9.3 Structural and Design Aspects

Like other publications, Tennis et al. (2004) base design on both the runoff storage requirements and strength/structural integrity of the pavement. Two separate designs are required with the greater resulting thickness being the required design thickness. Because this design process is similar to other publications already reviewed, details are not provided herein.

B3.9.4 Construction

Prior to construction the subbase must be smoothed and compacted. Compaction to a density of 90 to 95% is often recommended but it is noted that compaction decreases permeability.

In order to prevent drying, it is recommended that the subgrade be moist but without standing water just prior to pervious concrete placement. Also, the maximum handling time between mixing and placement was one hour, although this can be extended to 1.5 hours by use of appropriate admixtures.

Pervious concrete cannot be pumped so site access is an important aspect of any job. Placement should be continuous and spreading and strikeoff should be rapid. Conventional formwork should be used as should mechanical vibration and manual screeds. Manual screeds must be used with caution, however, as they can cause tears in stiff mixes. Strike off should occur about 0.5 to 0.75 inches above the desired final height to allow for compaction. Compaction should typically be done with a steel roller and should be completed within 15 minutes of placement. Compaction is typically the last step as normal floating and trowel operations reduce the permeability of the surface.

Tennis et al. (2004) recommends placed joints to prevent random cracking with joints one-fourth of the slab thickness with spacing of 20 ft or more being typical. Joint installation with a rolling joint tool was recommended soon after construction. Saw cutting joints was not recommended because slurry from sawing can plug voids and raveling of cut joints can occur. If random cracking is acceptable, pervious concrete can have no joints as cracking will not affect the strength of the pavement.

To insure proper moisture during curing, the subbase should be moist prior to placement and, after compaction, fog misting and plastic sheeting (remaining in place for seven days) is recommended. Curing should be started no more than 20 minutes and compaction and/or jointing. The plastic sheeting should be secured with lumber or stakes as using soil, sand, or dirt can clog pores.

B3.9.5 Maintenance

For quality assurance and acceptance tests, core samples taken (3 for every 100 yd³) per ASTM C42 measured for thickness and unit weight were recommended. Typical requirements are that average unit weights be within 5% of design values and that no thickness be under the design thickness by more than 0.5 inches.

The major maintenance item listed is prevention of pore clogging. This may involve maintaining adjacent land to prevent runoff of sediment onto the pervious concrete, vacuuming (at least annually), power blowing, and pressure washing of pavements surface.

B3.10 Lampe et al (2005). Report on Performance and Whole Life Cycle Costs

Lampe, L., Andrews, H., Martin, P., Barrett, M., Woods-Ballard, B., Kellagher, R., Martin, P., Jefferies, C., and M. Hollon (2005). *Performance and whole life costs of best management practices and sustainable urban drainage systems*. Prepared for WERF, AwwaRF, and UKWIR. Report No. 01-CTS-21T.

Structure	Hydraulic	Maintenance	Other
		<input checked="" type="checkbox"/>	<input checked="" type="checkbox"/>

B3.10.1 Focus of the Project

The focus of this project was to determine the performance and whole life-cycle costs of several stormwater management practices. Relevant information on permeable pavements related to cost, and maintenance issues from that report is reviewed herein.

B3.10.2 Cost

Regarding the cost of permeable pavement, Lampe et al. (2005) presents a summary of data from the Low Impact Development Center (2013), which is reproduced in Table B3-2.

Table B3-2. Permeable pavement costs (Lampe et al. 2005).

Paver System	Cost Per Sq. Foot (Installed)
Asphalt	\$0.50 to \$1.00
Porous Concrete	\$2.00 to \$6.50
Grass/gravel pavers	\$1.50 to \$5.75
Interlocking Concrete Paving Blocks	\$5.00 to \$10.00*

*dependent on depth of base and site accessibility, per conversation with Maryland Unilock® representative (2002)

Source: http://www.lid-stormwater.net/permeable_pavers/permpaver_costs.htm

Lampe et al. (2005) reported that capital costs for porous pavement systems increase linearly with size but at a rate equal to 66% of the size. For example, doubling the size of a permeable pavement project would increase the cost by 66%.

B3.10.3 Maintenance

For interlocking concrete pavements, Lampe et al. (2005) reports that only a small portion of the gaps between blocks must remain open for the system to work properly. Blockage or clogging can occur from material falling off vehicles as well as from soil and vegetation wash-off from adjacent areas. Blockage can be prevented and/or reduced by periodically sweeping and vacuuming and by practicing good landscaping habits in the vicinity. Two standard maintenance activities that were reported were: 1) routine vacuuming and sweeping, and 2) lifting and relaying blocks and the top layer of sand.

Routine maintenance of permeable pavements should include inspection, reporting & information management, street sweeping, and trash and minor debris removal. Corrective maintenance actions include structural repair and sediment removal.

Lampe et al. (2005) also reported the average annual cost of maintaining a "typical" permeable pavement system in British pounds to be £145 in preventative maintenance and £1,000 in corrective maintenance. The report gives no additional information on the area of pavement being maintained but does state that larger systems will cost more. This information can at least be valuable to show an expected relative difference between preventative and corrective maintenance costs.

B3.11 Offenberg 2005. Producing Pervious Pavements

Offenberg, M., 2005. Producing pervious pavements. Concrete International.

Structure	Hydraulic	Maintenance	Other
			<input checked="" type="checkbox"/>

B3.11.1 Focus of the Report

Offenberg (2005) presents an overview related to the production of pervious concrete and offers some troubleshooting suggestions.

B3.11.2 Construction

Four key aspects are presented as being critical to producing a successful pervious concrete section. They are 1) a uniform and properly compacted subgrade, 2) using the correct amount of water, 3) subjecting the pavement to appropriate levels of compaction, and 4) proper curing.

It is suggested that compaction of subgrade be performed to 92% to 96% of the modified Proctor maximum density for sandy subgrades. With regards to the amount of water in the mix, visual inspection for the presence of open pore spaces in compacted concrete and a light sheen from free water in the mix can be valuable clues that indicate proper water content. Offenberg (2005) suggests that the concrete supplier take some responsibility for this and that truck drivers also be trained to have an understanding of the basics of pervious concrete.

Other construction techniques discussed are similar to other documents reviewed herein. Additional comments and suggestions include cross-rolling pervious concrete applications in which ride quality is an issue and hand floating the edges of the concrete because rollers often do not provide sufficient compaction at the edges. Others, however, recommend not hand working pervious concrete because it can reduce void content and infiltration capacity (see the Shoreview, Minnesota case study in Volume 1).

Troubleshooting advice in Offenberg (2005) is limited to situations in which placed concrete has too much or too little water in the mix and pavements in which the concrete has not cured properly. In these cases Offenger (2005) states there are no sufficient remedies other than discarding the concrete and replacing it.

B3.12 Kevern et al 2006. Pervious Concrete Construction: Methods and Quality Control

Kevern, J., Wank, K., Suleiman, M.T., Schaefer, V.R., 2006. Pervious concrete construction: Methods and quality control. Submitted to NRMCA Concrete Technology Forum: Focus on Pervious Concrete, May 24-25, 2006, Nashville, TN.

Structure	Hydraulic	Maintenance	Other
<input checked="" type="checkbox"/>			<input checked="" type="checkbox"/>

B3.12.1 Focus of the Report

Kevern et al. (2006) describes methods related to pervious concrete that are used in practice and also discusses a study performed at Iowa State University that determined field level checks for pervious concrete quality control and assurance.

B3.12.2 Construction

Finishing and compaction are listed as the most important steps in producing a durable concrete pavement. Typically the pervious concrete is placed and struck off 0.75 to 1 inch above forms by means of a shim and vibratory screen. After removing the shims, the concrete is compacted using a weighted roller. Roller screeds are also used and discussed in Kevern et al. (2006). Other methods investigated and/or discussed include a hand-held vibrating screed to strike off the concrete and the use of an asphalt paver to place pervious concrete. It is also mentioned that a standard edging tool can minimize raveling.

Joints are discussed and, if desired, have a recommended spacing of 15 feet, although the NRMCA recommends spacing of no more than 20 feet and spacing of up to 45 feet has been reported without shrinkage cracking. Although joints can be either cut or formed, Kevern et al. (2006) lists formed joints (e.g. via a joint roller) as the preferred method.

Curing should involve misting the surface of the pervious concrete and covering with plastic for at least seven days.

B3.12.3 Compaction Study at Iowa State University

A study at Iowa State University resulted in the following conclusions:

1. Although many methods exist to place and finish pervious concrete, the impact of construction methods on long-term durability is not well understood,
2. Compaction energy can be used to balance strength and infiltration capacity, and
3. Compaction energy plays a crucial role with respect to freeze-thaw durability.

B3.12.4 Identified Data Gaps and Research Suggestions

Kevern et al. (2006) point out that additional research is needed to further understand the effect different construction methods and compaction energy have on the freeze-thaw durability of various pervious concrete mix designs.

B3.13 Pennsylvania Department of Environmental Protection (2006). Stormwater BMP Manual

Pennsylvania Department of Environmental Protection (PDEP) Bureau of Watershed Management. 2006. *Pennsylvania Stormwater Best Management Practices Manual*. PDEP, Harrisburg, PA, USA.

Structure	Hydraulic	Maintenance	Other
<input checked="" type="checkbox"/>		<input checked="" type="checkbox"/>	

B3.13.1 Focus of the Project

PDEP (2006) developed a stormwater best management practice manual that includes a chapter on permeable pavements. The manual discusses many common issues related to permeable pavements that are covered in similar documents in other states and counties.

B3.13.2 Structural and Design Aspects

The Pennsylvania stormwater BMP manual makes many recommendations and many of those recommendations are typically found in other, similar documents. Included recommendations that are not as common are:

- Permeable pavements should not be placed on compacted or recent fill. Areas of fill older than 5 years may be considered for permeable pavement,
- The stone subbase should be placed in lifts and rolled,
- All systems should include an overflow system,
- Perforated pipes along the bottom of a bed can be used to distribute runoff more evenly,
- All permeable pavement systems should have an alternate or backup path for water to enter to aggregate reservoir in case the pavement becomes clogged,
- If underlying soils are poorly draining, the system can be designed to discharge effluent to adjacent stormwater management practices such as wetlands or bioretention cells or swales,
- Locating permeable pavement in a potential hot spot such as a truck parking lot or gas station should be carefully considered,
- Subgrades should not be compacted,
- Permeable pavements should be installed at the end of the construction sequence,
- Geotextile and aggregate should be placed immediately after subgrade is approved,
- Geotextile fabric should overlap at least 16 inches and should extend at least 4 ft outside the edge of the bed,
- Aggregate should be placed in slightly compacted, 8 inch lifts,
- Non-woven geotextiles should be polypropylene and have grab tensile strength of greater than or equal to 120 lbs, Mullen burst strength of greater than or equal to 225 psi, flow rate of greater than or equal to 95 gal/min-ft², and a UV resistance after 500 hours of greater than or equal to 70%,
- Stone for the reservoir bed shall be 1 to 2 inch uniformly graded aggregate with a wash loss of no more than 0.5%,
- For porous asphalt the bituminous surface should be 2.5 inches thick with a bituminous mix of 5.75% to 6% by weight of dry aggregate.

Other details and recommendations related to gradations, weather limitations for placement, voids, admixtures, and many other issues are given in PDEP (2006).

B3.13.3 Maintenance

PDEP (2006) states that the primary goal of maintenance is to prevent the pavement surface and infiltration bed from becoming clogged. Other suggestions and comments include:

- The surface should be vacuumed two or three times a year,
- Pavement washing and compressed air units are not recommended,

- Several measures for preventing sediment from washing onto the permeable surface are presented,
- Dirt on the surface doesn't necessarily clog the surface but dirt that's ground in can lead to clogging. Thus tracking of sediment by vehicles should be prevented and all construction vehicles should be prohibited from traveling on the permeable surface,
- Sand or other abrasives should not be applied on or adjacent to a permeable pavement,
- Permeable pavement areas less than 50 square feet can be patched with standard impermeable pavement with no significant impact.

B3.14 Schaefer et al (2006). Mix Design Development for Pervious Concrete in Cold Weather Climates.

Schaefer, V.R., Wang, K., Suleiman, M.T., Kevern, J.T. 2006. Mix Design Development for Pervious Concrete In Cold Weather Climates, Iowa Department of Transportation, Report number 2006-01, Ames, IA, USA.

Structure	Hydraulic	Maintenance	Other
<input checked="" type="checkbox"/>			

B3.14.1 Focus of the Project

Schaefer et al. (2006) investigates various mix designs in order to develop a pervious concrete mix with sufficient infiltration capacity, strength, and freeze-thaw durability. Various concrete mixes with different sizes and types of aggregate, binder content, and admixtures were investigated and evaluated. Aggregates of river gravel and crushed limestone were investigated. River gravel sizes were 0.5 inch, 0.375 inch, and no. 4 size (100% passing the 0.375 inch sieve and 100% retained on the no. 4 sieve). Also, 0.375 inch crushed limestone and pea gravel were included in the research.

B3.14.2 Mix Design

Schaefer et al. (2006) measured the porosity, permeability, strength, and freeze-thaw durability of all the mixes that were investigated. Results and conclusions from that work are:

1. Mixes with only a single size aggregate have high permeability but insufficient strength,
2. Addition of a small fraction of sand to the mix increased strength and freeze-thaw resistance but it also lowered permeability,
3. Adding sand and latex to the mix increased strength (compared to mixes with a single sized aggregate) but mixes in which only sand was added had a higher strength,
4. Mixes with a small percentage of sand showed 2% mass loss after 300 freeze-thaw cycles,
5. Low compaction reduced compressive strength, split strength, and unit weight but increased permeability,

6. A binder to aggregate ratio of 0.21 and a water:cement ratio of 0.27 was determined to be the optimum in terms of strength, permeability, and void ratio,
7. In terms of seven day strength, the optimum latex content was determined to be 10%,
8. Mixes with larger aggregate size had higher void ratios,
9. Aggregate with higher abrasion resistance resulted in high strength concrete,
10. The compressive strength and unit weight decreased linearly as the void ratio increased,
11. Permeability increased exponentially as the void ratio increased, with a rapid increase in permeability at void ratios greater than 25%,
12. At regular compaction energy, mixes with void ratios between 15% and 19% had seven day compressive strengths ranging from 3,300 to 2,900 psi, permeabilities ranging from 135 to 240 in/hr, and unit weights from 127 to 132 pcf. The split strength was about 12% of the compressive strength,
13. A mass loss of about 15% indicated a terminal serviceability for a pavement,

B3.14.3 Identified Data Gaps and Research Suggestions

Schaefer et al. (2006) suggest the following as future research areas and needs:

1. Because only a limited number of aggregates consisting of crushed limestone and river gravel were investigated, more research should be performed to determine the effect of other aggregates on the properties of pervious concrete,
2. More research should be performed to better understand how compaction energy affects pervious concrete properties (e.g. strength, void ratio, permeability, freeze-thaw durability) so that standardized construction methods can be developed,
3. Other methods to increase the strength of pervious concrete should be investigated. The current study only investigated the use of silica fume, latex, and sand.

B3.15 Chopra et al. (2007). Construction and Maintenance Assessment of Pervious Concrete Pavements

Chopra, M., Wanielista, M., Ballock, C., Spence, J. 2007. Construction and Maintenance Assessment of Pervious Concrete Pavements. Stormwater Management Academy, University of Central Florida, Orlando, FL, USA.

Structure	Hydraulic	Maintenance	Other
	<input checked="" type="checkbox"/>	<input checked="" type="checkbox"/>	

B3.15.1 Focus of the Project

Chopra et al. (2007) focuses on construction and maintenance activities related to pervious concrete sites in Florida, Georgia, and South Carolina with construction specifications suggested for these and similar regions. Objectives included evaluating the clogging potential of pervious concrete systems and the impact of maintenance activities on infiltration rates.

Pervious concrete cores were taken from field sites ranging from 6 to 20 years old. The cores were evaluated for infiltration rates before and after pressure washing, vacuum sweeping, and a combination of these two processes.

B3.15.2 Maintenance

Chopra et al. (2007) determined the following with respect to the maintenance activities that were investigated:

1. Pressure washing dislodged particles that cause clogging. These particles can wash off the pavement into receiving water bodies or can be pushed further down into the pavement by the pressure washing itself. Using too much pressure can also damage the concrete surface,
2. Pressure washing should be tested on a small area of pervious concrete to ensure that it can be used without damaging the concrete,
3. Vacuum sweeping dislodged particles that caused clogging and removed them from the pavement surface and voids,
4. A combination of pressure washing and vacuum sweeping can be used,
5. Current literature predicts recovery of 80% to 90% of the infiltration capacity after maintenance activities have been performed,
6. Some research suggests that brooming the pervious concrete surface immediately restores over 50% of the permeability,
7. Sediment removed by maintenance activities in the current study were typically a fine sand with an average of 43% passing the number 200 sieve.

B3.15.3 Identified Data Gaps and Research Suggestions

Chopra et al. (2007) suggested future research in the following areas:

1. Investigation and monitoring of newly placed pervious concrete over time to more accurately predict the decrease in permeability experienced by pervious concrete pavements,
2. Investigation into other methods of maintenance including high volume flushing.

B3.16 Delatte et al. (2007). Portland Cement Pervious Concrete Pavement: Field Performance Investigation on Parking Lot and Roadway Pavements-Final Report

Delatte, N., Miller, D., Mrkajic, A. 2007. Portland Cement Pervious Concrete Pavement, Field Performance Investigation on Parking Lot and Roadway Pavements - Final Report. RMC Research and Education Foundation, Silver Spring, MD, USA.

Structure	Hydraulic	Maintenance	Other
<input checked="" type="checkbox"/>			

B3.16.1 Focus of the Project

Delatte et al. (2007) documents field observations and non-destructive testing results of pervious concrete applications in Ohio, Kentucky, Indiana, Colorado, and Pennsylvania. Field investigation included visual inspection, two types of surface infiltration measurements, and ultrasonic pulse velocity (UPV) testing at some locations.

B3.16.2 Conclusions

The following conclusions were made based on observations, information gathered, and testing:

1. The installations have not shown any signs of freeze-thaw damage,
2. Some sites had surface raveling, which typically stopped after the first few months of use,
3. Some sites experienced surface cracking and clogging. Cracking was attributed to overloading or long spacing between joints,
4. Saw cut joints experienced less raveling than tooled joints,
5. Some pavements that were not installed properly had very low infiltration capacity,
6. Most of the installations are performing well (but most of them are new),
7. Most of the sites have not yet been subject to maintenance activities,
8. As indicated by specimen cores taken from the sites, the use of gravel as a course aggregate (as opposed to crushed limestone) may lead to more effective and uniform compaction,
9. Typically, the top of a pervious concrete pavement is much better compacted than the bottom,
10. Gravels provide higher strength as compared to crushed limestone,
11. The most important factor in maintaining long-term infiltration capacity of a pervious pavement is the initial construction practices implemented,
12. Runoff from adjacent land areas, if carrying sediment, can also lead to clogging of pervious concrete,
13. Sweeping or vacuuming can be used to restore the infiltration capacity of a pervious concrete pavement,
14. Visual inspection can identify areas most likely to be clogged and other non-structural problems,
15. Laboratory UPV results correlated well with hydraulic conductivity and concrete strength but field testing using this method was not as reliable.

B3.16.3 Identified Data Gaps and Research Suggestions

Delatte et al. (2007) suggest the following topics for further investigation:

1. The sites in this study (and additional sites) should be monitored in the future and the initial information reported in Delatte et al. (2007) be used as a bench mark,
2. New test methods should be developed to measure strength, thickness, and void ratio of in place pervious concrete so that cores do not have to be taken,

- UPV could be used to test for freeze-thaw damage in the field but further work must be performed to develop this technology.

B3.17 Wanielista et al (2007). Hydraulic Performance Assessment of Pervious Concrete Pavements for Stormwater Management Credit.

Wanielista, M., Chopra, M., Spence, J., Ballock, C. 2007. Hydraulic Performance Assessment of Pervious Concrete Pavements for Stormwater Management Credit. Stormwater Management Academy, University of Central Florida, Orlando, FL, USA.

Structure	Hydraulic	Maintenance	Other
	<input checked="" type="checkbox"/>		

B3.17.1 Focus of the Project

Wanielista et al. (2007) reports on pervious concrete parking lots tested for infiltration capacity via an embedded single ring infiltrometer. Thirty pavement cores were also extracted and examined and the underlying soil was assessed to determine its composition. Also, a mass balance model was developed to predict runoff and recharge volumes.

B3.17.2 Water Quality and Hydrology

The following conclusions were made:

- Pervious concrete, if installed properly, can maintain its ability to infiltrate even after years of use and no maintenance,
- After years of use the limiting infiltration factor changed from the sub soil to the pervious concrete itself.

The following recommendations were also made:

- To assess pervious concrete, a single ring infiltrometer should be placed in the concrete during construction and it should extend about 8 inches into the subsoil. This will allow measurements to be made in the future and minimize wall and leakage affects,
- Pervious concrete sections should include a sandy subbase with a clearance of at least two feet to the seasonal high water table.
- If the infiltration rate into pervious concrete as measured by the embedded infiltrometer (see recommendation #1) is less than 1.5 in/hr, the pervious concrete should be cleaned,
- Stormwater management credit should be given for stormwater infiltration into pervious concrete.

B3.17.3 Identified Data Gaps and Research Suggestions

Wanielista et al. (2007) suggest further investigation into the following topics.

- A testing method to determine infiltration rates into pervious concrete systems with underlying gravel reservoirs should be developed. Again, embedding an infiltrometer ring

into the concrete and down into the soil, will allow field infiltration rates to be measured and used in modeling the entire system,

5. A mass balance model should be developed with the following abilities:
 - a. The ability to simulate unsaturated flow within the underlying soil all the way down to the water table
 - b. The ability to incorporate raised curbs and the corresponding additional storage that raised curbs create.
 - c. The ability to model evaporation from the pavement surface.

B3.18 Wanielista and Chopra (2007a). Florida Department of Transportation Report on the Compressive Strength of Pervious Concrete

Wanielista, M., Chopra, M. 2007a. Performance Assessment of a Pervious Concrete Pavement, Report 3 of 4: Compressive strength of pervious concrete pavements. Stormwater Management Academy, University of Central Florida, Orlando, FL, USA.

Structure	Hydraulic	Maintenance	Other
<input checked="" type="checkbox"/>	<input checked="" type="checkbox"/>	<input checked="" type="checkbox"/>	

B3.18.1 Focus of the Project

This study was performed for the Florida Department of Transportation. The focus of this project was to investigate the structural and hydrological aspects of pervious concrete. Findings associated with structural and hydrologic aspects of this project are summarized below.

B3.18.2 Structural and Design Aspects

Laboratory tests were performed to investigate the effect of varying components of pervious concrete on its strength and, by using the test results and studying existing pervious concrete pavements, determined the traffic loads and volumes that pervious concrete can withstand. Wanielista and Chopra (2007a) used aggregate with a specific gravity of 2.36 and a unit weight of 147.5 lb/ft³. Concrete cylinders with different properties and different permeability were constructed. Water cement ratios were varied from 0.32 to 0.52 by weight, aggregate cement ratios varied from 4 to 7 by volume. Resulting permeability values ranged from zero to 2688 in/hr and specific gravity values ranged from 1.95 to 2.36. Compressive strength results are shown in Figures 3-1. Wanielista and Chopra (2007a) also determined other relationships such as unit weight as a function of strength and porosity and permeability as a function of A/C ratio, among others. Also, existing pervious concrete systems were investigated to gather information regarding long term performance and vitality.

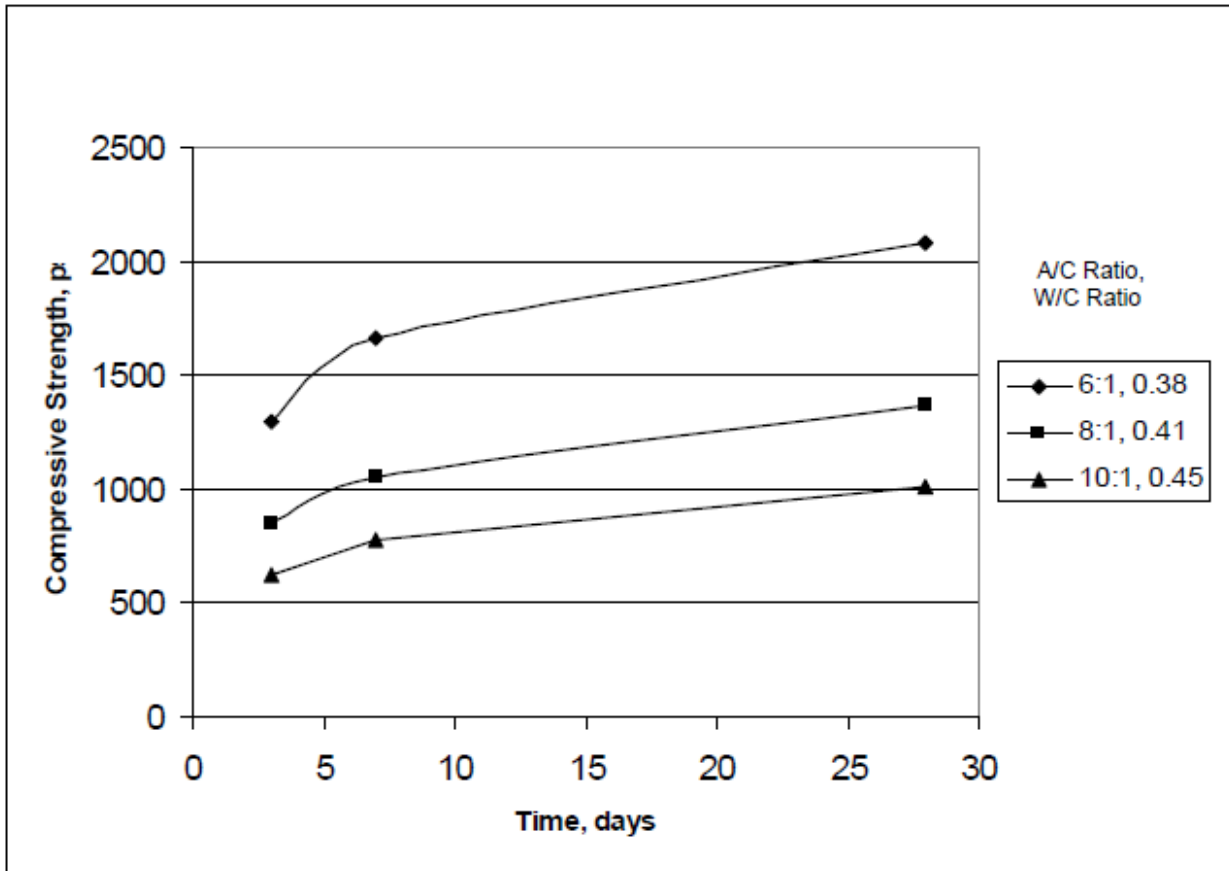

Figure B3-1. Compressive strength of pervious concrete as a function of time for different A/C and W/C ratios (Wanielista and Chopra 2007a).

Wanielista and Chopra (2007a) reached the following conclusions:

1. Pervious concrete should only be used in low traffic volume and low traffic load applications,
2. An A/C ratio less than 5 in combination with a W/C ratio from 0.35 to 0.39 resulted in the highest compressive strength without jeopardizing permeability,
3. Higher A/C ratios do not have enough cement,
4. Higher W/C ratios eliminate void spaces,
5. The energy applied to the pervious concrete was 1,544 kN-m/m³ (modified Proctor). Higher compaction energy did not reduce permeability but did increase compressive strength,
6. The compressive strengths obtained in their study would support traffic loads up to 40 tons,
7. Pavement design thickness depends on the quality of the subgrade, the compressive strength of the pavement, and traffic loadings,
8. Pervious concrete is acceptable in low volume/low impact applications.

B3.18.3 Water Quality and Hydrology

Wanielista and Chopra (2007b) monitored a pervious concrete shoulder that was constructed as part of (and adjacent to) a rest stop along an interstate highway in central Florida. The objectives were to determine how the pervious concrete would perform with respect to infiltration and water quality and also how the performance varied over a one year period. To do this water samples were collected and analyzed for nitrates and orthophosphate. Also, the shoulder area was monitored for truck traffic. Trucks were observed on the shoulder area 38 out of 80 observations and a traffic counter recorded about 500 axles per week.

To measure infiltration rates more accurately, a 12 inch diameter core bit was used to drill out a circular section of pavement, the section was left in place but an impermeable tube was inserted around the core to isolate the section and to encourage 1-dimensional downward flow during the test. The test was essentially a single-ring infiltrometer test. Also, a double-ring method was developed in which silicone caulking was placed around the bottom of the inner and outer rings. This allowed infiltration rates to be measured without having to drill through the pavement.

The following specifications were followed during construction:

1. The delivered mix must be within 5 pcf of that specified,
2. Concrete must be stricken off at the form boards and compacted to a level finish grade.
3. A Schedule 40 ten inch steel pipe roller (or a comparable device) must be used to take the stricken concrete to finish grade,
4. The pervious concrete must be covered with an impermeable liner for a period of 7 days,
5. Curbing should be used to direct water downward.

An acceptable infiltration rate for yearly volume control was stated to be 1.5 in/hr as this would infiltrate at least 80% of the rainfall at the site assuming no additional runoff from adjacent areas. After one year, the lowest average infiltration rate measured was 2.5 in/hr (at a head of zero to 1 inch). Due to runoff flowing on to the pervious concrete from adjacent areas, effluent from the pervious concrete was observed. Runoff was collected by two slotted pipes placed at the bottom of the reservoir. One pipe was placed at the edge of the pervious pavement/impermeable pavement interface and the other was placed 7 ft from this edge (under the pervious concrete pavement). The volume of water collected at the edge was over 50 times greater than that collected 7 ft from the edge, indicating that the pervious concrete pavement was infiltrating stormwater effectively. Also, over the one year study, there was no visible water at the edge location. Wanielista and Chopra (2007b) estimated that the pervious concrete infiltrated almost all of the water it received over the one year study period.

Water collected by the previously mentioned slotted pipes was analyzed for nitrate and orthophosphate. On average, nitrate and orthophosphate concentrations were lower 7 ft from the edge of the pavement as compared to the edge itself. For ten runoff events, runoff was also

collected from the impermeable pavement and analyzed for nitrate and orthophosphate. Again, the results showed that the pervious concrete pavement improved water quality.

Wanielista and Chopra (2007b) concluded that:

1. There was no observable wear on the pervious concrete shoulder area despite the fact that trucks stopped and started on the pavement,
2. Embedded infiltrometers give more accurate measurements than those placed on the surface,
3. After one year measured infiltration rates were higher than 1.5 in/hr,
4. Water quality (in terms of nitrates and orthophosphate) of the water leaving the reservoir was about the same as the rainwater,
5. Water quality at the bottom of the storage reservoir was better than the runoff,
6. Pervious concrete shoulders should be considered for stormwater management along highways,
7. During construction an embedded infiltrometer ring that extends 8 in. into the subgrade should be placed in concrete to facilitate future infiltration testing.

B3.18.4 Identified Data Gaps and Research Suggestions

Recommendations for future research include:

1. Other larger and harder aggregate should be tested,
2. Lower A/C ratios should be tested, perhaps even as low as 2:1,
3. A wider range of compaction energy should be tested to determine the effect on pervious concrete,
4. Existing sites should be thoroughly investigated and should include accurate traffic studies that include exact traffic volumes and loadings to determine how such variables impact the long term performance of pervious pavement.

B3.19 Worel et al (2007). MnRoad Pervious Concrete Sidewalk Project

Worel, B., Frentress, D. P., and Clendenen, J. 2007. 2006 MnROAD – Pervious Concrete Project Pervious Concrete Sidewalk Project. Minnesota Department of Transportation, Maplewood, MN, USA.

Structure	Hydraulic	Maintenance	Other
<input checked="" type="checkbox"/>			<input checked="" type="checkbox"/>

B3.19.1 Focus of the Project

The Minnesota Department of Transportation (MnDOT) and the Aggregate Ready Mix Association of Minnesota (ARM) constructed a pervious concrete sidewalk at the MnRoad facility about 40 miles northwest of Minneapolis in the state of Minnesota. The sidewalk consisted of three different types of pervious concretes:

- Mix #1: A colored (gray) pervious concrete mix with 3/8" minus granite aggregate
Mix #2: A pervious concrete mix with 3/8" minus gravel aggregate and 5% sand (mix #2)
Mix #3: A pervious concrete mix with Kraemer limestone aggregate, polypropylene fibers and 5% sand.

Mix #3 has been used successfully in Iowa with mix design specifications supplied by Iowa State University.

The objectives of this project included:

1. Demonstrate use of different aggregates available in Minnesota in pervious concrete mixes,
2. Demonstrate use of the Iowa mix (#3), which uses sand and fibers as part of the aggregate fraction,
3. Determine if wet hard, wet freeze prevents water from draining through the pervious concrete,
4. Determine if freeze thaw cycles result in pavement deterioration or frost heaving,
5. Determine if winter sanding operations are needed and, if needed, if sanding prevents pervious concrete from draining,
6. Determine if a pervious concrete section can handle normal sidewalk traffic and maintenance,
7. The evaluation of several potential quality control measures for pervious concrete including,
8. density, permeability, and compressive and flexural strength.

B3.19.2 Structural and Design Aspects

Existing soils under the pervious concrete sidewalks were A-6 clay soil. All sidewalks were designed with 4 inches of pervious concrete on top of 6 inches of washed concrete stone. The hydraulic storage capacity of the base layer was not designed or addressed. Instead, it was decided to provide an open-air outlet for water down the existing fore slope. A filter fabric was placed underneath the washed concrete stone and on top of the existing clay subgrade. Relevant information related to the mixes and materials used is given in Table B3.3. Mix design proportions are given in Table B3.4.

After the existing sidewalk was removed the existing clay soil was also removed to allow 6 inches of drainable aggregate base to be placed and compacted. The clay sub grade was sloped away from the existing curb and gutter to allow water to pass through the pervious concrete sidewalk and to drain into an outlet pipe placed at the end of the 8-foot wide sidewalk section.

The outlet pipe was a 4 inch plastic pipe with a wire screen mesh placed over the intake. The outflow drained down the existing fore slope

Concrete placement was done with a roller screed as the placement tool with no riser strips. Immediately following the roller screed a joint cutter was used to match joints with the existing joints in the curb and gutter. A plastic sheet was installed within 20 minutes of the pervious concrete placement and, due to light rain that was falling, the cross rolling was done on top of the plastic sheeting. The concrete was cured with plastic sheets for 7 continuous days.

Table B3-3. Dimensions and materials of pervious concrete sidewalks (Worel et al. 2007).

Mix #1 – Granite Aggregate (colored)

Installation Location	Length (feet)	Width (feet)	Depth (inch)	Cubic Yards (5% overrun)	Square Feet
MnROAD Sidewalk	56	5	4	3.59	280
Field Access Road	8	3.5	5.5	0.41	28
Totals				4.00	280

Mix # 2 - 3/8" Minus River Gravel Aggregate

Installation Location	Length (feet)	Width (feet)	Depth (inch)	Cubic Yards (5% overrun)	Square Feet
MnROAD Sidewalk	9.5	9.8	4	1.20	261
	21	8	4	2.15	
Field Access Road	7	3.5	5.5	0.65	25
Totals				4.00	286

Mix # 3 - Iowa Mix Design using Limestone with 5% Sand

Installation Location	Length (feet)	Width (feet)	Depth (inch)	Cubic Yards (5% overrun)	Square Feet
MnROAD Sidewalk	26	8	4	2.67	208
Field Access Road	0	0	0	0	0
Totals				2.67	208

Base Materials - Washed Concrete Stone 3/4" Minus - CA 50

Installation Location	Length (feet)	Width (feet)	Depth (inch)	Cubic Yards	Tons
MnROAD Sidewalk	48	5	0.5	4.89	7.26
	10	11	0.5	2.24	3.33
	8	5	0.5	0.81	1.21
	15	8	0.5	2.44	3.63
	32	8	0.5	5.21	7.74
Totals				15.60	23.17

Table B3-4. Mix design proportions (Worel et al. 2007).

Mix #1 – Granite Aggregate (colored)

Rogers Plant

Materials	Company	Date	CY	Job Arrival	Finish Pour	W/C
3/8" Minus Granite Aggregate	Aggregate Industries	9/13/07	4	10:45 am	11:30 am	0.27
Prism Color Gray						

Ingredient	Source	Oven Dry Per CY	SSD Per CY	CY Target	Target	Actual (lbs)	Water (lbs)
3/8" Minus Granite Aggregate	Pit #173006 M. St. C.	2505	2515	2555	10220	10300	
Lafarge Type I Cement	LAFDAIA	455		455	1820	1830	
Coal Creek Ash	COCUNND	195		195	780	760	
Water		202	202	162	564	548	708
AIR Mix 250 (Oz/CY)	EUAM250	4	5		14	15	
COLP2	Prism Color Gray (2%)						

Mix # 2 - 3/8" Minus River Gravel Aggregate

Elk River Plant

General Resource Technology

Materials	Company	Date	CY	Job Arrival	Finish Pour	W/C
1/2" Minus River Gravel with 5% Sand	AME Red-E-Mix Inc.	9/18/07	4	10:20 am	11:30 am	0.27

Ingredient	Source	Oven Dry Per CY	SSD Per CY	CY Target	Target	Actual (lbs)	Water (lbs)
Plaisted 1/2" Gravel	Pit #17049	2988	3030	3060	12240	12269	
Barton Sand	Pit # 71002	169	170	177	468	466	
Holcim Cement Lima Peru	LIMLPE	570		570	2280	2278	
Water		154		117	468	468	614
GRT Admixture Polychem VR	GRTPOLYVR			8	32	32	
GRT Admixture PolyChem KB1000	GRTKB1000	17.1 Oz./CY		17	68	69	

**Mix # 3 - Iowa Mix Design using Limestone with 5% Sand
Rogers Plant**

Materials	Company	Date	CY	Job Arrival	Finish Pour	W/C
3/8" minus Kraemer Limestone	Aggregate Industries	9/18/0 7	3.5	11:30a m	12:10 am	0.22

Ingredient	Source	Oven Dry Per CY	SSD Per CY	CY Target	Target	Actual (lbs)	Water (lbs)
3/8 Kraemer Limestone	Pit #119106	2380	2413	2440	8540	8520	
Lafarge Type I Cement	LAFDAIA	510		510	1785	1825	
Sand	Pit #171041 A.I.E.R.	120	121	124	430	420	
Coal Creek Ash	COCUNND	90		90	315	350	
Water		174		145	389	384	487
Fillbrillated Fibers (lbs/CY)	Fibermesh 300			1.5	5.25	5.25	
AIR Mix 250 (Oz/CY)	EUAM250	4	4		14	15	

B3.19.3 Identified Data Gaps and Research Suggestions

Worel et al. (2007) made the following observations and conclusions:

1. Existing sidewalk forms can be used to place a four inch thick pervious concrete on a six inch drainable base,
2. Color can be added to a pervious concrete mix with no change in placement techniques,
3. Two different roller screeds (one provided by Bunyan Screed Systems and one by Lura Enterprises) were successful in placing pervious concrete,
4. The in-situ density of the pervious concrete was very close to the designed density leading,
5. to the yield being very close to correct with this pervious concrete placement.
6. Fibers were successfully placed in a pervious concrete mix,
7. A second Minnesota limestone was successfully placed in a pervious concrete mixture,
8. Changing the density of the pervious concrete had significant impacts on the performance properties of the pervious concrete,
9. Concrete placement using the single chute of a ready mix truck worked well. All placement,
10. finishing, and curing operations were completed within a 20-30 minute window,
11. Debris runoff from adjacent areas may clog pervious concrete,
12. A landscape fabric can be an effective separation layer between soils and the drainable base layer,

13. Watering of the subgrade and base before pervious concrete placement should be required and it should be done as much as possible to ensure the availability of water for hydration,
14. In order to prevent clogging, nearby debris and sedimentation should not drain directly onto the pervious concrete.

B3.20 Colorado Ready Mixed Concrete Association (2009). Specifier’s guide for pervious concrete pavement design

CRMCA (Colorado Ready Mixed Concrete Association). 2009. Specifier’s guide for pervious concrete pavement design. CRMCA, Centennial, CO, USA.

Structure	Hydraulic	Maintenance	Other
<input checked="" type="checkbox"/>			<input checked="" type="checkbox"/>

B3.20.1 Focus of the Project

CRMCA (2009) was written to assist designers in specifying pervious concrete pavements. It is not all inclusive and does not address design with respect to infiltration of stormwater. In particular, it was written to address freeze-thaw cycles, seasonal temperature changes, and Colorado's extremely dry weather.

B3.20.2 Structural and Design Aspects

Rolling compaction that spans the width of the placed section and exerts a minimum pressure of 10 psi is recommended. Joints, if desired, shall be constructed by rolling or forming. For rolled joints, a "pizza cutter" roller should be used. Joint material must be 0.25 or 0.50 inch flexible foam joint material with a relative density of 1.7 or higher that meets listed ASTM specifications. Although joints can be omitted if random cracking is preferred, CRMCA (2009) specifies that if joints are installed they should be at regular intervals spaced at 20 ft or less.

Pervious concrete should only be placed between April 1 and November 1 and should not be placed if the temperature is expected to be 40°F or lower or 90 °F or higher in the seven days following placement. Pervious concrete should also not be placed on frozen subgrade. During curing, the concrete should be covered with polyethylene sheeting that is at least 6 mil thick. CRMCA (2009) also discusses in detail other possible moisture loss control measures.

Course aggregate shall conform to ASTM C33 and fine aggregate complying with ASTM C33 shall make up 4% to 8% of the total aggregate weight. The combined course and fine aggregates shall have at least 10% passing the #4 sieve. The document notes that research suggests that additional sand will increase resistance to freeze-thaw cycles, durability, and strength while maintaining enough infiltration capacity.

The mixture shall have a density of 105 lb/ft³ to 130 lb/ft³ and shall conform to ASTM C29. The void content should be from 15% to 25%, the water to cement ratio shall be 0.26 to 0.35, and the cementitious content shall be from 450 lb/yd³ to 550 lb/yd³. The document also gives other specifications related to admixtures, fly ash, placing and finishing, curing, etc.

B3.21 3.21 McGowen et al (2009). Report on Water Quality Issues in Highway Management

McGowen, S., Smith, B., Brindle, F., Davis, V.W., Herbert, R., Lauffer, M., Lewis, J., Ripka, T. 2009. Best Practices In Addressing NPDES And Other Water Quality Issues In Highway System Management.

Structure	Hydraulic	Maintenance	Other
		<input checked="" type="checkbox"/>	

B3.21.1 Focus of the Report

This report, which was supported by the National Cooperative Highway Research Program, focuses on many stormwater management practices and contains a small portion on permeable pavements.

B3.21.2 Maintenance

Installation is stated to be a key factor in the long-term performance of permeable pavements. Studies performed by the University of Central Florida have shown "good" results when the surfaces have been maintained by vacuum sweeping. McGowen et al. (2009) also reports that in hot weather the binder in porous asphalt systems can melt, move deeper into the pavement, and solidify. The result is an impermeable layer that prevents infiltration of stormwater runoff. No details, however, were given with respect to the temperature at which this has been observed.

B3.22 University of New Hampshire Stormwater Center (2009). Design specifications for porous asphalt pavement and infiltration beds

UNHSC (University of New Hampshire Stormwater Center). 2009. *UNHSC Design specifications for porous asphalt pavement and infiltration beds*. University of New Hampshire, Durham, NH, USA.

Structure	Hydraulic	Maintenance	Other
<input checked="" type="checkbox"/>			

B3.22.1 Focus of the Project

UNHSC (2009) provides detailed design specifications for porous asphalt pavements in parking lots. A brief summary of relevant material is provided herein.

B3.22.2 Structural and Design Aspects

UNHSC (2009) states that below the porous asphalt layer there should be a 4 to 8 inch choker layer (8 in preferred), an 8 to 12 inch filter course layer of poorly graded sand, a 3 inch minimum thickness filter blanket (i.e. pea gravel), and a reservoir of course, crushed stone. This layering is shown schematically in Figure B3-2. The optional bottom liner is recommended only for aquifer protection or to eliminate infiltration. Recommended aggregate gradations are given in Table B3-5. Additional details related to these and additional topics such as the porous asphalt mix are given in UNHSC (2009) and results are further discussed in the case study corresponding to the University of New Hampshire Stormwater Center in Volume 1 of this document.

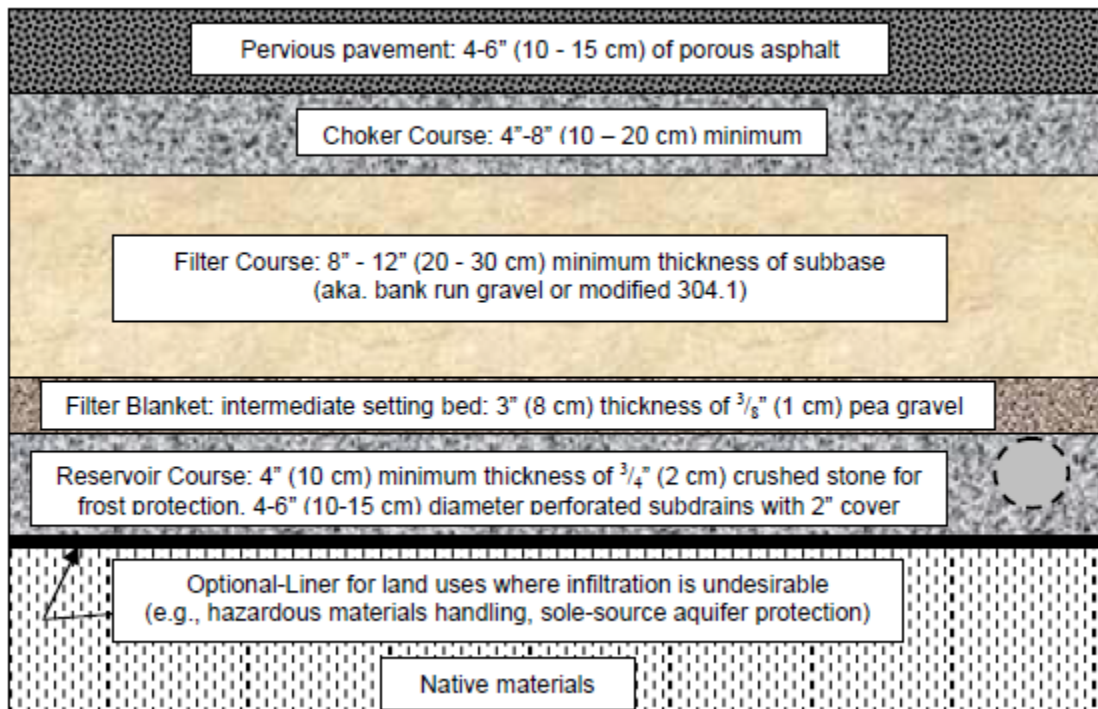

Figure B3-2. Typical parking lot cross-section as recommended by UNHSC (2009).

Table B3-5. Recommended aggregate gradations (UNHSC 2009).

US Standard Sieve Size Inches/mm	Percent Passing (%)			
	Choker Course (AASHTO No. 57)	Filter Course (Modified NHDOT 304.1)	Reservoir Course (AASHTO No. 3)	Reservoir Course Alternative* (AASHTO No. 5)
6/150	-	100	-	-
2½/63	-	-	100	-
2 /50	-	-	90 – 100	-
1½/37.5	100	-	35 – 70	100
1/25	95 - 100	-	0 – 15	90 – 100
¾/19	-	-	-	20 - 55
½/12.5	25 - 60	-	0 - 5	0 - 10
3/8/9.5	-	-	-	0 - 5
#4/4.75	0 - 10	70-100	-	-
#8/2.36	0 - 5	-	-	-
#200/0.075	-	0 – 6**	-	-
% Compaction ASTM D698 / AASHTO T99	95	95	95	95

* Alternate gradations (e.g. AASHTO No. 5) may be accepted upon Engineer’s approval.

** Preferably less than 4% fines

B3.23 American Concrete Institute (2010). Report on Pervious Concrete

ACI (American Concrete Institute). 2010. *Report on Pervious Concrete*. ACI, Farmington Hills, MI, USA. ACI 522R-10.

Structure	Hydraulic	Maintenance	Other
<input checked="" type="checkbox"/>	<input checked="" type="checkbox"/>	<input checked="" type="checkbox"/>	

B3.23.1 Focus of the Project

The American Concrete Institute has developed a report on the application, design, materials, properties, construction, testing, and inspection of pervious concrete (ACE 2010). This report is summarized herein.

B3.23.2 Structural and Design Aspects

Structural design aspects are broken down into the sections on materials, properties, design, and construction that follow.

B3.23.2.1 Materials

ACI (2010) states that aggregate is typically single sized or course aggregate between 0.375 inch and 0.75 inch and all aggregates should meet ASTM D448 and C33/C33M. Rounded and

crushed aggregate, both normal and lightweight, have been used but flaky or elongated aggregate should not be used. Aggregates should also be hard, clean, and have no coating.

Portland cement conforming to ASTM C150/C150M, C595/C595M, or C1157/C1157M should be used as the main binder with supplementary materials such as fly ash, blast-furnace slag, and silica fume being acceptable.

Water to cement ratios should be low and should typically range from 0.26 to 0.40. If the water content is too high the paste may drain and clog the pore system.

Water-reducing, retarding, accelerators, and air-entraining admixtures can be used but should meet all relevant requirements and ASTM standards.

B3.23.2.2 Properties

ACI (2010) reviews previous studies that have investigated pervious concrete properties. These studies, however, are not all conclusive and cannot be solely used to design mixes. Rather they show general trends. For example, a study by Meininger (1988) showed a drop in compressive strength from over 5000 psi at an air content between 5% and 10% to just over 1000 psi at an air content between 25% and 30%. Results cannot be applied universally, however, because the tests only investigated two aggregate sizes over a range of aggregate gradation and compaction effort but did not investigate the impact of a host of other variables. Other summaries showed an increase in compressive strength with unit weight (Mulligan 2005), a drop in air content with an increase in water:cement ratio (Meininger 1988), a drop in flexural strength with an increase in air content (Meininger 1988), and an increase in flexural strength with an increase in compressive strength (Meininger 1988).

ACI (2010) reports that void content is highly dependent on aggregate gradation, cementitious material content, water:cement ratio, and compactive effort. It is also stated that a range of porosities can be achieved by blending two different size aggregates. If this is done, however, the larger aggregate should be less than ~2.5 times the size of the smaller aggregate or else the smaller aggregate may fill in the voids and reduce permeability. Although, if the size ratio is large, mechanical properties can be enhanced.

The pore size in pervious concrete is an important parameter as it affects properties such as permeability and sound adsorption. Larger sized aggregate produces larger pores and increased permeability. Pore structure also impacts pervious concrete properties. Low et al. (2008) used a statistical method to determine that aggregate size, aggregate-cement ratio, and water-cement ratio greatly impact pore structure.

Permeability (or infiltration capacity) is directly related to the porosity and the pore size of pervious concrete. It's been reported (Meininger 1988) that a porosity of at 15% is required to achieve a permeability of 1 cm/s.

Tests have shown that entraining air in the cement paste can improve durability.

Toughness, as measured by ASTM C1399, can be improved by adding synthetic fibers. One study found that fibers 1.5 to 2.0 inches in length were most effective in increasing toughness (SI Concrete Systems 2002).

With regards to developing mix proportions, ACI (2010) suggests repeated trial-and-error efforts that involve developing different mix proportions under laboratory settings and testing them in the field until the desired behavior is achieved. Overall, the goal is to obtain a balance between voids, strength, paste content, and workability. ACI (2010) describes methods that can be used in trial batch proportioning.

B3.23.2.3 Design

ACI (2010), like other documents, states a typical subgrade compaction of 90% of the Standard Proctor Maximum Dry Density in order to maintain infiltration capacity. The subgrade soil, however, should be considered because compacting clayey soils to 90% can essentially eliminate infiltration whereas compacting some sandy soils to 100% has no impact on infiltration. Regardless of the extent of compaction specified, it is important to field test the base and subgrade after compaction to ensure that it meets the desired objectives with respect to infiltration and structural integrity. With regards to concrete strength and structural thickness, ACI (2010) makes some general comments but provides no specific design details.

For design with respect to stormwater management, ACI (2010) describes a design process that involves determining the volume of runoff to be treated through such acceptable measures as the rational method or curve number method. Once the volume of runoff has been determined, the design process involves insuring that the void spaces in the existing soil (above the seasonally high groundwater table), pavement, and subbase have the capacity to store the volume of runoff. In areas subject to freeze-thaw cycles, a base of gravel is recommended. If a rock base for stormwater storage is to be used, ACI (2010) suggests using a geotextile fabric should be placed between the rock and the subgrade.

B3.23.2.4 Construction

Pervious concrete mixes should be placed as quickly as possible because they typically have almost no excess water in the mix and can dry out quickly. This can lead to reduced strength and, in the future, raveling of the concrete.

Edge forms, as used with conventional concrete, should be used and concrete should be placed as close to its final location as possible to minimize workmanship. After deposition of concrete it should be cut with a concrete hand rake to a rough elevation and care should be taken to maintain the intended voids. ACI (2010) also discusses other construction techniques such as riser strips, placing equipment, miscellaneous tools, and how to place new pervious concrete next to an existing section that has already been placed.

Construction joints, having a depth of one-quarter to one-third of the thickness of the pavement should be installed as indicated by the design plans. It is also recommended that joints be installed in fresh concrete with special tools. A specially designed compacting roller-jointer with a blade that is at least one-quarter the thickness of the slab and has enough mass to create a clean joint is recommended. The roller should also produce a rounded edge so that square edges, which have a greater tendency to ravel, can be avoided.

The curing cover should be placed no later than 20 minutes after concrete placement and that is for ideal, high humidity conditions. For other environments the cover should be placed sooner. Cover material should be heavy-duty polyethylene that meets ASTM C171 requirements and should cover the entire width of concrete. All measures should be taken to accomplish the construction process quickly to prevent the concrete surface from drying. Concrete should be allowed 7 to 10 days to cure, depending on the use of admixtures. In cold weather, however, curing times may need to be extended.

Like other documents, ACI (2010) recommends placing concrete only when temperatures are expected to be above 40 °F. Curing blankets may also be used in times of cold weather.

B3.23.3 Maintenance

Some studies have shown a lack of durability to freeze-thaw conditions if the porous structure is completely filled with water when subject to freezing. Other tests, however, show this has some but not total governance on durability. For example, if freezing occurs more slowly (i.e. over a day instead of hours), this may give water in the pores a chance to drain before freezing thereby increasing durability. ACI (2010) recommends always using caution when using pervious concrete in applications where a hard freeze may occur before drainage from the voids can occur.

Pressure washing and vacuuming are discussed as means of maintaining infiltration capacity. If pressure washing is used, maintenance crews must be careful to not use a pressure so high that it will damage the concrete. The most effective technique, it is stated, is to follow pressure washing with vacuuming. A typical maintenance schedule is given in Table B3-6.

Table B3-6. Typical maintenance plan for pervious concrete (ACI 2010).

Activity	Schedule
<ul style="list-style-type: none"> • Ensure that paving area is clean of debris • Ensure that the area is clean of sediments 	Monthly
<ul style="list-style-type: none"> • Seed bare upland areas • Vacuum sweep to keep the surface free of sediment 	As needed
<ul style="list-style-type: none"> • Inspect the surface for deterioration or spalling 	Annually

B3.23.4 Identified Data Gaps and Research Suggestions

Areas identified as research needs and or knowledge gaps include:

1. The effect of water with high sulfate concentrations or acidic water on the durability of pervious concrete,
2. Understanding and improvement of the strength of pervious concrete,
3. Understanding of the pore structure is needed in order to determine material based performance design standards,
4. The effect of water on the strength and the underlying soils for other applications,
5. Fatigue performance,
6. Characterization of material structure,
7. Freeze-thaw and cold climate applications,
8. Porous grout and other pore pressure reduction potentials,
9. Environmental remediation potential,
10. Surface deterioration and repair,
11. Development and standardization of testing methods,
12. Development of non-destructive test methods,
13. Urban heat island effect and thermal properties.

B3.24 Jones et al (2010). Caltrans Report on Structural Performance of Fully Permeable Pavements

Jones D., Harvey J., Li H., Wang T., Wu R. and Campbell B. (2010). "Laboratory testing and Modeling for Structural Performance of Fully Permeable Pavements under Heavy Traffic." Report number CTSW-RT-10-249.04 prepared for California Department of Transportation, Sacramento, California.

Structure	Hydraulic	Maintenance	Other
<input checked="" type="checkbox"/>			<input checked="" type="checkbox"/>

B3.24.1 Focus of the Project

This study was performed by the University of California Pavement Research Center (UCPRC) for the Division of Environmental Analysis of the California Department of Transportation (Caltrans). The focus of this study was to measure some of the important permeable pavement parameters under laboratory conditions and use them as input of computer model to simulate the structural performance of permeable pavement; particularly under medium speed and heavy load traffic. Principal tasks involved in this project were:

1. Evaluation of structural characteristics of all materials used in porous asphalt and pervious concrete including base and subgrade materials,
2. Perform performance modeling of various designs,

3. Development of recommended designs for future testing,
4. Complete life-cycle cost analysis of the recommended designs including various options.

B3.24.2 Structural Performance Results

In developing pavement designs, the mechanistic-empirical (ME) approach was used rather than the R-value design method as assumptions in the latter are not appropriate for fully permeable pavements. Subgrade soils and base course aggregate were tested (when appropriate) for such properties as particle size distribution, Atterberg Limits, density-moisture relationships, permeability, and resilient modulus, among others. Also, tests were performed to determine permanent deformation of subgrade soils and dynamic cone penetrometer (DCP) tests were performed on base course materials.

With regards to hot mix asphalt permeable pavement, different mix designs and aggregate gradations were also tested for permeability, moisture sensitivity, rutting resistance, raveling resistance, fatigue cracking resistance, and flexural stiffness. Open-graded Portland Cement Concrete mixes were tested for modulus of rupture.

Results of laboratory testing showed that:

1. Clays and silts that are common in many populated areas of California provide very little support to pavement and any strength that it does have decreases with increasing moisture content. Permeable pavements constructed on such soils must have thicker base and/or surface layers,
2. Saturated hydraulic conductivity was dependent on construction compaction with a more significant impact on clays as compared to silts,
3. Four different commercially available permeable base-course aggregates were tested and found to provide reservoir storage and enough support for traffic loads in parking lots, basic access streets and driveways, and highway shoulders,
4. For hot-mix asphalt, particle size distribution and the binder type are the two most important factors for selecting an appropriate mix,
5. Most hot-mix asphalts tested had sufficient infiltration capacity,
6. Rutting of the surface appeared to be a problem for a mix with conventional binder and one with a rubberized binder. Most of the mixes tested had sufficient resistance to raveling as compared to a dense-graded control,
7. For open-graded Portland Cement Concrete there was a clear relationship between aggregate grading, cement content, water-to-cement ratio, and strength and permeability. All specimens tested exceeded permeability requirements, suggesting that adjustments can be made to optimize mixes while still maintaining adequate permeability,
8. The water-to-cement ratio is very important in ensuring good constructability and long-term performance of the pavement,

9. No durability testing was performed on pervious concrete but the mixes are expected to be suspect to raveling when subject to traffic,
10. The holes in the pervious concrete specimens reduced flexural strength as compared to conventional concrete. Weakening is mostly caused by a reduction in crack resistance cross section and stress concentrations can be ignored,
11. Pervious concrete pavements with void ratios of 3.1% can be designed in the same manner as non-permeable pavements if the modulus of rupture is reduced,
12. To estimate the reduction of modulus of rupture, the reduction in crack-resisting cross-section normal to the direction of maximum principle stress can be calculated and the modulus of rupture reduced by another 10%.

In the modeling portion of the research, results of stress calculations in concrete and strain calculations in asphalt were used to estimate the thickness required to ensure the layer didn't fail due to fatigue. Nonlinear layer elastic theory was used to estimate the stiffness of the granular base. This was then used to estimate the shear stress to strength ratios in the subgrade. These results were used to develop structural design tables that can be used with results from hydraulic performance to determine the required layer thickness. Design input variables were subgrade permeability, truck traffic level (i.e. traffic index), climate/region (Sacramento or Los Angeles), traffic speed (4 mph or 24 mph), design storm (2, 50, 100 year return period) for the climates/regions, and the number of adjacent impermeable lanes.

Two recommended design layouts are shown in Figures 3-3 and 3-4. In addition, the study also recommends that as many permeability tests as possible be performed on the subgrade at the design elevation of the top of subgrade. This will help determine the ability of the subgrade to infiltrate water. Many tests are recommended because the permeability can vary greatly over short distances. In order to maintain permeability it is recommended that construction traffic on the subgrade be kept to a minimum. For joints, the study recommends installation procedures as outlined in the American Concrete Pavement Association (ACPA) guide.

Results from the computer modeling indicate that:

1. Using the mechanistic-empirical design equations can be an effective way of determining the required thickness of fully permeable pavements so they are strong enough to carry heavy truck traffic,
2. All required pavement structures were less than 5 ft in total thickness and most concrete slabs were less than 1.5 ft for the heaviest traffic. Thus, all pavements were considered feasible,
3. Design cross-sections for shoulder retrofits of highways and low speed traffic areas are feasible as determined by construction and maintenance experts after review.

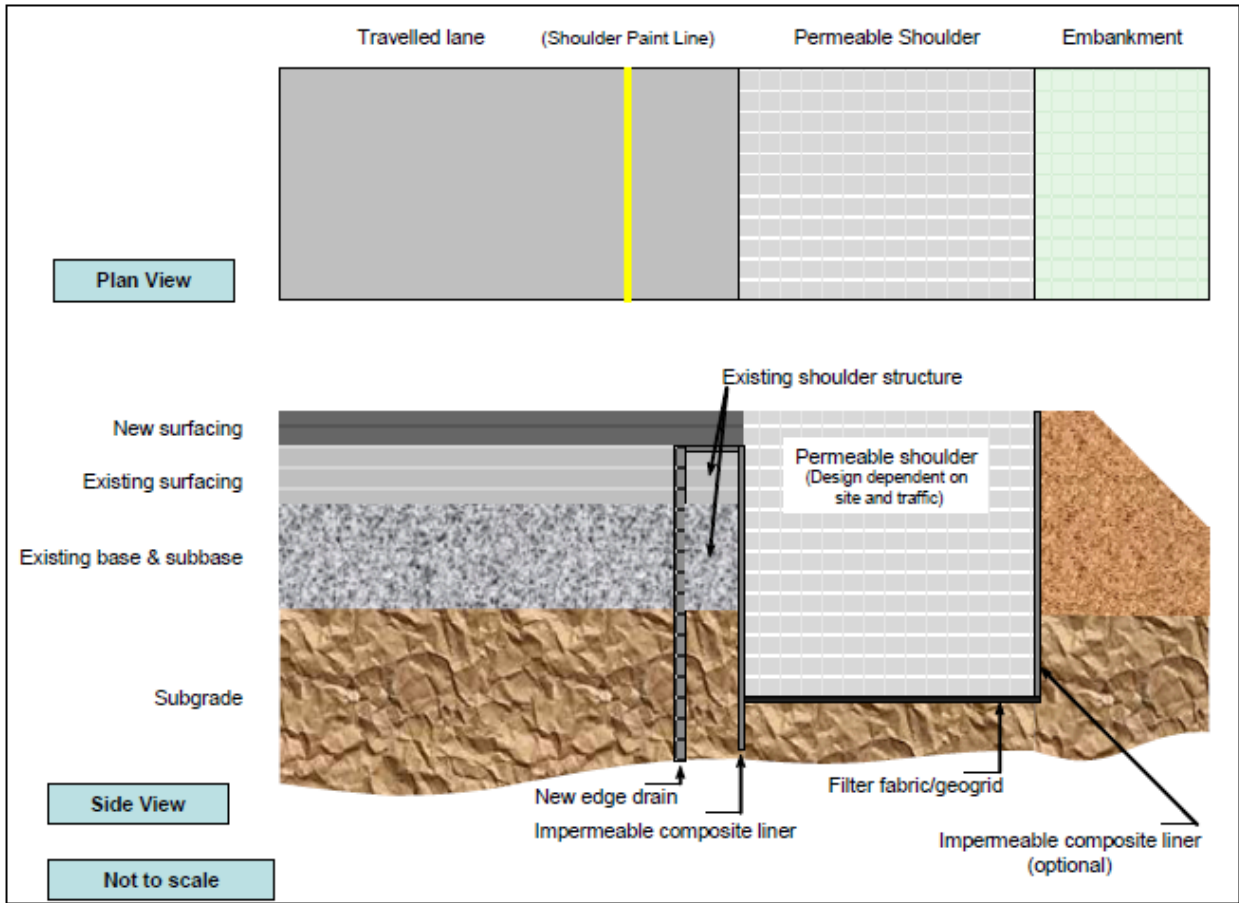

Figure B3-3. Proposed fully permeable pavement shoulder retrofit design configuration 1 (Jones et al. 2010).

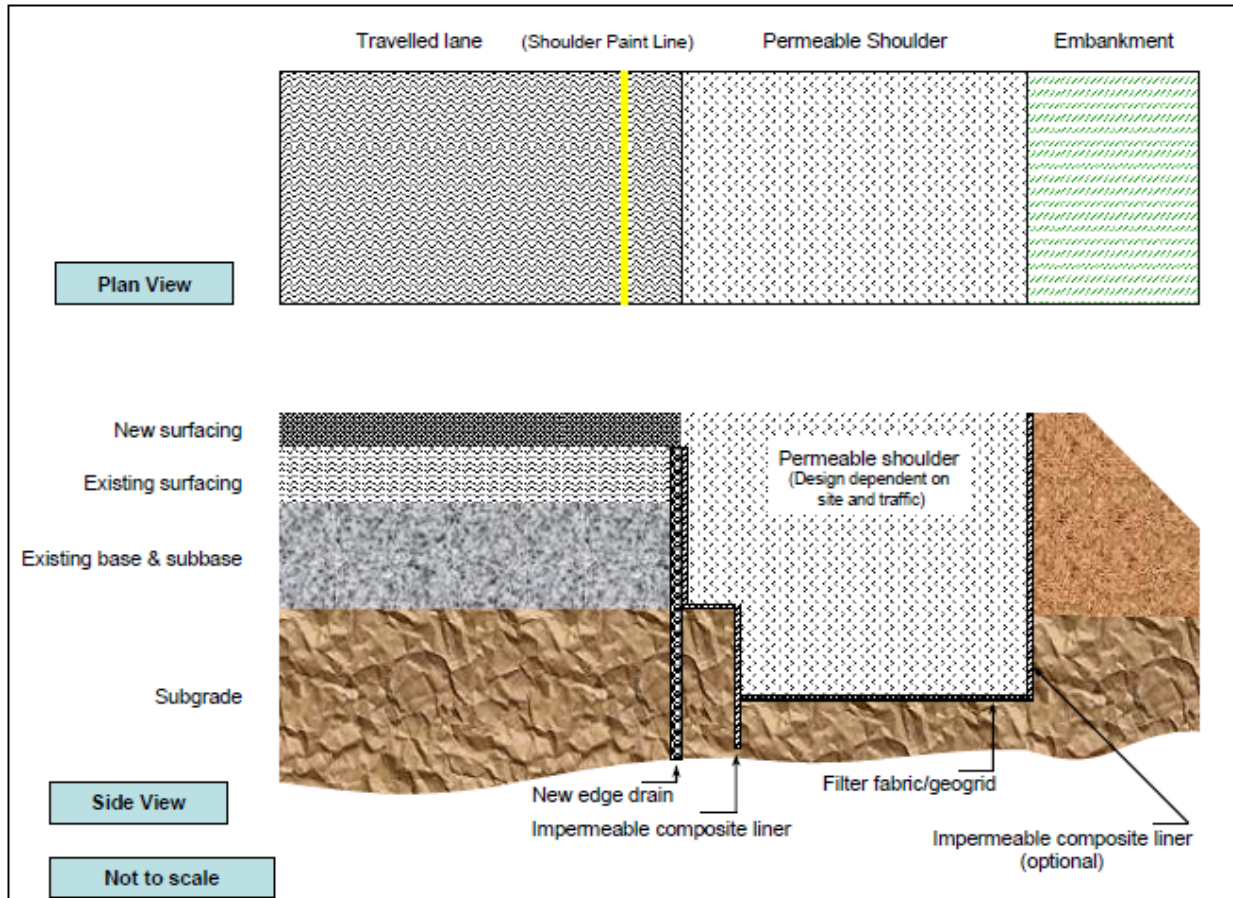

Figure B3-4. Proposed fully permeable pavement shoulder retrofit design configuration 2 (Jones et al. 2010).

B3.24.3 Life Cycle Cost Analysis

A Life-Cycle Cost Analysis (LCCA) was performed to evaluate the net present value (NPV) economic costs of stormwater management alternatives. When performing the life-cycle cost analysis it was assumed that the two fully permeable pavements investigated carried out the same function with regards to stormwater treatment (both runoff volume and water quality) as the other alternatives. The two permeable pavements considered were a shoulder retrofit for a high speed highway and a low speed highway or parking lot/maintenance yard. The life-cycle cost analysis determined the net present value (NPV) of the basic elements of life-cycle cost analysis include analysis period, discount rate, costs, and salvage value. Most of the material and construction cost related to a permeable pavement shoulder retrofit was obtained from a local pavement construction company. All costs were converted to the net present value and compared to other currently available stormwater management practices. The cost of permeable pavement shoulder retrofit was compared with the costs of conventional stormwater BMPs that were obtained from Caltrans pilot BMP retrofit study (Caltrans 2003).

Results showed that fully permeable pavements for both the shoulder retrofit and the maintenance yard/parking lot are more cost-effective than currently available management practices in most scenarios. Fully permeable shoulders draining one lane of conventional asphalt had a net present value of about two-thirds of the next lowest cost alternative and fully permeable shoulders draining three lanes were about half the cost. With regards to the maintenance yard/parking lot scenario, costs were similar to other stormwater management options when comparing the low end of cost estimates but were significantly more cost-effective when comparing the high range of costs. The retrofit cost analysis was performed based on single highway lane and three highway lanes under low and high cost options. The summary result of this comparative analysis is shown in Figure B3-5. As shown, the full depth permeable pavement shoulder can be cost effective compared with conventional BMPs.

Attempts were made to perform a Life-Cycle Assessment (LCA) analysis. Performing the life-cycle assessment analysis required elements of life-cycle inventory (e.g. energy consumption, greenhouse gas emissions, material flows, air and water pollutants, etc.), impact assessment (assessment of inventory results, e.g. climate change), and interpretation. Most of the required environmental evaluation data is not available and hence the true LCA could not be performed. Therefore, this study did not complete a life-cycle assessment but rather proposed a framework for how such an assessment could be carried out.

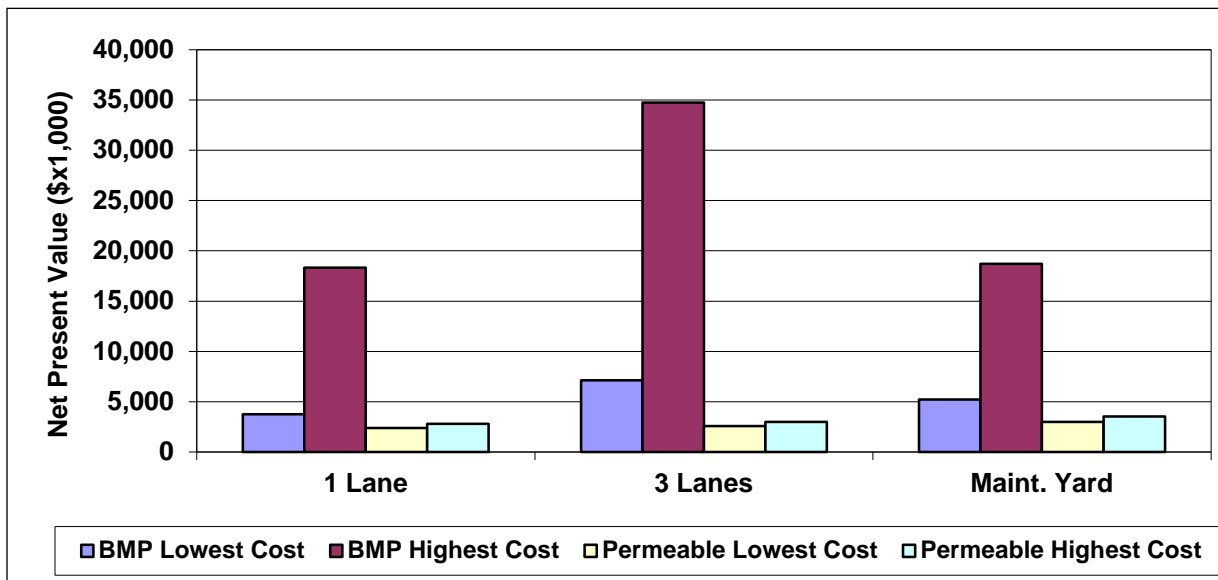

Figure B3-5. Cost comparison for BMP and fully permeable pavement (low and high cost options) (Jones et al. 2010).

B3.24.4 Identified Data Gaps and Research Suggestions

Based on this work, the following recommendations were made:

1. A life-cycle cost analysis should be performed for all potential projects and results should drive the selection of pavement type and materials used,
2. ASTM specifications for granular material as specified by NAPA (2008) and ACPA (2009) should be used only if they are found to be cost-effective,
3. Subgrade should be compacted to 91% (+/- 1%) and should be performed dry of optimum water content. Variability in compaction during construction and post-construction consolidation should be monitored closely,
4. Portland Cement Concrete open-graded mixes should be similar to those in Caltrans (2010a). Variations with smaller aggregate size and greater cement content can be used as long as the permeability remains at or above 1.5 cm/s,
5. Minimum flexural strengths of 325 psi and/or minimum splitting tensile strengths of 290 psi are recommended for use with the structural design. The use of splitting tensile strength for mix design was recommended over flexural or compressive strength testing because of it is convenient and cost-effective,
6. The Georgia DOT open-graded asphalt mix should be considered first for high traffic pavements, followed by RHMA-O for lower traffic pavements. The HMA-O mix likely has a higher risk of raveling, rutting, and cracking,
7. The design cross-sections for shoulder retrofits shown in Figures 3-3 and 3-4 should be starting points in the design process,
8. The use of appropriate geotextiles is recommended as a filter layer between the subgrade and granular base or, if used, the subgrade and Portland Cement Concrete (PPC-O) subbase,
9. For shoulder retrofit projects, there should be an impermeable membrane fabric separating the traffic lanes and the permeable shoulder. A drainage system with outlets should be in place between the traffic lanes and the impermeable membrane,
10. The number of permitted overflows should be defined because it will influence the thickness of the gravel base/reservoir layer.

B3.25 Kayhanian et al. (2010). Caltrans Report on Hydraulic Performance of Fully Permeable Pavements

Kayhanian M., Chai L., Givens B. 2010. Laboratory testing and simulation for hydraulic performance of fully permeable pavements. Report number CTSW-RT-10-247.03 prepared for California Department of Transportation, Sacramento, California.

Structure	Hydraulic	Maintenance	Other
	<input checked="" type="checkbox"/>	<input checked="" type="checkbox"/>	

B3.25.1 Focus of the Project

This study was performed by the Department of Civil and Environmental Engineering at the University of California for the Division of Environmental Analysis of the California

Department of Transportation (Caltrans). The focus of this study was to measure some of the required parameters in the lab and use them as input of computer model to simulate the hydraulic performance of permeable pavement. A majority of the simulations were performed for full depth permeable shoulder of highways. This report presents the methodology and the results of hydraulic performance testing for full permeable pavement using the *HYDRUS 2-D* model. The report also presents some information on clogging and performed clogging simulations. The simulation results for both of these topics are summarized below.

B3.25.2 Hydraulic Performance Results

The performance of permeable pavement was assessed by solving Richards' equation using a commercially available software program called *HYDRUS* that is based on unsaturated flow theory and uses a finite element approach. Rainstorms of 2, 50, and 100 year return periods were modeled and simulations were performed for three different regions in California. The regions selected consisted of a northern California region with high rainfall, a Central Valley region with medium rainfall, and a southern urban region with medium rainfall. The aggregate permeability was assumed to be constant at 10^{-1} cm/s and the subgrade permeability varied from constant values of 10^{-3} cm/s to 10^{-6} cm/s.

Rainfall data, soil data and other parameters were input into *HYDRUS* in order to generate the desired results. *HYDRUS* performed the simulations according to the flow chart shown in Figure B3-6. Assumptions in the simulation were:

1. Rain water infiltrated downward in the vertical direction with no lateral flow,
2. Traffic lanes were impervious and all rainfall is directed towards permeable shoulders,
3. Travel times between the location of runoff generation and infiltration were small compared to infiltration times,
4. Rain intercepted by vehicles, lost as spray or evaporation was ignored,
5. The water table was low and did not impact infiltration,
6. There was no clogging of the surface layer.

and boundary conditions were:

1. The top surface is at atmospheric conditions,
2. There is no flux through the right or left side (i.e. rain water infiltrated vertically downward),
3. At the bottom of the permeable pavements there is no pressure head and thus the system experiences free drainage,
4. The initial water content of the soil was or was close to the residual water content.

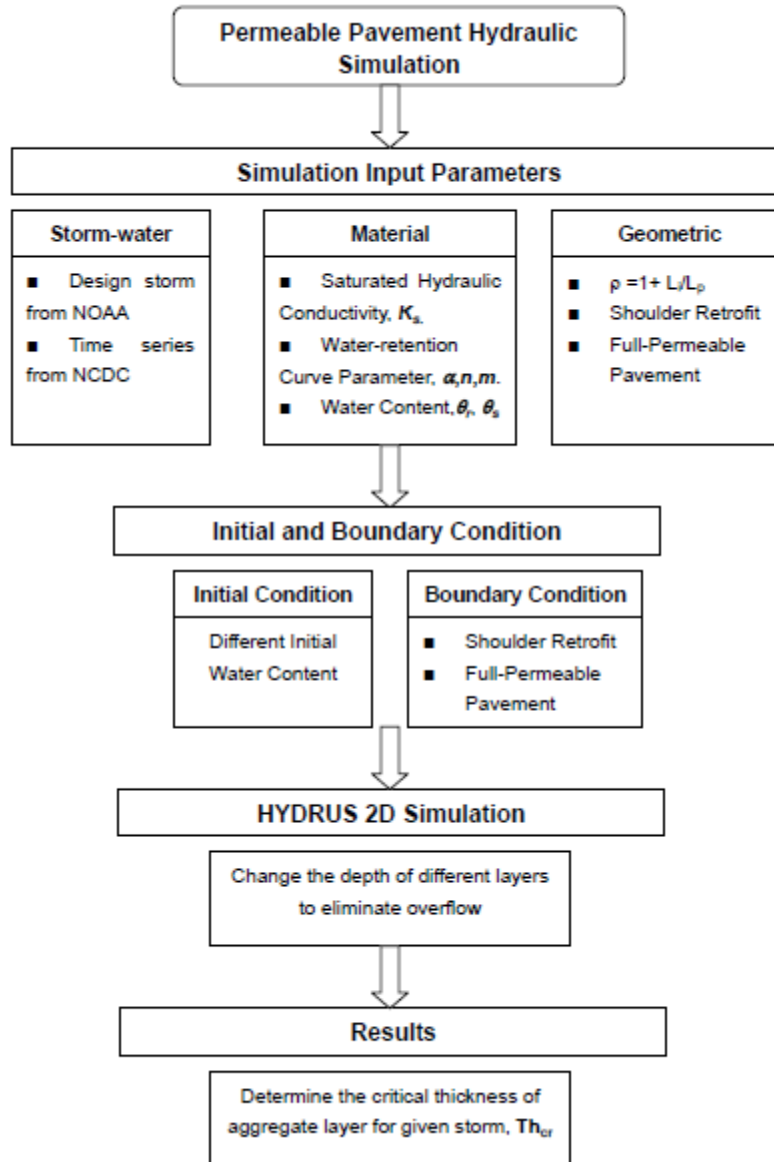

Figure B3-6. Procedure flow chart used in hydraulic performance simulation (Kayhanian et al. 2010).

Simulation results indicated that:

1. An aggregate thickness of <1 m to ~3 m is required to capture the entire rainfall of any design storm in any California region,
2. Required aggregate thickness is influenced by climate, storm recurrence interval, subgrade soil saturated hydraulic conductivity, aggregate void ratio, number of traffic lanes, and boundary conditions,

3. Higher rainfall amounts (and longer recurrence intervals) require larger aggregate thickness depths but the difference in required aggregate thickness for the 50 and 100 year storms was not significant,
4. Natural rainfall data input generated slightly thicker aggregate base depths as compared to synthetic data,
5. Soil saturated hydraulic conductivity was the factor that had the greatest impact results. Such values less than 10^{-5} cm/s cause full depth permeable pavement to be impractical,
6. Highway surface area was another critical variable impacting required aggregate thickness. When traffic lanes were increased from 2 to 4, the required aggregate thickness increased by 100%,
7. Initial water content and surface pavement void space also greatly impact the required aggregate thickness.

B3.25.3 Clogging Simulation Results

To perform this simulation, three different clogging profiles were considered, as illustrated in Figure B3-4, and it was assumed that the reduced permeability of the upper 5 cm (2 in.) of HMA-O and PCC-O pavement was one-hundredth of its original value.

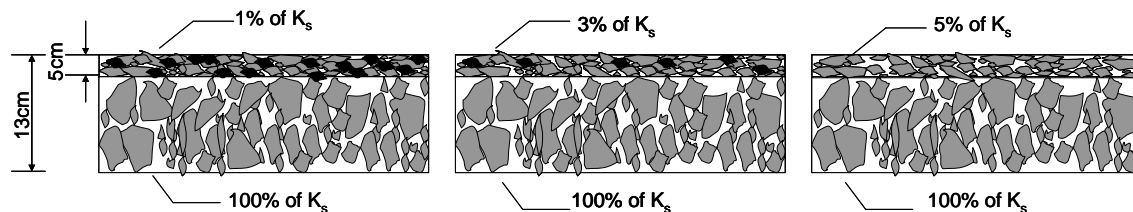

Figure B3-7. Graphic illustration of three clogging surface profiles (Kayhanian et al. 2010).

The percent reduction in saturated hydraulic conductivity of the top 5 cm (2 in.) layer of surface pavement, considered above, was based on the void ratio (porosity) profile of a known PCC-O core sample obtained from a permeable concrete parking lot shown in Figure B3-8. As can be seen, if there was no reduction in porosity in the upper surface of the pavement, the average porosity would have been about 25 percent. With this porosity the saturated hydraulic conductivity of PCC-O would be about 0.1 cm/sec (see Figure B4-12). In theory, a rainfall of about 360 cm/hr (141 in. /hr) would be needed to create surface runoff from either the HMA-O or PCC-O pavements. This amount of rainfall is unusual and will never happen. However, surface runoff can be generated when a significant portion of surface air voids are reduced due to clogging.

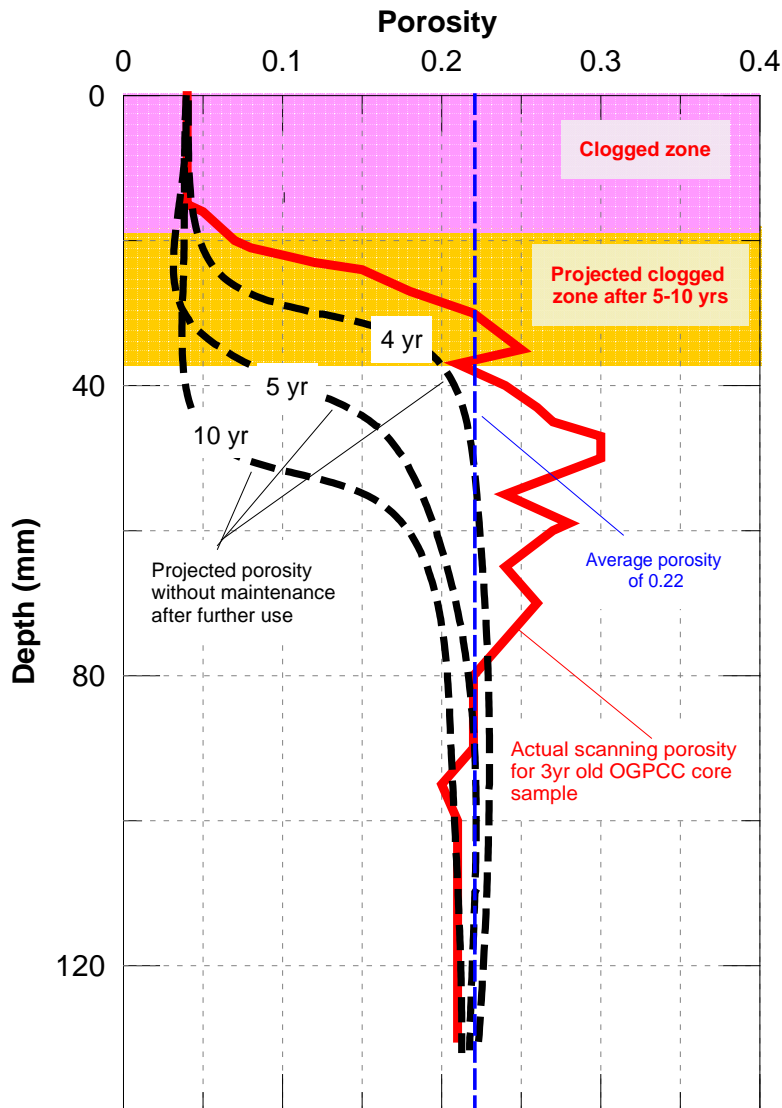

Figure B3-8. Porosity profile of an actual PCC-O core sample compared with estimated porosity profile without maintenance after further use (Kayhanian et al. 2010).

The impact of clogging based on porosity profile of surface pavement is illustrated in Figure B3-8, where the average porosity of the upper pavement layer decreased with years of operation without maintenance. Theoretically, surface overflow will occur when the porosity of the upper surface layer of pavement decreases and when the surface hydraulic conductivity reaches to less than the rain intensity. Typically, the maximum rain intensity for the Sacramento area is about 10^{-3} cm/sec. Therefore, the surface pavement hydraulic conductivity must decrease by close to 100 fold in order for surface runoff to occur. To investigate the clogging issues, several simulations were performed with surface saturated conductivity ranging from 1 to 5 percent of original value.

The clogging simulation results showed that no overflow failure occurred until the saturated hydraulic conductivity reached about 1 percent of the saturated hydraulic conductivity. In

addition, the amount of overflow volume was relatively insignificant compared to the total volume. In general, the overflow volume ranged from less than 1 to about 3 percent of total storm event volume.

Since there was no field investigation involved with this project, no specific maintenance schedule was recommended. However, it was specified that the full depth permeable pavement must be regularly cleaned in order to assure continuous permeability and infiltration of surface runoff through the pavement and base layers.

B3.25.4 Identified Data Gaps and Research Suggestions

The simulation results, while promising, must be verified by conducting a pilot field study. The modeling approach must then be validated with measured field data collected during the pilot study. Detailed design specifications could be developed based on the results of the pilot study and field trials. To validate the findings presented in the hydraulic performance report, the following activities were proposed for future investigation:

1. Construct two or more heavy vehicle simulator (HVS) test sections at the Advanced Transportation Infrastructure Research Center (ATIRC) to assess the structural and hydraulic performance of fully permeable pavement shoulder retrofit for highways.
2. Construct two or more test sections on University of California, Davis (UCD) bus routes to assess the structural and hydraulic performance of full permeable pavement designs.
3. Use various cleaning methods and assess the impact of regular maintenance on the clogging effect and maintaining high permeability of surface permeable pavement.
4. Measure the flow and quality of subsurface infiltrated water. The information gathered under this part of the study will be used: (1) to assess the short- and long-term impact of possible pollutants on groundwater and (2) to determine the sustainability benefits in terms of groundwater surcharge and pollutant removal.

B3.26 Urban Drainage Flood Control District (2010). Urban Storm Drainage Criteria Manual

Urban Drainage and Flood Control District (UDFCD). 2010. *Urban Storm Drainage Criteria Manual Volume 3. UDFCD, Denver, CO, USA.*

Structure	Hydraulic	Maintenance	Other
		<input checked="" type="checkbox"/>	

B3.26.1 Focus of the Project

UDFCD (2010) has published a stormwater drainage manual that contains information on permeable pavements. Relevant information is summarized herein.

B3.26.2 Maintenance

UDFCD (2010) states that inspection should occur at least once a year and, during the inspection, infiltration should be inspected either by observing a natural rainfall event or by spraying water on the surface with a hose. The document also mentions ASTM C1701 as a means of obtaining spot infiltration rates.

Other maintenance actions include debris removal and cleaning the surface with a regenerative air or vacuum sweeper at least twice per year. It is recommended that this be done on dry days and without the addition of water. Also, for PICP, the fill between pavers may need to be replaced after vacuuming. If infiltration rates are minimal, at least partial restoration can be accomplished by removing the top 0.5 to 1 inch of fill between pavers with a vacuum and refilling with clean aggregate.

If pervious concrete is clogged and vacuuming is ineffective, power washing or blowing is recommended before replacement of pervious concrete. Any saw cuts in pervious concrete can lead to raveling. If pervious concrete needs to be patched, it can be done with conventional concrete as long as the patch doesn't cover more than 10% of the area. Finally, all patches should be extended to existing isolated joints. Porous asphalt can also be patched with conventional asphalt as long as it does not exceed 10% of the total surface area.

With regards to snow removal and winter maintenance, sand should not be used and deicers, if used, may infiltrate and be non-effective. Deicers, however, can be used on PICP but should not be used on pervious concrete because it can damage the concrete. On porous asphalt, deicers can be used sparingly but mechanical snow removal is recommended.

B3.27 Vancura et al. (2010). Performance Evaluation of In-Service Pervious Concrete Pavements in Cold Weather-Final Report

Vancura, M., Khazanovich, L., MacDonald, K. 2010. Performance evaluation of in-service pervious concrete pavements in cold weather, Ready Mixed Concrete (RMC) Research & Education Foundation, Silver Spring, MD, USA.

Structure	Hydraulic	Maintenance	Other
<input checked="" type="checkbox"/>			<input checked="" type="checkbox"/>

B3.27.1 Focus of the Project

In work funded by the Ready Mixed Concrete (RMC) Research & Education Foundation, Vancura et al. (2010) presents laboratory and field research regarding the evaluation of pervious concrete pavement systems including visual assessment, subsurface assessment, and structural analysis. Their report also includes a pervious concrete field survey form that can be used when performing inspections and assessment of pervious concrete systems.

B3.27.2 Structural and Design Aspects

Vanura et al. (2010) reached the following conclusions regarding structural and design aspects:

1. The subgrade modulus, modulus of elasticity, and flexural strength of pervious concrete is typically lower than conventional concrete but through proper design (i.e. pavement thickness, base material, and base material depth) pervious concrete can provide adequate bearing capacity,
2. The Westergaard model accurately describes the behavior of pervious concrete,
3. The stiffness of pervious concrete is lower than conventional concrete and a modulus of elasticity value of 2.5×10^6 psi should be used in design if no other data is available,
4. An increase in pavement thickness and modulus of rupture increases the fatigue life of pervious concrete,
5. The base layer plays a significant role in the bearing capacity of pervious concrete,
6. Factors that affect the long-term performance of pervious concrete systems include but are not limited to proper mix design, placement and curing practices, and maintenance,
7. The applicability of the StreetPave fatigue model to pervious concrete is unknown.

B3.27.3 Identified Data Gaps and Research Suggestions

Vancura et al. (2010) indentified the following data gaps and research needs.

1. Full-scale testing or field studies should investigate the applicability of the StreetPave model to pervious concrete systems,
2. Pervious concrete sites should be monitored over time to develop a better understanding of the long-term performance of such systems and their rate of degradation,
3. Investigation into the effect of lightweight aggregate on pervious concrete should be performed because lightweight aggregate may decrease the strength of pervious concrete and/or it may aid in internal hydration which could increase the strength,
4. Freeze-thaw processes should be investigated to determine if damage is due to lack of paste hydration or the lack of a standard air void distribution,
5. An investigation into the pore size and pore size distribution in pervious concretes along with the quantity of hydrated cement paste could help explain the need for entrained air bubbles at water:cement ratios of 0.27 as found by Vancura et al. (2010),
6. Fatigue models for pervious concrete should be developed and calibrated.

B3.28 Izevbekhai and Akkari (2011). Pervious Concrete Test Cells at MnROAD Low Volume Road

Izevbekhai, B.I., Akkari, A. 2011. Pervious Concrete Cells on MnROAD Low-Volume Road. Minnesota Department of Transportation report no. MN/RC 2011-23, St. Paul, MN, USA.

Structure	Hydraulic	Maintenance	Other
<input checked="" type="checkbox"/>	<input checked="" type="checkbox"/>	<input checked="" type="checkbox"/>	

B3.28.1 Focus of the Project

Izevbekhai and Akkari (2011) reported on the design, construction, and early performance of three pervious concrete test cells (an overlay, pervious concrete on granular subbase, and pervious concrete on a cohesive subbase) at the MnROAD testing facility. The objective of the study was to test the performance of the cells on a low volume road in Minnesota's cold climate. Results related to full-depth pervious concrete are summarized herein. For more detailed discussion and results, see the corresponding case study in Volume 1 of this document.

B3.28.2 Structural and Design Aspects

Izevbekhai and Akkari (2011) used falling weight deflectometer tests to back calculate elastic moduli values of 10 and 25 GigaN/m² for pervious and conventional concrete, respectively. They also included a literature review, which is summarized herein, in which they briefly reviewed other related work.

In Eller and Izevbekhai (2007), a 1-year performance evaluation of a pervious concrete driveway was reported. A petrographic analysis revealed void ratios of 10 to 23% from top to bottom in test cores which were taken from sacrificial concrete pads placed next to the actual driveway. The actual pad exhibited uniform void ratio with depth although Izevbekhai and Akkari (2011) do not report the value. Also reported was a distress survey that shown excessive raveling at the location where concrete trucks were delayed and moderate raveling was observed in tooled joints.

Sieglen, W.E. and Von-Langsdorff, H. (2004) discussed using interlocking concrete block pavement (ICPB) in ports with subgrades that would have caused instability with conventional pavements because of gypsum. The port discussed is located on Staten Island in New York City and was expanded by about 12 acres with a 0.25 acre ICPB demonstration plot. ICPB was selected because of the poor quality subgrade and for its resistance to container loads, especially damage at corner castings. The ICPB was designed for a 20-year service life. The reported loads were 215,000 lb dual wheel axle loads (excluding dynamic forces) and stacked container point loads of 50,000 lb.

It was also reported that Haselbach, L.M., Freeman, R.M. (2006) noted top to bottom increases in porosity in 6 inch high slabs of pervious concrete that were placed with an approximate surface compaction of 10%. It is stated that uniform porosity with depth is a needed criteria for pervious concrete pavements.

Offenberg (2005) stated that for a successful pervious concrete project, each party involved in the construction must know their responsibility and keys to success. The paper also discussed the role of the contractor in such projects.

Another paper, Partl et al. (2003), focused on aggregate used in porous asphalt and was reviewed because of its relevance to pervious concrete. Partl et al. (2003) reported that, by optimizing the

gap in aggregate, a void ratio greater than 25% and an infiltration rate of at least 7 cm/s can be obtained.

Schaefer et al. (2006) developed a set of useful information for improving pervious concrete designs and construction practices. The set included optimizing void and aggregate content, and optimal water:cement ratio to maximize durability and strength. An optimal aggregate size of 3/8 or 1/2 inch aggregate size with a porosity of 20 to 25% were reported as optimal.

ACI (2002) described a procedure for proportioning concrete with slumps from zero to 1 inch and lower consistencies and with aggregates of 3 inches or less. Equipment for measuring consistencies are discussed along with aggregate properties and proportioning mixes for pervious concrete.

Fowler (2003) discussed requirement necessary for good pervious concrete performance. Although the size was not specified it was stated that the aggregate should be single graded. Listed conclusions include:

1. The initial surface finishing is extremely important in establishing a permeable surface,
2. Limited research indicates little clogging occurs over time,
3. Permeable pavement can reduce surface heat and reduce the need for stormwater ponds.

Kuennen (2003) pointed out that void content and void structure are crucial for good performance of pervious concrete. The following statements regarding pervious concrete were also made:

1. It can help communities meet EPA Phase II stormwater regulations,
2. It can reduce water spray, hydroplaning, and heat storage (in the summer),
3. The optimum void ratio is 20 to 25%. Higher void ratios reduce compressive strength,
4. Pervious pavements can be used in parking lots, recreation trails, plazas, and other pedestrian areas,
5. Water treatment may be achieved through transfer to soils and subsequent microbial degradation,
6. Pervious concrete costs more but can eliminate the need for gutters, storm sewer, etc.

Waagberg (1984) was also reviewed with the following advantages of porous asphalt listed:

1. There is a lower risk of hydroplaning with porous asphalt,
2. There is better friction when wet,
3. There is a reduction in traffic noise,
4. Wear by studded tires is no more than that of conventional asphalt,
5. There are better reflection characteristics.

It was also noted that the porous pavement was not more likely to ice compared to other pavements.

Stidger (2002) discussed managing concrete road life-cycles and stated that increasing the life of roads exposed to heavy rains can be accomplished by using pervious concrete. As with other authors, the importance of mix design, construction, and other variables were touted as being important to an extended pervious concrete life.

Welleman (1976) studied friction in porous surfaces and found that friction forces between tires and roads are significantly reduced by a water layer only a few millimeters thick. The thickness of the water layer, it was stated, is affected by lateral and longitudinal slopes, surface texture, ruts, and the length of the drainage path. Recommendations to reduce water nuisance include:

1. Including transverse drainage channels in the road surface,
2. Use of a high quality surface dressing that includes resins,
3. Use of high pervious asphaltic concrete as a wearing course.

Neithalath et al. (2005) found that the freeze-thaw durability was maximized when "macronodule" (aggregate-like, 2 to 8 mm in size) fibers were used.

Other documents were reviewed but the above include those most related to structural, water, and maintenance aspects.

Based on their own study, Izevbekhai and Akkari (2011) found that pervious concrete has higher sound adsorption and about the same friction as compared to conventional pavement. In studying the three test cells for performance it was noted that:

1. Pervious concrete can be designed with conventional methods such as the AASHTO 1993 method,
2. The cells had a slight increase in their International Roughness Index (IRI) and a decrease in surface rating (SR) over two years of study,
3. IRI values were much higher than conventional pavements and did not meet FHWA standards (possibly due to the fixed-form pavement method used),
4. SR values for all cells met MnDOT requirements for "good" pavements,
5. All friction values were above minimum requirements for skid resistance and safety,
6. The on board sound intensity (OBSI) increased in the summer and a slight overall increase over the 2 year study period (1/3 Octave Bands were not significantly affected by test location in any of the cells or between runs),
7. Predicting OBSI from sound adsorption tests is not possible at this time,
8. Sound adsorption did not vary over 2 years,
9. The ratio of porous to non-porous sound absorption coefficients is dependent on sound frequency,
10. Sound adsorption of the pervious test cells was improved compared to non-porous concrete tested at MnROAD,

11. FWD testing indicates that the deflection of the surface is dependent on season, with minimum deflection occurring in the fall and winter,
12. Based on thermocouple data and watermark sensors, pervious concrete can reduce temperature and moisture gradients, which help prevent warping and curling,
13. Traffic load was not the contributing factor of pavement distress, rather the important issues are related to the environment in which the pavement resides,
14. ISLAB or similar programs can be used to analyze and predict stresses in the pervious concrete,
15. Falling weight deflectometer (FWD) test results were higher than typical concrete pavements. It is not known how this may be related to durability but should be the subject of future research.

B3.28.3 Water Quality and Hydrology

Izevbekhai and Akkari (2011) found the following with regards to hydrology:

1. Infiltration rates varied significantly within the same cell, suggesting uneven consistency below the surface,
2. Infiltration rates in the granular subbase cell were, as expected, typically larger than into the clay subbase cell.

Izevbekhai and Akkari (2011) estimated a rainfall of 0.4 in/hr for 123 hours as the critical flood level. Although no definition of this scenario is given, it is stated to be contingent on the continuity of the base below cross-drains and the presence of a sloping aquifer that pushes trapped water westward through the porous subgrade.

B3.28.4 Maintenance

Izevbekhai and Akkari (2011) found and/or concluded the following with regards to maintenance:

1. For full-depth pervious concrete, temperature gradients through the pavement, base, and subgrade were reduced suggesting that the freeze-thaw cycles experienced by full-depth pervious concrete pavements may be reduced,
2. Vacuuming more than twice a year resulted in improved performance compared to lesser amounts of maintenance. The authors concluded that pervious pavements can be maintained with this amount of maintenance,
3. Freeze-thaw was a suspected cause of raveling. Keeping the pavement free from clogging may lessen freeze-thaw exposure and as a result, reduce raveling,

B3.29 Urban Drainage and Flood Control District (2011a). Stormwater Quality Monitoring Report Permeable Interlocking Concrete Pavement (PICP)

Urban Drainage and Flood Control District (UDFCD). 2011a. *Stormwater Quality Monitoring Report Permeable Interlocking Concrete Pavement (PICP) at Denver Wastewater Management Building Denver, Colorado 2008-2010*. UDFCD, Denver, CO, USA.

Structure	Hydraulic	Maintenance	Other
	<input checked="" type="checkbox"/>	<input checked="" type="checkbox"/>	

B3.29.1 Focus of the Project

The Urban Drainage and Flood Control District in Denver, Colorado (UDFCD) monitored a permeable interlocking concrete pavement (PICP) system at the Denver wastewater treatment plant. The PICP watershed was 5,300 ft², 3,590 ft² of which was impermeable. The ratio of impermeable area to the area of the PICP was 2.1:1. Results are discussed herein. For additional discussion on this and other projects related to the UDFCD, see the corresponding case study in Volume 1 of this report.

B3.29.2 Design Aspects

The PICP systems consisted of 3.125 inch thick pavers with less than 1/2-inch aggregate placed in between the pavers. The pavers were on top of an aggregate leveling course, which was on top of a large aggregate reservoir and filter layer. The filter layer consisted of sand and was included to improve water quality. An underdrain collected water and conveyed it downstream for sampling and flow measurement. The entire system was separated from the subgrade by an impermeable plastic liner.

B3.29.3 Water Quality and Hydrology

The PICP was tested for infiltration rate using a modified version of ASTM C1701 and water samples were collected from the PCIP site and a reference/control site to determine the impact the PICP had on water quality.

The concentration of some contaminants were higher in the PICP site compared to the control site. The authors explained that this could be due to the use of each site. The control site was an employee parking lot that received little vehicular traffic compared to the PICP site. Overall, the concentration of 29 contaminants in all water samples were determined and concentrations between the control site and the PICP were compared. Only 11 of the 29 contaminant concentrations were found to be statistically different between the sites and only 5 of the 11 were found to be lower on the PICP site. Those five were dissolved manganese, total zinc, chemical oxygen demand, total Kjeldahl nitrogen, and total suspended solids. Contaminant concentrations that increased were nitrates/nitrites and total cadmium, although these differences were not statistically significant.

Difficulties with the flow monitoring equipment on the site resulted in no conclusions with regards to the impact on runoff volumes. Also, because of differences between the control site and the test (i.e. PICP) site, drawing conclusions regarding the impact of the PICP on water quality was also difficult.

B3.29.4 Maintenance

The system partially clogged over three years but still seemed to maintain "good" infiltration over most of the PICP area. After three years, however, the pavement appeared to be partially clogged at a location where runoff first entered on to the PICP. At this time the PICP surface was swept with a vacuum sweeper. This removed aggregate between the pavers in many locations but not where the pavers appeared to be more clogged. The spaces between the pavers were filled in with aggregate, were needed.

B3.30 Urban Drainage and Flood Control District (2011b). Stormwater Quality Monitoring Report Porous Asphalt

Urban Drainage and Flood Control District (UDFCD). 2011b. *Stormwater Quality Monitoring Report Porous Asphalt at Denver Wastewater Management Building Denver, Colorado 2008-2010*. UDFCD, Denver, CO, USA.

Structure	Hydraulic	Maintenance	Other
<input checked="" type="checkbox"/>	<input checked="" type="checkbox"/>	<input checked="" type="checkbox"/>	

B3.30.1 Focus of the Project

The Urban Drainage and Flood Control District in Denver, Colorado monitored a 1,840 ft² porous asphalt pavement system at the Denver wastewater treatment plant. The total watershed area was about 5,900 ft², 4,060 ft² of which is impervious. The ratio of impervious area to the porous asphalt area is 2.2:1. The porous asphalt consisted of open graded hot asphalt with less than 3% fines passing the #200 sieve. A control site a few hundred feet away was also monitored for reference. Results are discussed herein. For additional discussion on this and other projects related to the UDFCD, see the corresponding case study in Volume 1 of this report.

B3.30.2 Structural and Design Aspects

Primary components of the porous asphalt system were the top wearing course, a reservoir layer, and a filter layer. All aggregate in the asphalt passed the 1/2-inch opening sieve. The filter layer consisted of sand and was included to improve water quality. An underdrain collected water and conveyed it downstream for sampling and flow measurement. The entire system was separated from the subgrade by an impermeable plastic liner.

B3.30.3 Water Quality and Hydrology

Difficulties with the flow monitoring equipment on the site made it difficult to draw conclusions with regards to the impact on runoff volumes.

Contaminant concentrations in effluent from the porous asphalt monitoring site were compared to those of the control site. Dissolved petroleum, chloride, and dissolved phosphorus (in one test) were significantly lower in the porous asphalt effluent. Nitrate/nitrite, total selenium, and dissolved sodium, however, were higher. Again, these differences may be due to differences in traffic volumes at each location because the control site received much less traffic.

B3.30.4 Maintenance

The pavement clogged over the 3 year study with a significant drop in infiltration rates observed after two years. The pavement was power washed, which was somewhat effective in restoring infiltration rates. The pavement was also vacuumed twice in the third year and again, infiltration rates improved somewhat. Much of the pavement, however, remained clogged.

Site maintenance included:

- Broom type street sweeper (before infiltration test) on July 2, 2009,
- Combination of street sweeping and pressure washing on June 22, 2010,
- Pressure wash with fire hose (by CAPA) on November 19, 2010,
- Vacuum truck during wet conditions (after rain) on May 18, 2011,
- Hand vacuumed after initial infiltration tests were conducted on June 29, 2011 (note two sets of tests performed on this date),
- Pressure washing in combination with vector truck suction on July 21, 2011.

Measured infiltration rates and the corresponding dates are shown in Figure B3-9.

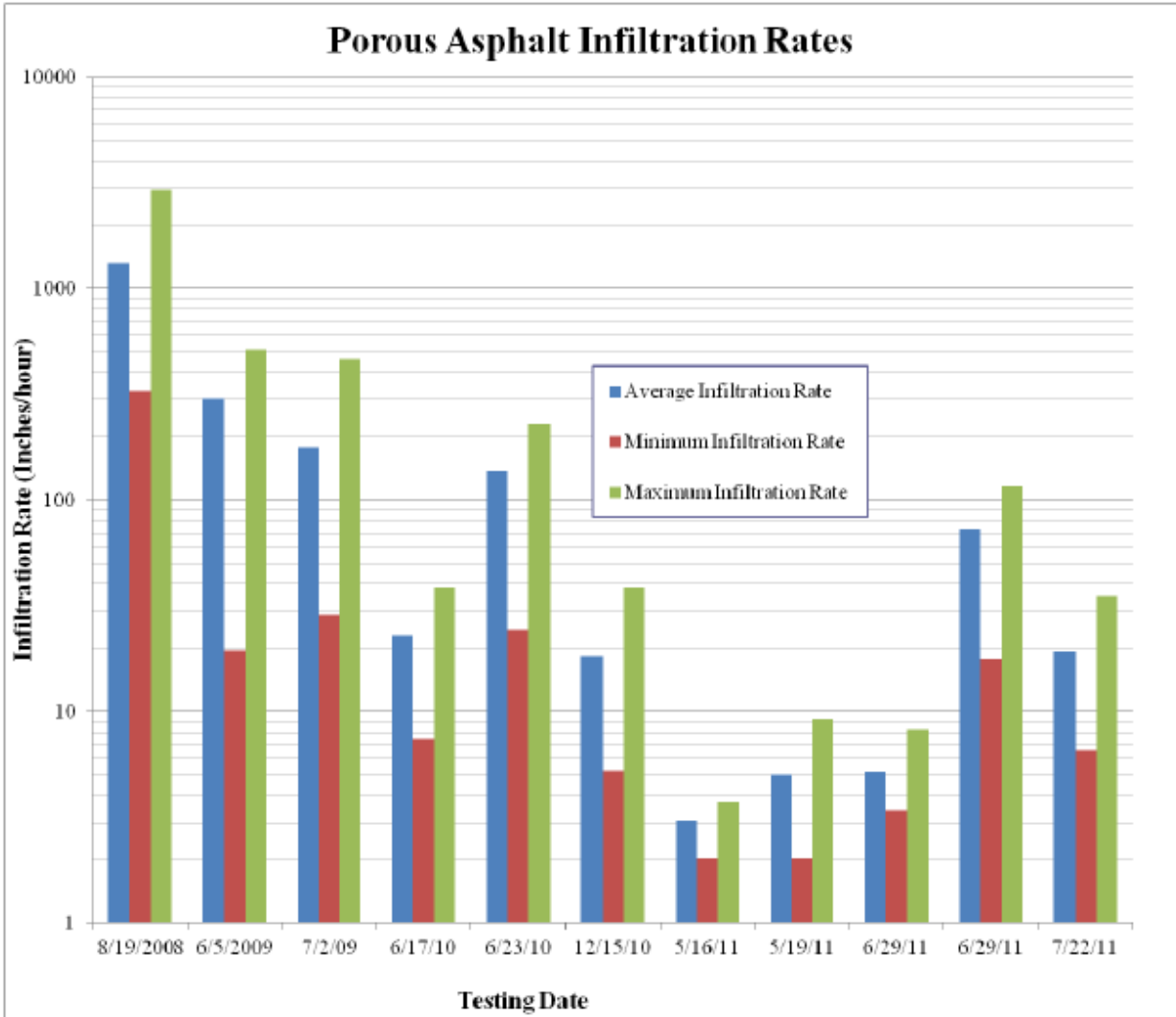

Figure B3-9. Porous asphalt infiltration rates (UDFCD 2011b).

B3.31 Drake et al (2012). Report on the Evaluation of Permeable Pavements in Canada

Drake, J., Bradford, A., Van Seeters, T., MacMillan, G. 2012. *Evaluation of permeable pavements in cold climates*. Toronto and Region Conservation Authority, Toronto, Canada.

Structure	Hydraulic	Maintenance	Other
	<input checked="" type="checkbox"/>	<input checked="" type="checkbox"/>	

B3.31.1 Focus of the Project

This three year study investigated the functional, hydraulic, and water quality aspects of three different types of permeable pavements (two permeable interlocking pavers and pervious concrete). In addition, the project investigated the benefits of using permeable pavements on low permeable soils, the use of permeable pavements in cold climates, and the effectiveness of cleaning practices.

The study was conducted at the Toronto and Region Conservation Authority's Living City Campus, about 5 miles north of Toronto, Canada. An existing parking area was replaced so that there were four cells, each about 2500 ft² in surface area. Two cells were constructed with permeable interlocking concrete pavers (AquaPave (R) and Eco-Optiloc (R)), one cell with pervious concrete, and one with conventional impermeable asphalt. The stone granular base provided about 19 inches of water storage. A perforated pipe placed at the interface of the native soil and the granular subbase drained each permeable pavement cell and a catch basin drained runoff from the conventional asphalt cell. The AquaPave site had an additional perforated pipe 39 to 59 inches below subbase layer and in the native soil. This enabled water sampling after water passed through the native soil so that the effects on water quality could be examined. A geotextile fabric was placed between the base and native soil. Each cell was hydraulically separated by concrete curbs that extended below the surface. Soils in the area were found to consist mostly of silts and clays with clay content ranging from 7% to 30%. Water quantity and quality of surface runoff and infiltrated water were monitored continuously.

Major findings related to surface infiltration, water quality and treatment, and maintenance issues are summarized below. For additional discussion regarding this project, see the corresponding case study in Volume 1 of this report.

B3.31.2 Surface Infiltration

Surface infiltration rates that was measured in May or June of each year for three consecutive years showed spatial variability through the porous pavements with coefficients of variation ranging from 0.51 to 1.2. Pervious concrete had the highest mean surface infiltration rate (0.35 cm/s) with Eco-Optiloc pavers (0.026 cm/s) and AquaPave pavers (0.0056 cm/s) exhibiting much lower rates. Throughout the course of the study, pervious concrete had measured infiltration rates on the order of 10 times larger than both PICPs with the order for both measured means and medians being pervious concrete > Eco-Optiloc > AquaPave. All three systems, however, fully infiltrated runoff from all the monitored storm events over the course of the study.

Table B3-7 shows how surface infiltration rates changed over each year of the 3 year study and Table B3-8 shows the percent change (and related data) for the change between the beginning and end of the study. It must be noted that spatial variability in surface infiltration rates existed over the course of the study and the largest losses were found in the center through-lanes that

received the most traffic and were at the low points of the AquaPave and Eco-Optiloc pavers. Although no sand was applied to the lot during the winter, sand was applied to nearby streets and cars entering the lot could have carried sand in with them.

Surface ponding was briefly observed on camera for less than one hour on the AquaPave pavement during one intense rainfall and it may have occurred briefly on the Eco-Optiloc pavement during the same storm. The ponding occurred during the day when all the parking spaces were occupied which reduced the infiltration capacity of the pavements and both the interlocking paver surfaces were, unlike the porous concrete, sloped toward the center, which may have pooled water in one location. Also, the AquaPave cell may have received some of the runoff from the traditional asphalt cell, which also would have increased the likelihood of ponding. Aside from winter slush accumulation on the AquaPave cell and the above mentioned ponding, all water was infiltrated by the permeable pavements. Thus, Drake et al. (2012) concluded that surface ponding is not anticipated for even the most intense storms.

Table B3-7. Variability in surface infiltration rates for different pavements (Drake et al. 2012).

Pavement	Mean (cm/s)	Median (cm/s)	Standard Deviation (cm/s)
2010			
AquaPave	0.042	0.043	0.026
Eco-Optiloc	0.144	0.140	0.074
Pervious Concrete	0.649	0.589	0.368
2011			
AquaPave	0.038	0.033	0.024
Eco-Optiloc	0.082	0.064	0.061
Pervious Concrete	0.497	0.371	0.406
2012			
AquaPave	0.009	0.006	0.011
Eco-Optiloc	0.039	0.026	0.033
Pervious Concrete	0.377	0.298	0.318

Table B3-8. Change in surface infiltration rate for different pavement between 2010 and 2012 (Drake et al. 2012).

Pavement	Mean (%)	Median (%)	Standard Deviation (%)
AquaPave	-86	-87	26
Eco-Optiloc	-84	-70	26
Pervious Concrete	-44	-43	35

B3.31.3 Water Quality and Hydrology

With regards to water quality, all stormwater that infiltrated through any of the porous pavements had significantly reduced mean and median event mean concentrations (as compared to the traditional asphalt lot) for suspended solids, oil and grease, ammonia-ammonium nitrogen, nitrite, total Kjeldahl nitrogen, total phosphorus, chloride, calcium, copper, iron, manganese, and zinc. For example, the median removal efficiency for zinc was 69% for AquaPave, 75% for Eco-Optiloc, and 80% for pervious concrete. Concentrations of dissolved solids, barium, strontium, magnesium, and potassium, however, all increased after infiltration through the permeable pavements. The resulting levels, however, did not exceed receiving water guidelines. It was also noted that pH, alkalinity, conductivity and temperature were also affected by the permeable pavement. The average pH of effluent from the pervious concrete lot was 9.2 and for the PICP lots the average was 8.3 (influent pH was not reported). Also, effluent from the two porous pavers was noticed to be similar in each case but different from the pervious concrete. For example, strontium concentrations were much larger in the porous paver effluent (3750 µg/L and 4370 µg/L, for the AquaPave and Eco-Optiloc, respectively) as compared to the pervious concrete ((1430 µg/L). Potassium concentrations, however, were much larger in the pervious concrete effluent (109.5 mg/L) as compared to the PICP effluent (27.5 mg/L and 20.1 mg/L for the AquaPave and Eco-Optiloc, respectively).

Total mass loads (L_{Total}) and mass load reduction (MLR) for various pollutants under different permeable pavements are summarized in Table B3-9.

Table B3-9. Total mass and MLR of various pollutants for different permeable pavements (Drake et al 2012).

Pollutant	L _{Total} (g)				MLR (%)		
	Control	AP	EO	PC	AP	EO	PC
General							
Solids, dissolved	104332	23777	78026	71560	77	25	31
Solids, suspended	8952	635	1260	3126	93	86	65
Solids, total	115178	24415	79297	74717	79	31	35
Solvent extractable	459	0	3	2	100	99	100
Metals							
Aluminum	61	20	41	79	67	33	-30
Barium	4	4	11	3	10	-165	31
Boron	0	1	4	4	-303	-1014	-1062
Calcium	3161	1382	3728	730	56	-18	77
Chloride	59061	7440	30582	16937	87	48	71
Copper	2	0	1	2	79	64	4
Iron	99	18	34	57	82	66	42
Magnesium	246	428	1043	245	-74	-324	0
Manganese	14	1	2	3	92	84	77
Potassium	311	1471	1999	8824	-373	-542	-2735
Sodium	25301	3012	11171	6336	88	56	75
Strontium	31	272	865	158	-766	-2654	-403
Zinc	10	1	2	2	89	82	85
Nutrients							
Nitrogen, ammonia + ammonium	27	3	5	7	91	83	75
Nitrogen, nitrate+nitrite	82	47	75	52	43	8	37
Nitrogen, nitrite	7	1	2	3	88	76	61
Phosphorus, phosphate	34	1	3	10	96	92	72
Phosphorus, total	59	2	6	18	96	90	70

Drake et al. (2012) concluded that:

1. Permeable pavements have significant advantages with regards to stormwater management when compared to conventional asphalt surfaces,
2. Permeable pavements can decrease runoff volumes, even in areas with low permeability soils,
3. Permeable pavements delay and reduce peak outflows. On average, peaks flows from permeable pavements were 91% smaller than those from the conventional asphalt site,
4. Permeable pavements function well in the winter and, based on surveys, did not experience surface heaving or slumping,

5. Surface infiltration rates decreased significantly over the 3-year study. Measured reductions for AquaPave, Eco-Optiloc, and pervious concrete were 87%, 70%, and 43%, respectively,
6. Even though surface infiltration rates decreases substantially, all pavements tested had the ability to infiltrate all the rainfall from the observed storms,
7. Mean pollutant concentrations in runoff from permeable pavement were significantly lower than concentrations in runoff from conventional asphalt,
8. The permeable pavements tested leached constituents into the stormwater but the long-term impact is unknown,
9. Salt application in the winter increased pollutant loads as the salt was found to contain metals, nitrogen, phosphorus, and naphthalene,
10. During the warm season (May-August) water infiltrating through the AquaPave surface was cooler than that of traditional asphalt and during the cooler months (October-February) the AquaPave effluent was warmer than the asphalt runoff.

B3.31.4 Maintenance

Drake et al. (2012) investigated the effectiveness of maintenance activities on other, older permeable pavement lots in the Toronto region. Some lots were swept with a mechanical sweeper and one was pre-wetted and cleaned with a regenerative air sweeper. Infiltration testing before and after maintenance showed no significant change in infiltration rates at any of the sites. Mechanical sweepers are not recommended for use on permeable pavements so these results were expected. Furthermore, one of the sites cleaned with the mechanical air sweeper was subject to excessive amounts of fine sediment due to nearby construction activities. This may have affected the effectiveness of the sweeper. Also, with regards to regenerative air sweeping, pre-wetting of pavements is not recommended. Thus, the effectiveness of both maintenance activities may have been impacted negatively and results may not be typical.

As an investigation into the impact of vacuum sweeping as a preventative maintenance action, vacuum sweeping was performed in 2012 on the pervious concrete, AquaPave, and Eco-Optiloc surfaces. The median infiltration rate of the AquaPave and Eco-Optiloc pavements were increased by 271% and 137%, respectively, while the median pervious concrete infiltration rate decreased by 5%. This suggests that vacuuming may not be as effective on pervious concrete. The pervious concrete, however, still had infiltration rates an order of magnitude larger than the PICPs.

Table B3-10 shows infiltration rates before and after maintenance. The surface infiltration rates of half of the maintained sites improved after maintenance. Based on their results, Drake et al. (2012) concluded that suction-based sweeper trucks are well suited for rehabilitative maintenance of permeable pavements. Preliminary observations suggest that the most effective way to maintain the surface of a permeable pavement is to dislodge sediment and then remove it.

Table B3-10. Infiltration rates before and after maintenance (Drake et al. 2012).

Treatment	Infiltration Rate (cm/hr)		Change (cm/hr)	Depth Exposed (cm)
	Pre-treatment	Post-treatment		
Seneca College King's Campus				
No Treatment	1.1	2.9	1.8	NA
Hand Sweeping	0.7	4.7	4.0	0.1
Low Suction Vacuum	0.7	6.5	5.8	0.5
High Suction Vacuum	0.7	4.0	3.2	0.3
Pressure Wash	0.7	¹		3.0
Sunset Beach, Richmond Hill				
No Treatment	0.7	1.4	0.7	NA
Hand Sweeping	1.4	1.4	0.0	0.4
Low Suction Vacuum	0.4	1.4	1.1	0.8
High Suction Vacuum	0.7	2.9	2.2	0.4
Pressure Wash	0.7	> 250 ²		2.2
East Gwillimbury GO Station				
No Treatment	3.2	5.8	2.5	NA
Hand Sweeping	2.2	1.1	-1.1	0.2
Low Suction Vacuum	2.2	253.8	251.6	1.0
High Suction Vacuum	2.5	96.5	94.0	0.5
Pressure Wash	3.6	295.9	292.3	2.5
St Andrew's Niagara-on-the-Lake				
No Treatment	32.0	47.5	15.5	NA
Hand Sweeping	10.1	6.5	-3.6	0.1
Low Suction Vacuum	13.7	211.3	197.6	3.5
High Suction Vacuum	10.4	100.4	90.0	1.0
Pressure Wash	17.3	246.2	229.0	4.5
BMO Field				
No Treatment	16.2	5.4	-10.8	NA
Hand Sweeping	10.08	9.72	-0.4	NA
Low Suction Vacuum	5.76	15.48	9.7	NA
High Suction Vacuum	9.36	9.36	0.0	NA
Pressure Wash	6.48	15.48	9.0	NA
Earth Rangers				
No Treatment	5.4	38.88	33.5	NA
Hand Sweeping	3.96	4.32	0.4	0.5
Low Suction Vacuum	11.16	161.64	150.5	2
High Suction Vacuum	2.88	193.68	190.8	3.5
Pressure Wash	5.76	176.04	170.3	3.0
Guelph Line				
No Treatment	3.6	1.44	-2.2	NA
Hand Sweeping	3.6	-	-	NA
Low Suction Vacuum	3.6	5.4	1.8	NA
High Suction Vacuum	1.08	-	-	NA
Pressure Wash	1.08	21.96	20.9	NA

Notes: 1. Infiltration rate into the pavement was too fast to measure accurately. 2. A complete seal between the rings and pavement was not achieved, resulting in large losses through the sides.

B3.31.5 Identified Data Gaps and Research Suggestions

Based on their work, Drake et al. (2012) recommends the following:

1. Partial infiltration permeable pavement systems should use raised pipes or control valves to increase infiltration and reduce effluent volume,

2. Closed outlet tests suggested that raising the perforated drain pipe in systems on low permeable soils may cause outflow volumes to be significantly reduced but further investigation is needed,
3. Further testing on leaching of materials from pervious pavements should be performed,
4. Further investigation is needed to determine the specific conditions under which partial infiltrations permeable pavement systems should be eligible for pollution removal credit,
5. Further tests should be perform on potential methods of dislodging material from permeable pavement surfaces,
6. Pervious concrete should receive maintenance only every two years or less,
7. Further research is needed to know how the characteristics of permeable pavements change over time,
8. Further research should be performed on the use and performance of permeable pavements in cold climates,
9. Further research is needed to determine winter salting requirements on permeable pavements,
10. Further research is needed to determine the impact of larger traffic volumes and heavier traffic loads on the resistance of permeable pavement systems to frost heave and slumping.

B3.32 Amde and Rogge (2013). Development of high quality pervious concrete specifications for Maryland conditions

Amde, A.M., Rogge, S. 2013. Development of high quality pervious concrete specifications for Maryland conditions. State Highway Administration Maryland Department of Transportation, Report number: MD-13-SP009B4F, Baltimore, MD, USA.

Structure	Hydraulic	Maintenance	Other
<input checked="" type="checkbox"/>			

B3.32.1 Focus of the Project

In an effort to develop preliminary specifications for pervious concrete, Amde and Rogge (2013) conducted investigations to enhance the structural performance and durability of pervious concrete. This was accomplished through testing different admixtures (cellulose fibers, a delayed set modifier, and a viscosity modifier). Specimens developed from different mix designs were tested for density, void content, compressive strength, split tensile strength, permeability, freeze-thaw durability, and abrasion resistance. Freeze-thaw testing was performed at 100%, 50%, and 0% saturation.

Cellulose fibers can help prevent shrinkage and temperature cracking and fiber balling. They can, however, be subject to algae and fungi attacks and thus, are usually coated with a biocide.

Viscosity modifier admixture can be added for better flow, faster discharge time from the truck, and easier placement and compaction. It can also help prevent paste drawdown, a condition in which the concrete paste migrates to and seals the bottom.

Concrete mix designs that were investigated had void contents of 15 to 25%, water:cement ratios of 0.27 to 0.33, and binder to aggregate ratios below 0.25. The density and air void content of concrete specimens were found by determining the theoretical density of the concrete (on an air-free basis). The absolute volumes were calculated by dividing the mass of the ingredient by its density. The actual mix density was determined by dividing the mass of concrete by its volume. The target void content was 20%.

Compressive strength of all specimens was measured at 7, 14, 28, and 120 days and split cylinder tests were performed on all samples. Also, permeability tests were performed on all samples using the falling head test method. Abrasion resistance was quantified by measuring the amount of concrete abraded off a surface by a rotating cutter in a set period of time.

B3.32.2 Structural and Design Aspects

The cellulose fiber admixture had the greatest impact on concrete durability due to the fibers ability to help hold the aggregate/paste mix together. Both abrasion resistance and freeze-thaw durability increased with the addition of cellulose fibers. The delayed set modifier reduced permeability because more concrete paste settled to the bottom and developed a less pervious layer. The viscosity modifier resulted in a mix that was easier to handle but had little other impact.

B3.32.3 Identified Data Gaps and Research Suggestions

Amde and Rogge (2013) made recommendations and identified knowledge gaps. They are:

1. A non-destructive test to determine the level of compaction and the uniformity of compaction throughout a pervious concrete sample should be developed. This could be used to help determine structural properties of in-place pervious concrete,
2. Investigation into the fatigue of pervious concrete will be needed if the application of pervious concrete is to be expanded to light and medium traffic situations,
3. Full saturation of aggregates could help the curing process by potentially releasing moisture in a more controlled manner. Further investigation should be undertaken to determine if the process could be used in place of or in addition to typical curing methods,
4. Research should investigate the impact recycled aggregate has on pervious concrete determine what properties of recycled aggregate are desirable or optimum.

B3.33 Hein et al (2013a). NCHRP Report on Permeable Shoulders with Stone Reservoirs

Hein, D., Strecker, E., Poresky, A., and Roseen, R. 2013a. *Permeable Shoulders with Stone Reservoirs*. Report prepared from the American Association of State Highway and Transportation Officials (AASHTO), NCHRP Project 25-25, Task 82, National Cooperative Highway Research Program, Transportation Research Board.

Structure	Hydraulic	Maintenance	Other
<input checked="" type="checkbox"/>	<input checked="" type="checkbox"/>	<input checked="" type="checkbox"/>	<input checked="" type="checkbox"/>

B3.33.1 Focus of the Project

The study was conducted to evaluate the suitability of using permeable pavement for roadway shoulder applications. This project was initiated because the permeable pavement systems are designed to minimize environmental impacts, stormwater runoff, and flooding and to treat or remove pollutants by allowing stormwater to infiltrate through the pavement in a manner similar to pre-development hydrologic conditions. Under this stormwater management program, the water from the surface of the roadway would flow into the permeable shoulder into a stone reservoir to temporarily store and treat runoff before infiltration into the roadway subgrade soils and/or discharge to other stormwater conveyance and treatment systems.

This report evaluated the existing literature and based on available information identified some of the key design, construction, implementation and maintenance features of permeable pavement shoulder design. Major topics evaluated in this report include: structure and hydrologic design, construction issues, and maintenance standards. This report also presented a decision matrix to properly select suitable permeable pavement sites and provided some suggestions for data gaps and futures studies. Some information presented in this report is general and not specifically related to permeable shoulder design. The important and relevant findings presented in this report are summarized below.

B3.33.2 Structural and Hydrological Design of Permeable Pavements

The structural and hydrological components for design of permeable pavements are shown in Figure B3-10. As shown, the structural design of the pavement is completed to determine the thickness of the various pavement components that are necessary to support the intended design traffic while protecting the subgrade from permanent deformation. The hydrological design determines the key design elements necessary to infiltrate rainwater and surface runoff into the pavement and hold and/or detain and filter the water to achieve the stormwater management objectives. An optimal permeable pavement design is one that is just strong enough to accommodate the design traffic and has the minimum hydrological features to provide water quantity and quality management (Smith 2011).

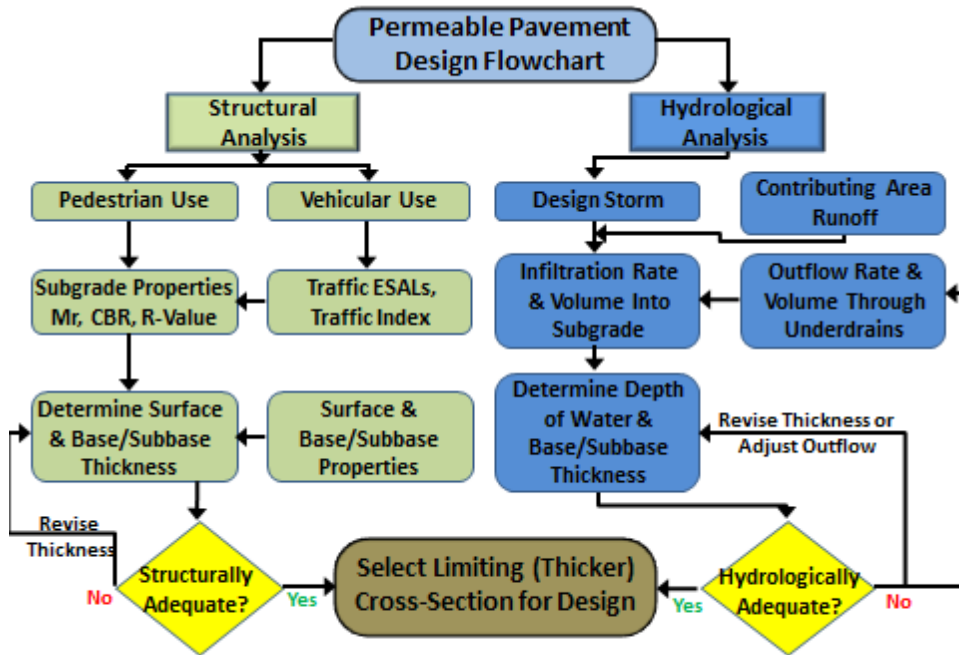

Figure B3-10. Structural and hydrological design flowchart (Hein et al. 2013a).

B3.33.2.1 Structural Analysis Framework

The American Association of State Highway and Transportation Officials (AASHTO) provided structural design guidelines for porous asphalt and permeable interlocking concrete pavement (AASHTO 1993). Pervious concrete structural design is based on the StreetPave system as modified by the American Concrete Paving Association (ACPA 2012). Brief descriptions of the design methods used with these systems is provided in the following sections.

Porous Asphalt and PICP Structural Design

The AASHTO pavement structural design method is summarized using the following equation (U.S. Customary units) (AASHTO 1993):

$$\text{Log } W = Z_R \times S_0 + 9.36 \times \log(\text{SN} + 1) - 0.02 + \frac{\log\left[\frac{P_i - P_t}{P_i - 1.5}\right]}{0.4 + \frac{1094}{(\text{SN} + 1)^{5.19}}} + 2.32 \times \log(M_R) - 8.07 \quad 3-1$$

where W = design traffic load in equivalent single axle loads (ESALs), Z_R = standard normal deviate for reliability “R,” as described below, S_0 = standard deviation, as described below, SN = structural number of the pavement, as described below, which is $= \sum a_i * d_i$, a_i = structural layer coefficient, as described below, d_i = layer thickness, p_i = initial serviceability, as described below

p_t = terminal serviceability, as described below, and M_R = subgrade resilient modulus (units must be U.S. Customary).

A brief discussion of the key pavement structural design elements and typical values follows:

The AASHTO design procedure characterizes traffic loads in terms of Equivalent Single Axle Loads (ESALs). One ESAL is represented as the application of a single 80 kN (18,000 lb) axle load. Permeable pavements in North America have typically been designed for applications not exceeding about 1 million ESALs (Smith 2011). Design procedures have recently been developed in Europe that accommodates ESAL loadings into the 10 million range (Interpave 2010). Highway pavements are typically designed for ESAL loading in the order of 5 to 100 million ESALs. Shoulders; however, receive much less traffic unless they are utilized for expanded capacity during rush hour for example. A typical shoulder pavement would be exposed to much fewer than 100,000 ESALs during its design life. It should be noted that procedures used by a particular agency to calculate ESALs will be required. This may include differences in the calculation of ESALs for flexible and rigid pavements.

The design reliability level (Z_R , factor of safety) is the reliability level selected by the designer to take into account the probability that the pavement as designed may not provide satisfactory service during the intended period of service. The increase in the design reliability level results in more substantial (stronger) pavement with higher probability that the pavement will perform as designed. For the AASHTO design procedure, the higher the selected reliability and standard deviation, the higher the design ESALs used in the design and the thicker the pavement design for a specified loading. Critical facilities are typically assigned reliability factors of 95 percent or higher. Low traffic volume roadways and less critical facilities may be assigned reliability values of 75 percent or less. For permeable shoulder pavements, a reliability factor in the order of 80 percent ($Z_R = -0.841$) would be considered appropriate. This represents a low to medium level of reliability.

The overall standard deviation (S_0) takes into account the variability associated with design and construction inputs, including variability and material properties, subgrade, traffic, and environmental exposure. Other factors that contribute to the overall standard deviation include lack-of-fit of the AASHTO model and replicate section errors (errors due to other unaccounted factors). For shoulder pavements, a standard deviation of 0.44 is appropriate for flexible pavements and pavers and 0.34 for rigid pavements.

The Structural Number (SN) of the pavement is a dimensionless value that represents the “strength” of a pavement section. It is determined by multiplying the thickness of a pavement layer (d_i) by its layer coefficient (a_i) which is a representation of the strength of the layer and then summing this value for all layers. The higher the SN, the stronger the pavement section.

The layer coefficient (a_i) is a measure of the strength of an individual layer. This value typically ranges from about 0.06 for subbase layers to 0.44 of bound layers such as asphalt concrete layers. Typically, layer coefficient values for permeable pavement layers are lower than for conventional dense graded pavement layers. For example, the layer coefficient for a new dense graded asphalt layer would typically range from 0.4 to 0.44. Porous asphalt concrete is produced by modifying the aggregate gradation to permit water to flow through the pavement. In doing so, the strength of the layer is reduced. As such, porous asphalt has a layer coefficient in the range of 0.2 to 0.3 as well as the paver and bedding materials used as permeable interlocking concrete pavement. A similar reduction applies to open graded base and subbase layers (Hein 2006). Dense graded base, for example, would have a layer coefficient in the order of 0.12 to 0.14. An open graded base would be between 0.06 and 0.09. This reduction reflects the reduced load carrying capacity of the open graded layer. Open graded base layers are sometimes stabilized with either asphalt cement or Portland cement, which may increase their layer coefficient.

The variable p_i is the initial serviceability of the as-constructed pavement. For the design of both flexible and rigid pavements, the AASHTO Guide uses present serviceability index (PSI). This index was developed through regressions between slope variance measurements, key distress types (rutting, alligator cracking, and patching for flexible pavements and cracking and patching for rigid pavements), and subjective present serviceability ratings (PSR). The index, like PSR, is based on a scale of 0 to 5, with 0 representing a completely failed pavement and 5 representing a perfectly even and unblemished pavement. The initial serviceability of a new highway pavement would typically range from about 4.1 to 4.5. An initial serviceability of 4.2 would be considered reasonable for a shoulder pavement.

The variable p_t is the terminal serviceability of the pavement or the point in time at which rehabilitation of the pavement would be considered necessary to keep it in a serviceable condition. The terminal serviceability is typically higher for more important pavement sections such as interstate highways that are subjected to more frequent traffic. Terminal serviceability for highway lanes is typically in the 2.2 to 3.2 range. A value of 2.5 would be considered reasonable for shoulder pavements.

The characterization of subgrade soils (M_R) is one of the most challenging parts of pavement design. Subgrade soil consists of native soil left after the removal of the existing overlaying material, as well as soils used as earth borrow to construct embankment fills or to replace existing unsuitable soils. The objective of the subgrade construction is to provide a uniform foundation for the pavement structure. The ability of subgrade soil to support a pavement structure is characterized by its laboratory-determined M_R . The design modulus used in the AASHTO design is based on the support capability determined after the subgrade material has been 'soaked' for 96 hours, i.e. saturated. The AASHTO design equation is very sensitive to this input. The common approach in providing guidance in the selection of resilient modulus is to

group soil types into common categories and assign typical M_R values to each category. The selection of an appropriate design value for M_R depends on a number of factors and a suitability qualified geotechnical engineer should be consulted for its determination. In general, coarse grained soils such as sands and gravels have higher M_R values than fine grained soils such as silts and clays. As such, the required pavement thickness for a given traffic level is higher for fine grained soils.

The characterization of the subgrade is not only for structural design purposes. It is also important if one of the goals of the permeable pavement design is to infiltrate water into the subgrade. It is important to establish the relationship between soil permeability and *in situ* soil density achieved during construction. This is important to establish a relationship between subgrade infiltration capability and the structural capacity necessary to support the design traffic. For example, a resilient modulus determined at a soil compaction level of 95 percent of the standard Proctor maximum dry will have lower infiltration capacity and higher structural capacity than a resilient modulus determined at a soil compaction level of 90 percent. Further, in the event that the field density is less than the design density, it may be necessary to decrease the design resilient modulus, which decreases the structural capacity especially when the soil is saturated, requiring a thicker pavement structure.

It should be noted that some of the current permeable pavement design documents require that the subgrade not be compacted to promote infiltration. This would be very difficult to achieve in a highway construction environment as a uniform subgrade cross-section is desirable to provide lateral drainage and it would be very difficult to control the movement of construction equipment which would tend to compact the subgrade during construction operations. A geotechnical engineer should be consulted for further detailed information.

Pervious Concrete Structural Design

The structural design of pervious concrete pavements is different than that used for porous asphalt and PICP. The most common procedure used in North America is that outlined by the American Concrete Paving Association (ACPA 2012). This procedure uses fatigue of the pervious concrete as the primary failure mode for the pavement. The fatigue/damage equation for the pavement is:

$$FD_{total} = FD_{single} + FD_{tandem} + FD_{tridem} \quad 3-2$$

where: FD_{total} = Total fatigue damage (%), FD_{single} = Fatigue damage from single axle load (%), FD_{tandem} = Fatigue damage from tandem axle loads (%), FD_{tridem} = Fatigue damage from tridem axle loads (%).

Fatigue damage for each axle type in Equation 3-3 is determined using Miner's damage hypothesis (Miner 1945).

$$FD = \frac{n}{N_f} \quad 3-3$$

where: n = number of load applications, N_f = allowable applications before failure.

The number of load applications is determined using the same traffic analysis as outlined in the AASHTO design procedure except the heavy vehicles are divided into the number of single, tandem and tridem axle load categories. The total allowable applications to failure can be estimated as:

$$\text{Log } N_f = \left[\frac{-SR^{-10.24} \log(1-p)}{0.0112} \right]^{0.217} \quad 3-4$$

where, N_f = allowable applications before failure, SR = stress ratio (%), and P = probability of failure (%).

The stress ratio is a function of flexural strength and the equivalent stress, which is a function of load weight. The higher the number of load repetitions the lower the stress ratio. For load repetitions of 100 axel loads, the stress ratio would be in the range of 0.8. For load repetitions greater than 1 million, the stress ratio is 0.5. For pervious shoulder applications, a stress ratio of about 0.5 would be appropriate.

The probability of failure is calculated as:

$$P = 1 - R * \frac{SC}{50} \quad 3-5$$

where, P = probability of failure (%), R = reliability (%), and SC = percent slabs cracked at the end of the design life (assumed at 15 %).

The stress ratio is the stress divided by the strength of the material.

$$SR = \frac{\sigma_{eq}}{MR} \quad 3-6$$

where, SR = stress ratio (%), σ_{eq} = equivalent stress, MPa (psi), and MR = flexural strength of the concrete, MPa (psi).

The flexural strength of typical conventional concrete pavement ranges from about 4.5 to 6.5 MPa (650 to 945 psi). The flexural strength of pervious concrete typically ranges from about 2 to 3 MPa (290 to 435 psi).

B3.33.2.2 Hydrologic Analysis Framework

There are numerous stormwater models that could be used to complete the hydrological design for permeable shoulder pavements. Depending on the hydrologic design goals, one of the following models may be used:

Simple volumetric runoff estimation methods. These models generate an estimated runoff volume for a specified design storm depth, but do not assign a hydrograph “shape” to this runoff volume. Examples include the NRCS Curve Number method, the volumetric runoff coefficient method, and others.

Event-based hydrograph estimation methods. These models generate an estimated runoff hydrograph for a specified design storm. Examples include the Watershed Hydrology Program (WinTR-20), Small Watershed Hydrology (Win TR-55), Santa Barbara Unit Hydrograph (SBUH), HEC-1 Flood Hydrograph Package, HydroCAD Stormwater Modelling (HydroCAD), and others.

Continuous simulation modeling programs. These models generate long term runoff hydrographs from multiple storms based on a real observed continuous rainfall record and other hydrologic inputs; many also have the capability to route the hydrograph through stormwater management facilities that conduct continuous analysis of transient inflows, outflows, and storage levels. Examples include the USEPA Stormwater Management Model (SWMM), the Hydrologic Engineering Center Hydrologic Modeling System (HEC-HMS), Source Loading and Management Model for Windows (WinSLAMM), Integrated Design Evaluation and Assessment of Loadings (IDEAL), others.

In general, the hydrological analysis assesses if the design runoff volumes or hydrographs can be infiltrated, stored and released by the pavement structure provided. The quantity of water in the pavement system is described as a water balance (NRCS 1986):

$$\begin{aligned} \text{Water Volume (Time)} = \\ \text{Initial Water Level} + \\ \int_0^{\text{time}} \text{Inflows(Time)} - \text{Surface Outflows(Time)} - \text{Volume Reduction (Time)} \end{aligned} \quad 3-7$$

Variations on this general framework for specific hydrologic analysis applications were also provided by the NCHRP report (2013a).

B3.33.3 Conceptual Design Configurations

Several configurations can be considered for construction of permeable shoulder systems. The designs need to consider many features such as local or rural environment, design traffic, storm intensity, subgrade type, geometric restrictions, stormwater management objectives, etc. Generic/conceptual designs are shown in Figure B3-11. The cross-sections shown are for a rural design. For urban designs, the granular rounding may be reduced in width and hard surfaced. Curb and gutter, gutter, barrier walls, safety barriers may also be present beyond the permeable shoulder.

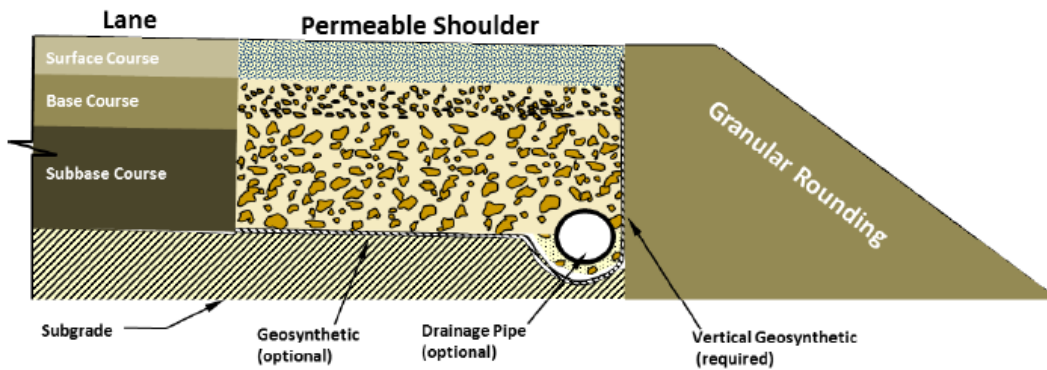

(a) Basic design

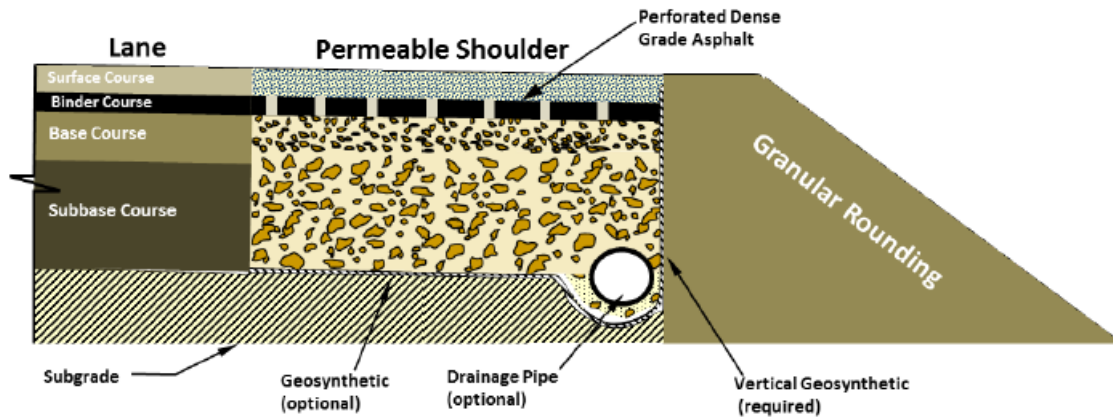

(b) Strengthened design

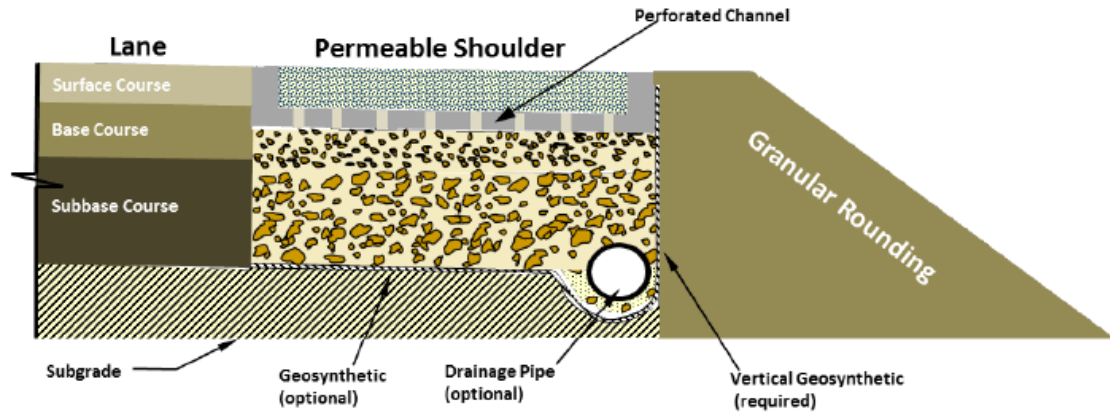

(c) Channeled design

Figure B3-11. Conceptual permeable shoulder design configurations (Hein et al. 2013a).

B3.33.4 Permeable Shoulder Pavement Maintenance Guidelines

Several preventive maintenance activities were recommended to ensure the functional integrity of the permeable shoulder pavement that include:

1. Permeability checks should be completed using standard infiltration tests, (ASTM C1701-09 and ASTM C1781-13). As well as visual inspection of clogging and durability,
2. Inspect permeable pavements after major rain events to ensure pavement structural integrity and surface infiltration,
3. Perform vacuum sweeping at regular intervals in high risk areas, such as areas where sources of sediment or organic debris are higher, and/or where the ratio of tributary to pervious area is high. Twice per year is recommended and should be increased in areas subject to higher concentrations and deposition rates of dust and debris, biomass loading, etc. (Henderson 2011). Restore any joint filler loss for PICP,
4. Properly maintain upstream landscaping to minimize run-on of sediment and debris,
5. Maintain drainage pathways from upstream pervious and landscaped areas to minimize potential for run-on to pavement,
6. Inspect and clean all outlet structures to ensure positive water flow from the permeable pavement,
7. Provide inspection ports and regularly monitor drainage rates of the stone reservoir to identify if clogging of underlying soils or outlet structures has occurred; remedy to avoid damage associated with extended ponding below the roadway,
8. Eliminate the use of sand for winter maintenance activities,
9. Clear snow after every storm is recommended. Special plow blades can be used but are not necessary. Raised snow plow blades are not recommended and any bouncing movement of the vehicle may result in damage to the permeable pavement surface (UNHSC 2011),
10. Clearing of snow completely from the permeable pavement surface,

11. Limit the use of winter deicing chemicals for sensitive vegetation areas, sensitive receiving waters, or for pavements designed to capture and reuse water.

Additional winter maintenance of permeable pavement is presented in the NCHRP report, however, most of them are specifically related to permeable shoulder pavements.

B3.33.5 Permeable Shoulder Feasibility Decision Matrix

To help in evaluating the suitability of projects for the use of permeable shoulders, a project suitability matrix (template) was developed which could be adjusted based on specific needs. The matrix includes many issues that must be considered and has weighting factors for each group of issues. Within each group, individual items also are given weighting factors with each factor assessed based on specific goals of the project. After all weighting factors have been assigned, scores are calculated and summed with final possible scores ranging from 0 to 100. It is suggested that if the total score is less than 65 the project is not a good candidate for permeable shoulders. Between 65 and 75, the project may be considered for permeable shoulders. Scores over 75 indicate that the project is well suited for permeable shoulders.

In an example in Hein et al. (2013a), the primary considerations were given a category weighting of 60 points; the secondary considerations were weighted at 30, and other considerations were weighted at 10. The scoring system is flexible, however, in that weighting factors are adjustable and can be tailored to specific locations and/or projects. Also, items for consideration could be added or removed from the list.

B4 Conference Proceedings and Peer Reviewed Journal Papers Publications

This chapter presents the review summary of published work presented in conference proceedings and peer reviewed journal papers. In general, these publications have been more rigorously reviewed than the reports and industry manuals presented in Chapters 2 and 3. As with the previous chapters, in this chapter the focus of each study is presented and the results are summarized according to the objectives of the study.

B4.1 Pratt et al (1999). Mineral oil bio-degradations within a permeable pavement: Long term observations

Pratt, C.J., Newman, A.P., Bond, P.C. 1999. Mineral oil bio-degradations within a permeable pavement: Long term observations. *Water Science and Technology*, 39(2):103-109.

Structure	Hydraulic	Maintenance	Other
	<input checked="" type="checkbox"/>		

B4.1.1 Focus of the Project

A laboratory full-scale permeable pavement system was investigated for its ability to retain and treat petroleum based contaminants. The section studied consisted of concrete pavers in a bed of gravel. The gravel, which extended 20 mm below the pavers, was placed on top of a geotextile fabric which was placed on top of 600 mm of 20-50 mm diameter crushed granite. The entire unit rested on and was supported by another layer of geotextile and an underlying stainless steel mesh.

The test section was subject to long-term, low level hydrocarbon loading at rates that would be typically experienced by urban roads and/or parking lots. Only clean motor oil, which has low poly-aromatic hydrocarbon (PAH) concentrations, was applied. Water quality was monitored over several months to determine the ability of the pavement system to retain and treat the petroleum based contaminants.

B4.1.2 Hydrology and Water Quality Performance

Results indicate that the permeable pavement investigated has the ability to sustain microbial populations such that the structure acts as an *in situ* bioreactor with regards to petroleum based contaminants. Petroleum contamination in the effluent was reduced to 2.4% of what was applied (i.e. an influent concentration of 900 g/m²-year was reduced to an effluent concentration of 22 g/m²-year).

A limiting factor in the reduction of petroleum appeared to be nutrient supply but a slow-release fertilizer was used to supply nutrients to the pavement structure which enabled petroleum degradation to be sustained. Fertilizer must be controlled and used with caution, however, as release of nutrients could reduce water quality of downstream receiving bodies. Also, because only clean motor oil was applied, the study did not investigate the potential for degradation of

PAHs within the pavement structure. Clearly, the results obtained are inconclusive and raised more questions than answers. For instance, the use of clean engine oil is unreal and the application of fertilizer as nutrient source may cause additional problems with respect to nitrogen or other contaminants being discharged to groundwater or receiving waters.

B4.2 Dierkes et al (1999). Heavy Metal Retention within a Porous Pavement Structure

Dierkes, C., Holte, A., Geiger, W.F. 1999. Heavy Metal Retention within a Porous Pavement Structure. Proceedings of the Eighth International Conference on Urban Storm Drainage, Sydney, Australia, August 30-September 3.

Structure	Hydraulic	Maintenance	Other
	<input checked="" type="checkbox"/>		

B4.2.1 Focus of the Project

Concrete pavers with four different subbase materials were tested under laboratory conditions to determine the performance of the permeable pavement structure with respect to metal retention. Sand was used as the fill material between the pavers, which were placed on a bed of pea gravel. A 39 cm deep subbase consisting of various crushed stones (0 to 4.5 cm in size) supported the pea gravel and pavers.

Four hundred centimeters of synthetic runoff (pH = 5) that represented 5 years of rainfall was applied to the pavements. The synthetic runoff was dosed with metals to 10 times typical runoff concentrations found in the literature (specific references not given). Metal concentrations were 180 µg/l Pb, 470 µg/l Cu, 660 µg/l Zn and 30 µg/l Cd. Effluent samples were collected and analyzed to determine the retention of metals in the pavement system.

B4.2.2 Hydrology and Water Quality Performance

In most of the structures, metal concentrations in effluent did not reach German limits (not specified) for seepage water after simulation of 50 years. Concentrations for cadmium and copper, however, did reach regulatory limits when coarse (> 5 mm) materials were used in the subbase. Results are shown in Table B4-1 below.

	lead	cadmium	copper	zinc
synthetic runoff	180 µg/l	30 µg/l	470 µg/l	660 µg/l
effluent (mean conc.)				
gravel	< 4 µg/l	0,7 µg/l	18 µg/l	19 µg/l
basalt	<4 µg/l	0,7 µg/l	16 µg/l	18 µg/l
limestone	< 4 µg/l	3,2 µg/l	29 µg/l	85 µg/l
sandstone	< 4 µg/l	10,5 µg/l	51 µg/l	178 µg/l
retention				
gravel	98 %	98 %	96 %	97 %
basalt	98 %	98 %	96 %	98 %
limestone	98 %	88 %	94 %	88 %
sandstone	89 %	74 %	89 %	72 %
limits for seepage	25 µg/l	5 µg/l	50 µg/l	500 µg/l

Figure B4-1. Influent and effluent concentrations of metals in the synthetic runoff with corresponding percent retentions (Dierkes et al. 1999).

Most of the metals were precipitated in the upper two centimeters of the pavement. In theory, these metals could be mobilized by acidified rainfall/runoff but, due to the buffering capacity of the pavement, it was concluded this would not occur.

B4.3 Brattebo and Booth (2003). Long-term stormwater quantity and quality performance of permeable pavement systems

Brattebo, B.O., Booth, D.B. 2003. Long-term stormwater quantity and quality performance of permeable pavement systems. *Water Research*, 37(18):4369–4376.

Structure	Hydraulic	Maintenance	Other
<input checked="" type="checkbox"/>	<input checked="" type="checkbox"/>		

B4.3.1 Focus of the Project

Brattebo and Booth (2003) investigated the long-term performance of four commercially available permeable pavers (Grasspave®, Gravelpave®, Turfstone®, UNI Eco-Stone®) used in a parking lot. After six years of daily use the pavers were assessed for structural durability, infiltration capacity, and impact on infiltrated water quality. The study site was located in the Pacific Northwest, which typically has low intensity rainfalls and was not subject to extended periods of below freezing temperatures.

B4.3.2 Structural Design Performance

None of the four pavers investigated showed signs of structural wear or failure.

B4.3.3 Hydrology and Water Quality Performance

Almost all of the rainwater reaching the pavers infiltrated through the pavement. Infiltrated runoff had significantly lower levels of copper (Cu) and zinc (Zn) than the runoff from the

adjacent asphalt parking area. In all samples but four, concentrations of Cu and Zn in infiltrated water were below toxic levels whereas almost all runoff samples had Cu and Zn concentrations above toxic levels. Toxic levels were not listed or defined in Brattebo and Booth (2003). Complicating matters further is the fact that some toxic levels are based on other water quality parameters (e.g. pH) and the fact that the definitions of toxic levels or how they are determined may have changed since the time of publication. Hardness and conductivity of the infiltrated water was higher than surface runoff concentrations.

Compared to infiltrated water collected five years before the study of Brattebo and Booth (2003), the most recent infiltrated water samples had significantly lower concentrations of Zn but higher concentrations of Cu and Pb. Although motor oil was found in 89% of the runoff samples from the asphalt area, no samples of infiltrated water were found to contain motor oil. Finally, no samples of runoff or infiltrated water were found to contain diesel fuel.

B4.4 Bean et al. (2004). Study on the surface infiltration rate of permeable pavements

Bean, E.Z., Hunt, W.F., Bidelspach, D.A., Burak, R.J. 2004. Study on the surface infiltration rate of permeable pavements. Proceedings of the 1st Water and Environment Specialty Conference of the Canadian Society for Civil Engineering, Saskatoon, Saskatchewan, Canada, June 2-5.

Structure	Hydraulic	Maintenance	Other
	<input checked="" type="checkbox"/>	<input checked="" type="checkbox"/>	

B4.4.1 Focus of the Project

The focus of this project was to assess the surface infiltration rate of twenty-seven permeable pavement sites ranging in age from 6 months to 20 years old. Sites consisted of concrete grid pavers and permeable interlocking pavers in North Carolina, Maryland, and Delaware. One site in North Carolina was monitored to assess its pollution retention performance. Also, 14 concrete grid pavers were tested twice for infiltration capacity to determine the effect of simulated maintenance. One test was before removal of a top layer of residue that was 1.3 to 1.9 cm thick and the other after removal of the residue layer, which simulated maintenance.

B4.4.2 Hydrology and Water Quality Performance

The permeable interlocking concrete paver sites that were close to areas with loose fine particles were found to have infiltration capacities of 61 cm/hr, which was significantly less than sites not exposed to loose fines (2000 cm/hr). The minimum infiltration rates were, however, comparable to a grassed, sandy loam soil.

Only six rainfall/runoff events were monitored on the site in North Carolina and only zinc concentrations were significantly reduced by the permeable pavement.

Bean et al. (2004) suggested that permeable pavements can significantly reduce runoff volumes if the following conditions are met:

1. The site has underlying sandy or loamy sand soil,
2. There is not a seasonally high water table,
3. The pavement is regularly maintained,
4. The pavement is properly constructed with proper materials,
5. The pavement surface is flat and not near disturbed clayey soils,
6. The pavement does not bear overburdening loads.

B4.4.3 Maintenance Performance

The simulated maintenance (i.e. removal of a top layer of sediment) increased the infiltration capacity on 13 of the 14 sites and statistical analysis showed that it did so at a confidence level of 99.8%. The median average infiltration rate increased from 5.0 cm/hr to 8.0 cm/hr due to simulated maintenance (as previously defined). The authors concluded that maintenance is a critical issue when trying to maintain the infiltration capacity of concrete grid pavers. In general, the permeable interlocking concrete pavers should not be installed in an area with possible erosion of fine particles. Additional maintenance guidelines suggested by Bean et al. (2004) were as follows:

1. For concrete grid pavers filled with sand, the surface should be vacuum swept at least once per year and,
2. After removing debris that has accumulated within the void spaces (shown to be effective for 1.3 cm of material), the spaces should be backfilled with sand.

B4.5 Burak (2004). Permeable Interlocking Concrete Pavements - Selection, Design, Construction and Maintenance

Burak, R.J. 2004. Permeable Interlocking Concrete Pavements - Selection, Design, Construction and Maintenance. Proceedings of the 2004 Annual Conference and Exhibition of the Transportation Association of Canada. 2004. pp. 17.

Structure	Hydraulic	Maintenance	Other
<input checked="" type="checkbox"/>			

B4.5.1 Focus of the Project

The focus of this project was to evaluate the use of permeable interlocking concrete pavements as a structural stormwater management device that also impacts water quality. The discussion includes the selection of the pavement cross-section based on stormwater management goals along with criteria for design, construction, and maintenance.

B4.5.2 Mix Design and Structural Design Performance

Burak (2004) recommends permeable interlocking concrete pavers at sites that meet the following criteria:

1. The surface slope is at least 1%,

2. The depth from the bottom of the pavement system to the high water level is at least 0.6 m (or perhaps more for water quality improvement),
3. The drainage area is less than 2 hectares,
4. There is a plan to maintain the pavement surface on regular basis,
5. The site is not a stormwater "hot spot" (e.g. an industrial site that generates hazardous materials, etc.),
6. The pavement is down slope of building foundations with piped drainage.

Permeable pavements can be designed to temporarily store stormwater and, overtime, have that water infiltrate into the natural underlying soils (i.e. exfiltration). Under some conditions, exfiltration should not be included in the design. A design with no exfiltration should be considered under the following conditions:

1. When the bottom of the base is within 0.6 m of the high water table level,
2. When the depth of underlying soil is not enough to sufficiently treat polluted water,
3. When the pavement is directly over solid rock,
4. Where underlying aquifers may be contaminated by stormwater,
5. Over fill soils that will change (e.g. expand) when exposed to water.

With regards to percent impervious, a common error is to assume that the percent of open surface area is equal to the percent that is pervious. For example, assuming that a surface that is 18% open is also 18% pervious and 82% impervious is incorrect. The pervious fraction and amount of infiltration depends on the infiltration rate of the material in the joints, the bedding layer, and the base materials (not the percent of open surface area).

Recommended base material is usually open graded base conforming to ASTM No. 57 crushed aggregate. Some have found that using a larger aggregate (2 to 3 inch) offers better constructability because the larger aggregate provides more support for construction traffic. Whatever aggregate is used it should have a minimum of 90% crushed faces, a LA abrasion value of less than 40, a California Bearing Ratio (CBR) of at least 80%, and a porosity no lower than 32%.

A bedding coarse of No. 8 aggregate is usually placed over the top of the base material (e.g. ASTM No. 57 aggregate) to help stabilize the irregular surface.

B4.5.2.1 Design Consideration for Cold Climates

Special consideration must be given when using permeable interlocking concrete pavers in cold climates because of the possibility of large volumes of snow melt that may occur rapidly.

Guidelines for use in such climates follow:

1. Permeable interlocking concrete pavers should not be used in permafrost areas,
2. Stockpiles of sand and salt should be kept away from pavers,
3. If salts are applied, groundwater should be monitored,

4. If sand is applied, inspection and maintenance (i.e. vacuuming) must occur regularly,
5. When frost penetration is greater than 1 m, parking lots with the pavers should be set back from the subgrade of adjacent roads 6m or more to avoid frost heaving and frost lenses under the roadway,
6. A 1 to 2% slope should be considered as an overflow factor of safety.

B4.6 Gilbert and Clausen (2006). Stormwater runoff quality and quantity from asphalt, paver, and crushed stone driveways in Connecticut

Gilbert, J.K., Clausen, J.C. 2006. Stormwater runoff quality and quantity from asphalt, paver, and crushed stone driveways in Connecticut. *Water Research*, 40(4):826-832.

Structure	Hydraulic	Maintenance	Other
	<input checked="" type="checkbox"/>		

B4.6.1 Focus of the Project

The focus of this project was to compare the quality and quantity of stormwater runoff produced from replicated conventional asphalt, permeable paver, and crushed-stone driveways. Rainfall and runoff were measured and flow-weighted composite samples were analyzed once a week for water quality parameters (total suspended solids, total Kjeldahl nitrogen, nitrate-nitrogen, ammonia-nitrogen, total phosphorus, copper, lead, zinc). Also, the annual infiltration rate on each surface was determined.

B4.6.2 Hydrology and Water Quality Performance

As expected, the conventional asphalt driveway generated the most runoff volume and the crushed-stone driveway the least. The average infiltration rates for the asphalt, paver, and crushed-stone pavements were 0, 11.2, and 9.0 cm/hr, respectively. The infiltration rates for the permeable surfaces decreased slightly over the study, most likely due to fine particle clogging. Compared to the asphalt pavement, the permeable paver runoff contained significantly lower concentrations of all pollutants. Runoff pollutant concentrations from the crushed-stone surface were similar to those of the asphalt surface except for total phosphorus, which was higher in the asphalt runoff. The pollutant mass loading from each pavement corresponded to the volume of runoff from each pavement, not the concentrations.

B4.7 Haselbach et al (2006). Permeability predictions for sand-clogged Portland cement pervious concrete pavement systems

Haselbach, L.M., Valavala, S., Montes, F. 2006. Permeability predictions for sand-clogged Portland cement pervious concrete pavement systems, *Journal of Environmental Management*, 81(1): 42–49.

Structure	Hydraulic	Maintenance	Other
	<input checked="" type="checkbox"/>		

B4.7.1 Focus of the Project

This laboratory study was performed to investigate the clogging of a pervious concrete pavement (not including subbase, etc.) due to the application of fine sand on the surface layer. A theoretical relationship between the effective permeability of a pervious concrete layer clogged with sand, the permeability of sand, and the porosity of the unclogged pervious concrete layer was derived. Using simulated rainfalls, the permeabilities of pervious concrete systems that were covered with extra fine sand (from 1.3 to 5.0 cm thick) were measured. Concrete slopes of 2% and 10% were tested and simulations were performed for a direct rainfall only scenario and a scenario that included additional runoff from adjacent areas.

B4.7.2 Hydrologic (infiltration Capacity) Performance

A layer of pervious concrete typically can pass water at 0.2 cm/s and fine sand can do so at 0.02 cm/s. The experimentally determined rate for the pervious concrete covered by a layer of extra fine sand was 0.004 cm/s, which is similar to the 100 year, 30 minute duration rainstorm in the southeastern United States. Both the 2% and 10% sloped sections of pervious concrete clogged with sand generated no significant runoff from simulated rainfall events corresponding to return periods of up to 100 years and with direct rainfall only. For scenarios representing runoff from adjacent areas, runoff was observed. Overall, experimental results matched those predicted by the derived theoretical relationship.

B4.8 Yang et al (2006). Influence of Moisture Conditions on Freeze and Thaw Durability of Portland Cement Pervious Concrete

Yang, Z., Brown, H., Cheney, A. 2006. Influence of Moisture Conditions on Freeze and Thaw Durability of Portland Cement Pervious Concrete. *Proceedings of Concrete Technology Forum: Focus on Pervious Concrete*, May 24-25, 2006, Nashville, Tennessee, 15pp. Available at:

Structure	Hydraulic	Maintenance	Other
<input checked="" type="checkbox"/>			

B4.8.1 Focus of the Project

The focus of this project was to investigate the effect of moisture conditions on the freeze-thaw durability of pervious concrete. Pervious concrete specimens were preconditioned to different moisture conditions using vacuum saturation and then exposed to rapid freeze-thaw cycles. Freeze-thaw damage was assessed by measuring the mass of material lost.

B4.8.2 Mix Design and Structural Design Performance

Pervious concrete that was vacuum saturated before being subjected to freeze-thaw conditions in water had the lowest durability. Specimens that were sealed and frozen and then thawed in air had higher freeze-thaw durability. Specimens with the highest durability were those that were subject to freeze-thaw cycles in air under sealed conditions and that were not subject to vacuum saturation. These specimens, however, experienced a significant drop in freeze-thaw durability when subject to freeze-thaw cycling in water.

Vacuum saturated pervious concrete lasted 100 cycles but, in similar testing on traditional concrete, such concrete failed at about 13 cycles. When both concretes were partially saturated before freeze-thaw cycling, however, the pervious concrete had a much lower durability.

B4.9 Boving et al (2008). Potential for localized groundwater contamination in a porous pavement parking lot

Boving, T.B., Stolt, M.H., Augenstern, J., Brosnan, B., 2008. Potential for localized groundwater contamination in a porous pavement parking lot setting in Rhode Island, *Environmental Geology*, 55(3):571-582.

Structure	Hydraulic	Maintenance	Other
	<input checked="" type="checkbox"/>	<input checked="" type="checkbox"/>	

B4.9.1 Focus of the Project

Boving et al. (2008) investigated the impact of infiltrated stormwater pollutants (organic, inorganic, and bacteria) on groundwater immediately below a porous asphalt parking lot. The performance of the pavement, including the effect of clogging, was also investigated.

To investigate the impact on water quality, deep and shallow sampling ports were installed below low and high traffic areas of the porous asphalt and one sampling port was installed just outside the lot. Shallow ports were well connected to the surface, at least initially, but flow to the deep ports appeared to be obstructed by a geotextile layer at the base of the lot.

B4.9.2 Hydrology and Water Quality Performance

Lower infiltration rates were observed in high traffic areas and under snow storage areas. Sand brought in to the lot by cars was identified as the main cause of low infiltration rates. Bacteria and biochemical oxygen demand (BOD) was not found in any infiltrated water and average polycyclic aromatic hydrocarbons (PAH) concentrations were found to be about 2 µg/L, which was near the detection limit.

Nitrate and phosphate from the porous asphalt surface leached into the ground at a rate of 0.45–0.84 g/m²-year. A multi-species tracer test was used to determine the retention capacity of the porous asphalt system to be 90% for metals and 27% for nutrients.

Contaminant concentrations observed in water samples taken below the pavement varied with the season. Higher nitrate and phosphorus concentrations were observed during the spring and fall (periods of fertilizer application) while metal and chloride concentrations were higher in later winter and early spring (periods of high road salt application). Additional hydrology and water quality performance results were:

1. Comparing PAH flux through the porous asphalt parking lot system to fluxes observed on conventional roads in the region and the results of a tracer study indicate that the porous pavement structure removes PAH's or at least impedes or retards PAH transport,

2. Tracer tests indicate that contaminant concentrations are reduced as water infiltrates through the pavement structure,
3. A geotextile layer below the pavement restricted or impeded the infiltration of water to lower depths. This most likely resulting in flow channelization in or beneath the pavement which, in turn, could increase the potential for groundwater contamination.

B4.9.3 Maintenance Performance

Most particle-bound pollutants appeared to be entering the system by deposition of dust suggesting that fluxes to groundwater could be reduced by more frequent and/or effective sweeping or vacuuming. Sweeping, however, will not reduce the transport of chloride from melting snow and ice that enters the parking lot via vehicular traffic.

B4.9.4 Recommendations for Future Research Suggestions

The following suggestions were made for areas of future research:

1. Although contaminant concentrations were reduced as water infiltrated through the pavement structure, more research is needed to determine what caused the reduction (i.e. asphalt, trapped particles, etc.),
2. The lot investigated was relatively new (between 1-3 years at the time of the study). Monitoring should continue to determine the long-term performance of the pavement structure.

B4.10 Gonzalez-Angullo et al (2008). Runoff Infiltration to Permeable Paving in Clogged Conditions.

González-Angullo, N., Castro, D., Rodríguez-Hernández, J., Davies, J.W. 2008. Runoff infiltration to permeable paving in clogged conditions. Urban Water Journal, 5(2):117-124.

Structure	Hydraulic	Maintenance	Other
	<input checked="" type="checkbox"/>		

B4.10.1 Focus of the Project

The objectives of this project were to 1) analyze the effects of clogging on the infiltration capacity of permeable pavements, and 2) determine the runoff resistance (i.e. percentage of water infiltrating within the pavement length) of a specific permeable surface when clogged with a specific silt. The pavers were 200 mm by 100 mm with vertical slots along the edges and were sloped downward at 2%. They were also clogged with construction debris.

B4.10.2 Hydrologic Performance

Although sloped at 2% and clogged with construction debris, the pavers still allowed significant infiltration to occur. More specifically, 81% of a 50 mm/hr rainfall was infiltrated and at least 90% of a 25 mm/hr rainfall would be expected to infiltrate.

B4.11 Kevern et al (2008). Pervious Concrete in Severe Exposures

Kevern, J.T., Wang, K., Schaefer, V.R. 2008. Pervious Concrete in Severe Exposures. Concrete International, 30(7):unknown pages.

Structure	Hydraulic	Maintenance	Other
<input checked="" type="checkbox"/>			

B4.11.1 Focus of the Project

The effect of nine parameters on the freeze-thaw resistance of pervious concrete was investigated. Investigated parameters were fine aggregate content, fiber content, water:cement ratio, level of compaction, air content, fly ash replacement, silica fume replacement, addition of latex polymers, and coarse aggregate type.

For all mixes the cementitious material:aggregate ratio was 0.21, the coarse aggregate was narrowly graded rounded river or pea gravel (except for mixes used to determine the effect of coarse aggregate). Typically, pea gravel grading had 100% passing the 0.375 inch sieve, 87% retained on the No. 4 sieve, and its specific gravity was 2.62. Also, except for mixes used to determine the effect of water:cement ratio, this ratio was fixed at 0.27.

B4.11.2 Mix Design and Structural Design Performance

The research study performed by Kevern et al. (2008) resulted in the following conclusions and suggestions:

1. About 7% by mass of the coarse aggregate should be replaced with fine aggregate,
2. Polypropylene fibers should be added to the mix (especially to mixes without sand),
3. Use a water:cement ratio close to 0.32 to improve workability and density,
4. Increase compaction (and lower porosity),
5. Air should be entrained to increase paste volume and improve workability,
6. When cement is replaced with fly ash it may lower freeze-thaw resistance,
7. Fly ash replacement, if used, should be no more than 10%,
8. To improve workability and resistance to freeze-thaw cycling, cement material may be replaced with up to 5% silica fume. If more than 5% is used the mix may become too dry and not compactable. This will lower freeze-thaw resistance,
9. Latex admixtures can improve freeze-thaw resistance if appropriate curing procedures are followed (i.e. wet curing and allowed to dry before testing),
10. Not allowing the concrete to dry before freezing can lower freeze-thaw resistance,
11. Freeze-thaw resistance is lowered by increased aggregate adsorption.

B4.12 Kevern et al (2009). Temperature Behavior of Pervious Concrete Systems

Kevern, J.T., Schaefer, V.r., Wang, K. 2009. Temperature Behavior of Pervious Concrete Systems. Journal of the Transportation Research Board, 2098:94-101.

Structure	Hydraulic	Maintenance	Other
			<input checked="" type="checkbox"/>

B4.12.1 Focus of the Project

This project determined temperature behavior of a pervious concrete parking lot. To do this a parking lot that was one-half pervious concrete and one-half traditional concrete was constructed. Temperature sensors were installed under each pavement (and down into the soil) that enabled temperature profiles to be recorded.

B4.12.2 Hydrology and Water Quality Performance

Insulation from the aggregate base under the pervious concrete delayed the formation of the frost layer. Also, permeability was restored when meltwater was present. When exposed to direct sunlight the pervious pavement became hotter than the traditional concrete but the daily low temperature of the two types of concrete was similar. Thus, the pervious concrete had less heat storage capacity.

Additional findings from Kevern et al. (2009) were as follows:

1. Air in the aggregate base acted as an insulating layer and higher latent heat (associated with higher moisture content soils) delays or eliminates frost formation,
2. When ambient air temperatures are much below freezing, temperatures in the middle of the pervious concrete are much warmer. This suggest that the concrete surface was even warmer and may have been above freezing when ambient air temperatures were too cold for deicers to function as desired,
3. Thawing of pervious concrete systems occurs more quickly as compared to traditional concrete,
4. The maximum temperature difference between pervious pavement and the ambient air occurred during the hottest conditions,
5. The maximum temperature difference between the pervious and standard pavements occurred during moderate conditions (60 °F to 85 °F).

Pervious concrete demonstrated a more rapid heating and cooling cycle as compared to traditional concrete. Daily low pervious concrete temperatures were as low as or lower than traditional concrete.

B4.13 Roseen et al. (2009). Seasonal Performance Variations for Storm-Water Management Systems in Cold Climate Conditions

Roseen, R.M., Ballesteros, T.P., Houle, J.J., Avellaneda, P., Briggs, J., Fowler, G., Wildey, R. 2009. Seasonal performance variations for storm-water management systems in cold climate conditions. Journal of Environmental Engineering, 135(3):128-137.

Structure	Hydraulic	Maintenance	Other
	<input checked="" type="checkbox"/>		<input checked="" type="checkbox"/>

B4.13.1 Focus of the Project

Six different low impact development (LID) designs at the University of New Hampshire Stormwater Center, including porous asphalt, were tested and monitored for two years (and 27 runoff events) to assess winter performance. Water quality performance of porous asphalt with respect to selected pollutants or water quality parameters is summarized herein.

B4.13.2 Water Quality Performance

Influent and effluent samples were analyzed for total suspended solids (TSS), total petroleum hydrocarbons-diesel (TPH-D), dissolved inorganic nitrogen (DIN, comprised of nitrate, nitrite, and ammonia), total phosphorous (TP), and total zinc (TZn). Performance differences between winter and summer seasons were determined by grouping data according to the month of collection (May to October = Summer, November to April = Winter).

Two performance measures were calculated:

1) Removal Efficiency (RE) = $1 - (\text{EMC}_{\text{Outlet}} / \text{EMC}_{\text{Inlet}})$, and the values given are the median of all corresponding values, and

(2) Efficiency Ratio (ER) = $1 - (\text{average of EMC}_{\text{outlet}}) / (\text{average of EMC}_{\text{inlet}})$.

Results for the porous asphalt test section are given in Table B4-1.

Table B4-1. Seasonal performance of porous asphalt (Roseen et al. 2006)

Analyte	Annual		Summer		Winter	
	ER (%)	RE (%)	ER (%)	RE (%)	ER (%)	RE (%)
TSS	96	100	91	97	100	100
TPH-D	100	100	99	100	100	100
DIN	-35	—	-62	—	-22	-45
TZn	79	96	77	96	81	95
TP	24	38	-17	-49	66	57

Roseen et al. (2006) concluded that, with respect to the contaminants that were investigated, the porous asphalt had a high level of performance (except for dissolved nitrogen) during the winter and performance will not be reduced by frozen filter media.

B4.14 Tyner et al (2009). Increasing exfiltration from pervious concrete and temperature monitoring.

Tyner, J.S., Wright, W.C., Dobbs, P.A. 2009. Increasing exfiltration from pervious concrete and temperature monitoring. *Journal of Environmental Management*, 90(8):2636-2641.

Structure	Hydraulic	Maintenance	Other
	<input checked="" type="checkbox"/>		<input checked="" type="checkbox"/>

B4.14.1 Focus of the Project

The focus of Tyner et al. (2009) study was to investigate different methods of treating an underlying clayey soil in order to maximize the infiltration capacity of a pervious concrete system.

Four types of treatments were applied to the underlying clay soil prior to placement of the stone aggregate base and pervious concrete. The treatments were: (1) control – no treatment; (2) trenched – soil was trenched and backfilled with stone aggregate; (3) ripped – soil was ripped with a subsoiler; and (4) boreholes – shallow boreholes were drilled and backfilled with sand.

B4.14.2 Hydrology and Water Quality Performance

The average exfiltration rates were 0.8 cm/d (0.3 in/d) for the control, 4.6 cm/d (1.8 in/d) for the borehole, 10.0 cm/d (3.9 in/d) for the ripped, and 25.8 cm/d (10.2 in/d) for the trenched treatment. The trenched treatment exfiltrated water the fastest, followed by the ripped and then the borehole treatments. Results for the ripped and borehole treatments, however, were not different from one another at the 5% level of significance. In summary, while all treated soils could sufficiently drain collected water in 3 days or less and the control (i.e. untreated soil) could not, the trenched soil exhibited superior infiltration capacity. Also, there was no variation in infiltration capacity with time over the course of the study (fall 2006 through summer 2007).

The study also monitored the temperature and water content within pores of the concrete. The temperature in the concrete dropped below freezing 24 times over the winter but, when temperatures were at freezing or below, there was never any free water in the pores of the pervious concrete. Also, the temperature of the concrete lagged behind the air temperature with a dampened amplitude.

B4.15 Chopra et al (2010). Effect of Rejuvenation Methods on the Infiltration Rates of Pervious Concrete Pavements

Chopra, M., Kakuturu, S., Ballock, C., Spence, J., Wanielista, M. 2010. Effect of Rejuvenation Methods on the Infiltration Rates of Pervious Concrete Pavements. *Journal of Hydrologic Engineering*, 15(6):426-433.

Structure	Hydraulic	Maintenance	Other

	<input checked="" type="checkbox"/>	<input checked="" type="checkbox"/>	
--	-------------------------------------	-------------------------------------	--

B4.15.1 Focus of the Project

The focus of this project was to investigate the hydraulic performance of pervious concrete using the cores of both surface pavement and underlying soils in both a laboratory and field settings. Also, the effectiveness of maintenance actions in regards to restoring hydraulic performance was assessed.

B4.15.2 Hydrologic (Infiltration Capacity) Performance

Infiltration rates from pervious concrete cores ranged from 0.4 in/hr to 227.2 in/hr and soil infiltration rates ranged from zero to 34.5 in/hr. Data suggested that either the pervious concrete or the underlying soil, or both, may become partially or totally clogged. Furthermore, the data suggests that the pervious concrete, even with its open pore structure, is just as likely to become clogged as the underlying soil.

B4.15.3 Maintenance Performance

Maintenance can restore hydraulic performance of pervious concrete surfaces that have become clogged. Pressure washing was more effective than vacuum sweeping and in some cases vacuum sweeping was not able to dislodge and/or remove some material that caused clogging. The pressure to be used during pressure washing should be given careful consideration because an excessively high pressure may push some particles towards the groundwater.

The authors suggest that the installation of infiltrometers at suitable locations during new construction would be very helpful for monitoring the performance of pavements. The application of these techniques will result in better management of stormwater and pollution prevention. Further detailed investigations are needed for studying the mechanism of clogging and the mechanism of rejuvenation considering the pore structure of pervious concrete.

B4.16 Collins et al (2010). Side-by-side comparison of nitrogen species removal for four types of permeable pavement and standard asphalt in eastern North Carolina

Collins, K.A., Hunt, W.F, Hathaway, J.M. 2010. Side-by-side comparison of nitrogen species removal for four types of permeable pavement and standard asphalt in eastern North Carolina, Journal of Hydrologic Engineering, 15(6), 512-521.

Structure	Hydraulic	Maintenance	Other
	<input checked="" type="checkbox"/>		

B4.16.1 Focus of the Project

Four permeable pavements and a conventional asphalt pavement were monitored for seven months to determine the performance of each with respect to stormwater runoff quality. The permeable pavements investigated were pervious concrete, two permeable interlocking concrete

pavers (joints filled with small aggregate), and a concrete grid paver filled with sand. Due to poorly draining native soils at the site, all systems included a crushed stone subbase that contained a perforated drain pipe. One paver system had 12.9% open surface area and the other had 8.5%.

Composite, flow-weighted samples of runoff discharged from the permeable pavement systems were analyzed for pH, total nitrogen, nitrite/nitrate nitrogen, ammonium, and organic nitrogen concentrations and loads.

B4.16.2 Hydrology and Water Quality Performance

Acid rainfall was buffered by all pavements. The pH of the permeable pavement effluent was higher than runoff from the asphalt pavement with pervious concrete having the highest pH. Ammonium and total Kjeldahl nitrogen concentrations corresponding to the permeable pavements were lower than those corresponding to traditional asphalt. Except for the concrete grid pavers, however, the nitrite/nitrate concentrations corresponding to the permeable pavers was higher than that of the asphalt pavement. The authors attributed this to nitrification occurring in the permeable pavement system. The concrete grid paver system had the lowest overall total nitrogen concentrations, although they were not statistically different than that of traditional asphalt.

Collins et al. (2010) also concluded:

1. All four permeable pavements performed similarly with respect to nitrogen removal,
2. Concrete grid pavers appear to reduce total nitrogen concentrations and most likely act similar to a sand filter treatment.

B4.16.3 Recommended Research Topic for Future Investigation

Collins et al. (2010) suggested that the underlying soils need to be isolated from the permeable pavement systems in order to investigate and gain a better understanding of the water quality response within the pavement system.

B4.17 Rowe et al (2010). Permeable Pavement Demonstration at the Edison Environmental Center

Rowe, A.A., Borst, M., O'Connor, T.P., Stander, E. 2010. Permeable pavement demonstration at the Edison Environmental Center, Proceedings of the 2010 International Low Impact Development Conference-Redefining Water in the City, San Francisco, USA, April 11-14, pp. 139-151.

Structure	Hydraulic	Maintenance	Other
	<input checked="" type="checkbox"/>		<input checked="" type="checkbox"/>

B4.17.1 Focus of the Project

A 110 space parking lot in New Jersey consisted of three sets of parking rows. The stalls of each row were surfaced with either porous asphalt, pervious concrete, or permeable interlocking

concrete pavers such that each of the three rows consisted of only one of the three permeable pavers. Samples of runoff that infiltrated each of the permeable pavements were collected below the pavement surface to determine the impact each pavement type had on water quality. Water quality parameters that were investigated were temperature, solids, indicator organisms, nutrients, metals, semi-volatile organic compounds. Total runoff volume was also determined. Also, attempts were made to assess how the performance of the pavements changed with time and the effects of maintenance.

The porous asphalt and pervious concrete pavements consisted of the surface pavement layer on top of a layer of 7.6 cm sized recycled concrete aggregate with a non-woven, needle punched geotextile fabric on the soil interface. The concrete pavement system consisted of 0.95 cm aggregate below the pavers and on top of a 1.6 cm stone choking layer. The choking layer was on top of a 7.6 cm sized recycled aggregate and non-woven, needle punched geotextile.

B4.17.2 Water Quality Performance

Results in Rowe et al. (2010) were very preliminary and only contained temperatures of the permeable concrete pavement itself and water content in the recycled concrete aggregate layer, which was deemed to be inaccurate. Temperature of all three permeable pavements in the parking stalls and traditional asphalt in the driving lanes all followed the air temperature, which peaked at 17°C. The concrete pavers reached the coolest temperature of all pavements but then warmed up to over 30° C, as did the porous asphalt. Overall, porous concrete was the coolest at a maximum temperature of about 21°C and traditional asphalt was the hottest at over 33°C. A temperature profile over a one-day period in October 11, 2009 is shown in Figure B4-2.

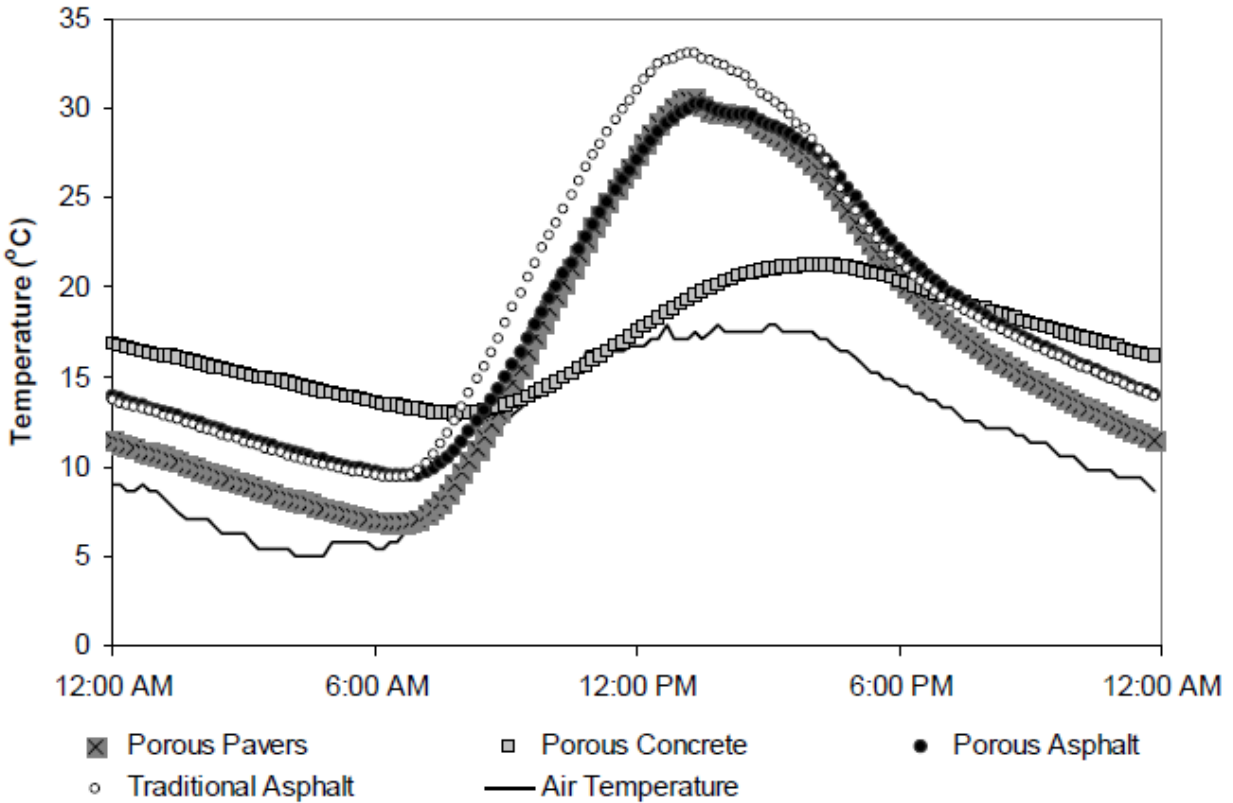

Figure B4-2. Average temperature readings at the surface of each permeable pavement and overlying air temperature (Rowe et al. 2010).

B4.18 Ravindrarajah and Yukari (2010). Environmentally friendly concrete for sustainable construction

Ravindrarajah, S., Yukari, A. 2010. Environmentally friendly concrete for sustainable construction. Proceedings from the 35th Conference on OUR WORLD IN CONCRETE & STRUCTURES: 25 - 27 August 2010, Singapore.

Structure	Hydraulic	Maintenance	Other
<input checked="" type="checkbox"/>			

B4.18.1 Focus of the Project

Experiments were performed to investigate the properties of pervious concrete with varying amounts (0, 20, and 50%) of low calcium fly ash in the mix (as cement replacement). The concrete properties investigated were porosity, unit weight, compressive strength, weight loss on drying, free drying shrinkage, and infiltration capacity.

B4.18.2 Mix Design and Structural Design Performance

It was determined, as with multiple other studies, that porosity has a significant effect on compressive strength and infiltration capacity. Replacing cement with fly ash by up to 50% had no significant effect on infiltration capacity and shrinkage. A slight effect on strength, however, was observed.

Higher porosity resulted in lower compressive strength and higher infiltration capacity. Results from the study were in agreement with other published reports that documented a linear relationship between strength and porosity and infiltration capacity and porosity for pervious concrete with porosities between 15 and 30%. Also, dimensional stability (due to drying shrinkage) increased with increasing amounts of fly ash. The authors concluded that an environmentally friendly and sustainable pervious concrete pavement could be produced by replacing a portion of the Portland cement with fly ash.

B4.19 Schwartz (2010). Effective CN and hydrologic design of pervious concrete storm-water systems

Schwartz, S.S. 2010. Effective CN and hydrologic design of pervious concrete storm-water systems. Journal of Hydrologic Engineering, 15(6):465-474.

Structure	Hydraulic	Maintenance	Other
	<input checked="" type="checkbox"/>		

B4.19.1 Focus of the Project

Schwartz (2010) presented pervious concrete design criteria for freeze-thaw protection and water drawdown. Curve numbers (CN), which are used to quantify hydrologic performance, were estimated from routing of design storms using standard computational tools.

B4.19.2 Hydrology and Water Quality Performance

The design process presented by Schwartz (2010) used the 10 year return period storm with a drawdown (i.e. total infiltration) time of no more than 3 days (72 hrs). This design process is based on providing both freeze-thaw durability and drawdown in the desired time. The resulting hydrologic performance is evaluated and quantified by an effective CN.

In the process the design storm is routed through the pervious concrete system using typical stage-discharge relationships that incorporate the effective porosity of the concrete system. A constant infiltration rate is assumed and usually set equal to the long-term (or steady-state) infiltration rate typically defined as f_c in Horton's equation. Infiltration is also assumed to occur only vertically and only over the subbase voids.

Design variables include the porosity and depth of the subbase, areas of drainage, areas of exfiltration (infiltration into underlying soils), and the size and elevation of drains (if included).

In summary, the minimum design thickness (of subbase) required to satisfy freeze-thaw durability is the maximum water surface elevation obtained within the subbase when the design storm is routed through the system. The design is then characterized by determining the effective curve number (CN) for the system using NRCS (1986) curve number hydrology.

B4.20 Lucke and Beecham (2011). Field investigation of clogging in a permeable pavement system

Lucke, T., Beecham, S. 2011. Field investigation of clogging in a permeable pavement system. *Building Research and Information*, 39(6):603-615.

Structure	Hydraulic	Maintenance	Other
	<input checked="" type="checkbox"/>		

B4.20.1 Focus of the Project

An eight year old permeable interlocking concrete pavement system was investigated to quantify the sediment accumulation process that occurred in the pavement and provide a better understanding of how the sediment affected infiltration capacity. The system that was investigated had a ~30 mm deep bedding aggregate (2-5 mm diameter) layer under the pavers followed by a geotextile fabric, a subbase (20-63 mm aggregate), and another geotextile fabric on top of the subgrade (i.e. existing soil).

B4.20.2 Hydrology and Water Quality Performance

Investigation into sediment accumulation by layer revealed that most of the sediment was retained in the aggregate bedding layer that consisted of 2-5 mm sized aggregate whereas only 8.3% of the sediment (by weight) was retained by the geotextile. Combined, the bedding layer and paving layer accounted for over 90% of the trapped sediment. Sediment accumulation in the joints between the pavers varied significantly with location across the surface of the pavement.

Infiltration rates, obtained with a double-ring infiltrometer (or an inundation method for three locations with extremely high infiltration rates), were determined at 12 locations and ranged from 6 mm/hr to 13,230 mm/hr.

The following conclusions were drawn:

1. At all three test locations, a greater percentage of fines (defined as < 33 microns in diameter) was retained by the geotextile than in the bedding layer or in the aggregate in joints between the pavers,
2. Most of the sediment (by mass) was retained in the aggregate bedding layer (2-5 mm in diameter) and, based on the storage capacity of this layer, it is not likely that this layer will cause failure of the system,

3. Sediment retained in the paving layer varied, at most, by 56% but the infiltration rates varied by over 10^5 . The authors state that this supports the conclusions of others who found that infiltration rates can be restored by removal of the upper 20 mm of joint material,
4. Infiltration rate testing on excavated geotextile fabric revealed that even the most severely blocked geotextile could still infiltrate water at a much higher rate than the design rainfall event. Thus, clogging after eight years is unlikely to be caused by the geotextile,
5. Although the geotextile retained more fines than the other layers, 90% of the total sediment retained was found in the paving and bedding layers. This suggests that the inclusion of a geotextile layer may not be warranted in permeable pavement systems.

B4.20.3 Shu et al (2011). Performance comparison of laboratory and field produced pervious concrete mixtures

Shu, X., Huang, B., Wu, H., Dong, Q., Burdette, E.G. 2011. Performance comparison of laboratory and field produced pervious concrete mixtures. *Construction and Building Materials*, 25:3187–3192.

Structure	Hydraulic	Maintenance	Other
<input checked="" type="checkbox"/>	<input checked="" type="checkbox"/>		

B4.20.4 Focus of the Project

The focus of this project was to determine the influence of variables that impact air void content, infiltration capacity, split tensile strength, compressive strength, and freeze-thaw durability of pervious concrete pavement from laboratory produced mixes, field produced mixes, and field core samples. Concrete mixes contained either limestone or granite aggregate with either No. 8 or No. 89 gradings (according to ASTM C33). A latex, air-entraining admixture and a high range water reducer were also added to some mixes to determine their impact.

B4.20.5 Mix Design and Structural Design Performance

Results indicate that mixes with limestone aggregate and the latex admixture may result in pervious concrete with lower porosity and infiltration capacity but with higher strength and abrasion (or freeze-thaw) resistance. Some mixes with the latex admixture resulted in lower freeze-thaw resistance than those without. Thus, care must be taken when designing a pervious concrete mix but a latex admixture can improve performance. Also, the air entraining admixture led to mixes with significantly higher freeze-thaw resistance.

Shu et al. (2011) concluded that a properly designed and laboratory verified pervious concrete mix can meet field requirements for strength, durability, and infiltration capacity.

B4.21 Wu et al (2011). Laboratory evaluation of abrasion resistance of Portland Cement pervious concrete

Wu, H., Huang, B., Shu, X., Dong, Q. 2011. Laboratory evaluation of abrasion resistance of Portland Cement pervious concrete, Journal of Materials in Civil Engineering, 23(5):697-702.

Structure	Hydraulic	Maintenance	Other
<input checked="" type="checkbox"/>			

B4.21.1 Focus of the Project

The focus of the project was to determine the effect of adding latex and fibers to pervious concrete mixes in an attempt to improve abrasion resistance.

B4.21.2 Design Mix and Structural Design Performance

The addition of latex to the design mix increased the strength of pervious concrete and slightly reduced the void content. Adding fiber had little to no effect on the abrasion resistance or other mechanical properties.

Other findings from Wu et al. (2011) study were as follows:

1. The Cantabro and the asphalt pavement analyzer (APA) abrasion tests were effective in assessing the abrasion resistance of pervious concrete,
2. Weight loss and wear depth could be used as indicators of abrasion resistance in the APA test,
3. Mix designs with smaller aggregate had stronger mechanical properties and higher abrasion resistance compared to mixes with larger aggregates,
4. Potentially optimum properties of pervious concrete are 15-20% voids, infiltration capacity of 1-2 mm/s, and a compressive strength of 20-25 MPa,
5. The APA test is feasible for determining the abrasion resistance of pervious concrete.

B4.22 Yang (2011). Freezing and thawing durability of pervious concrete under simulated field conditions

Yang, Z., 2011. Freezing and thawing durability of pervious concrete under simulated field conditions. ACI Materials Journal, 108(2):187-195.

Structure	Hydraulic	Maintenance	Other
<input checked="" type="checkbox"/>			

B4.22.1 Focus of the Project

The focus of this project was to investigate the effect of mix design and curing conditions on the freeze-thaw durability of pervious concrete under simulated field conditions, including freeze-thaw cycles, wet-dry environments, and salt applications.

B4.22.2 Mix Design and Structural Design Performance

Yang (2011) found the following with regards to the freeze-thaw durability of pervious concrete.

1. Air cured specimens had a much lower freeze-thaw resistance than lime-saturated water cured specimens,
2. During slow freeze-thaw cycling silica fume additions increased the freeze-thaw durability of water cured specimens but significantly lowered the durability of air cured specimens,
3. Polypropylene fibers increased durability,
4. The application of salt decreased durability,
5. Wet-dry cycles slowed freeze-thaw damage when the wet cycle was less than three days.

B4.23 Chai, et al (2012). Paper on Permeable Highway Shoulders

Chai, L., Kayhanian, M., Givens, B., Harvey, J.T., Jones, D. 2012. Hydraulic performance of fully permeable highway shoulder for storm water runoff management. *Journal of Environmental Engineering*, 138(7):711-722.

Structure	Hydraulic	Maintenance	Other
	<input checked="" type="checkbox"/>	<input checked="" type="checkbox"/>	

B4.23.1 Focus of the Project

This paper summarizes the results of numerous simulations to assess the hydraulic performance of fully permeable highway shoulder retrofits designed to capture all the rainfall runoff falling onto conventional highway surface pavements. The simulations were performed using commercially available *HYDRUS* software that uses unsaturated flow theory. The hydraulic properties of subgrade soil and pavement materials were measured in the laboratory and used as input for numerical simulation. The simulations were performed for three rainfall regions in California representing high, medium and low annual rainfall events. The simulations were performed based on 24 hr actual rainfall data using 2-, 50-, and 100-year storm recurrences to determine the critical thickness of aggregate needed to capture the highway runoff volume without surface ponding and/or overflow. Sensitivity analyses were also performed to evaluate the influence of material, hydrologic, and geometric factors on the critical aggregate base thickness.

B4.23.2 Hydrologic Simulation Performance Results

The major findings of this study were:

1. Fully permeable highway shoulder retrofits can have sufficient hydraulic capacity to be used as an alternative best management practice (BMP) method to capture highway surface runoff. Approximately 0.13 m to 3.0 m of aggregate base thickness would be required to capture all of the rain falling onto the pavement over the course of a rainy season in any part of California,

2. Higher rainfall generally requires thicker aggregate bases and, as expected, the required minimum aggregate thickness in high rainfall regions is about 50 percent more than the minimum aggregate thickness required for medium rainfall areas. Similarly, longer recurrence periods (50- and 100-year) require thicker bases compared with 2-year periods. The change in aggregate thickness for 50 and 100 year recurrence periods was insignificant,
3. Subgrade soil saturated hydraulic conductivity is the most sensitive factor in a fully permeable pavement design and will dictate where this type of pavement can be used. Soil permeability lower than 10^{-5} cm/sec would require impractical pavement thicknesses. This value is typical of most clay soils in California,
4. Highway surface area, represented by a geometric parameter ρ ($\rho = 4$ means there are three highway lanes being drained) also impacts the minimum aggregate base thickness requirement. In most instances, an increase from two to four lanes increases the required aggregate thickness by 100 percent. The impact of this is obviously greater in areas of high rainfall,
5. The influence of the α and n van Genuchten model parameters were not significant when compared to the subgrade soil conductivity and geometry factors. The difference in levels of subgrade soil compaction was also less significant than subgrade soil conductivity and saturated soil moisture content,
6. The initial water content of the various layers (including the subgrade) must be factored into the calculation of critical aggregate base thickness. Failure to do this will result in potential overflows later in the rain season or during prolonged rainfall events. The critical aggregate thickness calculated for average layer moisture contents must typically be increased by about 80 percent to accommodate the design rainfall events over the rain season,
7. Fully permeable pavement designs should be based on a minimum of one-year simulations and not 24-hour simulations to limit the number of potential overflow events. Void contents in the surface and aggregate base course need to be carefully designed for actual storm events (not maximum possible permeability) to ensure a balance between permeability and structural bearing capacity. High void contents, although preferable for permeability, can lead to shorter pavement lives under traffic,
8. Fully permeable pavements need to be maintained (i.e., periodic vacuuming and prevention of debris flowing across the pavement) to ensure that the void space between particles is preserved, although results indicated that a severe reduction in permeability has to occur for the pavements to lose their functionality,

9. Modeling simulation results alone may not be used as a basis for designing a new or retrofitting permeable shoulder. For practical purpose, it is recommended to conduct pilot investigation using heavy vehicle simulators to verify the design depth and structural integrity of pavement under realistic load and traffic condition.

B4.24 Golroo and Tighe (2012a). Pervious Concrete Pavement Performance Modeling Using the Bayesian Statistical Technique

Golroo, A., Tighe, S.L., 2012a. Pervious Concrete Pavement Performance Modeling Using the Bayesian Statistical Technique. *Journal of Transportation Engineering*, 138(5):603-609.

Structure	Hydraulic	Maintenance	Other
			<input checked="" type="checkbox"/>

B4.24.1 Focus of the Project

A linear performance model to predict the service life of pervious concrete pavement was developed by integrating expert knowledge obtained through a survey (using the Markov-chain process) and experimental data (obtained by pervious concrete field investigations) through incorporation of the Bayesian technique. In the Bayesian technique the main concept is that both sets of information (i.e. expert knowledge and experimental data) are applied to estimate the posterior probabilities. The main purpose of the Bayesian method is to estimate the regression coefficient of parameters in the models.

B4.24.2 Structural Design (Modeling) Performance

The overall condition of the pervious concrete was quantified with an index called the pervious concrete distress index (PCDI), which, in theory, can range from zero to 10. A PCDI of zero indicates a pavement in very poor condition and a 10 indicates a pavement in very good condition. The equation generated by Golroo and Tighe (2012a) was:

$$PCDI = 8.989 - 0.607(T) \quad (4.1)$$

Where, T = the age of the pavement in years.

Using this model for a pervious concrete pavement with service life of 9 years, the calculated PCDI index is 3.5, which may be considered a fair to good.

B4.25 Golroo and Tighe (2012b). Pervious concrete pavement performance modeling: an empirical approach in cold climates

Golroo, A., Tighe, S.L., 2012b. Pervious concrete pavement performance modeling: an empirical approach in cold climates. *Canadian journal of civil engineering*, 39(10): 1100-1112.

Structure	Hydraulic	Maintenance	Other
			<input checked="" type="checkbox"/>

B4.25.1 Focus of the Project

Golroo and Tighe (2012b) incorporated laboratory and field work to develop empirical performance models to predict the condition of pervious concrete that are based on a condition index. The proposed condition index is a combination of two other indices, a surface distress index and a functional performance index. The performance models are developed in two phases using regression analysis. Sources of data include a panel rating and field investigations.

B4.25.2 Structural Design (Modeling) Performance

To develop the model a condition index, the pervious concrete condition index (PCCI) was developed. This index was developed by using laboratory and field data collected on cores, beams, and on *in situ* field points to determine distresses in the pavement, surface infiltration capacity, and performance condition. For details on this and other aspects of the model development see Golroo and Tighe (2009, 2011). As stated previously, the PCCI was a function of the surface distress index and a functional performance index.

Also, similar to Golroo and Tighe (2012a), a model to predict the PCDI was also developed.

$$PCDI = 8.825 - 0.384(T) \quad (4.2)$$

Where, T = the age of the pavement in years.

Using this model, the distress index of pervious concrete pavement with a service life of 12 years is estimated to be 4.2 which, is about average.

Golroo and Tighe (2012b) reached the following conclusions:

1. A 12 year service life of pervious concrete was estimated and the range can be expected to be 8 to 16 years (95% confidence interval),
2. If raveling were observed in a pervious concrete pavement, major maintenance should be expected in 7 years,
3. With regards to infiltration capacity, maintenance (pressure washing and/or vacuuming should occur at least every six years.

B4.26 Henderson and Tighe (2012). Evaluation of Pervious Concrete Pavement Performance in Cold Weather Climates

Henderson, V., Tighe, S. 2012. Evaluation of pervious concrete pavement performance in cold weather climates. *International Journal of Pavement Engineering*, 13(3):197-208.

Structure	Hydraulic	Maintenance	Other
<input checked="" type="checkbox"/>	<input checked="" type="checkbox"/>	<input checked="" type="checkbox"/>	

B4.26.1 Focus of the Project

This paper examined five pervious concrete field applications in Canada to determine their performance in cold climates. Surface distress was evaluated as was permeability, moisture movement through the pavement, cast and cored samples, and winter maintenance options.

B4.26.2 Mix Design and Structural Performance

Different mix designs were tested and evaluated. Results indicate the following:

1. Aggregate selection is very important as it can minimize fracturing,
2. Mixes with fine aggregate are more durable. This is likely due to a larger surface area and more contact with the mix,
3. Compaction increases durability and decreases raveling,
4. An asphalt paver used for concrete placement can provide a well-finished surface but maintaining a concrete supply can be challenging. Constructability must be determined and managed on a site-by-site basis,
5. Pervious concrete prepared in mobile mixers were satisfactory and were produced without problems,
6. A vibratory plate compactor behind a roller or paver provided suitable compaction,
7. To insure performance, construction joints should be considered before concrete placement,
8. The education of the construction staff and crew regarding pervious concrete is critical to ensuring a successful project,
9. Cracks will develop if no joints are placed in the concrete or if joints are spaced too far apart,
10. Mix design and proper construction are critical in achieving a durable surface.

B4.26.3 Hydrology and Water Quality Performance

Evaluation of moisture movement through the pavement indicate that freeze-thaw cycling does not typically cause distress or failure in pervious concrete. Rather, the most important factors affecting long-term performance are site and mix design along with construction practices. Other conclusions were as follows:

1. Pavement use (e.g. traffic lanes, parking stalls) can affect infiltration capacity. Traffic lanes (both sanded and unsanded) experienced a greater reduction in infiltration capacity than both sanded and unsanded parking stalls,

2. Infiltration capacity has not been the determining factor in the overall performance of the pervious concrete test areas. . Rather, the mix designs and construction methods were more critical as they greatly impact the durability of the pavement surface.

B4.26.4 Maintenance Performance

Maintenance options to restore infiltration capacity (e.g. power washing, sweeping, rinsing the surface, and vacuuming) were evaluated as were winter operations to provide safe conditions to users of the test areas (e.g. snow removal, sanding, salting, etc.). Portions of some of the test sites were sanded or salted and snow was removed as necessary by plowing or via a front end loader. The following conclusions were made:

1. Winter maintenance (sanding, salting, etc.) on sites with sufficient initial infiltration capacity has not affected infiltration capacity after 22 months of operation,
2. Power washing and vacuuming appeared to decrease infiltration capacity. It was stated that vacuuming was most likely not the cause of the decrease. Rather, the decrease observed on the vacuumed sites was attributed to repeating the tests at a location as this can lead to the void spaces becoming clogged with water,
3. Power washing appeared to push particles deeper into the pervious concrete and this could cause a decrease in infiltration capacity,
4. Agitating debris in voids is an important step in restoring infiltration capacity. Sweeping with a stiff household broom and rinsing the concrete surface with a garden hose were both effective methods of achieving this goal,
5. Areas that had initially low infiltration rates were found to be especially difficult to restore (i.e. increase infiltration rates to initial values or higher).

B4.27 Huang et al (2012). Winter performance of inter-locking pavers-stormwater quantity and quality

Huang, J., Valeo, C., He, J., Chu, A. 2012. Winter performance of inter-locking pavers-stormwater quantity and quality. *Water*, 4(4):995-2008.

Structure	Hydraulic	Maintenance	Other
	<input checked="" type="checkbox"/>		

B4.27.1 Focus of the Project

The impact of a concrete inter-locking paver (UNI Eco-Optic ®) on stormwater runoff reduction (peak flows and total volume) and water quality was assessed. The research was performed by monitoring artificially generated rainfall-runoff events from a test cell in Calgary, Alberta during the winter. The impact on water quality focused on total suspended solids (TSS), total phosphorus (TP), total nitrogen (TN), copper (Cu), lead (Pb), and zinc (Zn).

B4.27.2 Hydrology and Water Quality Performance

The pavers were effective in reducing stormwater runoff peak flows for four tests performed on different days as shown in Figure B4.3. Typically, peak flows were reduced by about 21%. The first test (2011-10-1) was performed under mild temperatures (10°C) while the remaining three tests were performed under winter conditions (4°C, 2°C, -3°C, respectively). The inflow conditions represent a 100 year storm event.

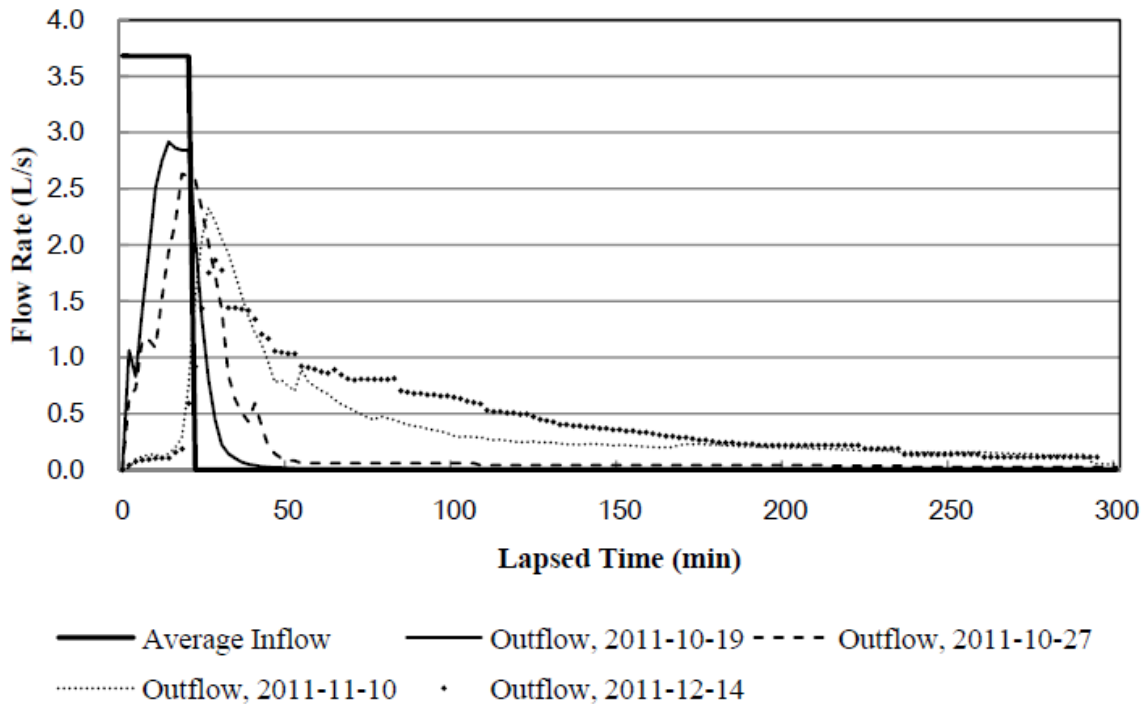

Figure B4-3. Inflow and outflow hydrographs for inter-locking concrete pavers (Huang et al. 2012).

Sanding materials were applied to the pavement surface before the third test. The sand application clogged some of the pores and reduced surface infiltration capacity rates from 7548 mm/hr to below 500 mm/hr. The reduction in infiltration capacity also resulted in the longer tails observed on the hydrographs of the latter two tests.

Overall, the pavers improved the quality of the runoff with average removal rates (concentration based) of 91, 78, 6, 55, 68, and 65 for TSS, TP, TN, Zn, Cu, and Pb, respectively.

B4.28 Kayhanian et al (2012). Permeability measurement and scan imaging to assess clogging of pervious concrete pavements in parking lots

Kayhanian, M., Anderson, D., Harvey, J.T., Jones, D., Muhunthan, B. 2012. Permeability measurement and scan imaging to assess clogging of pervious concrete pavements in parking lots. Journal of Environmental Management, 95:114-123.

Structure	Hydraulic	Maintenance	Other
-----------	-----------	-------------	-------

	<input checked="" type="checkbox"/>		
--	-------------------------------------	--	--

B4.28.1 Focus of the Project

Twenty pervious concrete parking lots were monitored and a statistical analysis was performed to determine factors that affect infiltration capacity (i.e. clogging) of the pavement. Monitoring data collected from each parking lot and included in the statistical analysis were: traffic flow, erosion, vegetation cover, sediment accumulation, maintenance actions, pavement cracking, average rainfall, and average air temperature. In addition, seven core samples were taken from four of the parking lots and porosity profiles were developed through the use of CT images to determine the extent and nature of clogging.

B4.28.2 Hydrologic (infiltration Capacity) Performance

The infiltration capacity (measured as hydraulic conductivity) was found to vary by up to 1000 times between parking spots and driving lanes. The factor most affecting infiltration capacity was the age of the parking lot followed by the amount of fine sediment (<38 µm) accumulated on pavement surfaces.

CT scans of cores revealed a clogging related decrease in infiltration capacity in the upper layers of the pavements with a decrease in infiltration capacity in mid-layers identified in some cores. The mid-level decrease in infiltration capacity could not be directly linked to particulate clogging.

B4.29 Kevern (2012). Pervious concrete shoulders for stormwater management

Kevern, J.T. 2012. Pervious concrete shoulders for stormwater management. Proceedings of the International Conference on Long-Life Concrete Pavements, September 18-21, Seattle, WA, USA.

Structure	Hydraulic	Maintenance	Other
<input checked="" type="checkbox"/>			<input checked="" type="checkbox"/>

B4.29.1 Focus of the Project

The focus of Kevern (2012) was to discuss requirements for using pervious concrete for road shoulders as well as the mixture development for a pervious concrete roadway shoulder, the first pervious concrete shoulder in the United States.

B4.29.2 Mix Design, Construction and Structural Design Performance

Kevern (2012) lists the following requirements for the construction of pervious concrete shoulders. The pavement should be:

1. Strong enough to serve as shoulder material,
2. Durable so excessive maintenance is not required,
3. Highly permeable with minimal maintenance associated with clogging,
4. Designed to minimize lateral movement of water,
5. Designed to include a base material that drains rapidly (for sub-grade protection),

6. Able to be constructed quickly,
7. Able to be cured without plastic.

In addition to the requirements listed above, the project described in Kevern (2012) was also bound by the following constraints:

1. Available coarse aggregate gradations were limited,
2. Concrete placement was to be performed with an agitator truck and roller-screed.

The mix design used for the first pervious concrete road shoulder in the United States is shown in Table B4-2. The water content listed is for a water:cement ratio of 0.35 and an additional 0.05 required for internal curing. Admixtures added to the mix were a super-absorbent polymer at 1.5 oz/cwt (ounce/hundredweight), polycarboxylate water reducer at 4 oz/cwt, hydration stabilizer at 4 oz/cwt, and air entrainer at 1 oz/cwt. The super-absorbent polymer was added to retain water in the concrete so it would cure internally without the use of plastic. Kevern (2012) notes that typically a one-third to one-half reduction in the amount of admixtures used for pervious concrete are needed to produce the same results when super-absorbent polymers are added.

Table B4-2. Mix design used for first pervious shoulder in US (Kevern 2012)

Material	Amount (pcy)
TX Active Cement	510
Coarse Agg.	2030
Fine Agg.	560
Fibers	1.5
Water	200
Design Voids	24%
Design UW	114.75 pcf

Kevern (2012) concludes by stating that the mix had good strength, durability, and self-cleaning properties and met all of the requirements stated above.

B4.30 Li et al (2012). Development of mechanistic-empirical design procedure for fully permeable pavement under heavy traffic

Li, H., Jones, D., Harvey, J. 2012. Development of mechanistic-empirical design procedure for fully permeable pavement under heavy traffic. Transportation Research Record, 2305:83-94.

Structure	Hydraulic	Maintenance	Other
<input checked="" type="checkbox"/>			<input checked="" type="checkbox"/>

B4.30.1 Focus of the Project

The focus of Li et al. (2012) was to develop mechanistic-empirical design procedures for fully permeable pavement designed to carry heavy but slow moving vehicles. Applicable areas with vehicles operating at slow speeds include maintenance yards, parking lots, residential streets, and shoulders of highways. Computer structural modeling was performed for porous asphalt, pervious concrete, and concrete slabs with cast drainage. Variables within the model included differing traffic loads and speeds, different California climates, and different material properties. A preliminary design method and design charts that incorporate hydraulic and structural performance were developed and examples provided.

B4.30.2 Structural Design and Simulations Performance

Reviewing or summarizing the design method is beyond the scope of this report. For details on the method, please see Li et al. (2012). Major findings presented in Li et al. (2012) paper were:

1. The mechanistic-empirical design method developed by Li et al. (2012) effectively estimated the permeable pavement thickness required for heavy truck traffic loads,
2. All designed pavement structures were less than 1.5 m thick (including the reservoir and subbase layers), which is a reasonable and constructible thickness,
3. Most concrete slabs designed were less than 0.46 m thick for the heaviest truck traffic,
4. The use of a PCC-O subbase will reduce the chance of subgrade rutting of asphalt pavements,
5. Designed cross-sections for highway shoulders and low speed traffic areas were considered technically and economically feasible.

B4.30.3 Recommended Research Topics for Future Investigations

The following research topics were recommended for future investigations:

1. The design method developed by Li et al. (2012) should be validated with field demonstration test sections for both hydraulic and structural performance,
2. Life-cycle cost and environmental life-cycle analysis should be performed after more data is obtained from the test sections and field demonstration test sections,
3. The field demonstration study should be expanded to include permeable interlocking concrete pavers.

B4.31 Manahiloh et al (2012). X-Ray computed tomography and nondestructive evaluation of clogging in porous concrete field samples

Manahiloh, K.N., Muhunthan, B., Kayhanian, M., Gebremariam, S.Y. 2012. X-Ray computed tomography and nondestructive evaluation of clogging in porous concrete field samples. Journal of Materials in Civil Engineering, 24(8):1103-1109.

Structure	Hydraulic	Maintenance	Other
			<input checked="" type="checkbox"/>

B4.31.1 Focus of the Project

The focus of this study was to assess clogging by examining the porosity profile of core samples prepared from CT images that were obtained from seven pervious concrete parking lots.

B4.31.2 Maintenance (Clogging) Performance

Manahiloh et al. (2012) demonstrated the capability of CT scans to determine the porosity of a pervious concrete specimen as a function of depth and, by putting multiple images together, generate a virtual image of the complete specimen. Porosity profiles of core samples showed that older parking lots had significantly lower porosity values than cores from newer parking lots. Also, samples exhibited clogged behavior due to high content of cement paste. The porosities of the cores were determined and the clogged fraction calculated. Clogged fraction values ranged from 1.5% to 11.2%.

B4.32 Mata and Leming (2012). Vertical Distribution of Sediments in Pervious Concrete Pavement Systems

Mata, L.A., Leming, M.L. 2012. Vertical Distribution of Sediments in Pervious Concrete Pavement Systems. ACI Materials Journal, 109(2):149-155.

Structure	Hydraulic	Maintenance	Other
	<input checked="" type="checkbox"/>	<input checked="" type="checkbox"/>	

B4.32.1 Focus of the Project

The effect of sediment on clogging of pervious concrete pavement with 20% porosity was examined. Sand, clayey silt, and clayey silty sand were mixed with water to create synthetic runoff with typical solids concentrations and the synthetic runoff was applied to pervious concrete specimens. Falling head permeability tests were performed before and after the application of the synthetic runoff and the results were compared to determine the impact the sediment had on clogging.

B4.32.2 Hydrologic (Infiltration Capacity) Performance

When clayey silt or clayey silty sands were applied to the pervious concrete via synthetic stormwater, a layer of clayey silty sediment was retained by the filter fabric at the bottom of the pervious concrete specimen. Sand particles, however, were trapped at or near the surface, which caused a reduction in surface infiltration capacity. The layer of fine sediment on the filter fabric can impact infiltration rates through the concrete and must be estimated and taken into account during the design of pervious concrete systems.

B4.32.3 Maintenance (Clogging) Performance

Most of the sediment was trapped near the top of the concrete but finer particles traveled deeper into or through the concrete. This process clogged the surface and reduced infiltration capacity, but the infiltration capacity was partially restored by vacuum sweeping.

B4.33 Roseen et al (2012). Water Quality and Hydrologic Performance of a Porous Asphalt Pavement as a Storm-Water Treatment Strategy in a Cold Climate

Roseen, R.M., Ballesteros, T.P., Houle, J.J., Avellaneda, P., Briggs, J., Houle, K.M. 2012. Water quality and hydrologic performance of a porous asphalt pavement as a storm-water treatment strategy in a cold climate. *Journal of Environmental Engineering*, 138(1):81-89.

Structure	Hydraulic	Maintenance	Other
	<input checked="" type="checkbox"/>		<input checked="" type="checkbox"/>

B4.33.1 Focus of the Project

A porous asphalt test section (with an area of 464 m²) in a parking lot at the University of New Hampshire Stormwater Center was monitored for four years to assess hydraulic performance and impact on water quality. Infiltration capacity into the surface and frost penetration were measured every month during the winter. The porous asphalt pavement consisted of 10 cm of porous asphalt, a 10 cm choker course, a 61 cm filter course, and a 10 cm reservoir of crushed rock. Results are summarized herein. For more details about this and other work at the University of New Hampshire Stormwater Center see the corresponding case study in Volume 1.

B4.33.2 Hydrology and Water Quality Results

Due to the fact that the porous asphalt was well drained, issues related to freezing within the media were minimal. Frost penetration was observed to depths of 71 cm without a decrease in infiltration capacity or any noticeable frost heave.

The infiltration capacity of the porous asphalt ranged, over the course of the study, from a low value of 1,490 cm/hr to a maximum value of 2,690 cm/hr with no consistent statistical differences found between seasons. It was also concluded that the course open-graded bases remained porous and well-drained throughout the year. No frost heave or any other negative effect of freeze-thaw cycling was observed and, thus, the life span of the porous asphalt test section is expected to be longer than a conventional pavement in such a cold climate.

Peak flows were reduced by 90% and most total suspended solids, petroleum hydrocarbons, and zinc concentration effluent values were below detection limits. Dissolved anions, such as nitrate and chloride, experienced no removal, and the phosphorus removal efficiency was 42%.

B4.34 Sumanasooriya et al (2012). Particle Packing-Based Material Design Methodology for Pervious Concretes

Sumanasooriya, M.S., Deo, O., Neithalath, N. 2012. Particle Packing-Based Material Design Methodology for Pervious Concretes. *ACI Materials Journal*, 109(2):205-214.

Structure	Hydraulic	Maintenance	Other
			<input checked="" type="checkbox"/>

B4.34.1 Focus of the Project

The focus of this study was to provide a rational methodology based on particle packing for the material design of pervious concrete. The process used a compaction index, which was based on the densities of mixture components, the packing density of the mix, and the corresponding volume fractions.

B4.34.2 Mix design and Structural Design Performance

When aggregates were assumed to be compacted to a volume fraction that was based on their dry-rodded unit weights, the hypothetical minimum paste volume fraction resulted in porosities that were higher than design values (when the mixes were compacted according to ASTM C1688/C1688M). Methods were developed to compensate for the high porosity in two different ways. The first method, for high paste content mixtures, was to increase the paste volume fraction while retaining the same compaction levels described in ASTM C1688/C1688M. The second method, for low paste content mixtures, was to increase the compaction level and add a minimum extra paste content. The paste volume fractions for the second case were 30 to 40% lower than those required for the first case.

Compaction indexes for both cases previously described were derived based on the virtual packing densities of the materials, volume fractions of the materials, and final mixture packing density. For a given porosity, compaction indexes were lower for high paste content mixes and higher for low paste mixes. Iso-compaction energy curves were developed from the relationship between the compaction energy and compaction indexes. These relationships can be used to determine the compaction index that is required to obtain a desired porosity for a chosen compaction method (or energy). Furthermore, the compaction indexes can be used to calculate corresponding material volume fractions.

B4.35 Welker et al (2012). A side-by-side comparison of pervious concrete and porous asphalt

Welker, A. L., Barbis, J.D., Jeffers, P.A., 2012. A side-by-side comparison of pervious concrete and porous asphalt. *Journal of the American Water Resources Association*, 48(4):809-819.

Structure	Hydraulic	Maintenance	Other
	<input checked="" type="checkbox"/>		<input checked="" type="checkbox"/>

B4.35.1 Focus of the Project

In this study porous asphalt and pervious concrete pavement were compared side-by-side with respect to water quality, durability, maintenance, and user perception. Nineteen rainfall/runoff events were monitored over a one year period and water samples were analyzed for pH, conductivity, total suspended solids, chlorides, total nitrogen, total phosphorus, and total

dissolved metals (cadmium, chromium, copper, lead, zinc). The Mann–Whitney U-test was used to compare results from the two pavements.

B4.35.2 Water Quality Performance

B4.35.3 The only water quality parameter that was found to be different between the two pavements was pH, with the pervious concrete pavement having a lower pH. Over the yearlong study the pavements wore well with no significant signs of wear.

B4.35.4 Structural Design Performance

B4.35.5 There were some signs of surface wear. Survey results of parking lot users, however, revealed perceptions were favorable with regards to esthetics, performance, and overall opinion on permeable pavements.

B4.35.6 Maintenance Performance

B4.35.7 Survey results indicated there were signs of clogging on the parking lots.

B4.36 Al-Rubaei et al. (2013). Long-Term Hydraulic Performance of Porous Asphalt Pavements in Northern Sweden

Al-Rubaei, A.M, Stenglein, A.L, Viklander, M., Blecken, G.T. 2013. Long-term hydraulic performance of porous asphalt pavements in northern Sweden. Journal of Irrigation and Drainage Engineering, 139(6):499-505.

Structure	Hydraulic	Maintenance	Other
	<input checked="" type="checkbox"/>	<input checked="" type="checkbox"/>	

B4.36.1 Focus of the Project

An eighteen year old and a 24 year old porous asphalt residential street in Northern Sweden were examined (by double-ring infiltrometer tests and examination of core samples) to determine if (or how) the long-term infiltration capacity of the asphalt was affected by clogging. Maintenance activities of high pressure washing and vacuum sweeping were also performed to determine the effectiveness of these actions with regards to restoration of infiltration capacity.

B4.36.2 Infiltration Performance

A noticeable clogging layer was observed on or near the surface of each pavement and, as a result, the infiltration capacities of the porous asphalt streets were significantly reduced from initial values. Initial infiltration capacities were reported to be above 290 mm/min whereas the mean infiltration capacities were reduced to about 0.50 mm/min for the 18 year old pavement and 0.22 mm/min for the 24 year old pavement. Although significantly reduced, a mean infiltration capacity of 0.50 mm/min was deemed large enough to infiltrate the local 100 year return storm with duration of 15 minutes.

Differences in the infiltration capacities of the two streets were attributed to differences in maintenance received by the pavements over their service life. The 18 year old pavement had fine gravel (2-4 mm) applied 2 to 4 times a year for winter traction but no salt was ever applied. This site was regularly maintained for the first 12 to 13 years through pressure washing and vacuuming along with annual sweeping in the spring after snow melt. For the five to six years prior to the investigation by Al-Rubaei et al. (2013), however, no such maintenance had been performed. The 24 year old site had five to ten applications of fine sand (0-6 mm) each winter, no salt applications, and also no maintenance. Differences could not be attributed to the presence of a geotextile layer because both pavements had one.

B4.36.3 Maintenance Performance

Pressure washing and vacuuming performed by Al-Rubaei et al. (2013) increased the infiltration capacity from a mean value of 0.50 mm/min to 3.48 mm/min for the 18 year old street but had no effect on the 24 year old street (mean infiltration capacity of 0.22 mm/min). The difference was attributed to the different maintenance practices previously described, age of the asphalt, and the application of sand and gravel during the winter months.

The authors concluded that:

1. Regular maintenance is the most important variable needed to maintain the long-term infiltration capacity of porous asphalt,
2. Mechanical sweeping is not adequate to maintain the infiltration capacity of porous asphalt,
3. Sand and other fine grain particles should not be used to increase friction during the winter.

B4.37 Coleri et al (2013). Clogging evaluation of open graded friction course pavements tested under rainfall and heavy vehicle simulators

Coleri, E., Kayhanian, M., Harvey, J.T., Yang, K., Boone, J.M. 2013. Clogging evaluation of open graded friction course pavements tested under rainfall and heavy vehicle simulators. Journal of Environmental Management, 129:164-172.

Structure	Hydraulic	Maintenance	Other
	<input checked="" type="checkbox"/>		<input checked="" type="checkbox"/>

B4.37.1 Focus of the Project

A procedure that used X-ray computed tomography (CT) imaging was developed to assess clogging mechanisms of open graded (i.e. permeable) friction course pavements. This was done by comparing CT images before and after application of simulated rainfall and also before and after full-scale accelerated pavement rutting tests. The latter was done to assess deformation related clogging. Different permeable pavements with different layer thicknesses and mix

designs were investigated for each. Deformation clogging was also assessed by measuring surface infiltration capacities before and after the rutting tests.

B4.37.2 Hydrologic Performance

Infiltration capacity was reduced by 40-90% as a result of the accelerated pavement rutting tests. Air void reduction as a result of the rainfall simulation was observed with a majority of the reduction occurring two to six millimeters from the bottom of the open graded friction course. Small air void changes were also observed in the upper 10 to 15 mm of the pavement but these were not enough to cause surface overflow. The reduction in air voids was consistent with the reduction in infiltration capacity.

B4.37.3 Mix Design and Structural Performance

CT images of surface open graded pavement showed a significant air-void reduction after rutting tests with the highest reduction at the bottom of the open graded friction course layer but also with significant reduction near the top. Deformation clogging was a function of mix design and layer thickness as thinner layers experienced greater amounts of deformation clogging.

B4.38 Drake et al (2013). Review of Environmental Performance of Permeable Pavement Systems: State of the Knowledge

Drake, J., Bradford, A., Marsalek, J. 2013. Review of environmental performance of permeable pavement systems: state of the knowledge. Water Quality Research Journal of Canada, 48(3): 203-222.

Structure	Hydraulic	Maintenance	Other
	<input checked="" type="checkbox"/>	<input checked="" type="checkbox"/>	

B4.38.1 Focus of the Report

Drake et al. (2013) performed a literature review regarding the hydrology, effect on water quality, long-term performance, and maintenance requirements of permeable pavements. Limitations of current knowledge and future research needs were also included in this review paper.

B4.38.2 Hydrology and Water Quality Performance

The review by Drake et al. (2013) focused on studies that monitored and/or tested full-scale parking lots with traffic and natural precipitation. Because the results of such tests usually depend on the climate and geography of the area, pavement type, and design of the overall system (e.g. use of geotextiles, underdrains, etc.) a meaningful comparison of results between studies was difficult. Drake et al. (2013) presented the results of many studies, most of which are shown in Table B4-3.

Table B4-3. Hydrologic performance of permeable pavements (Drake et al. 2013)

Paper	Type	Boundary condition	Study duration	Max rainfall	Volume	Flows	Timing
Abbott & Comino-Mateos (2003)	PICP	Impermeable liner with underdrains	14 months	20.6 mm	UEV averaged 67% of SRV, ranged between 30 and 120%		PF lag averaged 2 h, ranged between 5 min and 9 h
Barrett (2008)	PA (overlay)	Conventional asphalt	2.5 years	117 mm			Minimal lag between peak rainfall and runoff
Bean <i>et al.</i> (2007a)	CGP	Sandy soil	26 months	369 mm	SRV was 44% of RV on average		22% of all events produced runoff
	PC	Sandy soil	17 months	97 mm	SRV was 31% of RV on average		37% of all events produced runoff > 1 mm
	CGP	Sandy soils and loam sand soil with underdrains	10 months	88 mm			No runoff observed
Collins <i>et al.</i> (2008)	PICP	Sandy loam to sandy clay loam with underdrains	12 months	183 mm	SRV was <1% of RV, EV reductions averaged 37–66%, no exfiltration was observed for rainfall events <6 mm	PF reductions averaged 67% (PC), 60–74% (PICP), 77% (CGP)	PF lag averaged 28–50 min, ranged between 0 and 312 min
	PC						
	CGP						
Drake <i>et al.</i> (2012)	PICP PC	Silty clay with underdrains	22 months	51.6 mm	No direct runoff observed, UEV was 57% of SRV	PF reductions averaged 92%	hydrograph lag ranged between 45 min and 57.5 h
Dreelin <i>et al.</i> (2006)	PGC	Well-drained clayey soils with underdrain	4 months	18.5	Direct runoff reduced by 93%		
Fassman & Blackbourn (2010a)	PICP	Silty clay/clayey silt with underdrains	11 months	152 mm	UEV averaged 72% of SRV	PF reduction averaged 89%	median PF lag was 1 h
Kwiatkowski <i>et al.</i> (2007)	PC	Silty sand	~2.5 years	–	100% infiltration achieved for rain events <50 mm		
Pratt <i>et al.</i> (1989)	PICP	Impermeable liner with underdrain	1 month	–	UEV was 61–75% of RV	PF was 30% of rainfall intensity	PF lag was 5–10 min

Pratt <i>et al.</i> (1995)	PICP	Impermeable liner with underdrains	~ 2 years	22.6 mm	UEV averaged 24–47% of RV		
Roseen <i>et al.</i> (2012)	PA	Type 'C' soils with raised underdrain	18 months	12.7 mm	No direct runoff observed PP infiltrated 25% of RV	PF reduction averaged 80%	Hydrograph lag averaged 21 h
Rushton (2001)	PP	Sandy soil	~ 2 years	–	UEV was 35% of SRV	Reduction was more pronounced for small rain events	
TRCA (2008)	PICP	Impermeable liner with underdrains	2.5 years	72 mm	No runoff observed during the summer except for one large rain event (72 mm)	SIR of mature pavements (3–17 years) ranged between 3 and 122 cm/h	

In summarizing the papers reviewed by Drake et al. (2013) the authors state that in most studies of permeable pavements there was at least a 30% reduction in runoff volume compared to impermeable pavements. Volume reductions much higher than 30% are often reported for permeable pavements with underlying sandy soils. Also, for permeable pavements with underdrains, evidence suggests that small to moderate rainfall events experienced minimal volume reduction regardless of location or design details. With regards to peak flow rates, reductions of 70% or more were often documented but reported lag times were highly variable, even within a single study.

Other studies, some of which are discussed herein, have found that 1) parked cars can concentrate runoff and cause overflow conditions on small sections of permeable pavements, 2) adding infiltration trenches to, boreholes to, or ripping the surface of the underlying soil can increase infiltration capacity of poorly draining soils, and 3) evaporation rates were higher for permeable pavements as compared to impermeable control pavements and varied with subbase materials, vegetation, and color of stone.

Studies that investigated surface infiltration rates are summarized in Table B4-4. As shown, some studies on existing permeable pavements have found high infiltration capacities after many years of use yet other studies have found just the opposite. Items associated with low infiltration rate (e.g. clogging) tended to be winter sanding, high traffic loads, the use of geotextiles (by accumulating sediment that forms a barrier to infiltration) (Boving et al. 2008, Yong et al. 2008, Brown et al. 2009) and some have found that vegetation (plant growth and leaf litter) may help sustain infiltration (James and Gerrits 2003). Although the filtration of fines will, overtime, decrease a pavements capacity for infiltration, almost all studies noted that restoration of infiltration capacity should be possible through regular maintenance.

Table B4-4. Infiltration capacity of older permeable pavements (Drake et al. 2013)

Paper	Pavement	Age (years)	Measured Surface Infiltration	Details
Pratt <i>et al.</i> (1995)	PICP	9	>100 cm/h	Infiltration rates exceeded 100 cm/h
Baladès <i>et al.</i> (1995)	PICP	Unreported		Infiltration rates dropped by 35–50% over the course of 2 years
Kresin <i>et al.</i> (1997)	PICP	1–3	<1.5 cm/h	No significant infiltration
James & Gerrits (2003)	PICP	8	<1.5 cm/h	No significant infiltration
Brattebo & Booth (2003)	PICP, Porous Turf	6		No surface infiltration measurements were performed. PICP infiltrated all precipitation during the study (max rainfall intensity = 7.4 mm/h)
Abbott & Comino-Mateos (2003)	PICP	2	1.3 cm/h	No significant infiltration
Bean <i>et al.</i> (2007b)	CGP	Unreported	4.9 cm/h	Median infiltration rate
	PICP (visibly clean)	Unreported	2,000 cm/h	
	PICP (visibly clogged)	Unreported	8.0 cm/h	
	PC (visibly clean)	Unreported	4,000 cm/h	
	PC (visibly clogged)	Unreported	16 cm/h	
Hou <i>et al.</i> (2008)	Unspecified	4	>560 cm/h	
TRCA (2008)	PICP	2	122 cm/h	Reported three parking lots with 'good' infiltration based on qualitative observations Reported two parking lots with 'poor' infiltration based on qualitative observations
		10	9.6 cm/h	
		17	3.4 cm/h	
		4–13		
		4–8		
Beecham <i>et al.</i> (2009)	PICP	7–12	18.6 cm/h	The median infiltration rate was 18.6 cm/h. Infiltration rates ranged between 7 and 108 cm/h
Henderson & Tighe (2011)	PC	2	–	Infiltration rates on five sites ranged between 0 and 1,800 cm/h
Roseen <i>et al.</i> (2012)	PA	3	>111 cm/h	An overall decline in infiltration rates was observed throughout the study
Drake & Bradford (2012)	PICP	7	<5 cm/h	
	PC	4	<5 cm/h	

With regards to water quality, permeable pavements typically reduced pollutant mass loads discharged to receiving water bodies by reducing runoff volumes and by retaining pollutants within the permeable pavement system. Pollutants retained in the pavement void space eventually need to be removed.

Although results varied, in general, studies found that permeable pavements retained 50 to 60% of solids and particle-bound metals (typically Pb, Zn, Cd, Cu, Fe). Due to limited number of samples, confidence intervals for individual studies are large but, as a whole, Drake et al. (2013) concludes that porous asphalt, pervious concrete, and permeable interlocking concrete pavers remove suspended solids and the particulate metals.

Hydrocarbons are also retained in permeable pavement systems. Once there, they can volatilize or be degraded by naturally occurring microorganisms. Also, removal of oils and greases often results in concentrations less than detection limits. With regards to nitrogen, it has been reported that permeable pavement systems provide suitable conditions for nitrification (ammonium to nitrate) but it has also been observed that total nitrogen concentrations can be higher in

permeable pavement effluent than in conventional asphalt runoff or atmospheric deposition. Also, particulate bound phosphorus can be removed by filtration within the pavement structure. Related studies listed by Drake et al. (2013) are summarized in Table B4.5.

Several studies have observed that most particulate pollutants are retained either at the surface or within the first few centimeters below the surface within the pores. Most studies have also found zero or minimal stormwater pollutants in the soils underlying permeable pavements.

Table B4-5. Removal rates of metals and solids (Drake et al. 2013)

Paper	Pavement	Sampled events	Average removal (%)					Average residual concentration					
			By concentration or mass	TSS	Zn	Cu	Pb	Cd	TSS (mg/L)	Zn (µg/L)	Cu (µg/L)	Pb (µg/L)	Cd (µg/L)
Barrett <i>et al.</i> (2006)	PA (overlay)	5	Concentration	94	76	75	93	7.6	40.4 ^a , 30.9 ^b	6.8	0.9		
Barrett (2008)	PA (overlay)	5 asphalt, 25 exfiltrate	Concentration	93	79	52	88	8.80	34.7 ^a , 27.4 ^b	12.9 ^a , 9.8 ^b	1.5 ^a , < 1.0 ^b		
	PA (overlay)	6	Concentration	87	83	61	87	23.17	23.3 ^a , 13.0 ^b	12.4 ^a , 8.4 ^b	1.4 ^a , < 1.0 ^b		
Fassman & Blackburn (2010b)	PICP	8-17	Concentration ^a	56	93	57		10-80	8-60 ^a , 0-20 ^b	3-8 ^a , 1-3 ^b			
			Concentration ^b		93	52							
			Mass ^a	70	96	70							
			Mass ^b		95	69							
Legret & Colandini (1999)	PA	11	Mass	59	73	84	77	8.3	45.6	8.3	0.25		
Legret <i>et al.</i> (1996)	PA	22-38	Concentration	64	72	79	67	12	46	15	5.4	0.49	
Pagotto <i>et al.</i> (2000)	PA	25	Concentration ^b		61	15	32	60	13	180	24	13	0.5
			Concentration ^c		74	70	83	73					
			Concentration ^a	81	66	35	78	69					
			Mass ^a	77	59	21	74	62					
Roseen <i>et al.</i> (2009)	PA	Unspecified, 24 months	Concentration	96	79			2.22	100				
Rushton (2001)	Porous paving + swale	12-30	Mass	91	75	81	85	3.76	18.6	3.35	1.25		
Sansalone & Teng (2004)	PC	3	Mass ^c	91	85	86	89	86		71.2 ^a , 29.2 ^b	16.8 ^a , 12.3 ^b	20.3 ^a , 17.6 ^b	0.8 ^a , 0.7 ^b
			Mass ^b		91	88	76	86					
			Concentration ^c	72	55	54	63	55					
			Concentration ^b		92	62	25	54					

^aTotal.
^bDissolved.
^cParticulate.

Porous pavements also tend to raise the pH of infiltrated water from acidic levels to values between 8 and 9.5. This may be due to concrete (pervious concrete or concrete blocks) or to materials in the layers underneath the surface layer (e.g. choker course, subbase, etc.). Because most metals are less soluble at higher pH's, this may also cause metals to precipitate.

Studies have been conducted on the impact that certain design variations have on water quality. Examples include geotextiles (may affect nutrient removal), phosphorus absorbing materials, anaerobic zones (may increase nutrient removal), sand layers (may increase nitrogen removal),

and crushed brick, limestone, and basalt (the former two have more metal removal than the latter).

Materials within the pavement structure itself can react chemically and/or dissolve, thereby increasing the pH, conductivity, alkalinity, hardness, and dissolved solids. One three-year long study concluded that the source of all pollutants found in water samples was sand used for joints and beds and not from surface inputs (Fassman and Blackbourn 2010).

Drake et al. (2013) state that salts appear to be the only contaminant with a significant potential for groundwater contamination and that salts can cause the leaching of metals through cation exchange.

With regards to frost, it has been documented that infiltrating runoff increases the latent heat of the ground below permeable pavements and that this delays freezing. Also, when thawing occurs on permeable pavements, melt water is removed from the surface and thawing is quickened. These processes reduce the risk of frost damage because periods of frost are shorter and frost penetration is shallower.

Although it is typically assumed that permeable pavements reduce temperatures and increase soil moisture, research has not found significant differences in these areas between permeable and impermeable pavements. Research has shown, however, that plant growth is more dependent on pavement design than type (Morganroth 2011, Morganroth and Visser 2011). For example, an increase in tree growth is more likely with uncompacted bases and/or sub-bases.

B4.38.3 Maintenance Performance

Many studies have found that removing particles at or near the surface restores, at least partially, infiltration capacity. Testing within each study was typically limited and, as a result, associated uncertainties were high. Maintenance investigations summarized by Drake et al. (2013) are shown in Table B4.6 and B4.7.

Table B4-6. Studies investigating the impact of maintenance (Drake et al. 2013)

Study	Pavement	Age (years)	Maintenance	Post treatment infiltration (cm/h)	Level of rehabilitation
Kresin <i>et al.</i> (1997)	PICP	1-3	Manual removal of material in top 5 mm	0.77 (Site 1) 4.0 (Site 2)	Negligible change An increase of 168%
James & Gerrits (2003)	PICP	8	Manual removal of material in top 25 mm		Post treatment infiltration rates for the 1st plot (Eco-Stone 3') only improved in areas of low traffic Removal of material in top 25 mm provided partial rehabilitation
Henderson & Tighe (2011)	PC	2	Large hose Hand held sweeping Hand held sweeping and power washing	70-1,300	Over 90% of the treated area displayed improvement. Significant results were observed Between 20 and 80% of the treated area displayed improvement. Results were not significant Between 50 and 90% of the treated area displayed improvement. Results were not significant
Chopra <i>et al.</i> (2010a)	PC	6-18	Hand held vacuum sweeping	25.4	
		6-18	Pressure washing	145	
		6-18	Hand held vacuum sweeping and pressure washing	170	

Table B4-7. Other studies on maintenance (Drake et al. 2013)

Study	Pavement	Age (years)	Maintenance	Level of rehabilitation
Baladès <i>et al.</i> (1995)	PICP	10	Wetting and sweeping	Negative effect
		Unreported	Sweeping and vacuum sweeping	Severely clogged surfaces showed no improvement. Moderately clogged surfaces were rehabilitated after two passes
		Unreported	Vacuum sweeping	Partial or full rehabilitation was achieved after two passes
van Duin <i>et al.</i> (2008)	PA	<1	Pressure washing	Partial or full rehabilitation was achieved
			Schwarze A8000 Regenerative-air truck (single dry pass)	Maintenance decreased measured infiltration rates
	PICP	<1	Schwarze A8000 regenerative-air truck (three wet passes)	Pavement appeared to be irreversibly clogged
			Schwarze A8000 Regenerative-air truck (single dry pass)	Measured infiltration rates improved in some areas. Increases in infiltration related to depth of joint material removed
			Schwarze A8000 regenerative-air truck (three wet passes)	Measured infiltration rates improved in some areas. Increases in infiltration related to depth of joint material removed

Chopra <i>et al.</i> (2010b)	PC	Specimen simulations	Loading of sand followed by Elgin Whirlwind vacuum truck	Full rehabilitation was achieved after two passes
			Loading of limestone followed by Elgin Whirlwind vacuum truck	Partial rehabilitation was achieved
	Flexipave	Specimen simulations	Loading of sand followed by Elgin Whirlwind vacuum truck	No significant effect
			Loading of limestone followed by Elgin Whirlwind vacuum truck	No significant effect
	PICP	Specimen simulations	Loading of sand followed by vacuum truck	Full rehabilitation was achieved after two passes
			Loading of limestone followed by vacuum truck	Vacuum sweeping restored infiltration rates at one location and failed at a second location
PA	Specimen simulations	Loading of sand followed by vacuum truck	The first pass of the vacuum sweeper improved infiltration rates but repeated passes decreased infiltration	
		Loading of limestone followed by vacuum truck	No significant effect	
Drake <i>et al.</i> (2012)	PICP	2	Elgin Whirlwind vacuum truck	Single pass of the vacuum sweeper partially restored infiltration rates
	PC	2	Elgin Whirlwind vacuum truck	No significant effect

Based on the review performed by Drake et al. (2013) the following can be concluded in regards to permeable pavement maintenance:

1. The effectiveness of cleaning decreases as the exposure to clogging materials increases,
2. Reduction in infiltration capacity can only be partially restored through maintenance,
3. Even within a single permeable pavement, the effect of maintenance is highly variable,
4. Successful demonstrations of large-scale maintenance actions have been documented but under limited conditions,
5. The impact of maintenance on infiltration capacity depends on the type of permeable pavement.

B4.38.4 Recommended Research Topics for Future Investigations

Drake et al. (2013) recommended the following research topics for future investigations:

1. A better understanding of nitrogen fate and transport in porous pavement is needed. For example, the source of nitrogen when it has been found to leach from a porous pavement system is not known,
2. Although permeable pavements can remove particulate phosphorus, research is needed to determine the long-term fate and transport of the phosphorus (does it become mobile later, etc.?).
3. The source, fate, and transport of nutrients need to be better understood,
4. The effect of design and materials used on water quality should be investigated,
5. The impact of infiltration on groundwater quality,

6. Determination of pavement designs that optimize pollutant retention and minimize clogging,
7. Development of models that can accurately predict loss of infiltration capacity over the long-term,
8. An accurate estimate of life-cycle costs should be developed,
9. The impact of permeable pavements on watersheds at a large scale must be better understood,
10. Decision tools are needed to help users make more optimum decisions with regards to permeable pavements.

B4.39 Fan et al (2013). Microbial Community Structure and Activity under Various Pervious Pavements

Fan, L.F., Chen, J.W., Wang, S.F., Chen, T.H., Chen, C.P., Chao, W.L., Hsieh, H.L. 2013. Microbial Community Structure and Activity under Various Pervious Pavements. Journal of Environmental Engineering, Published online, 10.1061/(ASCE)EE.1943-7870.0000798.

Structure	Hydraulic	Maintenance	Other
			<input checked="" type="checkbox"/>

B4.39.1 Focus of the Project

The focus of this project was to investigate and compare the microbial structure and activity in soil under several permeable pavements. Two soil layers were collected (aggregate and soil bases) under a permeable asphalt, concrete brick, concrete-glass block, and JW pavement. A JW pavement is a newly designed concrete pavement with high load bearing properties and permeability. Contrary to other pavements, the lower layer under JW pavements do not need to be heavily and repeatedly compressed because the JW pavement is ductile and strong.

Each soil layer was evaluated for granulometry, water content, pH, total organic carbon, total nitrogen, enzymatic activities, community-level physiological profiles, phylogenetic bacterial diversity, and a microbiological assay was performed.

B4.39.2 Water Quality Performance

The amount and diversity of bacterial communities and the activation and versatility of microbial activities were related to the total organic carbon content of the pavements. JW pavement had microbial compositions and activities much stronger than those under the other pavements (except for fungi and actinobacteria). Bacteria under the JW pavement was also more abundant and diverse and the soil there also indicated more activated and versatile microbial metabolism in all substrates and some types of functional guilds. The authors attributed these results to a looser soil structure and a higher water and total organic carbon content.

B4.40 Hein et al 2013b. Cleaning Methods for Pervious Concrete Pavements

Hein, M.F., Dougherty, M., Hobbs, T., 2013b. Cleaning Methods for Pervious Concrete Pavements. International Journal of Construction Education and Research, 9(2):102-116

Structure	Hydraulic	Maintenance	Other
		<input checked="" type="checkbox"/>	

B4.40.1 Focus of the Project

This project investigated the effectiveness of maintenance actions such as power blowing, pressure washing, vacuuming, and a combination of these methods with respect to restoring the infiltration capacity of pervious concrete.

B4.40.2 Maintenance Performance

As initial cleaning methods, vacuuming and pressure washing both increased surface infiltration capacities by over 90%. Combining pressure washing and vacuuming was much more effective than either of the single methods applied individually. Tests indicated that sections that were vacuumed then pressure washed then vacuumed again increased in infiltration capacity by almost another 50% compared to a single maintenance action (i.e. pressure washing or blowing alone). Also, power blowing applied after power washing had little impact on infiltration rates.

B4.41 Imran et al (2013). Permeable Pavement and Stormwater Management Systems: A Review

Imran, H. M., Akib, S., Karim, M.R. 2013. Permeable pavement and stormwater management systems: a review. *Environmental Technology*, 13(18):2649-3656.

Structure	Hydraulic	Maintenance	Other
<input checked="" type="checkbox"/>	<input checked="" type="checkbox"/>		

B4.41.1 Focus of the Project

Imran et al. (2013) reviewed the use of permeable pavements for different purposes while focusing on runoff quality and drainage from roads, roofs, driveways, parking lots.

A proposed permeable pavement cross-section was presented in this review paper. The cross-section consisted of a top layer of permeable pavers, a bedding course (200-250 mm of course sand), a filter course (50-100 mm of crushed aggregate that can filter water, enhance biodegradation, and provide structural support), a base course (350-400 mm of large aggregate for support and water storage), and an optional geotextile layer (which may enhance treatment of infiltrated water).

B4.41.2 Hydrology and Water Quality Performance

According to this review paper, geotextile fabric between the base layer and bedding layer can increase pollutant retention capability, enhance biodegradation, and prevent the transport of fines to lower layers. The bedding layer is defined as a layer of fine sand, which can also retain pollutants. Some report that a permeable pavement with a geotextile layer can increase pollutant retention (Brown et al. 2009, which is reviewed in this document). Some studies report that solids removal may occur at the surface of the pavement (James and Gerrits, 2003, James 2004) however, while others, as discussed previously, found that this occurs at the geotextile layer. Imran et al. (2013) also reported that permeable pavements can remove pathogens from infiltrated water (Scholz and Grabowiecki 2009).

In some applications geothermal heat pumps have been placed beneath the permeable pavement, presumably to heat the pavement during the winter months and cool the pavement during the summer.

Porous asphalt is summarized as having the ability to significantly retain metals and organic carbon from infiltrated water and as having little ability to retain nitrogen and ammonia.

B4.41.3 Recommendations for Future Research Investigation

Imran et al. (2013) recommended the following research topics for future investigations:

1. A better understanding of the biodegradation process in permeable pavements (species, dispersal, and colonization rate) is needed,
2. Further investigation into the removal/retention of nutrients is needed,
3. Evaluation of the optimum environment for biodegradation for various organisms is needed,
4. A better understanding of the relationship between temperature profiles, biodegradation, and microorganism life cycles is needed,
5. Investigation into different media mixes to enhance bioretention is needed,
6. The performance of filter media in sumps at the bottom of permeable pavement structures should be investigated,
7. A better understanding of the removal and leaching of phosphorus within permeable pavements is needed.

B4.42 Li et al (2013a). The use of reflective and permeable pavements as a potential practice for heat island mitigation and stormwater management

Li, H., Harvey, J.T., Holland, T.J., Kayhanian, M. 2013a. The use of reflective and permeable pavements as a potential practice for heat island mitigation and stormwater management. *Environmental Research Letters*, 8:1-14.

Structure	Hydraulic	Maintenance	Other
-----------	-----------	-------------	-------

	☑		☑
--	---	--	---

B4.42.1 Focus of the Project

The project explored the possibility of using permeable pavements to manage stormwater and reduce heat island effects near the surface. To do this, test sections of reflective permeable pavement (including porous asphalt, pervious concrete, and interlocking concrete pavers) were investigated for hydraulic and thermal performance.

B4.42.2 Hydrologic (infiltration Capacity) Performance

Interlocking concrete pavers had the highest infiltration capacity (0.5 cm/s) and two porous asphalt pavements had the lowest (0.1 cm/s). Two pervious concrete sections tested had intermediate infiltration capacities of about 0.3 cm/s. The 0.1 cm/s infiltration capacity was found to be sufficient to prevent surface runoff overflow during most typical rainfall events at the location of the study (central California).

B4.42.3 Mix Design and Structural Performance

Results from a simulation study indicated that, if properly designed, full depth permeable pavements may retain runoff from a typical California storm and be strong enough to carry both light-duty and some heavy-duty vehicles at low speed.

B4.42.4 Albedo (Pavement cooling or Heat Island) Performance

Increasing albedo can significantly lower pavement daytime high surface temperatures in California. Moisture near the surface of the pavement and the evaporation rate affect the amount of pavement cooling. Adding water to the pavements lowered the temperatures (due to evaporation) with the maximum cooling effect being 15° to 35°C early in the afternoon in the summer. Twenty-five hours after adding water the pavement temperature was still 2° to 7°C lower than one hour after adding water despite the fact that the air temperature was even higher 25 hours after adding water. This study concluded that using permeable reflective pavements can help mitigate near-surface heat island effects and improve air quality (by reducing air conditioner use).

B4.42.5 Recommended Research Topics for Future Investigation

Li et al. (2013a) suggested the following research topics for future research:

1. Field studies to verify hydraulic performance and structural design under traffic loadings,
2. Field studies to investigate other cooling technologies such as reflective paint and material that generate high evaporation rates,
3. Field studies to assess thermal performance and the effect on building energy,
4. A detailed life-cycle environmental assessment.

B4.43 Li et al (2013b). Comparative field permeability measurement of permeable pavements using ASTM C1701 and NCAT permeameter methods

Li, H., Kayhanian, M., Harvey, J.T. 2013b. Comparative field permeability measurement of permeable pavements using ASTM C1701 and NCAT permeameter methods. *Journal of Environmental Management*, 118:114-152.

Structure	Hydraulic	Maintenance	Other
	<input checked="" type="checkbox"/>		

B4.43.1 Focus of the Project

This study was compared the measured infiltration rate obtained by two different methods, 1) The National Center for Asphalt Technology (NCAT) permeameter method and, 2) The ASTM C1701 method. Measurements were obtained from five locations of field test sections comprised of porous asphalt, pervious concrete, and permeable interlocking concrete pavers and the results were compared.

B4.43.2 Hydrologic (Infiltration Capacity) Performance

Major findings from Li et al. (2013b) study were as follows:

1. Both methods investigated can be used to measure the infiltration capacity of all pavement types, regardless of the surface type,
2. The pavement type will not affect the measurement precision,
3. Values obtained with the ASTM method were, on average, 75% lower than values obtained with the NCAT method,
4. The ASTM method was more reliable and had less variability than the NCAT method.

The reason the ASTM method was more reliable and had less variability was attributed to the larger base diameter of its permeameter.

B4.44 Mbanaso et al (2013). Laboratory-based experiments to investigate the impact of glyphosate-containing herbicide on pollution attenuation and biodegradation in a model pervious paving system

Mbanaso , F.U., Coupe, S.J., Charlesworth, S.M., Nnadi, E.O. 2013. Laboratory-based experiments to investigate the impact of glyphosate-containing herbicide on pollution attenuation and biodegradation in a model pervious paving system. *Chemosphere*, 90(2):737-746.

Structure	Hydraulic	Maintenance	Other
			<input checked="" type="checkbox"/>

B4.44.1 Focus of the Project

This laboratory investigation determined the effect of adding glyphosate-containing herbicides on hydrocarbon retention and biodegradation within permeable pavements.

B4.44.2 Hydrology and Water Quality Performance

The glyphosate-containing herbicides appeared to reduce hydrocarbon retention by geotextiles by pushing oils through the pavement systems. Permeable pavement systems with only oil added discharged effluent with a hydrocarbon concentration of up to 24.5 mg/L whereas systems with added oil and herbicide had effluent with a hydrocarbon concentrations of up to 73.2 mg/L. The authors note that some of the increase is probably due to the fact that the herbicide itself contains hydrocarbons. Previous studies have shown permeable pavements with added mineral oil (and no herbicide) retained 98.7% of added oils which were eventually biodegraded.

The herbicide also reduced the ability of the geotextile to retain metals. When glyphosate-containing hydrocarbons were added, high concentrations of lead, copper, and zinc were found in the effluent from the permeable pavement.

The herbicide also stimulated populations of bacteria and fungi and increased their population, thus increasing the number of organic degraders. Protists (organisms that live in almost any environment that contains liquid water), however, were eliminated by the herbicide addition but their populations recovered within seven days. Their taxonomic richness, however, was reduced after recovery.

B4.45 Sata et al (2013). Properties of pervious geopolymer concrete using recycled aggregates

Sata, V., Wongsu, A., Chindaprasit, P. 2013. Properties of pervious geopolymer concrete using recycled aggregates. *Construction and Building Materials*, 42:33-39.

Structure	Hydraulic	Maintenance	Other
<input checked="" type="checkbox"/>			

B4.45.1 Focus of the Project

Sata et al. (2013) investigated properties of pervious geopolymer concrete containing recycled aggregates (fly ash, sodium silicate solution, sodium hydroxide solution, crushed structural concrete, and crushed clay brick) and compared the results to properties of pervious concrete containing natural coarse aggregate. Properties investigated included compressive strength, split tensile strength, total void ratio, and infiltration capacity.

B4.45.2 Mix Design and Structural Design Performance

Sata et al. (2013) concluded that recycled aggregate from crushed structural concrete and crushed clay bricks can be used as coarse aggregate for pervious geopolymer concrete with high calcium

fly ash as a source material. Although using crushed structural concrete and crushed clay brick resulted in lower compressive strengths than concrete with natural aggregate, values were still within typical ranges (2.9 to 10.3 MPa). Also, values for density, compressive strength, split tensile strength, compressive strength, total void ratio, and infiltration capacity were all similar to those of conventional pervious concrete.

Other relevant results from this study include:

1. Void ratio and infiltration capacity of pervious geopolymer concrete with different sodium hydroxid concentrations (and same aggregate and paste content) were all similar,
2. Mixes with high sodium hydroxide concentrations (15 to 20 M) resulted in higher strengths than low concentrations (10 M).

Results indicated that making pervious concrete using recycled crushed structural concrete and clay brick as coarse aggregates with high calcium fly ash is feasible and produces acceptable properties but with lower strength.

B4.46 Scholz (2013). Water Quality Improvement Performance of Geotextiles Within Permeable Pavement Systems: A Critical Review

Scholz, M., 2013. Water Quality Improvement Performance of Geotextiles Within Permeable Pavement Systems: A Critical Review. *Water*, 5:462-479.

Structure	Hydraulic	Maintenance	Other
	<input checked="" type="checkbox"/>		

B4.46.1 Focus of the Project

Scholz (2013) performed a review by critically assessing previously reported tests regarding the impact of geotextiles on water quality. The review considered available literature and assessed the studies for scientific rigor and statistical significance. When assessing the impact of geotextiles on water quality organics, nutrients, metals, motor oils, suspended solids, and chloride were considered.

B4.46.2 Water Quality Performance

The review performed by Scholz (2013) concluded that only few studies have investigated the role of geotextiles on improving water quality. The available limited literature, however, suggests that any water quality improvement due to the presence of a geotextile is minimal but, if present, it is due to the retention of solid particles (and associated particle-bound pollutants) on the fabric. Other contaminants not associated with solids (e.g. chloride) were essentially unaffected. The information presented in existing studies were not conclusive and available data was deemed unsuitable for further statistical analysis.

B4.46.3 Recommended Research Topics for Future Investigations

Scholz (2013) recommended the following research topics for future investigation:

1. Long-term testing on the impact of geotextiles with underground testing units to mimic actual field conditions,
2. Different, or modified, geotextiles should be investigated. For example, heat-bonded geotextiles might slow the release of oil or geotextiles with trace elements may enhance the degradation of some contaminants (e.g. oils).

It was also suggested that future studies be undertaken in parts of the world with dryer and warmer climates than most of the past study locations (or studies should be performed in a climate controlled area to represent these conditions).

B4.47 Sonebi and Bassuoni (2013). Investigating the effect of mixture design parameters on pervious concrete by statistical modeling

Sonebi, M., Bassuoni, M.T. 2013. Investigating the effect of mixture design parameters on pervious concrete by statistical modeling. *Construction and Building Materials*, 38:147-154.

Structure	Hydraulic	Maintenance	Other
<input checked="" type="checkbox"/>			

B4.47.1 Focus of the Project

The focus of this project was to develop statistical modeling (two-level factorial design and response surface methodology) to investigate the effect of water:cement ratio, cement content, and coarse aggregate content on pervious concrete properties (density, void ratio, infiltration capacity, and compressive strength). Testing was performed with water:cement ratios ranging from 0.28 to 0.40, cement content ranging from 350 to 415 kg/m³, and coarse aggregate ranging from 1200 to 1400 kg/m³.

The developed models, which can simulate the impact of design variables on resulting density, void ratio, infiltration rate and compressive strength, can help optimize pervious concrete mix proportions and reduce the amount of trial batches.

B4.47.2 Mix Design and Structural Design Performance

Major findings of the Sonbei and Bassuoni (2013) study can be summarized as follows:

1. An increase in water:cement ratio increased density and compressive strength but reduced void ratio and infiltration capacity,
2. An increase in water:cement ratio resulted in a high paste volume that was more than enough to encapsulate the aggregate,
3. Excessive paste clogged pores, increased compressive strength, and reduced void content,

4. Increased cement content resulted in lower void ratio and infiltration capacity but increased the compressive strength,
5. An increase in coarse aggregate reduced density and increased void ratio, infiltration capacity, and compressive strength.

B4.48 Wardynski et al (2013). Internal Water Storage Enhances Exfiltration and Thermal Load Reduction from Permeable Pavement in the North Carolina Mountains

Wardynski, B.J., Winston, R.J., Hunt, W.F., 2013. Internal water storage enhances exfiltration and thermal load reduction from permeable pavement in the North Carolina mountains. *Journal of Environmental Engineering*, 139(2):187-195.

Structure	Hydraulic	Maintenance	Other
	<input checked="" type="checkbox"/>		

B4.48.1 Focus of the Project

A recently constructed permeable interlocking concrete paver (PICP) parking lot in North Carolina was monitored for one year to assess the impact the pavers had on runoff volume, stormwater temperature, and thermal load export. The parking lot had an area of 239 m² and was divided into three cells with varying aggregate depths (deep, medium and shallow internal water storage) and drainage configurations. The conventional cell had a 25 cm thick aggregate layer for water storage with an underdrain at the bottom of this layer, the shallow cell was identical except that the drain was located at the top of the aggregate storage layer, and the deep cell had a 56 cm thick aggregate storage layer with an underdrain located 25 cm below the top of the aggregate layer.

B4.48.2 Hydrology and Water Quality Performance

The shallow and deep cells had the largest stormwater volume reductions (99.6 and 100%, respectively) while the conventionally drained cell had a volume reduction of 7%. Thermal loads for the deep, shallow, and a conventionally drained cell were reduced in direct proportion to the corresponding volume reduction.

Median effluent temperature from the conventionally drained cell exceeded the critical trout temperature of 21°C during eight of the 54 events that were monitored. Effluent temperatures for the two cells with internal water storage never exceeded the critical trout temperature.

Temperature profiles indicate that the pavers can buffer the impact of high runoff temperatures. During cold winter months the temperature of the subsurface soils never reached freezing. Thus, the authors concluded that frost heave of such pavers should not be expected in similar climates.

B4.49 Yong et al (2013). Predicting physical clogging of porous and permeable pavements

Yong, C.F., McCarthy, D.T., Deletic, A. 2013. Predicting physical clogging of porous and permeable pavements. *Journal of Hydrology*, 481:48-55.

Structure	Hydraulic	Maintenance	Other
	<input checked="" type="checkbox"/>	<input checked="" type="checkbox"/>	

B4.49.1 Focus of the Project

Yong et al. (2013) investigated the processes involved in the clogging of permeable pavements (porous asphalt, modular Hydrapave, and monolithic Permapave) and develop a "black box" model to predict clogging.

B4.49.2 Maintenance (Clogging) Performance

Clogging, as assumed, was determined to be a function of pavement design. Porous asphalt clogged near the surface, which caused water to pond more quickly than the other two permeable pavements tested. Clogging in the Hydrapave pavement was just above the geotextile layer, which was underneath the pavers, and no clogging was observed in the Permapave pavement.

Clogging rates were dependent on test conditions. Systems that were subject to dry periods had almost double the life span of those that experienced continuous flow with no dry periods. Results were used to develop a model that calculated clogging as a function of the total volume of water infiltrated and the flow rate. The model only considered physical clogging, which is most likely the major component of clogging in most systems. The form of the equation was the same for both pavements that were modeled but the coefficients were different, suggesting that the form of the equation may be applicable to other pavements.

B4.50 Sañudo-Fontaneda et al (2014). Study on Field Study of Infiltration Capacity Reduction of Porous Mixture Surfaces

Sañudo-Fontaneda L.A., Andrés-Valeri V.C.A., Rodriguez-Hernandez J., and Castro-Fresno D. 2014. Field Study of Infiltration Capacity Reduction of Porous Mixture Surfaces. *Journal of Water*, 6: 661-669; doi:10.3390/w6030661

Structure	Hydraulic	Maintenance	Other
	<input checked="" type="checkbox"/>	<input checked="" type="checkbox"/>	

B4.50.1 Focus of the Project

The focus of this project was to develop a new methodology to quantify the reduction in surface infiltration of porous asphalt and to identify the hypothetical differences in permeability between zones within the parking lots influenced by static loads from parked vehicles. With this aim, nine different zones were selected in order to check this hypothesis (four points under the wheels of a standard vehicle and five points between wheels). The hypothesis was evaluated by measuring

infiltration capacity reduction for nine bays with Polymer-Modified Porous Concrete and another nine bays with Porous Asphalt surfaces at the University of Cantabria (Spain) Campus parking area five years after their construction, using the Laboratorio de Caminos de Santander (LCS) permeameter. The experimental design is shown in Figure B4-4.



Figure B4-4. (A) Scheme of the eighteen car parking bays analyzed; and (B) measurement zones selected within each car park bay and LCS on-site (Sañudo-Fontaneda et al. 2014).

B4.50.2 Infiltration and Hydraulic Performance

The distribution of the permeability values registered using the LCS permeameter at each measurement point of the analyzed parking bays of both types of pervious surfaces is shown in Figure B4-5. It can be observed that there are differences in the infiltration capacity among the different measurement zones on both types of pervious surfaces, generally showing a reduction in infiltration capacity in some wheel-surface contact zones. Considering the average permeability values in each measurement zone of each pervious surface type, the average reductions of the infiltration capacity were calculated and the results were in the range of 65-85% and 75-85% for the PMPC and PA surfaces, respectively.

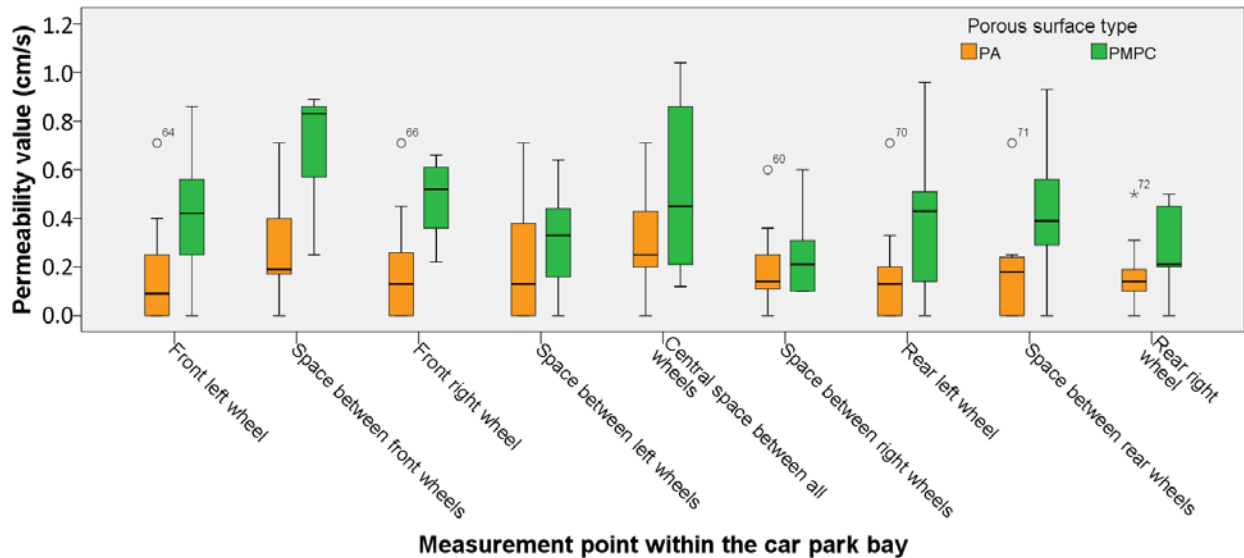

Figure B4-5. Box-plots of the average values of permeability in each measurement zone of parking bays (Sañudo-Fontaneda et al. 2014).

The statistical analysis (Mann-Whitney and Kruskal Wallis significance tests) performed on the results obtained demonstrate the influence of the measurement zone on permeability values and on the reduction in infiltration capacity obtained after five years of use in car parking bays made of PMPC and PA. In this field study, permeability was significantly different for PMPC and PA surfaces after 5 years of use. No significant differences were found between PMPC and PA surfaces regarding their infiltration capacity reduction after five years of use. The statistical methodology described in this article demonstrated that only the type of porous mixture surface significantly influenced permeability results, while neither the type of porous surface nor the measurement zone influenced the reduction in infiltration capacity. While the reduction in the infiltration capacity on both porous mixture surfaces was quite similar (on average; 79.43% for PMPC surface and 82.04% for the PA surface), the average permeability value was still high (0.41 cm/s) to prevent the surface overflow.

The methodology presented in this study could be used in similar investigation in order to prove the general suitability of materials used in permeable pavement construction projects.

B5 Books and Other Publications

There have been few books written on the topic of permeable pavement. One book, written by Ferguson in 2005, provides a comprehensive history of permeable pavement, mix design, construction, structural design aspects, hydrological design, maintenance, cost, and environmental concerns. This book and other publications such as student theses and magazine articles are reviewed in this chapter.

B5.1 Chopra et al (undated). Hydraulic Performance of Pervious Concrete Pavements.

Chopra, M., Wanielistaa, M., Spence, J., Ballock, C., Offenber, M. undated. Hydraulic Performance of Pervious Concrete Pavements

Structure	Hydraulic	Maintenance	Other
			<input checked="" type="checkbox"/>

B5.1.1 Focus of the Project

This project investigated the infiltration capacity, storage capacity, and clogging potential of a pervious concrete system. Several pervious concrete parking lots that were at least five years old were assessed in detail by testing infiltration capacity, surface clogging, and examining their subgrades/subsoils. Also, design and construction guidelines for pervious concrete are presented.

B5.1.2 Mix Design and Structural Design Performance

Mix design and construction guidelines were provided as summarized below: (see Chopra et al undated for full details).

1. Contractor shall provide proof of qualifications and experience,
2. Cement shall comply with the latest specifications of Portland cement or blended hydraulic cement and aggregates shall conform to ASTM C 33. Chemical admixtures, if approved, shall conform to ASTM C 494,
3. The top six inches of subgrade shall be gravelly or granular, primarily sandy soil and have a permeability of at least 1 in/hr,
4. The subgrade shall be level,
5. Mixes shall be used within 45 minutes of the addition of water. Concrete shall be placed as close to its final location as possible and an internal vibrator shall not be used,
6. After strike-off, concrete shall be compacted to the level of the form with a steel roller made from nominal 10-inch diameter steel pipe of 0.25 inch thickness. The roller shall provide a minimum of 10 psi vertical force,
7. As soon as possible, all concrete should be covered with a secured (6 mil minimum) plastic sheet,
8. If a travel lane is wider than 15 feet, longitudinal joints shall be installed down the middle of the lane,
9. Traverse joints should be spaced at no more than 20 feet,

10. Joints should be installed using a roller with a flange welded to it and the joint depth shall be 1/4 of the pavement thickness or 1.5 inches, whichever is smaller.

B5.1.3 Hydrology (infiltration Capacity) Performance

In all field tests the infiltration capacity exceeded the design value of 2 in/hr. Chopra et al. (undated) stated this demonstrated the potential long-term effectiveness of pervious concrete to infiltrate stormwater runoff.

B5.2 Ferguson (2005). Porous Pavements

Ferguson, B. 2005. Porous Pavements. Taylor & Francis, New York, NY, USA. ISBN-13: 978-0849326707.

Structure	Hydraulic	Maintenance	Other
<input checked="" type="checkbox"/>	<input checked="" type="checkbox"/>	<input checked="" type="checkbox"/>	<input checked="" type="checkbox"/>

B5.2.1 Focus of the Book

Ferguson (2005) focused on permeable pavement practices and experiences in North America and included information on the structure and hydrology of permeable pavements, the aggregates used in permeable pavements, and media design to support trees. Also included are chapters on porous turf, plastic geocells, open-jointed paving blocks and open-celled paving grids (i.e. permeable interlocking concrete pavers), pervious concrete, and porous asphalt. The book concludes with chapters on soft porous surfaces (i.e. granular material from an organic or recycled sources such as mulch) and permeable decks (i.e. bridge type structures that elevate the pavement). The last two chapters are not within the scope of this literature review. Also, numerous case studies are included throughout the book.

Due to the wide range of topics in Ferguson (2005) and the depth of coverage, a thorough review is not possible within the context of this literature review. Also, most of the topics discussed in Ferguson (2005) have been covered in detail by other, more recent documents that have been reviewed in this report. Thus, only a brief summary of the most relevant components of Ferguson book relevant to the historical evolution, mix design and structural design aspect, hydrological design aspects, water quality and environmental concern, maintenance issues are summarized herein.

B5.2.2 Mix Design, Construction and Structural and Design Aspects

Ferguson (2005) discussed soil classification, characteristics, compaction, and bearing value of soils. The structural role of pavement is also discussed as are freezing conditions and wet, swelling, and plastic subgrades.

With regards to aggregates, Ferguson (2005) provided an overview of ASTM standard gradations, discussed open-graded aggregates, aggregate size, and the influence on infiltration capacity. A separate section is devoted to aggregate base courses and reservoirs.

Through case studies of both a successful and unsuccessful pervious concrete applications, Ferguson (2005) reaffirmed that permeable pavements should not be located at the low point in the drainage system.

B5.2.3 Hydrological Design Aspects and

In a review of hydrology Ferguson (2005) presented an overview of surface infiltration, runoff coefficients, infiltration into the subgrade, storage in the pavement structure, and travel times, among other topics. Rainfall patterns are discussed as is the importance and frequency of small storms.

B5.2.4 Water Quality and Environmental Concerns

Ferguson (2005) briefly reviewed typical stormwater pollutants and sources but did not discuss typical concentrations. The processes of solids (and adsorbed metals) capture is discussed and some associated case studies are given. Also discussed are the processes of oil degradation in the pavement and additional treatment through infiltration into the subgrade.

B5.2.5 Maintenance Issues

Ferguson (2005) noted that permeable pavements can become clogged, especially in high traffic areas and where vehicles frequently turn. The friction generated by vehicle tires can cause the pavement to wear and the pavement can become clogged with debris, although debris may also be carried to the area by the vehicles.

Ferguson (2005) noted that permeable pavement infiltration rates generally decline rapidly immediately after construction but the decline generally becomes much slower after a couple of years. Maintenance activities discussed by Ferguson (2005) included those previously discussed such as washing and vacuuming.

B5.2.6 Costs

Ferguson (2005) reviewed other publications that indicated porous asphalt and pervious concrete can, when considering costs of associated stormwater management systems, be more economical than traditional asphalt pavements. To support this claim actual projects in which porous asphalt or pervious concrete were selected over traditional projects were briefly presented.

B5.3 Briggs (2006). Performance Assessment of Porous Asphalt for Stormwater Treatment

Briggs, J.F. 2006. Performance assessment of porous asphalt for stormwater treatment. M.S. Thesis. University of New Hampshire, Durham, NH, USA.

Structure	Hydraulic	Maintenance	Other
<input checked="" type="checkbox"/>	<input checked="" type="checkbox"/>	<input checked="" type="checkbox"/>	

B5.3.1 Focus of the Project

Briggs 2006 assessed the performance of a porous asphalt parking lot in Durham, New Hampshire. The 4 inch thick porous asphalt surface was placed over a porous media reservoir that included a fine-grained filter course. The fine-grained filter course was in place of the typical coarse, uniformly graded aggregate and was intended to improve water treatment.

B5.3.2 Mix Design, Construction and Structural Design Performance

Strength tests showed that traditional dense mix asphalt is significantly stronger than porous asphalt due to the air voids in the porous asphalt. This has not, however, seemed to affect the durability of the porous asphalt.

With regard to cost, the construction cost per parking space (\$2200) was 10% more than traditional asphalt (\$2000). With a thinner reservoir layer, however, the cost of the porous asphalt system would have been less than traditional asphalt.

B5.3.3 Hydrology and Water Quality Performance

A water balance revealed that the lot retained and/or infiltrated most of the precipitation over an 18 month span. Initial surface infiltration capacity was measured at three locations with reported capacities of 1300 in/hr, 1000 in/hr, and 330 in/hr. The two higher capacity locations had a 50% decrease in infiltration capacity over the course of the study. Infiltration capacity of the low permeability location decreased significantly and appeared to become clogged due to solid particles and/or draindown of the asphalt binder. Solids that caused clogging could have originated from sand applied during the winter, aggregate and speed bump material that broke off during winter plowing, or off site organics.

Twelve storm events were monitored for runoff peaks and volumes. The porous asphalt significantly reduced peak flows and also exhibited high lag times.

Frost penetration was observed to a depth of 1 foot below the ground surface but this did not affect the performance of the pavement. This was most likely because the voids in the asphalt were unsaturated. Frost heave was not observed.

Water quality treatment for total suspended solids, zinc, and diesel was exceptional and for phosphorus it was limited. Negative removal rates for nitrate and chloride were observed, with significantly more chloride being exported from the system than entered the system.

B5.3.4 Conclusions

Briggs (2006) concluded that:

1. Porous asphalt can be a cost-effective and viable stormwater treatment strategy as it can reduce runoff volumes, runoff peaks, and concentrations of some contaminants,
2. Care must be taken when considering porous asphalt because ground slope, soil type, groundwater depth, depth to bedrock, and traffic loads can affect performance,

3. Design and construction is important and should follow published and accepted guidelines,
4. The base of the reservoir layer should be flat to maximize infiltration,
5. Maintenance is important to optimize long-term performance.

B5.3.5 Recommendations for Future Research Investigation

The following recommendations for future research investigation were made by Briggs (2006):

1. The method for measuring infiltration capacity should be improved to minimize leaking,
2. Pavement cores should be taken and analyzed to determine the extent that binder drawdown affected infiltration,
3. Infiltration capacity prior to and after maintenance should be measured to determine the impact of maintenance activities,
4. Optimize winter maintenance strategies to minimize the application of deicers and sand,
5. Determine the impact on groundwater quality,
6. Better records of sanding and salting applications should be kept and chloride application rates should be quantified.

B5.4 Gunderson (2008). Pervious pavements: New findings about their functionality and performance in cold climates

Gunderson, J. 2008. Pervious pavements: New findings about their functionality and performance in cold climates. Stormwater Magazine, September 2008.

Structure	Hydraulic	Maintenance	Other
<input checked="" type="checkbox"/>	<input checked="" type="checkbox"/>	<input checked="" type="checkbox"/>	

B5.4.1 Focus of the Project

Gunderson (2008) summarized studies that have been performed at the University of New Hampshire Stormwater Center on both porous asphalt and pervious concrete. For a more a more technical review, see the corresponding case study in Volume 1 of this report.

B5.4.2 Mix Design and Structural Design Performance

An open-graded and well designed permeable pavement of significant depth will experience a longer life (compared to conventional pavement) from increased freeze-thaw resistance and greater load bearing capacity. Design guidelines account for frost depths from 48 to 52 inches but more of a concern than depth is the rate of freeze-thaw cycling.

The system tested at the University of New Hampshire had the porous asphalt at the top, a stone choker course, an underlying filter layer of sand and gravel, and an stone layer with a drainage system (for sampling). In low permeable soils the drainage layer may be required.

The pervious concrete portion of the project was just beginning at the time Gunderson (2008) was written so results were minimal. University of New Hampshire researchers, however, did note that pervious concrete can be warmed by the underlying soil and this can lessen the impact of cold weather on the system.

The cross-section of the system consisted of a sand/filtration layer and large coarse stone reservoir layer. The reservoir layer acts as a stormwater detention area and the filter layer will improve water quality through physical and chemical processes.

A proper pervious concrete system should include: 1) proper water:cement ratio (not too wet or too dry), 2) selection/design of a subbase that can support expected loads and improve water quality, and 3) correct construction by educated contractors.

B5.4.3 Hydrology and Water Quality Performance

Frozen filter media and freeze-thaw cycling were not an issue with respect to infiltration. The subbase, if well drained, remained open and, even if it was frozen, it did not freeze solid and, thus, retained the ability to infiltrate. In fact, winter infiltration rates were found to be consistently higher than summer rates. One possible cause discussed was the asphalt binder, which may swell in the summer heat and thereby reduce infiltration.

With regards to water quality impact, no seasonal variation was observed. Typically, 95% or more of solids, total zinc, and total petroleum hydrocarbons (diesel) were retained and 42% of total phosphorus was retained. Nitrogen, however, was not retained.

B5.4.4 Maintenance (Clogging) Performance

Clogging of porous asphalt is attributed to 1) surface particulates and, 2) a combination of liquid binder and surface particulates. Impacts of clogging can be addressed through routine cleaning and appropriate mix designs that minimize binder draindown. University of New Hampshire researchers also noted that even with 99% clogging, infiltration rates would still be more than 10 inches per hour. Also, winter salt applications were reduced by 75% compared to conventional pavement.

B5.4.5 Costs Comparison

Gunderson (2008) noted that permeable pavements in cold climates can have a design life of up to 30 years whereas traditional pavement typically have design lives of 15 years. Also, with permeable pavements, typical stormwater drainage systems (e.g. catch basins, pipe, etc.) can be reduced or eliminated. These factors can make a permeable pavement system as or more cost-effective than a traditional non-permeable pavement.

B5.5 Houle (2008). Winter performance assessment of permeable pavements

Houle, K., 2008. Winter performance assessment of permeable pavements - A comparative study of porous asphalt, pervious concrete, and conventional asphalt in a northern climate. M.S. Thesis. University of New Hampshire, Durham, NH, USA.

Structure	Hydraulic	Maintenance	Other
	<input checked="" type="checkbox"/>	<input checked="" type="checkbox"/>	<input checked="" type="checkbox"/>

B5.5.1 Focus of the Project

The performance of two parking lots, one porous asphalt and one pervious concrete, in a cold climate was investigated. Frost penetration, surface infiltration rates, snow and ice cover, skid resistance, chloride retention, and salt loading are considered.

B5.5.2 Hydrologic Performance

Infiltration rates did not decrease during the winter even with frost depths of 27 inches.

B5.5.3 Maintenance Performance

Less snow and ice cover on the porous asphalt parking lot allowed annual salt use to be reduced by 75%, on average while maintaining adequate skid resistance. The greatest reduction in salt loadings was achieved freeze-thaw cycles.

Black ice did not form on the pervious concrete lot, which eliminated the need for salt application during freeze-thaw conditions. No overall salt reduction, however, was observed on the porous concrete lot. This was attributed to the light color of the concrete and shading of the pavement surface.

Houle (2008) concluded that permeable pavements are more functional than standard impervious pavements in cold regions. Skid resistance was higher for both porous asphalt and pervious concrete as compared to traditional dense mix asphalt.

B5.5.4 Recommendations for Future Research Investigation

Houle (2006) recommended the following be the subject of future research:

1. Monitor infiltration rates over the long-term to determine the long-term performance of the pavement,
2. Performing a chloride mass balance on the parking lots to determine chloride retention or export amounts,
3. Other maintenance actions/items such as salt brines and non-chloride salts should be investigated to determine their performance and required loading rates,
5. Measure vertical temperature profiles below the ground surface as well as groundwater elevations to determine if latent heat from the ground and infiltrated water can melt snow and ice in or on the pavement.
6. Perform full life-cycle costs for various pavement types to better compare permeable pavements amongst themselves and with traditional pavements.

B5.6 Thomle (2010). The Declining pH of Waters Exposed to Pervious Concrete

Thomle, J.N. 2010. The Declining pH of Waters Exposed to Pervious Concrete. MS Thesis, Department of Civil and Environmental Engineering, Washington State University, Pullman, WA, USA.

Structure	Hydraulic	Maintenance	Other
	<input checked="" type="checkbox"/>		

B5.6.1 Focus of the Project

This study investigated the temporal pH change of stormwater that has contacted pervious concrete that has aged under various air restrictions. Pervious concrete specimens were prepared in the laboratory and exposed to three different levels of ambient air restriction. The pH of specimens was assessed by either infiltrating tap or deionized water through the specimens or by soaking the specimens in tap or deionized water.

The study also investigated the decline in pH of water in contact with pervious concrete exposed to carbonate laden water.

B5.6.2 Hydrology and Water Quality Performance

The pH of water exposed to concrete decreases as a result of a chemical process called carbonation. In this process the hydroxide anion associated with calcium hydroxide is replaced with a carbonate anion and calcium carbonate is formed.

More exposure to ambient air caused a significant increase in the rate of pH decline. Tap water, which represented typical stormwater for the study, had much lower pH values than deionized water. Minerals in the tap water help lessen the impact of the concrete and, as a result, the pH does not rise as much as in deionized water. It is expected that, for most typical field conditions, effluent pH values will decline to acceptable values in much less than one year.

In the carbonate laden water tests, the pH of water exposed to concrete that had previously been exposed to carbonate laden water decreased more quickly when exposed to ambient air.

B5.6.3 Recommended Research Topics for Future Investigations

Thomle (2010) suggested the following research topics for future investigations:

1. Quantification of the total carbonation that occurred in the specimens,
2. Quantification of the amount of carbon sequestered in the specimens when exposed to carbonate laden waters.
3. Tests should be performed using higher concentrations of carbonate species.

B5.7 Boyer (2011). Preliminary analysis of summertime heat storage in traditional versus pervious concrete systems

Boyer, M. 2011. Preliminary analysis of summertime heat storage in traditional versus pervious concrete systems. MS Thesis, Department of Civil and Environmental Engineering, University of Washington, Pullman, WA, USA.

Structure	Hydraulic	Maintenance	Other
			<input checked="" type="checkbox"/>

B5.7.1 Focus of the Project

Boyer (2011) investigated a pervious concrete pavement and an adjacent traditional concrete pavement in a parking lot in Iowa for their performance related to the mitigation of the urban heat island effect. The pervious concrete section had a solar reflective index (SRI) of 14 and the traditional concrete had an SRI of 37. A higher value of SRI means more solar radiation will be reflected and there will be less potential to add to the urban heat island effect.

B5.7.2 Urban Heat Island (Solar Reflective Index) Performance

Although the pervious concrete had a much lower SRI than the traditional concrete, during periods with little or no precipitation it performed just as well as the traditional concrete with respect to mitigating the urban heat island effect. Thus, Boyer (2011) concluded that using only the SRI to rank pervious concrete in terms of its cooling ability is a faulty method.

Likely due to evaporative cooling, there were also temperature related benefits observed with the pervious concrete when it rained. The temperature of both pavements generally followed the air temperature but when there was daytime rain, the pervious concrete cooled to a much lower temperatures. The water stored in pervious concrete layer had a large impact on heat gain of the system but when this water evaporated, the system cooled. The pervious concrete cooled more quickly than the traditional concrete.

B5.7.3 Recommended Research Topics for Future Investigations

Boyer (2011) recommended the following topics for future research:

1. Mapping of temperatures as a function of depth in the pervious concrete layer more accurately and also the investigation of the impact of varying porosities, material characteristics, and climates in order to develop design guidelines to mitigate the urban heat island effect,
2. Investigate the impact of the aggregate storage layer on heat island mitigation (although the pervious concrete layer controlled most of the heat gain and loss),
3. Performed a detailed finite element analysis to model the temperature gains and losses to better understand the processes involved in the heating and cooling of pervious concrete,
4. Perform a life cycle analysis including environmental, energy, and economic considerations,
5. Perform a study to measure the amount of water retained in the pervious concrete layer after a rainfall event and also the evaporation and cooling effect of this water.

B5.8 Drake (2013). Performance and operation of partial infiltration permeable pavement systems in the Ontario climate

Drake, J. 2013. *Performance and operation of partial infiltration permeable pavement systems in the Ontario climate*. Ph.D. Thesis, University of Guelph, Guelph, Ontario, Canada, June 2013.

Structure	Hydraulic	Maintenance	Other
	<input checked="" type="checkbox"/>	<input checked="" type="checkbox"/>	

B5.8.1 Focus of the Project

Drake (2013) investigated the performance of three permeable pavements systems (AquaPave®, Eco-Optic®, and Hydromedia® pervious concrete) over low permeability soil (drawdown rates of 10^{-5} to 10^{-4} cm/s) by monitoring them for over two years. Performance of the permeable pavements was also compared to a control impervious asphalt site. Main findings and conclusions are summarized here. For more details regarding the research project see the corresponding case study in Volume 1.

B5.8.2 Hydrology and Water Quality Performance

The hydrologic performance of the permeable pavement systems were evaluated by restricting the outflow using valves on underdrains beneath the pavement to accomplish: 1) elimination of runoff for rainfalls of less than 7 mm, 2) reduction of peak flows by 91%, and 3) reduction of total runoff volume by 43%.

With regards to water quality, the permeable pavements reduced effluent concentrations and total mass loads of suspended solids, nutrients, hydrocarbons, and most metals. These benefits were also observed during the winter but to a different degree. Values of pH, and concentrations of potassium and strontium indicated that the effluent water quality changed with time.

Pollutant concentrations from the pavement structure itself (i.e. construction materials) were found to significantly decrease after a season of rainfall.

Other findings were:

1. The pervious concrete and permeable interlocking concrete pavers behaved similarly with respect to hydrology. Most differences were attributed to construction practices rather than the products themselves,
2. The pervious concrete and permeable interlocking concrete pavers behaved similarly with respect to water quality for most pollutants but not all. The permeable pavements investigated all removed high amount of solids, most metals, and nutrients and significantly reduced the occurrence of detectable levels of hydrocarbons,
3. Differences in metal concentrations were attributed to specific aggregates and/or material in the pavement itself. Such metals were Ba, Ca, Cr, and Sr among others,

4. All three pavements increased pH and, during non-winter months, also increased conductivity and dissolved solids,
5. The pH of the pervious concrete decreased exponentially over the first and second year (typically from near 10 or 11 to around 8.5),
6. Nutrient concentrations in effluent from all three pavements were much different. This was attributed to different transformation and removal processes occurring in each system,
7. Clogging occurred at different rates and generated different maintenance needs. The rate of surface clogging was linked to the size of the surface opening,
8. Traffic and loading rates significantly impacted long-term surface infiltration capacity. Higher traffic counts lead to more rapid clogging,
9. Low areas that received runoff from other areas experienced more clogging,
10. Areas with established vegetation within the permeable pavement did not have higher surface infiltration capacities.

B5.8.3 Cold Weather Operation Performance

The following observations were made with respect to the performance of the permeable pavements during the winter months:

1. The pavements buffered sodium and chloride concentrations and reduced the loading of sodium and chloride to downstream water bodies by over 89%,
2. Effluent nutrient concentrations increased during the winter season,
3. Conditions may exist in permeable pavement systems to allow denitrification (NO_3^- to N_2) to occur,
4. Permeable pavements did not require the application of salt during the winter as often as the traditional asphalt surface.

B5.8.4 Maintenance Performance

Drake (2013) found that small-scale equipment for vacuum sweeping and pressure washing have good potential to restore, at least in part, infiltration capacity.

Street sweeping trucks with suction-based sweeping partially restored infiltration capacity on permeable interlocking concrete pavers. Vacuum sweeping also improved the hydraulic performance of a pervious concrete pavement that had experienced a severe loss of permeability but, overall, maintenance of severely clogged pavements was less successful and more variable.

Other relative findings related to maintenance performance were as follows:

1. No impact of freeze-thaw cycling on the durability was observed,
2. Small-size equipment for vacuum cleaning and pressure washing have potential to increase infiltration capacity,
3. After two years of use, PICP benefited from vacuum sweeping,
4. Full-sized sweeping trucks used suction-based sweeping to partially restore infiltration capacity of PICP,
5. At one site vacuum sweeping increased infiltration capacity of pervious concrete but at another it had no impact,
6. Annual vacuum cleaning of PICP is recommended,
7. Even though vacuum sweeping did not significantly impact pervious concrete hydraulic performance, annual sweeping is recommended as a preventative measure.

B5.8.5 Recommended Research Topics for Future Investigation

Drake (2013) identified the following topics for future research:

1. Accurate and reliable life-cycle cost analysis of permeable pavements are needed. To do this, proven maintenance activities and their costs are needed,
2. The ability of permeable pavements to sustain benefits on a large, watershed scale must be understood and demonstrated,
3. Assessment tools are needed for decision support for policy makers and developers,
4. More demonstration of performance of permeable pavements in low permeability soils is needed and the impact of varying boundary conditions on infiltration must be better understood,
5. The impact on water quality must be evaluated with methods that are more telling than event mean concentrations (such as total pollutant loads), more accurately include data that is below detection limits, and include a frequency analysis,
6. The process of reduced permeability (i.e. clogging) must be better understood to allow for a more accurate life-cycle cost analysis,
7. The effect of vegetation on permeable pavement performance and the control of weeds must be better understood,
8. Maintenance requirements must be better understood,
9. The performance of permeable pavements over long time scales must be better understood,

10. Investigation into techniques to dislodge particles causing clogging are needed as this would increase the effectiveness of vacuum sweeping and regenerative air sweeping,
11. Further research is needed to determine the performance of permeable pavements in cold weather over long-term time scales,
12. Further research is needed to determine how/if permeable pavements can provide safe conditions with lower salt application rates than traditional pavements.

B6 Appendix B References

- AASHTO (American Association of State Highway and Transportation Officials). 1993. *Guide for Design of Pavement Structures*, AASHTO, Washington, D.C., USA.
- ACI (American Concrete Institute). 2010. *Report on Pervious Concrete*. ACI, Farmington Hills, MI, USA. ACI 522R-10.
- ACPA (American Concrete Paving Association). 2009. *Stormwater management with pervious concrete pavement*. ACPA, Skokie, IL, USA.
- ACPA (American Concrete Pavement Association). undated A. *PerviousPave-Background, Purpose, Assumptions and Equations*. Washington, D.C., USA.
- ACPA (American Concrete Paving Association). undated B. *Concrete Information: Cement treated permeable base for heavy-traffic concrete pavements*. ACPA, Arlington Heights, IL, USA.
- Al-Rubaei, A.M, Stenglein, A.L, Viklander, M., and Blecken, G.T. 2013. "Long-term hydraulic performance of porous asphalt pavements in northern Sweden." *Journal of Irrigation and Drainage Engineering*, 139(6): 499-505.
- Amde, A.M., and Rogge, S. 2013. *Development of high quality pervious concrete specifications for Maryland conditions*. State Highway Administration Maryland Department of Transportation, Baltimore, MD, USA.
- Bean, E.Z., Hunt, W.F., Bidelspach, D.A., and Burak, R.J. 2004. "Study on the surface infiltration rate of permeable pavements." *Proceedings of the 1st Water and Environment Specialty Conference of the Canadian Society for Civil Engineering*, June, Saskatoon, Saskatchewan, Canada.
- Beecham, S., Pezzaniti, D., Myers, B., Shackel, B., and Pearson, A. 2009. "Experience in the application of permeable interlocking concrete pavements in Australia." *Proceedings of the 9th International Conference on Concrete Block Paving*, , October, Buenos Aires, Argentina, Argentinean Concrete Block Association, Cordoba, Argentina.
- Borgwardt, S., 1994. *Tests performed on the Uni Eco-stone pavements of various ages - Expert opinion*, Institute for Planning Green Spaces and for Landscape Architecture, University of Hanover, Germany.
- Borgwardt, S., 1995. *Suitable beddings for paving blocks permeable to water*. Betonwerk + Fertigteil-Technik (Concrete Precasting Plant and Technology, Germany).
- Borgwardt, S. 1997. *Performance and fields of application for permeable paving systems*. Betonwerk + Fertigteil-Technik (Concrete Precasting Plant and Technology, pp. 100-105, Germany).
- Borgwardt, S., 2006. Long-term in-situ infiltration performance of permeable concrete block pavement. *Proceedings of the 8th International Conference of Concrete Block Paving*,

San Francisco, CA, USA. Interlocking Concrete Pavement Institute Foundation for Education and Research, November, Herndon, Virginia, USA.

- Boving, T., Stolt, M., Augenstern, J. and Brosnan, B. 2008. "Potential for localized groundwater contamination in a porous pavement parking lot setting in Rhode Island." *Environ. Geol.* 55 (3): 571–582.
- Boyer, M. 2011. *Preliminary analysis of summertime heat storage in traditional versus pervious concrete systems*. MS Thesis, Department of Civil and Environmental Engineering, University of Washington, Pullman, WA, USA.
- Brattebo, B.O., and Booth, D.B. 2003. "Long-term stormwater quantity and quality performance of permeable pavement systems." *Water Research*, 37(18): 4369–4376.
- Briggs, J.F. 2006. *Performance assessment of porous asphalt for stormwater treatment*. M.S. Thesis. University of New Hampshire, Durham, NH, USA.
- Brown, D. 2003. "Pervious concrete pavement: A win-win system." *Concrete Technology Today*, 24(2), Portland Cement Association.
- Brown, C., Chu, A., van Duin, B. and Valeo, C. 2009. "Characteristics of sediment removal in two types of permeable pavement." *Water Qual. Res. J. Can.* 44 (1): 59–70.
- Burak, R.J. 2004. "Permeable Interlocking Concrete Pavements - Selection, Design, Construction and Maintenance." *Proceedings of the 2004 Annual Conference and Exhibition of the Transportation Association of Canada*. 2004. pp. 17. September 19-22, Quebec, Ontario, Canada.
- Cahill, T.H., Adams, M., and Marm, C. 2005. "Stormwater management with porous pavements." *Government Engineering*, March 2005, pg. 6. California Department of Transportation, Sacramento, CA, USA.
- Caltrans. 2010a. *Laboratory testing and modeling for structural performance of fully permeable pavements under heavy traffic: Final Report*. California Department of Transportation, Sacramento, CA, USA.
- Caltrans. 2010b. *Laboratory testing and simulation of the hydraulic performance of fully permeable pavements: Final Report*. California Department of Transportation, Sacramento, CA, USA.
- Chai, L., Kayhanian, M., Givens, B., Harvey, J.T., and Jones, D. 2012. "Hydraulic performance of fully permeable highway shoulder for storm water runoff management." *Journal of Environmental Engineering*, 138(7): 711-722.
- Chopra, M., Wanielistaa, M., Spence, J., Ballock, C., and Offenber, M. undated. *Hydraulic Performance of Pervious Concrete Pavements*. Stormwater Management Academy, University of Central Florida, Orlando, FL, USA.

- Chopra, M., Kakuturu, S., Ballock, C., Spence, J., and Wanielista, M. 2010. "Effect of Rejuvenation Methods on the Infiltration Rates of Pervious Concrete Pavements." *Journal of Hydrologic Engineering*, 15(6): 426-433.
- Coleri, E., Kayhanian, M., Harvey, J.T., Yang, K., Boone, J.M. 2013. "Clogging evaluation of open graded friction course pavements tested under rainfall and heavy vehicle simulators." *Journal of Environmental Management*, 129: 164-172.
- Collins, K.A., Hunt, W.F, and Hathaway, J.M. 2010. "Side-by-side comparison of nitrogen species removal for four types of permeable pavement and standard asphalt in eastern North Carolina," *Journal of Hydrologic Engineering*, 15(6): 512-521.
- CPG (Concrete Promotional Group). Undated. *Handbook for Pervious Concrete Certification in Greater Kansas City*. CPG, Overland Park, KS, USA.
- CRMCA (Colorado Ready Mixed Concrete Association). 2009. *Specifier's guide for pervious concrete pavement design*. CRMCA, Centennial, CO, USA.
- Debo, T.N., and Reese, A.J. 1995. *Municipal storm water management*, Lewis Publishers, CBC Press, Boca Raton, FL, USA.
- Dierkes, C., Holte, A., and Geiger, W.F. 1999. "Heavy Metal Retention within a Porous Pavement Structure." *Proceedings of the Eighth International Conference on Urban Storm Drainage*, August 30-September 3, Sydney, Australia.
- Drake, J., Bradford, A., Van Seeters, T., and MacMillan, G. 2012. *Evaluation of permeable pavements in cold climates*. Toronto and Region Conservation Authority, Toronto, Canada.
- Drake, J. 2013. *Performance and operation of partial infiltration permeable pavement systems in the Ontario climate*. Ph.D. Thesis, University of Guelph, Guelph, Ontario, Canada.
- Drake, J., Bradford, A., and Marsalek, J. 2013. "Review of environmental performance of permeable pavement systems: state of the knowledge." *Water Quality Research Journal of Canada*, 48(3): 203-222.
- Eller, A.J., and Izevbehai, B.I. 2007. *1st Year Performance Report for Cell 64 Pervious Concrete*. Minnesota Department of Transportation, St. Paul, MN, USA.
- Fan, L.F., Chen, J.W., Wang, S.F., Chen, T.H., Chen, C.P., Chao, W.L., and Hsieh, H.L. 2013. "Microbial Community Structure and Activity under Various Pervious Pavements." *Journal of Environmental Engineering*, Published online, 10.1061/(ASCE)EE.1943-7870.0000798.
- Fassman, E. and Blackburn, S. 2013. "Urban runoff mitigation by a permeable pavement system over impermeable soils." *Journal of Hydrologic Engineering*, 15(6): 475-485.

- Ferguson, B. 2005. *Porous Pavements*. Taylor & Francis, New York, NY, USA. ISBN-13: 978-0849326707.
- Gerrits, C. 2001. *Restoration of Infiltration Capacity of Permeable Pavers*. Masters Thesis, Civil Engineering Department, University of Guelph, Ontario.
- Ghafoori, N. 1995. "Pavement thickness designs for no-fines pavement parking lots." *Journal of Transportation Engineering*. 121(6): 476-484.
- Gilbert, J.K., and Clausen, J.C. 2006. "Stormwater runoff quality and quantity from asphalt, paver, and crushed stone driveways in Connecticut." *Water Research*. 40(4): 826-832.
- Golroo, A., and Tighe, S.L. 2009. "Use of soft computing applications to model pervious concrete pavement condition in cold climates." *Journal of Transportation Engineering*. 135(11): 791-800.
- Golroo, A., and Tighe, S.L. 2011. "Alternative modeling framework for pervious concrete pavement condition analysis." *Construction and Building Materials*. 25(10): 4043-4051.
- Golroo, A., Tighe, S.L., 2012a. Pervious Concrete Pavement Performance Modeling Using the Bayesian Statistical Technique. *Journal of Transportation Engineering*, 138(5):603-609.
- Golroo, A., and Tighe, S.L., 2012b. "Pervious concrete pavement performance modeling: an empirical approach in cold climates." *Canadian Journal of Civil Engineering*, 39(10): 1100-1112.
- González-Angullo, N., Castro, D., Rodríguez-Hernández, J., and Davies, J.W. 2008. "Runoff infiltration to permeable paving in clogged conditions." *Urban Water Journal*, 5(2): 117-124.
- Gunderson, J. 2008. "Pervious pavements: New findings about their functionality and performance in cold climates." *Stormwater Magazine*. September 2008.
- Hall, M.J. 1994. *Cement stabilized open graded base, strength testing and field performance vs. cement content*, 73rd annual meeting of the Transportation Research Board. January, 1994, Washington, D.C., USA.
- Haselbach, L.M., and Freeman, R.M. 2006. "Vertical porosity distributions in pervious concrete pavement." *ACI Materials Journal*. 103(6): 452.
- Haselbach, L.M., Valavala, S., and Montes, F. 2006. "Permeability predictions for sand-clogged Portland cement pervious concrete pavement systems," *Journal of Environmental Management*. 81(1): 42-49.
- Hein, D., Strecker E., Poresky A., and Roseen R. 2013a. *Permeable shoulders with stone reservoirs*. American Association of State Highway and Transportation Officials (AASHTO), NCHRP Project 25-25, Task 82, National Cooperative Highway Research Program, Transportation Research Board, Washington, DC.

- Hein, M.F., Dougherty, M., and Hobbs, T., 2013b. "Cleaning Methods for Pervious Concrete Pavements." *International Journal of Construction Education and Research*. 9(2): 102-116.
- Henderson, V., and Tighe, S. 2012. "Evaluation of pervious concrete pavement performance in cold weather climates." *International Journal of Pavement Engineering*. 13(3): 197-208.
- Houle, K. 2008. "Winter performance assessment of permeable pavements - A comparative study of porous asphalt, pervious concrete, and conventional asphalt in a northern climate." M.S. Thesis. University of New Hampshire, Durham, NH, USA.
- Huang, J., Valeo, C., He, J., and Chu, A. 2012. "Winter performance of inter-locking pavers-stormwater quantity and quality." *Water*. 4(4): 995-2008.
- Imran, H. M., Akib, S., and Karim, M.R. 2013. "Permeable pavement and stormwater management systems: a review." *Environmental Technology*, 13(18): 2649-3656.
- InterPave. 2010. *Permeable Pavements: Guide to the design, construction and maintenance of concrete block permeable pavements*. InterPave, Leicester, England.
- Izevbekhai, B.I., and Akkari, A. 2011. *Pervious concrete cells on MnROAD low-volume road*. Minnesota Department of Transportation report no. MN/RC 2011-23, St. Paul, MN, USA.
- James W. 2004. "Clogging of permeable concrete block pavement by street particulates and rain. Innovative modeling of urban water systems." *CHI monograph 12*. Guelph, Ontario, Canada.
- James, W., and Gerrits, C. 2003. "Maintenance of infiltration in modular interlocking concrete pavers with external drainage cells." *Practical modeling of Urban Water Systems*. CHI Publishers, Guelph. pp 417-435.
- Jones, D., Harvey, J., Li, H., Wang, T., Wu R., and Campbell, B. 2010. *Laboratory testing and Modeling for Structural Performance of Fully Permeable Pavements under Heavy Traffic*. Report number CTSW-RT-10-249.04 California Department of Transportation, Sacramento, CA.
- Kayhanian M., Chai L., and Givens B. 2010. *Laboratory testing and simulation for hydraulic performance of fully permeable pavements*. Report number CTSW-RT-10-247.03 California Department of Transportation, Sacramento, CA.
- Kayhanian, M., Anderson, D., Harvey, J.T., Jones, D., and Muhunthan, B. 2012. "Permeability measurement and scan imaging to assess clogging of pervious concrete pavements in parking lots." *Journal of Environmental Management*, 95:114-123.
- Kevern, J.T., Schaefer, V.R., and Wang, K. 2009. "Temperature Behavior of Pervious Concrete Systems." *Journal of the Transportation Research Board*, 2098: 94-101.

- Kevern, J.T., Wang, K., and Schaefer, V.R. 2008. "Pervious Concrete in Severe Exposures." *Concrete International*, 30(7).
- Kevern, J.T. 2012. "Pervious concrete shoulders for stormwater management." *Proceedings of the International Conference on Long-Life Concrete Pavements*, September 18-21, Seattle, WA, USA.
- LADPW (Los Angeles County Department of Public Works). 2002. *Development planning for storm water management*. Los Angeles County, 2002.
- Lampe, L., Andrews, H., Martin, P., Barrett, M., Jefferies, C., Woods-Ballard, B., Kellagher, R., and Hollon, M. 2004. *Post-project Monitoring of BMPs/SUDs to Determine Performance and Whole-Life Costs: Phase 2*. Water Environment Research Foundation, Alexandria, Virginia, USA.
- Lampe, L., Andrews, H., Martin, P., Barrett, M., Woods-Ballard, B., Kellagher, R., Martin, P., Jefferies, C., and Hollon, M. 2005. *Performance and whole life costs of best management practices and sustainable urban drainage systems*. Water Environment Research Foundation, Alexandria, Virginia, USA.
- Legret, M. Colandini, V., and Le Marc, C. 1996. "Effects of porous pavement with reservoir structure on the quality of runoff water and soil." *The Science of the Total Environment*. 189/190: 335-340.
- Leming, M.L., Malcom, H.R., and Tennis, P.D. 2007. *Hydrologic Design of Pervious Concrete*, Portland Cement Association (PCA), Skokie, IL, USA.
- Lindsey, G., L. Roberts and Page, W. 1992. "Inspection and maintenance of infiltration facilities." *Journal of Soil and Water Conservation*. 47(6): 481-486.
- Li, H., Jones, D., and Harvey, J. 2012. Development of mechanistic-empirical design procedure for fully permeable pavement under heavy traffic. *Transportation Research Record*. 2305: 83-94.
- Li, H., Harvey, J.T., Holland, T.J., and Kayhanian, M. 2013a. "The use of reflective and permeable pavements as a potential practice for heat island mitigation and stormwater management." *Environmental Research Letters*, 8: 1-14.
- Li, H., Kayhanian, M., and Harvey, J.T. 2013b. "Comparative field permeability measurement of permeable pavements using ASTM C1701 and NCAT permeameter methods." *Journal of Environmental Management*. 118: 114-152.
- Low, K.; Harz, D.; and Neithalath, N. 2008. "Statistical Characterization of the Pore Structure of Enhanced Porosity Concretes." *Proceedings of the NRMCA Concrete Technology Forum*, May 20-22, Denver, CO.
- Low-Impact Development Center. 2013. *Permeable Paver Costs*. http://www.lid-stormwater.net/permpaver_costs.htm. Web document. Accessed October 31, 2013.

- Lucke, T., and Beecham, S. 2011. "Field investigation of clogging in a permeable pavement system." *Building Research and Information*, 39(6): 603-615.
- Malhotra, V.M. 1976. "No-fines concrete: Its properties and applications." *ACI Journal*. 73(11): 628-644.
- Manahiloh, K.N., Muhunthan, B., Kayhanian, M., and Gebremariam, S.Y. 2012. "X-Ray computed tomography and nondestructive evaluation of clogging in porous concrete field samples." *Journal of Materials in Civil Engineering*. 24(8): 1103-1109.
- Mata, L.A., and Leming, M.L. 2012. "Vertical Distribution of Sediments in Pervious Concrete Pavement Systems." *ACI Materials Journal*. 109(2): 149-155.
- Mbanaso, F.U., Coupe, S.J., Charlesworth, S.M., and Nnadi, E.O. 2013. "Laboratory-based experiments to investigate the impact of glyphosate-containing herbicide on pollution attenuation and biodegradation in a model pervious paving system." *Chemosphere*, 90(2): 737-746.
- McGowen, S., Smith, B., Brindle, F., Davis, V.W., Herbert, R., Lauffer, M., Lewis, J., and Ripka, T. 2009. *Best Practices In Addressing NPDES And Other Water Quality Issues In Highway System Management*. Scan Management, Arora and Associates PC, Lawrenceville, NJ, USA.
- Meininger, R.C. 1988. "No-fines pervious concrete for paving." *Concrete International*. 10(8): 20-27.
- Morgenroth, J. 2011. "Root growth response of *Platanus orientalis* to porous pavements." *Arboric. Urban For.* 37(2): 45-50.
- Morgenroth, J., and Visser, R. 2011. "Above ground growth response of *Platanus orientalis* to porous pavements." *Arboric. Urban For.* 37(1): 1-5.
- Mulligan, A., 2005. *Attainable Compressive Strength of Pervious Concrete Paving Systems*. MS Thesis, University of Central Florida, 132 pp.
- NAPA (National Asphalt Pavement Association). 2008. *Porous asphalt pavements for stormwater management, Design, Construction and maintenance guide*. Information Series 131, NAPA, Lanham, MD, USA.
- NRCS (National Resource Conservation Service, U.S. Department of Agriculture). 1986. *Urban hydrology for small watersheds, TR 55*, Washington D.C.
- Offenberg, M. 2005. "Producing Pervious Pavements." *Concrete International*. 27(3): 50-54.
- Partl, M.N., Momm, F., Bariani, B. 2003. "Study of the aggregate for the pervious asphalt concrete performance testing and evaluation of bituminous materials." *Proceedings of the 6th International RILEM Symposium*. pp. 237-243, April 14-16, Zurich, Switzerland.

- Pennsylvania Department of Environmental Protection (PDEP) Bureau of Watershed Management. 2006. *Pennsylvania Stormwater Best Management Practices Manual*. PDEP, Harrisburg, PA, USA.
- Pratt, C.J., Newman, A.P., and Bond, P.C. 1999. "Mineral oil bio-degradations within a permeable pavement: Long term observations." *Water Science and Technology*. 39(2): 103-109.
- Ravindrarajah, S., Yukari, A. 2010. "Environmentally friendly concrete for sustainable construction." *Proceedings from the 35th Conference on Our World in Concrete & Structures*, August 25-27, Singapore.
- Roseen, R.M., Ballesterro, T.P., Houle, J.J., Avellaneda, P., Briggs, J., Fowler, G., and Wildey, R. 2009. "Seasonal performance variations for storm-water management systems in cold climate conditions." *Journal of Environmental Engineering*. 135(3): 128-137.
- Roseen, R.M., Ballesterro, T.P., Houle, J.J., Avellaneda, P., Briggs, J., and Houle, K.M. 2012. "Water quality and hydrologic performance of a porous asphalt pavement as a storm-water treatment strategy in a cold climate." *Journal of Environmental Engineering*. 138(1): 81-89.
- Rowe, A. A., Borst, M., O'Connor, T.P., and Stander, E.K. 2010. "Permeable pavement demonstration at the Edison Environmental Center," in *Proceedings, Low Impact Development 2010: Redefining Water in the City*, 2010 ASCE, April, Reston, VA.
- Sata, V., Wongsu, A., and Chindaprasirt, P. 2013. "Properties of pervious geopolymer concrete using recycled aggregates." *Construction and Building Materials*. 42: 33-39.
- Schaefer, V.R., Wang, K., Suleiman, M.T., and Kevern, J.T. 2006. *Mix Design Development for Pervious Concrete In Cold Weather Climates*, Iowa Department of Transportation, Ames, IA, USA.
- Scholz, M., 2013. "Water Quality Improvement Performance of Geotextiles Within Permeable Pavement Systems: A Critical Review." *Water*. 5: 462-479.
- Scholz M, and Grabowiecki P. 2009. "Combined permeable pavement and ground source heat pump systems to treat urban runoff." *J Chem Technol Biotechnol*. 84(3): 405-413.
- Schwartz, S.S. 2010. "Effective CN and hydrologic design of pervious concrete storm-water systems." *Journal of Hydrologic Engineering*. 15(6): 465-474.
- SI Concrete Systems. 2002. *Fiber-Reinforced Pervious Concrete*. Project 2120-36, SI Concrete Systems, Chattanooga, TN.
- Sieglen, W.E., and Von-Langsdorff, H. 2004. "Interlocking Concrete Block Pavements at Howland Hook Marine Terminal." *Proceedings of Port Development in the Changing World*, pp. 10. May 23-26, Houston, TX.

- Smith, David R. 2011. *Permeable Interlocking Concrete Pavements, 4th edition*. Interlocking Concrete Pavement Institute (ICPI), Herndon, VA, USA.
- Shackel, B. 1995. *Infiltration and Structural Tests of UNI Eco-Loc and UNI Eco-Stone Paving*. School of Civil Engineering, University of New South Wales, Australia.
- Shu, X., Huang, B., Wu, H., Dong, Q., and Burdette, E.G. 2011. "Performance comparison of laboratory and field produced pervious concrete mixtures." *Construction and Building Materials*. 25: 3187–3192.
- Sonebi, M., and Bassuoni, M.T. 2013. "Investigating the effect of mixture design parameters on pervious concrete by statistical modeling." *Construction and Building Materials*. 38: 147-154.
- St. John, M.S., and Horner, R.R. 1997. *Effect of Road Shoulder Treatments on Highway Runoff Quality and Quantity*, Washington State Transportation Center, University of Washington, Seattle, WA.
- Sumanasooriya, M.S., Deo, O., and Neithalath, N. 2012. "Particle Packing-Based Material Design Methodology for Pervious Concretes." *ACI Materials Journal*. 109(2): 205-214.
- Thomle, J.N. 2010. "The Declining pH of Waters Exposed to Pervious Concrete." MS Thesis, Department of Civil and Environmental Engineering, Washington State University, Pullman, WA, USA
- Tyner, J.S., Wright, W.C., and Dobbs, P.A. 2009. "Increasing exfiltration from pervious concrete and temperature monitoring." *Journal of Environmental Management*. 90(8): 2636-2641.
- Urban Drainage and Flood Control District (UDFCD). 2010. *Urban Storm Drainage Criteria Manual, version 3*. Urban Drainage and Flood Control District, Denver, CO.
- Urban Drainage and Flood Control District (UDFCD). 2011a. *Stormwater Quality Monitoring Report Permeable Interlocking Concrete Pavement (PICP) at Denver Wastewater Management Building Denver, Colorado 2008-2010*. UDFCD, Denver, CO, USA.
- Urban Drainage and Flood Control District (UDFCD). 2011b. *Stormwater Quality Monitoring Report Porous Asphalt at Denver Wastewater Management Building Denver, Colorado 2008-2010*. UDFCD, Denver, CO, USA.
- UNHSC (University of New Hampshire Stormwater Center). 2007. *University of New Hampshire Stormwater Center Annual Report*, Durham, NH, USA. University of New Hampshire Stormwater Center.
- UNHSC (University of New Hampshire Stormwater Center). 2009. *UNHSC Design specifications for porous asphalt pavement and infiltration beds*. University of New Hampshire, Durham, NH, USA.
- USEPA (United States Environmental Protection Agency), Office of Water. 1999. *Storm water Technology fact sheet: Porous pavement*, EPA 832-F-99-023.

- Walker, M. 2012. "Pervious, Permeable, and Porous Pavers – Are they really the same?" Water Environment Federation Stormwater Report, 3(10).
- Wanielista, M., Chopra, M. 2007a. *Performance Assessment of a Pervious Concrete Pavement, Report 3 of 4: Compressive strength of pervious concrete pavements*. Stormwater Management Academy, University of Central Florida, Orlando, FL, USA.
- Wanielista, M., Chopra, M. 2007b. *Performance Assessment of a Pervious Concrete Pavement Used as a Shoulder for an Interstate Rest Area Parking Lot*. Stormwater Management Academy, University of Central Florida, Orlando, FL, USA.
- Wang, T., Harvey, J., and Jones, D. 2010. *A framework for life-cycle cost analyses and environmental life-cycle assessments for fully permeable pavements*. California Department of Transportation (Caltrans), Sacramento, CA, USA.
- Wardynski, B.J., Winston, R.J., and Hunt, W.F., 2013. "Internal water storage enhances exfiltration and thermal load reduction from permeable pavement in the North Carolina mountains." *Journal of Environmental Engineering*. 139(2): 187-195.
- Welker, A. L., Barbis, J.D., and Jeffers, P.A., 2012. "A side-by-side comparison of pervious concrete and porous asphalt." *Journal of the American Water Resources Association*, 48(4): 809-819.
- Wenck Associates, Inc. 2014. *Porous pavement paired intersection study*, prepared for the Shingle Creek Watershed Management Commission, City of Robbinsdale, MN, and the Minnesota Pollution Control Agency, Maple Plain, MN, USA.
- Worel, B., Frentress, D. P., and Clendenen, J. 2007. *2006 MnROAD – Pervious Concrete Project Pervious Concrete Sidewalk Project*. Minnesota Department of Transportation, Maplewood, MN, USA.
- Wu, H., Huang, B., Shu, X., Dong, Q. 2011. "Laboratory evaluation of abrasion resistance of Portland Cement pervious concrete." *Journal of Materials in Civil Engineering*, 23(5): 697-702.
- Yang, Z., 2011. "Freezing and thawing durability of pervious concrete under simulated field conditions." *ACI Materials Journal*. 108(2): 187-195.
- Yang, Z., Brown, H., and Cheney, A. 2006. "Influence of Moisture Conditions on Freeze and Thaw Durability of Portland Cement Pervious Concrete." *Proceedings of Concrete Technology Forum: Focus on Pervious Concrete*, May 24-25, Nashville, Tennessee.
- Yong, C., Deletic, A., Fletcher, T. and Grace, M. 2008. "The clogging behaviour and treatment efficiency of a range of porous pavements." *Proceedings from the 11th International Conference on Urban Drainage*. pp. 1-10, August-September, Edinburgh, Scotland.
- Yong, C.F., McCarthy, D.T., and Deletic, A. 2013. "Predicting physical clogging of porous and permeable pavements." *Journal of Hydrology*. 481: 48-55.

Yang, J. and Jian, G. 2003. "Experimental study on properties of pervious concrete pavement materials." *Cement and Concrete Research*. 33(3): 381.

Zement. 2003. *Regenwasserversickerung durch Pflasterflächen, Bauerberatung Zement-Merkblatt strassenbau*, bundesverband der Deutsche Zementindustrie e.v., www.bdzement.de, June, Köln, Germany, S 15.