

COrE+

The Cosmic Origins Explorer

A proposal for ESA's M4 space mission

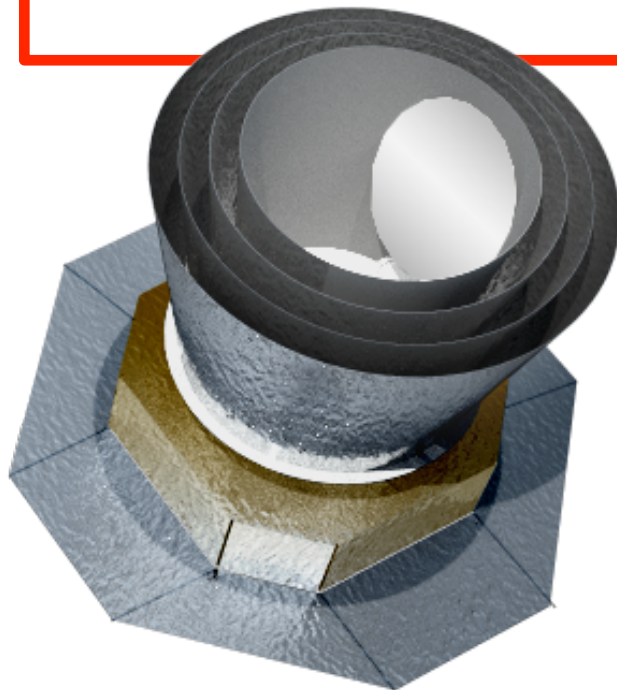

Jacques Delabrouille

Laboratoire APC, Paris, France

On behalf of the COrE+ Collaboration



Outline

- ➔ • Tensor modes with a future mission?
- Beyond primary CMB science
- Why a space mission ?
- COrE+
- Conclusion

Many proposed Post-Planck CMB missions

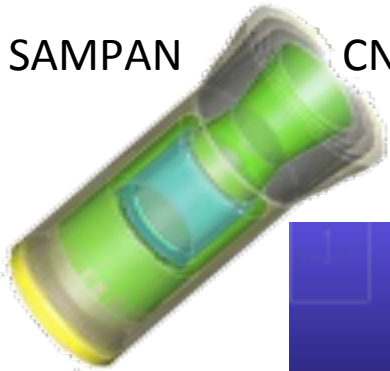

SAMPAN

CNES 2006

NASA 2008 EPIC-IM

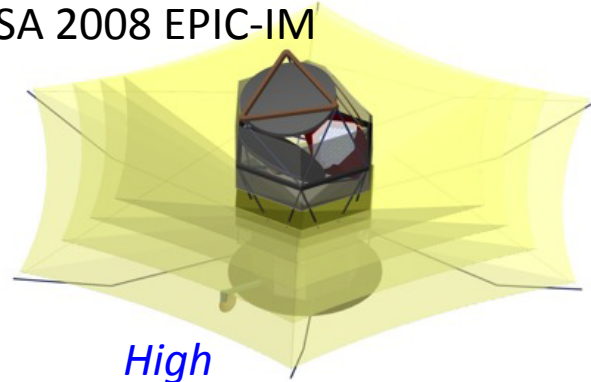

High resolution

CoRE
ESA 2010



Many frequency bands

BPOL
ESA 2007

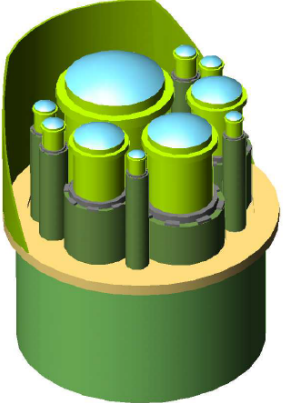

JAXA 2008

LiteBIRD

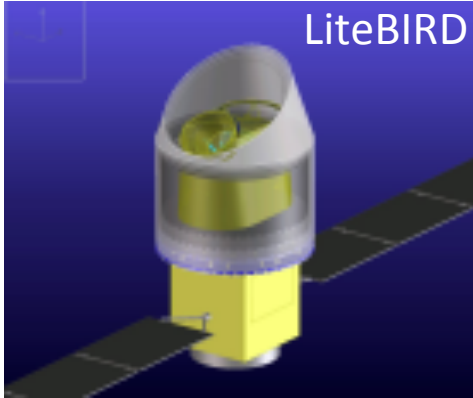

Absolute spectrophotometer

NASA
PIXIE

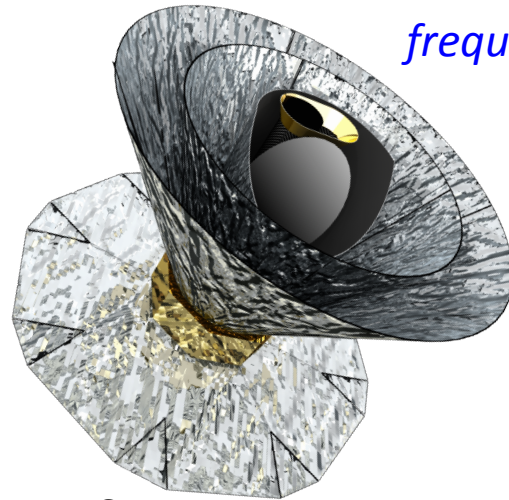
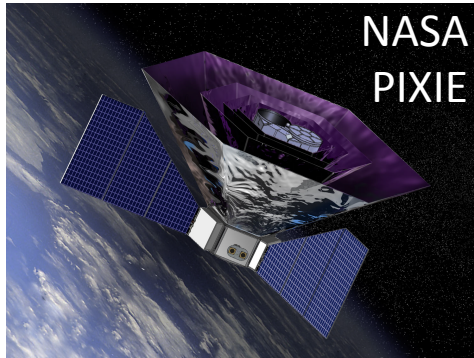

PRISM
ESA 2013

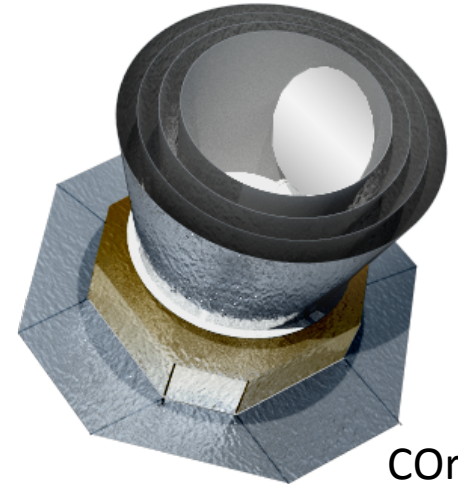

CoRE+
ESA 2015

Low resolution

Limited frequency coverage

Primary CMB B-modes

More comprehensive science cases

(spectroscopy, sub-mm astronomy, astrophysical cosmology)

Polarisation B-modes

Objective: CMB B-modes (primordial and lensing)

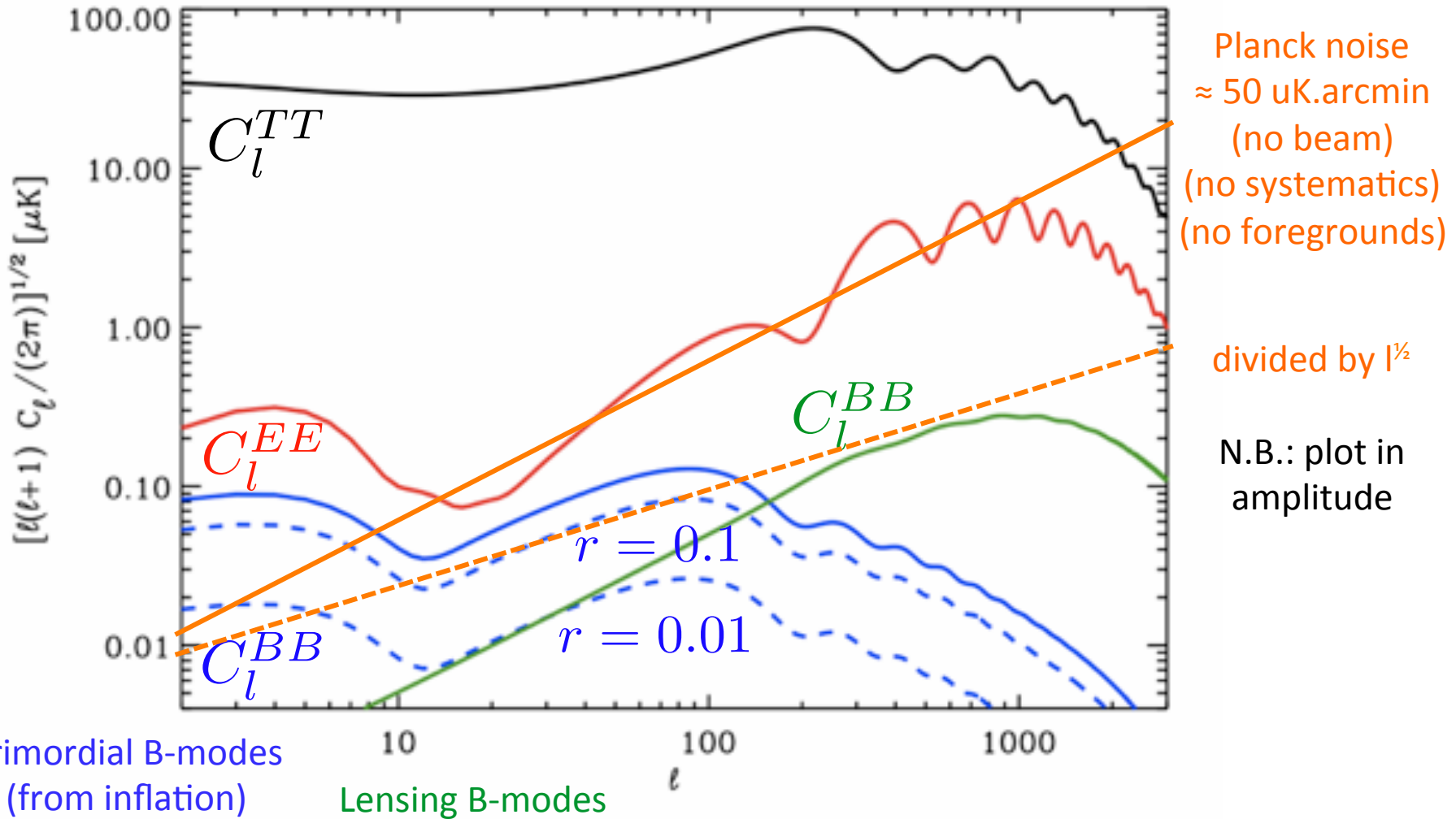

Polarisation B-modes

Objective: CMB B-modes (primordial and lensing)

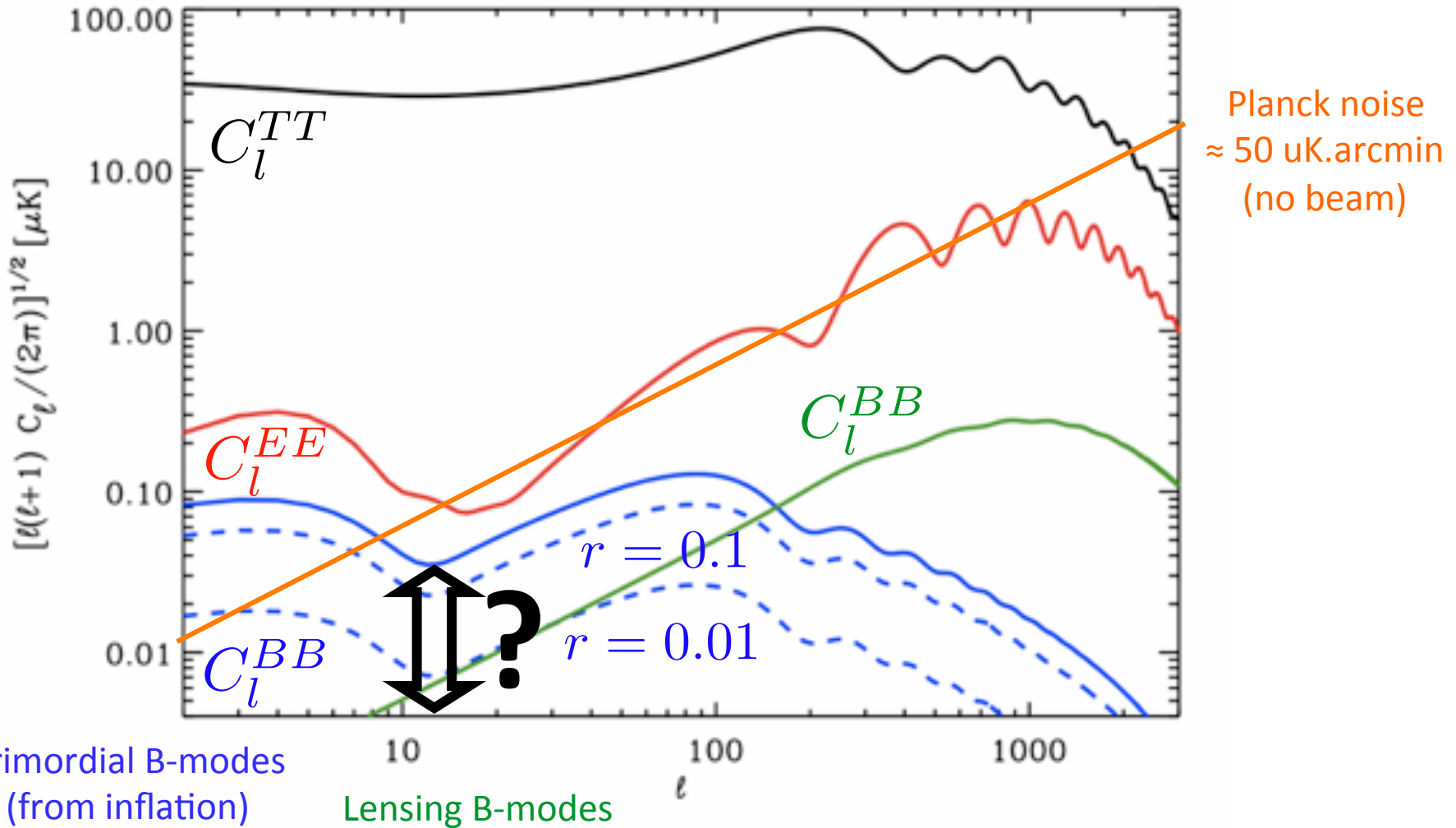

Early Universe : physics at 10^{16} GeV

Initial perturbations

- scalar (density)
- tensor (gravity waves)

depend on the potential $V(\phi)$ and derivatives:

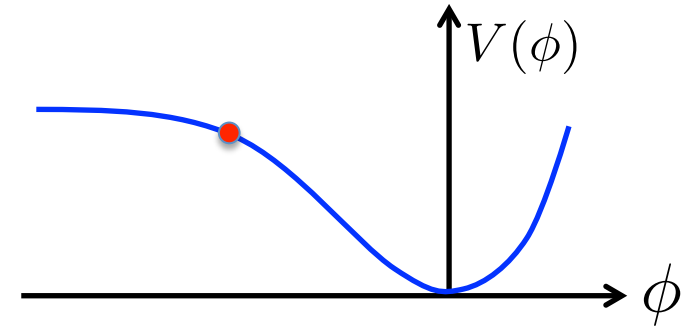

- scalar spectral index $n_S - 1$
- running $\frac{dn_S}{d \ln k}$
- tensor/scalar ratio $r = T/S$
- tensor spectral index n_T

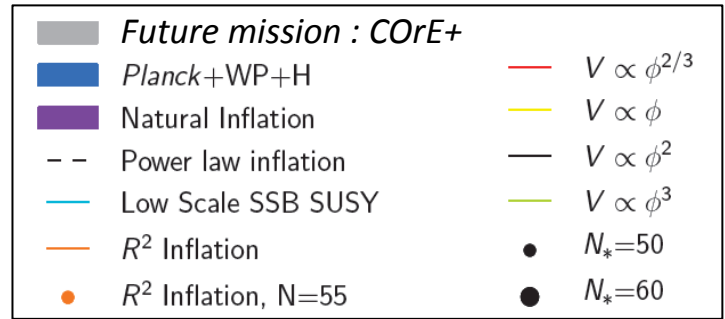
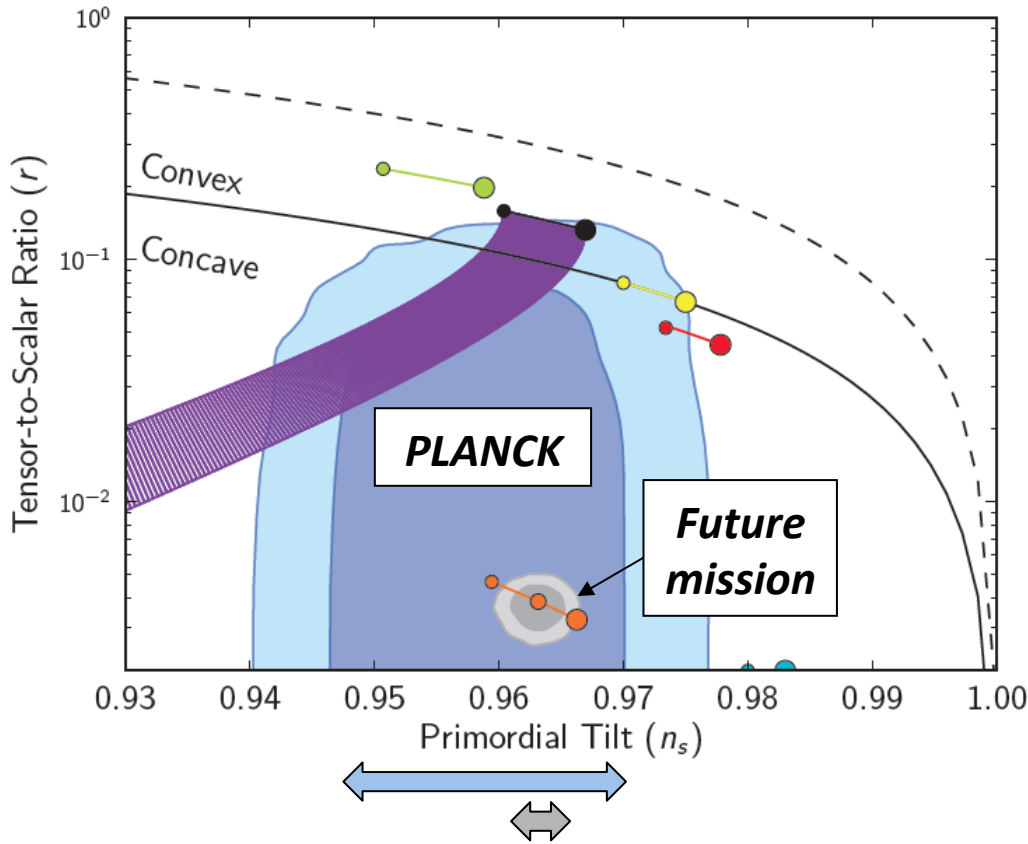

Measure r
with $\delta r < 10^{-3}$

- Particularly interesting values of r
- $r \approx 0.1-0.15$
 - $r \approx 2-3 \times 10^{-3}$

Evaluation of PRISM L-scale mission proposed science (early 2014):
 " The SSC was fully convinced of the great importance of the core CMB science and encourages the CMB community to consider proposing this science for a future M-class mission."

Fundamental limitations

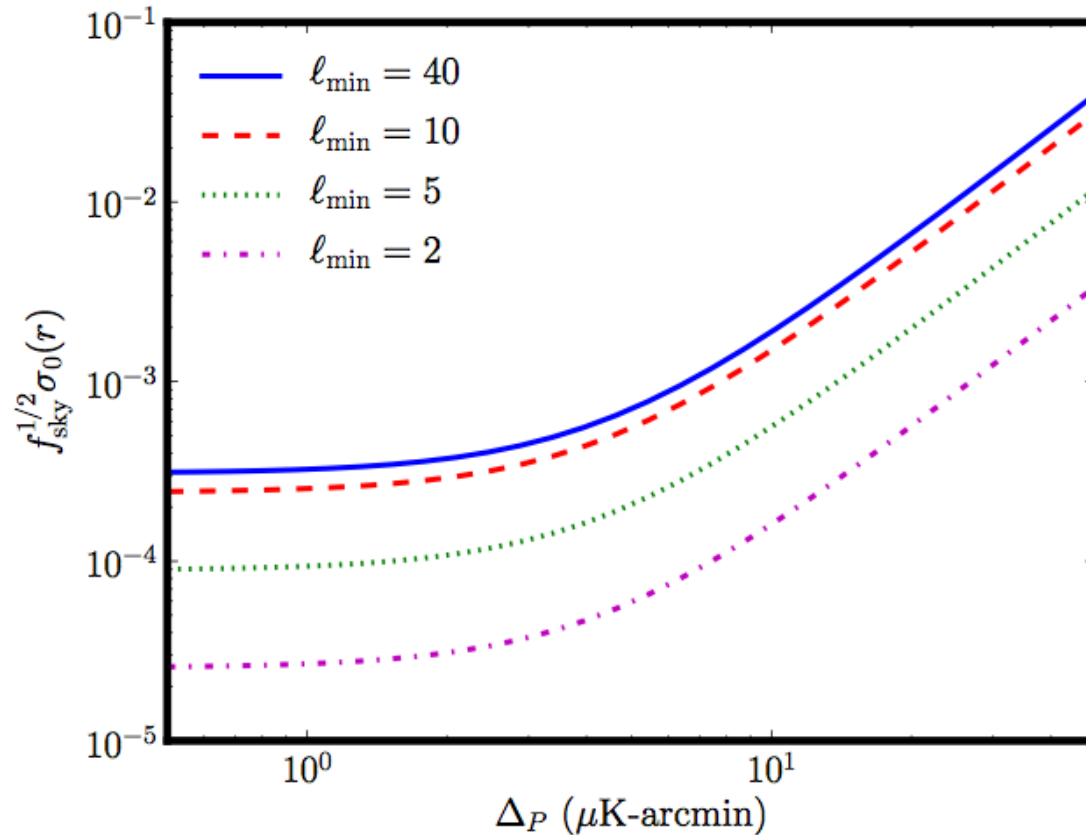

Figure 2: Statistical error $\sigma_0(r)$ on the tensor-to-scalar ratio for varying noise level, assuming no delensing has been done. The forecast is strongly dependent on whether the reionization B-mode signal at $\ell \lesssim 10$ is assumed measurable in the presence of sky cuts and Galactic foregrounds. The value of $\sigma_0(r)$ levels off for noise levels $\lesssim 4.4 \mu\text{K-arcmin}$ since the observations have become lensing-limited.

Fundamental limitations: lensing confusion

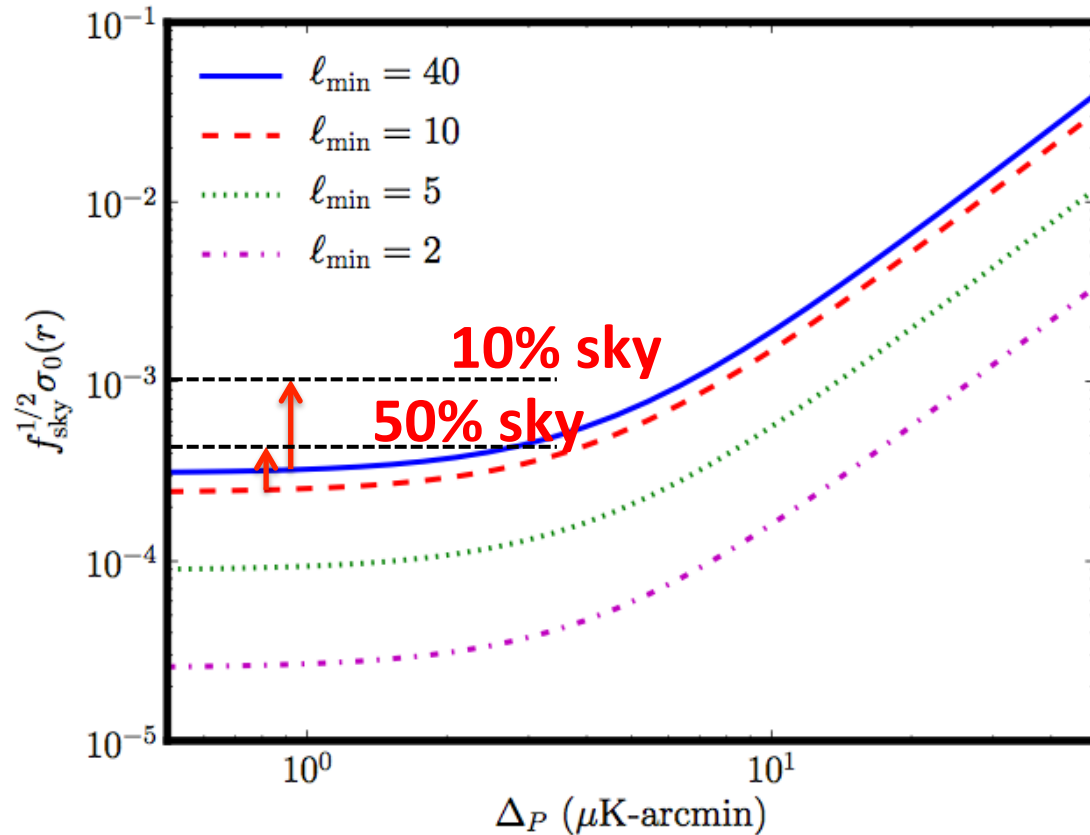
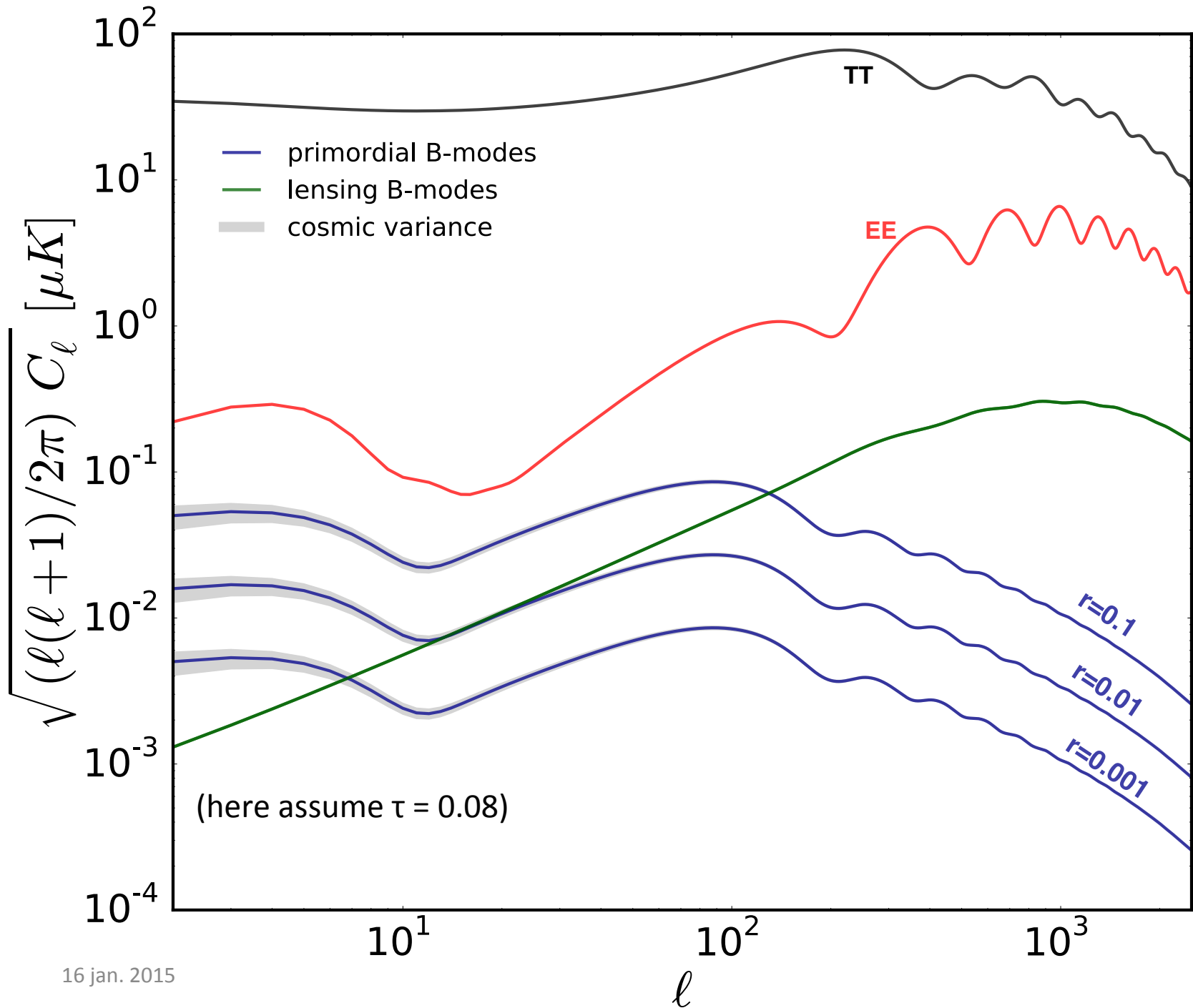

Figure 2: Statistical error $\sigma_0(r)$ on the tensor-to-scalar ratio for varying noise level, assuming no delensing has been done. The forecast is strongly dependent on whether the reionization B-mode signal at $\ell \lesssim 10$ is assumed measurable in the presence of sky cuts and Galactic foregrounds. The value of $\sigma_0(r)$ levels off for noise levels $\lesssim 4.4 \mu\text{K-arcmin}$ since the observations have become lensing-limited.



Fundamental limitations

OTHER OPTION
USE TRACER OF MASS

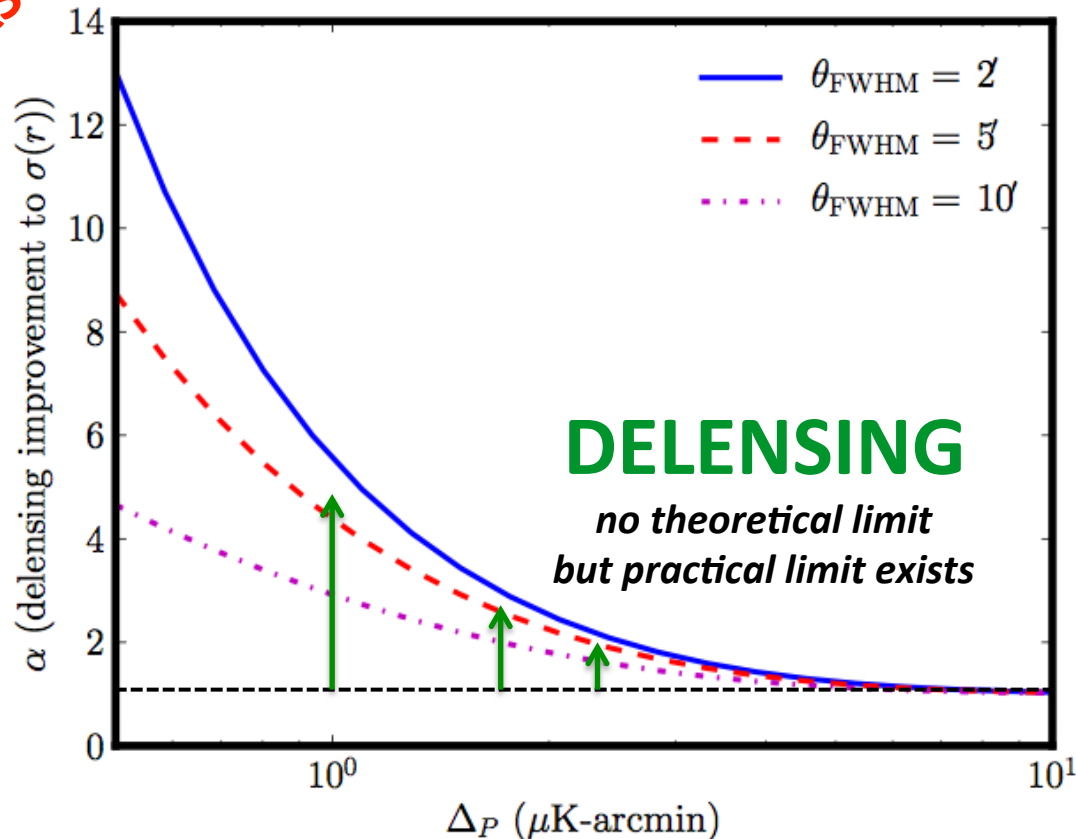
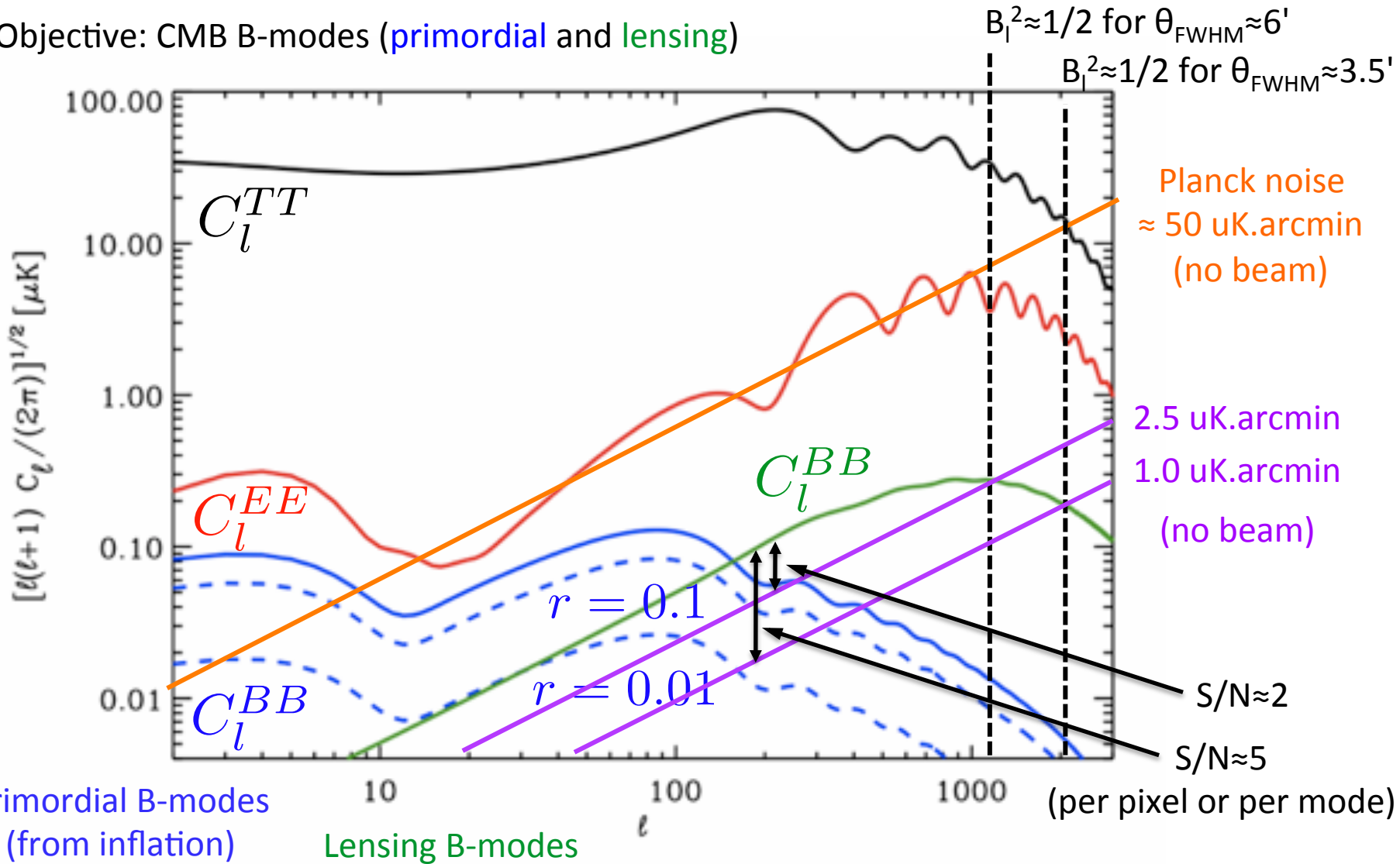

Figure 3: Forecasted improvement $\alpha = \sigma_0(r)/\sigma(r)$ in the statistical error on r due to polarization delensing, for varying noise level and beam. In the limit of low noise and high resolution, we find no limit (from delensing residuals alone) to how well r can be measured.

Next : Polarisation B-modes

Objective: CMB B-modes (primordial and lensing)



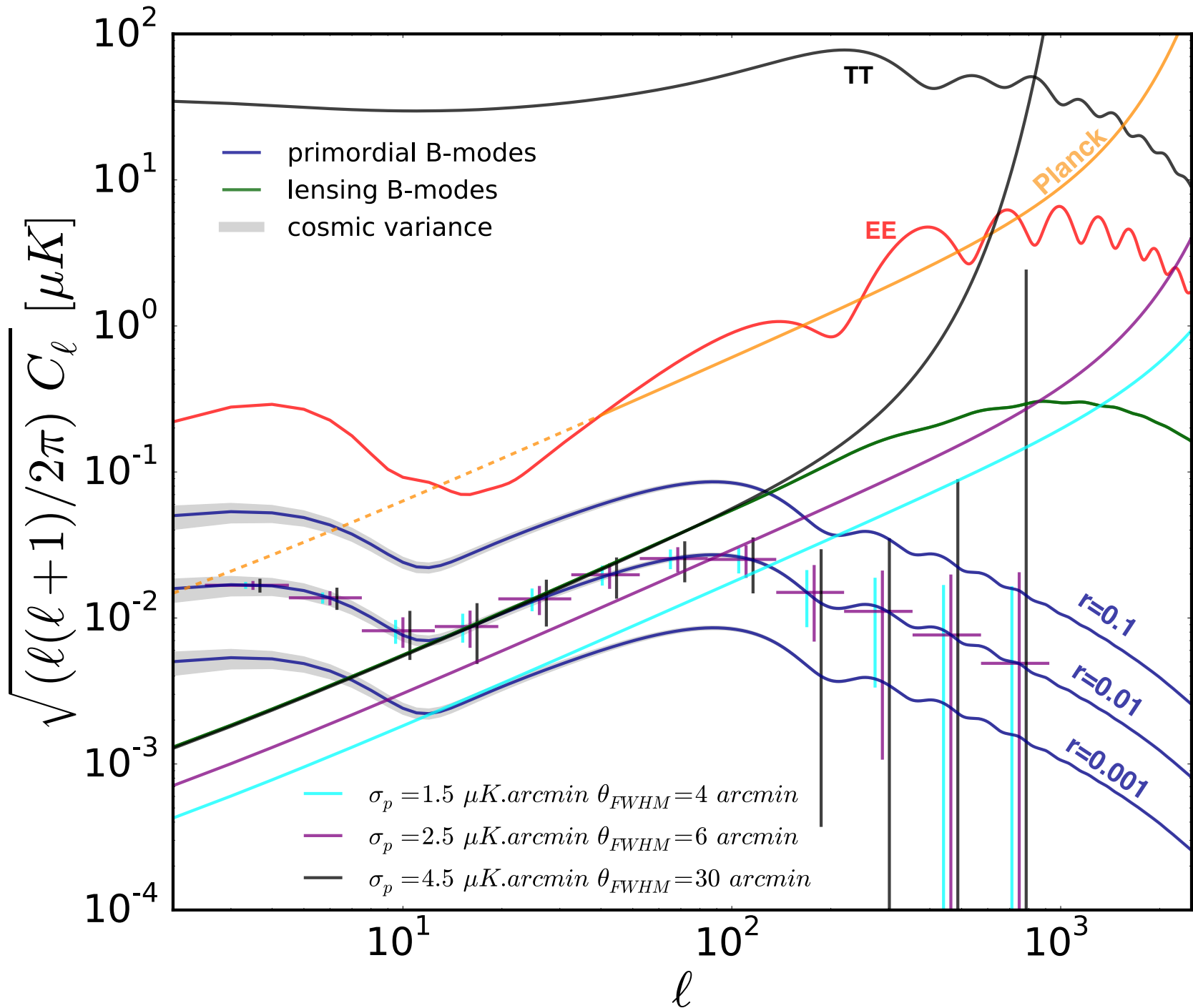

Figure by Josquin Errard

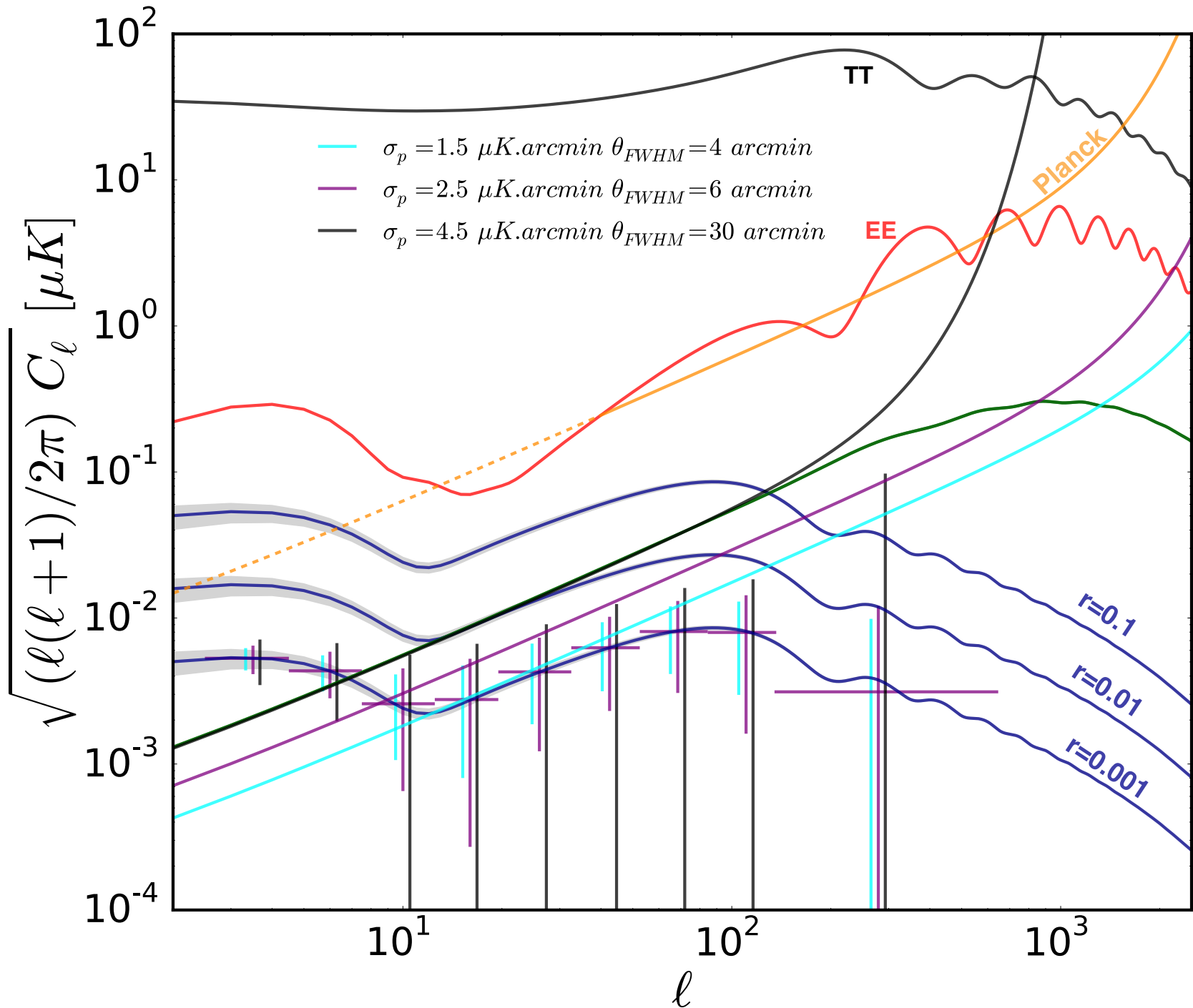

Figure by Josquin Errard

What space mission ?

There is a strong incentive to reach
 $r \approx 2-3 \times 10^{-3}$ at 5σ

This can be achieved with a reasonably-sized space mission with large sky coverage and some de-lensing.

Sensitivity between 1.5 et 2.5 $\mu\text{K}\cdot\text{arcmin}$
 $\approx 2000-6000$ detectors in space

CMB angular resolution between 4' et 6'
(class ≈ 1.5 m telescope)

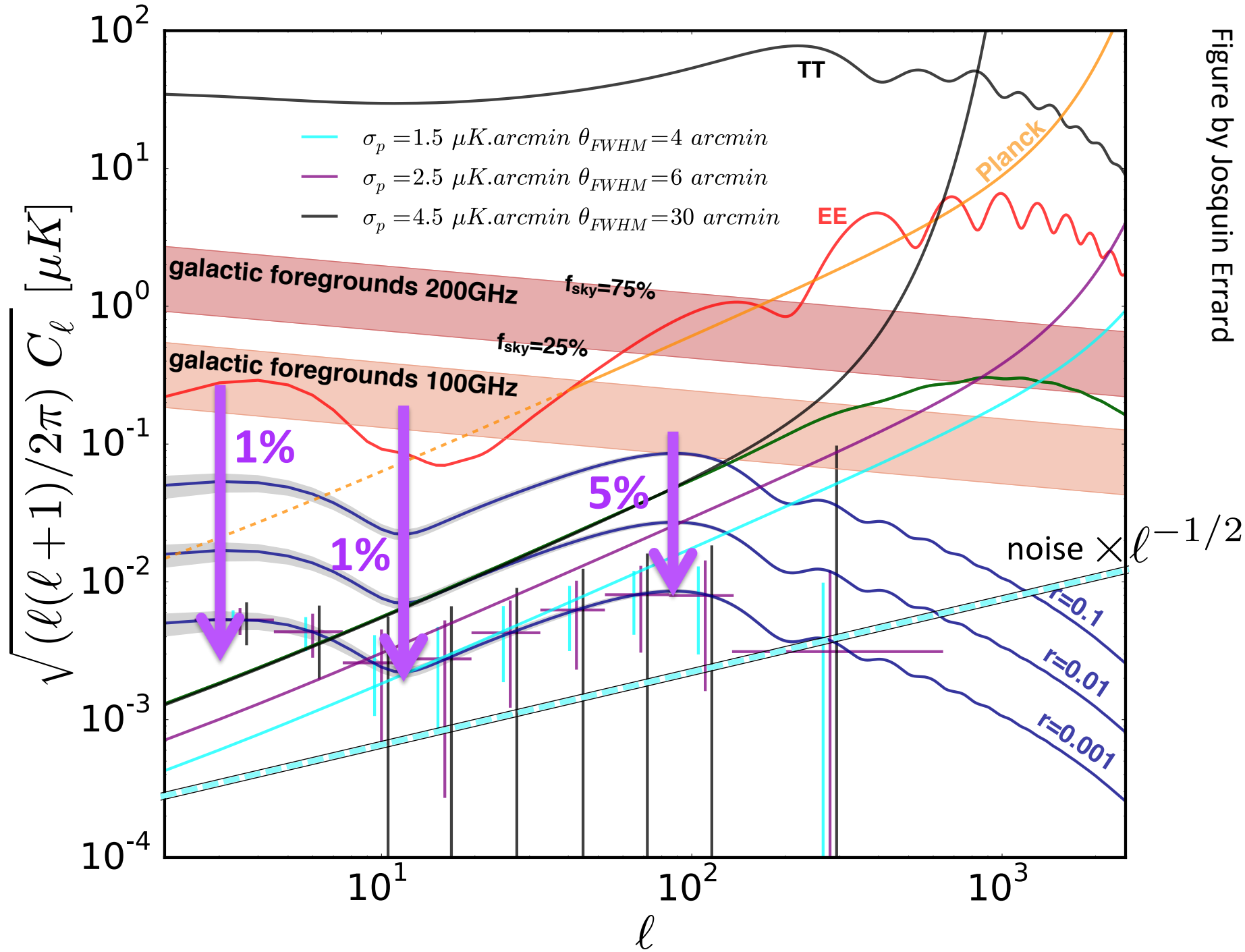

Figure by Josquin Errard

What space mission ?

Enough channels to separate CMB from foregrounds

Well motivated target for r , but
exceptional science guaranteed for all values of r
(inflation + lensing + foreground science).

This is the (near-) ultimate CMB polarisation mission.

(No spectral distortions of the continuum)

Outline

- Tensor modes with a future mission?
- ➔ • Beyond primary CMB science
 - Why a space mission ?
 - COrE+
 - Conclusion

CMB lensing

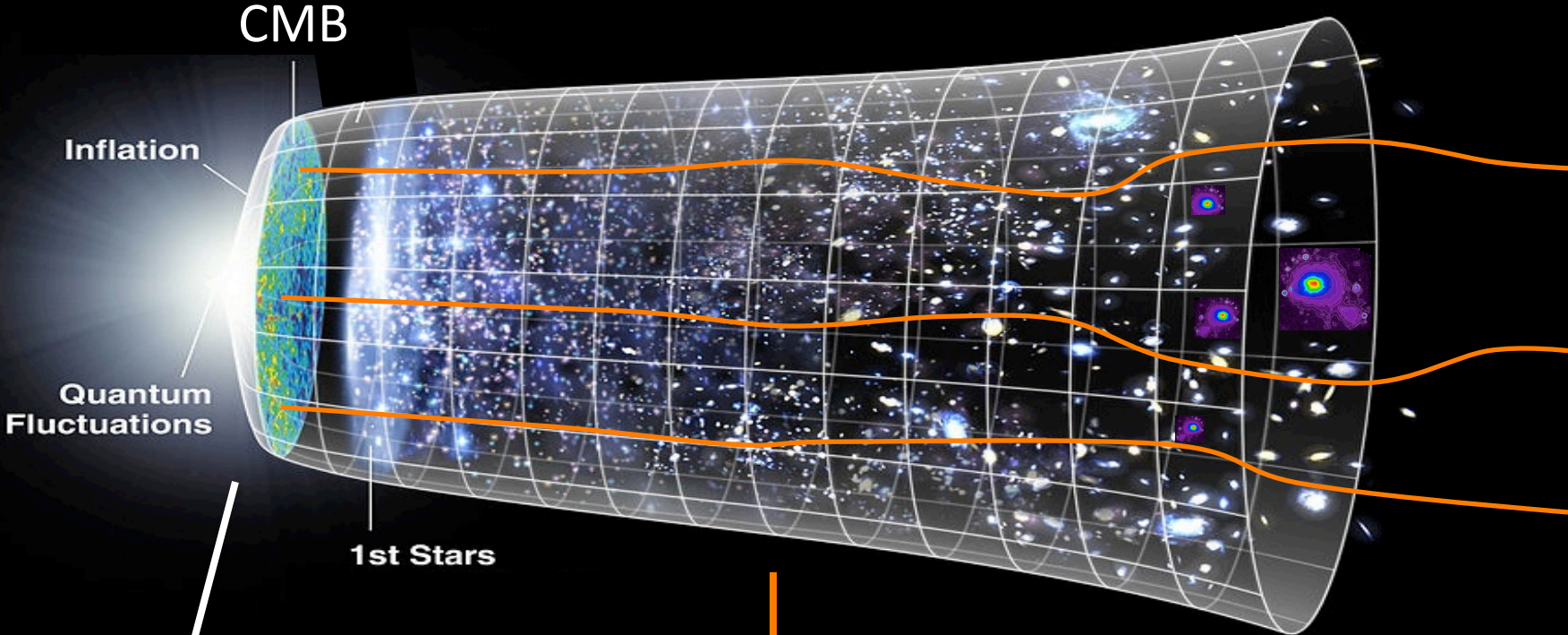

Inflation
Physics at $\approx 10^{16}$ GeV
 $E_{\text{CORe}^+} > 10^{12} \times E_{\text{LHC}}$

$z \approx 1-3$
Gravitational lensing
Dark matter distribution

Uros Seljak's talk

T (unlensed) and lensing potential

Unlensed Temperature

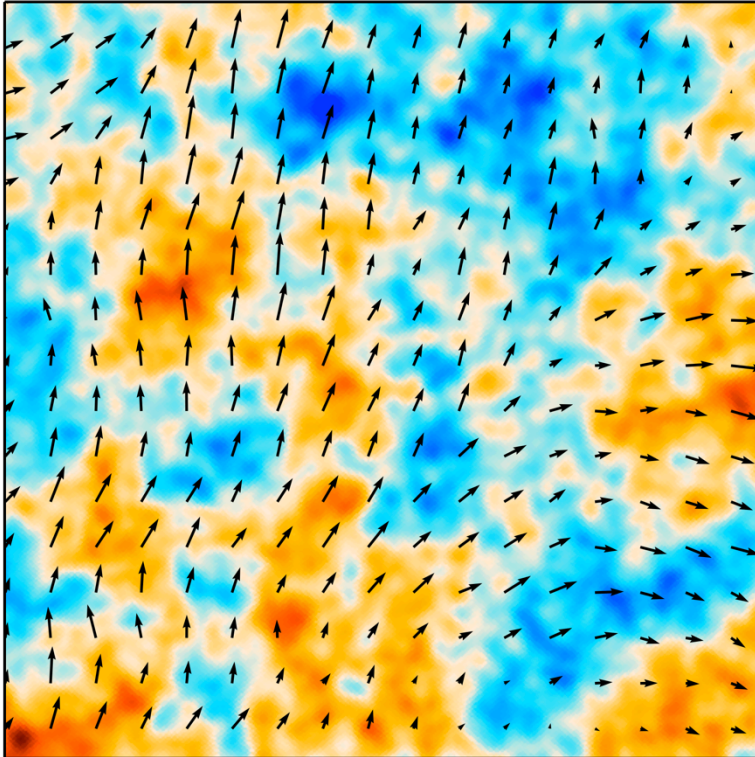

Lensing Potential

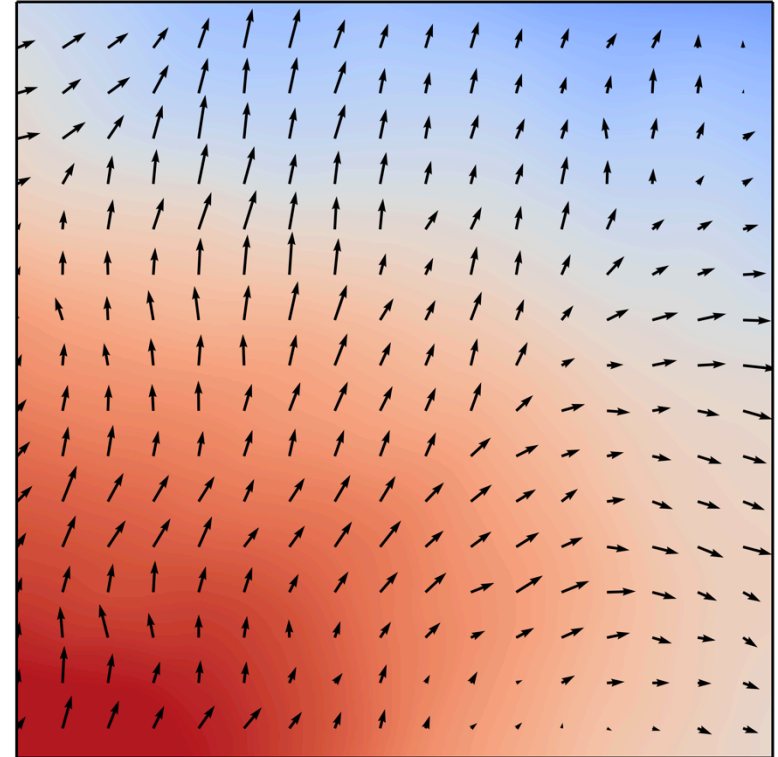

Figures by Ata Karakci

T (lensed) and lensing potential

Lensed Temperature

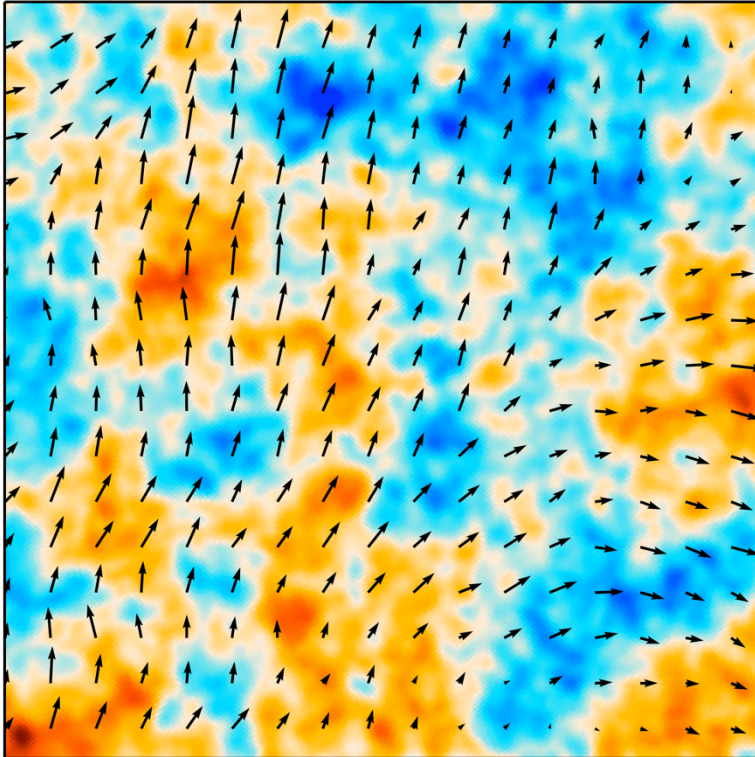

Lensing Potential

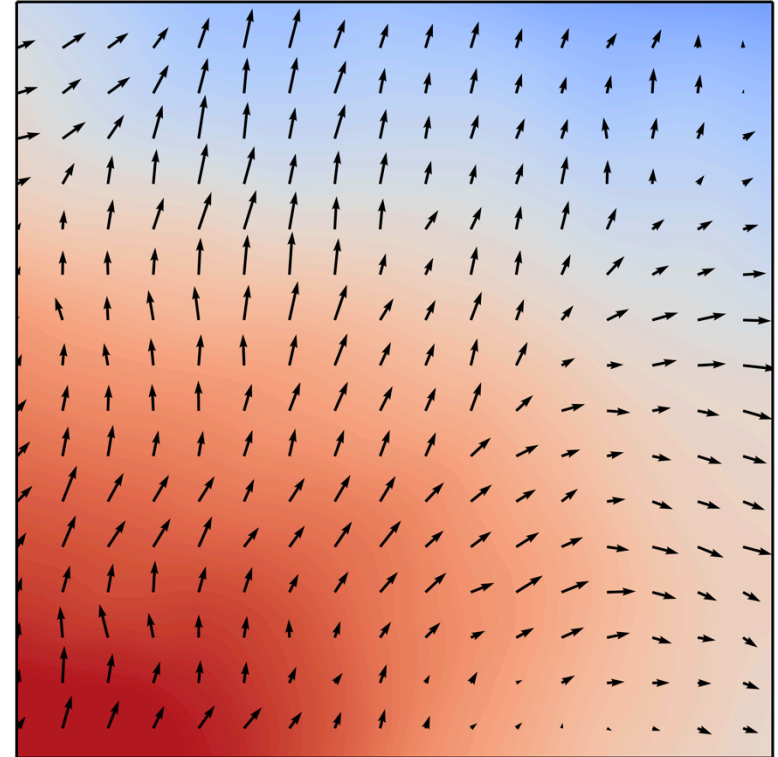

Figures by Ata Karakci

E, B (unlensed) $r=0.01$

Unlensed E-Modes

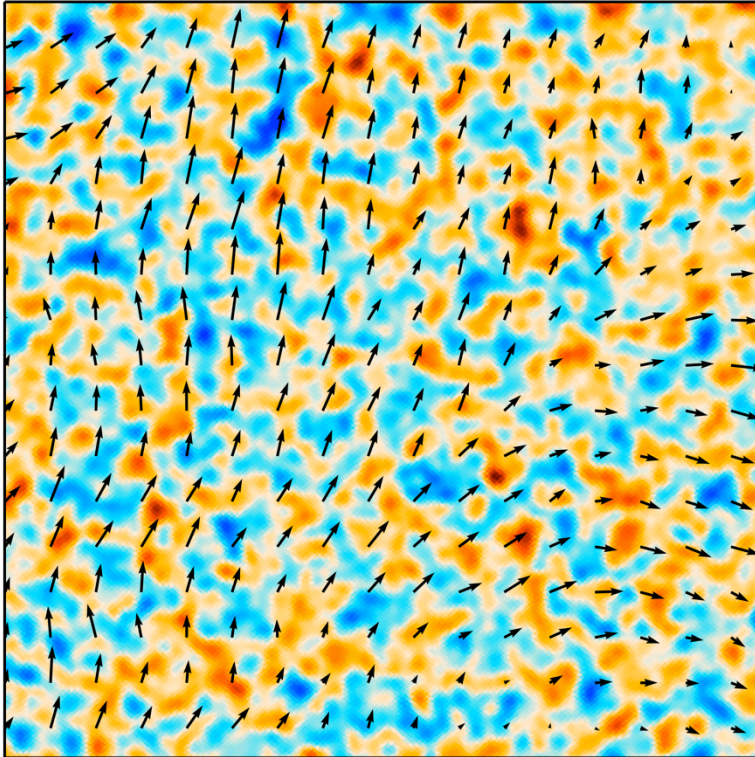

Unlensed B-Modes

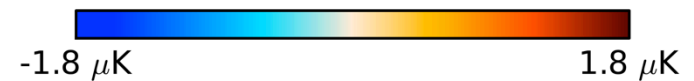
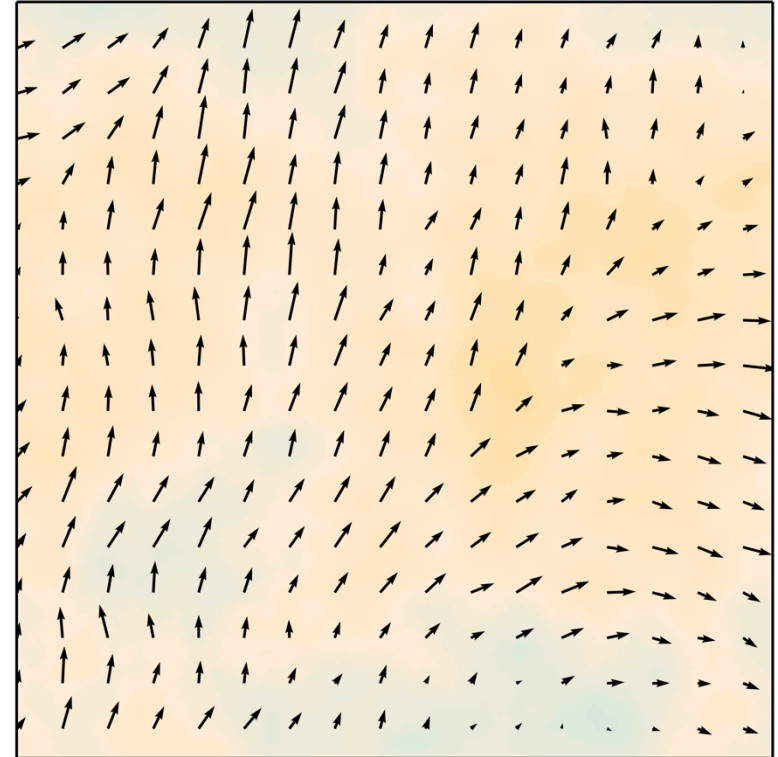

Figures by Ata Karakci

E, B (lensed) $r=0.01$

Lensed E-Modes

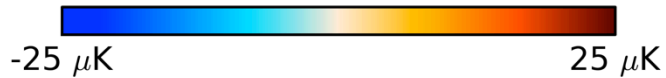
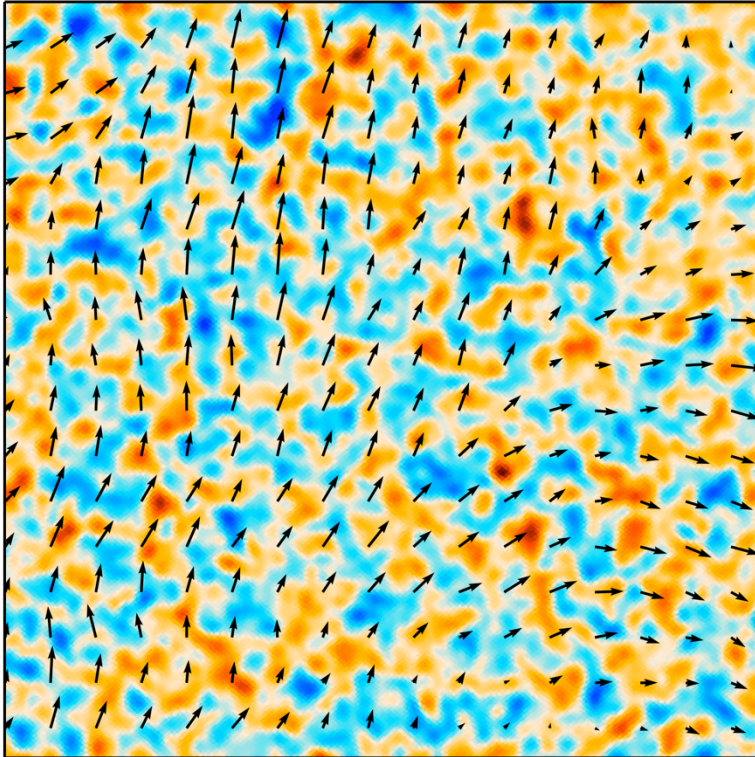

Lensed B-Modes

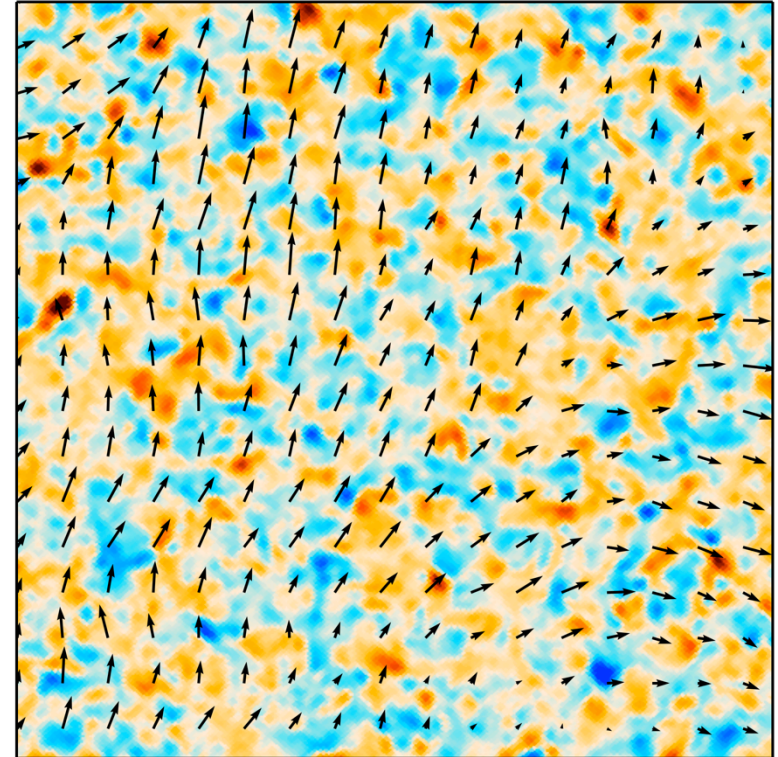

Figures by Ata Karakci

Reconstruction of the lensing potential

Input

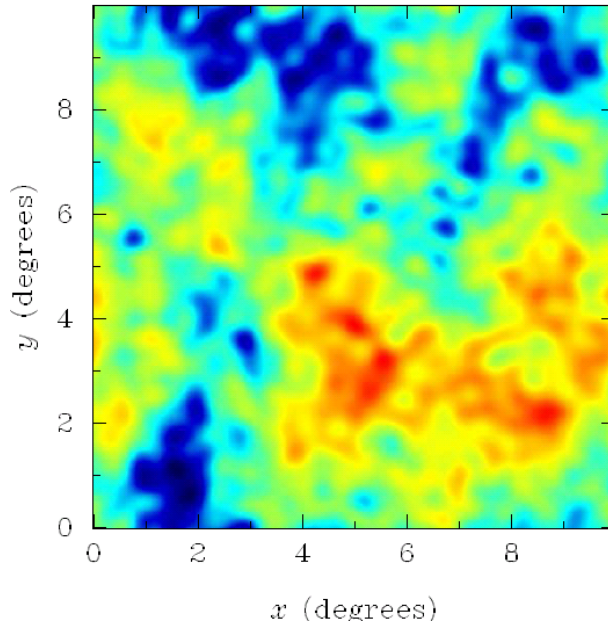

Future

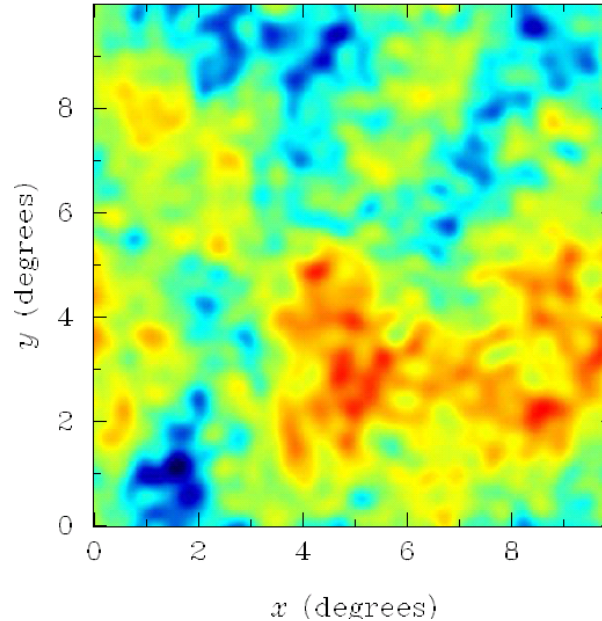

Planck (simulation)

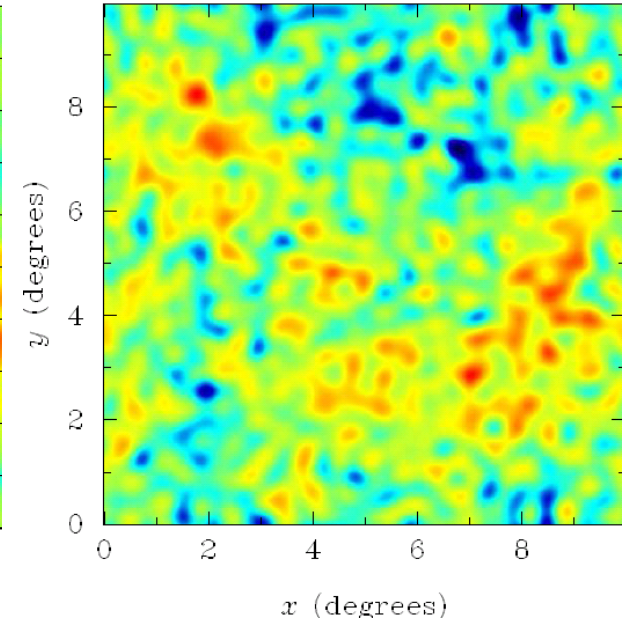

- **COrE+** : High-fidelity reconstruction of the integral of the gravitational potential all the way to recombination.
- Direct detection of dark matter structures...

Reconstruction of the lensing potential

3 unknowns

Φ
 T_{LSS}
 E_{LSS}

3 observations

T_{OBS}
 E_{OBS}
 B_{OBS}

Reconstruction of the lensing potential

Impact of sensitivity $\Delta T = \Delta P / \sqrt{2}$

Hu & Okamoto, 2002, ApJ 574, 566

- Temperature only
- Polarisation (E-B correlation)

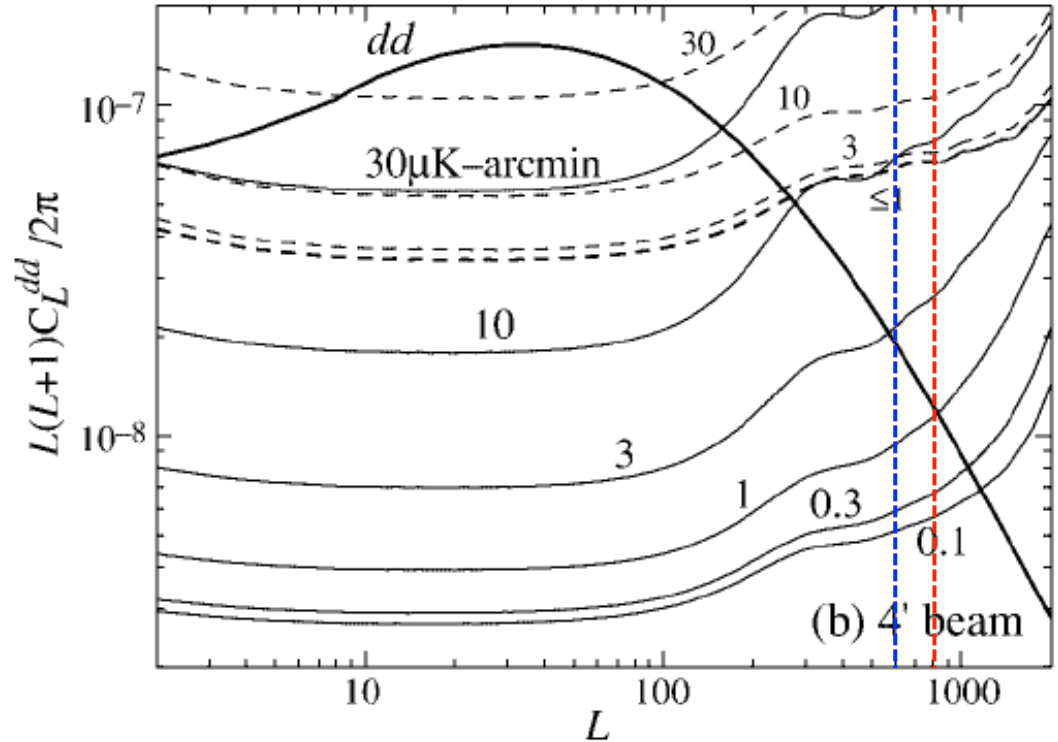
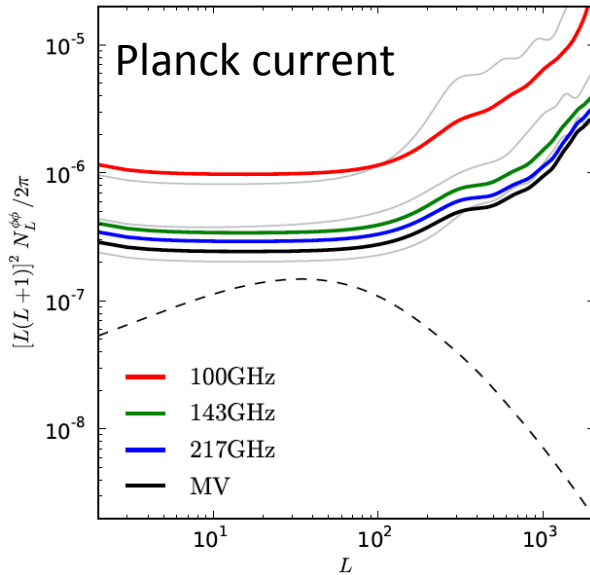

Objective: $\Delta T \approx 1 \mu\text{K. arcmin}$

20' 15'

Reconstruction of the lensing potential

Impact of angular resolution

Hu & Okamoto, 2002, ApJ 574, 566

- Temperature only
- Polarisation (E-B correlation)

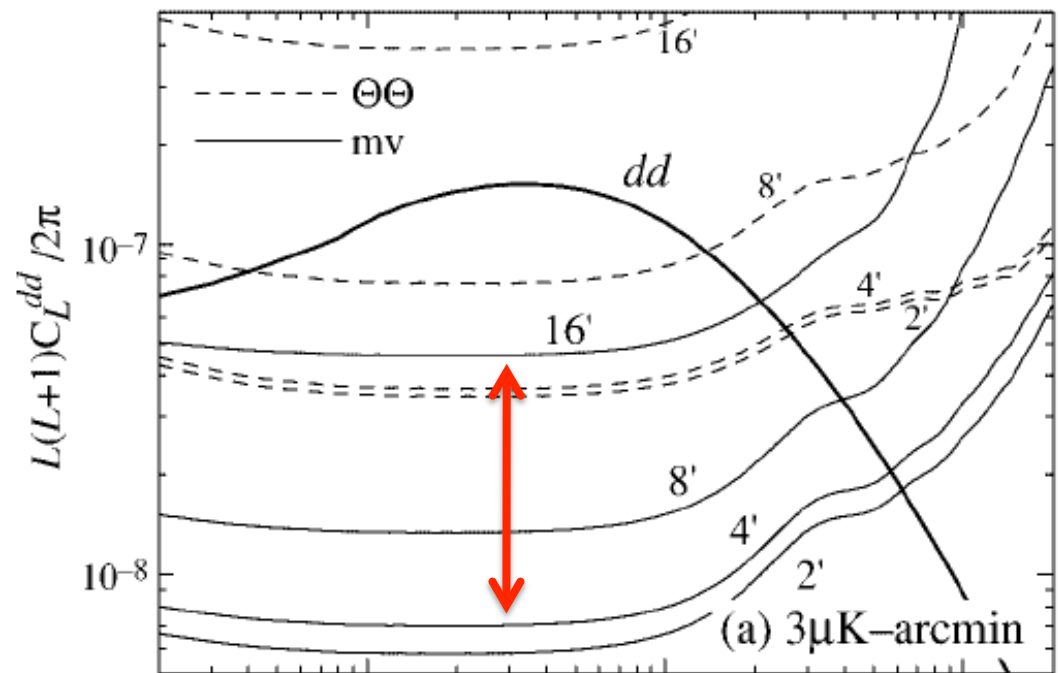

Objective: 4' resolution

Reconstruction of the lensing potential

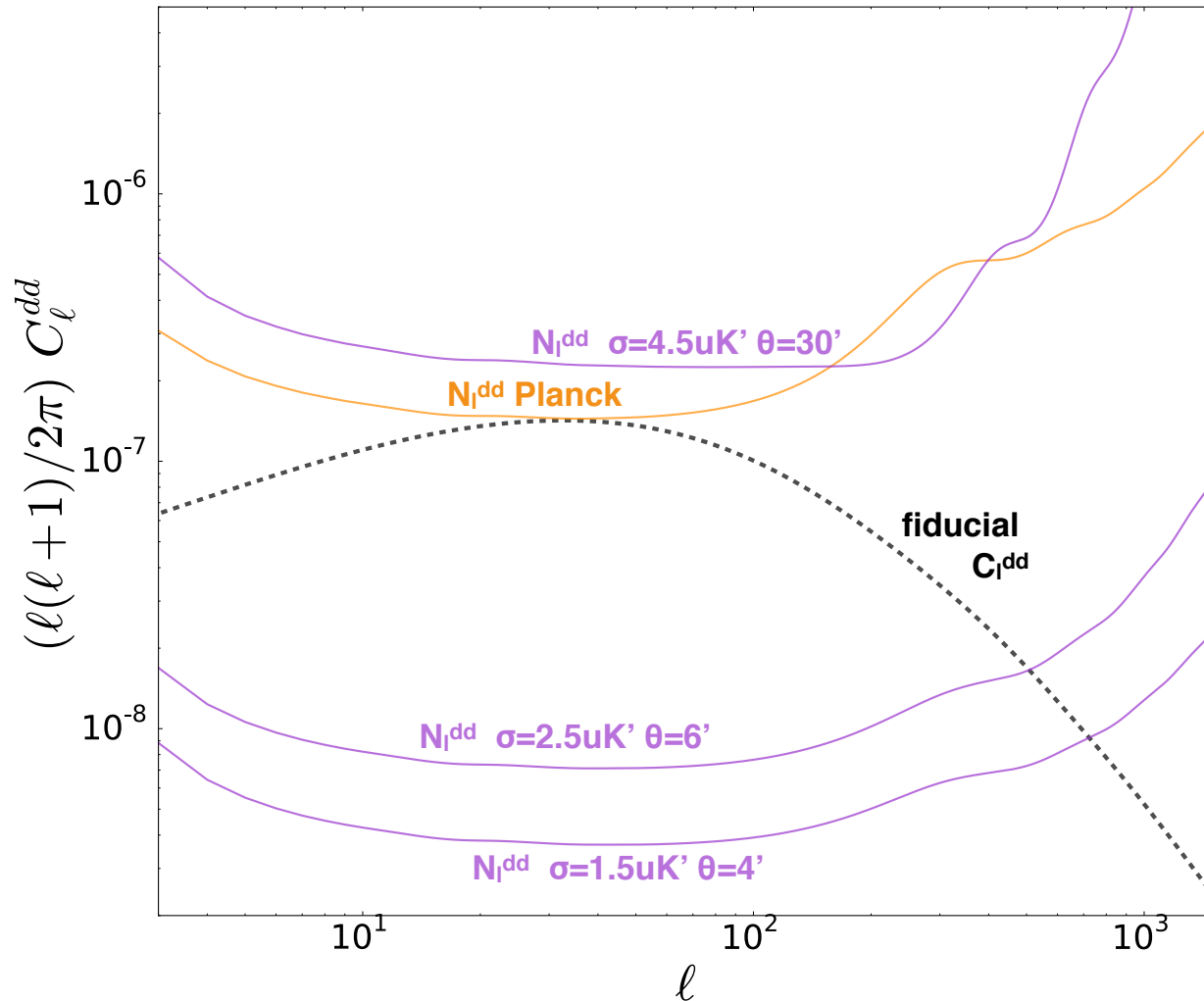
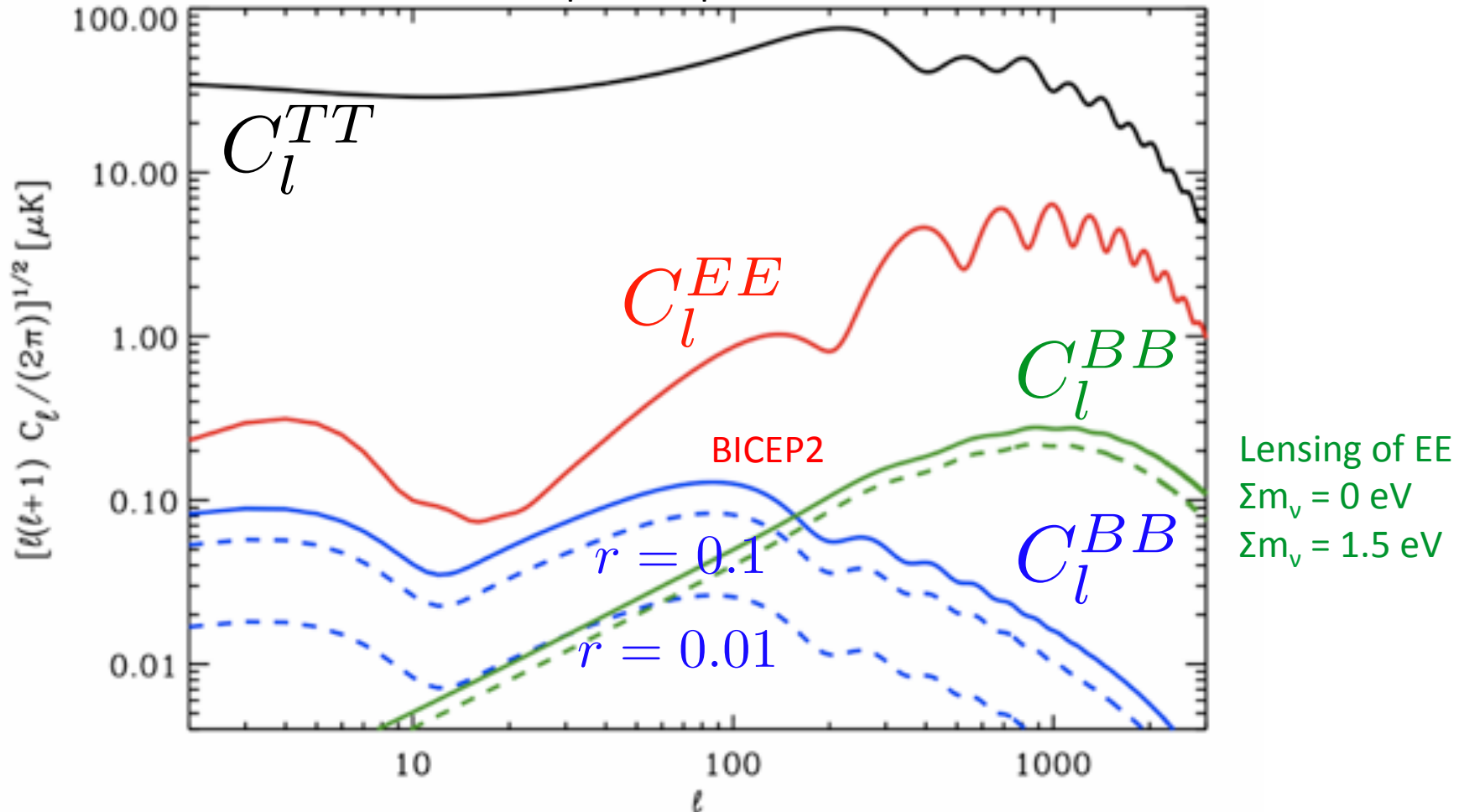

Figure by Josquin Errard

Temperature & Polarisation CMB C_l

plot adapted from J. Carlstrom's P5 talk



Constraining the neutrino sector

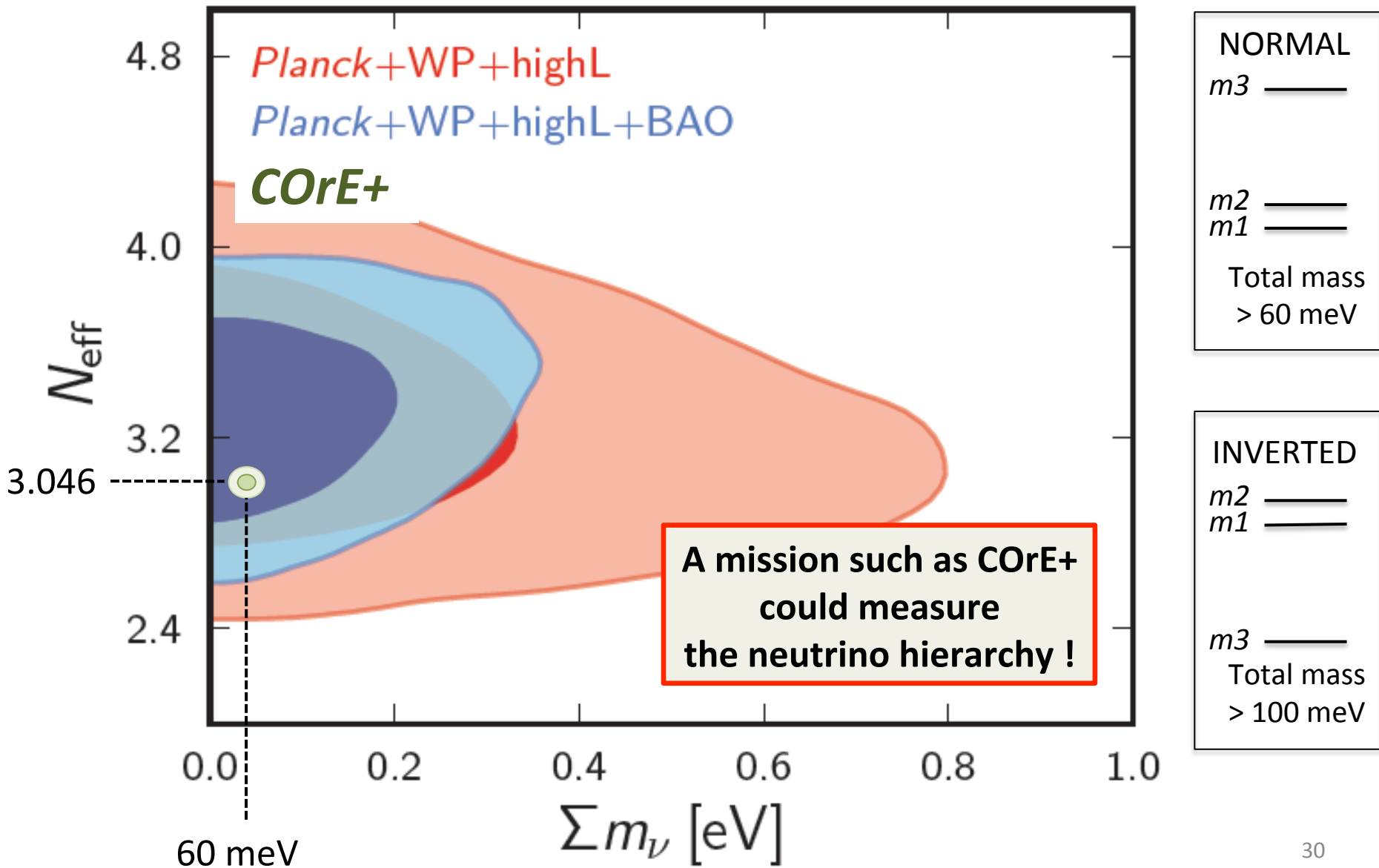

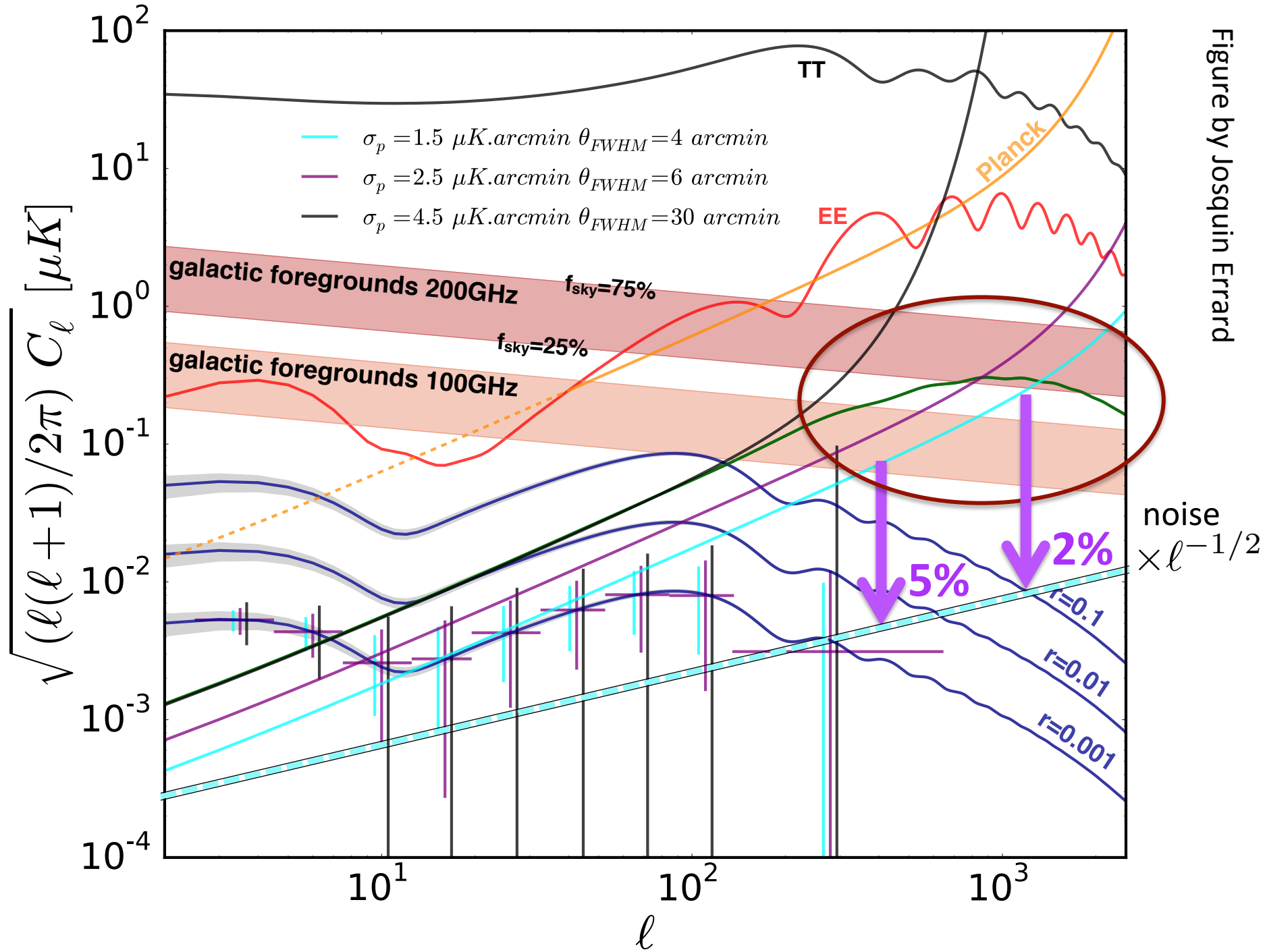

Figure by Josquin Errard

What space mission ?

COrE+

(quasi-) ultimate mission for CMB
polarisation anisotropies
(fit 15 cosmological parameters)

This is true irrespective of the value of r .

Outline

- Tensor modes with a future mission?
- Beyond primary CMB science
- ➔ • Why a space mission ?
 - COrE+
 - Conclusion

B-modes detected...

BICEP2: Ade et al., PRL 112, 24,
id.241101 arXiv:1403.3985

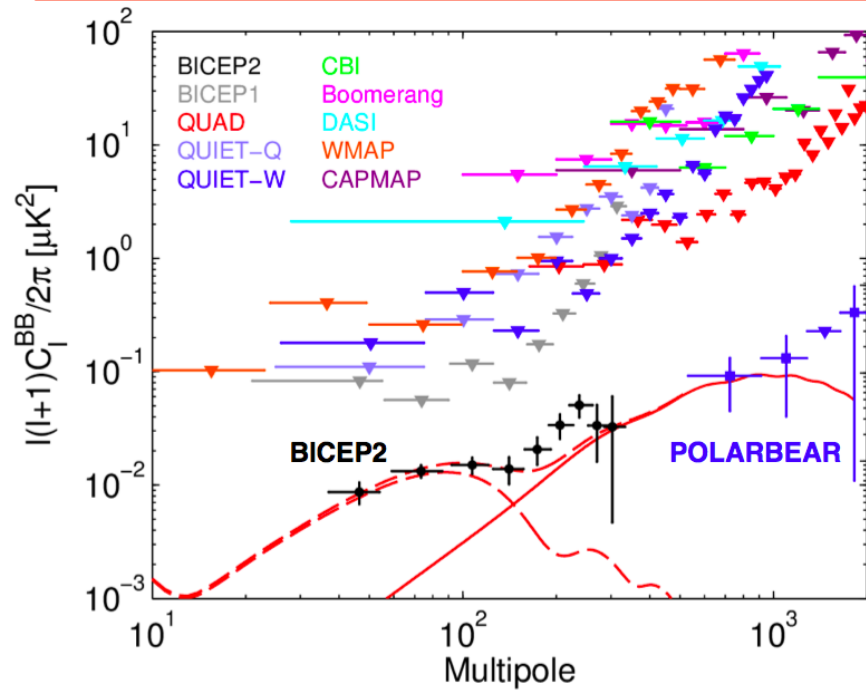

POLARBEAR
Ade et al., ApJ 794,
issue 2, Article id. 171

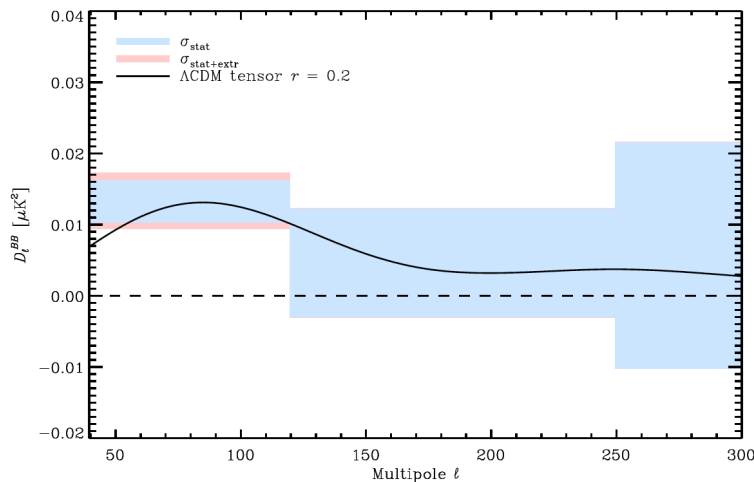
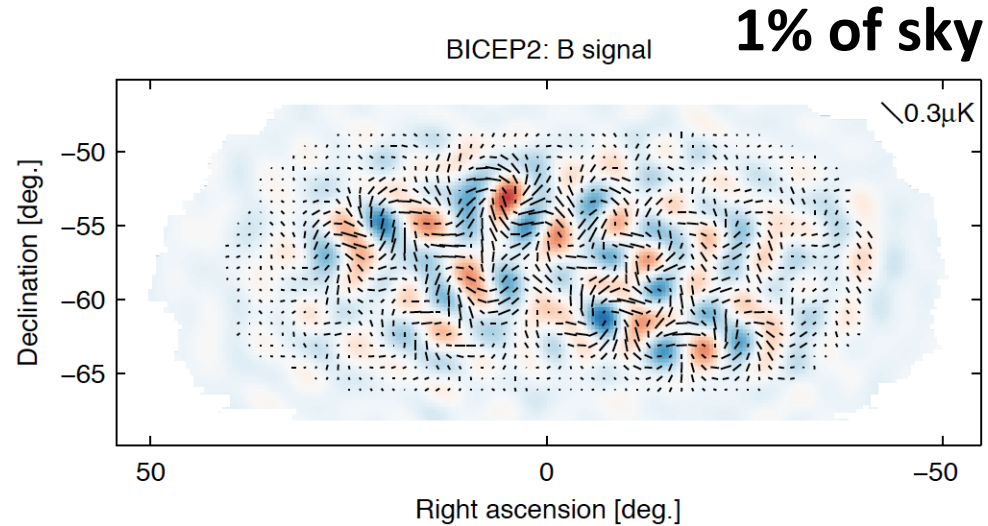

Planck collaboration, Planck intermediate results XXX.

Foreground emission

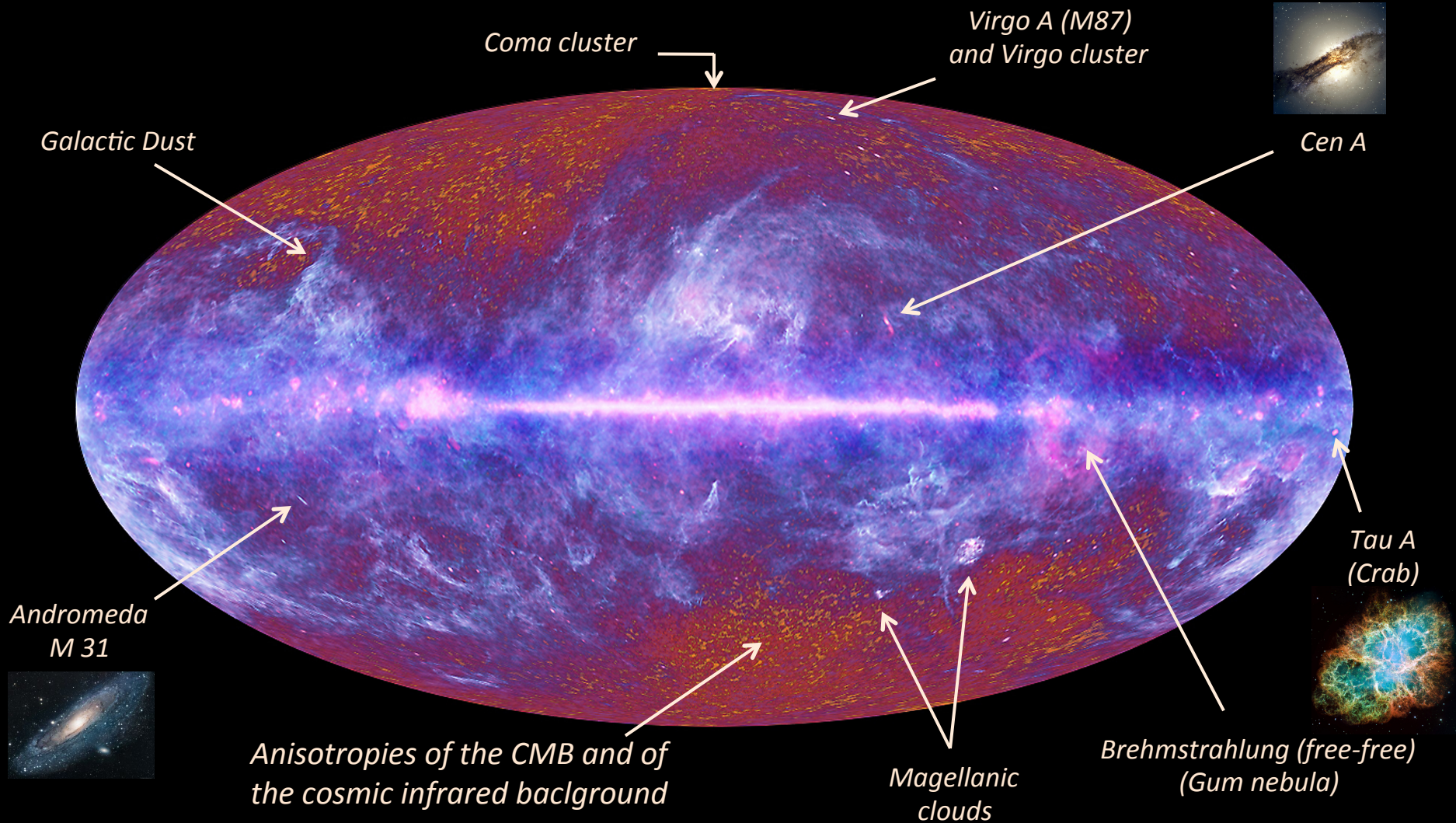

Atmosphere !

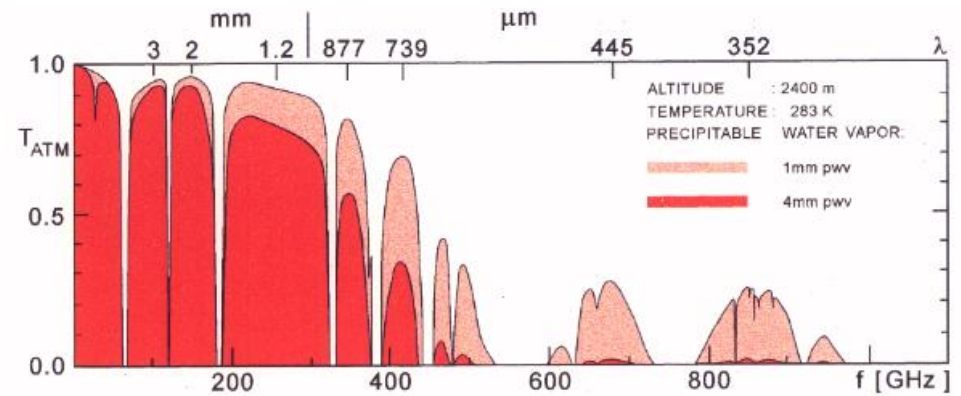

transmission and emission

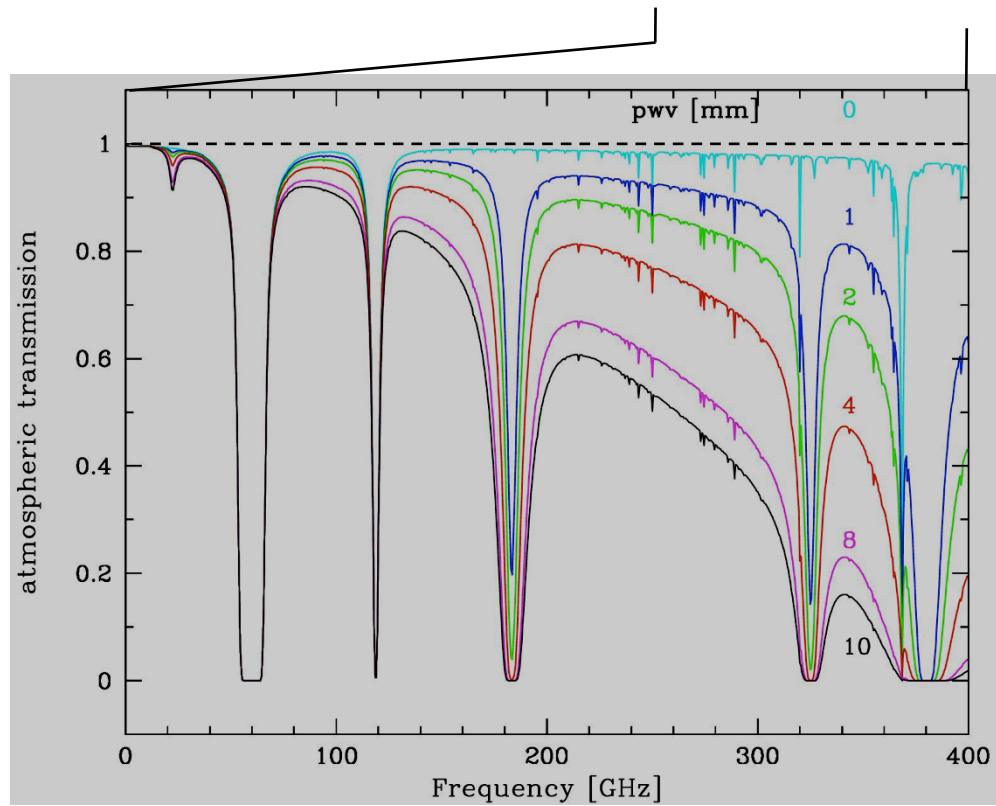

Comparison of the sky background

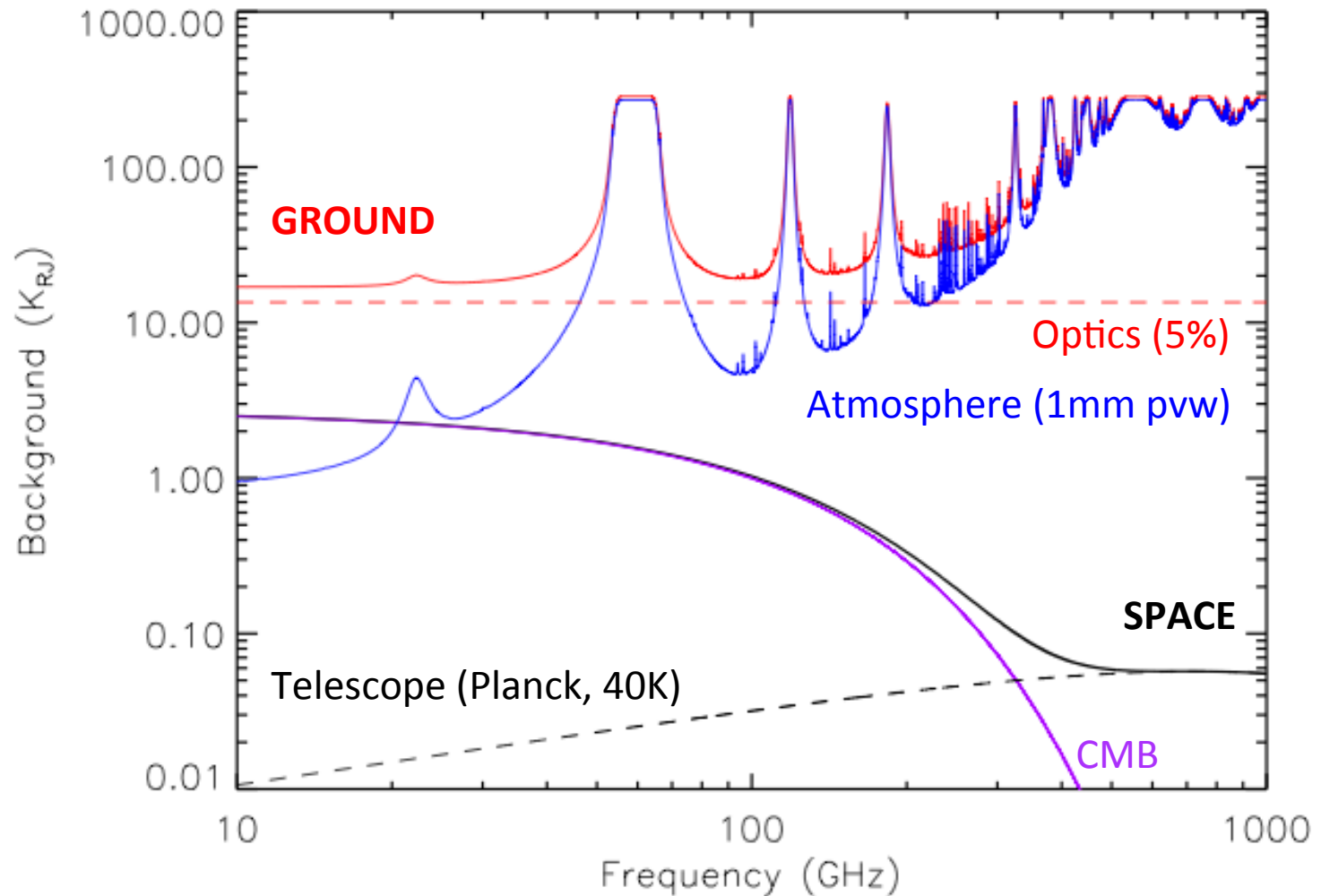

Sensitivity comparison

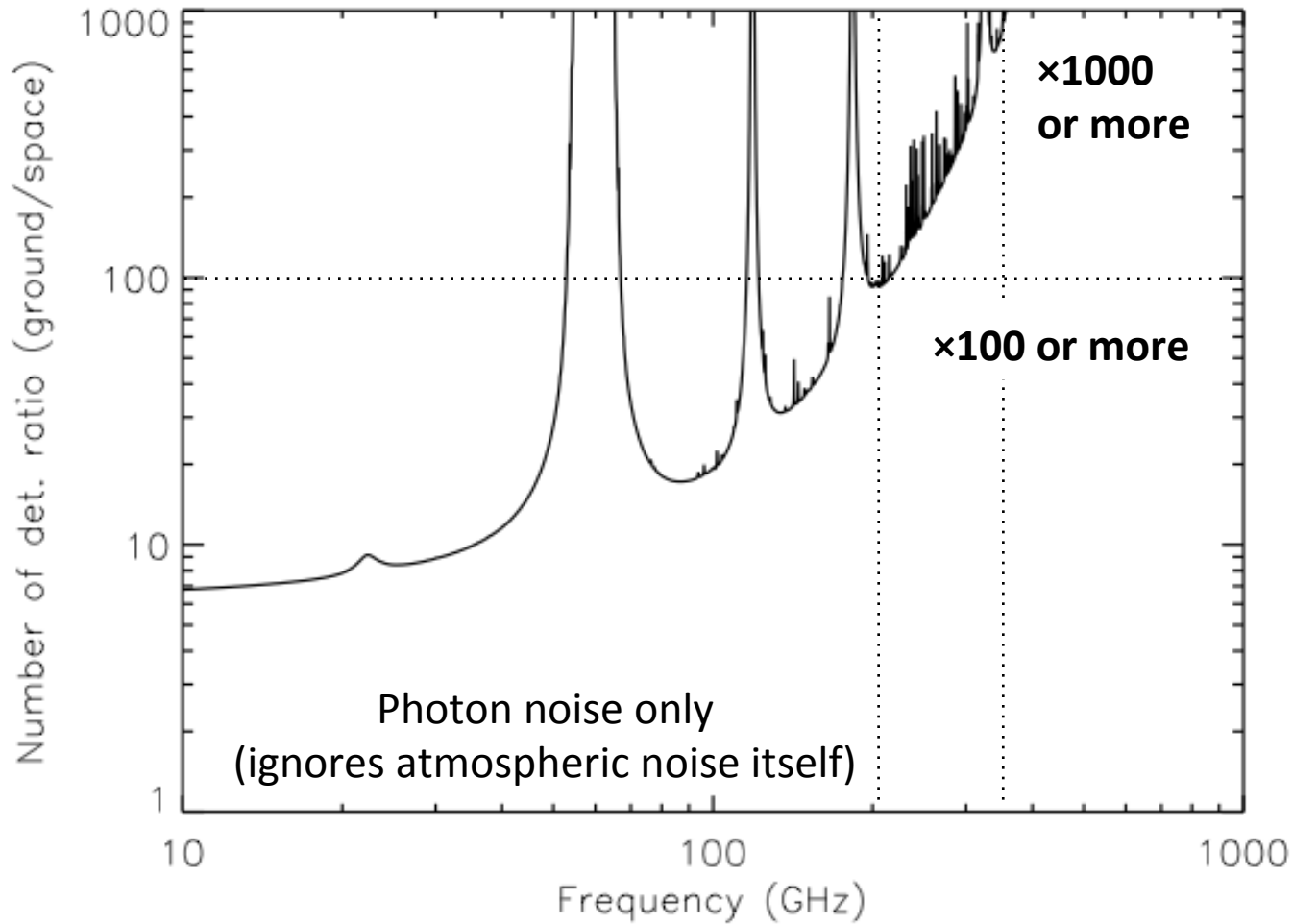

Atmospheric emission

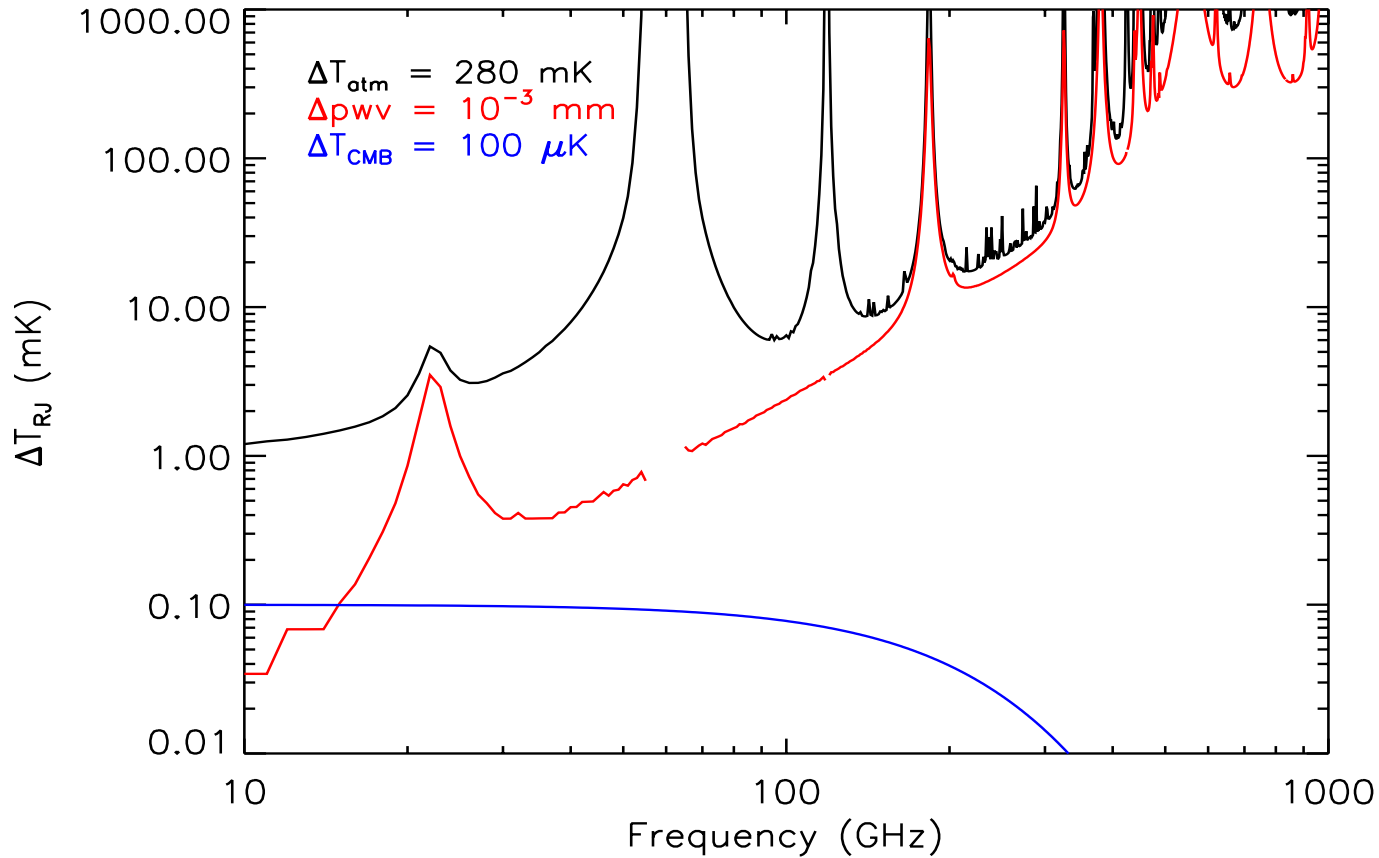

Atmospheric emission

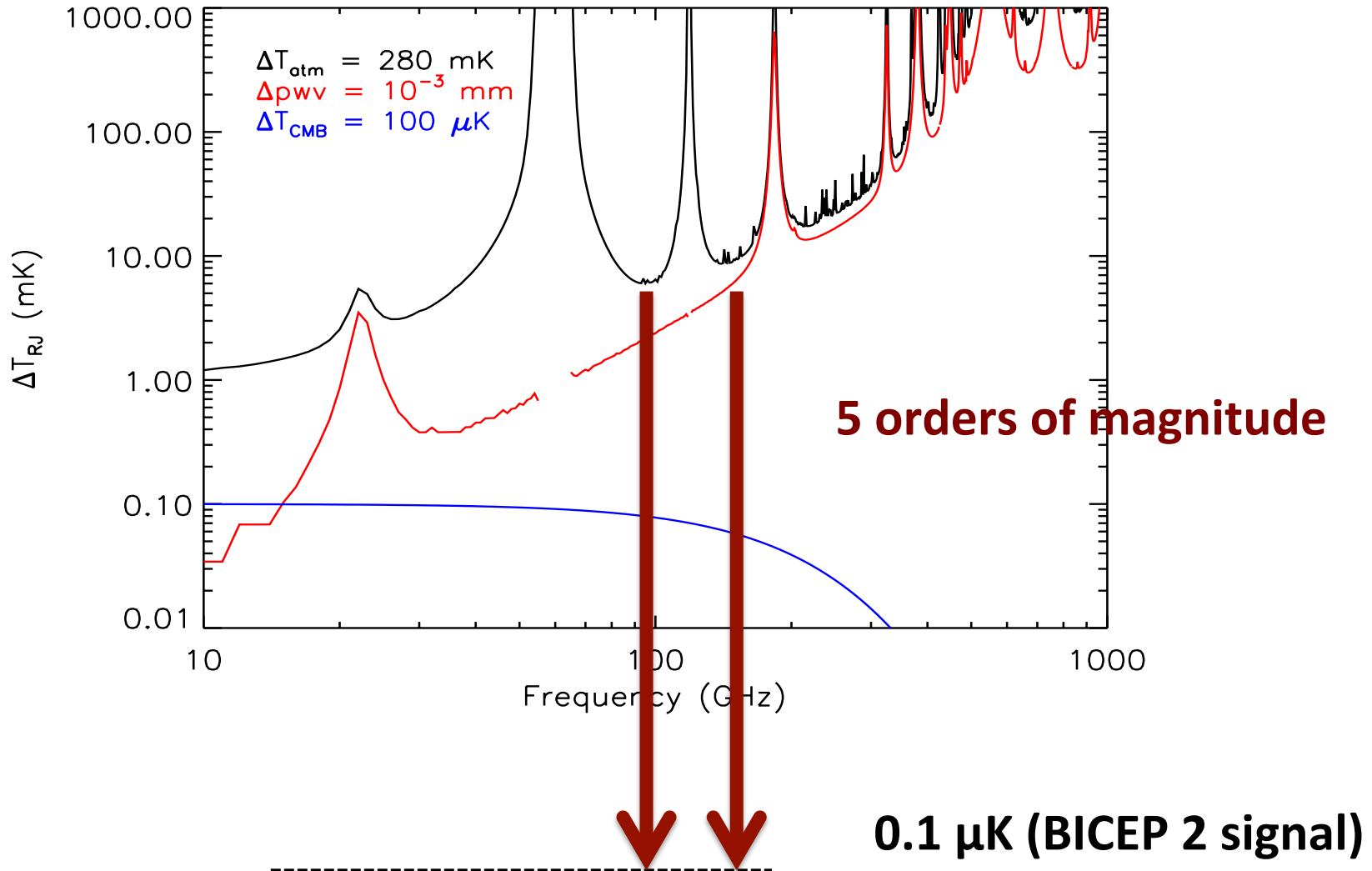

Atmospheric emission

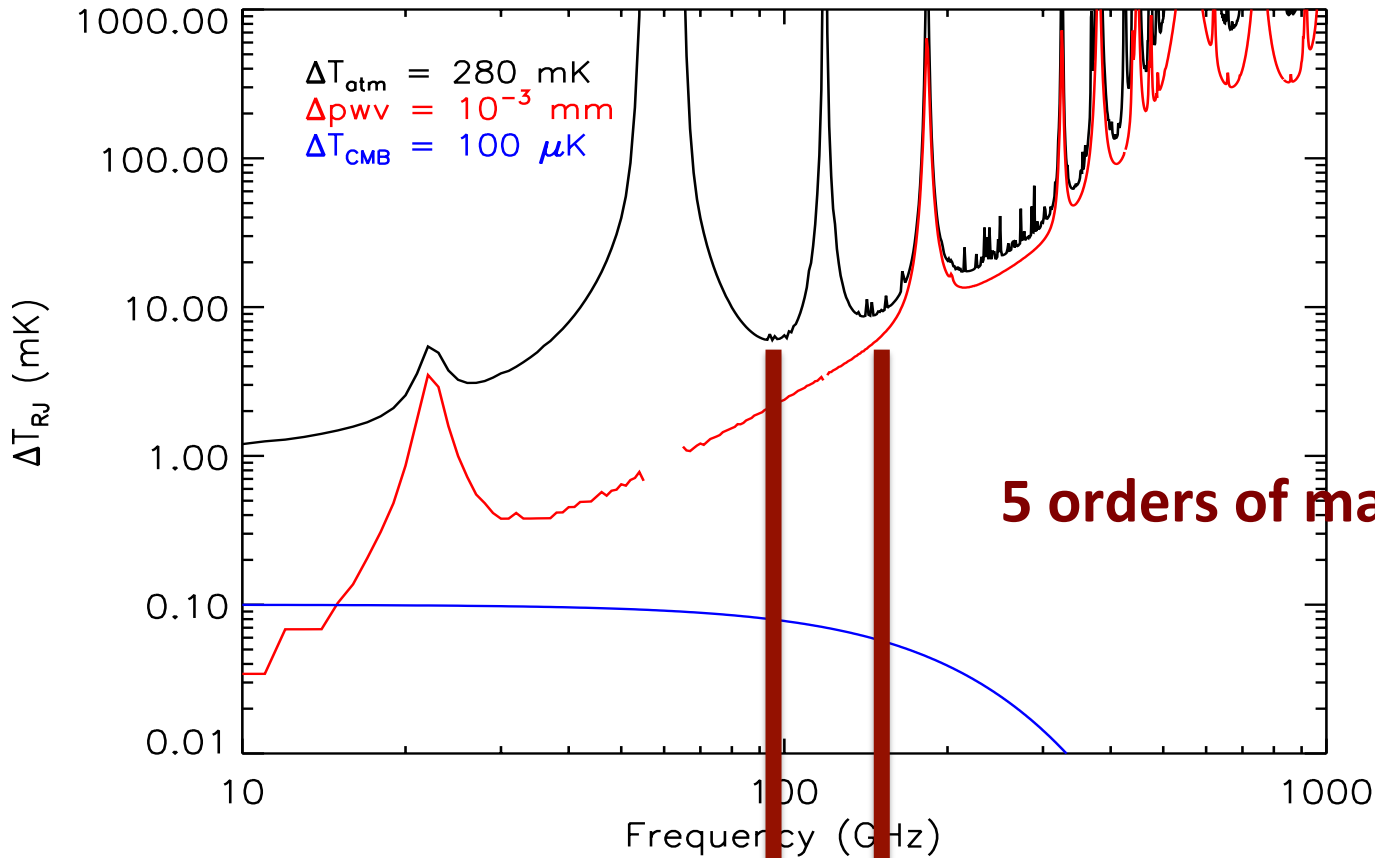

5 orders of magnitude

0.1 μK (BICEP 2 signal)

One more (only) but *on larger scales*

Outline

- Tensor modes with a future mission?
- Beyond primary CMB science
- Why a space mission ?
- • COrE+
- Conclusion

COrE+ and ESA M4 call

- ESA M4 call for a medium mission.
 - Budget 450 M€ (ESA) + National contributions for the science payload (including international contributions, e.g. from NASA);
 - Call issued August 19th, 2014; Proposal submitted January 15th, 2015;
 - If pre-selected, definition phase from 2015 to 2017.
 - Selection in 2017-2018; Launch in 2025.

COrE+

Cosmic Origins Explorer+

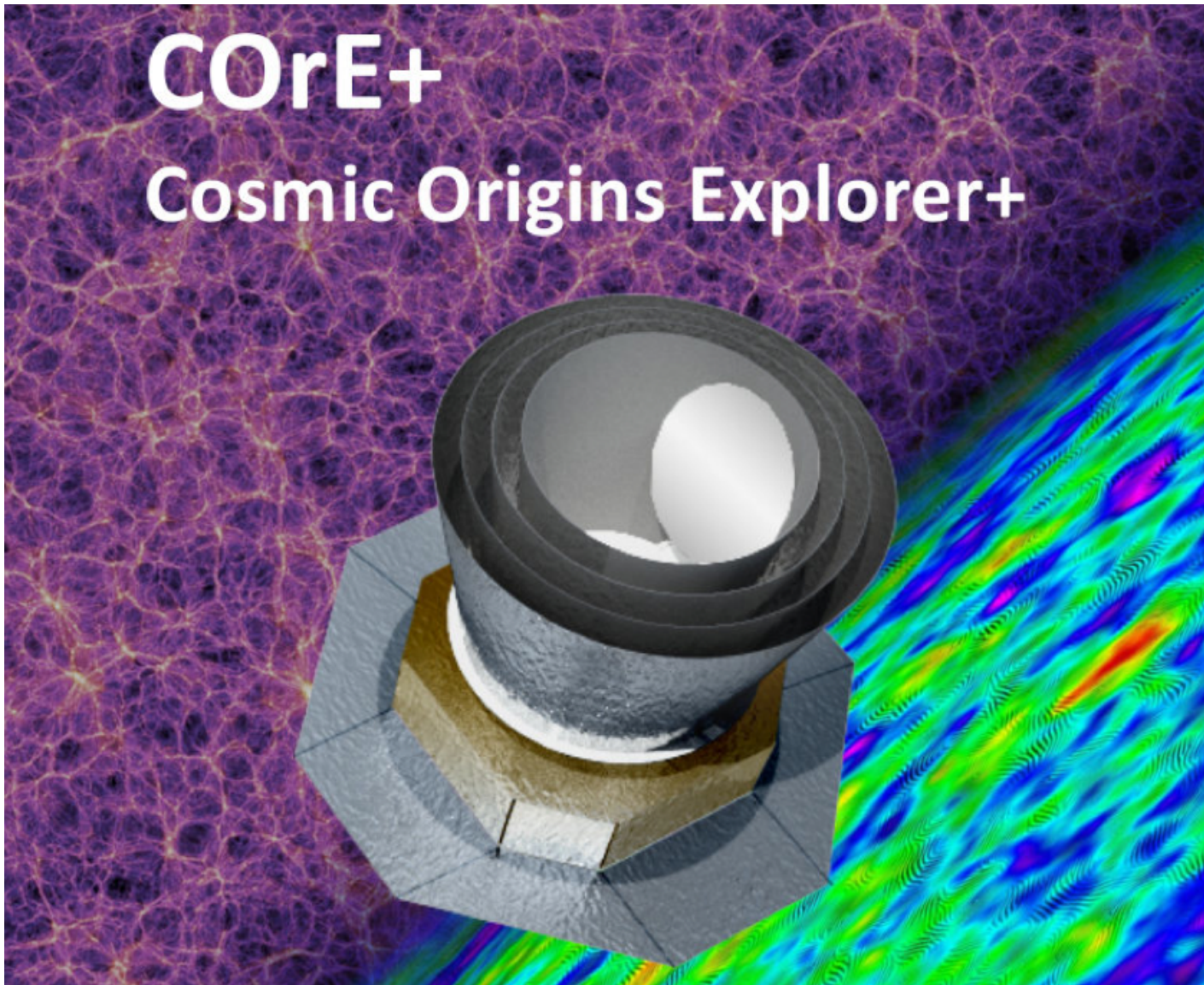

Proposal leader: *Paolo de Bernardis;*
Co-leaders: *François Bouchet & Jacques Delabrouille*
US Coordinator: *Shaul Hanany*

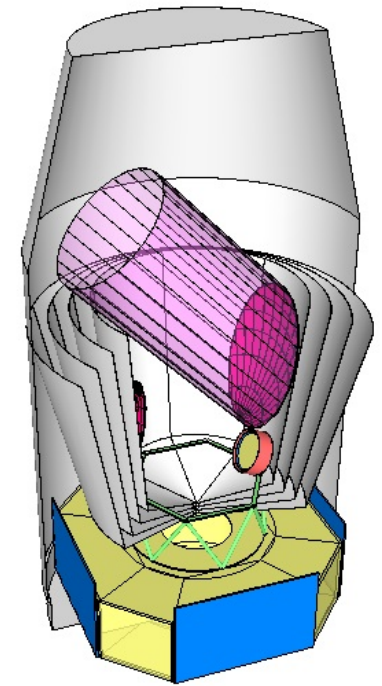
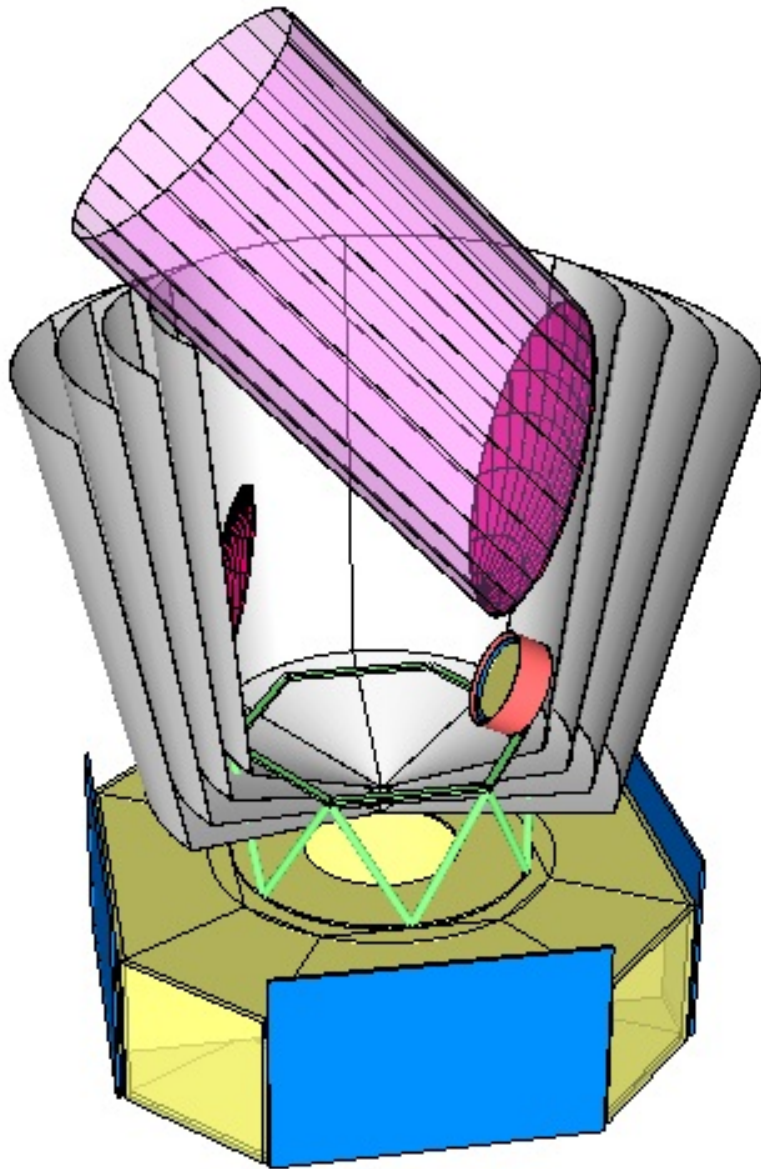

Launch configuration
CORe+ in Soyuz fairing

**TO BE
OPTIMIZED**

-  60 GHz
-  70 GHz
-  80 GHz
-  90 GHz
-  100 or 115 GHz

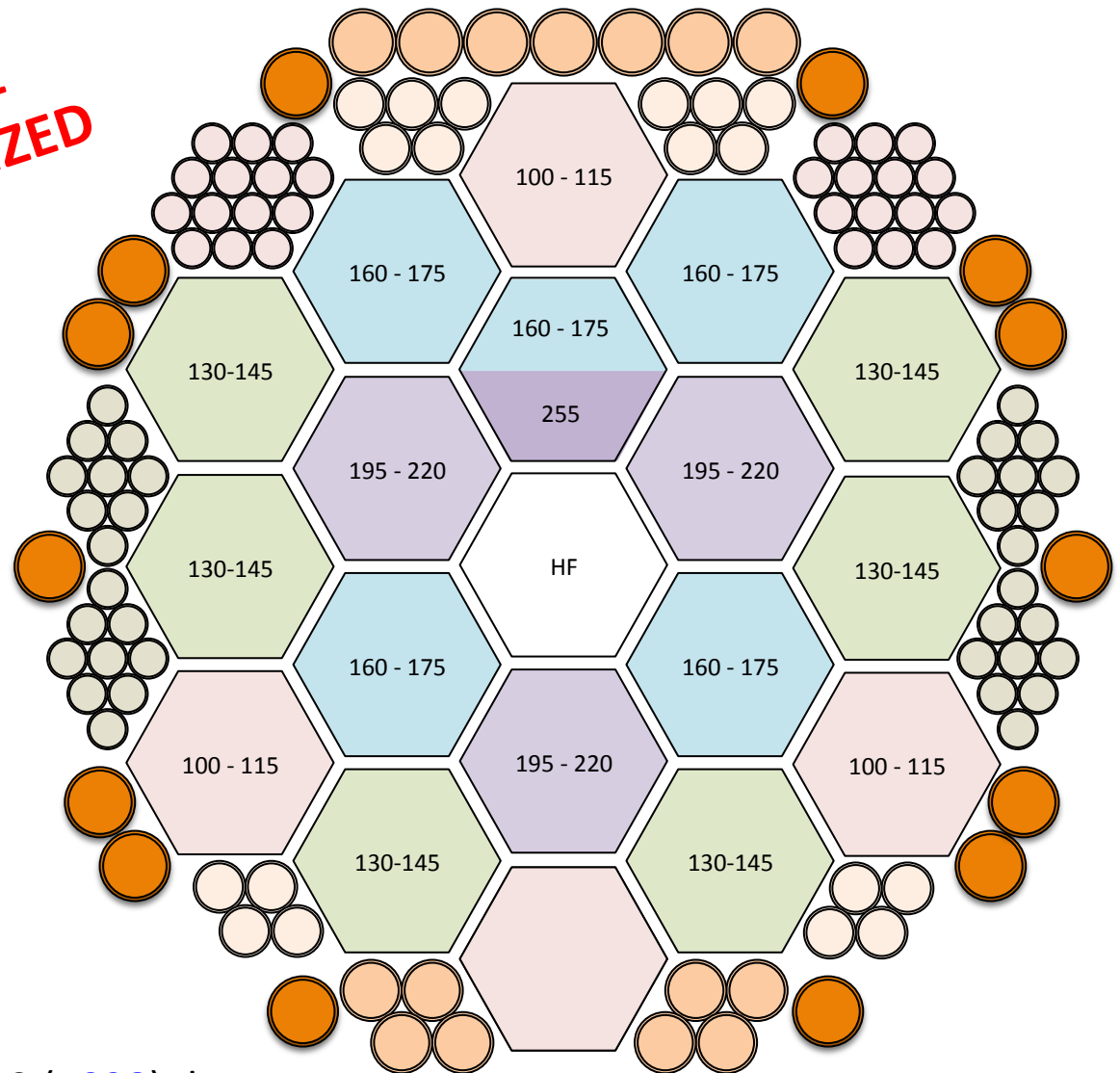

ν	$N_{\text{det single}}$	$N_{\text{det dual}}$
60	28	28
70	30	30
80	36	64
90	72	102
100	84	120
115	124	196
130	180	244
145	264	444
160	254	434
175	290	554
195	346	600
220	200	490
255	140	486
295	60	260
340	60	200
390	60	120
450	60	120
520	60	120
600	60	120
700	60	60
800	60	60

2410 (5028) detectors
 63% (58%) in CMB channels
 1.85 (1.2) $\mu\text{K}\cdot\text{arcmin}$ sensitivity

COrE+ proposed baseline

(50% opt. eff., $\Delta\nu/\nu=25\%$, 60K payload, single frequency pixels)

channel GHz	beam arcmin	N_{det}	ΔT $\mu\text{K}.\text{arcmin}$	ΔP $\mu\text{K}.\text{arcmin}$	ΔI kJy/sr.arcmin	$\Delta y \times 10^6$ $y_{\text{SZ}}.\text{arcmin}$	PS flux (5σ) mJy
60	14	28	11.3	16	1.14	-2.3	6
70	12	30	10.5	14.9	1.4	-2.2	6.3
80	10.5	38	9.1	12.9	1.53	-2.0	6
90	9.33	72	6.5	9.2	1.32	-1.5	4.6
100	8.4	84	6.0	8.5	1.43	-1.5	4.5
115	7.3	124	5.0	7.0	1.45	-1.3	4
130	6.46	180	4.2	5.9	1.43	-1.3	3.5
145	5.79	264	3.6	5.0	1.37	-1.3	3
160	5.25	254	3.8	5.4	1.6	-1.7	3.1
175	4.8	290	3.8	5.3	1.69	-2.2	3.0
195	4.31	346	3.8	5.3	1.79	-4.1	2.9
220	3.82	200	5.8	8.1	2.78	-	4.0
255	3.29	140	8.9	12.6	4.11	5.5	5.1
295	2.85	60	19.4	27.4	7.84	5.7	8.4
340	2.47	60	30.9	43.7	9.91	5.6	9.2
390	2.15	60	55.0	77.8	12.63	7.0	10.2
450	1.87	60	116.6	164.8	16.48	10.9	11.5
520	1.62	60	295.7	418.2	21.71	21.0	13.2
600	1.4	60	899.7	1272.4	28.61	50.3	15.0

Table 3: Proposed *COrE+* frequency channels. The sensitivity is calculated assuming $\Delta\nu/\nu = 25\%$ bandwidth, 50% optical efficiency, total noise of twice the expected photon noise from the sky and the optics of the instrument at 60K temperature. The aggregated CMB sensitivity is $2\mu\text{K}.\text{arcmin}$ in polarization. This is the *COrE+* baseline

COrE+ proposed extension

(50% opt. eff., $\Delta\nu/\nu=25\%$, 60K payload, dual-frequency pixels)

channel GHz	beam arcmin	N_{det}	ΔT $\mu\text{K}\cdot\text{arcmin}$	ΔP $\mu\text{K}\cdot\text{arcmin}$	ΔI (kJy/sr) $\cdot\text{arcmin}$	$\Delta y \times 10^6$ $y_{\text{SZ}}\cdot\text{arcmin}$	PS flux (5σ) mJy
60	14	28	9.8	13.8	0.99	-2.0	5.2
70	12	30	9.1	12.9	1.21	-1.9	5.5
80	10.5	64	6.1	8.6	1.02	-1.3	4.0
90	9.33	102	4.8	6.7	0.96	-1.1	3.4
100	8.4	120	4.3	6.1	1.04	-1.1	3.3
115	7.3	196	3.4	4.8	1.00	-0.9	2.7
130	6.46	264	3.0	4.2	1.02	-0.9	2.5
145	5.79	388	2.5	3.6	0.98	-0.9	2.1
160	5.25	534	2.3	3.2	0.96	-1.0	1.9
175	4.8	554	2.4	3.3	1.06	-1.4	1.9
195	4.31	600	2.5	3.5	1.18	-2.7	1.9
220	3.82	490	3.2	4.5	1.54	-	2.2
255	3.29	486	4.1	5.8	1.91	2.6	2.4
295	2.85	260	8.1	11.4	3.26	2.4	3.5
340	2.47	200	14.6	20.7	4.70	2.7	4.4
390	2.15	120	33.7	47.6	7.74	4.3	6.2
450	1.87	120	71.4	100.9	10.09	6.7	7.1
520	1.62	120	181.1	256.1	13.3	12.9	8.1
600	1.4	120	551	779.2	17.52	30.8	9.2
700	1.2	60	3293.5	4657.8	33.35	145.1	15.0
800	1.05	60	14499.8	20505.9	43.04	527.4	16.9

Table 4: *COrE+* frequency channels for a possible extension of the proposed baseline, based on dual-frequency, dual polarization detectors. Each pixel feeds detectors at frequency ν_n and ν_{n+2} , i.e. (60 and 80 GHz), (70 and 90 GHz), (80 and 100 GHz), etc.

Focal plane wafers

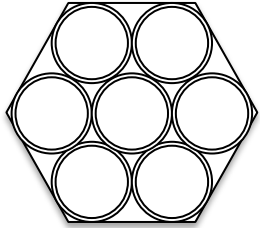

7 horns
14 detectors
 $h = 8.2 F\lambda$

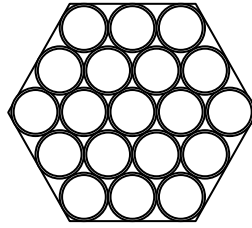

19 horns
38 detectors
 $h = 13.4 F\lambda$
100 – 115 GHz

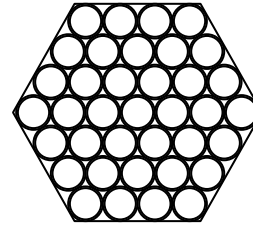

37 horns
74 detectors
 $h = 18.6 F\lambda$
130 – 145 GHz

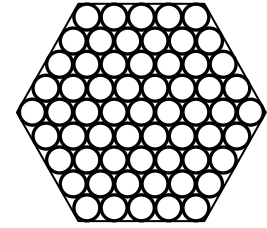

61 horns
122 detectors
 $h = 23.8 F\lambda$
160 – 175 GHz

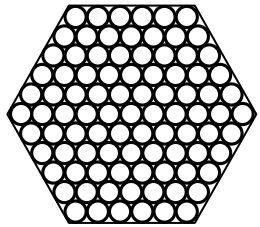

91 horns
182 detectors
 $h = 29.0 F\lambda$
195 – 220 GHz

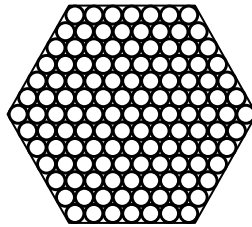

127 horns
254 detectors
 $h = 34.2 F\lambda$
255 GHz

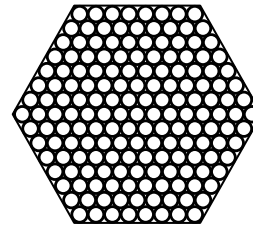

169 horns
338 detectors
 $h = 39.4 F\lambda$
295 GHz

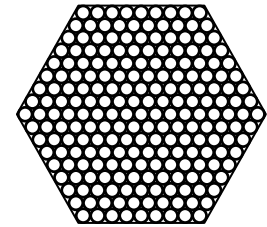

217 horns
434 detectors
 $h = 44.6 F\lambda$
High frequencies

h = Height of the hexagons for horn diameter of $3 F\lambda$ (-20 dB edge taper)

-  60 GHz
-  70 GHz
-  80 GHz
-  90 GHz
-  100 or 115 GHz

**TO BE
OPTIMIZED**

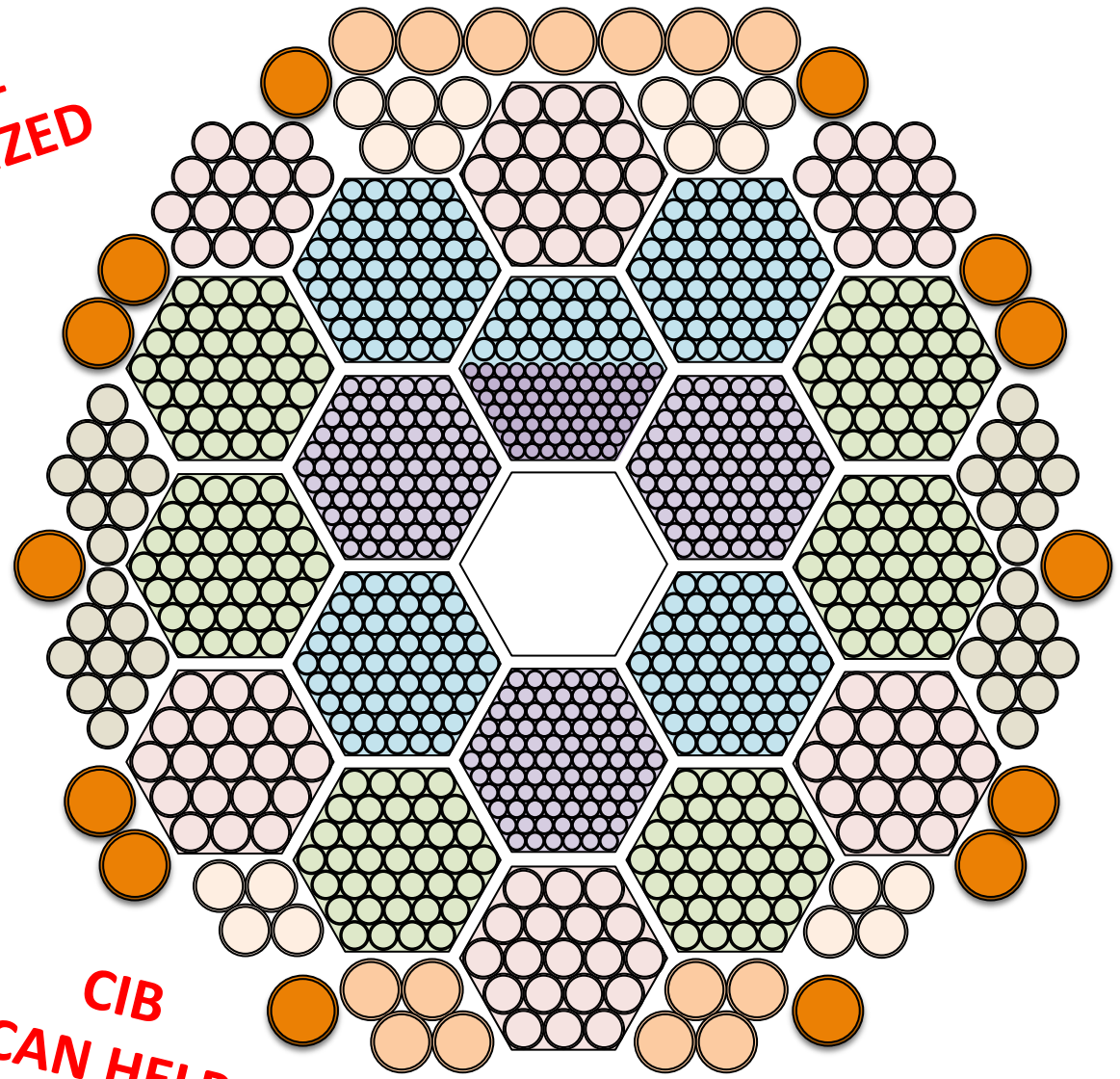

v	$N_{\text{det single}}$	$N_{\text{det dual}}$
60	28	28
70	30	30
80	36	64
90	72	102
100	84	120
115	124	196
130	180	244
145	264	444
160	254	434
175	290	554
195	346	600
220	200	490
255	140	486
295	60	260
340	60	200
390	60	120
450	60	120
520	60	120
600	60	120
700	60	60
800	60	60

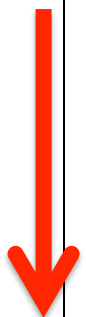

**CIB
CAN HELP
DELENSING**

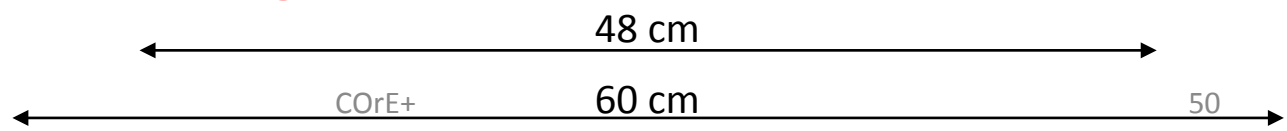

Extragalactic
Astrophysics

Interstellar medium
(magnetic field)

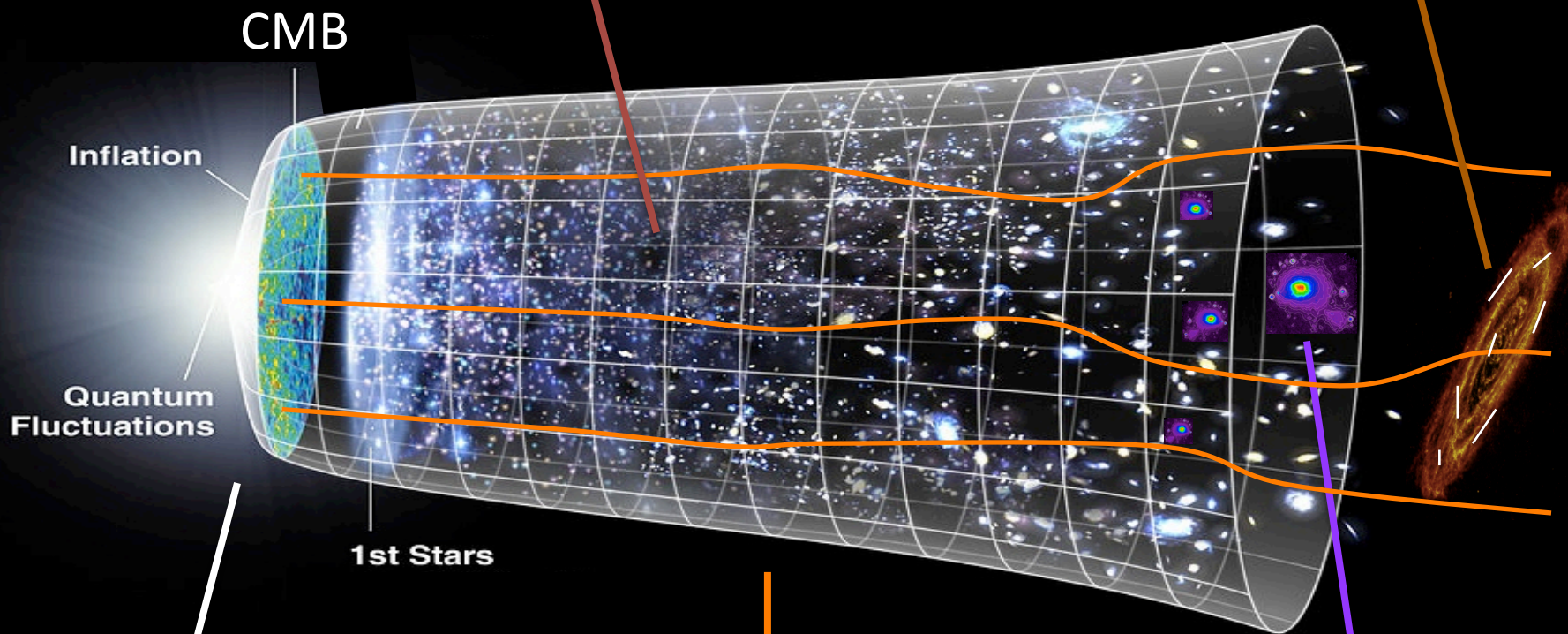

Quantum
Fluctuations

CMB

Inflation

1st Stars

Univers primordial
Physique à $\approx 10^{16}$ GeV

$$E_{\text{CORe}^+} > 10^{12} \times E_{\text{LHC}}$$

16 jan. 2015

$z \approx 1-3$

Gravitational lensing
Dark matter distribution

$z \approx 0-2$

Sunyaev-Zeldovich effect:
Distribution of the hot gas
and velocity field

Observation of >100,000 Galaxy clusters

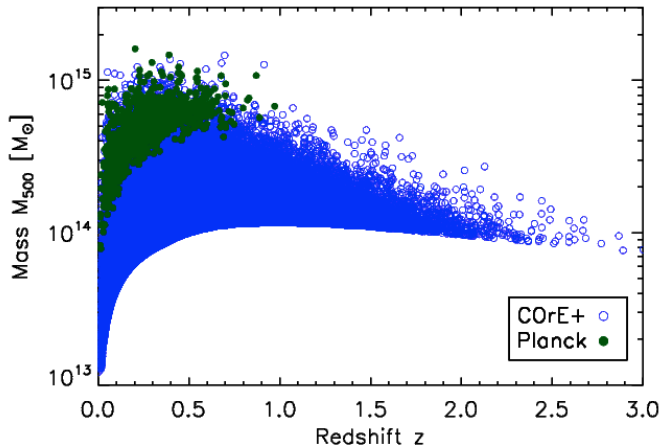
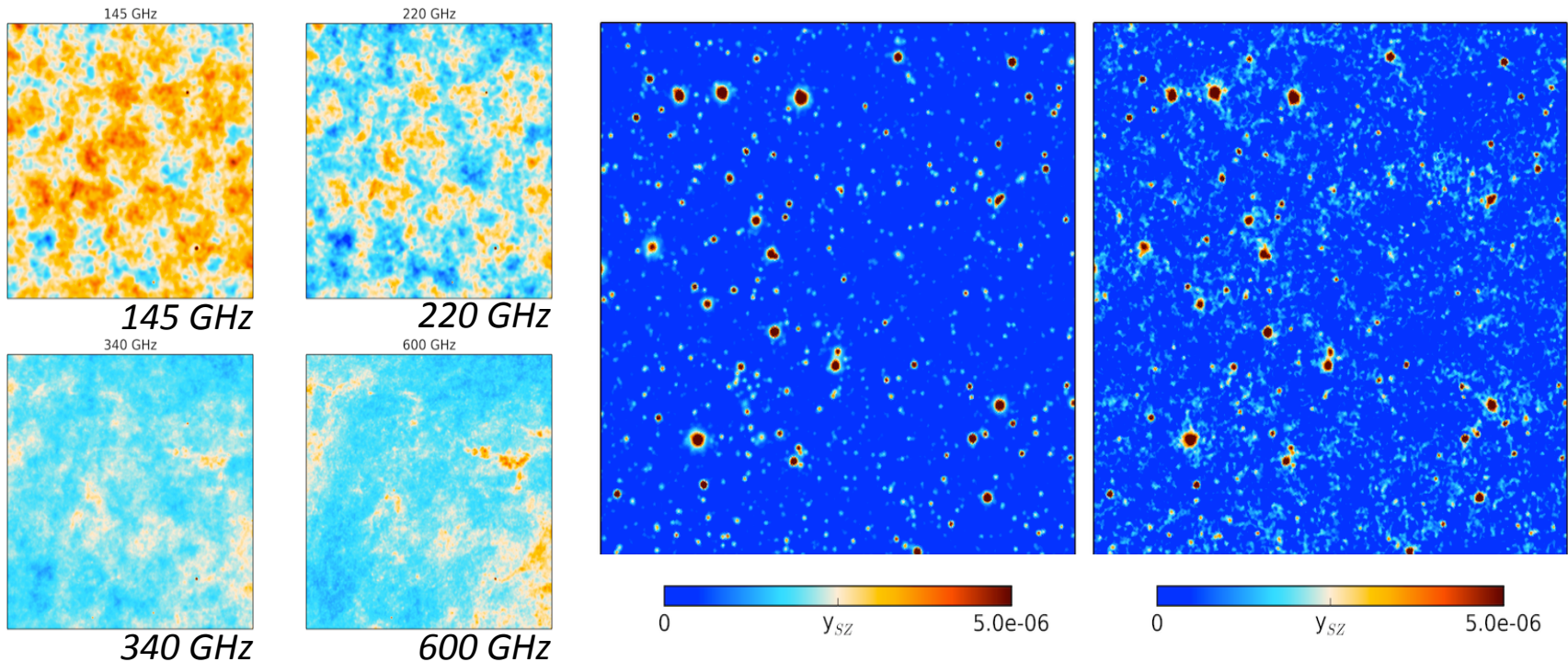

SZ map reconstruction
Needlet ILC (Mathieu Remazeilles)
on PSM simulations (Ata Karakci)

Limit mass as a function of redshift (Jean-Baptiste Melin)

Conclusion

Let's do it !

support this mission:

<https://hangar.iasfbo.inaf.it/core/>