



Minnesota
Department of
Transportation

Scour Monitoring Technology Implementation

**RESEARCH
SERVICES
&
LIBRARY**

**Office of
Transportation
System
Management**

Jeff Marr, Principal Investigator
St. Anthony Falls Laboratory
University of Minnesota

September 2014

Research Project
Final Report 2014-37



To request this document in an alternative format call [651-366-4718](tel:651-366-4718) or [1-800-657-3774](tel:1-800-657-3774) (Greater Minnesota) or email your request to ADArequest.dot@state.mn.us. Please request at least one week in advance.

Technical Report Documentation Page

1. Report No. MN/RC 2014-37	2.	3. Recipients Accession No.	
4. Title and Subtitle Scour Monitoring Technology Implementation	5. Report Date September 2014		6.
	7. Author(s) Matthew Lueker and Jeff Marr		
9. Performing Organization Name and Address St. Anthony Falls Laboratory University of Minnesota 2 Third Avenue SE Minneapolis, MN 55414	10. Project/Task/Work Unit No. CTS Project #2011069		8. Performing Organization Report No.
	11. Contract (C) or Grant (G) No. (c) 89261 (wo) 261		
12. Sponsoring Organization Name and Address Minnesota Department of Transportation Research Services & Library 395 John Ireland Boulevard, MS 330 St. Paul, Minnesota 55155-1899	13. Type of Report and Period Covered Final Report		
	14. Sponsoring Agency Code		
15. Supplementary Notes http://www.lrrb.org/pdf/201437.pdf			
16. Abstract (Limit: 250 words) <p>Bridge scour is the removal of sediment around bridge foundations and can result in the failure of the bridge. Scour monitoring is performed to identify unacceptable scour on bridges considered to be scour critical and determine when scour reaches elevations that could cause potential bridge failure. Two types of monitoring are available: portable monitoring and fixed monitoring. Prior to this project, MnDOT was only using portable monitoring devices, which requires the deployment of personnel to make physical measurements of scour depths. For some scour critical bridges, especially during high-water events, fixed instrumentation capable of continuous scour monitoring was preferred, but MnDOT lacked the experience or expertise to install this type of equipment.</p> <p>This project installed fixed monitoring equipment at two bridge sites and monitored them for three years to determine the effectiveness and reliability of fixed scour monitoring deployments. Several device options were installed to allow MnDOT to analyze the installation and performance of different types of sensors.</p> <p>Both systems operated for the three years with some outages due to various causes but overall performance was acceptable. The outages were mostly related to power issues and communication issues. Valuable lessons were learned through the deployment, which may be applied to future installations. The deployment executed in this project has provided the confidence to deploy other fixed scour monitoring equipment at key bridges around the state of Minnesota. In addition, the data collected during deployment of the scour monitoring equipment has been stored and provides insight into scour processes. This data can be used by other research groups for design or research purposes.</p>			
17. Document Analysis/Descriptors Scour, monitoring, bridge foundations, bridges, structural health monitoring		18. Availability Statement No restrictions. Document available from: National Technical Information Services, Alexandria, Virginia 22312	
19. Security Class (this report) Unclassified	20. Security Class (this page) Unclassified	21. No. of Pages 144	22. Price

Scour Monitoring Technology Implementation

Final Report

Prepared by:

Matthew Lueker

Jeff Marr

St. Anthony Falls Laboratory

University of Minnesota

September 2014

Published by:

Minnesota Department of Transportation

Research Services & Library

395 John Ireland Boulevard, MS 330

St. Paul, Minnesota 55155-1899

This report represents the results of research conducted by the authors and does not necessarily represent the views or policies of the Minnesota Department of Transportation or the University of Minnesota. This report does not contain a standard or specified technique.

The authors, the Minnesota Department of Transportation and/or the University of Minnesota do not endorse products or manufacturers. Trade or manufacturers' names appear herein solely because they are considered essential to this report.

Acknowledgments

We would like to acknowledge the Hydraulics Division at the Minnesota Department of Transportation (MnDOT) bridge department for providing coordination with district-level MnDOT staff, reviewing tasks, and providing support and guidance that led to a successful long-term scour monitoring deployment at two Minnesota bridges. We would especially like to acknowledge Andrea Hendrickson and Solomon Woldeamlak.

We would also like to thank all of the district-level MnDOT staff who helped support installation. This includes Larry Cooper, Tom Miles, Craig Lenz, and Larry Waletzki from District 6 and Scott Morgan, Jay Spencer, Jeff Robb, Charles Kremer and Jed Falgren from District 7. We would also like to especially highlight the contribution of Brett Reinardy and Robert Emineth, MnDOT highway signal technicians, who were on site for installation and provided continued support for the deployments. This project would have been much more difficult without their help, and their knowledge of field-based electronics was critical to prompt troubleshooting and successful, efficient deployments.

We also thank our MnDOT administrative liaison, Shirlee Sherkow, and the University of Minnesota Center for Transportation Studies.

Finally, we would like to thank ETI Instrument Systems for providing continued support for the equipment used in this deployment, aid in troubleshooting, and assisting in the monitoring of the systems.

Table of Contents

1	Introduction and Project Background.....	1
2	Verification of Bridges, Products, and Installation Methods	3
2.1	Bridge/Stream Geometry Verification	3
2.2	Equipment Verification.....	5
2.3	Installation Verification	6
2.4	MnDOT Work Plan Modifications	6
2.5	Installation Work Plans.....	7
2.6	System Construction and Programming	9
2.7	System Operation and Maintenance	10
2.8	Total Costs	11
3	Equipment Installation at Bridge Sites.....	12
3.1	Pre-Installation Tasks.....	12
3.2	Installation Equipment	12
3.3	Installation Personnel.....	13
3.4	Methods.....	15
3.5	Scour Equipment Locations	25
3.6	Conduit and Mounting Hardware	28
3.7	Schedule.....	29
3.8	Data Storage.....	31
3.9	Post Installation Modifications	32
4	Technical Documentation Report.....	35
4.1	Site Selection	35
4.2	Sensor Selection.....	36
4.3	Datalogging.....	38
4.4	Data Collection, Alerts, and Visualization	43
5	Testing Event.....	45
5.1	Float-Out Devices	45
5.2	Successful Alerts from Non-Testing Events.....	50
6	Yearly Maintenance and Administration	52
6.1	Bridge 5900.....	52
6.2	Bridge 07011.....	70

6.3 Alerts/Warnings	82
7 References	85

APPENDIX A: AS-BUILT DRAWINGS

APPENDIX B: SYSTEM MANUALS

List of Tables

Table 1: Bridge 07011 Original Plan.....	6
Table 2: Bridge 23015 Original Plan.....	6
Table 3: Personnel Type, Number, and Total Hours for Two Day Installation	13
Table 4: Bridge 5900, Pier 19 Scour Equipment.....	26
Table 5: Bridge 5900, Pier 20 Scour Equipment.....	26
Table 6: Bridge 07011, Pier 4 Scour Equipment.....	27
Table 7: Bridge 07011, Pier 5 Scour Equipment.....	27
Table 8: Conduit and Mounting Hardware.....	28
Table 9: Bridge 5900 Master Station Equipment Amperage	69
Table 10: Bridge 5900 Remote Station Equipment Amperage	69
Table 11: Bridge 07011 Master Station Equipment Amperage	80
Table 12: Bridge 07011 Remote Station Equipment Amperage	81

List of Figures

Figure 1: Bridge 07011 - Upstream profiles of piers 3 through 6	3
Figure 2: Bridge 5900 - Piers 18, 19, and 20 from Right to Left	5
Figure 3: Historical Stage Elevation Two Miles Upstream of Bridge 07011 – Stage 0 is 747.92 ft	8
Figure 4: Historical Stage Elevation of Pool at Bridge 5900	9
Figure 5: Bridge 07011 Sonar Mount.....	16
Figure 6: Bridge 5900 - Upper Sonar Mount	17
Figure 7: Bridge 5900 - Craning Lower Mount	18
Figure 8: Bridge 5900 - Attaching Lower Mount.....	18
Figure 9: Bridge 5900 - Lower Mount with Eye-Hook (at top).....	19
Figure 10: Bridge 5900 - Installed Sonar Mount.....	19
Figure 11: Bridge 5900 - Pier 20 Tilt Sensor	20
Figure 12: Bridge 07011 - Float-out Receiver.....	22
Figure 13: Bridge 07011 - Installation of Tethered Buried Switches.....	23
Figure 14: Bridge 07011 - Pier 4 Solar Panel from Deck	24
Figure 15: Bridge 07011 - Pier 5 Solar Panel.....	24
Figure 16: Bridge 5900 - Solar Panel Locations	25
Figure 17: Bridge 5900 - Solar Panel Bracket.....	25
Figure 18: Bridge 5900 - Pier 20 Tilt Signals Before and After Programming Fix	33
Figure 19: Bridge 5900 - Pier 20 Sonar Signal Before and After Programming Fix	33
Figure 20: Bridge 07011 - Pier 4 Solar Panel.....	40
Figure 21: Bridge 07011 – Pier 5 Datalogger and Solar Panel	41
Figure 22: Bridge 5900 - Pier 19 Datalogger and Solar Panel	42
Figure 23: Bridge 5900 - Pier 20 Datalogger and Solar Panel	43
Figure 24: Pier 5 at Installation (10/25/2011) and Testing Event (9/12/2013)	46
Figure 25: Access to Bridge 07011 Master Station during 4/2/2014 Maintenance and Testing Event.....	48
Figure 26: Pier 5 during 5/13/2014 Testing Event	49
Figure 27: Bridge 5900 Stage and Discharge - Administration 2011-2012	53
Figure 28: Bridge 5900 Stage and Discharge - Administration 2012-2013	54
Figure 29: Bridge 5900 Stage and Discharge - Administration 2013-2014	54

Figure 30: Bridge 5900 Stage Difference between USACE and Scour Monitor - Administration 2011-2012	55
Figure 31: Bridge 5900 Stage Difference between USACE and Scour Monitor - Administration 2012-2013	56
Figure 32: Bridge 5900 Stage Difference between USACE and Scour Monitor - Administration 2013-2014	56
Figure 33: Upstream View from USACE Control Points 6 at Winona, MN	57
Figure 34: Pier 19 Scour History - Administration 2011-2012	58
Figure 35: Pier 19 Scour History - Administration 2012-2013	58
Figure 36: Pier 19 Scour History - Administration 2013-2014	59
Figure 37: Pier 20 Scour History – Administration 2011-2012	63
Figure 38: Pier 20 Scour History – Administration 2012-2013	63
Figure 39: Pier 20 Scour History – Administration 2013-2014	64
Figure 40: Pier 20 Tilt History for Entire Monitoring Period	66
Figure 41: Bridge 5900 Voltage	67
Figure 42: Bridge 5900 Voltages.....	68
Figure 43: Degraded Master Station Battery Capacity.....	68
Figure 44: Bridge 07011 Stage and Discharge –Administration 2011-2012	71
Figure 45: Bridge 07011 Stage and Discharge –Administration 2012-2013	71
Figure 46: Bridge 07011 Stage and Discharge – Administration 2013-2014	72
Figure 47: Stage Difference between USACE and Scour Monitor – Administration 2011-2012	73
Figure 48: Stage Difference between USACE and Scour Monitor – Administration 2012-2013	73
Figure 49: Stage Difference between USACE and Scour Monitor – Administration 2013-2014	74
Figure 50: Pier 4 Downstream Bed Elevation – Administration 2011-2012	75
Figure 51: Pier 4 Downstream Bed Elevation – Administration 2012-2013	76
Figure 52: Pier 4 Downstream Pier Elevation – Administration 2013-2014	77
Figure 53: Bridge 07011 Voltages.....	78
Figure 54: Bridge 07011 Voltages.....	79
Figure 55: Wire Corrosion on Solar Panel Wire	80
Figure 56: Relocated Solar Regulator	80
Figure 57: 35 Amp-hour Battery Replacement on Bridge 070011 Master Station	81

Executive Summary

Bridge scour is the removal of sediment around bridge foundations and can result in the failure of the bridge. Scour monitoring is performed to identify unacceptable scour on bridges considered to be scour critical and determine when scour reaches elevations that could cause potential bridge failure. Two types of monitoring are available: portable monitoring and fixed monitoring. Prior to this project, MnDOT was only using portable monitoring devices, which requires the deployment of personnel to make physical measurements of scour depths. For some scour critical bridges, especially during high-water events, fixed instrumentation capable of continuous scour monitoring was preferred, but MnDOT lacked the experience or expertise to install this type of equipment.

This project installed fixed monitoring equipment at two bridge sites and monitored them for three years to determine the effectiveness and reliability of fixed scour monitoring deployments. Several device options were installed to allow MnDOT to analyze the installation and performance of different types of sensors.

Fixed scour monitoring equipment was deployed on the following two bridges:

- Bridge 07011, T.H. 14 crossing the Minnesota River at Mankato, Minnesota
- Bridge 5900, T.H. 43 crossing the Mississippi River at Winona, Minnesota

Bridge 07011 utilizes an underwater sonar device, a radar stage sensor, two wireless float-out devices, and two tethered (wired) buried switches. Bridge 5900 utilizes two underwater sonar devices, an underwater pressure stage sensor, and a two axis tilt sensor. Data collected from the sensors are transmitted to an offsite database for viewing by personnel through an interface. Based on criteria set for scour depth, tilt angle, and battery power, warning messages and alerts are sent to personnel via email.

Both systems operated for the three years with some outages due to various causes but overall performance was acceptable. The outages were mostly related to power issues and communication issues. Valuable lessons were learned through the deployment, which may be applied to future installations. The deployment executed in this project has provided the confidence to deploy other fixed scour monitoring equipment at key bridges around the state of Minnesota. In addition, the data collected during deployment of the scour monitoring equipment has been stored and provides insight into scour processes. This data can be used by other research groups for design or research purposes.

Lessons Learned

This extended deployment of scour monitoring equipment has provided the following information for future deployments.

1. Installation

- a. Datalogger enclosures and solar panels should be located so access is possible with commonly used district equipment. However, this should be balanced with difficulty of access for vandals. The current deployment has experienced some issues with inaccessibility of equipment and no issues with vandalism.
- b. If possible, wire splices should be only performed inside of the datalogger enclosure. No splices should be under water at any time.
- c. Enclosures and solar panels should be installed in locations out of the splash zone of snow plows. This mitigates snow build up on the solar panel and prevents excessive rusting of wire or other components. Road salt accelerates rusting.
- d. As with all installations, procedures and material should be carefully reviewed before proceeding with installation.

2. Installation Equipment

- a. Under bridge inspection truck (“snooper”) is required for most installations. They were mostly clearly needed for the conduit runs up the faces of the piers and mounting of brackets not accessible from boat, deck, or river bed. It is important to verify that the “snooper” flight path can reach all work areas.
- b. A stable boat is very useful for installation on deeper rivers. Bridge 5900, which crosses an impounded section of the Mississippi, is a good example.
- c. Electrical/signal technician vans typically have the majority of tools needed for installation with the exception of hammer drill and concrete fasteners.
- d. Electrical/signal boom trucks are beneficial to have for solar panel installation, especially if bridge trusses reach above the roadway.
- e. Hand tools can be used for burying float-out devices if the river bed is above the river stage at the time of installation. This may take more time, but is much more straightforward than bringing heavy equipment on site.
- f. Proper equipment and traffic control equipment is required as necessary. These are common procedures for MnDOT.
- g. The truck mounted crane provided a good way to lower heavy components, primarily the sonar mount, from the bridge deck to near the water surface. The crane on the boom truck may also be used for this if it has acceptable load limits and cable lengths.

3. Before Installation

- a. A suitable installation plan with drawings with adequate details should be made prior to the installation. In addition, the plans should be thoroughly

discussed with the bridge crew and electrical technicians before installation. Ideally, this would happen in person. This ensures all parties are well informed on of steps of installation and installation proceeds quickly while traffic is affected.

- b. The datalogger system should be fully functional, tested prior to installation and as fully assembled as possible, including mounts. Additionally, any onsite electrical connection should be clearly noted in a document to prevent any confusion on-site. The current deployment was miswired during installation and caused a sensor to only be powered on only when modem is powered on. This was mitigated with remote reprogramming
- c. The sonar brackets near or below the water surface should be as fully assembled as possible including sensors mounted. Furthermore, good elevation references should be known to quickly install brackets on the piers and the brackets should be fully painted.
- d. Conduit, clamps, outlet bodies for pulling and junctions should be purchased prior to the install. In general, enough material for the full run should be purchased but exact dimensions are not needed. The conduit can be quickly bent, cut and connected on-site. In general, rigid conduit should be used where there is potential contact with water or debris and EMT should be used everywhere else for ease of conduit routing. Rigid pipe larger than $\frac{3}{4}$ " generally cannot be bent with a hand bender on-site.
- e. Plans for other component mounts, i.e., solar panels, should be completed. This is very bridge specific and final construction may need to be performed on site.

4. During Installation

- a. Final operation should be verified using the telemetry system during installation.
- b. Appropriate extra cables should be on hand to extend any runs, if needed. This generally applies to the solar panel cabling, but can include the sensor cables.
- c. Some tasks can be performed at the same time to reduce roadway closure times, i.e. sonar cable mounting and solar panel cable routing.

5. Scour Monitoring Equipment Design

- a. Although it is important to keep signal cables short, solar panel cables can be considerably longer due to low currents. The datalogger enclosure should be located close to the sensors while still being fairly easy to access for the DOT. Solar panels can be located relatively farther away in a location with good sunlight and where it is unlikely to be damaged.
- b. Conduit is *NOT* required for each cable run. Generally, conduit is only needed for high voltage, i.e. 120 volts cable runs. Conduit was only used on the cable runs near the water surface for protection of the cable.
- c. Any items capable of rusting need to be painted to prevent added corrosion to the bridge.
- d. Submerged sensors should be located at an elevation that are typically not in the ice layer or elevations where debris is typically found. For Bridge

07011, the sonar sensor was mounted above the typical water level and increasing stage levels submerge the sensor when scour events are likely. For Bridge 5900, the sonar sensor and pressure stage sensor was mounted about five feet below the typical minimum water level.

- e. Conduit runs should closely follow within inches the pier face profile to minimize damage from ice and debris.
- f. Cellular modems can potentially create excess electrical noise on a system. Sensitive voltage measurements should be performed when this or other noisy sources are powered off.
- g. Power budget should be carefully reviewed prior to installation and minimum energy storage of five days without solar recharging is required.

6. Personnel

- a. The involvement of MnDOT signal technicians personnel is very important and they generally take leading roles during the installation. This support will need to be contracted out if electricians are not available internally. The bridge groups generally view this type of installation under the jurisdiction of electrical services. Furthermore, they have expertise and equipment needed in the installation, including cable routing, conduit bending, wiring connections, and solar charging systems. The personnel costs for signal technicians or electrical contract costs should be included in future installation plans.
- b. The district bridge units generally know the best methods to install once the overall plan is presented. They also have great knowledge about bridge and its debris issues. They are very capable and can quickly fabricate items for the install, if necessary.
- c. It is critical to have somebody with hydraulics background examine the historical stage data, bridge structure and debris issues to come up with a good plan for locating sensors.

7. Sensors

- a. Limitations of tilt sensors should be clearly outlined prior to installation and before disseminating data to other groups. It should be reiterated that the type of tilt sensors used on this project are primarily used for finding abrupt changes to tilt rather than long term tilt monitoring. Analog sensor signals will naturally drift without routine recalibration. Specific installation guides should also be provided to ensure tilt sensor is rigidly mounted to bridge.
- b. Wireless float-out device communication protocols must be fully understood for successful deployment. This deployment initially failed to detect a float-out device due to the receiver ignoring the float-out devices after three successful wireless communications with the float-outs. This likely occurred during installation. This communication should also be more robust to remove these types of issues.
- c. Sonar sensors are susceptible to signal attenuation from suspended sediment and excessive distance measurements due to additional echoes from surface ice or debris. These should be mitigated with logical

programming. “No return” readings should also be excluded from calculating readings.

- d. Successful, long-term monitoring can be performed with sonar devices by carefully locating sonar out of typical elevations of ice and routing conduit directly along pier face to utilize strength of pier.

8. Power

- a. Batteries need replacement every three years. Batteries should be sealed with enough energy storage (Amp-hours) to run the system for five days with no charging.
- b. Batteries were undersized for the equipment’s power needs and solar recharge rates in Minnesota. The power budget for solar-based deployments should be carefully reviewed for determining solar panel size and battery’s energy storage capacity. Campbell Scientific provides a technical application note which should be followed and is listed in the references of this report.

9. Data Visualization and Warnings

- a. Overlaying critical bridge geometry elevations in addition to scour elevations is helpful to interpret data visualizations quickly. This includes footing elevations, water surface elevations, and scour critical water surface elevations.
- b. Excessive warning notifications sent to district staff can result in monitoring fatigue in the staff and may result in missing severe warnings.

10. Overall

- a. Careful hydraulic insight is needed to interpret scour data. There may be many local factors such as presence of dam in the vicinity that could affect sediment transport load and thus affect the scour. This was the case with monitoring at Bridge 5900

1 Introduction and Project Background

The purpose of this project is to implement fixed scour monitors on two bridges in Minnesota. The project was performed in cooperation with ETI Instrument Systems, Inc., the MnDOT Bridge Office Hydraulics Section, MnDOT District 6 – Winona, and MnDOT District 7 - Mankato.

The bridges selected for instrumentation were based on the preliminary work plans created in a previous report, *Bridge Scour Monitoring Technologies: Development of Evaluation and Selection Protocols for Application on River Bridges in Minnesota*. These two bridges are listed below.

- Bridge 07011, T.H. 14 crossing the Minnesota River at Mankato, Mn
- Bridge 23015, T.H. 16 crossing the Root River near Rushford, Mn

The instrumentation plans for these two bridges included the following major items.

1. Sonar and stage sensors and associated assemblies
2. Conduit
3. Datalogger and associated enclosures
4. Installation
5. System construction and programming
6. System maintenance and ongoing costs

Quotes for the two systems were also received from ETI Instrument Systems, Inc. for the system construction and programming that included all hardware, assembly, programming, and system manuals for both installations (see Appendix C). These ETI quotes for a turnkey scour monitoring system for both bridge sites totaled \$43,793 plus taxes. ETI was not onsite for installation, so this does not include travel or installation labor hours.

During the initial stage of this project, Bridges 07011 and 23015 were examined to ensure that they were suitable for this implementation project. Bridge 07011 was kept as a suitable bridge for the following reasons.

- Bridge was scour critical
- Major bridge with high traffic
- Difficult to monitor scour with portable devices

Bridge 23015, however, was not suitable bridge for this effort for the following reasons

- Lack of district interest
- High likelihood of debris damage to sensor
- Low significance bridge with low traffic levels

Discussion between MnDOT's hydraulics division and MnDOT District 6 personnel resulted in the selection of Bridge 5900 on T.H. 43 over the Mississippi near Winona as a suitable replacement site. The reasons for the suitability of this bridge for fixed monitoring implementation are the following.

- Bridge is scour critical with a history of scour at main channel pier #19
- District interest

- Bridge in same District as bridge 23015 causing minimal impact on the project plans
- Difficult to monitor with portable devices.

The project was organized into the following subtasks

1. Verification of bridges, products/technologies, and installation methods to identify any risks associated with deployment.
2. Equipment procurement
3. Equipment installation
4. Intensive monitoring for the first few weeks after deployment to resolve and report on any operational problems.
5. Developing technical documentation of the equipment.
6. Conduct a “testing event”. The event was the simulated release of a float-out and verification that the event was detected. This also verified that the automated personnel notification system was functioning.
7. Yearly administration reports that described system operation for each of the three years of deployment.

2 Verification of Bridges, Products, and Installation Methods

The first task of the deployment process was to determine the bridge geometry, verify sensors selected were appropriate for the installation, and verify the installation methods were suitable. Some final design aspects such as final mounts were considered, but were not finalized during this initial task.

2.1 Bridge/Stream Geometry Verification

The bridge geometry, current bed levels, and anticipated typical and maximum water surface elevations were needed to plan both implementations.

Bridge geometry was taken from various MnDOT plan sheets and verified with recent photographs. Applicable structures on Bridge 07011 structures were unchanged since bridge construction. However, bridge 5900 has had some pier modifications since construction. A concrete structure was added in 1998 at the water level to repair damage. These modifications were added to the workplan drawings.

Current bed levels were taken from the most recent profile from underwater bridge inspection reports and other sources.

Typical and maximum water surface elevations were determined from a variety of sources. These include flood profiles, underwater bridge inspection reports, scour action plans, and historical data from the United States Army Corps of Engineers – St. Paul District website.

2.1.1 Bridge 07011

Bridge 07011 is in Mankato, MN in District 7. It is located on Trunk Highway 14 crossing the Minnesota River. Monitoring is necessary for 100-year flood events. The bridge crosses above the edge of a massive dolomite rock feature extending towards the east. All of the foundations on the eastern portion of the bridge sit on spread footings. Only piers four and five are susceptible to scour. The distances from the deck to the spread footings are 80 and 70 ft, respectively. The river is straight in this area.



Figure 1: Bridge 07011 - Upstream profiles of piers 3 through 6

The piers of Bridge 07011 are solid and aligned with the flow direction. Scour is mostly limited to local pier scour. A dike and the dolomite rock feature contain the river

upstream of the bridge so there is no floodplain. The US Army Corps of Engineers operates stage monitoring station located 2.3 river miles upstream of the bridge.

The high water elevation, 775 ft, corresponds to the 100-year flood event and the typical water elevation is 749 ft. The river bed is active because of the sandy bottom and the fast moving current.

Daily traffic on Bridge 07011 is 22,000 vehicles. The bridge is located within the city of Mankato, MN, and is not due for replacement within the next ten years.

Data collection from the bridge monitoring systems is accomplished over cellular networks. Bridge 07011 is located within Verizon's coverage area.

The Underwater Inspection Report noted one-foot diameter logs lodged against piers indicating large debris accumulation is an issue at this site. The report also noted that the bed around pier 4 was silty sand and bedrock is the subsurface material. The bed at pier 5 is typically above the water level and the bed at pier 4 is typically underwater.

2.1.2 Bridge 5900

Bridge 5900 is in Winona, MN in District 6. It is located on Trunk Highway 43 crossing the Mississippi River. Monitoring is necessary for floods greater than the 5-year event. The large steel truss bridge has 22 piers and crosses a portion of the Mississippi to an island. Only piers 18 through 22 are scour critical. The piers are aligned with the flow direction. Piers 20, 21 and 22 are not in the main channel. Piers 18 and 19 are larger piers supporting the main span and are located in the main navigation channel. The reach of the river is located in Navigation Pool 6 between Dams 5a and 6 so water elevations are controlled. Water surface elevation in the pool is typically maintained at a stage of 645 ft (NAVD88) during low flows.



Figure 2: Bridge 5900 - Piers 18, 19, and 20 from Right to Left

Pier 18 is partially covered by riprap from the levee on the south side of the bridge. Scour depressions were found on the upstream side of piers 19 and 20. The bed material at the base of piers 19 and 20 was noted as sand, but no information was given for piers 21 and 22.

The Bridge Scour Action Plan calls for scour monitoring by boat when the water elevation reaches 653.6 ft. Scour is limited to local pier scour. A second branch of the river is located to the north of the bridge site.

A 2003 USACE flood frequency study stated the 200-year event elevation to be 660 ft. This study also states the typical pool elevation is 645 ft, which matches the elevation during the 2008 Underwater Inspection Report.

The MnDOT website lists the average daily traffic as 11,600 vehicles and there is also pedestrian and major barge traffic at the bridge site. The bridge is located within the city of Winona, MN, and is due for rehabilitation in 2017 with a new bridge constructed just upstream starting in 2014. Bridge closure for monitoring equipment installation was estimated to be difficult because of the large amount of daily traffic on the narrow two-lane bridge.

2.2 Equipment Verification

Only the acoustic stage sensors were found to be out of range for the sites. The bottoms of the bridges decks, where stage sensors are mounted, are 50 and 60 ft for Bridge 07011 and 5900, respectively. The acoustic sensor typically used by ETI has a maximum range 33 ft. Instead, a radar sensor was used on Bridge 07011 and a submerged pressure sensor was used on Bridge 5900.

Other issues affecting installation were wiring lengths, which should be kept as short as possible while ensuring adequate length for installation, and the direction and location of solar panels to maximize energy capture. The panels need to face south in a sunny location.

2.3 Installation Verification

Bridge inspection trucks are used to access the underside of the bridge and face of the pier to install the equipment. The *MnDOT Inspection Vehicle Policy Manual* included “flight paths” which describe the reach of these vehicles. The A-75 snooper stationed in Oakdale had a maximum under bridge vertical reach of 75 ft. The A-62 snooper stationed in Owatonna had a maximum under bridge vertical reach of 62 ft. There was no specification on the horizontal reach of these vehicles at these maximum vertical reaches.

Bridge 5900 required a reach of 66 ft down and 19 ft outward from the deck edge. Bridge 07011 required a reach of 56 ft down and 23 ft inward from the deck edge.

MnDOT provided a Kann boat with dual 50 HP motors as a work platform to install the sonar mount and sonar device below the water surface on piers 19 and 20 of Bridge 5900. Conduit and wiring on the footing and lower part of the pier were also installed from the water surface.

Bridge 07011 required access to the east shore of the river by walking down the road embankment slope to install buried sensors. Shovels were used to install buried sensors. A power auger would have been necessary if a deeper hole was needed.

Conduit and mounts required concrete fasteners. This is common practice for MnDOT.

2.4 MnDOT Work Plan Modifications

The transition from Bridge 23015 to Bridge 5900 required modifications to the original workplan. Additional instrumentation types were requested from MnDOT to test a wider variety of scour monitoring devices. The two tables below list the original plans for Bridges 07011 and 23015.

Table 1: Bridge 07011 Original Plan

Item	Location
Master Datalogger Station	Top of Pier 5
Sonar Transducer	Base of Pier 5
Remote Datalogger Station	Top of Pier 4
Stage Sensor, Acoustic	Top of Pier 4
Sonar Transducer	Base of Pier 4

Table 2: Bridge 23015 Original Plan

Item	Location
Master Datalogger Station	Top of North Abutment
Float-out Receiver/Decoder	Top of North Abutment
Wireless Float-out Devices (4)	Base of North Abutment
Tethered Buried Switches (2)	Base of North Abutment
Remote Datalogger Station	Top of Pier 5
Stage Sensor, Acoustic	Top of Pier 5
Sonar Transducer	Base of Pier 5

The major changes from the original plans to the final plans are summarized below.

1. Bridge 07011 – The Pier 5 sonar transducer was replaced with wireless float-outs and tethered switches. This also included the float-out receiver/decoder. This change were made because the bed is above typical water surface elevation away from the thalweg of the river and the desire to test these two types of equipment
2. Bridge 07011 – The acoustic stage sensor was replaced with a radar stage sensor because the elevation difference from the sensor to the water surface was greater than the range of the acoustic sensor. The range to the typical water surface elevation was 43 ft and the acoustic sensor’s maximum was 33 ft.
3. Bridge 5900 – The Pier 21 tilt meter was added. The tilt meter was added to evaluate this sensor for scour and bridge monitoring and provide additional field testing experience with different sensors.
4. Bridge 5900 – Sonar sensors were added on Piers 19 and 20. These are both locations where there is active scour and little protection. Pier 18 is also a scour critical pier, but there is some protection from riprap on a levee located close to that pier.
5. Bridge 5900 – The acoustic stage sensor was replaced with a pressure based stage sensor. This change was made because the elevation difference from the sensor location to the water surface was greater than the range of the acoustic sensor. Also, the pressure based sensor was much cheaper than the radar sensor.

2.5 Installation Work Plans

Work plans for the deployment of fixed scour monitoring equipment on Bridge 07011 in Mankato and Bridge 5900 in Winona were prepared. The plans included figures for instrument location, wire routing, a quote for hardware and programming from ETI Instrument Systems, and estimates for costs associated with installation and maintenance.

The objective of this work plan was to provide necessary information and rough estimates of costs for deployment scour monitoring equipment. The following sections describe the deployment aspects at the time of workplan writing.

2.5.1 Sonar Assemblies

The enclosures that contain the sonar and mount must have the following characteristics.

- Robust enough to withstand debris impacts
- Does not impede the line of sight of the sonar device

- Angles the sonar away from the footing.
- Does not impede the operation of the stage sensor
- Mounts rigidly to the front of the pier
- Connects directly to conduit to eliminate exposure of wires to debris

On Bridge 07011, locate the bottom of the sensor enclosure at an elevation of 755 ft. This is above the potential location of river ice, which was determined from historical data (Figure 3). On Bridge 5900, locate the position of the sensor enclosure at an elevation of 641 ft, about four feet below the typical water surface elevation. Figure 4 shows the historical river stage rarely falls below 644 ft. Lake ice typically grows no thicker than two feet thick therefore the sensor should be protected from freezing damage at this location.

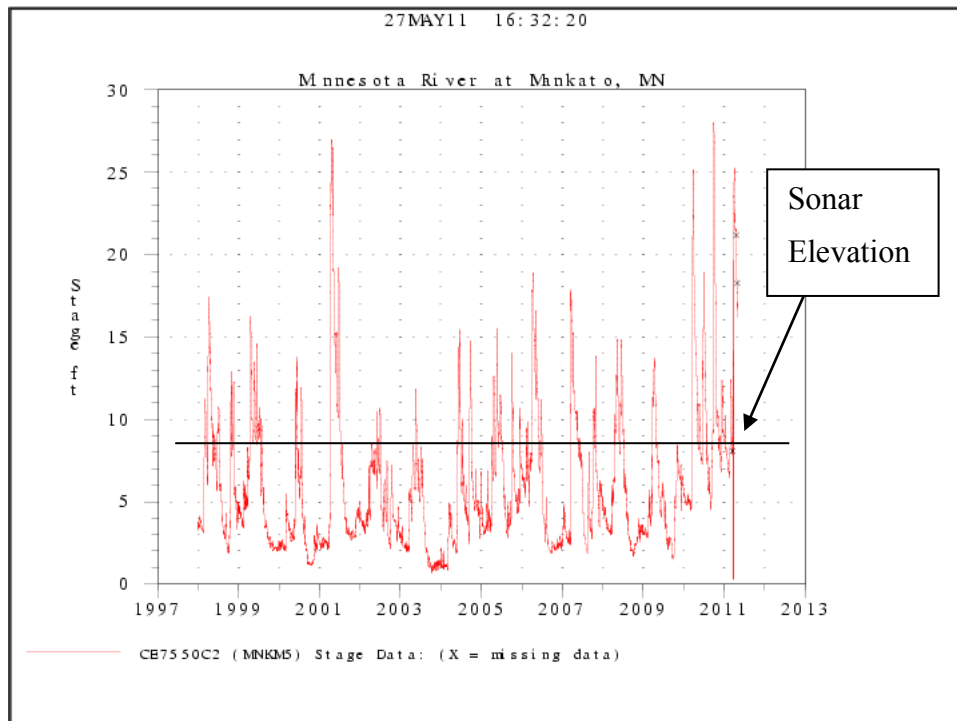

Figure 3: Historical Stage Elevation Two Miles Upstream of Bridge 07011 – Stage 0 is 747.92 ft

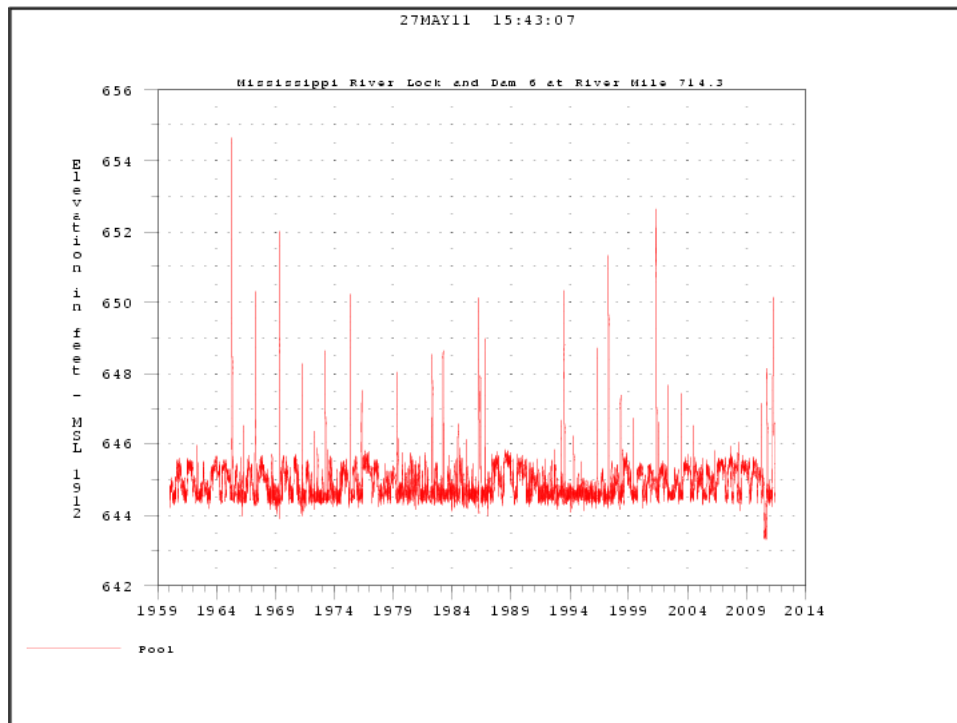

Figure 4: Historical Stage Elevation of Pool at Bridge 5900

2.5.2 Float-out devices and Tethered Buried Switches

Bury float-outs and tethered switches one foot in front of the footing. Locate tethered buried switches on the centerline of the pier and the float-out devices offset of the centerline. Mount the wireless receiver/decoder on the same side of the pier to maximize line of sight when the float-out devices are activated.

2.5.3 Radar Stage Sensor

Mount radar stage sensor on underside of the bridge superstructure 20 feet away from pier on same side as datalogger enclosure.

2.5.4 Tilt sensor

Mounting location of the tilt sensor is a very important design parameter for the monitoring. The location needed to exhibit tilt as opposed to translation if the foundation of the bridge started to move. An ideal location is the top of the foundation about $\frac{1}{4}$ of the length of the top of the foundation.

2.6 System Construction and Programming

Prior to system deployment, all hardware interfacing, datalogger programming, system testing, and finalization of all installation details were reviewed. ETI Instrument Systems, Inc. provided the fully programmed system and UMN provided database interface functionality.

The following functionality was incorporated in the program.

- Turn on cellular modem for fixed time(s) during the day for programming and data downloading. A secondary remote system should notify administrator if cellular connection fails at designated times.
- Turn on cellular modem, increase measurement frequency and/or notify personnel if
 - Water level exceeds a maximum threshold, i.e., 50 year flood elevation
 - Water level changes by a large amount between readings
 - Bed elevation at either pier fall below a set threshold, i.e., five feet above scour critical elevation
 - Bed elevation changes by a large amount between readings
 - Battery voltage falls below a designated value
 - Communications with sensors fail
- Repeat readings before notifying personnel to keep false warnings to a minimum
- Acceptable power budgeting

Installation preparation required gathering all materials needed for installation including the instrumentation system, conduit, and clamps for attaching the conduit to the bridge site. Every step of the installation required detailed planning so that work at the site could be completed efficiently.

2.7 System Operation and Maintenance

System maintenance was difficult to estimate, especially with the deployment of new systems. Maintenance is typically the most underestimated cost of a fixed scour monitoring system deployment. The following table lists the likely operation and maintenance items.

Table 3: Estimated Maintenance Costs and Hours

Item	Frequency	Description	Equipment Cost	Hours
System Evaluation	Yearly	Lane Closure	\$0	16
Unplanned Maintenance	Varies	Remote Reprogramming to Hardware Replacement	\$0 to \$3000	4 to 24

System Evaluation - A yearly system evaluation is needed to make sure that all of the components are working correctly. This should include a visual inspection of the system and an in-depth analysis of the data collected to check for irregularities that have passed the error trapping features of the datalogger program and database management software.

Unplanned Maintenance - Unplanned maintenance may be required from system failure, vandalism, damage from debris, or other unknown causes. Maintenance maybe as simple as remote reprogramming of the datalogger or as involved as sensor replacement. The resulting cost for these maintenance issues can range from \$100 to \$4000, depending on the severity of the problem.

During the three year deployment, replacement batteries were the only hardware costs and on-site yearly evaluation was not performed or needed. The data collected provided enough insight to determine if maintenance was required.

Another operational cost is the cellular modem requires a data plan from the cellular provider that will have a fixed cost per month. This was approximately \$26/month for the projects.

2.8 Total Costs

Additional materials totaling \$3,340 were purchased for mounting and protecting the components on Bridge 07011 and \$4,050 for Bridge 5900. This included wires supplied by ETI. The ETI Instrument Systems components, assembly, and programming was \$22,691.70 plus tax for Bridge 07011 and \$19,843.20 plus tax for Bridge 5900. The MnDOT District provided installation equipment, parts and labor. The monthly cellular plan and the yearly evaluation was \$312/year.

Unplanned maintenance costs are usually high for fixed scour monitoring. An estimate for the first year would be \$5,000 and decreasing to about \$1,000 for following years. Actual costs were much less than this. On-site maintenance was required only three times. Two times was needed to replace batteries and at third time was needed to rewire a solar panel cable that had rusted.

3 Equipment Installation at Bridge Sites

This chapter provides a summary of sensor system installation and addresses. This includes the following topics:

- Pre-install activities
- Sensor locations as-built
- Installation schedule description
- Location of data storage
- Drawings of scour monitoring equipment as installed
- Photographs of installed equipment

3.1 Pre-Installation Tasks

The following tasks were performed prior to installing the scour monitoring equipment at each bridge.

- Site visits to Bridge 5900 and 07011 and development of final installation plans.
- Review of drawings and plan with district managers and workers with final install plans
 - This included providing drawings for the installation and talking through the installation with district managers and maintenance workers
- Construction and programming of scour monitors by ETI personnel.
- The systems were fully programmed and ready for final connections when delivered.
 - Data retrieval setup at the University of Minnesota. The University's existing Campbell Scientific Loggernet network and was modified to incorporate the scour monitoring data to log all data after deployment. The system was tested by University of Minnesota prior to the installation.
- Fabrication of sonar mounts and pre-assembly of sonar in mounts.
 - The sonar mounts were designed specifically for each pier and were constructed at the University of Minnesota. The sensors were mounted on the brackets prior to arriving at the bridge site to speed installation.
- Purchase of conduit, junction boxes, and clamps
 - Final conduit was selected by MnDOT signal technicians. Rigid was used on lower portions of the conduit in contact with water and debris, and EMT conduit was used above this level. $\frac{3}{4}$ inch rigid and 1" EMT have nearly the same outer diameter and allowed use of the same bender, clamps, and connectors.
 - 90° and straight conduit outlet bodies were used for pull points and compression fittings were used for most conduit connections. These fittings worked with both the $\frac{3}{4}$ inch $\frac{3}{4}$ " rigid and 1 inch EMT.

3.2 Installation Equipment

The instrumentation installed consisted of the following major assemblies.

- Sonar and stage sensors and associated assemblies
- Tilt sensors (Bridge 5900, Pier 20)

- Conduit
- Datalogger and associated enclosures
- Solar panels

The following MnDOT heavy equipment was on site for the installation.

- Flat bottom hydraulics boat
- Crane truck
- Under bridge inspection truck (“Snooper”) Aspen A-75
- Worksite van
- Electrical/signal technicians van
- Boom truck
- Equipment needed for lane closure (trucks, etc.)

3.3 Installation Personnel

The following parties were on-site for the installation.

- MnDOT Bridge Units for Districts 6 (Winona) and 7 (Mankato)
- Electrical/signal technicians from both District 6 and 7
- MnDOT Bridge Office Hydraulics
- University of Minnesota providing technical guidance
- ETI Instrument Systems, who built and programmed the scour monitoring systems was available via telephone throughout the installation

ETI Instruments Systems initially planned to perform final connections, but the installation schedule prohibited this. Final connections were conveyed to MnDOT and the University of Minnesota through the Technical Manual Documents supplied with the systems and via telephone. This worked well with the exception of some miswiring that occurred on Pier 20 of Bridge 07011. These issues were mitigated with programming.

Table gives the personnel type, quantity and total hours for a typical two day installation.

Table 4: Personnel Type, Number, and Total Hours for Two Day Installation

Personnel Needed for Two Day Installations			
Type	Number Workers	Total Hours*	Comment
"Snooper" Driver	1	16	Cost bundled with "Snooper" Rental
"Snooper" Bucket Operator	1	16	Bridge maintenance worker with "Snooper" training
Traffic Control	2	32	Assume traffic reduced to one way
Maintenance Workers	2	32	Help with various tasks, i.e. digging, pipe bending, etc.
MnDOT Electrician	1	16	Performs majority of mounting and wiring connections
MnDOT Hydraulics Personnel	1	16	Directs work and answers questions during install

University of Minnesota	1	16	Directs work and answers questions during install
-------------------------	---	----	---

*Does not include travel time

3.3.1 District Bridge Maintenance

MnDOT Bridge Maintenance for Districts 6 and 7 provided the lane closure, safety procedures, and the majority of the manpower during the installation. These groups were very knowledgeable about conditions and characteristics of each bridge site, especially with regard to debris. They also had the personnel trained to operate the “snooper” from the basket. Overall, this group was very motivated and extremely adept at overcoming issues that came up during the course of the installation.

3.3.2 Electrical/Signal Technicians

The electrical/signal technicians were a critical part of the installation, although they were not in the original workplan. Future installations of this type of equipment should include these MnDOT staff from the start. The electrical/signal unit’s expertise includes wiring, electronics, conduit routing, and solar charging units. The group also has access to the electrical vans and boom trucks that were used extensively during the installation.

3.3.3 MnDOT Bridge Office Hydraulics

The hydraulics section provided valuable insight into the characteristic of the stream at each bridge and contributed to the installation of the buried sensors on Bridge 07011. They also provided the large flat bottom boat needed for the installation of the sonar brackets on Bridge 5900.

Overall, the hydraulics group is required during the installation of scour monitoring equipment because of the deeper insight they have into scour and river dynamics. They are familiar with the scour calculation procedure and can determine the best location of equipment to avoid damage from debris based on yearly stage cycles and other local hydraulics.

3.3.4 University of Minnesota

The University of Minnesota was contracted to organize the installation between the various parties involved. The University designed the overall installation and structural brackets to mitigate damage by river debris. They also monitored the scour monitors to ensure continual operation.

3.3.5 ETI Instrument Systems

ETI assembled and programmed the datalogger for operation and continued to provide support via remote programming of the system. The ETI System included all sensors, cables (some were added on-site for unforeseen changes to the install) and enclosures with mounts. Conduit and brackets for sonar, stage and receiver were not included.

The systems came fully prepped for installation with only minor programming modifications needed after installation.

3.3.6 Parties Required for Future Installation

Future installations can likely be performed without the University of Minnesota. The contributions required from the other parties are listed below.

- MnDOT Bridge Maintenance
 - Manage road closure
 - Supply major equipment
 - Provide fasteners and mounts
 - Supply majority of personnel
- MnDOT Bridge Office Hydraulics
 - Characterize stream at bridge site, i.e. max/min stage, debris depth, etc.
 - Gather input from local district and ETI or other scour monitoring system supplier
 - Create installation plan with sensor locations
 - Provide installation overview to other parties
 - Be on-site for installation
- MnDOT Electrical/Signal Technicians
 - Work closely with scour monitoring system supplier to understand connections and operation of assembled and programmed system
 - Perform conduit and cable runs and perform final connections
- ETI or other scour monitoring systems supplier
 - Purchase, assemble and program full scour monitoring systems
 - Provide documentation for final connections and operations
 - Work closely with MnDOT Electrical/Signal Technicians

An alternative is to hire a contractor to obtain and install the equipment or to include the work as part of a construction project.

3.4 Methods

To summarize the installation process, each of the components of the scour monitoring system are discussed individually.

3.4.1 Sonar Mounts

Sonar mounts were designed and constructed by the University of Minnesota prior to installation. The mounts were designed to meet the following requirements:

- Provide the sonar transceiver a unobstructed “clear view” of bed elevation while both keeping the deviation from vertical orientation to a minimum and keeping the sonar as close to the pier face profile as possible.
- Provide access to sensors without divers.
- Maintain majority of mount as close to pier profile as possible.
- Place sonar sensors out of elevations where damage from ice and debris could typically occur.
- Protect cables along pier profile and through the water surface.

3.4.1.1 Installation details

The positions of the mounts were determined by measuring from known elevation points on the bridge pier. The bracket was held up to mark the holes, the holes were hammer drilled and concrete bolts were used to mount the brackets. The installation of the these mounts were mounted in less than hour after setup.

The mount for Pier 4 of Bridge 07011 required four bolts on the base plate, which was curved to match the radius of the pier face (**Error! Reference source not found.**). The mount was carried down to the mounting location in the “snooper” bucket. Three people including the operator helped mount the bracket to the pier face. The “snooper” was extended fully downwards during the installation. The holes were drilled and the mount was attached to the pier face.



Figure 5: Bridge 07011 Sonar Mount

The mounts for Piers 4 and 5 of Bridge 5900 used a two-part mount connected with a hinge. The hinge allows the sonar, typically underwater, to be swung up and accessed. The installation was performed with a flat bottom boat and a truck mounted crane. The upper portion of the mount was taken to pier via the boat. The holes were marked, hammer drilled, and concrete bolts were used to mount the upper portion of the brackets (Figure 6). A conduit was mounted under the upper portion of the mount to route the cable. The lower portion of the sonar mount was lowered from the bridge deck using the crane. The mount was lowered to the boat (Figure 7), attached to the hinge on the upper portion of the mount (Figure 8), and dropped into place using the eye hook on the mount (Figure 9). Prior to swinging the lower mount into place, the cables were routed up conduit mounted under both the lower and upper portions of the mount.

The lower portion of the sonar mounts were heavy, ~200 lbs. This would have created issues if the heavy lifting equipment was not on site during the installation. During future access to the underwater sensors, heavy lifting equipment should be on site. Swinging the

lower portion of the mount out of the water is possible, but would be difficult using only a boat. Figure 17 is the final installed mount.



Figure 6: Bridge 5900 - Upper Sonar Mount

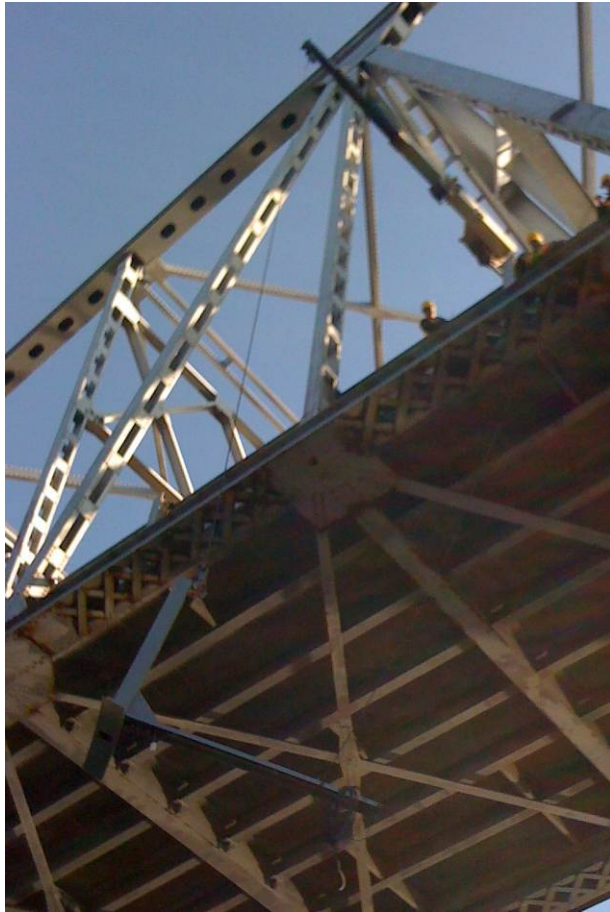

Figure 7: Bridge 5900 - Craning Lower Mount



Figure 8: Bridge 5900 - Attaching Lower Mount

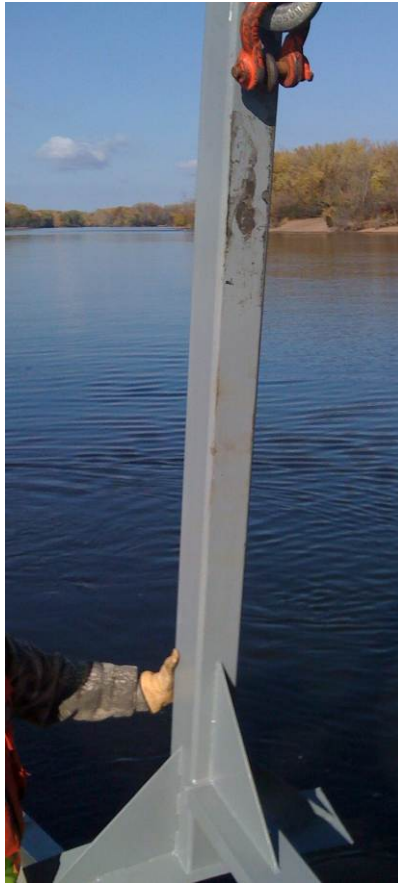

Figure 9: Bridge 5900 - Lower Mount with Eye-Hook (at top)



Figure 10: Bridge 5900 - Installed Sonar Mount

3.4.2 Conduit Runs

Conduit installations took 4 hours each, including cable chasing. The general approach was to use ¾ inch rigid pipe where there was potential contact with debris and ice and 1 inch EMT where debris was not an issue. Rigid pipe is more difficult to bend than EMT and EMT is preferred by the MnDOT electrical group. Heavy duty one and two hole pipe straps with concrete bolts were used to mount the conduit as needed. Compression couplings were used to join pipe sections and conduit outlet bodies were used for corners and wire pull locations. Special considerations for each bridge/pier are listed below.

- Bridge 07011
 - Pier 4 conduit was joined to sonar mount nipple with ¾ inch pipe union.
 - Pier 5 lowest section was 1 ½ inch rigid conduit to accommodate thick tethered buried switch cables and reducer was used to change to ¾ inch as the conduit went up the pier.
- Bridge 5900
 - EMT conduit was used for entire run as lower sections were protected by sonar mount.

Conduit was not used for the tilt sensor, float-out receiver, radar stage sensor, or solar panel cables. Initially, it was anticipated that this would be needed, but MnDOT electrical group had no issues with running low voltage cables without conduit.

3.4.3 Tilt Sensor

The tilt sensor was installed in fifteen minutes by MnDOT electrical group. The sensor came from ETI enclosed in a small plastic electronics case with water proof grommet (Figure 11). The enclosure was glued to the top of the concrete pier under the bridge superstructure using two-part epoxy provided by the MnDOT district bridge department. After installation, the cables were routed and connected to the datalogger.



Figure 11: Bridge 5900 - Pier 20 Tilt Sensor

3.4.4 Stage Sensors

The two bridges used two different types of stage sensors. Bridge 5900 uses a submerged pressure sensor and bridge 07011 uses a radar sensor. Typically, ETI provides scour monitoring equipment with sonar water level sensors. However, both bridges exceeded the maximum range, about 30 ft, of these sensors. The pressure stage sensor was used on Bridge 5900 because it provided a low cost alternative and the already submerged sonar mounts provided the location and conduit for the pressure sensor. The pressure stage sensor must be kept out of the ice layer. The radar stage sensor was used on Bridge 07011 because the sonar mount is mounted at an elevation above typical stage levels. The radar stage sensor is much more expensive but has double the range of the sonar stage.

On Bridge 5900, the pressure sensor was mounted on the sonar mount on the back side of the c-channel prior to arriving on-site. Two screw-on conduit clamps were used to hold the pressure sensor in place. The power, signal and air tube connection were run up the conduit with the sonar wiring. The desiccant head was mounted to the end of the air tube inside of the datalogger enclosure. The appropriate length of cable was designated when ordered.

On Bridge 07011, the radar stage sensor was mounted to the underside of the north superstructure I-beams 20 ft west of the Pier 4. This location gives lower stage elevations compared to directly upstream of the bridge due to bridge hydraulics. The radar was mounted to a piece of Unistrut. The Unistrut was cut the same width as the I-beam and attached with large c-clamps. The cable was routed without conduit to the datalogger enclosure and final connections were made. Large c-clamps were used to route the cables.

3.4.5 Float-out Devices

Float-out devices were installed on the upstream side of Pier 5 on Bridge 07011. The primary focus was to place the sensors on the west side of the pier so that they would float downstream on the same side of the receiver antenna. This ensures as much line of sight as possible and increases chances that the float-out signal is received after scoured out.

The target elevations for the float-out devices were 748 and 746 ft, but the final elevations were 756.4 and 753.7 ft. Scour critical elevation is 746 ft and the bed elevation at the time of install was 761 ft. It was determined that 4.6 to 7.3 ft of scour would be an event worth warning. The float-outs were installed using shovel and posthole diggers and took about 4 hours. The water level at the time of install was about 750 ft, so no water was encountered in the holes. See the as-built drawing for final locations.

The final connection to the battery was completed and the float-out devices were buried.

The float-out receiver was mounted on a piece of Unistrut to the bottom of the south side of the I-Beam superstructure (Figure 12). The receiver was placed about six feet west of the pier centerline. The cable was routed without conduit back to the datalogger enclosure.

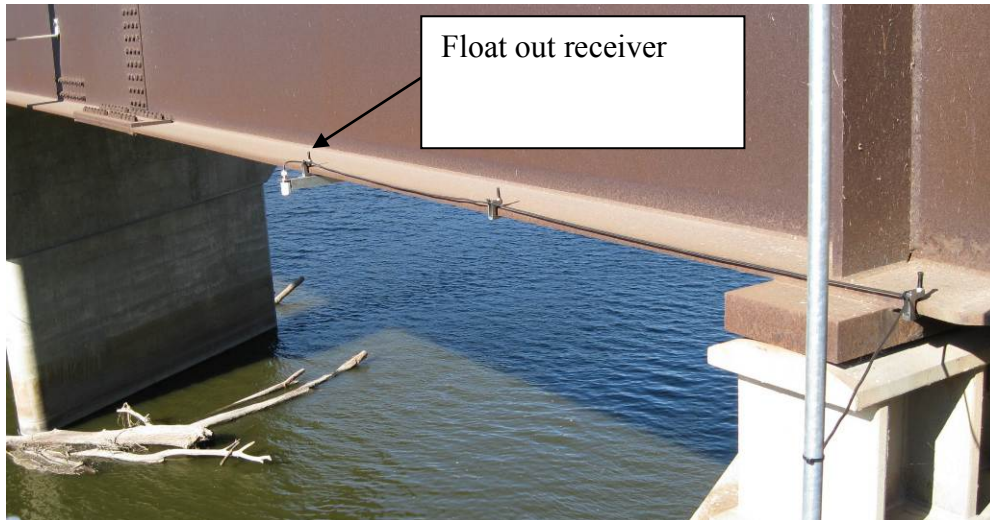

Figure 12: Bridge 07011 - Float-out Receiver

3.4.6 Tethered Buried Switches

Tethered buried switches (TBS) were buried five feet to the west of the Pier 5 nose on Bridge 07011 and were installed using the same general process and at the same time as the float-out devices. See the Section 3.4.5 for conditions at installation. The TBS's were initially planned to be buried at elevations of 746 and 748 ft; however this was too deep with the tools on hand. The installed elevations of the sensors were 753.7 and 751.7 ft. These elevations correspond to the elevations of the tip of the tethered buried switches and the tips need to be installed vertical to place in the non-activated state. Switches indicate scour by indicating when the tips are in stream and are horizontal. The sensors will likely be scoured out at a somewhat higher bed elevation than buried at.

The tethered buried switches are enclosed in the end of a 20 foot long $\frac{3}{4}$ inch hose and then reduced down to signal cable for the remainder of the run to the datalogger. Approximately 8.6 and 6.6 ft of the hose for the lower and higher installation, respectively, were used to run to the location of TBS from the $1\frac{1}{2}$ inch conduit. This included 4.6 ft horizontally from the end of the conduit and then four and two feet vertically down for each respective TBS. See Figure 13.

The remainder was installed inside of the 1-1/2 inch conduit on the front side of the pier. The switches were first buried and then the cables were pulled up the conduit to the datalogger enclosure. The cable from the tip location to the 1-1/2 inch conduit was buried and the cables entered the conduit below the bed elevation at the time of installation to prevent the cable from being jiggled by the current during high stages.

Final connections were performed after chasing the cables up the conduit.



Figure 13: Bridge 07011 - Installation of Tethered Buried Switches

3.4.7 Datalogger Enclosures

Datalogger enclosures mounted quickly to the top of the Piers on Bridge 5900 and on the deck barrier on Bridge 07011. ETI provided Unistrut, Unistrut pipe clamp, and pipe to mount both the datalogger and the solar panel.

The Unistrut was mounted to the bridge with the concrete bolts. The data loggers on Bridge 07011 are accessible utilizing the electrical/signal technician boom trucks. This equipment is much more available than the “snooper” trucks. The data logger enclosures on Bridge 5900 are located at a position that is accessible when using fall arrest equipment. However, the angle of access is not good and any extensive work in the datalogger enclosure will require a “snooper.”

3.4.8 Solar Panels

Planning for locations of solar panels was the most difficult installation part. At Minnesota’s latitude, it is very important to get a clear view of southern sky to maintain good charging throughout the winter months. Also, mounting solar panels towards the roadway invites damage from plows and other roadway debris. Only Pier 5 of Bridge 07011 had the datalogger on the south side of the bridge which provided a location out of the way of debris and with a clear view of the southern sky. None of the cables for the solar panels were run in conduit and all panels were pointed south $\sim 40^\circ$ from horizontal. The solar panels locations for each pier are listed below.

- Bridge 07011
 - Pier 4 solar panel mounted on south side of pier cap and cable ran from datalogger on north side. (Figure 14).

- Pier 5 solar panel mounted next to datalogger on deck barrier. See Figure 15.
- Bridge 5900
 - Pier 19 solar panel mounted on top of truss.
 - Pier 20 solar panel mounted on top of truss. (Figure 16).



Figure 14: Bridge 07011 - Pier 4 Solar Panel from Deck



Figure 15: Bridge 07011 - Pier 5 Solar Panel



Figure 16: Bridge 5900 - Solar Panel Locations

The solar panels of Piers 4 and 5 of Bridge 07011 were mounted using the same methods as used to mount the dataloggers. The cable for Pier 4 was extended using suitable gage wire and was first run along the top side of the north part of section of the pier while the “snooper” was on the north side of the roadway then was continued while the “snooper” was on the south side of the roadway.

The solar panels on Piers 19 and 20 of Bridge 5900 were mounted on top of the truss using electrical/signal technician boom trucks. The elevation of the solar panel for Pier 19 was near the maximum height for the boom truck. The solar panels were mounted on conduit mounted on the brackets show in Figure 17. The brackets were painted and attached using large c-clamps. Cables were extended and routed through the truss down to the datalogger and final connections were made.



Figure 17: Bridge 5900 - Solar Panel Bracket

3.5 Scour Equipment Locations

The following tables give an outline of the scour equipment mounted on each bridge pier. Together with the drawings and image taken during installation, a clear picture is given of the equipment installed and where the equipment is located.

Table 5: Bridge 5900, Pier 19 Scour Equipment

Bridge 5900, Pier 19 (Deck Elevation, 714 ft)			
Item	Elevation (ft)	Distance from Upstream Pier Face	Comments
Remote Station	~704	Close	Enclosure, datalogger, radio, antenna, 12 volt battery
Pressure Stage Sensor	640.75	9 inches	Mounted inside sonar mount
Sonar (Scour) Sensor	640	6 ft	Mounted on sonar mount
Solar Panel	~769	N/A	Mounted on top of bridge truss 36 ft east of pier centerline
Sonar Mount	640	Close	Hinged, can be rotated out of water with grab hook and eye bolt on upstream point
Conduit	N/A	Close	Houses sonar and stage sensor cabling, on centerline of upstream pier face

Table 6: Bridge 5900, Pier 20 Scour Equipment

Bridge 5900, Pier 20 (Deck Elevation, 710 ft)			
Item	Elevation (ft)	Distance from Upstream Pier Face	Comments
Master Station	~699	Close	Enclosure, datalogger, radio, antenna, 12 volt battery, cellular modem
Two-axis Tiltmeter	~701	11.25 ft	Mounted under deck at 1/4 pier width
Sonar (Scour) Sensor	640	2.75 ft	Mounted in sonar mount
Solar Panel	~735	N/A	Mounted on top of bridge truss 36 ft west of pier centerline
Sonar Mount	640	Close	Hinged, can be rotated out of water with grab hook and eye bolt on upstream point
Conduit	N/A	Close	Houses sonar cabling, on centerline of upstream pier face

The conduit used for both piers 19 and 20 on Bridge 5900 was 1" EMT up the entire pier face with straight conduit outlet bodies used where necessary for pulling or connection

wires. The conduit is protected from river debris by part of the sonar mount up to the elevation of 651.5 ft.

Table 7: Bridge 07011, Pier 4 Scour Equipment

Bridge 07011, Pier 4 (Deck Elevation, 813.3 ft)			
Item	Elevation (ft)	Distance from Downstream Pier Face	Comments
Remote Station	~811	Close	(Mounted on deck barrier)Enclosure, datalogger, radio, antenna, 12 volt battery
Radar Stage Sensor	800.9	3.75 ft	Clamped to I-Beam Sub Structure 20 ft west of pier centerline
Sonar (Scour) Sensor	755.3	1.25 ft	Mounted on sonar mount, typically above water surface
Solar Panel	~800	N/A	Mounted on upstream pier face to increase solar charging
Sonar Mount	755.3	Close	Fixed, can likely access with boat
Conduit	N/A	Close	Houses sonar cabling, on centerline of downstream pier face

The conduit used for pier 4 on Bridge 07011 was 3/4" rigid schedule 40 pipe up to the vertex of the hammerhead, elevation 792.2 ft, where a 90° conduit outlet body was used to transition to 1" EMT. 1" EMT and 3/4" rigid have similar outer diameters easing the transition. 3/4" rigid was used in the lower portions to help mitigate debris damage. 1" EMT was used above the maximum water line to ease installation with more bendable material. Straight outlet bodies were used as needed for pulling and connecting wires.

Table 8: Bridge 07011, Pier 5 Scour Equipment

Bridge 07011, Pier 5 (Deck Elevation, 815.6 ft)			
Item	Elevation (ft)	Distance from Upstream Pier Face	Comments
Master Station	~808	Close	(Mounted on deck barrier)Enclosure, datalogger, radio, antenna, 12 volt battery, cellular modem, float-out receiver
Float-out Receiver Antenna	~800.4	3.6 ft	Clamped to I-Beam Sub Structure 6 ft west of pier centerline
Float-out 1	756.4	2.5 ft	Buried 2.5 ft downstream and 9 ft west of pier face, float-out to stay west of pier if unburied by scour



Float-out 2	753.7	2.5 ft	Buried 2.5 ft downstream and 9 ft west of pier face, float-out to stay west of pier if unburied by scour
Tethered Buried Switch (TBS) 1	753.7	0	Buried 4.7 ft west of pier face
TBS 2	751.7	0	Buried 4.7 ft west of pier face
Solar Panel	~808	Close	Mounted on deck barrier next to datalogger
Conduit	N/A	Close	Houses TBS cables on centerline of downstream pier face







The conduit used for pier 5 was 1-1/2" rigid to an elevation of about 770 ft, 3/4" rigid to the vertex of the hammerhead, elevation 789.6, then 1" EMT to the datalogger enclosure. The rigid pipe was used to mitigate damage to the TBS cables, especially since they are mounted to the upstream face of pier 5. The 1-1/2" rigid pipe was required for the lower section to allow room for both TBS cables within the conduit. The pier profile allowed for no bending in the 1-1/2" section while closely following the pier profile. The cables are reduced to a smaller diameter after the first 20 ft, so a smaller cable could be used afterwards. Above the maximum water line, the conduit was again switched to 1" EMT to allow easier bending and installation.

3.6 Conduit and Mounting Hardware

Table 9 lists hardware used to mount the datalogger enclosures, sensors, and route conduit for each bridge. Images are provided for clarity. Conduit straps were located as needed for the installation. This included a strap on either side of each conduit connection (compression and conduit body) and a strap on either side of each bend. For straight runs, strap were used a minimum of one every ten feet.

Table 9: Conduit and Mounting Hardware

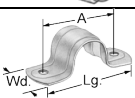
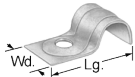
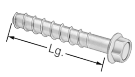
Conduit, Clamps, and Bolts Used During Installation			
Item	Image	Locations Used	Comments
3/4" Rigid Galvanized Pipe	N/A	Below water Surface, locations susceptible to debris	Difficult to bend with hand tools
1" EMT Pipe	N/A	Above water surface, locations out of way of debris	Easily bendable, fast install
1-1/2" Rigid Galvanized Pipe	N/A	Only straight runs; for thick cables, i.e. tethered buried switches	Unbendable with hand tools
3/4" to 1-1/2" reducing coupling		Transition from 1-1/2" to 3/4" rigid pipe	N/A
3/4" pipe union		Connection from welded nipple on sonar mount to conduit run	Easy connection with no pipe/conduit turning

3/4" Straight (C-style) Conduit Body		Pull points or breaks for wire splices	Have extra on hand
3/4" 90° (LB-style) Conduit Body		Pull points at ~90° conduit corners	Have extra on hand
1" or 3/4" Conduit Compression Connector		Adapt unthreaded conduit to conduit bodies	May not be needed depending on conduit body style
1" or 3/4" Conduit Compression Coupling		Connection between pipe junctions for both 1" EMT and 3/4" rigid	1 size fits both 1" EMT and 3/4" rigid
1" or 3/4" Two hole heavy duty strap		Below water Surface, locations susceptible to debris (1 every 10 feet and as needed)	1 size fits both 1" EMT and 3/4" rigid,
1" or 3/4" One hole heavy-duty strap		Above water surface, locations out of way of debris (1 every 10 feet and as needed)	1 size fits both 1" EMT and 3/4" rigid
1/2" and 3/8" Dia. Concrete Bolts		Mounting sonar mounts (1/2"), datalogger enclosures (1/2"), and conduit straps (3/8")	Holes predrilled with hammer drill
I-Beam Clamps		Mounting sensors/solar mounts on beams, routing cable without conduit	Ensure jaw exceeds I-beam flange thickness, bridge beam are THICK
Two-part Epoxy Adhesive	N/A	Mounting Tilt Sensor Enclosure	Supplied by MnDOT, ensure it adheres to concrete and plastic

3.7 Schedule

Both installations occurred from October 24th, 2011 to October 31st, 2011 within 6 working days.

Bridge 07011 installation took 2 1/2 working days and bridge 5900 installation took 2 working days

3.7.1 October 24, Bridge 07011

Parties Onsite: University of Minnesota, MnDOT Hydraulics, District 7 Bridge Crew, District 7 Electrical/signal Technician

Equipment Onsite: Snooper, Worksite Van, Electrical Van, Lane closure equipment.

The lane closure on the westbound direction of the bridge was set up by 9 am. At this time the snooper was set up to install the sonar and mount on the downstream side of Pier 4 and a crew was sent down to start digging holes for placing the float-out devices and tethered buried switches on the upstream side of Pier 5.

The installation of the sonar and mount was completed by noon. The remainder of the day was spent running conduit up the downstream side of pier 4 and mounting the data logger enclosure. The datalogger enclosure was mounted on the downstream side of the bridge on the bridge railing.

The installation of the float-out sensors and tethered buried float-out were completed by the end of the day. However, the conduit run was completed the next day when the snooper was available on the eastbound side of the bridge.

3.7.2 October 25, Bridge 07011

Parties Onsite: MnDOT Hydraulics, District 7 Bridge Crew, District 7 Electrical/signal Technician

Equipment Onsite: Snooper, Worksite Van, Electrical Van, Lane closure equipment.

The lane closure on the westbound direction of the bridge was set up in the morning allowing for the radar stage sensor to be mounted and the solar panel cables to be set up on top of the south side of pier 4. The solar panel is positioned in such a way to maximize incoming solar radiation while keeping the panel below the bridge railing. The lane closure was moved to eastbound direction of the bridge at noon. On pier 5, the float-outs and tethered buried switches were already buried on the previous day. The conduit run up the upstream side of pier 5 was installed and the master station was almost installed before the snooper started acting erratically and stopped work for the day at 3 pm.

3.7.3 October 26, No Onsite bridge work

No on-site work was performed on this day. The MnDOT electrical/signal technician worked on the float-out receiver mount to be installed on the October 28th.

3.7.4 October 27, Bridge 5900

Parties Onsite: University of Minnesota, MnDOT Hydraulics, District 6 Bridge Crew, District 6 and 7 Electrical/signal Technicians

Equipment Onsite: Snooper, Electrical Van, Boat, Crane truck, Boom truck, Lane closure equipment.

The lanes closure of the eastbound lane of Bridge 5900 and traffic control was set up to handle the bridge traffic reduced to one lane of traffic.

The sonar mount were mounted in a two stage process. The first was to fasten the c-channel mount to the bridge pier. This second stage was dropping the portion of the mount that was typically below the water level. This portion of the mount attached to the first with sturdy hinge.

While the lane closure was set up, a crew of 5 people in the boat attached the first section of the mount to the bridge pier. The boat was positioned in the streamwise direction against the front edge of the pier. The boat motor was used to pin the boat against the upstream side of the pier. Installation of the above water portion of the mounts was complete by about 10 am. EMT conduit was mounted under the c-channel to protect the cables.

The second, underwater portion of the sonar mount was dropped from the bridge deck using the crane equipped truck. The lower portion of the mount was then

rested on the boat and bolted to the hinge on the upper portion of the mount. The lower portion was then dropped into the water and swung into place.

Each of the sonar mount already had the sonar and stage sensor (Pier 19, Remote Station) mounted. Prior to swinging the lower portion into place, the cables were chased through the conduit mounted underneath the upper portion. The lower portions of the sonar were fully mounted by 12 pm. The conduit run on Pier 20 and mounting of the datalogger enclosure and pulling cables lasted the remainder of the day.

3.7.5 October 28, Bridge 07011

Parties Onsite: District 7 Bridge Crew, District 7 Electrical/signal Technician

Equipment Onsite: Worksite Van, Snooper, Lane closure equipment.

District 6 (Winona) Bridge Department do not work on Friday's so no work was performed on Bridge 5900.

After closing the eastbound lane on Bridge 07011, the master station, float-out receiver, and both solar panels were installed. Final electrical connections on the Master station were completed. These tasks were completed by noon. After ETI tested the system remotely, this finalized the installation on Bridge 07011.

3.7.6 October 31, Bridge 5900

Parties Onsite: University of Minnesota, MnDOT Hydraulics, District 6 Bridge Crew, District 6 and 7 Electrical/signal Technician

Equipment Onsite: Boom Truck, Electrical Van, Snooper, Lane closure equipment.

After the lane closure and traffic control was in place, two main activities were performed to complete the installation on Bridge 5900. This included running conduit and mounting the datalogger enclosure on pier 19 and mounting/connecting the solar panel for both the master and remote stations and mounting the tilt sensor on pier 20.

The snooper was used to run the conduit up the upstream face of pier 20.

It was decided that the solar panels should be mounted on top of the truss to maximize the amount of sunlight. The brackets were quickly fabricated by the MnDOT bridge crew offsite. The brackets were mounted with c-clamps. Cables were extended to reach the datalogger enclosures.

The tilt sensor was mounted on top of pier 19.

ETI tested the system remotely and this completed the installation of the system on Bridge 5900.

3.8 Data Storage

The scour monitoring systems as supplied from ETI are typically used to monitor scour and alert the appropriate personnel if a measured value exceeds a predetermined value, i.e. scour elevation at a pier falls below the scour critical elevation. The system performs this without any other systems to store or report to personnel. This is performed with the

onboard memory, which is constantly overwritten, and the cellular communication, which contacts people via email.

For the current project, the data is continually logged to a PC located at the University of Minnesota using the Campbell Scientifics Loggernet program. This program is used for all aspects of communication, including programming and data retrieval, for Campbell Scientific dataloggers. The overall approach of logging performed by Loggernet is to look for any new reading since last download and pull those readings for the datalogger. Data visualizations utilize software called Vista Data Vision was used to read files created using Campbell Scientific hardware. The system is also capable of creating warnings/notifications based on the data. The scour monitoring systems themselves also provide notification and warning independent of the data storage and visualization software. More recent data can also be accessed directly by MnDOT from the dataloggers.

3.9 Post Installation Modifications

There were a few modifications to the software and the hardware after the scour monitoring equipment was installed. These included the following.

3.9.1 Programming

The software modifications performed post install were mostly related to changing the sensor offset elevations, modifying alerts, and fixing some issues related to incorrect wiring on the Bridge 5900 Master Station located on Pier 20. It is important to remember that float-out devices have no scour elevations associated with them within the program

- Bridge 07011
 - Pier 4 Remote station - Stage Sensor Elevation was corrected on 11/2/2011
 - Pier 4 Remote station - Stage Sensor Elevation was corrected on 11/3/2011
- Bridge 5900
 - Header file corrected to state correct piers for sonar sensors on 11/2/2011
 - Pier 20 Master station - Reprogrammed to resolve incorrect wiring issues on 11/22/2011
 - § Sonar makes reading while cellular modem powered up
 - § Tilt and voltage readings taken when cellular modem is turned off
 - Pier 19 Remote Station – Stage elevation was corrected to read correctly on 2/22/2011. Measured range needed to be added to sensor elevation rather than subtracted as with above water sensors.

The biggest issue to resolve was the incorrect wiring issues on the Bridge 5900 Master Station. The issue was the sonar and cellular modems appeared to be powered together rather than individually. Both are powered off when the modem is not turned on. The programming fix made the sonar readings while the cellular modem was turned on and powered up. This can be seen in Figure 19 which shows that sonar readings are correct and stable after the 11/22 reprogramming. Prior to this, the readings were typically 640 ft because the elevation offset in the program and the output is 0 while the sensor is powered down. The correct readings prior to the reprogramming relate to time when the sonar and cellular modem happened to be powered on simultaneously.

The second issue was the noise on both the tilt sensor and the voltage reading. The noise was likely due to the cellular modem operation. This can be seen in Figure 18 where the signal is more noisy prior to the 11/22 reprogramming. The programming fix was to make these readings at times when the cellular modem was turned off. This may be due to poor wiring and could likely be resolved by rewiring making sure to remove any stray connections.

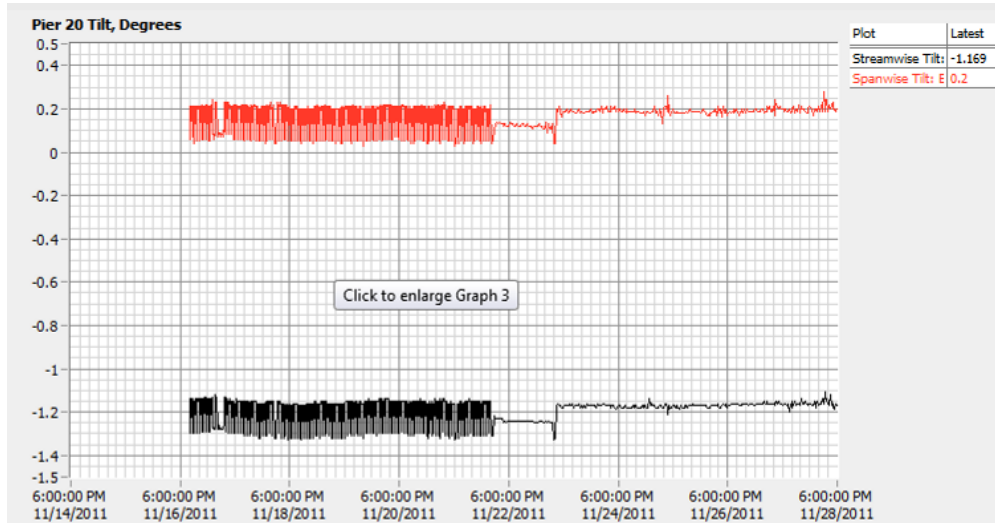

Figure 18: Bridge 5900 - Pier 20 Tilt Signals Before and After Programming Fix

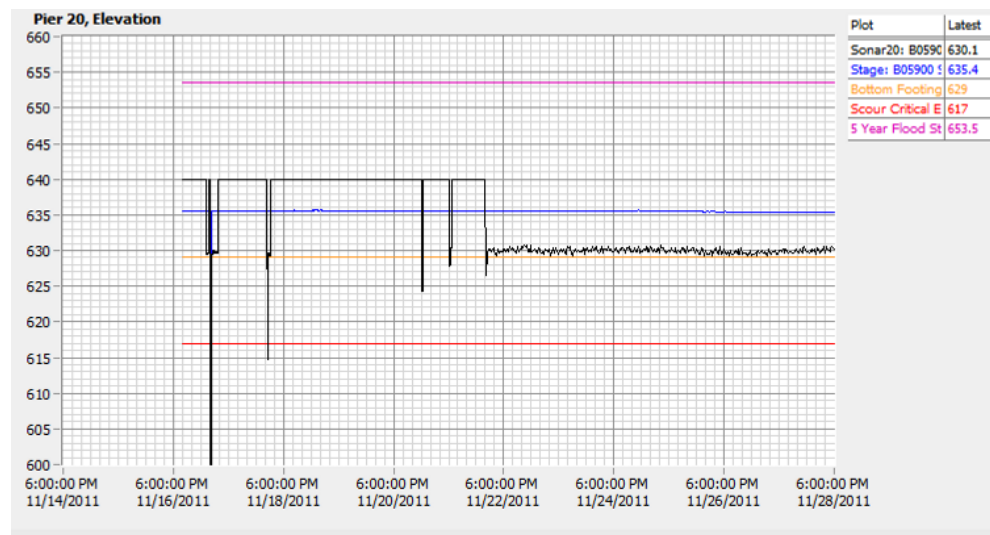

Figure 19: Bridge 5900 - Pier 20 Sonar Signal Before and After Programming Fix

3.9.2 Hardware

- Bridge 07011
 - Pier 5 Master station – Battery was replaced with a larger battery (35 Amp-hour) compared to original (12 Amp-hour) on 12/13/2011. Station lost power due to low battery voltage on 11/28/2011. This was performed by the District 7 Electrical/Signal Technician with a boom truck to reach over the side of the bridge to the datalogger enclosure. The District 7

bridge group provided the lane shutdown while the battery was switched out.

- Bridge 5900
 - Pier 20 Master Station - Still incorrectly wired, but fixed with programming outlined in Section 3.9.1.

4 Technical Documentation Report

This technical documentation report outlines the process of scour monitoring implementation and uses the two implementation sites as examples.

The implementation steps include the following:

- Site (bridge and foundation) selection
- Sensor selection, mounting location, and protection
 - Ancillary sensors (i.e. stage)
 - Other nearby monitoring
- Datalogging
 - Equipment
 - Power Budget
 - Mounting location
 - Programming
- Data collection and alerts
 - Onsite data collection and alerts
 - Offsite (long-term) data storage and alerts
 - Data visualization

4.1 Site Selection

Bridges are usually selected for scour monitoring because of a critical scour rating, observed scour, increased vulnerability due to nearby construction, or other observations of channel movement or local bed degradation. The current research project selected bridge to demonstrate fixed monitoring equipment. Future installations will be selected as an alternative or supplement to portable monitoring or countermeasure installation. Once a bridge has been selected for fixed monitoring, the appropriate locations need to be chosen for monitoring. Typically, scour calculations and a thorough review of the specific bridge files will indicate which foundations require monitoring. If there is limitation on the number of foundations to be monitored, the most susceptible ones should be selected. Most often, the most susceptible piers are located in the main channel of the river.

4.1.1 Bridge 07011

The eastern portion of the bridge sits on an erodible rock formation (Jordan sandstone). Due to this, Piers 4 and 5 only have spread footings and are considered scour critical and monitoring was implemented on these piers.

4.1.2 Bridge 5900

Piers 18 through 23 are the only piers which become submerged. Piers 18 and 19 support the main span over the main channel of the river and Piers 21 through 24 are protected by heavy upstream vegetation. Pier 18 is next to an armored levee with some of the riprap extending down to the pier adding additional protection. Therefore, scour monitoring was implemented on Piers 19 and 20.

4.2 Sensor Selection

The Scour Monitoring Decision Framework (SMDF) was used to aid in sensor selection. In general, the SMDF usually ranks sonar and float-out devices for their overall better characteristics. Sonar can remotely measure the bed elevation, including aggradation, providing continuous data. Float-outs do not require wiring and are not exposed to flow, which mitigates issues with debris and/or ice. Sensor Location and Protection

Selecting the sensor location is highly bridge specific. Extensive knowledge of scour locations, historical icing conditions, stage variation, and debris must be known for robust sensor location selection. Protection of sensors is an additional consideration, but it is best to locate the sensors out of the way of potential damage. Cables should be routed inside heavy duty conduit and mounted directly to bridge piers to avoid damage. General recommendations are listed below.

- Underwater sensors should be located at least four feet below the minimum water surface elevation normally occurring during winter in areas where river ice develops. This also keeps the sensor away from the majority of floating debris. If this is not possible due to shallow depths, the sensors should be placed at an elevation typically above the water surface elevation during times of ice cover. This requires a significant change in water surface elevation during flooding to submerge the sensors to allow readings during potential scour events.
- If cables intercept the water surface, they should be located inside heavy conduit. Additional protections, i.e. C-channel is also advised, especially if ice flows and/or debris is anticipated.
- All components and conduit lines should be mounted directly to the pier profile as much as possible. This requires much more conduit bends during installation but allows the conduit runs to utilize the stiffness of the pier itself to prevent bending and other damage.

4.2.1 Ancillary Sensors

Ancillary sensors contribute to data collection by providing additional information about local variables that affect scour or other sensor performance. The most useful ancillary sensor is a stage sensor; however, temperature sensors may be needed to increase the accuracy of other sensors. Cameras would also be useful where icing and debris occur. Battery voltage measurement is useful for datalogger troubleshooting and is a standard function on dataloggers.

- Stage sensing can either be pressure sensors (bubble water level sensor or submerged pressure sensor), or distance sensors (sonic or radar). Distance sensors are generally more expensive, but do not require submergence. Bubble water level sensors are slightly better as they only require a tube extending below the water level whereas submerged pressure sensors are most at risk for fouling. With all stage measurements, the elevation of the sensor or bottom of tube with bubble meter must be determined. The range of the stage sensing instrument must be within the range of the river stage and this can preclude some sensors from use or restrict mounting elevations.

- Temperature or other condition sensor may be required for correction of other sensor, i.e. tilt meters if they are affected by temperature. Some smart sensor auto correct for temperature in their readings
- Cameras also would be beneficial if debris and icing conditions are anticipated which could affect scour or damage instrumentation. The image data would need to be reviewed directly by personnel.

4.2.2 Bridge 07011

Bridge 07011 has the following sensors.

- Two ETI Instruments Systems, Inc. wireless float-out sensors and wireless receiver at Pier 5. These sensors were buried using shovels while the water stage was below the local Pier 5 bed elevation. The float-out sensors were buried approximately three feet downstream of the upstream profile of the pier on the same side as the receiver. This gives the receiver better line of sight when the float-outs are scoured out.
- Two ETI Instruments Systems, Inc. tethered buried switches at Pier 5. These sensors were buried using shovels while the water stage was below the local Pier 5 bed elevation. The cables were routed through with 1 ½” and ¾” rigid steel conduit and mounted directed on the upstream profile of the pier to mitigate any potential debris damage.
- An Airmar® SS-510 underwater sonar sensor on Pier 4. The sonar sensor is mounted on the downstream profile of the pier to avoid damage from river debris. The sensor is located above typical water levels and only becomes submerged when the stage exceed 755.3 ft. Local bed elevation and scour is only measured when the sensor is submerged. For reference, typical water surface elevations are ~749 ft and 775 ft is a 100-year event. The typical bed elevation recorded on the downstream side of the pier is 747.5 ft. The sonar sensor was mounted inside a robust mount bolted directly to the pier. Cables were routed through ¾” rigid steel conduit.
- A Campbell Scientific CS475-L Radar Range Sensor is mounted on the downstream superstructure I-beam approximately 20 ft from Pier 4. Typically, a cheaper SR50A-L Sonic Range Sensor would be used; however, the upper range of the sonic range sensor is 32.8 ft and the superstructure to typical water surface is approximately 51 ft. There were no convenient locations for a submerged pressure sensor due to shallow flow depths.
- The dataloggers themselves also measure panel temperature and battery voltage.

4.2.3 Bridge 5900

- Two Airmar® SS-510 underwater sonar sensors. One each mounted on Pier 19 and 20. The sensors are mounted on robust arms mounted on a hinge connected to the upstream profile of the pier. When swung into place, the sensors are both located at 640 ft. The typical water surface elevation is 645 ft. This keeps the sensors under ice and debris. 5”x 6.7# C-channel is used to attach the mount to the pier and to protect cables. The cables are routed in ¾” rigid steel pipe. The

sensors are always submerged and give a continuous data set of local bed elevation.

- A Campbell Scientific CS450-L submersible pressure transducer on Pier 20 is used to measure stage. Typically, an SR50-L sonic range sensor would be used but the range from the superstructure to the typical water surface exceeded the range of the sonic sensor. A submersible pressure transducer was chosen because it is much cheaper than a radar range sensor and the installation already included other sensor mounted below the water surface.
- An ETI Dual Axis Bridge Tilt Sensor is mounted on the top of Pier 20. This sensor was placed at the top of the concrete pier approximately $\frac{1}{4}$ of the pier length from the upstream profile. Tilt is measured in the streamwise direction (tilt up or down stream) of the river and the spanwise direction of the bridge. No conduit was used when running cables. Future installations should carefully examine tilt sensor specifications and sensors should be zeroed or otherwise referenced at the time of installation.
- The dataloggers measure panel temperature and battery voltage.

4.3 Datalogging

Dataloggers used for scour monitoring should be standalone devices that can record time stamped data, convert to meaningful units, and alert or download data to an offsite database for viewing by personnel.

4.3.1 Equipment

Equipment for the data logging system include

- Processor Based Datalogger
- Additional electronics to control or monitor sensors
- Wireless communication modems/receivers and associated antennas
- Solar Panel
- Battery
- Enclosures and associated mounts

4.3.2 Equipment Location

Datalogger equipment location should provide a balance of ease of access for MnDOT personnel, difficulty of access for vandals, and protection from snowplows and other roadway maintenance. In general, this can be achieved by placing all components below the deck/guardrail or high above the roadway deck.

In addition, solar panels must have a clear view of the southern sky and be orientated at $\sim 45^\circ$ from the horizon at Minnesota latitudes. This restricts mounting solar panels to the south side of the bridge or high on the bridge with structures above the road deck. Long cables can be used to connect the solar panel to the datalogger enclosure without conduit.

4.3.3 Programming

Datalogger manuals give example code and an overview of code structure and commands. With the Campbell Scientific datalogger programs, declarations are

performed first and all data collection, processing, controls and communication is performed in an overall scan interval.

Only site specific logic and scan rates (pseudocode) within the scan loops are discussed in this chapter as other technical aspects of programming is covered by suppliers. Scan loops should be fast enough to quickly notify personnel when a hazardous condition has occurred while balancing the power budget of the system. Other logic related items within the scan loop are listed here.

- Processing of sensor data into real world units
- Quality control of sensor data
- Setting alarms
- Power control of high amperage devices
- Communication with other data loggers, emails, and webpages

An internal lithium battery inside of the datalogger backs up the clock, program, and memory for about 3 years if the datalogger is disconnected from an external battery. The internal battery lasts much longer when connected to an external power source.

Dataloggers should be able to restart and hold the program for the entire length of the deployment.

4.3.4 Bridge 07011

4.3.4.1 Pier 4 – Remote Station

The remote station includes the following items.

- Campbell Scientific CR800 datalogger
- Campbell Scientific RF401 spread spectrum radio and antenna
- 12 amp-hour, 12 volt battery
- 20 watt solar panel
- Mounting hardware

The datalogger enclosure was mounted on the north barrier/guardrail of Bridge 07011. This location was directly above the sonar on the downstream side of the bridge. This datalogger location was not ideal for the solar panel since the panel must face south and this faces the roadway. The solar panel was instead mounted on the south side of the bridge as shown in Figure 20. The cable to the solar panel was routed on top of the pier with no conduit.



Figure 20: Bridge 07011 - Pier 4 Solar Panel

4.3.4.2 Pier 5 – Master Station

The master station includes the following items

- Campbell Scientific CR800 datalogger
- Campbell Scientific RF401 spread spectrum radio and antenna
- Float-out receiver/decoder electronics and antenna
- RavenXTV digital cellular modem for Verizon and antenna
- 12 amp-hour, 12 volt battery upgraded to 30 amp-hour battery
- 30 watt solar panel
- Mounting hardware

The datalogger enclosure and solar panel were mounted on the south barrier/guard rail directly above the tethered float-out sensor and wireless float-out devices as shown in Figure 21. This location allows a clear view of the south and protects the solar panel and datalogger from snow plows and other road maintenance and is difficult to access for vandals.



Figure 21: Bridge 07011 – Pier 5 Datalogger and Solar Panel

4.3.5 Bridge 5900

4.3.5.1 Pier 19 – Remote Station

The remote station includes the following items.

- Campbell Scientific CR800 datalogger
- Campbell Scientific RF401 spread spectrum radio and antenna
- 12 amp-hour, 12 volt battery
- 20 watt solar panel
- Mounting hardware

The datalogger enclosure was mounted directly to the pier on the north side of the bridge. The datalogger is approximately two feet below the top of the pier as shown in Figure 3. This location is directly above the sonar sensor at the base of the pier. Access is possible, but dangerous, without the use of an under bridge inspection truck (“snooper”). Access without a snooper requires fall protection. Access with a boom truck is likely not possible. The datalogger could have been mounted slightly higher to aid access for personnel with little increased risk of vandalism.

This datalogger location was not ideal for the solar panel since the panel must face south. This would have both faced the roadway and been in the shadow of the bridge truss structure. The solar panel was instead mounted at the top of the truss structure on the north side of the bridge. This mitigated the shadowing issues as well as protected it from road debris. The solar panel was installed at the highest location possible for a boom truck. The cable to the solar panel was loosely routed along the bridge truss beams with beam clamps. Alternatively, the solar panel could have been routed on the south side of the pier below the road deck with the cable routed along the top of the pier.

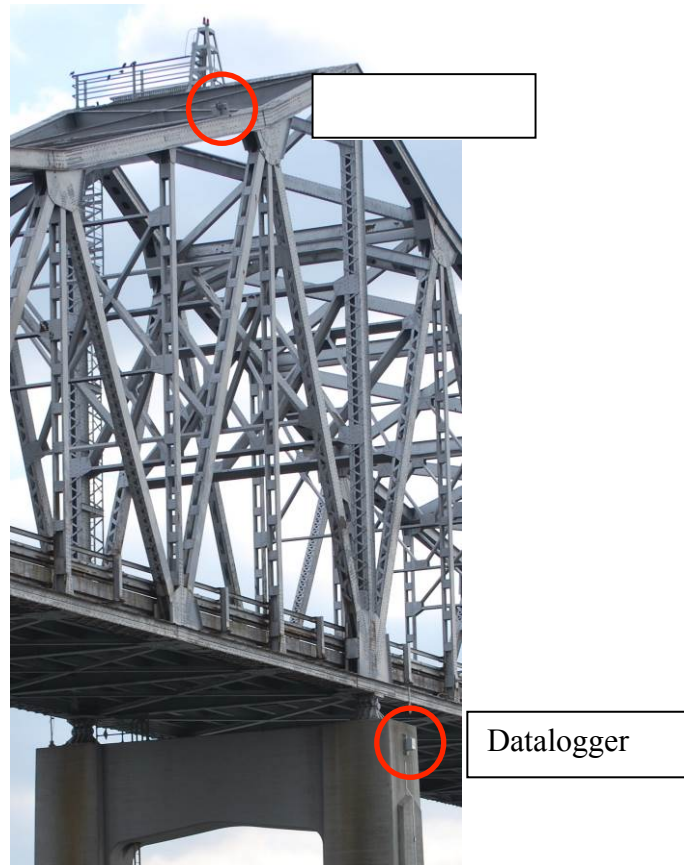

Figure 22: Bridge 5900 - Pier 19 Datalogger and Solar Panel

4.3.5.2 Pier 20 – Master Station

The master station includes the following items.

- Campbell Scientific CR800 datalogger
- Campbell Scientific RF401 spread spectrum radio and antenna
- RavenXTV digital cellular modem for Verizon and antenna
- 12 amp-hour, 12 volt battery upgraded to 30 amp-hour battery
- Digital relay for turning on underwater sonar
- 20 watt solar panel
- Mounting hardware

The datalogger enclosure was mounted directly to the pier on the north side of the bridge. The datalogger is approximately two feet below the top of the pier as shown in Figure 4. This location is directly above the sonar sensor at the base of the pier. Access is possible, but dangerous, without the use of an under bridge inspection truck (snooper). Access without a snooper requires fall protection. Access with a boom truck is likely not possible. The datalogger could have been mounted slightly higher to aid access for personnel with little increased risk of vandalism.

This datalogger location was not ideal for the solar panel since the panel must face south and this direction the roadway. The solar panel was instead mounted at the top of the truss structure on the north side of the bridge. This mitigated the shadowing issues as well

as protected it from road debris. The cable to the solar panel was loosely routed along the bridge truss beams with beam clamps. Alternatively, the solar panel could have been routed on the south side of the pier below the bridge deck with the cable routed along the top of the pier.

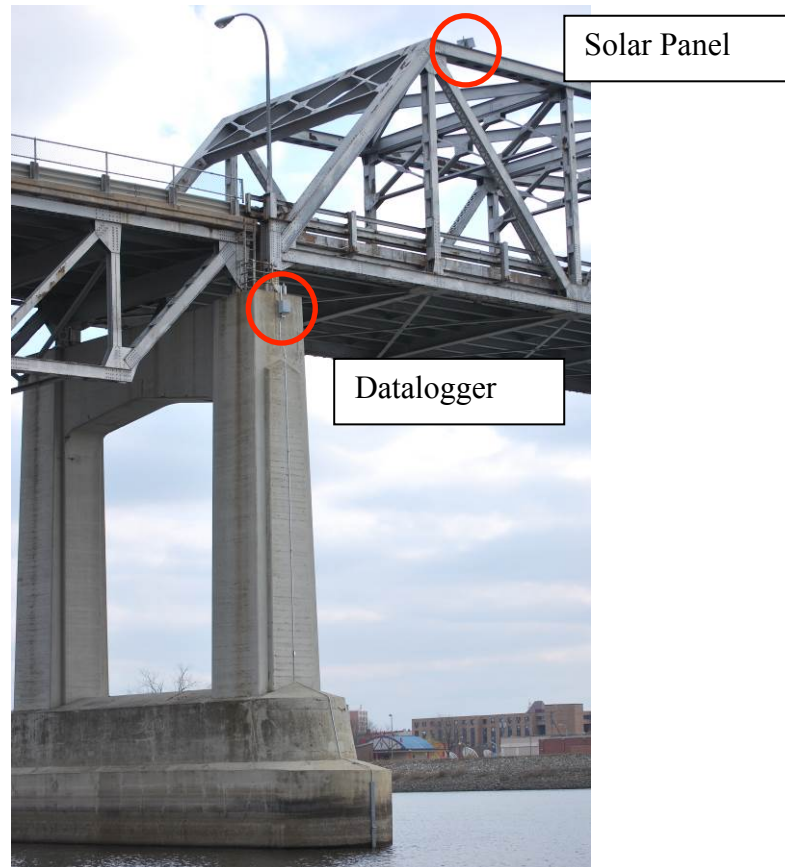

Figure 23: Bridge 5900 - Pier 20 Datalogger and Solar Panel

4.4 Data Collection, Alerts, and Visualization

The end use of the data is important to the type of data storage required. Dataloggers are fully capable of operating standalone to save years of data at a record rate of once every 30 minutes and determining and notifying appropriate personnel if scour activity is occurring. However, if the data requires backup, longer term data sets, or visualization is preferred, an offsite database management tool may be required.

4.4.1 Onsite data collection and alerts

The dataloggers are fully capable of collecting long-term data alerts and sending the appropriate alerts to personnel through the cellular modem at each datalogging station. If needed, data can be manually, but remotely downloaded via Campbell Scientific's Loggernet or similar software. The system can also host a webpage and be reprogrammed remotely.

4.4.2 Offsite (Long-term) Data Collection

If the data requires automated back-ups to ensure up-to-date data collection or data visualization, automated data downloads can set up via Campbell Scientifics Loggernet

or similar software and saved to a server or computer. This requires a computer constantly running Loggernet and synchronized times for data download at the offsite computer and the cellular modem powered up at the bridge site.

4.4.3 Data Management and Visualization

Data visualization provides a graphical view of the data sets to quickly understand data and review trends. Although charts can be made in Excel or other charting software, a web based tool to quickly make plots of various parts of the data set are extremely useful for understanding current readings and troubleshooting. The data management system should provide the data in an easy to search database, be easy to access, have alarm service, and provide quick plotting of any data. The data for the database management tool is taken from the offsite data collection files.

4.4.4 Bridges 07011 and 5900

Both bridge systems have onsite data collection and warnings, offsite data collection, and data management and visualization tools for recording and acting upon data.

The dataloggers were designed to be standalone. This includes a webpage hosted on the master station, powering on the modem in response to scour activity and at designated intervals so the datalogger can be accessed and composing email alerts with real-time data for scour activity alerts or for weekly updates. All of these items are performed within the execution code on the master station datalogger. At data collection rate of one point every 30 minutes, the datalogger can save data for about 3 years before the data is overwritten. Campbell Scientific's Loggernet software is used to remotely reprogram the datalogger or download data. The remote station is also remotely reprogrammed via the master station cellular model and wireless radio link.

The offsite data collection uses a computer constantly running Campbell Scientific's Loggernet software to connect to the master datalogger via a cellular modem with a static IP address. This requires that datalogger have the modem on when Loggernet accesses the master station. Any new data collected by the mast station datalogger is appended to the data file located on a server. The offsite data files created each contain a year of data.

The data management tool used is Vista Data Vision. The programs has three main subprograms that convert the data to MySQL database, set up plotting templates, and handle the online access of data.

1. db.robot.c imports the data from the comma separated file that Campbell Scientific and Loggernet save on the off site server. Once directed to this file, db.robot.c automatically imports all new data into the database. db.robot.c also is used to set up alarms and contact mail and cellular information.
2. db.data.browser is used to set up the template graphs, organize into groups, and the creation of additional variables as a function of collected data.
3. db.web.browser handles the online access of the data. This includes tabular data and graphs, user name and password setup and access, and additional site information pages.

5 Testing Event

Scour monitoring equipment operations was investigated by executing a testing event. This testing event is primarily related to float-out devices because the historical data from the sonar and stage sensors provide enough information to verify good operation. In addition, some stage and sonar measurements caused automated email alerts to be sent to the appropriate personnel. This further verified their operation and the alert system.

5.1 Float-Out Devices

Float-out devices are buried at the upstream base of Pier 5 on Bridge 07011. The wireless float-out devices have internal switches which connect power to the transmitter when the counterweighted float-out tilts in a certain direction after it is unburied by scour. The transmitter is not operational until the float-out is unburied and tilts in a prescribed orientation. The receiver, located in the datalogger enclosure, is always on and constantly listening for a signal from the float-out transmitter.

Unlike other scour sensors, wireless float-out devices have no way to check that they are operating correctly unless a float-out is unburied and activated to simulate a scour event. An initial testing event was performed on 9/12/2013 and the scour monitoring system failed to detect the activated float-out device. During maintenance on 4/2/2014, a second testing event was performed. The scour monitoring system detected the float-out device, but alerts were not properly set to alert personnel. A third testing event performed on 5/13/2014 activated a float-out near its buried location. The system successfully detected the float-out device and sent an automated email to the appropriate personnel.

5.1.1 9/12/2013 Testing Event

The wireless float-out devices were dug up on 9/12/2013 to simulate a scour event. The float-out devices were quickly found 7' 6" from the river side of the pier as indicated in the as-built drawings from Task 3. One float-out was buried directly above the other. The top float-out was found 20" below grade and the bottom float-out was found 60" below grade.

The initial plan was to unbury and activate only the top float-out. The expected result was to receive an automatic email from the alert system. This would complete the testing plan. However, after activating the float-out device, no automated email alert was received. The potential causes of this failure to send an alert are listed here:

1. Wireless transmitter not operating (likely due to bad batteries)
2. Wireless receiver not operating correctly
3. Datalogger software not operating correctly
4. Alert system not operating correctly

The bottom float-out was unburied and activated, but an alert was still not received. The datalogger then was directly contacted via IP address and was found to be working properly. To check wireless transmitter operation, one of the float-out devices was cut open. LEDs on the transmitter board showed that the transmitter was activated and the battery and tilt switch were working. The only potential issue left was that the wireless receiver was not operating correctly. The receiver, located in the Master Station enclosure, could not be accessed on that day because MnDOT bridge personnel were not

on site. The bottom float-out device was reburied 55” below grade and the disassembled float-out was mailed back to ETI for reassembly and could be used for retesting once the receiver issue was resolved.

Follow-up conversations with ETI indicated that the wireless receiver does not report float-outs after a particular transmitter signal has been received three times. This can take less than 20 seconds after the transmitter is activated. The receiver must be reset by pressing the reset button on the receiver or powering down the receiver inside of the Master Station. Removing the 12 volt supply power from the datalogger should also reset the receiver because the datalogger provides power to the receiver.

During installation, the float-out receiver may have been activated and transmitted three signals to the receiver. The receiver was not reset after installation of the float-out. This was determined to be the most likely reason the receiver did not operate correctly during the 9/12/2013 testing event.



Figure 24: Pier 5 at Installation (10/25/2011) and Testing Event (9/12/2013)

5.1.2 4/2/2014 Testing Event

A second testing event was planned during required scour system maintenance on 4/2/2014. This maintenance activity was the replacement of a dead battery. After replacing the battery, the reassembled float-out device not replaced during the previous testing event was activated on the bridge deck while a MnDOT electrical technician viewed the receiver LEDs inside of the Master Station. Access to the Master Station datalogger is shown in Figure 25. As described by ETI, the LED on the receiver blinked

three times indicating that the activated float-out communicated with the receiver three times at which point the receiver ignored the transmitter from that specific float-out. The receiver was reset and the float-out was again activated. The transmitter again reported the activated float-out to the receiver and ignored the activated float-out after three successful communications. The receiver was not reset again. The buried float-out can still be sensed by the system as that float-out has a different identifier. During the next scheduled communication with the SAFL database, the "FOArray(1)" variable was updated to "1" triggering an alert condition in the Vista Data Vision software. This change can be seen in the vdv.safl.umn.edu page. However, no personnel emails were affiliated with this alert so no automated emails were sent out. This error was due to the two levels of warnings in the alert system. These levels are "High" and "High High" in the Vista Data Vision software. The "High" level was set to 0.1 and the "High High" level was set to 1. Personnel emails were linked to the "High" level warning and no personnel emails were associated with the "High High" level. The Vista Data Vision system only activated the "High High" alert when the float-out was activated. The alert system has been changed to alert both the district and the scour monitoring administrators any time the FOArray(x) variables go above a value of "0".

The float-out device used for testing was not reburied and was tested from the deck only.

The FOArray(1) variable returned back to 0 on 4/3/2014. This was not reset by ETI or SAFL and was likely due to the charging issue that occurred immediately after the maintenance. At this time, a datalogger reboot likely caused the program to restart resetting this variable. However, the receiver was still likely ignoring Float-Out 1 unless the receiver also lost power when the datalogger was rebooted.



14 Maintenance and

A third testing event was performed on 5/13/2014 with a float-out device to ensure that the receiver, datalogger, and automated alert system were all fully functional. The float-out device unburied during the 9/12/2013 testing event was activated under the bridge. This location under the bridge closely simulates the location where the float-out would become active if removed by scour.

After activating the float-out device, the datalogger powered up the cellular modem as specified by the programming when a float-out is detected. The datalogger was directly accessed via IP address and the FOArray(1) had been changed to "1". At the next scheduled data download, an automatic email was sent to the scour monitoring administration and local district MnDOT personnel.

The float-out was not reburied at this time.



Figure 26: Pier 5 during 5/13/2014 Testing Event

5.1.4 Float-out Operation Review

The 4/2/2014 testing event showed that the receiver was operating correctly. This suggests that the float-out transmitter had been activated at installation and immediately was read three times by the receiver and ignored the reactivated float-out on 9/12/2013. However, the power outage on the Master Station from 11/28/2011 to 12/13/2011 and associated battery replacement on 12/13/2011 should have caused the receiver to reset.

Furthermore, the Master Station was powered up after the wireless float-out devices were buried during installation which also should have reset the receiver and not allowed additional received signals from the buried float-outs. The float-outs were buried on 10/24/2011 after activating Float-Out 1 which was successfully read by the datalogger at this time. The datalogger was turned off and not restarted until final electrical connections were made on 10/28/2011 and the program restarted at 11:45 AM.

A potential explanation for this issue is that the range between the wireless float-out and the receiver is too great for communication. The receiver antenna used has the worst range in the vertical direction and this is the general direction the wireless float-outs were tested in on the 9/12/2013 testing event. The 4/2/2014 testing event successfully triggered an alert, but the float-out device was activated from the deck within a few feet of the Master Station. However, the 5/13/2014 testing event found that range was not an issue

as the float-out was activated from a realistic distance and direction from the receiver antenna. The 5/13/2014 event reinforces the argument that the receiver had previously communicated with both float-outs at installation. It is unclear how the receiver kept these communications with the transmitters saved in memory when there were numerous times when the receiver should have lost power.

Three readings from the transmitter to the receiver constitute the limit of readings and not three readings from the receiver to the datalogger. This means that it is possible for the datalogger to never receive the information that a float-out has been activated if the datalogger is off and the receiver is on and receives information from the transmitter.

5.2 Successful Alerts from Non-Testing Events

There have been a number of successful alerts not affiliated with the testing since the scour monitoring equipment has been deployed. Some of these are due to real life events and some of them are caused by false readings or programming issues. These are briefly discussed here as they illustrate successful automated notifications to the appropriate personnel via email.

5.2.1 Bridge 5900

The Scour Action Plan specifies that scour monitoring should occur on Bridge 5900 at a stage corresponding to a 5-year event, or 653.5 ft. An automated alert was successfully sent to scour monitoring administration and the local MnDOT district on 4/3/2014, stating that the stage had reached the 5-year event level.

Software reprogramming occurring on 4/9/2014 led to numerous variables, including local bed elevations, to exceed specification and alerts were sent to both scour monitoring administration and the local MnDOT district. There were no real bed elevation events extreme enough to send any messages to any personnel.

There were numerous alerts due to tilt, battery warnings, and stale data. Stale data is due to the datalogger not being able to respond to automated scheduled downloads. These were all sent to scour monitoring administration and very few, if any, were extreme enough to notify the local MnDOT district. Only the tilt is set to alert the local district if it is extreme enough.

5.2.2 Bridge 07011

There were no real hydraulic events that triggered automated email messages to personnel. However, during 4/2/2014 maintenance to replace a bad battery, numerous false readings triggered alerts to both scour monitoring administration and local MnDOT district personnel. These alerts included low bed elevation and low stage to district MnDOT personnel.

There were numerous alerts due to battery warnings and stale data. These were sent only to scour monitoring administration.

The tethered buried switches have not been fully tested with the exception of during installation. Prior to connecting the tethered buried switches to the Master Station, the readings were “3” indicating that they were disconnected. “1” indicates that the tethered buried switch is buried and oriented vertically, “2” indicates that the tethered buried

switch has been unburied and is orientated horizontally, and “3” indicates that the switch is no longer attached to the data logger.

6 Yearly Maintenance and Administration

Results from yearly reporting on the administration and maintenance of the scour monitors on Bridge 5900 and Bridge 07011 are discussed here.

Significant incidents which occurred are thoroughly reviewed and recommended alert conditions are listed.

6.1 Bridge 5900

The current data file started collecting on 11/2/2011. The headers of the file changed requiring a new data file.

Data from 11/2/2011 to 11/22/2011 should be disregarded as there was ongoing reprogramming of the system to remotely resolve wiring issues on the Pier 5 Master Station.

There were no major data issues on Bridge 5900 with the data collection from 6/1/2012 to 6/30/2013.

ETI performed some programming modifications on 8/9/2012 to resolve some issues noted in the 2011-2012 yearly administration report.

These modifications included the following.

1. Stage reference (sensor elevation) was changed from 640 to 641.25 ft. The actual location of the stage sensor was located at 640.75 ft instead of 640 in the NGVD 1929 datum. Secondly, the local USACE stage measurement is reported in the MSL 1912 datum, which is 0.5 ft above the NGVD datum. Changing the stage reference from 640 to 641.25 means that the scour monitoring system uses the same datum as local USACE stage measurements.
2. Spikes are removed in software programming. If bed elevation changes by more than two feet between sonar readings (every 30 minutes), the reported bed elevation is one foot different from the previous reading in the direction of the change. This removes major spikes in bed elevation.

During the final year of administration, there were two technical issues with the Bridge 5900 deployment and no major scour degradation at either of the monitored piers.

The technical issues involved a software problem, likely due to communication issues, and a battery which had lost storage capacity and required replacement. Scour at both bridges piers did not exceed more than one foot below the footing until a Spring 2014 runoff event. There were two peaks that exceeded the 5-year threshold for monitoring as outline in the Scour Action Plan. Local bed elevation at Pier 19 eroded to 616.4 ft, 5.4 ft below the footing, and then quickly aggraded back to typical local bed elevations.

6.1.1 Stage

Figure 27, Figure 28, and Figure 29 show the discharge and stage from a local USACE monitoring station and from the scour monitoring equipment. The stage sensor on the Bridge 5900 system is a pressure sensor located a few inches from the front edge of the Pier 19. The USACE gauge is located on the Minnesota side of the river approximately 700 ft downstream of the bridge and uses MSL 1912 as a datum.

Prior to the 8/9/2012 reprogramming, the scour monitor recorded stages 1.25 ft below the reported USACE levels at low flows. After the reprogramming, the stage measurements are in excellent agreement at low flows. The 1.25 ft deviation is due to the following two factors.

- The programmed sensor elevation is 640 and the actual is 640.75 ft based on NGVD 1929.
- Bridge 5900 is likely built with the NGVD 1929 datum and USACE report with the MSL 1912 datum. The 1929 datum is 0.5 ft below the 1912 datum near Winona.

The system was reprogrammed with a stage sensor elevation of 641.25 ft to use the MSL 1912 datum.

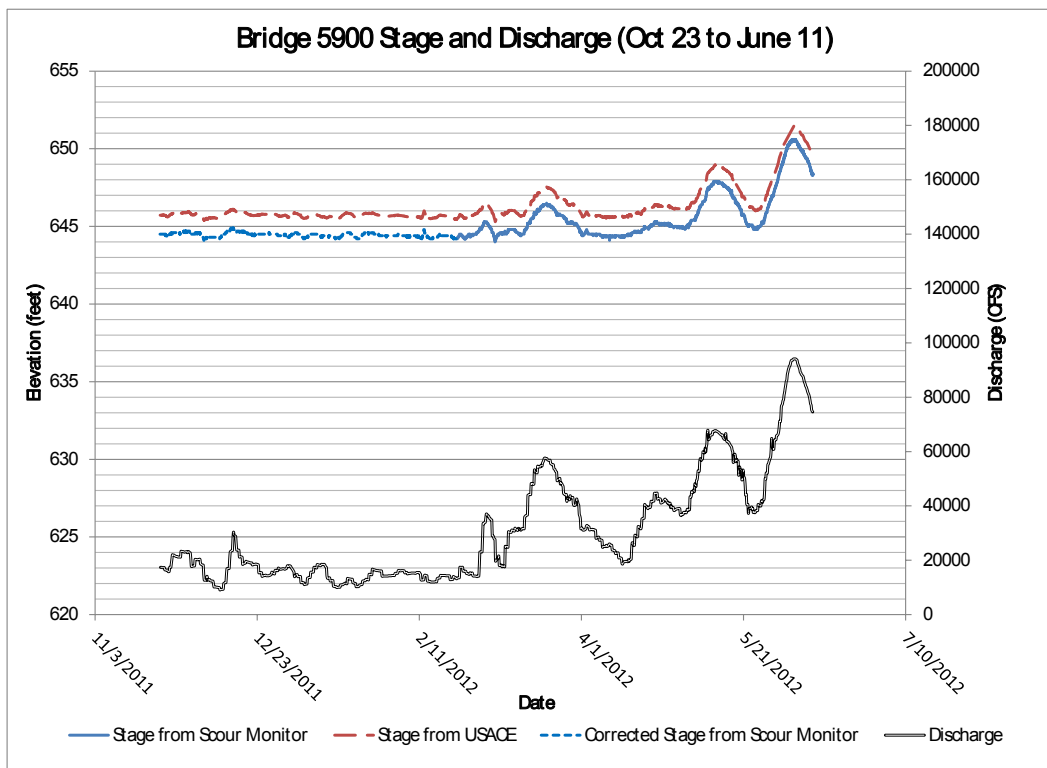

Figure 27: Bridge 5900 Stage and Discharge - Administration 2011-2012

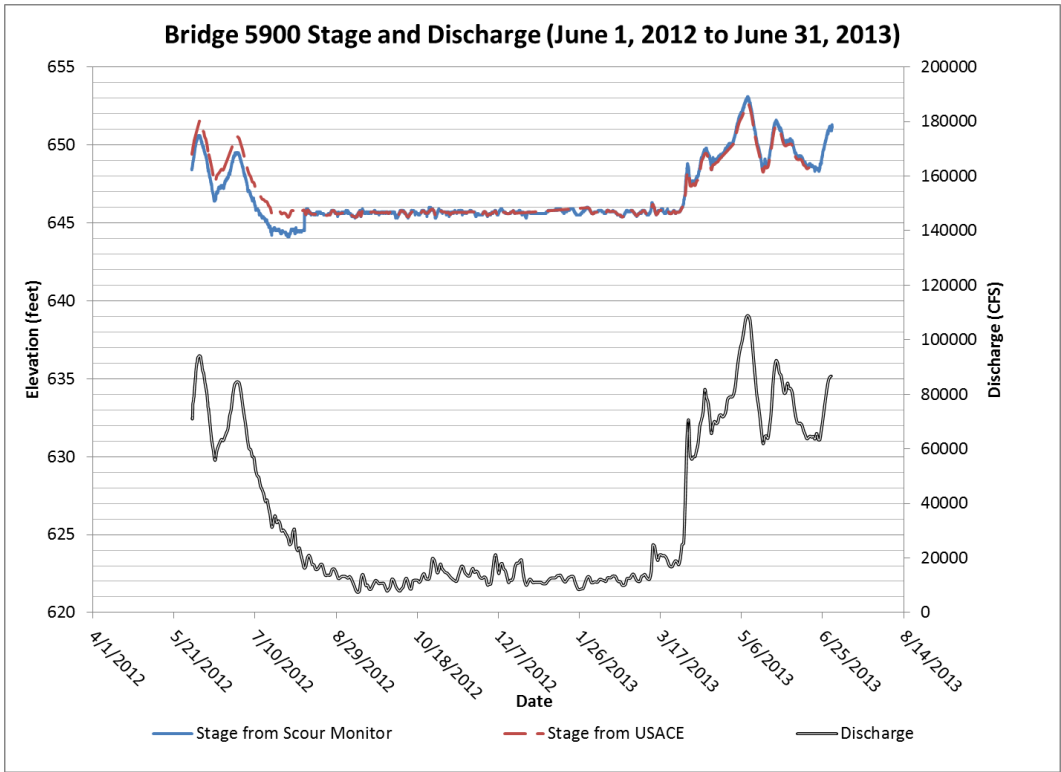

Figure 28: Bridge 5900 Stage and Discharge - Administration 2012-2013

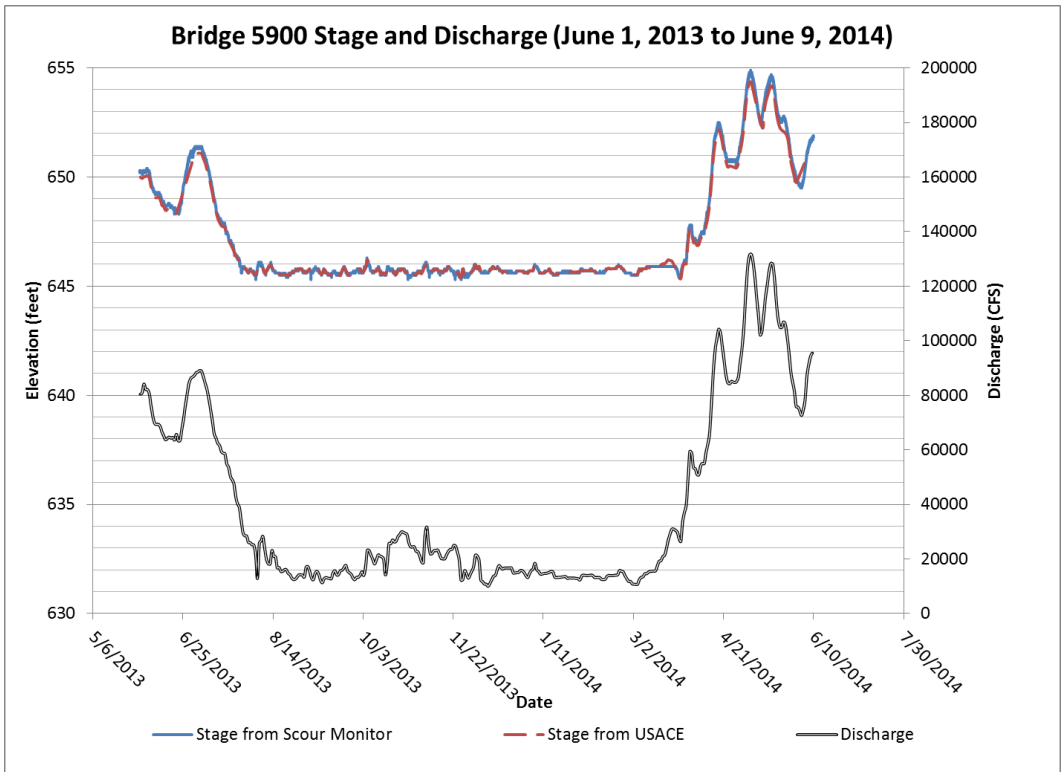

Figure 29: Bridge 5900 Stage and Discharge - Administration 2013-2014

Figure 30, Figure 31, and Figure 32 show the stage difference between the stages recorded by the scour monitoring equipment and the USACE stage sensor and also shows

the river discharge. At higher discharges, the stage deviates because of slightly higher water surface elevations at the upstream profile of the pier where the stage measurement is taken.

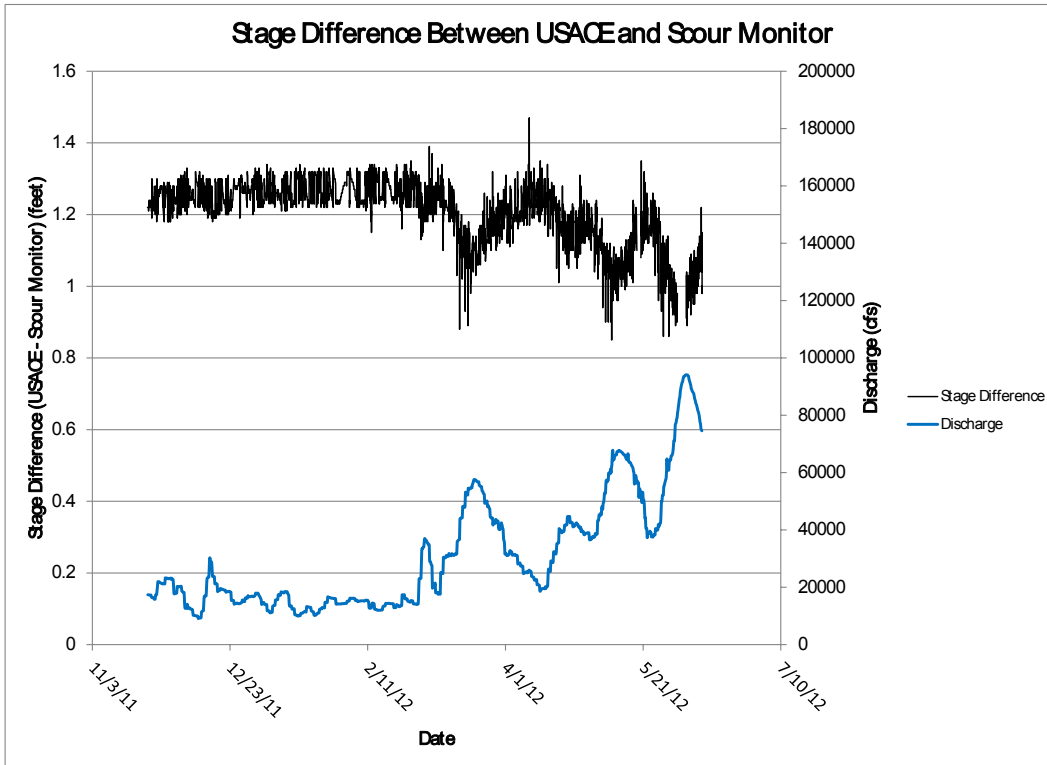

Figure 30: Bridge 5900 Stage Difference between USACE and Scour Monitor - Administration 2011-2012

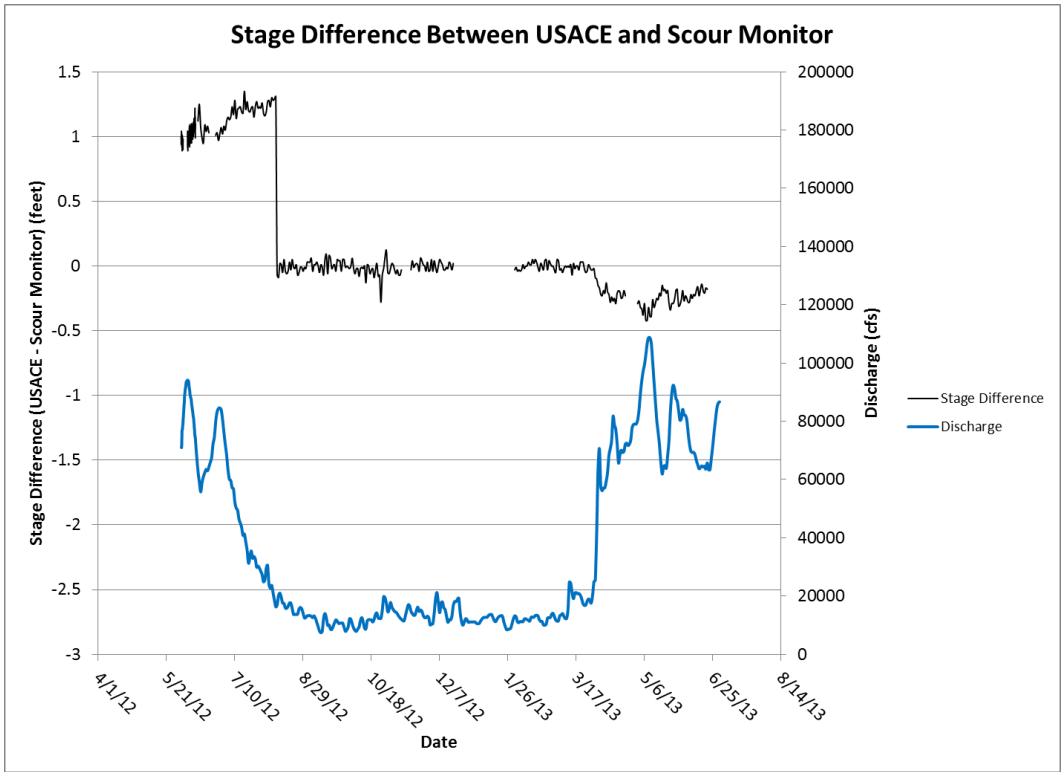

Figure 31: Bridge 5900 Stage Difference between USACE and Scour Monitor - Administration 2012-2013

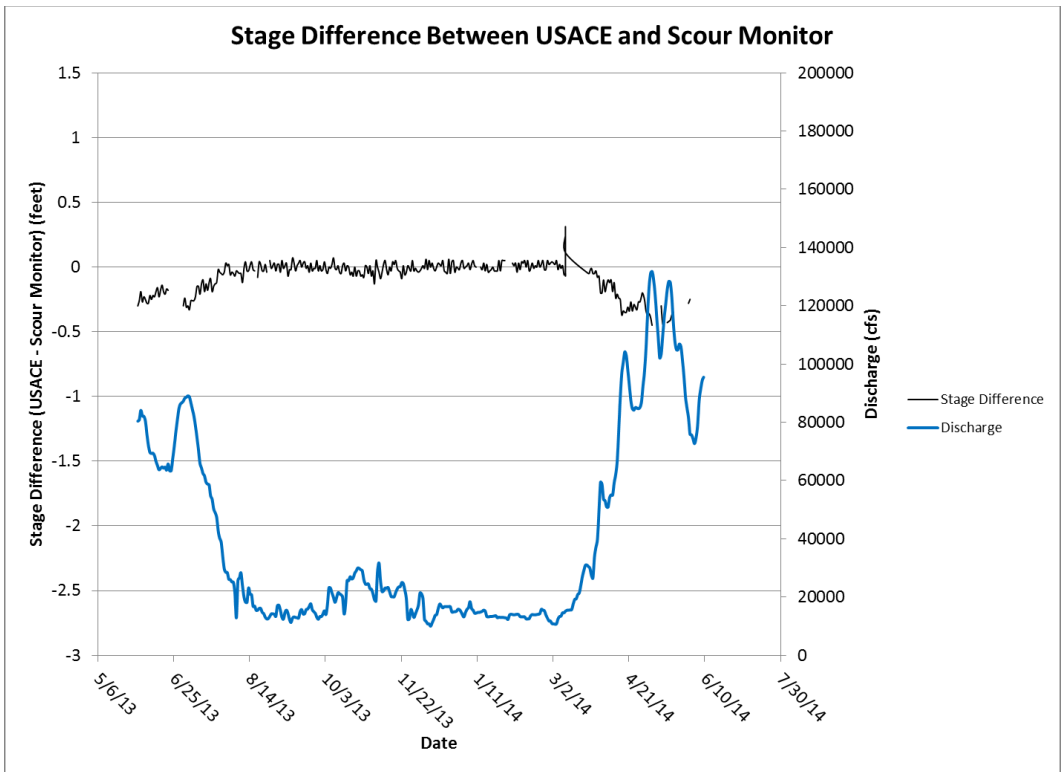

Figure 32: Bridge 5900 Stage Difference between USACE and Scour Monitor - Administration 2013-2014

Figure 33 shows the upstream view from the USACE gage and Bridge 5900.

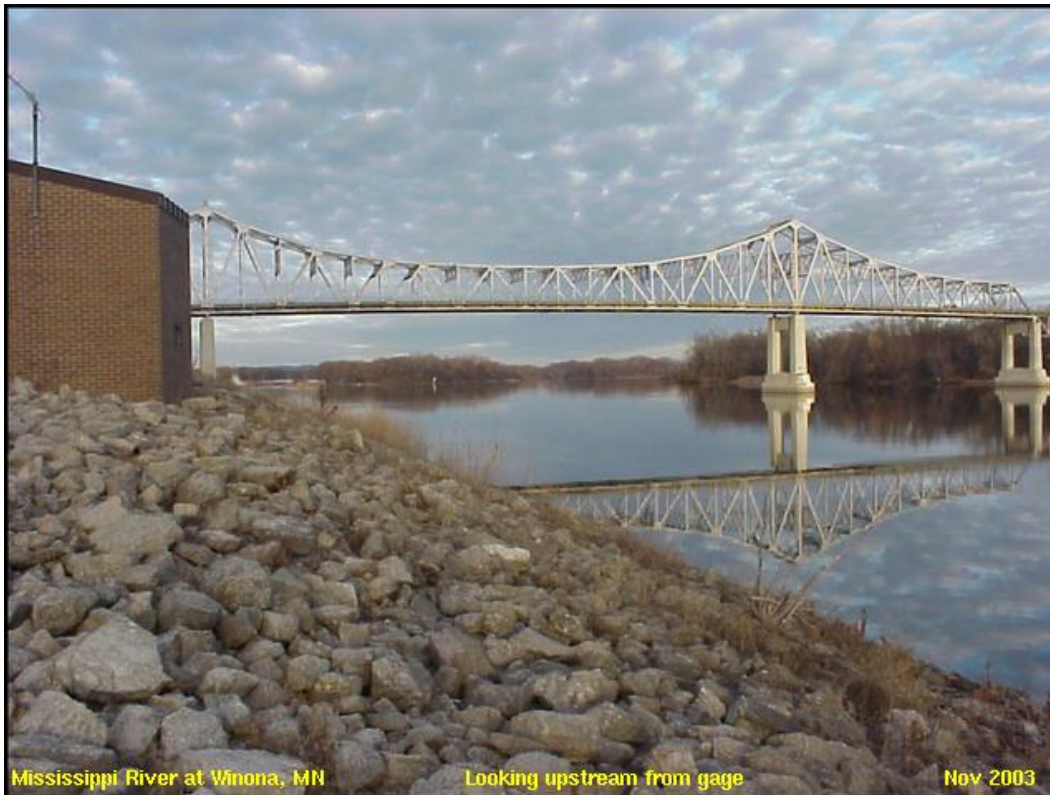

Figure 33: Upstream View from USACE Control Points 6 at Winona, MN

The data for the USACE gage is taken from

<http://www.mvp-wc.usace.army.mil/projects/Lock6.shtml>

Data from Control Point 6 (CP6) is used for this project.

6.1.2 Pier 19 Scour

Figure 34 shows the scour around Pier 19 from Oct 23 to June 11. There are a few false spikes in the dataset along with some significant scour events that occurred.

Figure 35 shows the scour around Pier 19 from 6/1/2012 to 6/30/2013. The spikes in the data set abruptly stop after the 8/9/2012 reprogramming. The resulting bed elevation shows a smoother bed elevation time series dataset, but the artifacts due to the maximum inter sample bed elevation change are also noticeable.

Figure 36 shows the scour around Pier 19 from 6/1/2013 to 6/9/2014. The bed elevation stayed around the elevation of the bottom of the footing with the exception of the Spring 2014 runoff event. The initial Spring hydrograph caused aggradation which was quickly eroded during the rising limb of the first peak which occurred on 4/18/2014. The local bed elevation eroded to the elevation of the bottom of the footing. The peaks occurring on 5/6/2014 and 5/18/2014 generally caused degradation during the rising limb and aggradation during the falling limb. The lowest local bed elevation was occurred during the slightly lower discharge 5/18/2014 peak. This elevation was 616.5 ft and was the lowest recorded local bed elevation during the 3-year monitoring period.

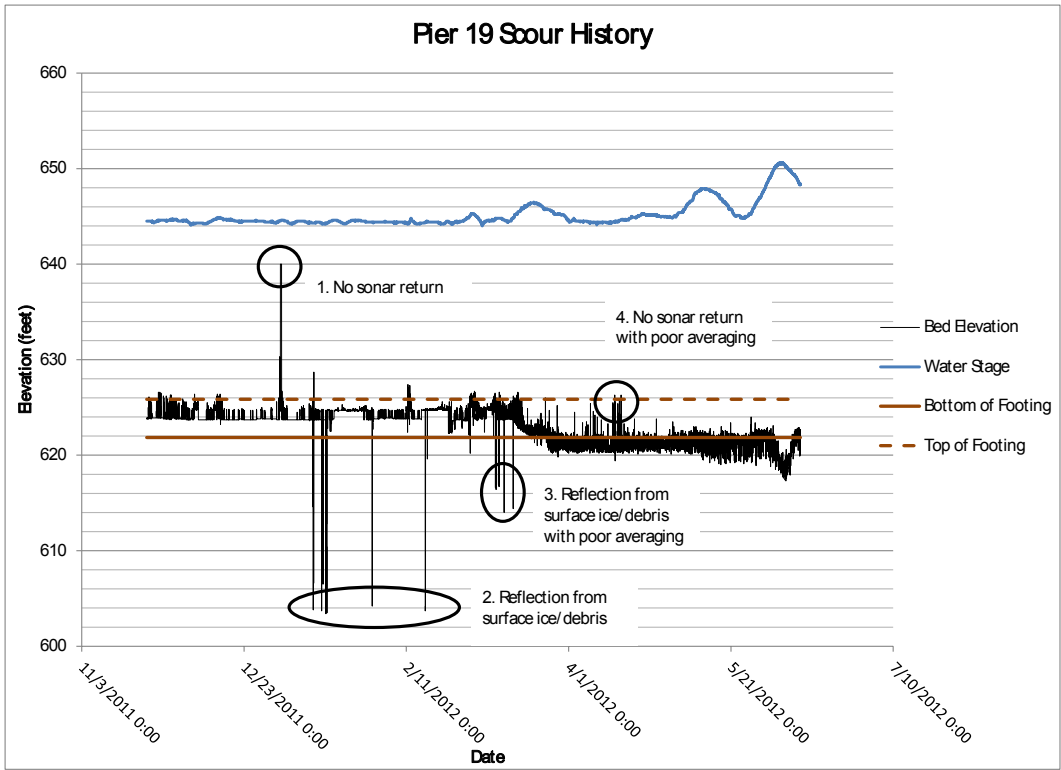

Figure 34: Pier 19 Scour History - Administration 2011-2012

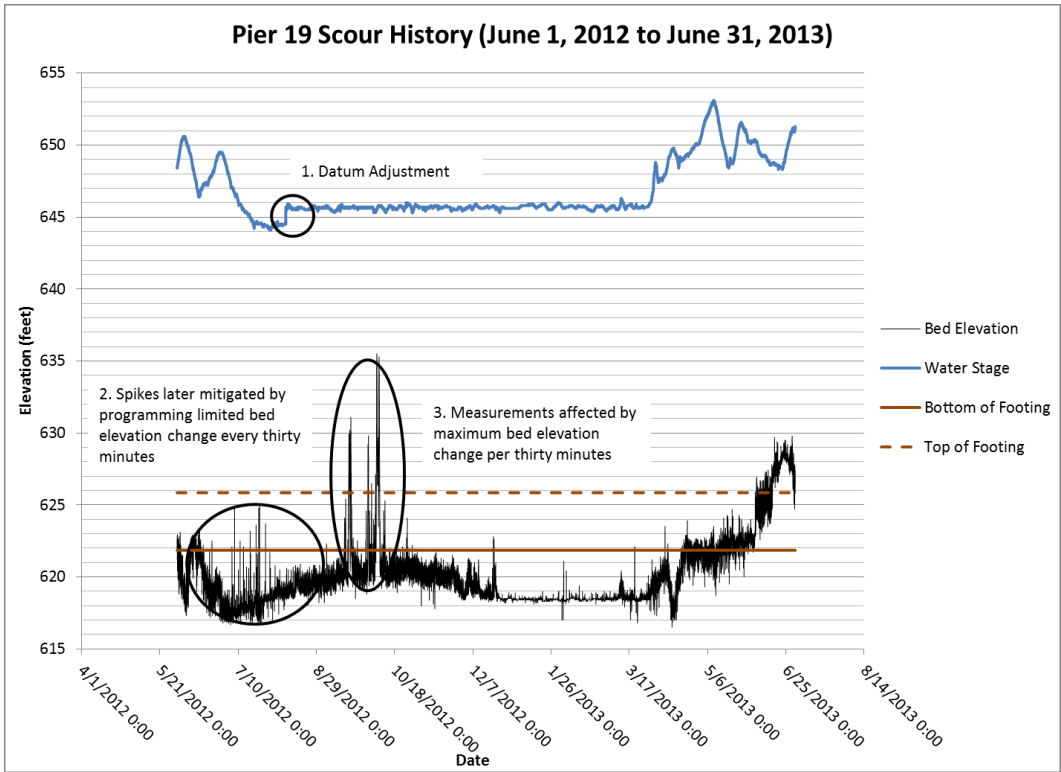

Figure 35: Pier 19 Scour History - Administration 2012-2013

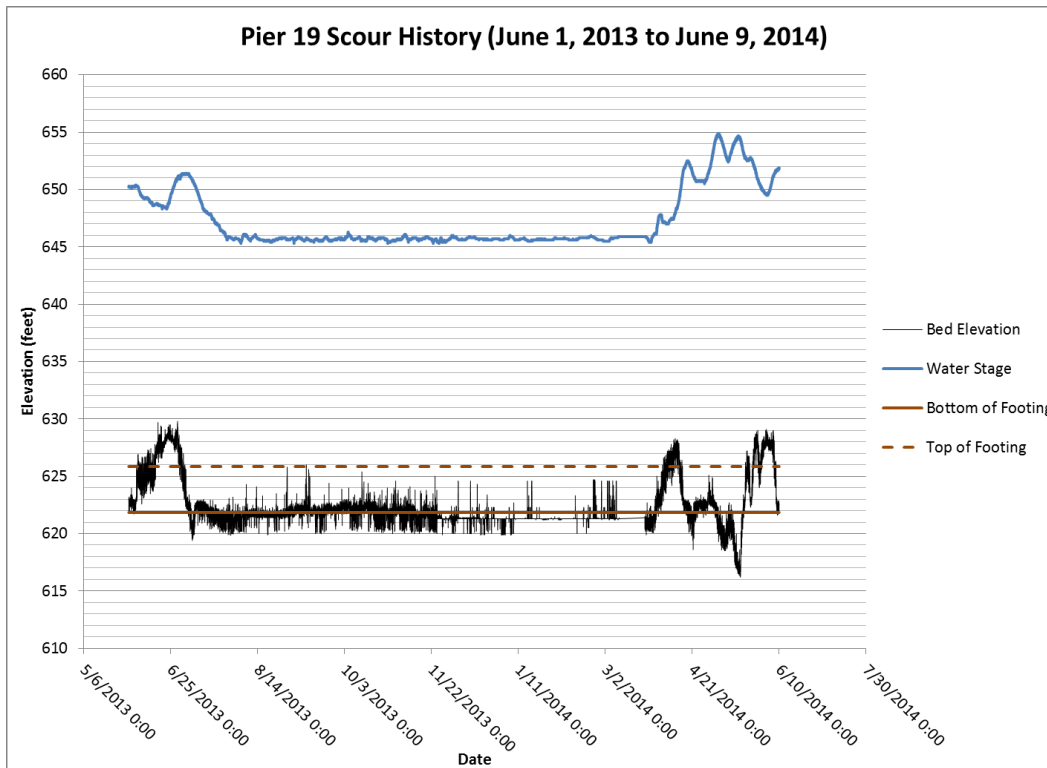

Figure 36: Pier 19 Scour History - Administration 2013-2014

6.1.2.1 False Readings

The major false readings during 2011-2012 administration, highlighted as 1 through 4 in Figure 34 are due to one of the following three items.

- No sonar returns,
- Surface debris or ice reflecting a false reading,
- One of the previous two averaged with correct readings.

The system uses the following averaging scheme. Every thirty minutes, ten readings are taken quickly in series, the minimum and maximum are discarded and the remaining eight are averaged and this value is reported.

The spike on 1/3/2012, indicated as circle 1 on the figure, was due to no sonar return. The reading reported by the sonar was 0 and the elevation of the instrument is 640 ft.

The spikes from 1/13/2012 to 2/16/2012 that reach to about 604 ft are likely due to reflections from the ice or debris on the water surface. These are indicated by circle 2 on the figure. The expected sonar return time is the time it takes to go from the sonar, bounce off the bed, and come back to the sonar. The readings indicated by 2 is the amount of time the sonar pulse take to go from the sonar, bounce off the bed, bounce off the material at the surface, bounce off the bed again, and then come back to the sonar. The excess distance as measured by the device is the distance from the bed to the material at the water surface. For all of these spikes, the excess distance read by the sonar device is about 20 ft, which is the same as the elevation difference between the water surface elevation and the bed elevation. This correlates well with reported ice conditions

occurring near the bridge from 1/15 to 1/20 from Larry Waletzki, the bridge department supervisor near Winona, Mn.

The spikes from 3/9/2012 to 3/12/2012, indicated by 3 in the figure, are likely due to reflections from surface debris affecting some, but not all of the 8 readings that are used to calculate the reported bed elevation. From the magnitude of the spikes, about 3 to 4 of the 8 samples appears to be surface reflected signals.

The spikes from 4/14/2012 to 4/16/2012, indicated by 4 in the figure, are likely due to no sonar returns on some, but not all of the 8 readings that are used to calculate the reported bed elevation. From the magnitude of the spikes, about 2 of the 8 samples appear to have been samples with no sonar return. Another potential cause of these spikes is the sonar return pinging off the top of the pier footing. The readings are very close to this elevation.

During 2012-2013 administration, the majority of false readings are not noticeable due to the limited change in bed elevation between samples. The spikes reported in the administration report from the previous year are no longer visible.

The spikes from 7/6/2012 to 8/5/2012, indicated by circle 2 in Figure 35, are likely due to no sonar returns on some, but not all of the eight readings that are used to calculate the reported bed elevation. From the magnitude of the spikes, about one to three of the eight samples averaged appear to have been samples with no sonar return. The spikes were mitigated by the 8/9/2012 reprogramming.

The spikes from 9/16/2012 to 10/11/2012, indicated by circle 3 in the Figure 35, are due to an abrupt, but constant change in elevation as read by the sonar. These readings are heavily affected by limited maximum change in bed elevation allowed in reprogramming. This is evident by the step change of one foot every sample period over the course of about ten sample periods, or five hours for the largest spike. The cause of these spikes is unknown due to the fact that reprogramming limiting the change in bed elevation between samples.

During 2013-2014 administration, the spikes reported in the administration report from the previous year are no longer visible.

The current programming which only reports a maximum bed elevation change of one foot when consecutive readings change by more than two feet mitigates large spikes well. There are some minor artifacts due to this programming in the aggradation from the 5/18/2014 peak, but these are difficult to find in the dataset.

6.1.2.2 Actual Scour Events

With the exception of the false readings listed in the previous sections, the data shows real scouring events around Pier 19 of Bridge 5900.

During 2011-2012 administration, the first event is the long term degradation event that occurred from 3/13/2012 to 3/27/2012. This event lowered the local bed four feet from 625 ft to 621 ft. This was caused by the spring runoff which peaked at 56,000 cfs.

In the second major live bed scour event which occurred from 5/31/2012 to 6/10/2012, the bed elevation went from 622 ft down to 619 ft and then refilled back to 622 ft.

It is interesting to note that there seems to be a discontinuity in the progression of scour when the bed elevation gets close to the bottom of the footing where the piling begins to

be exposed. The 3/13/2012 event, which had a peak discharge of 56,000 cfs, lowered the bed to an elevation of 621 ft, about a foot lower than the top of the footing. The bed did not further degrade until the 5/31/2012 event at a discharge of 65,000 cfs. This may be due to the complex geometry of the pier scour as the footing may help block the downward jet causing local scour.

The minimum local bed elevation for 2012-2013 administration was 618 ft on 4/14/2013. The maximum bed elevation for the current yearly report was 629 ft on 6/23/2013. This was also the local maximum local bed elevation measured during this project.

Bed degradation and aggradation from 6/1/2012 to 6/10/2012 corresponds with a spring runoff peak. This event lowered the local bed from the elevation of the bottom of the footing (622 ft) to 618 ft and then quickly refilled back to the bottom footing elevation. The discharge of this peak was 92,000 cfs and was the greatest peak on the Spring 2012 runoff hydrograph.

The last Spring 2012 peak occurred on 6/30/2012. This event caused an abrupt degradation followed by a very slow aggradation which occurred from 6/11/2012 to 8/16/2012. The bed elevation dropped from 622 ft to 617 ft, then aggraded back to 620 ft. The tail of the hydrograph ends approximately at approximately 8/2012 at a discharge of 10,000 cfs.

Degradation started again 10/28/2012 due a series of small peaks from 10/17/2012 to 12/23/2012. The local bed elevation on 12/23/2013 was 618.5 ft and this was maintained until Spring 2013 runoff events.

Spring 2013 runoff events brought initial aggradation before degrading to 618 ft at the second peak of the hydrograph on 4/13/2013. From this point, the bed aggraded to 629 ft on 6/23/2012 although two higher peaks than the 4/13/2013 peak occurred during this time. A possible reason for this aggradation could be operation of the downstream dam.

Similar discontinuities in the progression of degradation/aggradation as describe in the 2011-2012 yearly administration report can be seen in the Spring 2013 runoff. These discontinuities occur when the local bed elevation reaches the same elevation as the bottom and top of the footing/pile cap. The aggradation during spring 2013 does not change significantly from 4/22/2013 to 6/5/2013 when bed elevation is at 622 ft, the elevation of the bottom of the footing. During this time, the discharge has a local peak of 108,000 cfs and local minima of 64,000 cfs. On 6/5/2013, the bed elevation abruptly rose to 625 ft, approximately the same elevation as the top of the footing. The bed elevation stayed at this elevation from 6/6/2013 until 6/16/2013. After this time, the bed continued to aggrade more continuously to 629 ft. These dates correspond to a falling stage.

The minimum local bed elevation for the current yearly report was 616.5 ft on 5/19/2014. The maximum bed elevation for the current yearly report was 629 ft on 6/23/2013. This was also the local maximum local bed elevation to date.

After the initial bed aggradation during the 2013 Spring runoff, the bed elevation abruptly degraded approximately eight feet from 6/23/2013 to 7/7/2013. This degradation correlated to a rising limb of a hydrograph from 63,400 cfs to a peak of 88,800 cfs.

The final falling limb of the 2013 Spring runoff brought local bed elevation to 622 ft. There were only very minor changes in bed elevation until 11/25/2013 when the

discharge reached a local minimum of 12,500 cfs. The bed elevation remained constant until the 2014 Spring runoff.

The 2014 Spring runoff caused initial local aggradation from 621 ft to 627 ft. This local maximum bed elevation occurred a few days after the 4/2/2014 peak of 59,400 cfs. The bed elevation again quickly degraded back to 621 ft over nine days. This minimum bed elevation correlates in time to the 4/19/2014 peak of 103,000 cfs. The 5/16/2014 peak of 132,000 cfs caused the bed to degrade from 622.5 ft to a minimum bed elevation of 620 ft. The bed was starting to aggrade until the rising limb of the 5/18/2014 peak caused it to degrade. During the 5/18/20014 peak of 128,000 cfs, the local bed degraded to a level of 616.5 ft and then quickly aggraded to an elevation of 626 ft. Since this aggradation, some minor changes to local bed elevation have occurred. As of 6/9/2014, the local bed elevation has settled at 622.5 ft, the approximate elevation of the bottom of the footing.

6.1.2.3 Modifications

To reduce spikes in sonar data, reprogramming on 8/9/2012 caused the maximum change in bed elevation to be one foot if the sonar reads an elevation change of two feet or greater over its 30 minute sample period. . This causes some artifacts to be present in the data when there is an abrupt change in bed elevation. The current programing calculates sonar distance by taking ten readings, removing the minimum and maximum, and averaging the remaining eight samples. Most erroneous readings are due to no sonar return and false returns from the sonar return taking an additional ping from the surface due to ice or other debris. To remedy this, we propose the following pseudocode.

1. Take ten readings
2. Discard any reading with a sonar return of zero feet
3. Discard any readings with a sonar return greater than the previous sonar return plus depth using previous bed elevation and water surface elevation minus three feet. Three feet is an estimate of debris or ice thickness.

$$dist > dist_{prev} + (WSEL_{prev} - BedEl_{prev}) - 3$$

Average remaining values and report. If no readings remain, repeat steps 1-3. If no readings remain for second attempt, report sonar distance of 0 (bed elevation of 640 ft) to indicate reading was not possible.

6.1.3 Pier 20 Scour

Figure 37, Figure 38, and Figure 39 shows the scour around Pier 20 for each administration year.

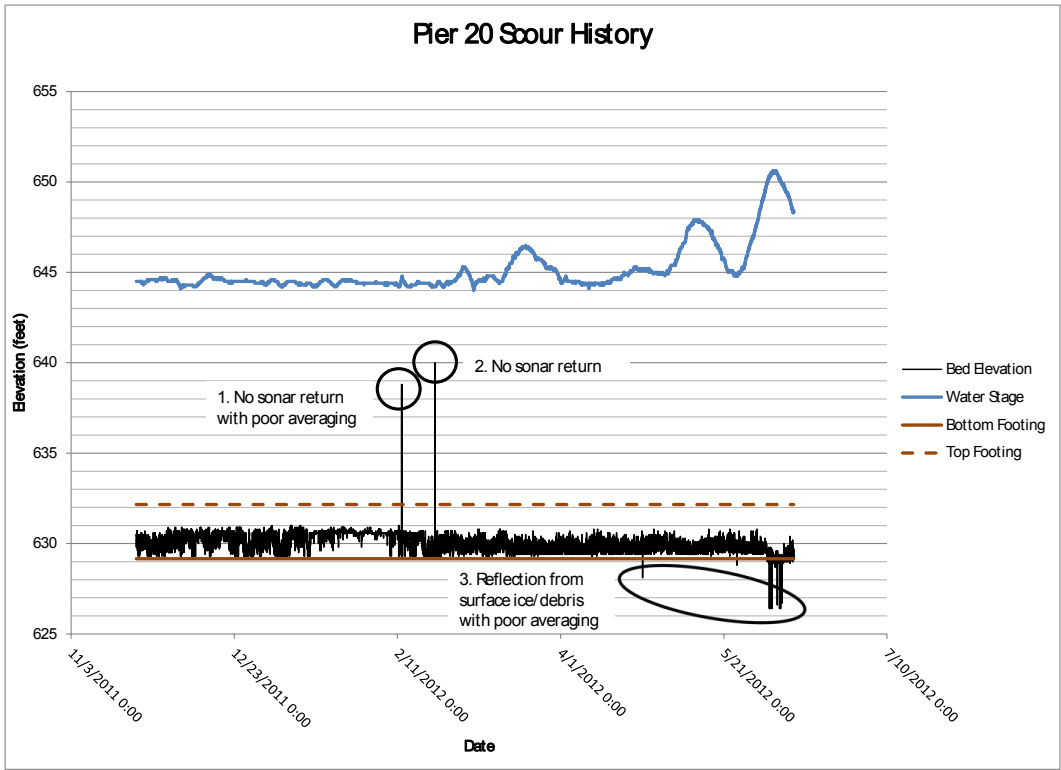

Figure 37: Pier 20 Scour History – Administration 2011-2012

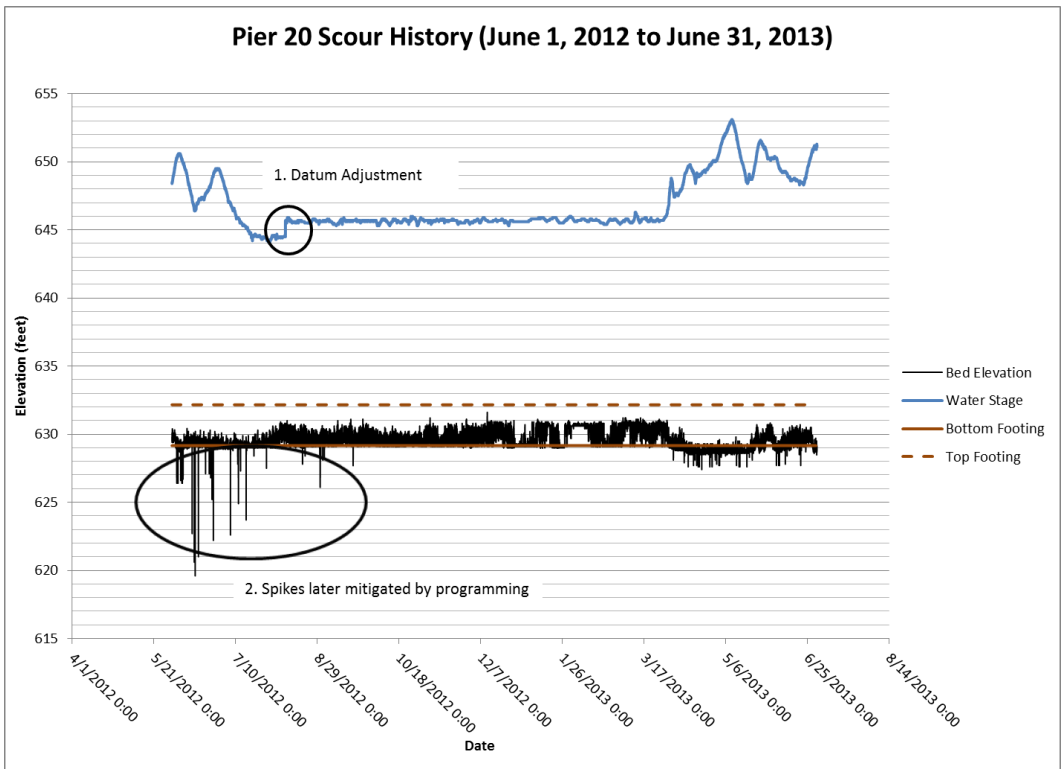

Figure 38: Pier 20 Scour History – Administration 2012-2013

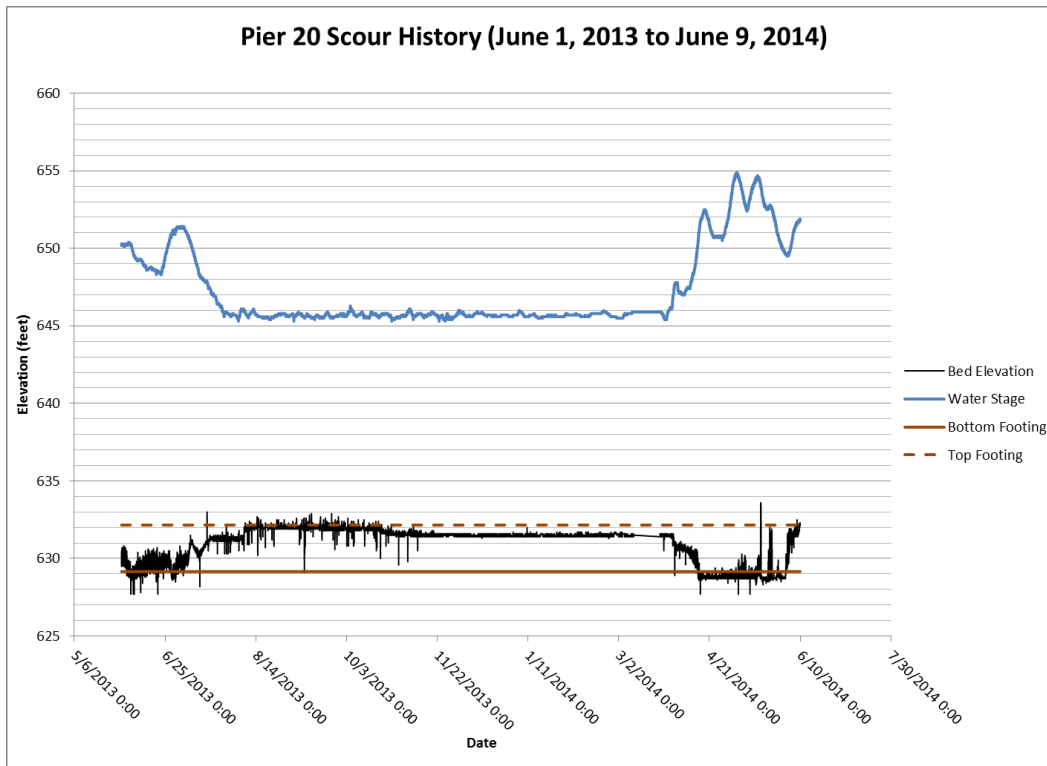

Figure 39: Pier 20 Scour History – Administration 2013-2014

6.1.3.1 False Readings

During 2011-2012 administration, the false readings at Pier 20 were likely due to the same causes as with Pier 19. Refer back to Section 6.1.2.1 for a description of these causes.

The spike on 2/12/2012, indicated by circle 1 in the figure, is likely due to a no sonar return affecting some, but not all, of the 8 readings that are used to calculate the reported bed elevation. From the magnitude of the spikes, about 7 of the 8 samples appear to be samples with no sonar return. The actual sonar reported reading for no sonar return comes back as zero and the elevation of the instrument is 640 ft.

The spike on 2/22/2012, indicated by circle 2 in Figure 38 is likely due to no sonar return affecting all of the 8 readings used to calculate the reported bed elevation.

The spikes from 4/26/2012 to 6/7/2012 that reached about 626 ft are likely due to reflections from the ice or debris on the water surface affecting some, but not all, of the 8 readings that are used to calculate the reported bed elevation. These are indicated by circle 3 on the figure. From the magnitude of the spikes, about 1 or 2 of the 8 samples appears to have been samples affected by surface reflections.

During 2012-2013 administration, the false readings at Pier 20 were likely due to the same averaging issues that were seen in Pier 19 data. However, the spikes appear to be due to surface reflections interpreted as longer sonar to bed distances rather than no sonar return.

The spikes from 6/1/2012 to 7/26/2012, indicated by circle 2 in the figure, are likely due to an extra reflection from surface debris on some, but not all, of the eight readings that

are used to calculate the reported bed elevation. From the magnitude of the spikes, about one to three of the eight samples averaged appear to have been samples with extra travel time due to surface reflections. The spikes were mostly mitigated by the 8/9/2012 reprogramming. The spikes after 8/9/2012 again were likely due to surface debris reflections, but were persistent enough to overcome the maximum allowable change in elevation of two feet as allowed by the programming.

During 2013-2014, there are no noticeable false readings from the Pier 20 bed elevation data.

6.1.3.2 Actual Scour Events

Overall during 2011-2012 administration, the bed at pier 20 was very constant with few fluctuations during the time frame shown in Figure 37. Over the entire period the bed varied by less than +/- 1 foot. Also, with the exception of the 6/2/2012 event, the data set appears to hit a minimum of 629.6 ft. This is about 0.4 ft above the bottom of the footing and likely has to do with the scour at the front edge of the pier stopping at the bottom of the footing. This same discontinuity in the progression of scour was found at Pier 19. During the 6/2/2012 scour event, the scour did increase until 80,000 cfs. At this point, the scour lowered the bed elevation by about 6 inches, but quickly refilled as the discharge fell back down.

Overall, the bed was very constant with few fluctuations during the time frame shown in Figure 37. As with the 2011-2012 yearly administration report, the bed during 2012-2013 varied by approximately +/- 1 foot. Over the current year examined, the minimum bed elevation encountered was 628.5 ft. This elevation was maintained for approximately one month during the spring 2013 runoff. The maximum bed elevation was 630.5 ft. This was the same maximum bed elevation from the previous year and likely corresponds to the bed elevation not affected by local scour.

Overall, the bed was very constant with few fluctuations during the 2013-2014 administration. Over the current year examined, the minimum bed elevation encountered was 629 ft. This elevation occurred during the spring 2013 runoff event. The bed then aggraded to a maximum bed elevation of 632 ft during the falling limb of the spring 2013 hydrograph. All bed motion stopped around 10/26/2013. This elevation was maintained until the spring 2014 hydrograph.

The spring 2014 runoff caused degradation until the bed elevation reached 629 ft on 4/14/2014. This correlates to the rising limb of the 4/18/2014 peak discharge. The abrupt stop in degradation in the middle of the rising limb again illustrates the discontinuity in the progression of the scour due to the footing protecting sediment from further scour. The bottom of the footing is at 629.16 ft. This bed elevation was maintained through the three major peaks of the 2014 spring runoff event. The local bed elevation then sharply aggraded from 6/2/2014 to 6/4/2014 up to a local elevation of 631.4 ft, slightly below the elevation of the top of the footing.

6.1.3.3 Potential Modifications

Similar programming modifications as pier 19 are recommended. See Section 6.1.2.3

6.1.4 Pier 20 Tilt

The averaging scheme for the tilt sensors is similar to that of the sonar sensor. Ten readings are taken, the lowest and highest are discarded, and the remaining eight are averaged. The spikes from both tilt sensors are likely due to poor readings that are not caught with this averaging method.

Figure 40 shows the tilt history of entire monitored period from 11/23/2011 to 6/9/2014. Frequency analysis shows both signals have dominant frequencies around 24 hours likely correlated to daily heating (day) and cooling (night) of the bridge structure.

General descriptions of the tilt data are:

- Slightly reduced, but continued sensor drift, about $-0.05^\circ/\text{year}$, for both streamwise and spanwise tilt
- Maximum tilt in winter, minimum tilt in later summer for both stream wise and spanwise tilt.
- Spanwise tilt sensor appears to have more spikes than the stream wise tilt sensor.

There appears to be no significant abrupt changes in tilt. It is not possible to conclude if the tilt reading were related to actual pier movement or sensor drift.

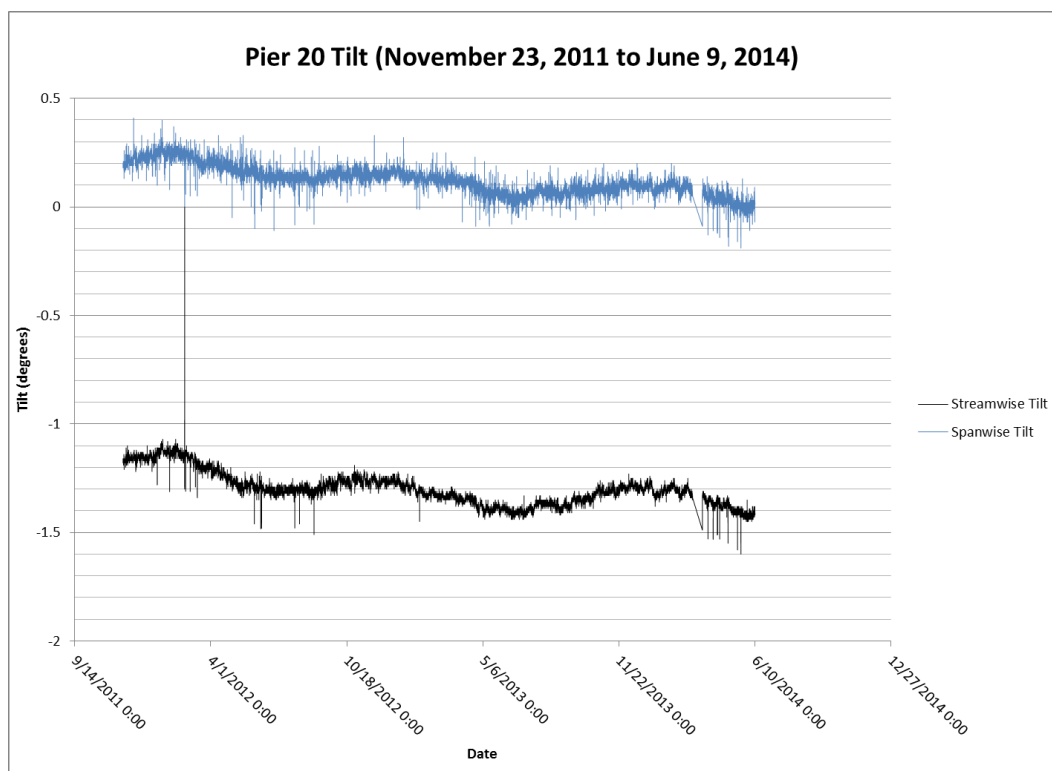

Figure 40: Pier 20 Tilt History for Entire Monitoring Period

6.1.5 Battery Voltage

The lowest battery voltage during the time period from 11/22/2011 to 6/10/2012 was 11.9 volts. This occurred on 12/6/2011 on the master battery after five days with not enough solar radiation to charge the system. Figure 41 shows the poorest charging history from 11/22/2011 to 6/10/2012. The spikes indicate daily charging from the solar panels and the

downward sloping portions indicate overnight discharging. The remainder of the voltage data shows charging occurring daily.

The batteries on both systems are 12 volt, 12 Amp-hour batteries. The power budgets are reviewed in Sections 6.1.5.1 and 6.1.5.2.

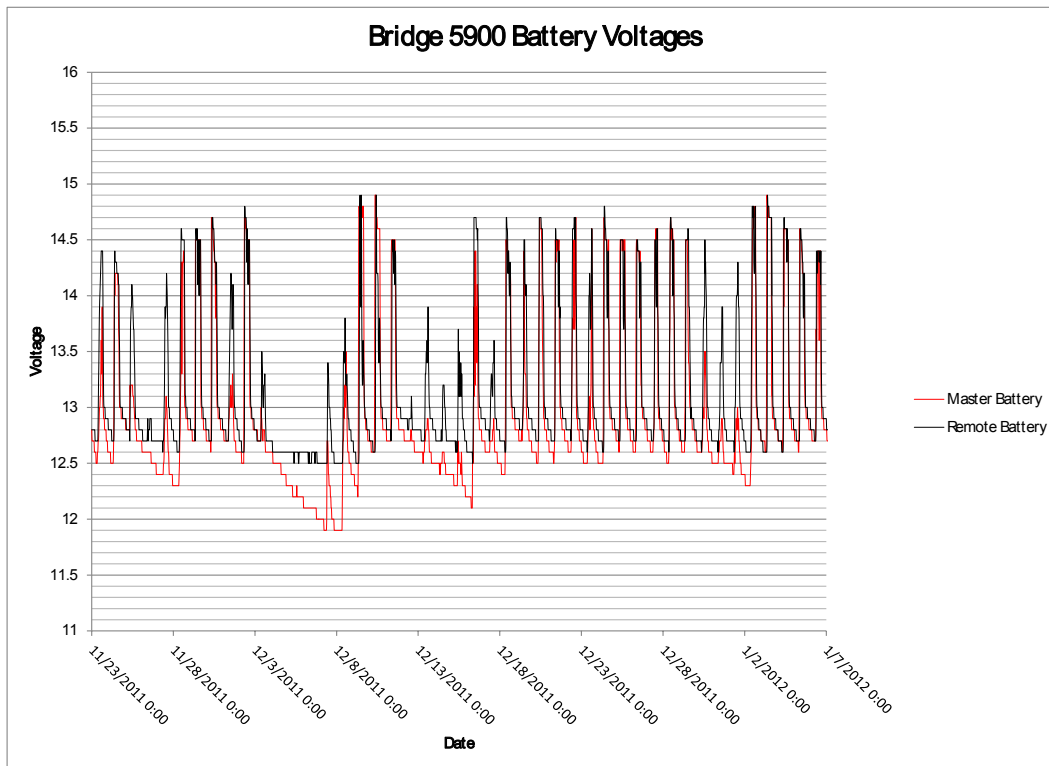

Figure 41: Bridge 5900 Voltage

During 2012-2013 administration, the lowest battery voltage during the time period from 6/1/2012 to 6/30/2013 was 11.8 volts. This occurred on 12/21/2012 on the master battery after six days of minimal solar charging.

During 2013-2014 administration, the storage capacity on the Master Station battery was diminished and the battery required replacement. Figure 41 shows the initial issue occurring on 12/5/2013 with voltages dropping to 11.1 Volts. Starting on 4/29/2013, a series of days with low solar radiation caused the voltage to drop to 8.7 Volts at which point, the datalogger stopped operating. The datalogger came back online by itself once the battery was recharged via the solar panel. Figure 43 shows the degraded battery storage capacity. At 12.5 Volts, the battery abruptly loses voltage which is indicative of reduced battery Amp-hours. The other batteries likely also have reduced Amp-hours and should also be replaced.

The gap in reported voltage shown in Figure 41 is due to a communication error with a Gmail server during the weekly update email. The time of the last reported data was 6:00 AM and the weekly message was due to be sent at 6:25 AM. This communication error caused the program to stall and no data was collected from 3/10 to 3/24. ETI likely restarted the program to remove the error. The portion of the code that sends the email has been removed until the operating system is updated, which according to Campbell Scientific, should resolve the Gmail communication issue.

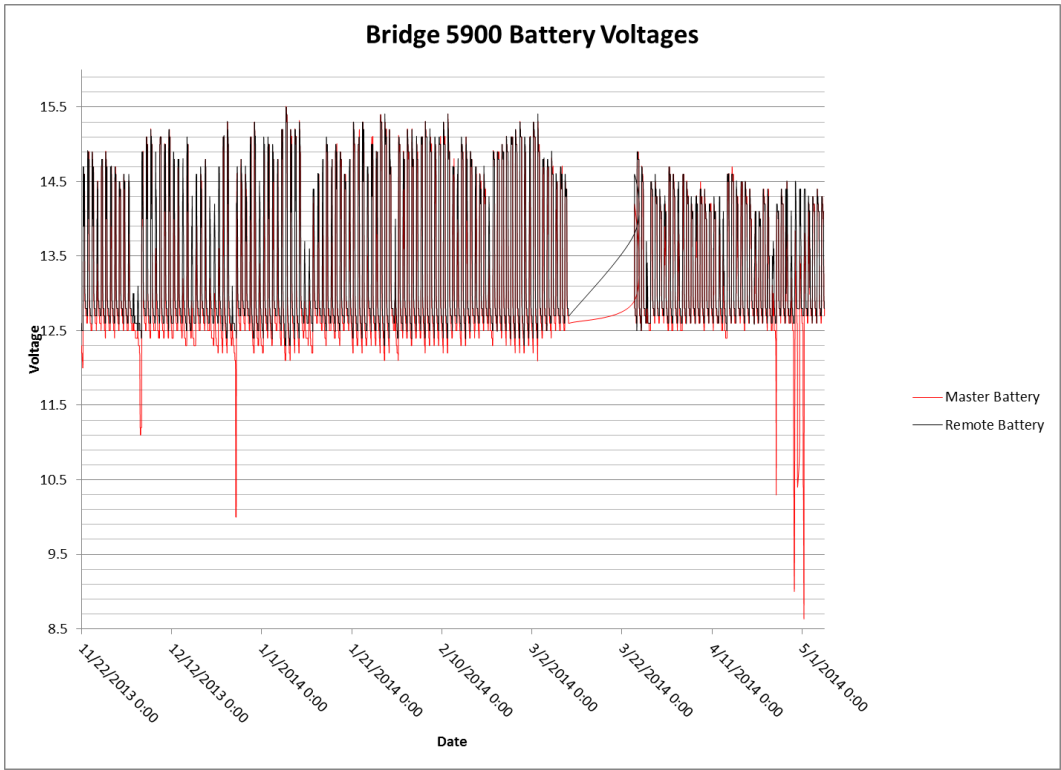

Figure 42: Bridge 5900 Voltages

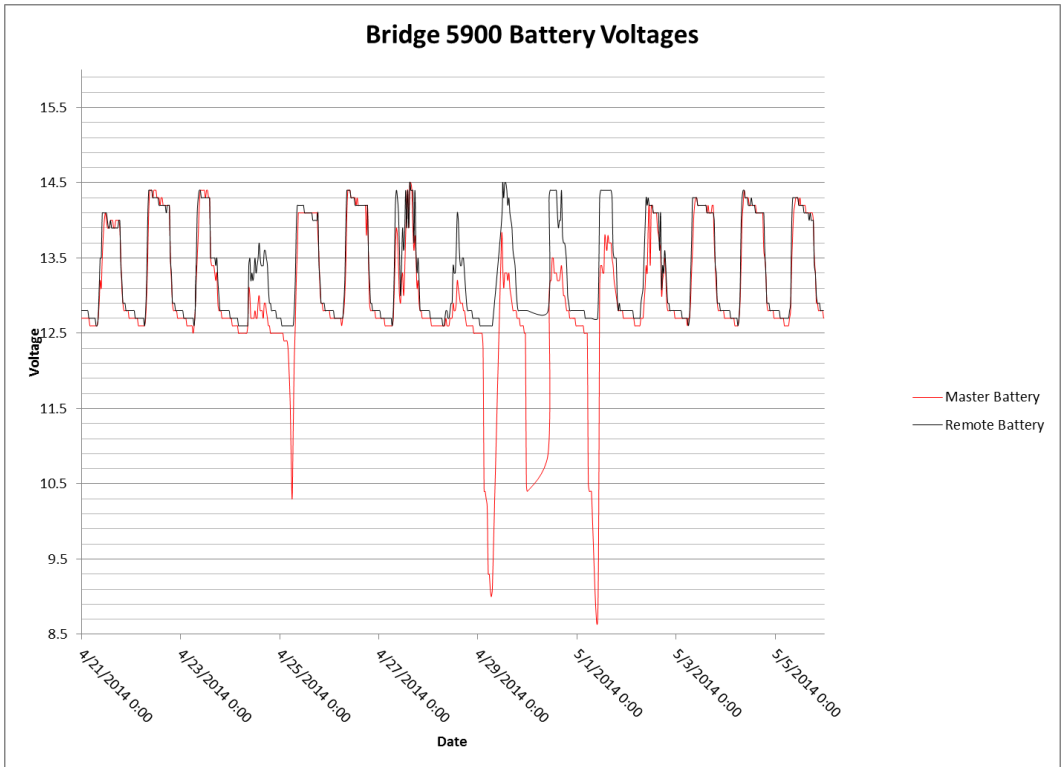

Figure 43: Degraded Master Station Battery Capacity

6.1.5.1 Master Station Energy Budget

The following items consume power on the Master Station

Table 10: Bridge 5900 Master Station Equipment Amperage

Equipment	Amperage (mA)
CR800 data logger	10
SS510 Sonar Transducer	0.2 (40 mA for 20 seconds every hour)
Tilt Sensors	1
RF401 Wireless Radio	4
RavenX Modem	8.3 (50 mA 10 minutes every hour)
<i>Total</i>	<i>23.5</i>

The total is 0.565 A-h/day. The 20 watt solar panel can output 1.19 A for 4 hours yielding a total of 4.76 A-h/day.

Campbell Scientific's recommended battery capacity should last for 288 hours (12 days) at Minnesota's latitude and a derating factor of 0.8 should be used. This battery capacity should be:

$$0.0235 \text{ A} \times 288 \text{ hours} / 0.8 = 8.5 \text{ A-hours.}$$

The 12 A-hour battery capacity is more than adequate.

6.1.5.2 Remote Station Energy Budget

The following items consume power on the Remote Station.

Table 11: Bridge 5900 Remote Station Equipment Amperage

Equipment	Amperage (mA)
CR800 data logger	10
SS510 Sonar Transducer	0.2 (40 mA for 20 seconds every hour)
SS 510 Stage Sensor	1
RF401 Wireless Radio	4
<i>Total</i>	<i>15.2</i>

This total is 0.365 A-h/day. The 20 watt solar panel can output 4.76 A-h/day. This battery capacity should be:

$$0.0152 \text{ A} \times 288 \text{ hours} / 0.8 = 5.5 \text{ A-hours.}$$

The 12 A-hour battery capacity is more than adequate.

6.2 Bridge 07011

All of the offsets for the sonar and radar stage sensor were finalized on 11/3/2011. The dataset is good from this point on. The system worked as expected for the 2012-2013 year. There was no activity monitored on Pier 5 with the exception of a simulated float-out event performed on 4/2/2014 and 5/13/2014 as part of testing events. Issues with the Master Station battery caused the system to go down from 12/31/2013 to 4/2/2014. However, nearby USACE stage measurements indicate there was no meaningful data lost during this time.

6.2.1 Stage

Figure 44, Figure 45, and Figure 46 show the stage and discharge from a local USACE monitoring station and from the scour monitoring equipment for each administration period. The radar stage sensor on the Bridge 07011 system is located on the downstream side of the bridge about 20 ft west of Pier 4. The USACE gauge is located on the east side of the river approximately 1.5 miles upstream of the bridge and uses NGVD 1929 as a datum for elevation. The stage as measured by the scour monitor is consistently 1 ± 0.1 ft below the reported USACE levels when discharges are below 4500 cfs. This agrees well with the reported bed slopes given in flood profiles. Figure 47, Figure 48, and Figure 49 show the difference between local staging station and the stage recorded by the scour monitoring equipment. At larger discharges, the difference increases up to two feet. This is likely due to reduced water surface elevation at the bridge caused by the increase in local velocity head. The time when the scour monitoring station was not operational is shown by the gap in the Figure 44. The USACE stage curve shows that no meaningful data was lost during this time.

The data for the USACE gage is taken from

<http://www.mvp-wc.usace.army.mil/dcp/MNKM5.html>

and

[http://waterdata.usgs.gov/mn/nwis/uv/?site_no=05325000&agency_cd=USGS.](http://waterdata.usgs.gov/mn/nwis/uv/?site_no=05325000&agency_cd=USGS)

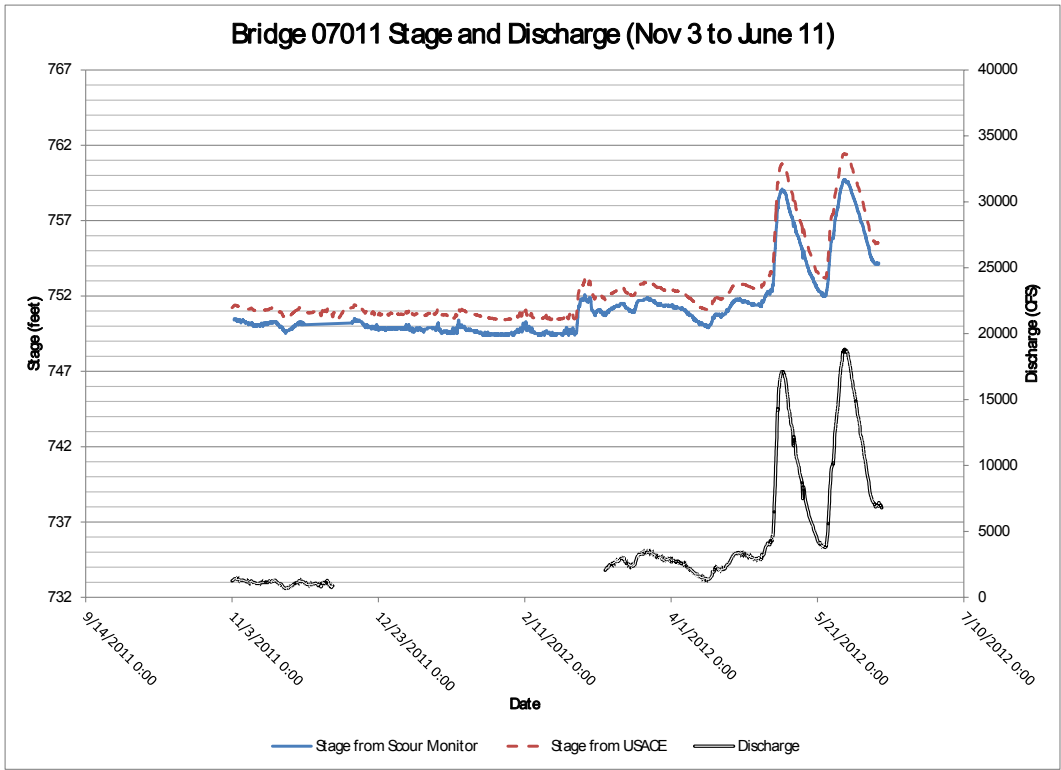

Figure 44: Bridge 07011 Stage and Discharge –Administration 2011-2012

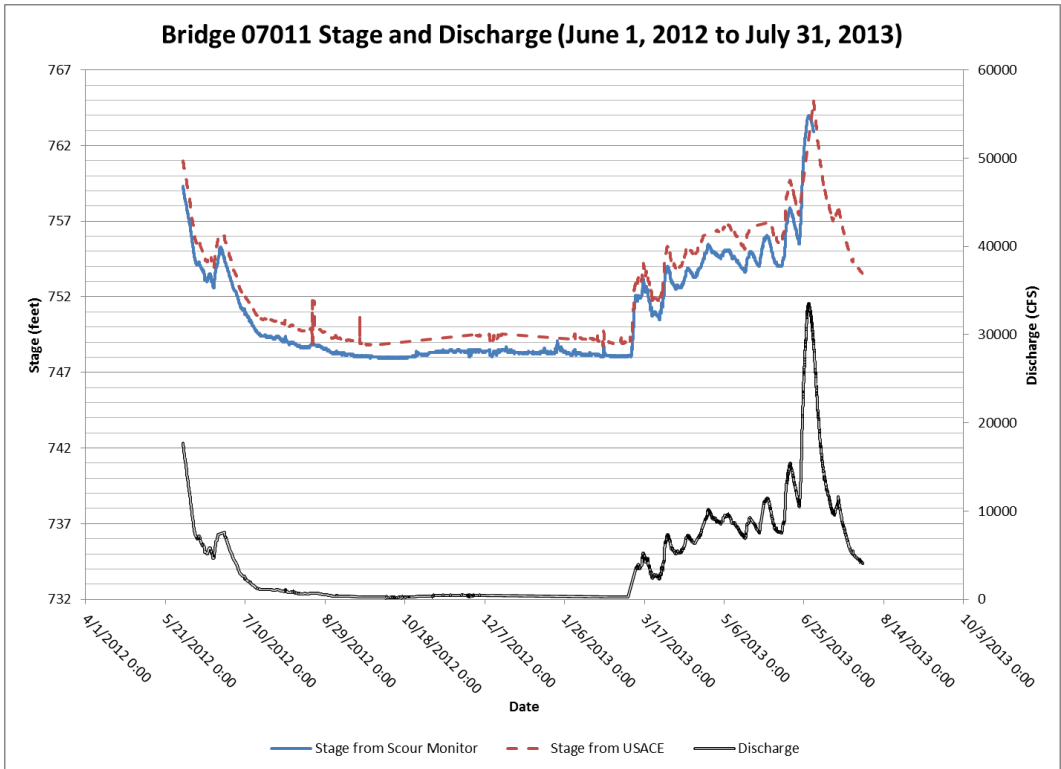

Figure 45: Bridge 07011 Stage and Discharge –Administration 2012-2013

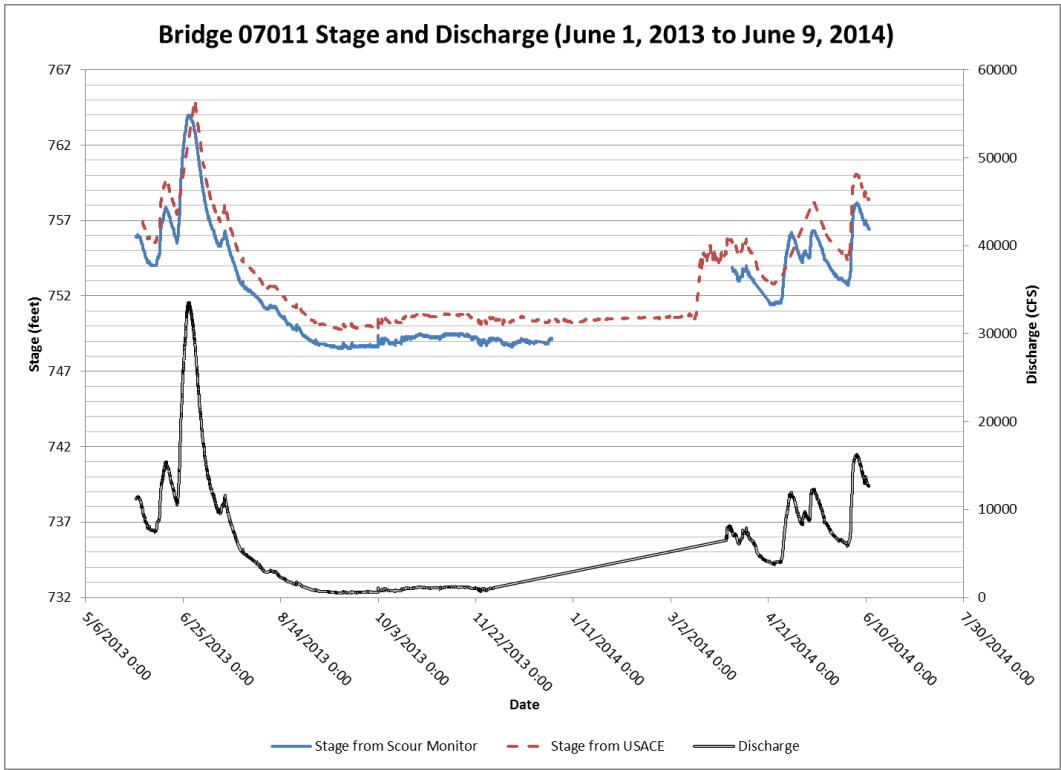

Figure 46: Bridge 07011 Stage and Discharge – Administration 2013-2014

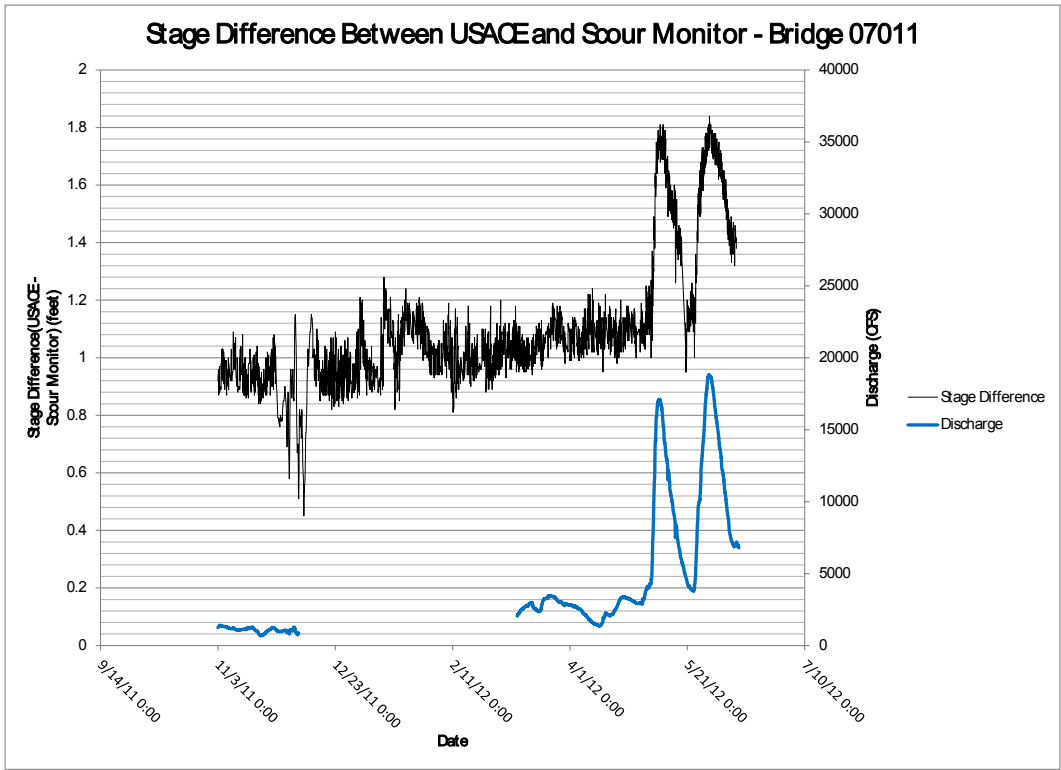

Figure 47: Stage Difference between USACE and Scour Monitor – Administration 2011-2012

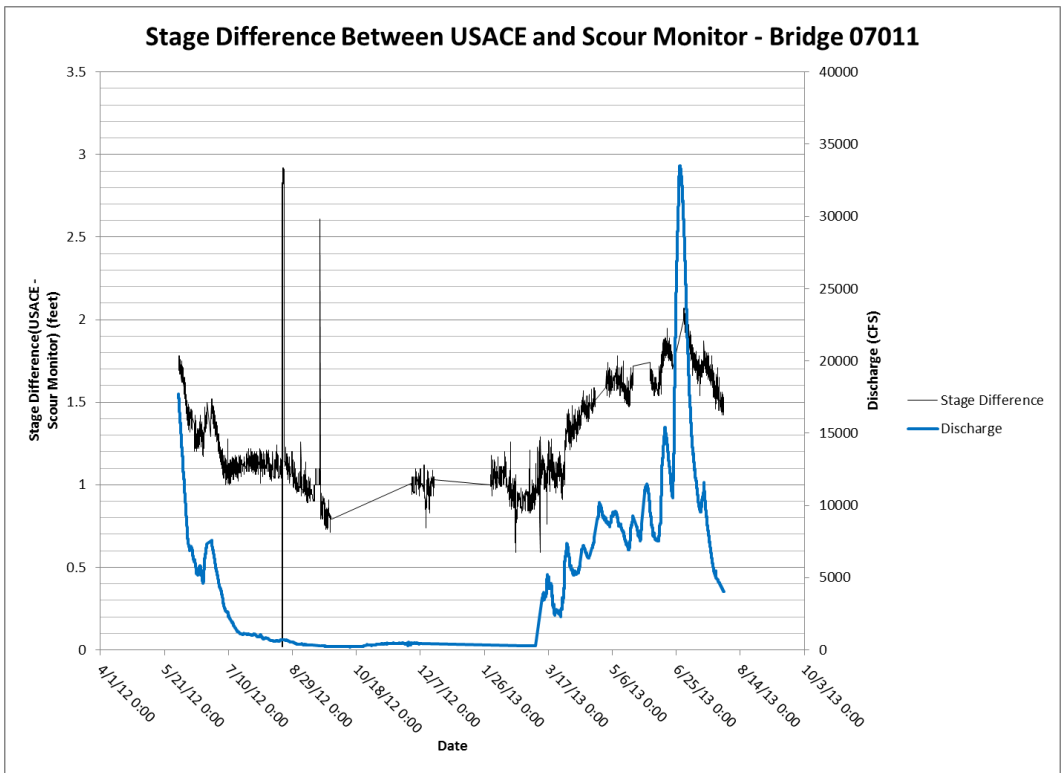

Figure 48: Stage Difference between USACE and Scour Monitor – Administration 2012-2013

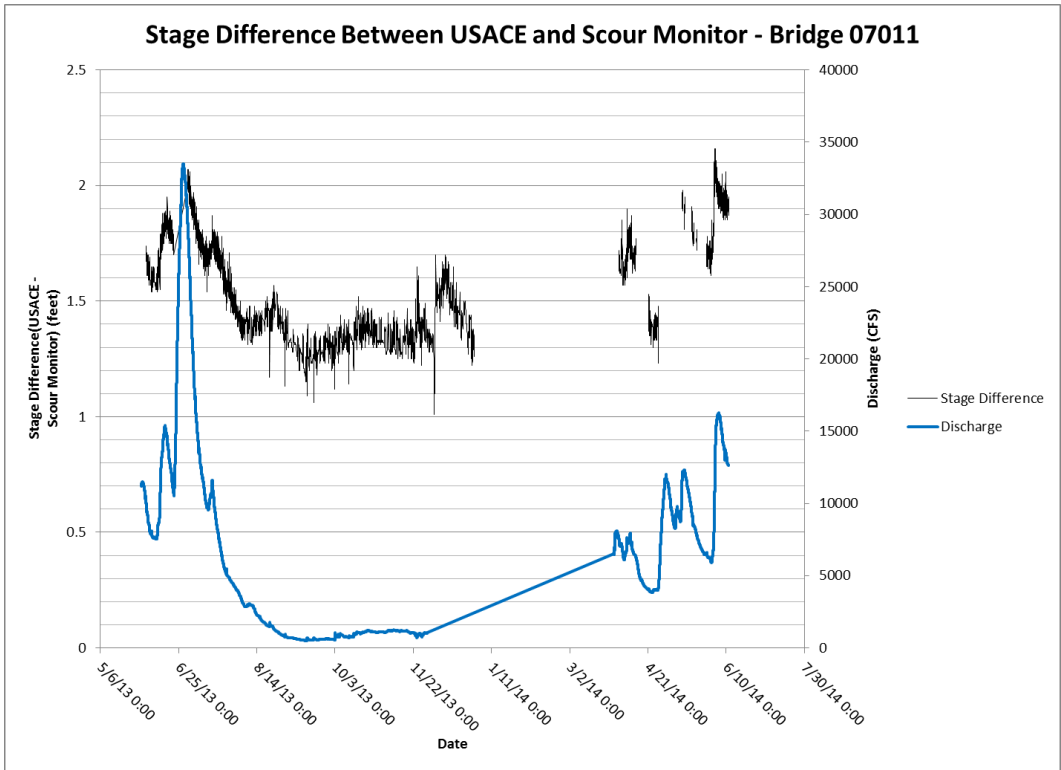

Figure 49: Stage Difference between USACE and Scour Monitor – Administration 2013-2014

6.2.2 Pier 4 Scour

The sonar is mounted on the downstream side of the bridge at an elevation of 755 ft and the stage needs to reach 757 ft for the sonar to operate. The bed elevation for all events during the monitored period ranged from 747 to 748 ft. This is far above the scour critical elevation of 733 ft.

Figure 50 shows the two events that activated the sonar on Pier 4 during 2011-2012 Administration.

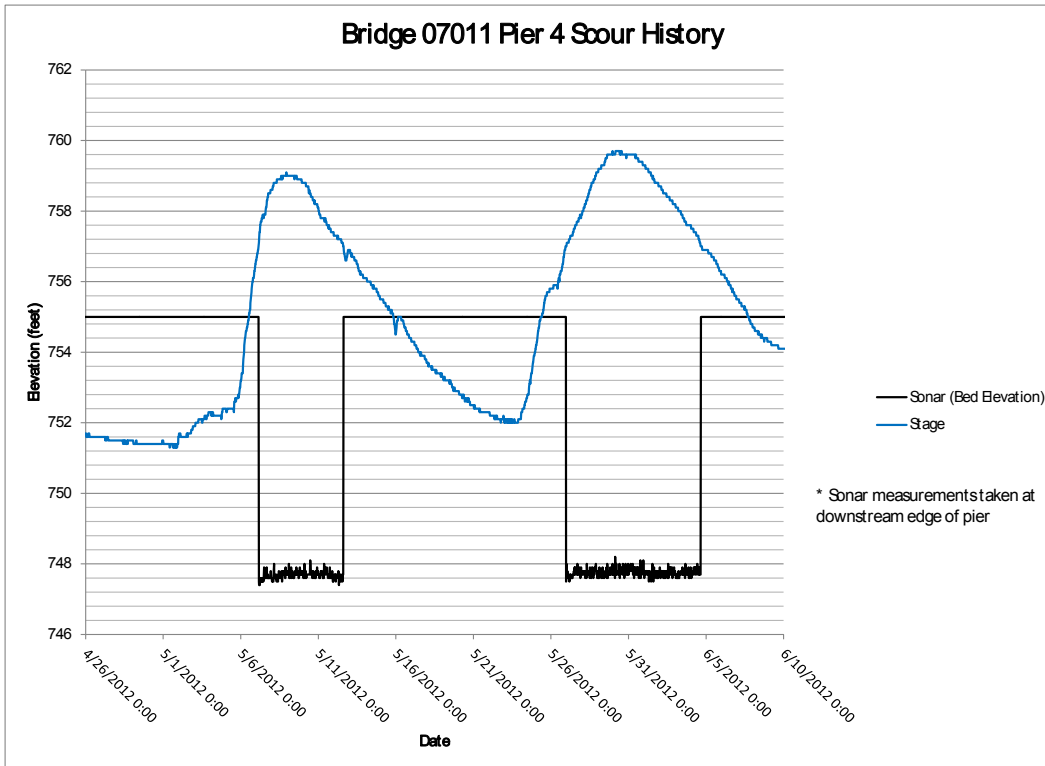

Figure 50: Pier 4 Downstream Bed Elevation – Administration 2011-2012

Figure 50 shows the two events that activated the sonar on Pier 4 during 2012-2013 Administration.

As opposed to the previous yearly report, there were false readings which returned bed elevations of 753.6 ft. The most likely explanation for these recorded elevations is suspended sediment caused a return at the minimum range for the sensor. This explanation is supported by suspended sediment concentrations that spiked to 800 mg/liter from 375 mg/liter from 6/24/2013 to 6/27/2013. This information came from the following website.

http://waterdata.usgs.gov/nwis/inventory?agency_code=USGS&site_no=05325000

The specification sheet indicates the minimum range for the instrument is 0.4 meters or 1.3 ft. This correlates well with a reported bed elevation of 753.6 ft with the sonar datum set at 755 ft.

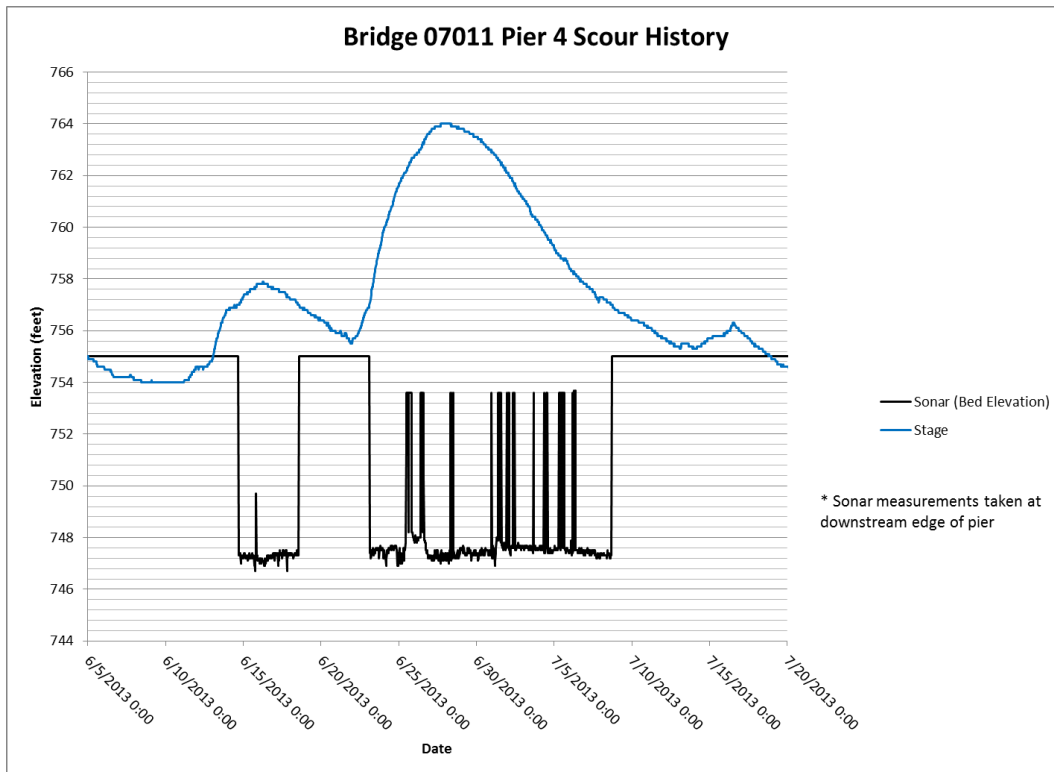

Figure 51: Pier 4 Downstream Bed Elevation – Administration 2012-2013

The stage was high enough to activate the sonar from 6/3/2014 to 6/8/2014 during 2013-2014 Administration. The maximum stage covered by the 2013-2014 report was 758.1 ft.

As with the previous yearly report, there were false readings which returned incorrect bed elevations. These false bed elevations were 753.9 ft and were more persistent when compared to the previous year. The most likely explanation for these recorded elevations is suspended sediment caused a return at the minimum range for the sensor. The sediment concentrations in the river are not readily available online. However, this event was due to a rainfall event which may cause high amounts of suspended sediment in the river. This may have also caused the more persistent false readings.

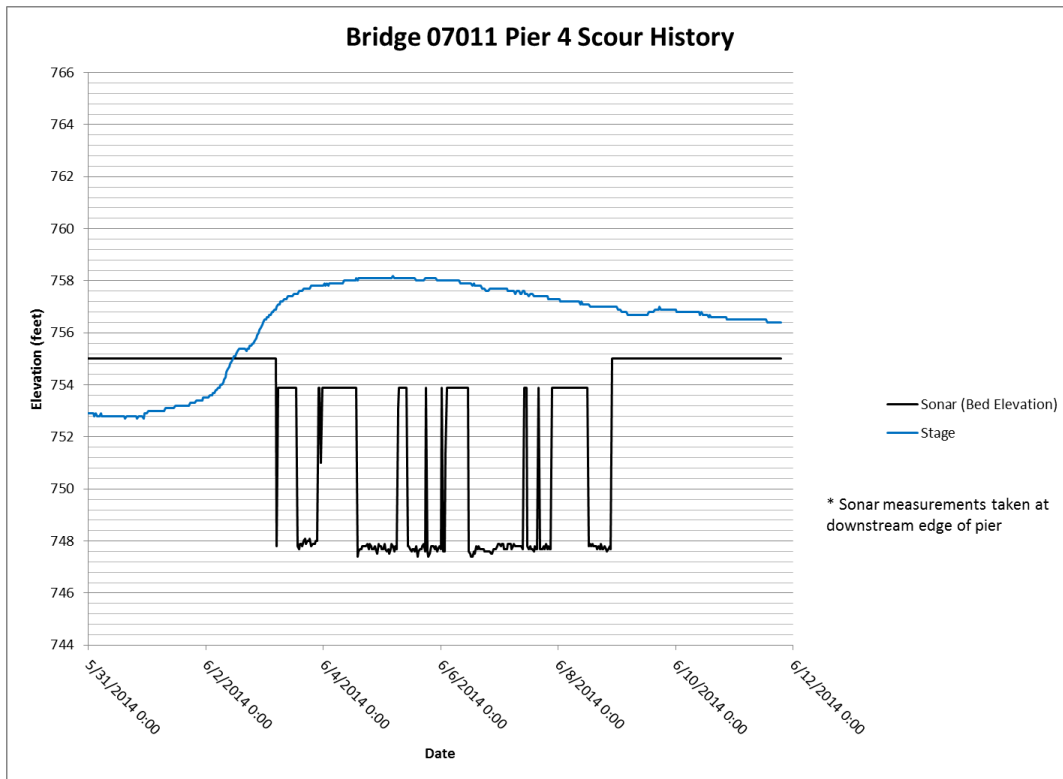

Figure 52: Pier 4 Downstream Pier Elevation – Administration 2013-2014

6.2.2.1 Modifications

A similar error trapping routine should be employed on the Bridge 07011 sonar devices as with underwater sonar devices on Bridge 5900. However, this routine would include additional error checks to mitigate issues with false sonar reading due to suspended sediment. The error check for surface reflections is excluded, as there is no evidence of this type of sonar return in the data and the sonar is typically above the water level when ice occurs.

1. Take ten readings
2. Discard any reading with a sonar return of zero feet
3. Discard any reading with a sonar return of less than two feet
4. Average remaining values and report. If no readings remain, repeat steps 1-3. If no readings remain for second attempt, report sonar distance of 0 (bed elevation of 655 ft) to indicate reading was not possible.

The program on the datalogger should continue to only sample the sonar sensor when the stage is 757 ft or higher.

6.2.3 Pier 5 Scour

Scour around Pier 5 is monitored by two tethered buried switches and two wireless float-out sensors. There were no alarms based on any of these systems during monitoring with the exception of the 4/2/2014 and the 5/13/2014 testing events which triggered float-out 1 alarms. The Tethered Buried Switch (TBS) returns a value of 1 when undisturbed and the Float-outs (FOArray) return a value of 0 when they are undisturbed.

The local bed elevation at the front side of Pier 5 at installation was about 758 ft and the maximum water surface elevation during monitoring was 764 ft. This is approximately six feet of local water depth above the float-out devices.

6.2.4 Battery Voltage

The initial 12 Amp-hour battery installed on the Master Station of Bridge 07011 was undersized to deal with the continuous operation of the wireless float-out receiver. This receiver needs to operate continuously to ensure the float-out signal is captured before it floats downstream. This issue manifested itself on 11/28/2011 when the master voltage dropped to 10.6 volts and the datalogger quit operating. This occurred after 2.5 days of little solar charging. The 12 Amp-hour battery was replaced with a 35 Amp-hour battery on 12/13/2011 by a District Signal Technician and the system worked well for more than a year. Similar consecutive non-charging days are found in the voltage data and the lowest master battery voltage since the replacement was 12 volts.

Figure 53 shows the comparison of overnight discharge before and after the master battery voltage was replaced. The remote battery voltage is also shown for reference.

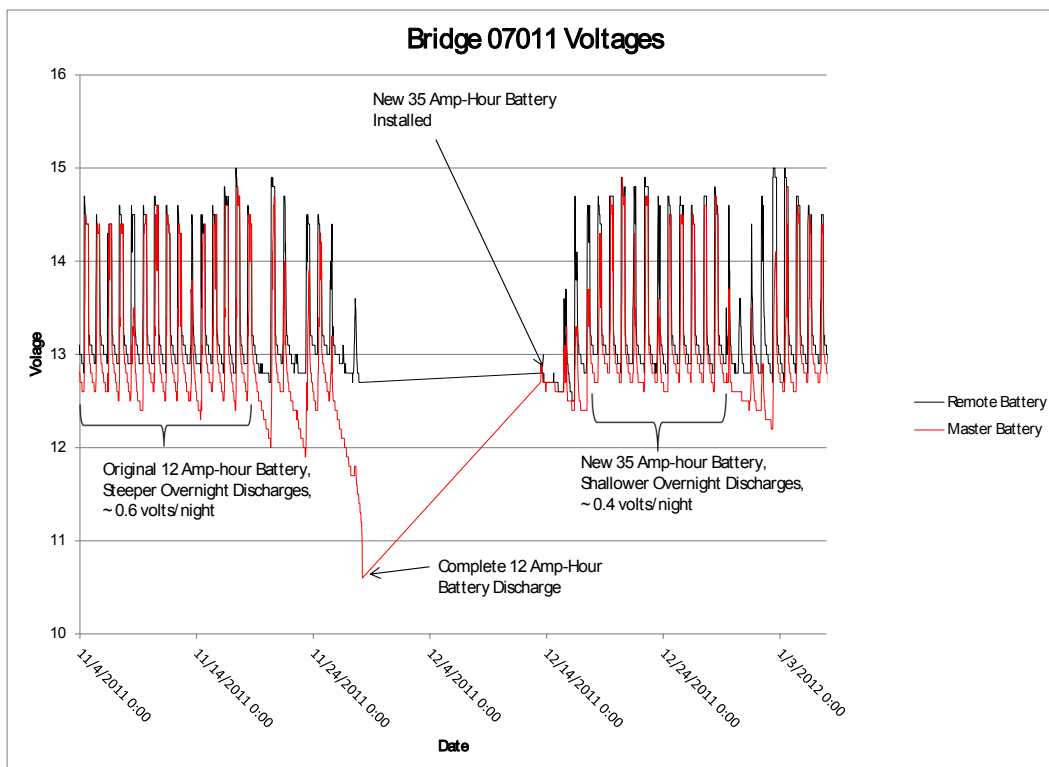

Figure 53: Bridge 07011 Voltages

There were no power issues with the remote station on bridge 07011 during the 3 year test period. During 2012-2013 Administration, the lowest voltage encountered for the Master Station was 11.4 volts after four days of minimal charging.

Figure 53 shows the lowest battery voltages encountered during 2013-2014 maintenance.

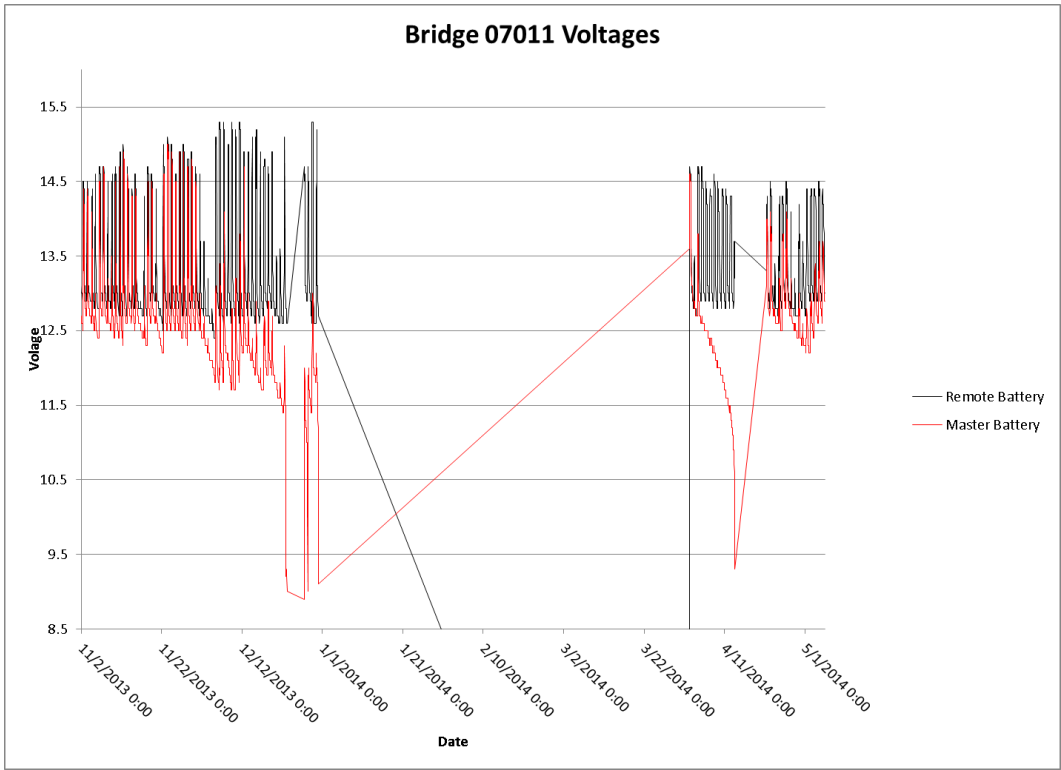

Figure 54: Bridge 07011 Voltages

Although it worked well for over a year, the 35 Amp-hour battery installed during 2011-2012 maintenance was unable to store enough energy in December 2013 and the system went offline on 12/31/2013. This was preceded by an outage from 12/23/2013 to 12/27/2013 when the battery voltage dropped too low to operate the datalogger. For this event, the datalogger restarted automatically after the solar panel recharged the battery.

The battery was replaced on 4/2/2014 and operated for one day before the solar panel stopped charging the battery and the system again went offline on 4/13/2014. Discussions between ETI, SAFL, and MnDOT electrical technicians determined that the most likely issue was a bad battery charging regulator. On 4/21/2014, MnDOT district personnel and a MnDOT electrical technician replaced the regulator and associated connections. The connections were not waterproof and had suffered severe corrosion to the point at which they were no longer conducting. Figure 55 shows the extreme corrosion that was found. The regulator was relocated to the inside of the datalogger enclosure and connections to the solar panel outside of the enclosure were waterproofed. Figure 56 shows the relocated regulator in the enclosure.

The solar panel and regulator on the Master Station of Bridge 07011 were the most likely to corrode of all the solar panels installed during this project because of its location just outside the bridge barrier. This solar panel was most likely to come into contact with roadway spray and plowed snow.

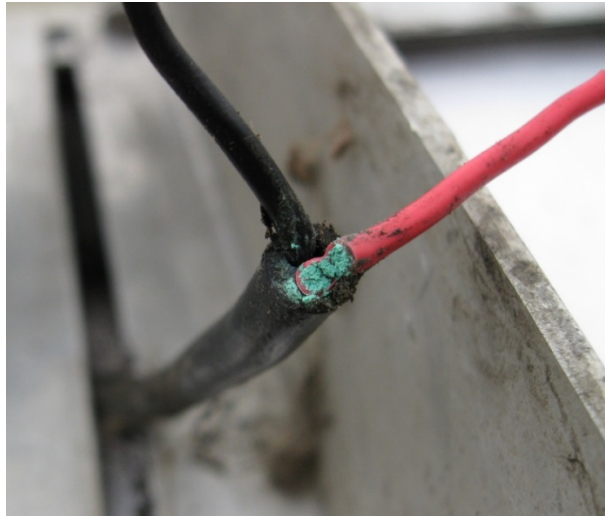

Figure 55: Wire Corrosion on Solar Panel Wire



Figure 56: Relocated Solar Regulator

6.2.4.1 Master Station Energy Budget

The following items consume power on the Master Station on Bridge 07011

Table 12: Bridge 07011 Master Station Equipment Amperage

Equipment	Amperage (mA)
CR800 data logger	10
Tethered Buried Switches	5.1
Wireless Float-Out Receiver	80
RF401 Wireless Radio	4
RavenX Modem	8.3 (50 mA 10 minutes every hour)

Total	107.4
--------------	--------------

This totals 2.578 A-h/day. The 20 watt solar panel can output 1.19 A for 4 hours yielding a total of 4.76 A-h/day. This battery capacity should be:

$$0.1074 \text{ A} \times 288 \text{ hours} / 0.8 = 38.7 \text{ A-hours.}$$

The initial 12 A-hour was not appropriately sized to handle the large current draw required by the wireless receiver, which accounts for 75% of all current draw from the system. It was replaced with a 35 Amp-hour battery shown in the following figure.

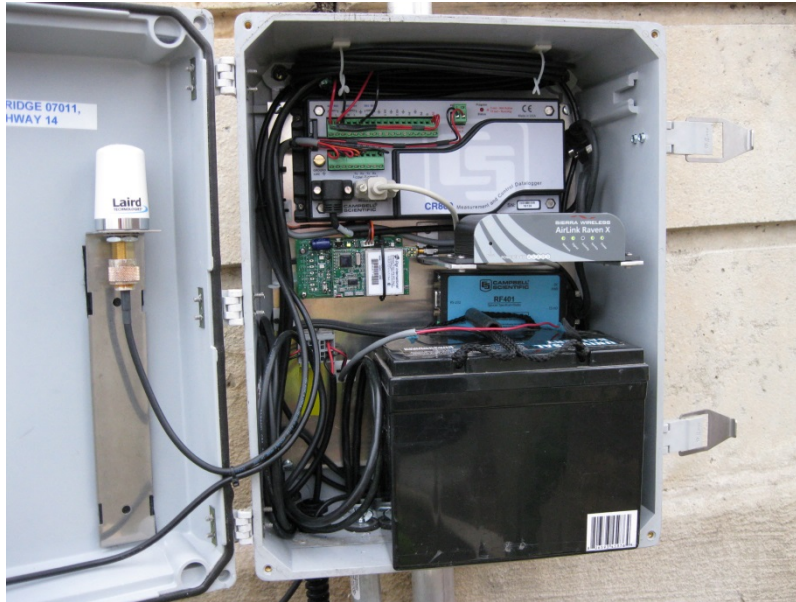

Figure 57: 35 Amp-hour Battery Replacement on Bridge 070011 Master Station

6.2.4.2 Remote Station Energy Budget

The following items consume power on the Remote Station on Bridge 07011

Table13: Bridge 07011 Remote Station Equipment Amperage

Equipment	Amperage (mA)
CR800 data logger	10
SS510 Sonar Transducer	0.2 (when submerged)
CS475 Radar Stage Sensor	4.7
RF401 Wireless Radio	4
Total	18.9

This totals 0.453 A-h/day. The 20 watt solar panel can 4.76 A-h/day. This battery capacity should be:

$$0.0194 \text{ A} \times 288 \text{ hours} / 0.8 = 7.0 \text{ A-hours.}$$

The 12 A-hour battery capacity is more than adequate.

8.1.1.1 Modifications

To mitigate the low voltage issues related to the high current draw of the receiver, a power relay should be installed that controls power to wireless float-out receiver. The pseudocode for relay operation is listed here.

- If battery voltages drops below 11.8 volts;
 - Turn off power to floatout receiver;
- If floatout receiver off and battery voltage has been greater than 13 volts for 1 hour;
 - Turn on power to floatout receiver;

An alert that the floatout receiver is inactive should also be sent out also. The best way to do this is to change the current variable, such as “FOArray(1) and FOArray(2)” to a value of 3, indicating the float out devices are currently undetectable.

This modification will require some reprogramming and installation of a relay in the Master Station enclosure. The relay would have a minimal effect on the power budget of the Master Station.

This modification also allows the receiver to be remotely reset if any float-outs are accidentally triggered during installation or maintenance by allowing system administrators to remotely power cycle the receiver

6.3 Alerts/Warnings

The following are alerts used for the scour monitoring systems. Explanations are given as necessary. Each alert is also listed with which group to be notified.

- *Admin*: includes St. Anthony Falls Laboratory IT and data custodian, MnDOT Bridge Hydraulics, and ETI Sensors
- *All*: includes *Admin* and specified local MnDOT district personnel.

6.3.1 Alerts from Bridge 5900

- University of Minnesota database has not updated within 3 hours. This is typically updated every half hour.
 - *Admin*
- Stage Exceeds 653.5 ft. This is per the Bridge Scour Action Plan.
 - *All*
- Pier 19 Bed elevation goes above 629 ft. Four feet above maximum recorded.
 - *Admin*
- Pier 19 Bed elevation goes below 616 ft. Four feet above scour critical and 1 foot below minimum recorded.
 - *All*
- Pier 19 Bed Elevation goes below 612 ft. Scour Critical Elevation.
 - *All*
- Pier 20 Bed elevation goes above 635 ft. Four feet above maximum recorded.

- *Admin*
- Pier 20 Bed elevation goes below 625 ft. Four feet below minimum recorded.
 - *All*
- Pier 20 Bed Elevation goes below 617 ft. Scour Critical Elevation.
 - *All*
- Spanwise tilt changes +/- 0.2. Seems to be changing +/- 0.15 seasonally.
 - *Admin*
- Streamwise tilt changes +/- 0.2. Seems to be changing +/- 0.15 seasonally.
 - *Admin*
- Master Battery goes below 12 volts or above 15.5 volts. Battery discharging too low or solar panel regulator broken.
 - *Admin*
- Remote Battery goes below 12 volts or above 15.5 volts. Battery discharging too low or solar panel regulator broken.
 - *Admin*

6.3.2 Alerts from Bridge 07011

- University of Minnesota database has not updated within 3 hours. This is typically updated every half hour.
 - *Admin*
- Local waster surface elevation greater than USACE or less than two feet below USACE. *If we can bring USACE data into database.*
 - *Admin*
- Stage Exceeds 770 ft. Five feet below Bridge Scour Action Plan. This accounts for potential water surface slope through bridge section.
 - *All*
- Pier 4 Bed Elevation goes above 752 ft. Four feet above maximum recorded.
 - *Admin*
- Pier 4 Bed elevation goes below 744 ft. Four feet below minimum recorded.
 - *All*
- Pier 4 Bed Elevation goes below 733 ft. Scour Critical Elevation.
 - *All*
- FOArray(1) changes from 0
 - *All*
- FOArray(2) changes from 0
 - *All*
- TBS1Stat changes from 1
 - *All*
- TBS2Stat changes from 1
 - *All*
- MasBatt goes below 12 volts or above 15.5 volts. Battery discharging too low or solar panel regulator broken.
 - *Admin*

- RemoteBatt goes below 12 volts or above 15.5 volts. Battery discharging too low or solar panel regulator broken.
 - *Admin*

6.3.3 Modifications to Alert Systems

The alerts on the tilt sensor data on Bridge 5900 were modified due to sensor drift.

The following summarizes the original tilt warnings.

- Spanwise Tilt less than -0.05° or greater than 0.35°
 - Lueker, SAFLIT, Hendrickson, Woldeamlak
- Spanwise Tilt less than -0.25° or greater than 0.55°
 - Lenz, Waletzki, Miles
- Streamwise Tilt less than -1.5° or greater than -1.1°
 - Lueker, SAFLIT, Hendrickson, Woldeamlak
- Streamwise Tilt less than -1.7° or greater than -0.9°
 - Lenz, Waletzki, Miles

This was modified to the following after sensor drift was affecting notifications. This includes alert to the administration group if the tilts changes $\pm 0.2^\circ$ from the current nominal value and alerts the district group if tilt changes $\pm 0.4^\circ$

- Spanwise Tilt less than -0.2° or greater than 0.2°
 - Lueker, SAFLIT, Hendrickson, Woldeamlak
- Spanwise Tilt less than -0.4° or greater than 0.4°
 - Lenz, Waletzki, Miles
- Streamwise Tilt less than -1.6° or greater than -1.2°
 - Lueker, SAFLIT, Hendrickson, Woldeamlak
- Streamwise Tilt less than -1.8° or greater than -1.0°
 - Lenz, Waletzki, Miles

When the power relay is installed to relieve battery drain due to float-out receiver, additional alerts should be implemented to alert administration that the float-outs are temporarily undetectable.

7 References

- Campbell Scientific, Inc. (2013). *CR800 Measurement and Control System Manual*. Retrieved June 18, 2013, from CR800 Measurement and Control Datalogger: <http://s.campbellsci.com/documents/us/manuals/cr800-cr850.pdf>
- Campbell Scientific, Inc. (2013). "Power Supplies-Application Note." Retrieved June 25, 2014, from CR800 Measurement and Control Datalogger:<http://s.campbellsci.com/documents/us/technical-papers/pow-sup.pdf>
- ETI Instrument System , Inc. (2011). *AS-3 Scour Monitoring System for Minnesota DOT Bridge 5900 Over the Mississippi River*. Fort Collins, Co.
- ETI Instrument Systems, Inc. (2011). *AS-3 Scour Monitoring System for Minnesota DOT Bridge 07011 Over the Minnesota River*. Fort Collins, Co.
- Lueker, M. et al. (2010). *Bridge Scour Monitoring Technologies: Development of Evaluation and Selection Protocols for Application on River Bridges in Minnesota*. Report No. MnDOT. St. Paul, MN.
- Vista Engineering. (2013). *Brochures & Manuals* . Retrieved June 18, 2013, from Vista Data Vision : <http://vistadatavision.com/support/brochures-manuals/>

Appendix A
As-Built Drawings

Pier Profile from West

Downstream Pier Face

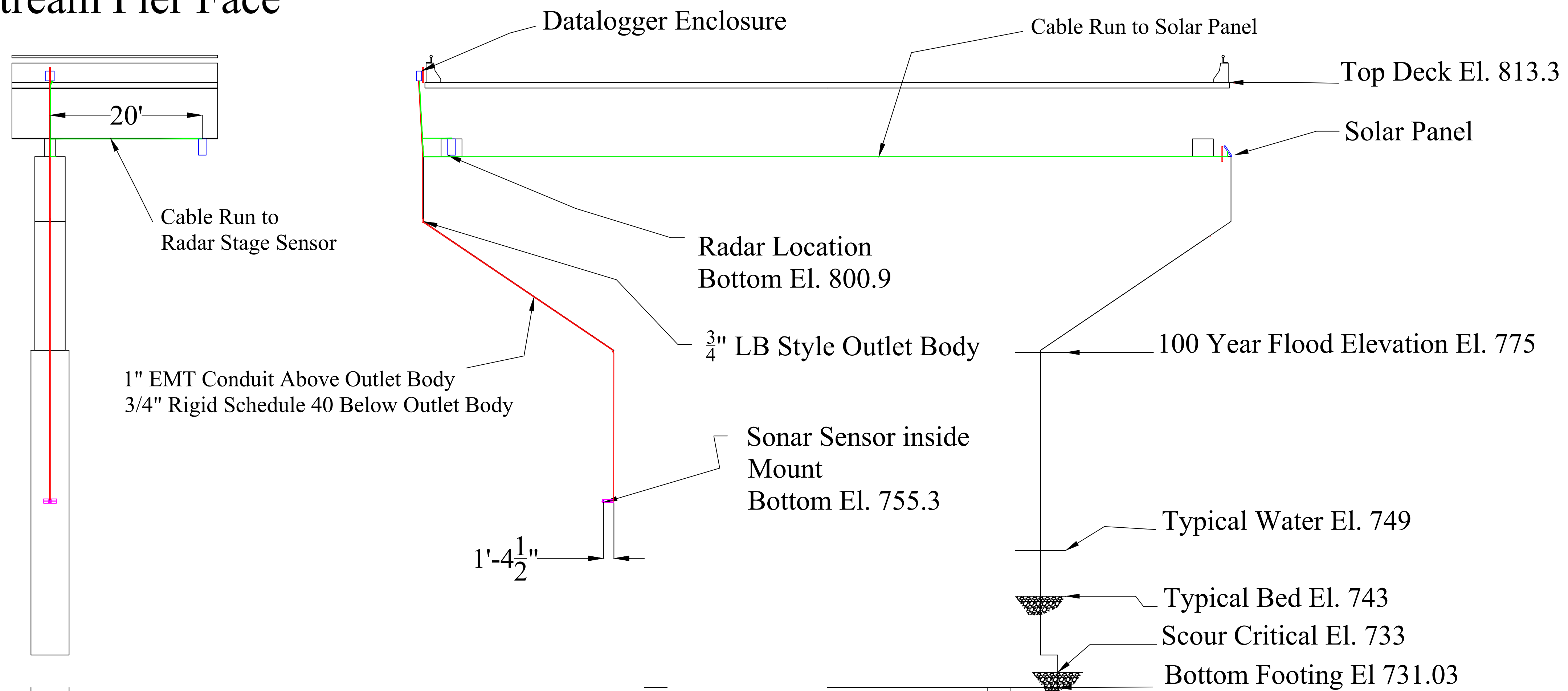

No.	Revision/Issue	Date

St. Anthony Falls Laboratory
 University of Minnesota
 2 3rd Ave SE
 Minneapolis, MN 55413
 Matt Lueker 612-626-3058

Scour Monitoring Implementation
 Mn/DOT Bridge 07011 Pier 4
 Mankato, MN
 Over Minnesota River

Project: Scour Monitoring	Sheet:
Date: 4/27/2011	
Scale: 	

Pier Profile from West

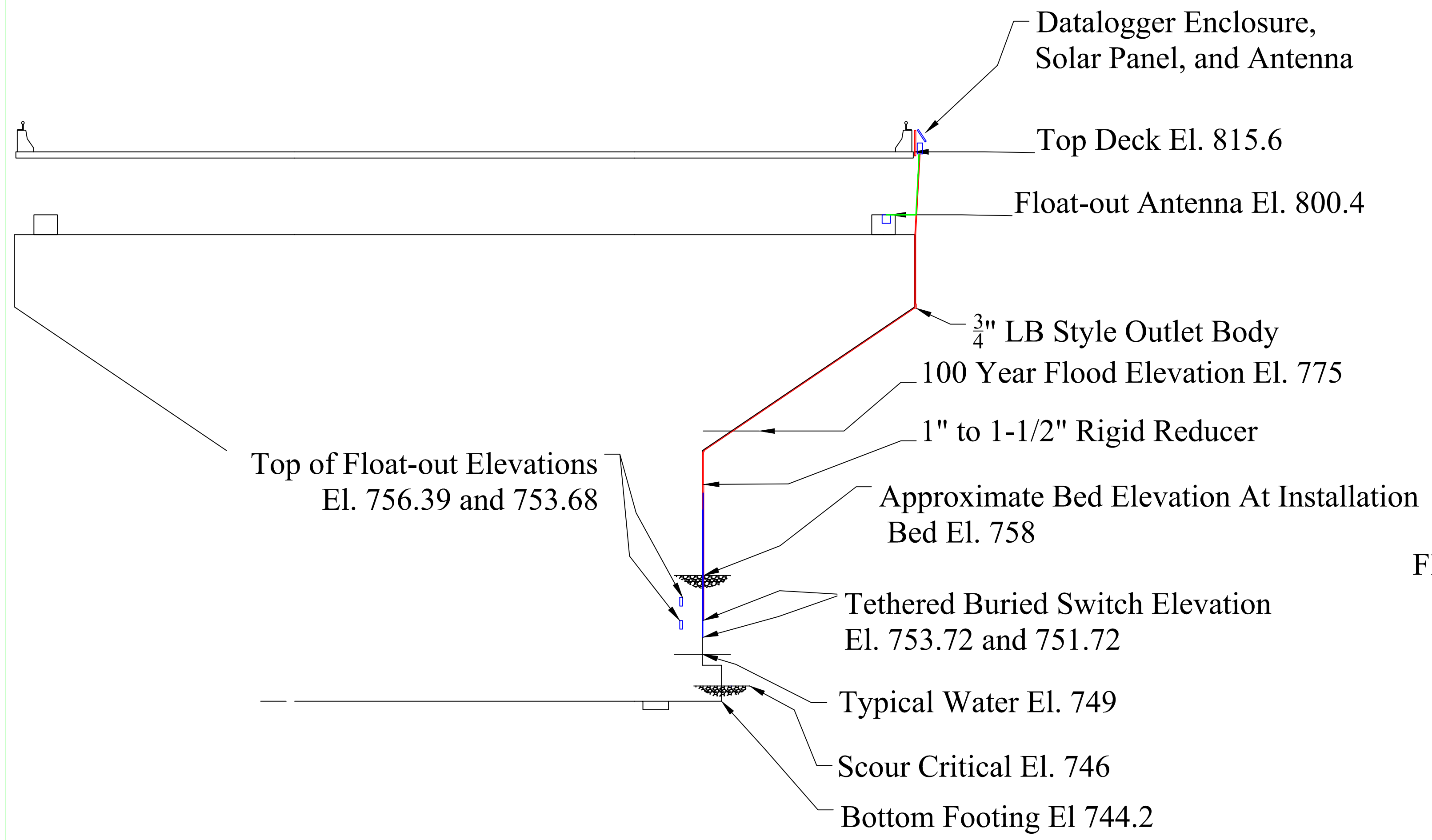

Upstream Pier Face

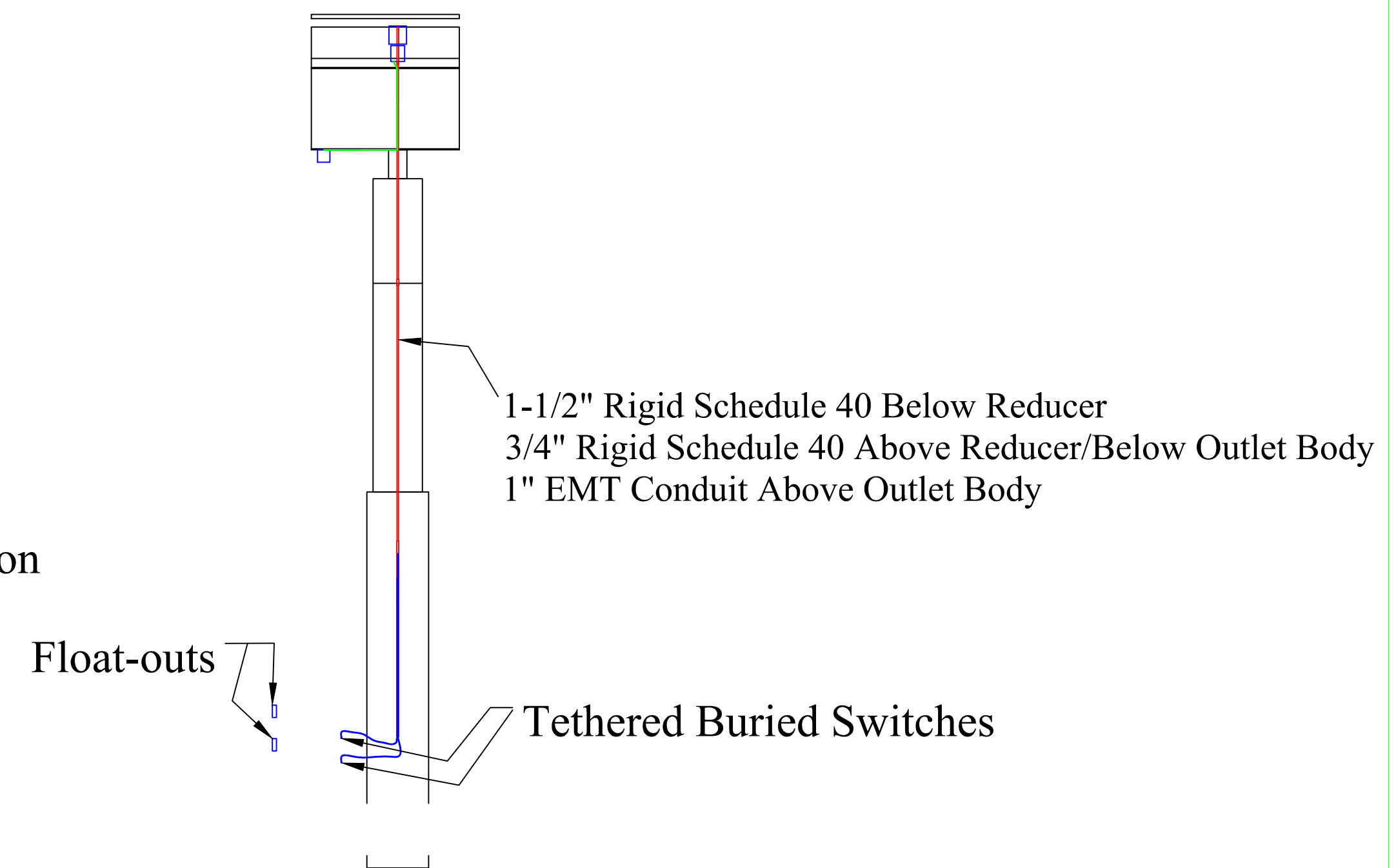

Plan View Foundation

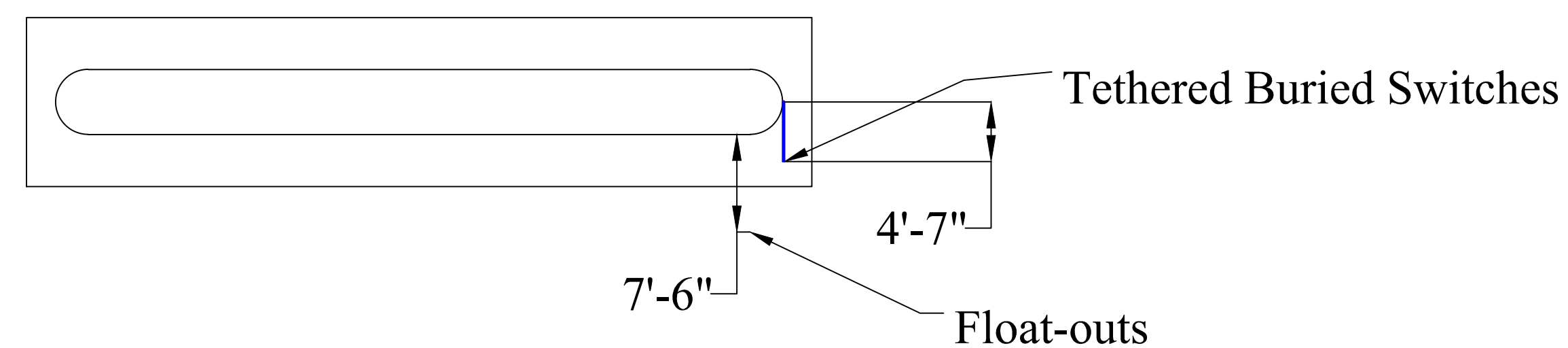

Sheet No.		
No.	Revision/Issue	Date
Firm Name and Address		
St. Anthony Falls Laboratory University of Minnesota 2 3rd Ave SE Minneapolis, MN 55413 Matt Lueker 612-626-3058		
Project Name and Address		
Scour Monitoring Implementation Mn/DOT Bridge 07011 Pier 5 Mankato, MN Over Minnesota River		
Project	Sheet	
Scour Monitoring		
Date		
4/27/2012		
Scale		

Sheet No.

Mount attached to pier using hammer drill and $\frac{1}{2}$ " concrete bolts through the four $\frac{3}{4}$ " through holes on the bent plate.

$\frac{3}{4}$ " nipple welded onto top of rectangular tubing to allow cable routing. $\frac{3}{4}$ " pipe union was used to attach conduit to mount.

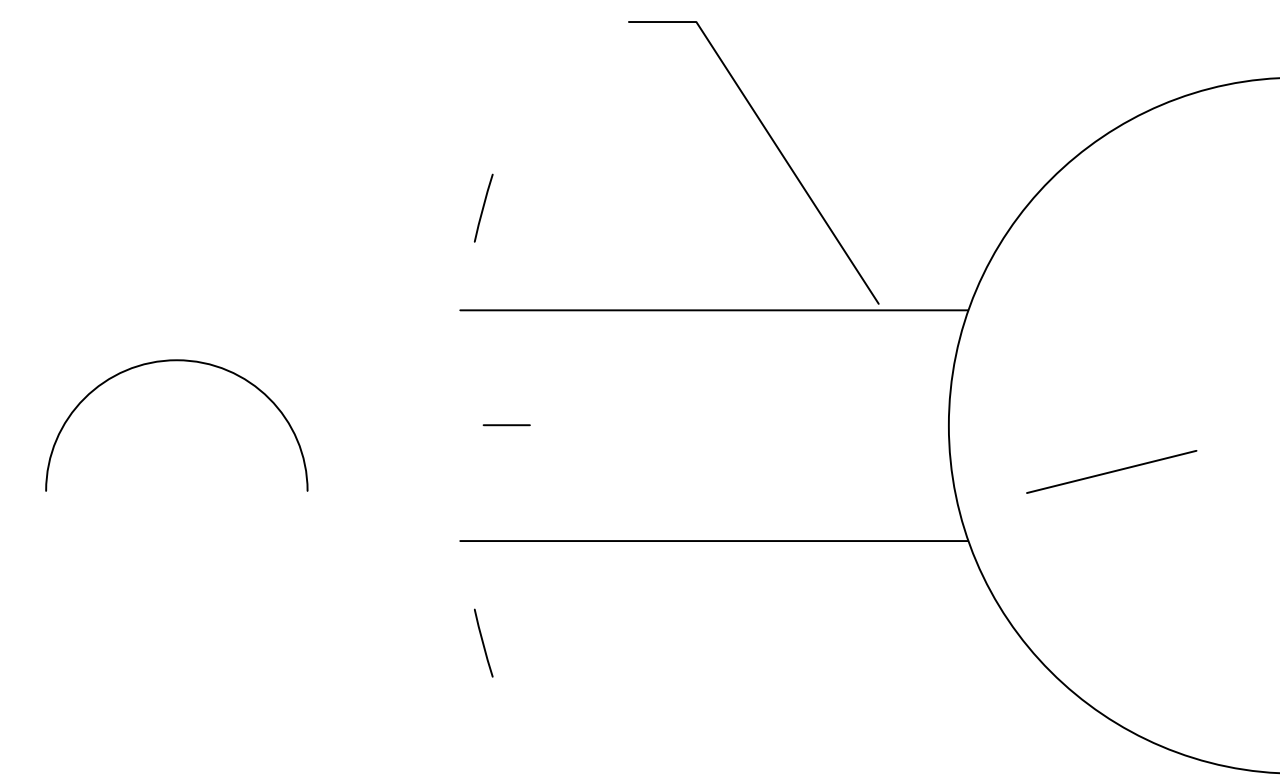
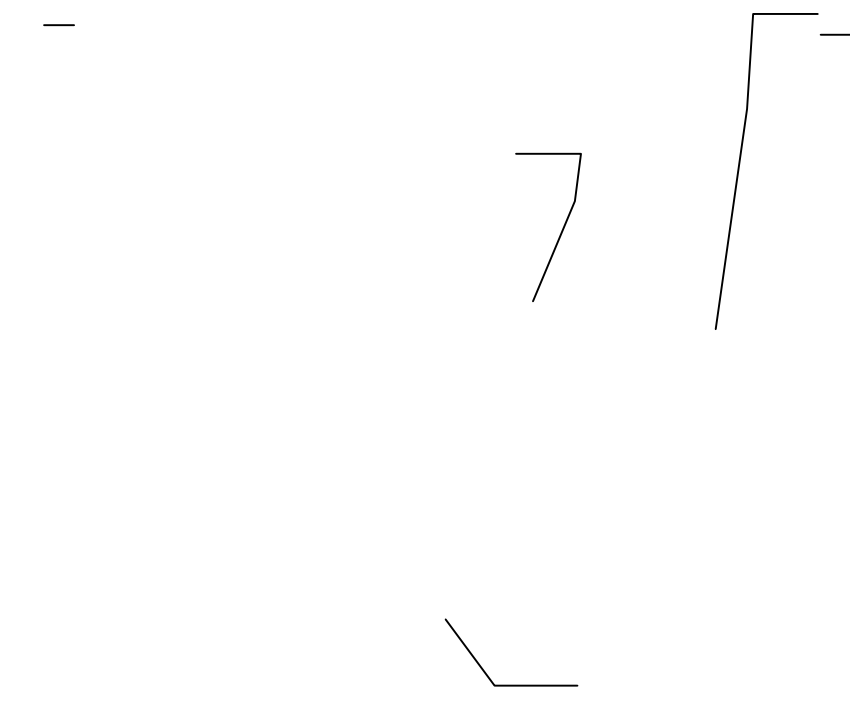
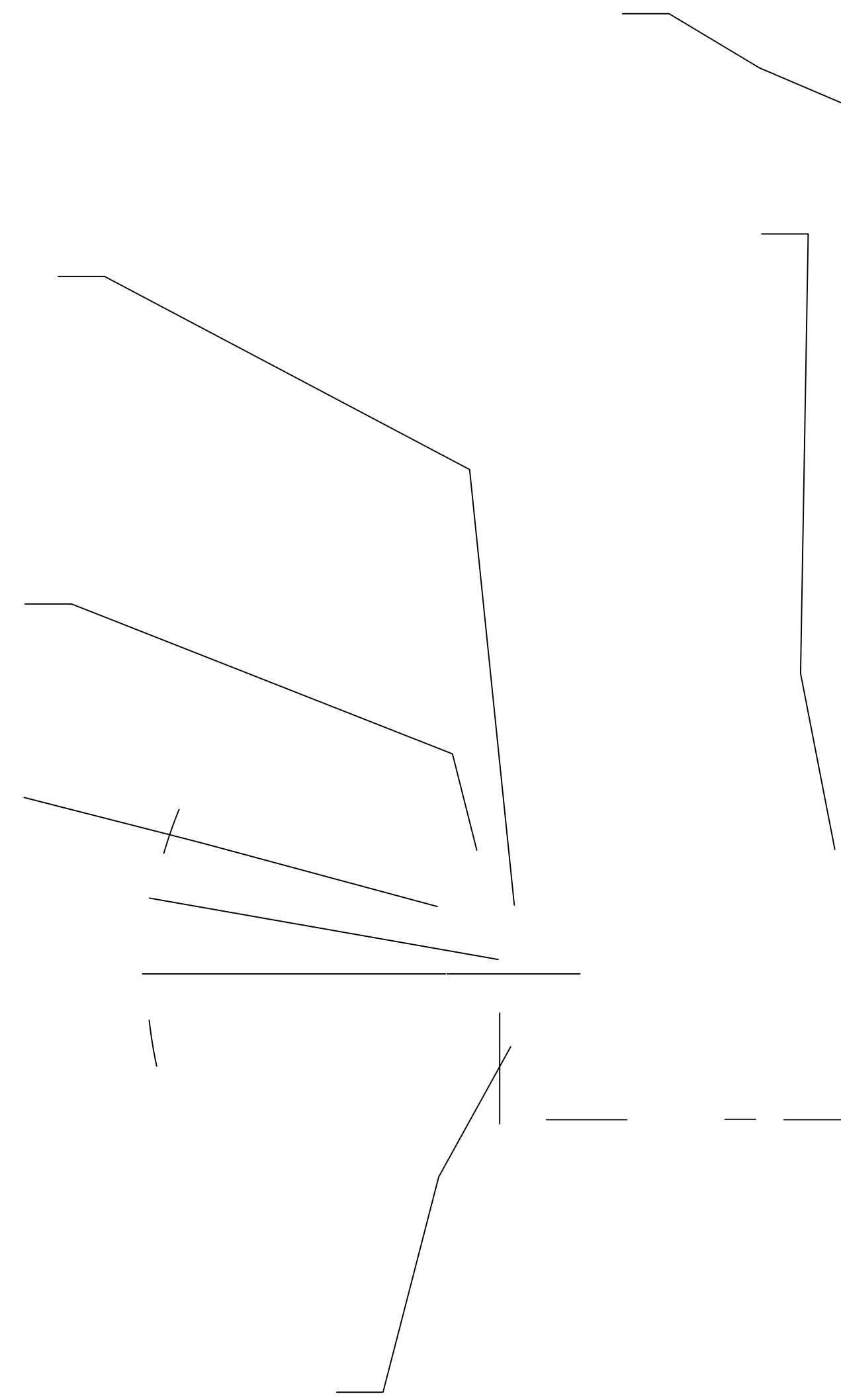

No.	Revision/Issue	Date
-----	----------------	------

Organization Name and Address
St. Anthony Falls Laboratory
University of Minnesota
2 3rd Ave SE
Minneapolis, MN 55413
Matt Lueker 612-626-3058

Project Name and Address
Pier 4 Sonar Mount
Mn/DOT Bridge 07011 Pier 5
Mankato, MN
Over Minnesota River

Project	Sheet
Scour Monitoring	
Date	
Scale	

Pier Profile from West

Downstream Pier Face

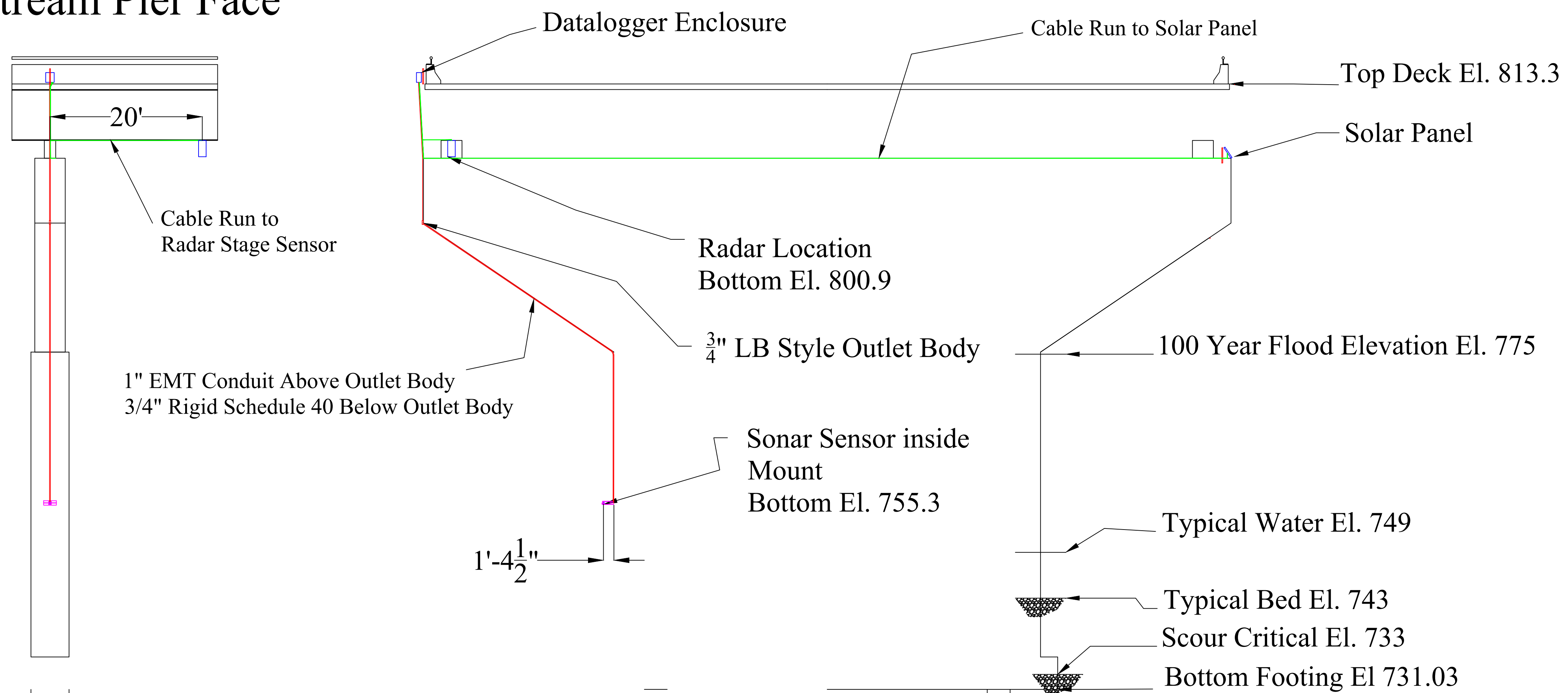

Sheet No.		
No.	Revision/Issue	Date
Author Name and Address		
St. Anthony Falls Laboratory University of Minnesota 2 3rd Ave SE Minneapolis, MN 55413 Matt Lueker 612-626-3058		
Project Name and Address		
Scour Monitoring Implementation Mn/DOT Bridge 07011 Pier 4 Mankato, MN Over Minnesota River		
Project	Sheet	
Scour Monitoring		
Date		
4/27/201		
Scale		

Pier Profile from West

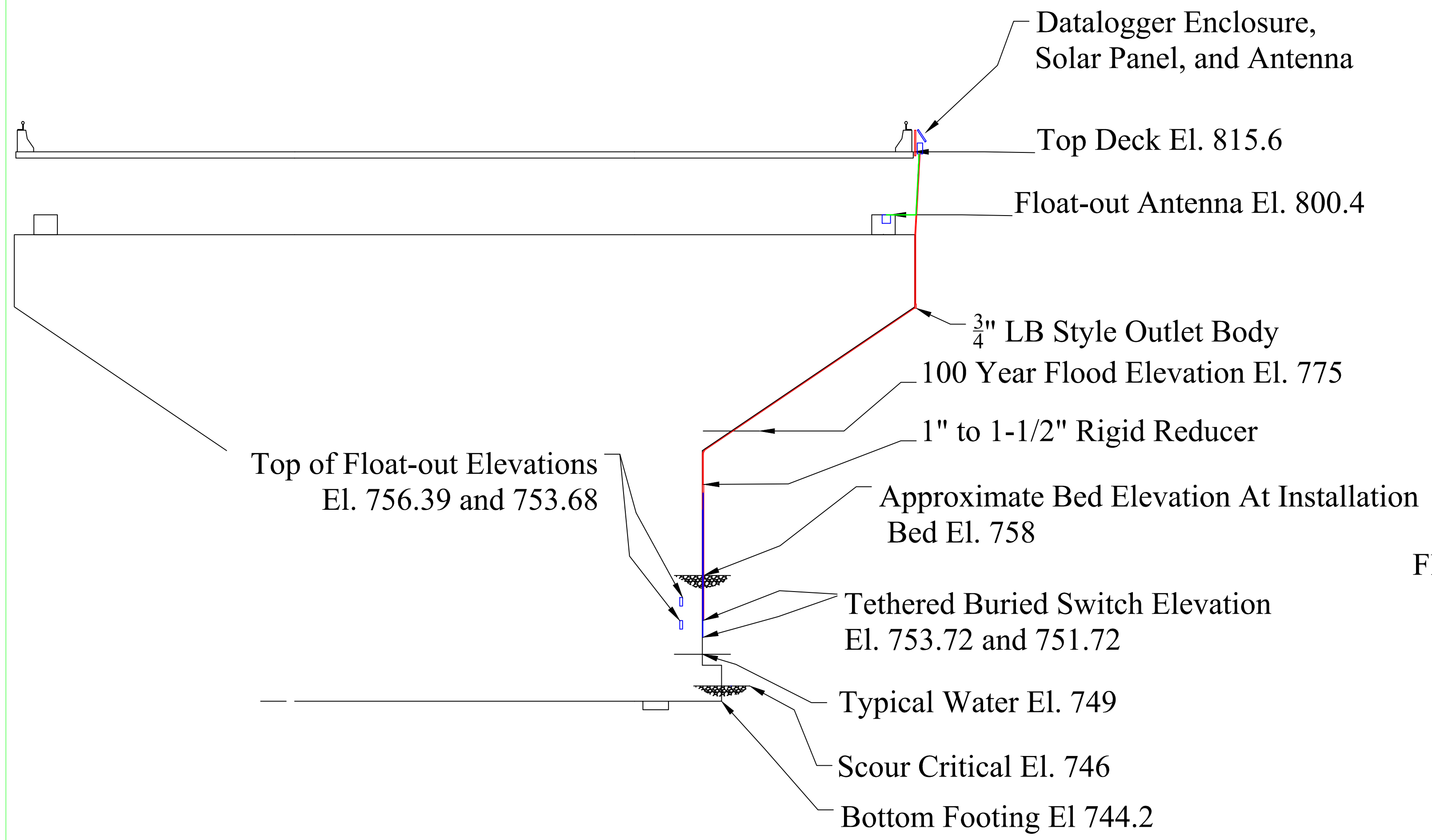

Upstream Pier Face

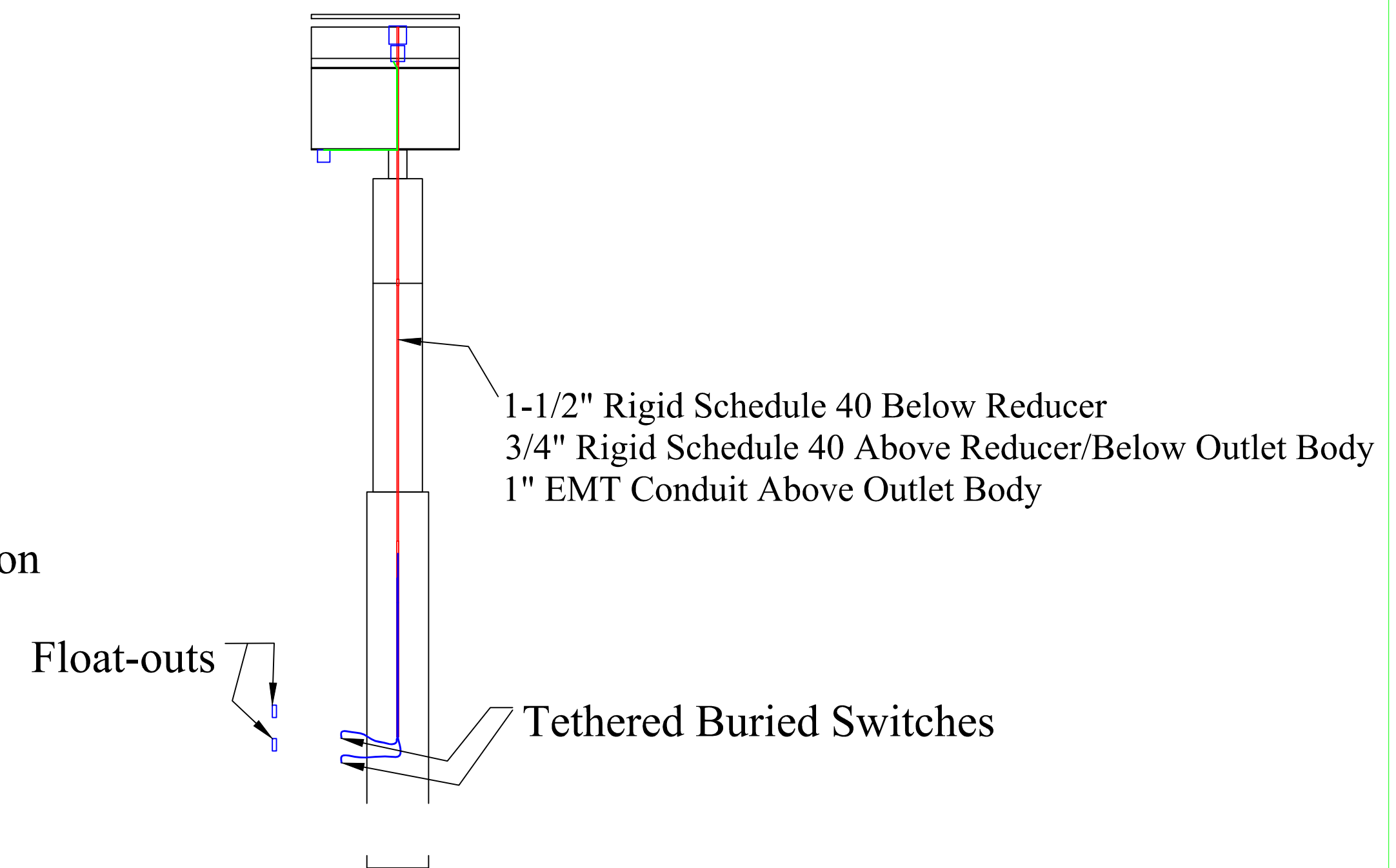

Plan View Foundation

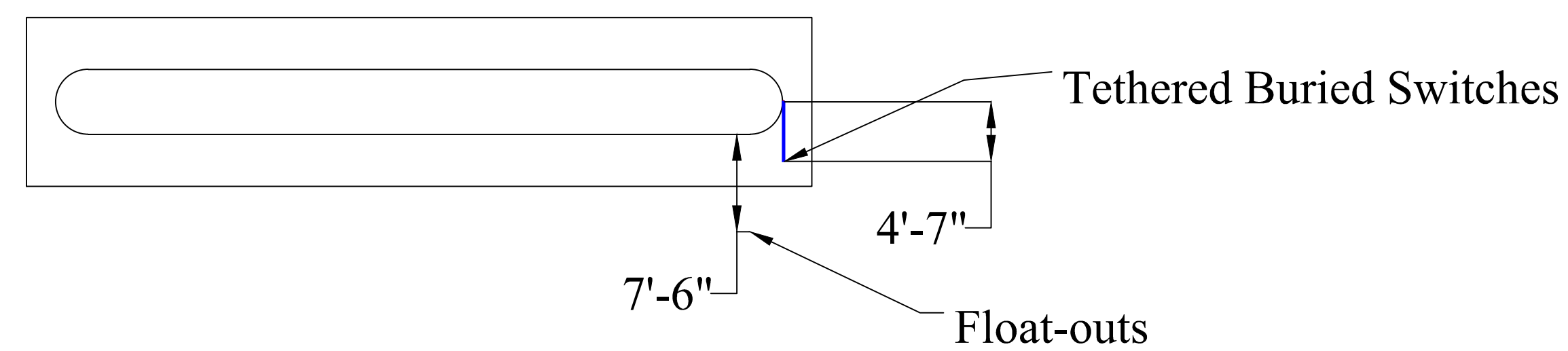

Drawing No.		
No.	Revision/Issue	Date
Firm Name and Address St. Anthony Falls Laboratory University of Minnesota 2 3rd Ave SE Minneapolis, MN 55413 Matt Lueker 612-626-3058		
Project Name and Address Scour Monitoring Implementation Mn/DOT Bridge 07011 Pier 5 Mankato, MN Over Minnesota River		
Project:	Sheet:	
Scour Monitoring		
Date:		
4/27/2012		
Scale:		

Pier Profile from East

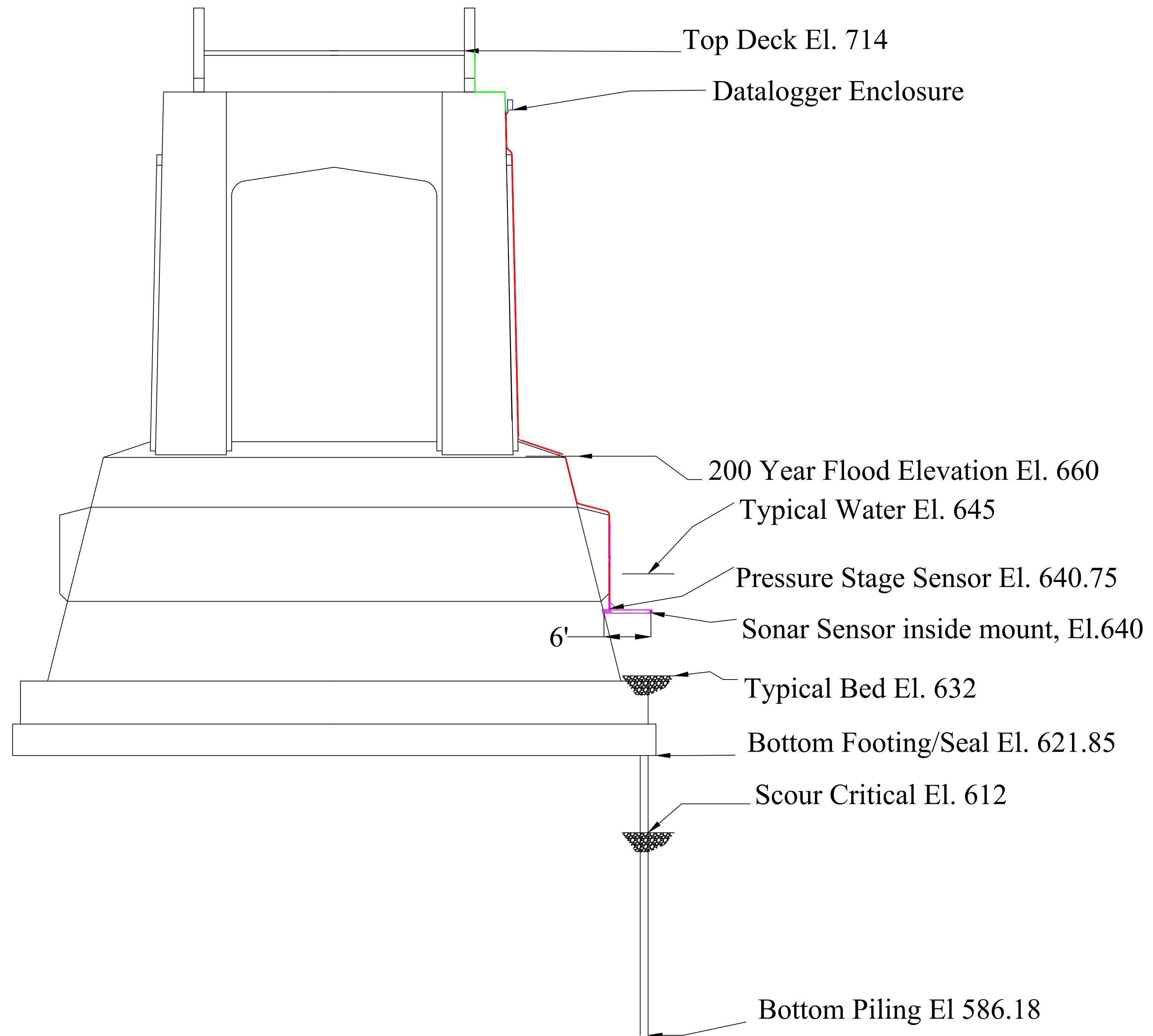

Upstream Pier Face

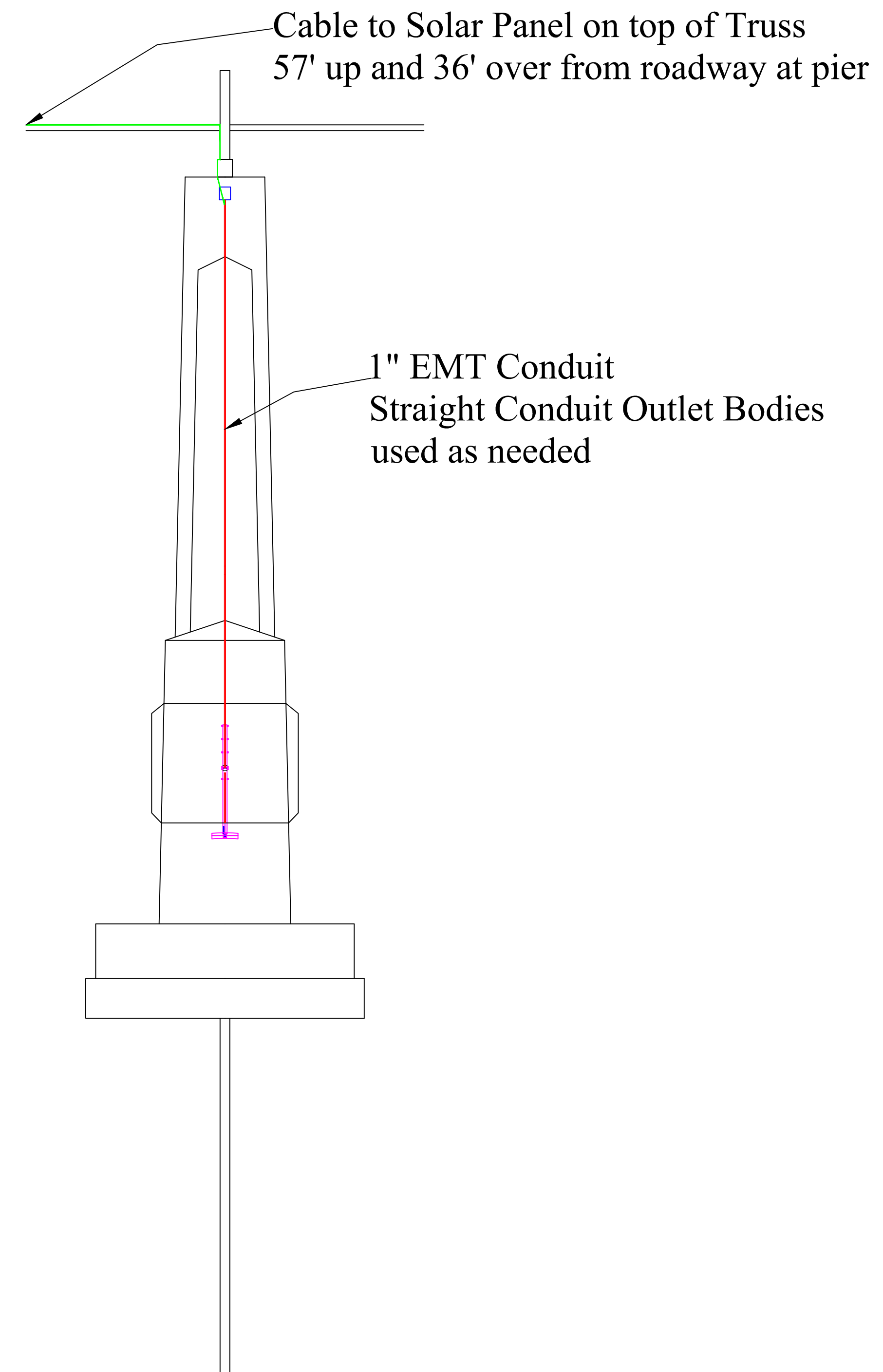

Sheet No.

No.	Revision/Issue	Date

Firm Name and Address
 St. Anthony Falls Laboratory
 University of Minnesota
 2 3rd Ave SE
 Minneapolis, MN 55414
 Matt Lueker 612-626-3058

Project Name and Address
 Scour Monitoring Implementation
 Mn/DOT Bridge 5900 Pier 19
 Winona, MN
 Over Mississippi River

Project:	Scour Monitoring	Sheet:	
Date:	4/27/2012	Scale:	

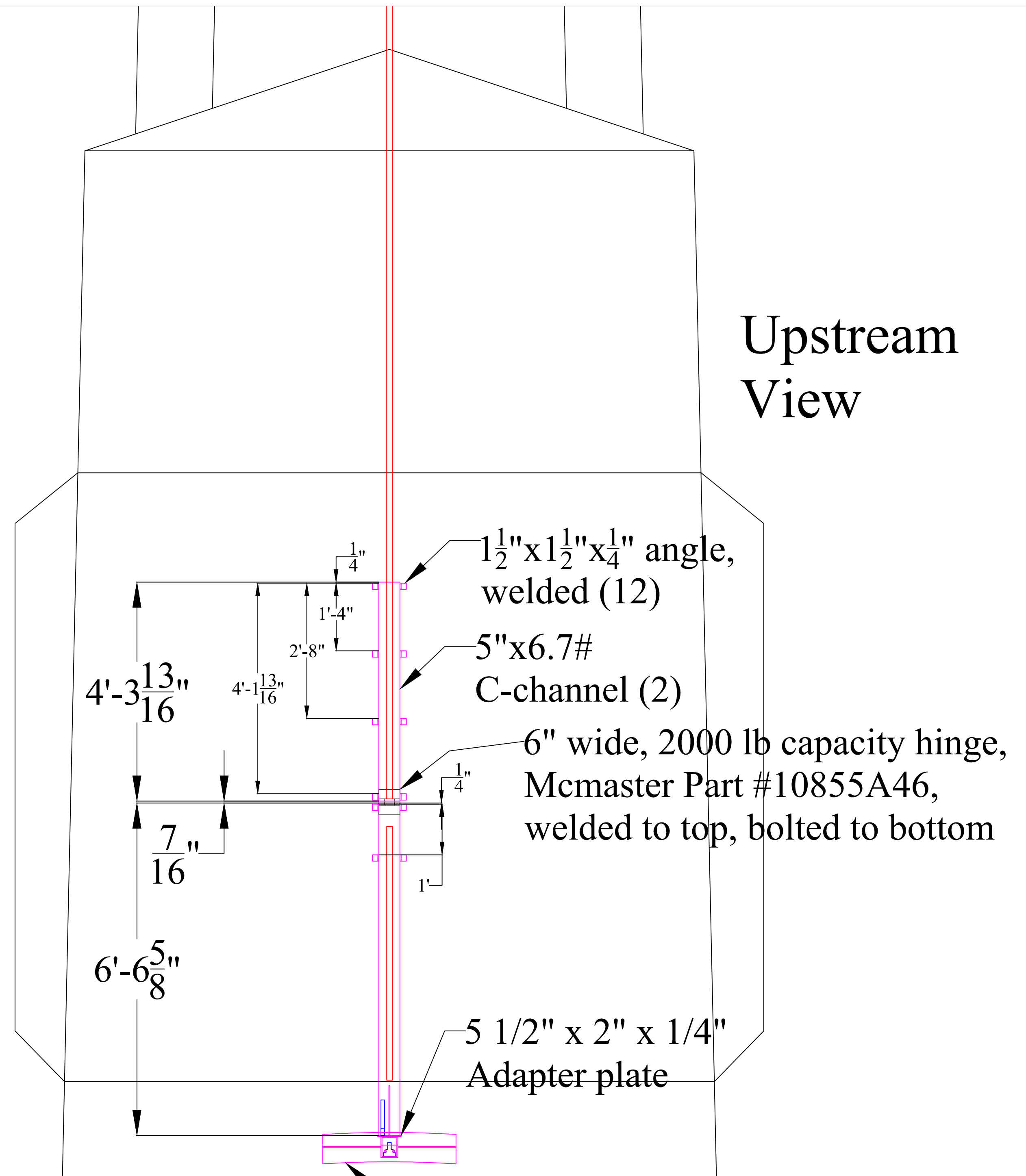
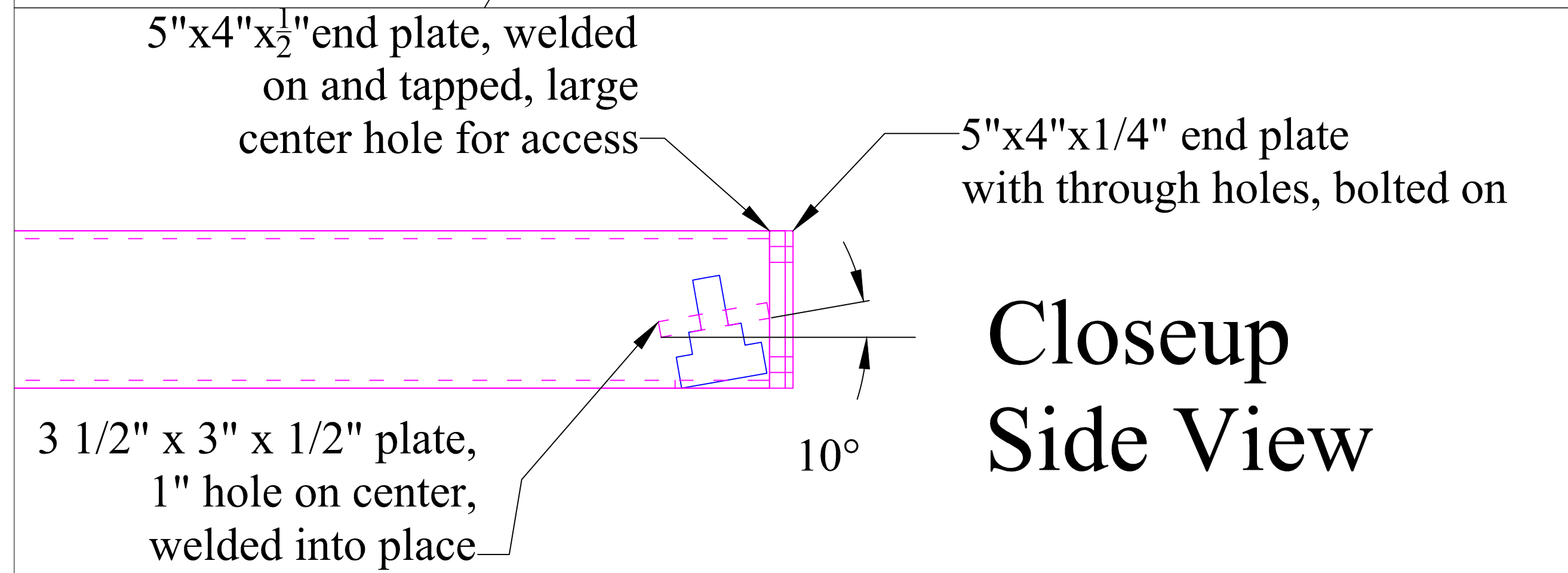
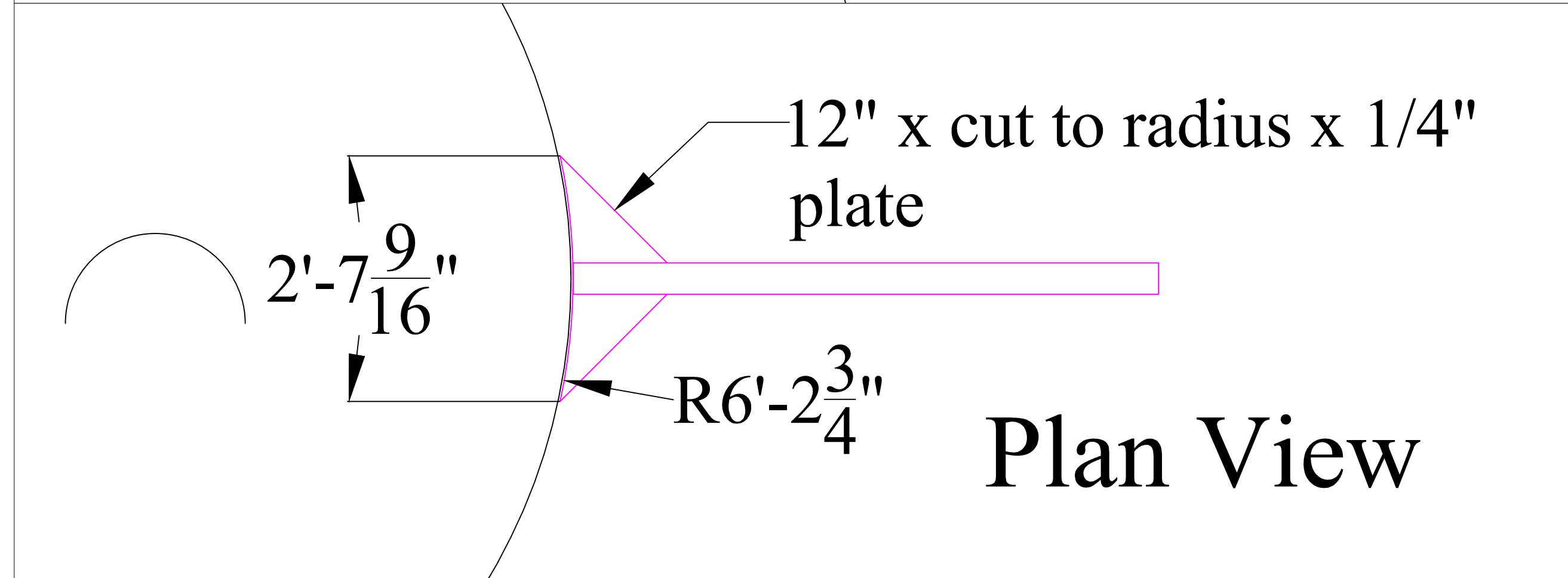
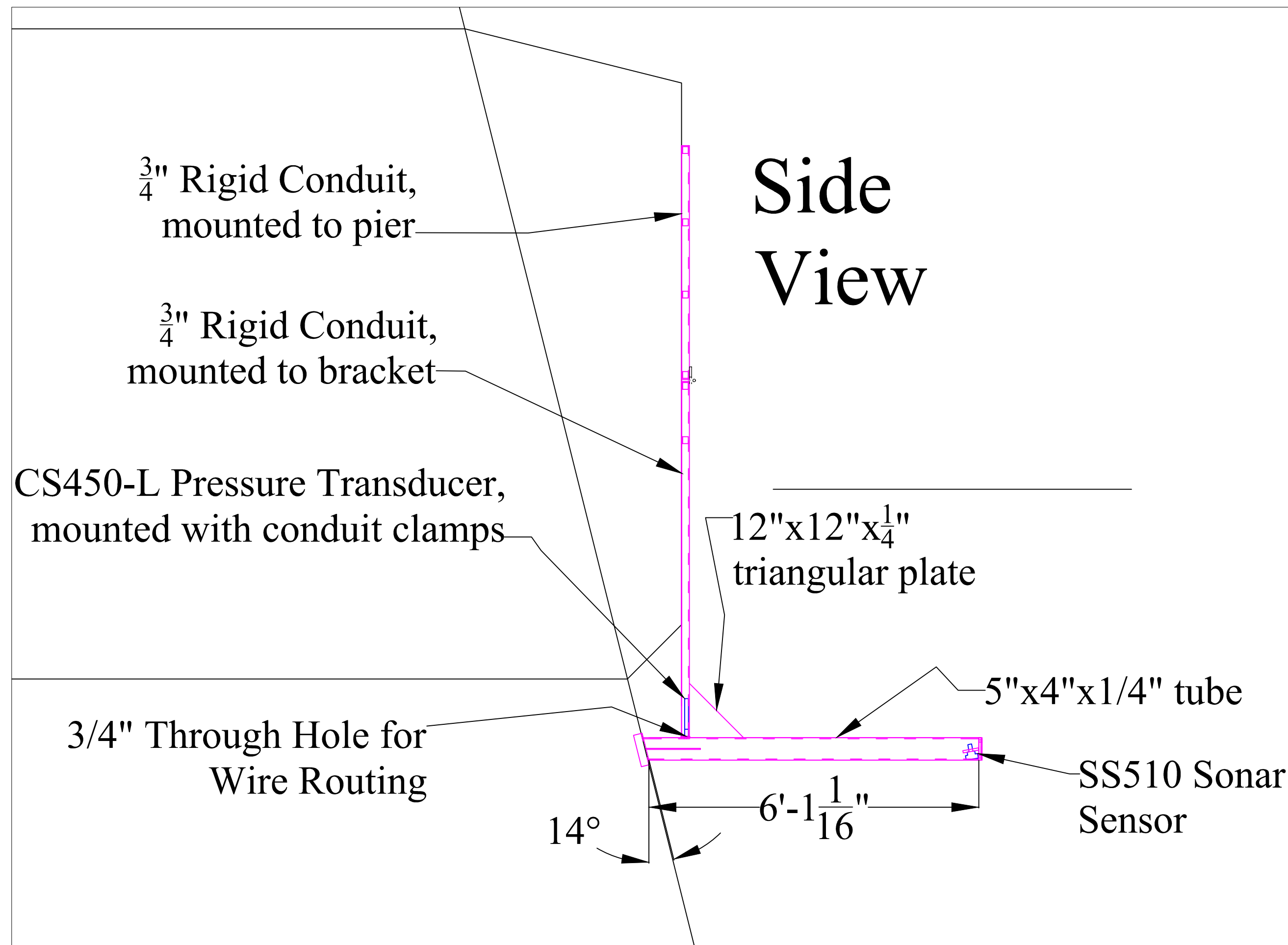

Upper portion of mount attached to pier using hammer drill and $\frac{1}{2}$ " concrete bolts (8). The $1\frac{1}{2}$ "x $1\frac{1}{2}$ "x $\frac{1}{4}$ " tabs on the c-channel have $\frac{3}{4}$ " holes drilled on center to pass the bolts through. Only the tabs on the upper portion of the mount were used.

Lower portion of mount was fastened to hinge welded to upper portion after upper portion was attached to pier.

Cables were ran through conduit before lower portion of mount was swung into place.

No.	Revision/Issue	Date

St. Anthony Falls Laboratory
University of Minnesota
2 3rd Ave SE
Minneapolis, MN 55414
Matt Lueker 612-626-3058

Pier 19 Sonar Mount
Mn/DOT Bridge 5900 Pier 20
Winona, MN
Over Mississippi River

Project: Scour Monitoring	Sheet:
Date: 4/27/2012	
Scale:	

Pier Profile from East

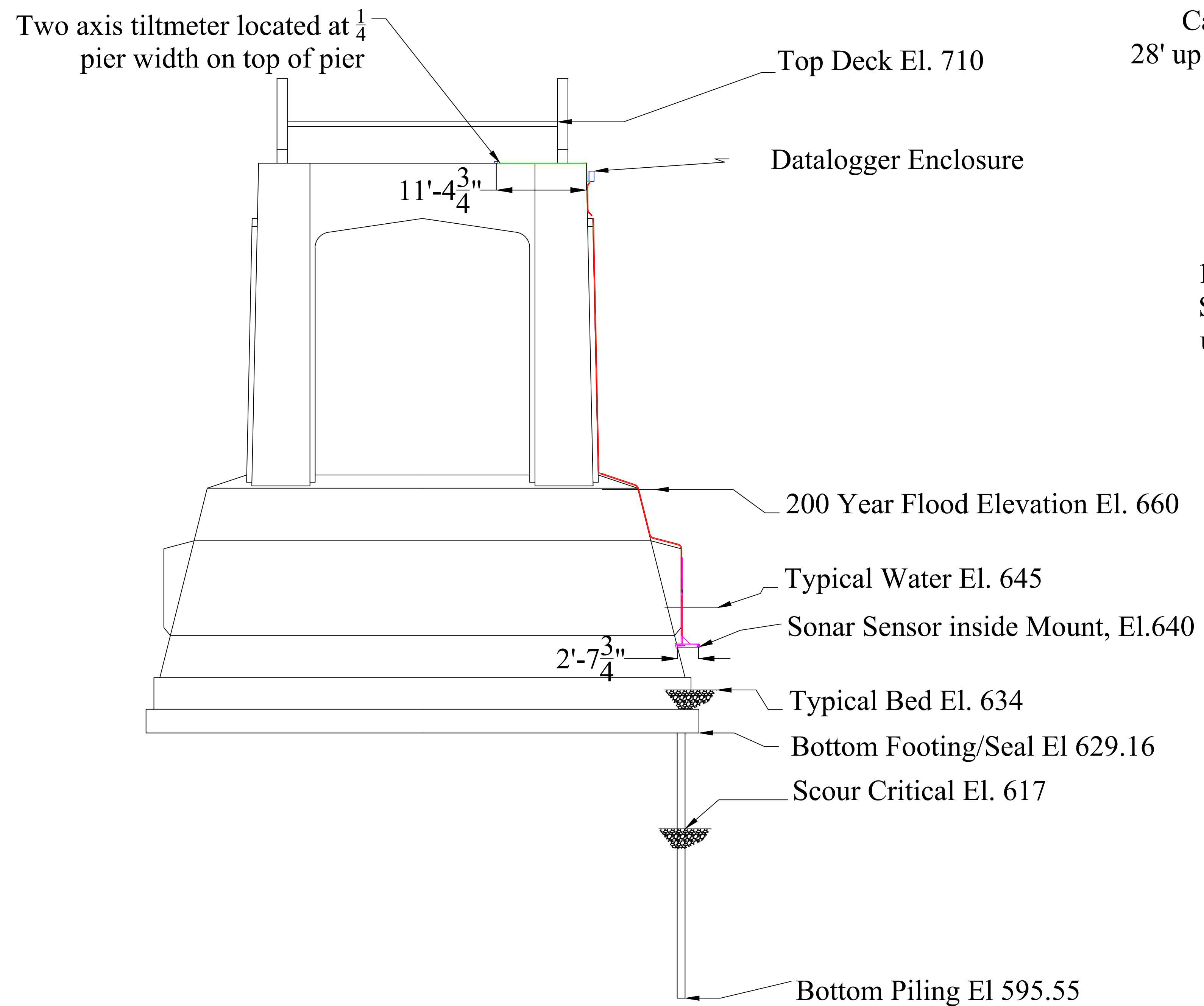

Upstream Pier Face

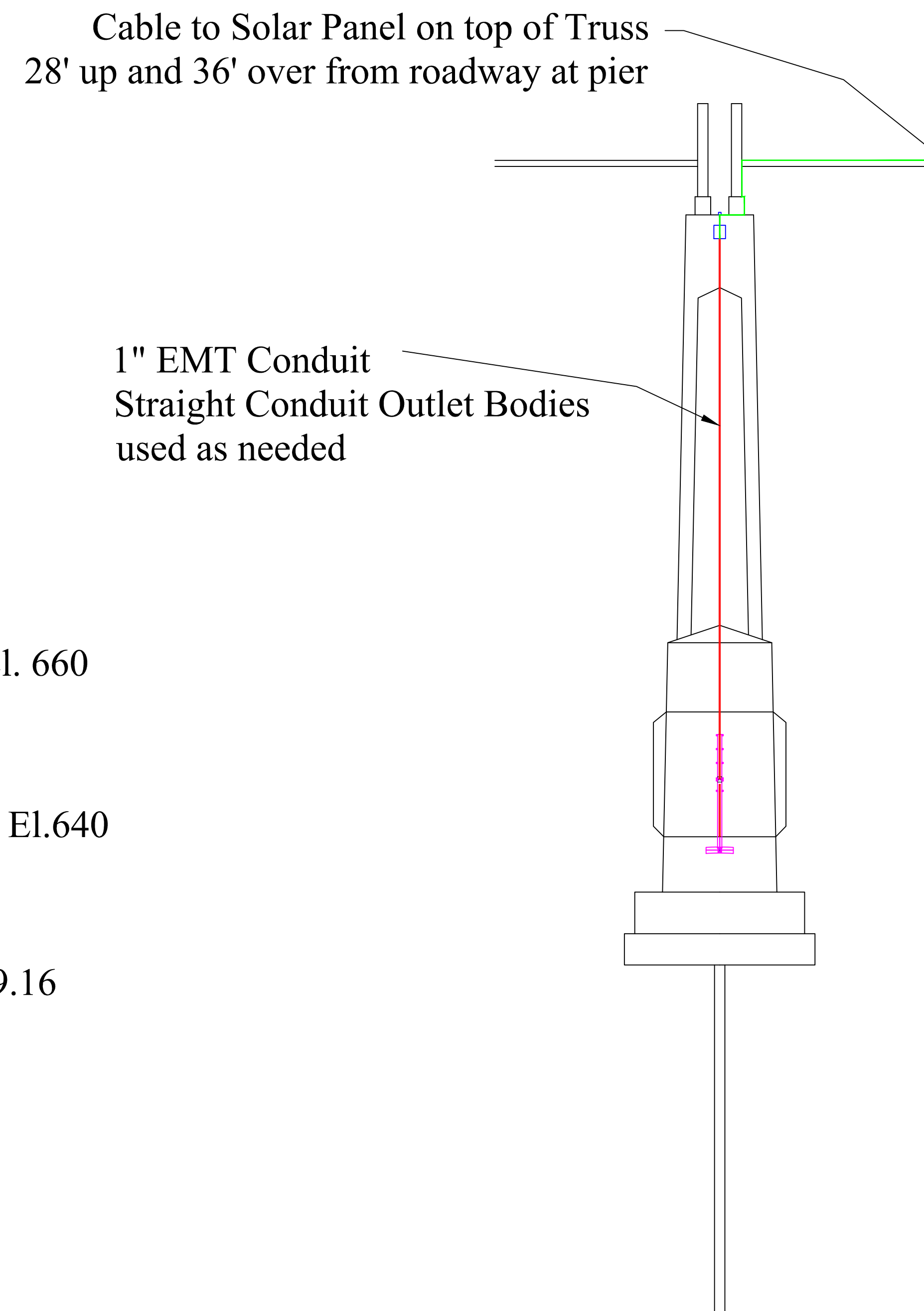

Sheet No.

No.	Revision/Issue	Date

Author Name and Address
 St. Anthony Falls Laboratory
 University of Minnesota
 2 3rd Ave SE
 Minneapolis, MN 55414
 Matt Lueker 612-626-3058

Project Name and Address
 Scour Monitoring Implementation
 Mn/DOT Bridge 5900 Pier 20
 Winona, MN
 Over Mississippi River

Project: Scour Monitoring	Sheet:
Date: 4/27/2012	
Scale:	

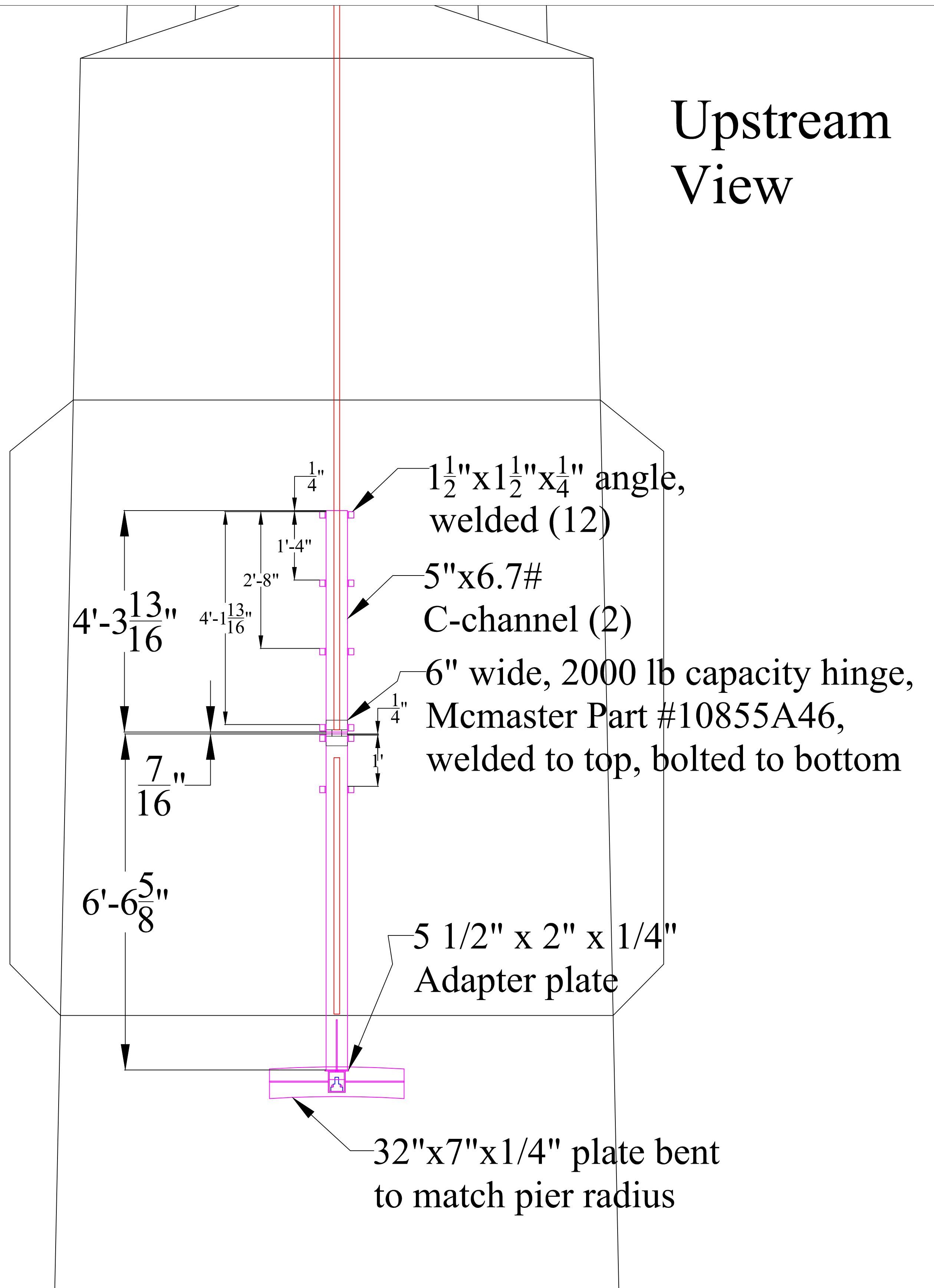
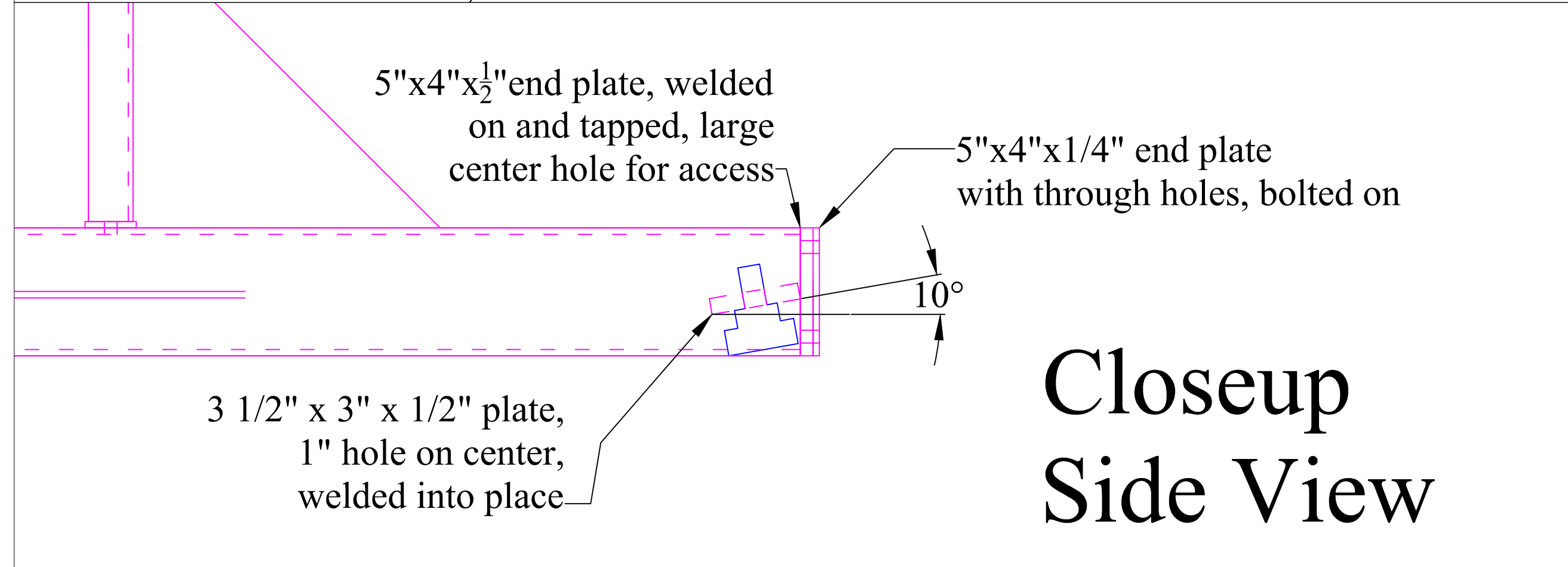
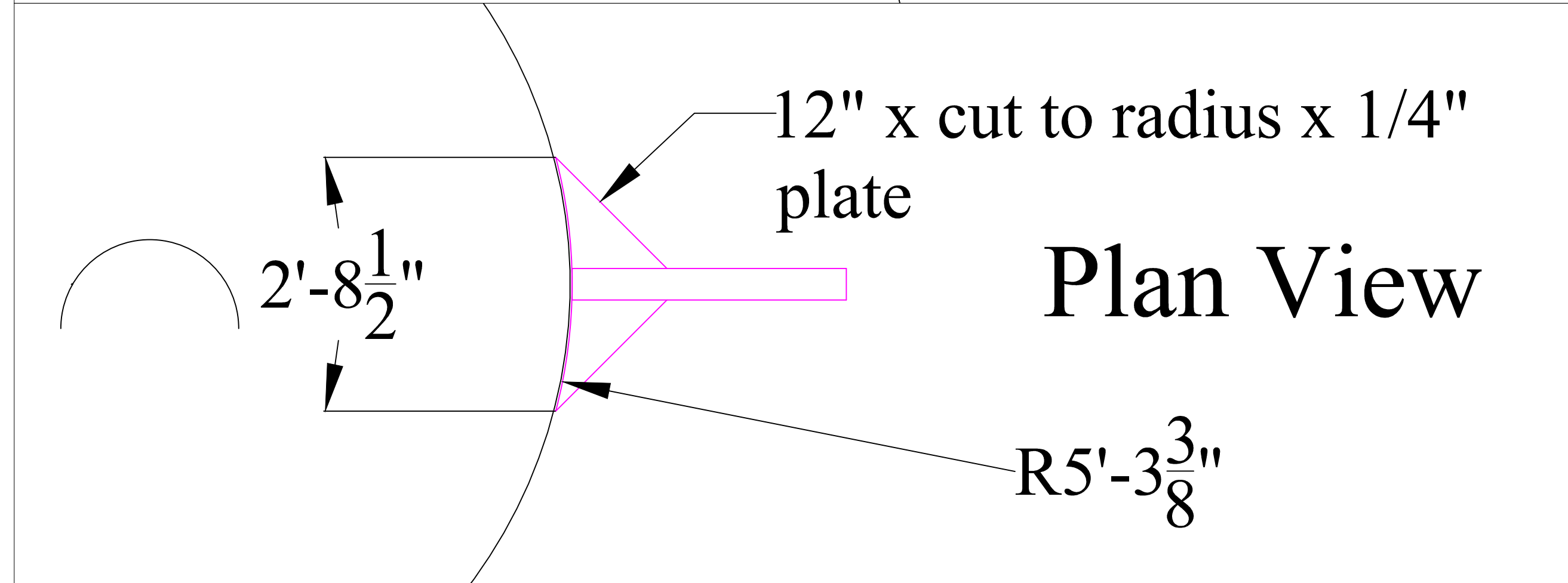
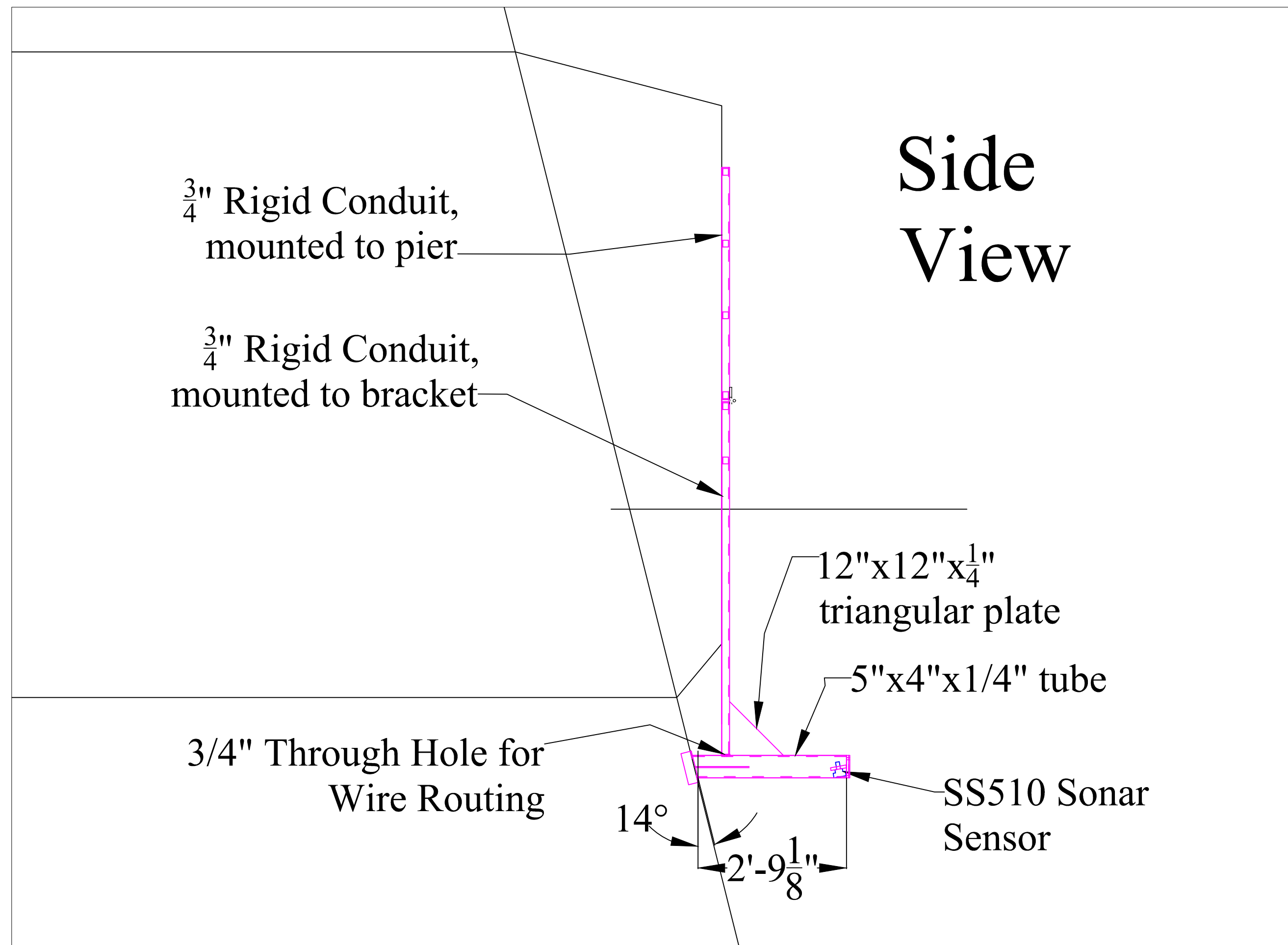

neral No.

Upper portion of mount attached to pier using hammer drill and $\frac{1}{2}$ " concrete bolts (8). The 1 $\frac{1}{2}$ "x1 $\frac{1}{2}$ "x $\frac{1}{4}$ " tabs on the c-channel have 3/4" holes drilled on center to pass the bolts through. Only the tabs on the upper portion of the mount were used.

Lower portion of mount was fastened to hinge welded to upper portion after upper portion was attached to pier.

Cables were ran through conduit before lower portion of mount was swung into place.

No.	Revision/Issue	Date

-firm Name and -address

St. Anthony Falls Laboratory
University of Minnesota
2 3rd Ave SE
Minneapolis, MN 55414
Matt Lueker 612-626-3058

Project Name and -address

Pier 20 Sonar Mount
Mn/DOT Bridge 5900 Pier 20
Winona, MN
Over Mississippi River

Project: Scour Monitoring	Sheet:
Date: 4/27/2012	
Scale:	

Appendix B
System Manuals

TECHNICAL MANUAL

AS-3 Scour Monitoring System

*With Sonar, Stage, Floatout
and Tethered Buried Sensors*

Configured for the Minnesota Department of Transportation
For Installation on the MNDOT Bridge 07011 Over the Minnesota River



INSTRUMENT SYSTEMS INC.

Scour Measurement Systems
1317 Webster Avenue
Fort Collins, Colorado 80524
(970) 484-9393
eti@etisensors.com

AS-3 Floatout System Technical Manual

Table of Contents

Section	Title	Page
1	Description	1
	1.1 General	1
	1.2 Major Components	2
2	Installation	5
	2.1 Preparing the Floatout Devices for Installation	5
	2.2 Installing the Solar Panel and AS-3 Equipment Enclosure	7
	2.3 Installing the Sonar Sensor	8
	2.4 Installing the Stage Transducer	8
	2.5 Installing the Tethered Buried Switches	8
	2.6 Wiring Connections that Must be Done at the Site	9
3	System Operation	12
	3.1 Normal System Operation	12
	3.2 System Operation if an Alert Condition is Observed	12
	3.3 Data Record Format	14
	3.4 Email Addresses Where Data is Sent	14
	3.5 Weekly Email Status Message	15
4	Maintenance and Troubleshooting	16

Section 1

DESCRIPTION

1.1 General

ETI has configured a bridge scour monitoring system for the Minnesota Department of Transportation. The system, installed on Bridge 07011 over the Minnesota River, consists of four different types of sensors, each measuring unique aspects of streambed stability. These sensors include:

1. Two floatout sensors buried in position in the streambed adjacent to the bridge's piers. Should flood water scour away the streambed holding the floatout in place, the floatout will be released and activated as it floats to the surface, transmitting a unique digitally encoded signal. A wireless floatout receiver on the bridge receives the signal, decodes it, and formats the data for transmission via a digital cellular modem.
2. Two tethered buried switches. These devices also are buried adjacent to the bridge's piers and become when released from the streambed by scour. Being tethered, they are hardwired to the AS-3's electronics.
3. A sonar device that measures the distance from the sonar transducer to the streambed. Because the transducer elevation is known, the elevation of the streambed is obtained by subtracting the measured distance from the transducer to the streambed from the elevation of the transducer.
4. A stream stage measuring device that measures the distance from the stream stage sensor to the surface of the stream. Because the elevation of the stage sensor is known, the elevation of the stream surface is obtained by adding the measured distance from the stage sensor to the stream surface to the elevation of stage sensor.

The AS-3 sends alert emails to select bridge personnel should a sensor detect a suspect scour condition. To provide assurance that the AS-3 is healthy and working properly, the system also sends weekly emails with the temperature and battery voltage.

The AS-3 is one of a family of bridge scour measurement systems designed and distributed by ETI Scour Measurement Systems that accommodate a variety of requirements and environments.

Should one of the system's sensors become active as a result of scour, the system's digital cellular modem is powered up for 60 minutes. The status of the system's sensors can be observed at that time by accessing the system via the Internet URL address described in Section 3.2.

1.2 Major Components

Major components of the AS-3 Scour Monitor installation include:

- A. ***A Master Station*** that houses the electronics that monitor the floatout sensors and the tethered buried switches. It also communicates wirelessly with the Remote Unit and sends emails to designated bridge personnel. The Master Station includes:
 - 1. Electronics to monitor the two floatout sensors. Each floatout has onboard electronics, a battery, and a wireless data link transmitter.
 - 2. A CR800 datalogger that controls the sensors, records and formats the data, and controls the transmission of alert (and weekly) emails..
 - 3. A wireless data link receiver to receive the floatout sensors' signals.
 - 4. A wireless data link receiver to communicate with the Remote Unit.
 - 5. A 20-watt solar panel and 12v battery.
 - 6. A Raven X digital cellular modem for transmitting emails and website data.
 - 7. A weatherproof electronics enclosure that houses the electronics and power supply.

- B. ***A Remote Unit*** with electronics that control a sonar sensor and the stream stage sensor. It formats the data from these sensors for transmission to the Master Station. The Remote Unit includes:
 - 1. A CR800 datalogger that controls the sonar and stage sensors, records and formats the data for transmission to the Master Station.
 - 2. A sonar sensor and cabling hardwired to the datalogger.
 - 3. A stream stage sensor and cabling hardwired to the datalogger.
 - 4. A wireless data link receiver to communicate with the Master Station.
 - 5. A 20-watt solar panel and 12v battery.
 - 6. A weatherproof electronics enclosure that houses the electronics and power supply.

The photograph below shows the Master Station and components.

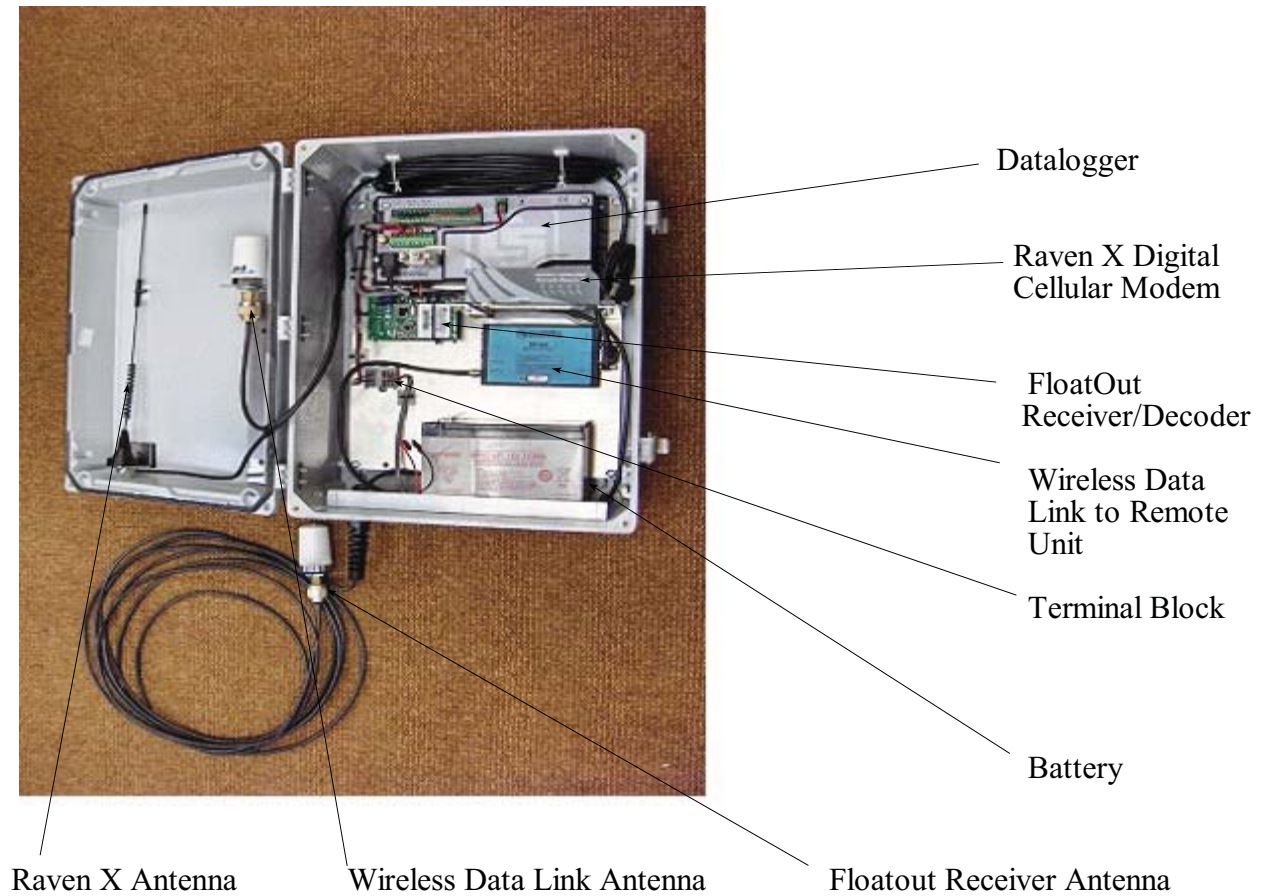

The photograph below shows the Remote Unit and components.

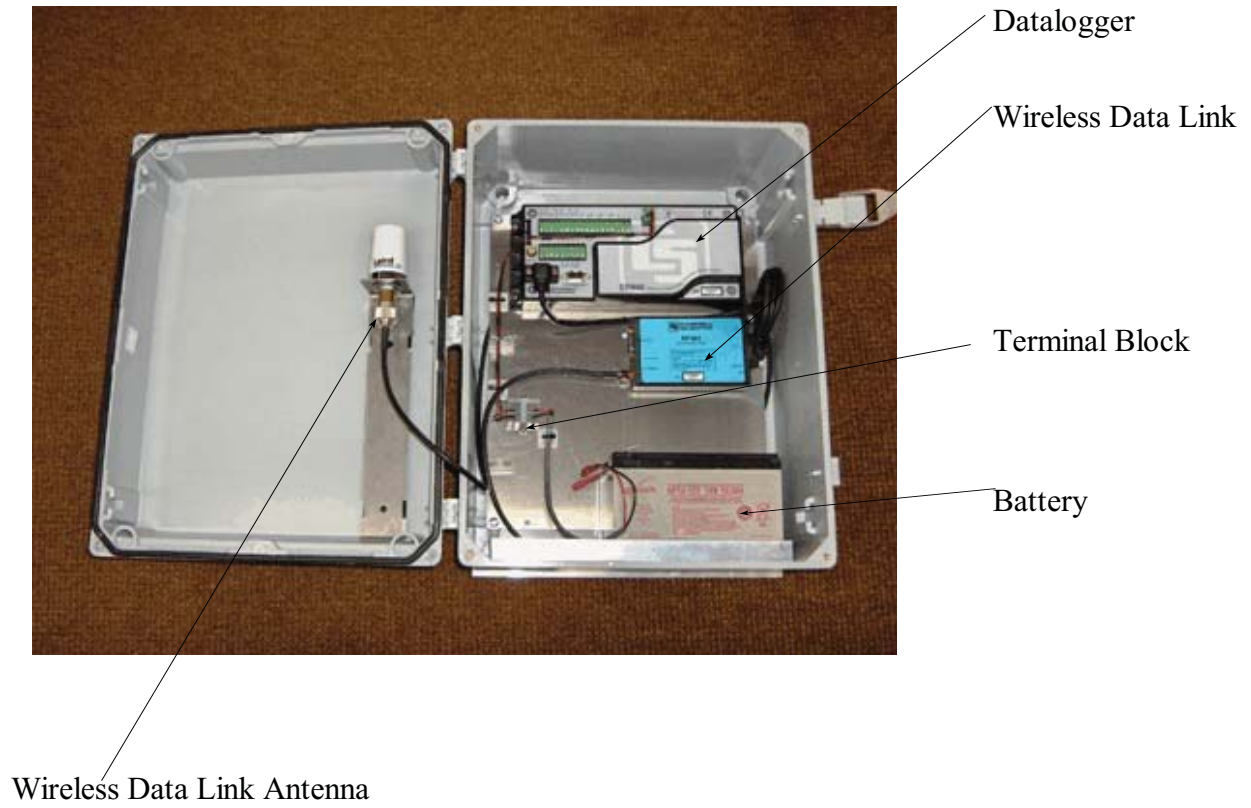

Section 2

INSTALLATION

2.1 Preparing the Floatout Devices for Installation in the Streambed

Note: Before proceeding to the site to install the sensors, obtain a tube of Pipe Joint Compound with PTFE (for PVC pipe) to seal the threads on the provided threaded plugs.

The floatouts are numbered 1 and 2, and are to be installed in the locations defined by the site engineer. Each floatout is marked to indicate “ACTIVE” and “INACTIVE” orientation.

The floatout sensors are to be installed as follows:

Sensor Number	Location
1	(Determined by customer)
2	(Determined by customer)

The floatout sensors are configured with an internal counterweight. The counterweight enables the floatout to rotate to the proper orientation to activate the digital data transmitter when scoured out from the streambed.

In the below left photograph, the sensor number and the words **NOT ACTIVE** are shown. This indicates that the sensor is in the orientation that *prevents* activating the transmitter. The photo on the right shows the opposite side sensor orientation with **ACTIVE** that *activates* the transmitter.



The floatout sensors are shipped with two red wires extending from the end of the sensor to prevent activation during shipping and draining the internal battery. Wire nuts have been provided to connect the red wires when ready for installation.

Do not connect the red wires until they are ready to be installed!

When ready to activate, place the floatout with the **NOT ACTIVE** markings *up*, or keep it vertically with the plug at the top, then twist the red wires together and put the wire nut on. Then insert the wires back into the floatout’s threaded hole.

The threaded plug is to seal the floatout sensor after the connected wires have been inserted

into the floatout housing. Apply the pipe joint compound to the threads on the threaded plug, and thread the plug into the housing. Tighten the plug with a box-end wrench, ensuring that the plug is tight.

The floatout is counter-weighted such that it will roll over with the **ACTIVE** side up when floating free. This activates the electronics to transmit the sensor's unique digital code.

The photograph below shows the sensor's wires, wire nut, and the plug that prepare the sensor for deployment into the streambed.



Warning:

*When the wires are attached with wire nuts, and the sensor is in a horizontal position with the **ACTIVE** side up, the sensor is transmitting its digitally coded signal. It is also draining the internal battery while transmitting. Therefore, keep the sensor in a vertical orientation with the plug at the top, or with the **NOT ACTIVE** position up after the wires are connected.*

Once the wires have been connected, the floatout must be kept in a vertical orientation or positioned so that the **NOT ACTIVE** marking is in the full upright position.

When placing the floatout, again make sure that it will *remain* in a vertical orientation! The unit is buoyant and will attempt to roll horizontally over to the **ACTIVE** position and float out.

Make sure there is enough material on top to keep the floatout in place. Then hand-place some riprap over it. This will protect the floatout from the remaining riprap being dumped from the barge. Otherwise, the riprap from the barge could possibly displace the floatout from the streambed.

2.2 Installing the Solar Panels and the AS-3 Equipment Enclosures

Mounting of these components is left to the discretion of the contractor charged with installation. Special considerations are as follows:

- a. Mount the solar panel with as much southern exposure as possible to maximize solar radiation reception, either above or below enclosure. See mounting options in photos below.
- b. Mount the equipment enclosure on the downstream side of the bridge to maximize reception of signals from activated float outs as they float downstream.

The photographs below show views of the solar panel, enclosures, and mounting brackets.

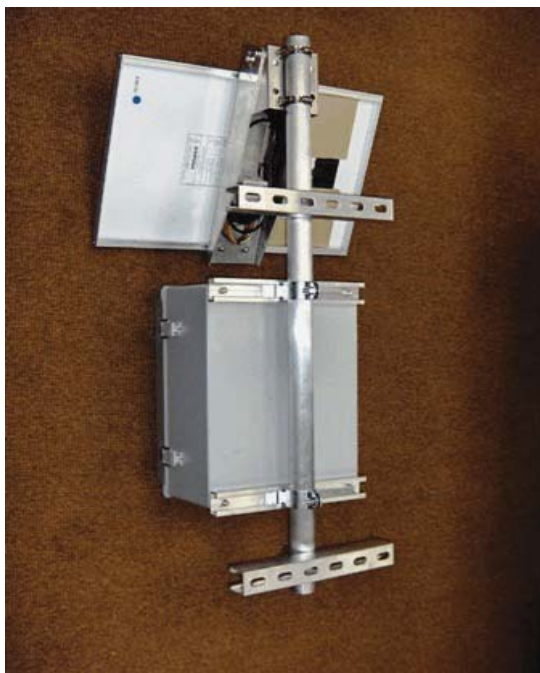

Solar Panel Mounted Above Enclosure



Solar Panel Mounted Below Enclosure

2.3 Installing the Sonar Sensors

The sonar transducer must be mounted in a sturdy housing to protect it from ice and debris. The housing must be located out from the pier so that the sonar transducer has a clear view of the streambed and not the lower section of the pier or the footer. A special tripod mount has been developed and is available from Stony Brook Mfg. The transducer cable must be run in a conduit that is firmly attached to the pier so that ice and debris cannot rip it off.

2.4 Installing the Stage Transducer

When fabricating the sonar transducer housing allow room for the stage sensors to be mounted in the same housing just above the sonar transducer. Both the sonar and stage sensor can be run in the same conduit to the Master Station.

2.5 Installing the Tethered Buried Switches

The two buried tethered switch sensors are to be hardwired to the Master Station. Therefore, choose a location that is in sufficient proximity that allows the cables to reach. The tethered switch sensors must be buried at scour-prone locations at desired depths to allow their release when enough streambed material is removed. They also must be buried in an upright position. When scour releases them, they will be tethered in a horizontal position allowing switch closure that is recognized by the Master Station.

2.6 Wiring Connections That Must Be Done at the Site

2.6.1 Master Station

Most of the wiring connections will have been completed at the ETI facility. However, the customer must do the wiring of the two Tethered Buried Switches to the datalogger at the site. The photo below shows the Master Station's datalogger.



Connect the red wire of TBS #1 to the datalogger terminal labeled SE1. Be aware that the red wire will share the terminal with a pre-installed wire. Connect the black wire from TBS #1 to the datalogger terminal with ground symbol between SE2 and SE3.

Connect the red wire of TBS #2 to the datalogger terminal labeled SE2. Be aware that the red wire will also share the terminal with a pre-installed wire. Connect the black wire from TBS #2 to the datalogger terminal with ground symbol between SE4 and SE5.

2.6.2 Remote Unit



Remote Unit Datalogger

All connections are to made directly to the Remote Unit datalogger as follows:

Data logger Terminal	Wire Color	Function
C4	Black	Signal in from Sonar
G(right of C4)	Shield	Power and Signal Ground
SW 12	Blue	Switched (+12 volts) Power to sonar
C1	White	Signal in (SDI=12)
G (left of C1)	Clear	Signal reference
12 V	Red	12 V continuous power to stage sensor
G (left of 12V)	Black	Ground - power ground

2.6.3 Solar Panel Connections

On both the Master Station and the Remote Unit, the solar panel wires are to be connected to the gray terminal block. There are already red and black power wires installed on the terminal block that connect to the datalogger and red and black leads that connect the battery. The red and black wires from the solar panel are to be installed in the slots next to where the *corresponding* battery leads are connected. (See the photograph below.)

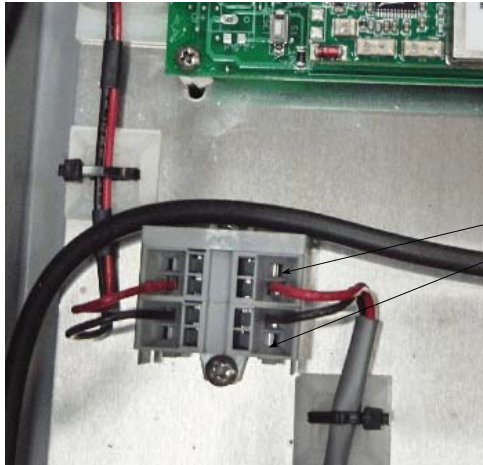

Red and Black solar panel wires here:

Use a small flat-blade screwdriver to open the spring-loaded slots to capture the solar panel's wires, which should have about $\frac{3}{8}$ inch of insulation stripped off.

Section 3

SYSTEM OPERATION

3.1 Normal System Operation

During normal daily operation, the system takes measurements as follows:

- a. Floatout sensors are continuously monitored (every second) for activity. A sensor's signals can be received by the Master Station's receiver up to one-quarter mile as it floats downstream.
- b. Every 60 seconds the system monitors the tethered buried switches for activity.
- c. Every 30 minutes the Remote Unit takes sonar and stage measurements and transmits that data, along with its battery voltage, to the Master Station. The Master Station analyzes the data to see if the sonar reading indicates scour.

3.2 System Operation if an Alert Condition is Observed by the System

- A. **Floatout Sensors.** Should scour occur causing a floatout to be released from the streambed, the floatout will begin immediately transmitting its unique digital ID from the spread-spectrum wireless data link transmitter. The wireless floatout receiver on the bridge receives the digital address from the floatout.

The system sends an alarm email that informs several designated email recipients that a floatout condition has occurred. The email alarm message provides the warning message that includes the bridge identification and the location on the bridge of the floatout sensor. (Example follows:)

Floatout Sensor Alert at Floatout Number 1 Location on MNDOT Bridge 007011 Over the Minnesota River

- B. **Sonar Sensor.** If the sonar sensor detects a decrease in streambed reference elevation of 12 inches, the system will also go into alert mode. At the same time it will reset its reference elevation to the current elevation. Should there be an additional scour of another foot, the system will issue another alert. Example follows:

Sonar Sensor Alert at MNDOT Bridge 007011 Over the Minnesota River

- C. **Tethered Buried Switch Sensors.** If the system detects activity of either of the tethered buried switches, it will go into alert mode. Example follows:

Tethered Sensor #1 Alert at MNDOT Bridge 007011 Over the Minnesota River

After the initial tethered sensor alert, the system will not issue another alert on that sensor. To ready the sensor to issue another alert, the appropriate variable TBS1STOP or TBS2STOP must be reset to 0 from 1 on the datalogger's CONNECT screen.

At initial deployment there are three email recipients prescribed by the Minnesota DOT.

After the initial alarm message is sent, a second identical message is sent out 30 minutes later. In addition, the modem remains powered up for the next 60 minutes after the initial message to allow queries into the system. During that time the system may be accessed over the Internet at the following URL address:



3.3 Data Record Format

The system continuously monitors for scour sensors that might have been activated. The data record for this transmission consists of the following comma-separated data items:

Field	Description
1	Date and time
2	Record number
3	Alarm; 0=no alarm detected, 1 = sonar alarm, 2 = tethered switch 1 active, 3 = tethered switch 2 active, 4 = one of the floatouts is active
4	Elevation of the streambed detected by the sonar sensor
5	Elevation of the water surface (stage)
6	Displays the last floatout sensor activated
7-8	These 2 fields represent the 2 floatouts. If a floatout sensor has been activated anytime in the past, its number will be in its corresponding field. See the sample file in below.
9	Tethered buried switch 1 status (1=normal,2=activated,3=wire broken, 0=no voltage)
10	Tethered buried switch 2 status (1=normal,2=activated,3=wire broken, 0=no voltage)
11	Temperature in degrees C at the Master Station electronics enclosure
12	Remote battery voltage
13	Master battery voltage

The following is an example of a file of data records as the floatouts were tested prior to shipment. (A header record precedes the data records.)

```
"TOA5", "MN07011Mas_IP", "CR800", "16139", "CR800.Std.21", "CPU:MnDOT Bridge 07011
Over Minn Riv.CR8", "33950", "Bridge07011Status"
"TIMESTAMP", "RECORD", "Alarm", "Sonar", "Stage", "FOActivated", "FOArray(1)", "FOArr
ay(2)", "TBS1Stat", "TBS2Stat", "MasTemp", "RemoteBatt", "MasBatt"
"TS", "RN", "", "", "", "", "", "", "", "", "", "", ""
"", "", "Smp", "Smp", "Smp", "Smp", "Smp", "Smp", "Smp", "Smp", "Smp", "Smp", "Smp"
"2011-08-30 10:37:00", 0, 4, 101.2, 122.6, 2, 0, 2, 1, 1, 25.5, 12.9, 13.3
"2011-08-30 11:00:00", 1, 4, 101.1, 122.8, 2, 0, 2, 1, 1, 25.6, 13.0, 13.4
"2011-08-30 11:30:00", 2, 0, 101.3, 122.8, 2, 0, 2, 1, 1, 25.6, 13.0, 13.6
"2011-08-30 12:00:00", 3, 0, 101.1, 122.7, 2, 0, 2, 1, 1, 25.6, 13.1, 13.5
```

In these four example records, the records show that floatout number 2 became active at 10:37. The Alarm field displayed the "4" until the second alert email was sent 30 minutes later.

3.4 Email Addresses Where Data is Sent



3.5 Weekly Email Status Message

Every Monday morning at 6:15 an email message that provides the battery voltage and temperature of the enclosure is sent to selected recipients. The purpose of this email is to provide assurance that the system is working and communicating. The following is a sample Weekly Status Message:

Weekly Status of MNDOT Bridge #07011 Over The Minnesota River

Battery Voltage = 12.9

Temperature = 21.7

Section 4

MAINTENANCE AND TROUBLESHOOTING

Routine maintenance of the AS-3 system consists mainly of inspecting and cleaning various components. Observing the following precautions will help ensure trouble-free operation:

- Inspect any gaskets. Make sure they are clean and in good condition.
- Inspect battery terminals. Make sure they are clean and free of corrosion.
- Inspect cable fittings. Make sure they are tight and keeping moisture out.
- Check cables for abuse.
- Check solar panel for any obstructions, dirt, bird droppings, etc.
- Check antennas.

If System Stops Recording Data or Stops Transmitting:

- Check for proper battery voltage, which should be above 12.2 volts.
- Check solar panel for damage

TECHNICAL MANUAL

AS-3 Scour Monitoring System

With Sonar, Stage and Tilt Sensors

**Configured for the Minnesota Department of Transportation
For Installation on the MNDOT Bridge 5900 Over the Mississippi River**



INSTRUMENT SYSTEMS INC.

**Scour Measurement Systems
1317 Webster Avenue
Fort Collins, Colorado 80524
(970) 484-9393
eti@etisensors.com**

AS-3 Floatout System Technical Manual

Table of Contents

Section	Title	Page
1	Description	1
	1.1 General	1
	1.2 Major Components	2
2	Installation	5
	2.1 Installing the Tilt Sensors	5
	2.2 Installing the Sonar Sensor	5
	2.3 Installing the Stage Sensor	5
	2.4 Installing the Solar Panel and AS-3 Equipment Enclosure	5
	2.5 Wiring Connections That Must Be Done at the Site	7
3	System Operation	10
	3.1 Normal System Operation	10
	3.2 System Operation When an Alert Occurs	10
	3.3 Data Record Format	11
	3.4 Email Addresses Where Data is Sent	11
	3.5 Weekly Email Status Message	12
4	Maintenance and Troubleshooting	13

Section 1

DESCRIPTION

1.1 General

ETI has configured a bridge scour monitoring system for the Minnesota Department of Transportation. The system, installed on Bridge 5900 over the Mississippi River, consists of three types of sensors, each measuring unique aspects of streambed stability. These sensors include:

1. Two sonar devices that measure the distance from the sonar transducer to the streambed. Because the transducer elevation is known, the elevation of the streambed is obtained by subtracting the measured distance from the transducer to the streambed from the elevation of the transducer.
2. Two channels (X and Y) of tilt sensors. The scour monitoring installation on Bridge 5900 takes tilt measurements every 10 minutes to determine bridge tilt movement along the roadway (X) and across the roadway (Y). Should either sensor indicate an abnormal tilt (out of specifications) the system sends an email message describing the condition to designated recipients.
3. A stream stage sensor that measures the distance (by pressure) from the stream stage sensor to the water surface of the stream. Because the elevation of the stage sensor is known, the elevation of the stream surface is obtained by adding the measured distance from the stage sensor to the water surface to provide the water stage.

The AS-3 sends alert emails to select bridge personnel should a sensor detect a suspect scour condition. To provide assurance that the AS-3 is healthy and working properly, the system also sends weekly status emails with the temperature and battery voltage.

The AS-3 is one of a family of bridge scour measurement systems designed and distributed by ETI Scour Measurement Systems that accommodate a variety of requirements and environments.

Should one of the system's sensors become active as a result of scour, the system's digital cellular modem is powered up for 60 minutes. The status of the system's sensors can be observed at that time by accessing the system via the Internet URL address described in Section 3.2.

1.2 Major Components

Major components of the AS-3 Scour Monitor installation include:

- A. ***A Master Station*** that houses the electronics that monitor the sonar sensors and the tilt sensors. It also communicates wirelessly with the Remote Unit and sends emails to designated bridge personnel. The Master Station includes:
 - 1. Electronics to monitor and control operation of the sonar and two tilt sensors.
 - 2. A CR800 datalogger that controls the sensors, records and formats the data, and controls the transmission of alert (and weekly) emails.
 - 3. A sonar transducer and cabling from the transducer to the Master Station.
 - 4. A two-channel tilt sensor configuration with cables to the Master Station
 - 5. A wireless data link receiver to communicate with the Remote Unit.
 - 6. A 20-watt solar panel and 12v battery.
 - 7. A Raven X digital cellular modem for transmitting emails and website data.
 - 8. A weatherproof electronics enclosure that houses the electronics and power supply.

- B. ***A Remote Unit*** with electronics that control a sonar sensor and the stream stage sensor. It formats the data from these sensors for transmission to the Master Station. The Remote Unit includes:
 - 1. A CR800 datalogger that controls the sonar and stage sensors, records and formats the data for transmission to the Master Station.
 - 2. A sonar sensor and cabling hardwired to the datalogger.
 - 3. A stream stage sensor and cabling hardwired to the datalogger.
 - 4. A wireless data link receiver to communicate with the Master Station.
 - 5. A 20-watt solar panel and 12v battery.
 - 6. A weatherproof electronics enclosure that houses the electronics and power supply.

The photograph below shows the Master Station and components.

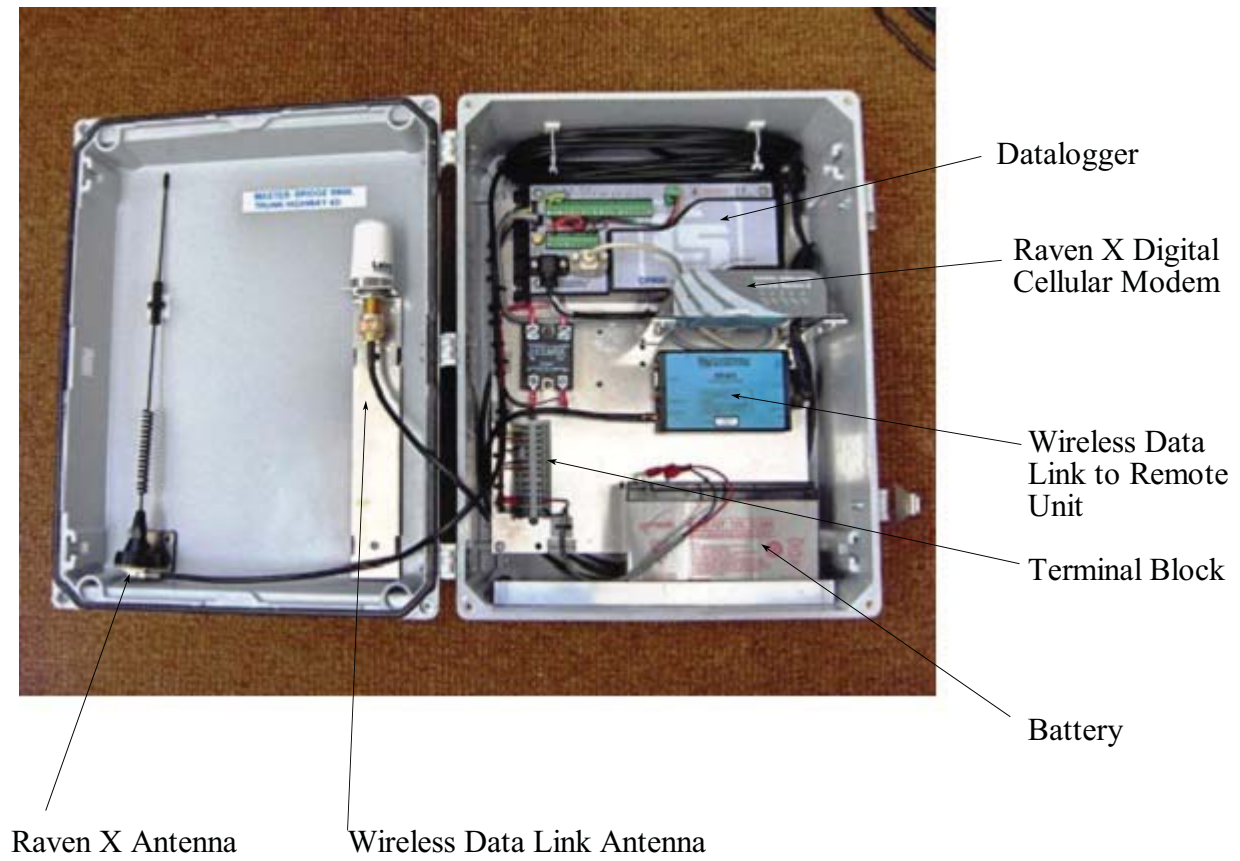

The photograph below shows the Remote Unit and components.

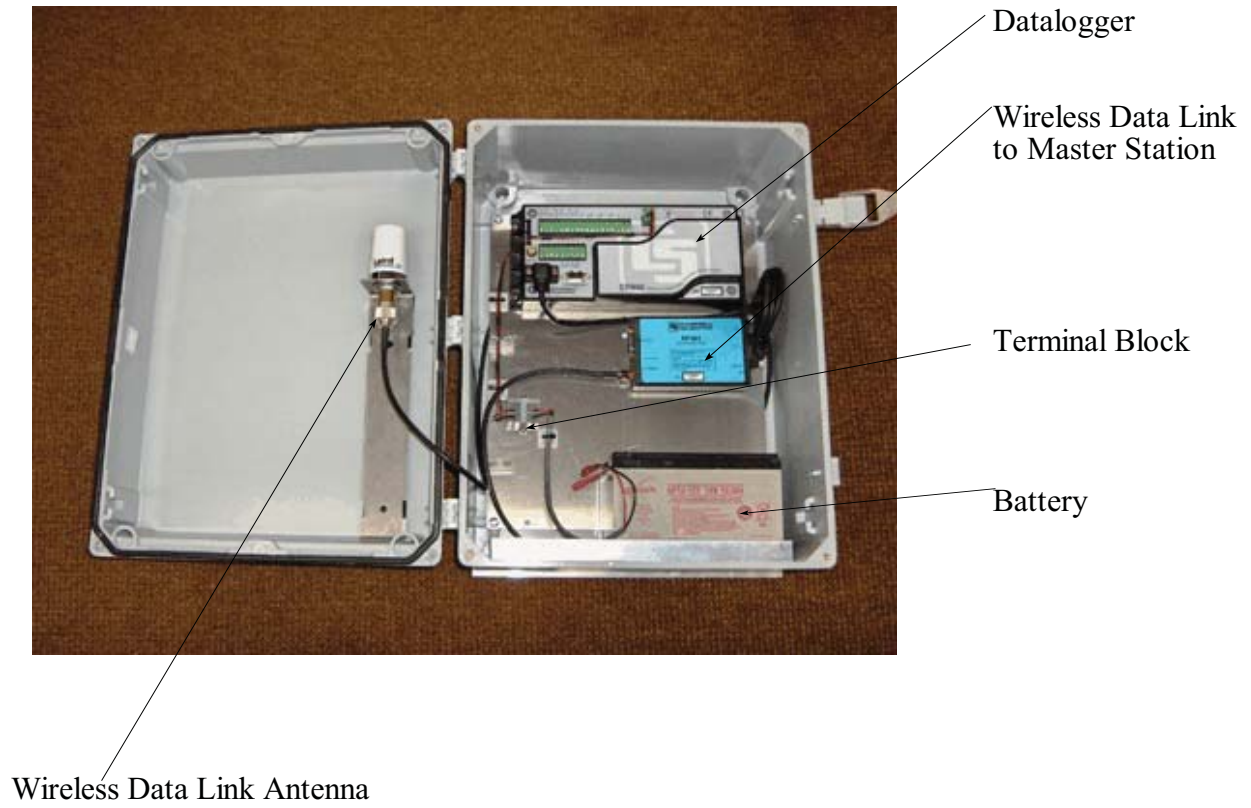

Section 2

INSTALLATION

Mounting of these components is left to the discretion of the contractor charged with installation. Special considerations are as follows

2.1 Installing the Tilt Sensor

The two channel (X and Y) tilt sensors are mounted in a small PVC enclosure. The X and Y axis is clearly marked on the cover of the enclosure. The enclosure must be located on a flat horizontal surface, as level as possible. The enclosure can be attached with a quality weatherproof adhesive.

2.2 Installing the Sonar Sensors

The sonar transducer must be mounted in a sturdy housing to protect it from ice and debris. The housing must be located out from the pier so that the sonar transducer has a clear view of the streambed and not the lower section of the pier or the footer. A special tripod mount has been developed and is available from Stony Brook Mfg. The transducer cable must be run in a conduit that is firmly attached to the pier so that ice and debris cannot rip it off.

2.3 Installing the Stage Sensor

When fabricating the sonar transducer housing allow room for the stage sensors to be mounted in the same housing just above the sonar transducer. Both the sonar and stage sensor can be run in the same conduit to the Master Station.

2.4 Installing the Solar Panels and the AS-3 Equipment Enclosures

Mounting of these components is left to the discretion of the contractor charged with installation. Special considerations are as follows:

- a. Mount the solar panel with as much southern exposure as possible to maximize solar radiation reception, either above or below enclosure. See mounting options in photos below.
- b. Mount both the Master Station and the Remote Unit equipment enclosures on the same side of the bridge to maximize transmission and reception of signals between the two units.

The photographs on the next page show views of the solar panel, enclosures, and mounting brackets.

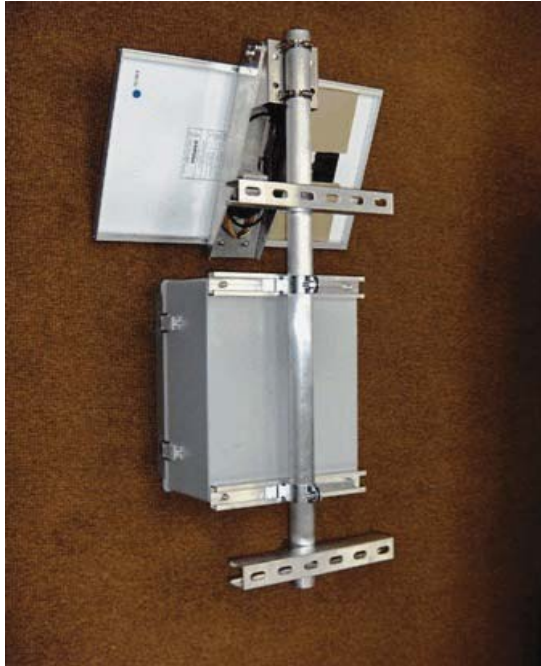

Solar Panel Mounted Above Enclosure



Solar Panel Mounted Below Enclosure

2.5 Wiring Connections That Must Be Done at the Site

2.5.1 Master Station

All connections on the left side of the terminal block *to the datalogger* have been completed at the ETI facility. However, the customer must make the following connections *to the right side of the terminal block* at the site.

(Already wired at ETI) (To be wired by the customer at the site)

To Datalogger	Terminal Block Position	Wire Color	Function
Yellow SE -1	14	Brown	Tilt sensor X signal in
Green SE - 2	13	Green	Tilt sensor Y signal in
Red 12 V	12	Red	Tilt sensor 12 volt power
Black Gnd	11	Blue	Tilt sensor power ground
*common w/ 11	10	Shield	Sonar ground / common
Brown C- 4	9	Black	Sonar signal in
Red Rly-1 Sw12 Vdc	8	Blue	Sonar power +12 Vdc
N/C	7		
N/C	6		
N/C	5		
Red +12 to logger	4	Red	Solar panel + 12 Vdc
Red *common 4	3	Red	Battery + 12 Vdc
Black	2	Black	Battery ground
Black *common 2	1	Black	Solar panel ground

2.5.2 Remote Unit

All connections are to be made directly to Remote Unit datalogger by the customer at the site as follows.

Datalogger Terminal	Wire Color	Function
Sonar:		
C4	Black	Signal in from Sonar
G (right of C4)	Shield	Power and signal ground
SW- 12V	Blue	Switched (+ 12 volts) power to sonar
Stage Pressure:		
+ 12V	Red	Continuous + 12 volts
G (right of +12)	Black	Power ground #1
C1	White	Signal in (SDI-12)

#1 Clear - Yellow - Blue, all connect to "G"

2.5.3 Solar Panel Connections

The solar panel wires are to be connected to the gray terminal block. There are already red and black power wires installed on the terminal block that connect to the datalogger and red and black leads that connect the battery. The red and black wires from the solar panel are to be installed in the slots next to where the *corresponding* battery leads are connected. (See the photograph below.)

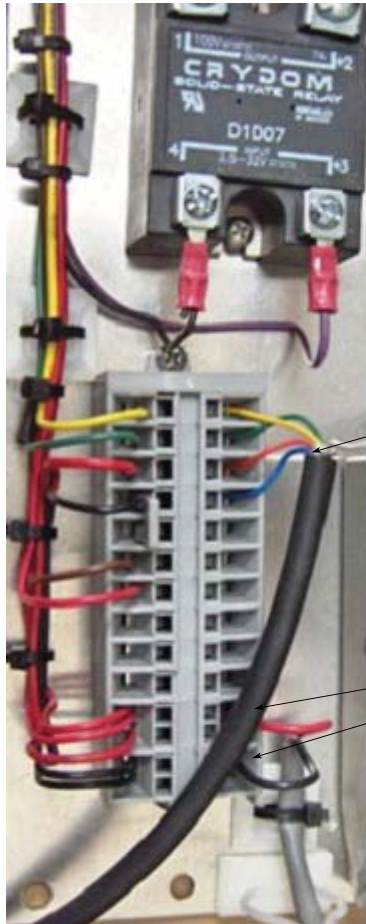

(Ignore the wiring shown here. This was a test tilt sensor cable. The customer is to connect the sensor cabling as described in the table on the previous page)

Connect Red and Black solar panel wires here:

Use a small flat-blade screwdriver to open the spring-loaded slots to capture the solar panel's wires, which should have about 3/8 inch of insulation stripped off.

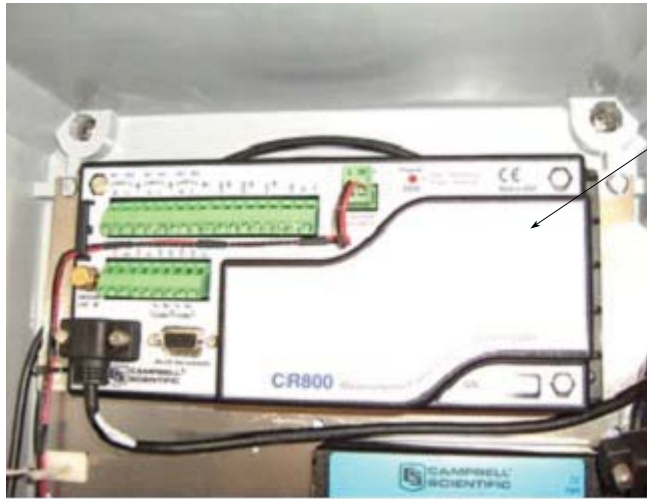

Remote Unit Datalogger

All connections are made directly to Remote Unit's datalogger as follows:

Data Logger Terminal	Wire Color	Function
C4	Black	Signal in from Sonar
G (right of C4)	Shield	Power and signal ground
SW- 12V	Blue	Switched (+ 12 volts) power to sonar
Stage pressure:		
+ 12V	Red	Continuous + 12 volts
G (right of +12)	Black	Power ground #1
C1	White	Signal in (SDI-12)

#1 Clear - Yellow - Blue all connect to "G"

Section 3

SYSTEM OPERATION

3.1 Normal System Operation

During normal daily operation, the system takes measurements as follows:

- a. Every 60 seconds the system takes measurements on the two tilt sensors. These readings are averaged over a 10-minute period and then analyzed to determine if they exceed a predetermined reference. A record is written to memory, and if either exceeds its reference, then alert emails are sent to designated bridge personnel.
- b. There is a sonar sensor at both the Master Station and the Remote Unit. The Remote Unit also has a stream stage sensor. Every 30 minutes the Remote Unit takes sonar and stage measurements and transmits that data, along with its battery voltage, to the Master Station. The Master Station also takes sonar readings on its sensor and analyzes the data to see if either sonar sensor indicates scour.

3.2 System Operation if an Alert Condition is Observed by the System

- A. **Tilt Sensors.** Should the tilt sensors indicate that the bridge tilt has exceed a reference limit, a record is written to datalogger memory and the system recognizes an alert condition exists. The system also resets the reference level for the alarming sensor to a value near the current reading. This new reference level will be used for the future measurements. The system then sends an alarm email that informs designated email recipients that a tilt condition has occurred. The email alarm message provides the warning message that includes the bridge identification and which tilt sensor is in alarm. (Example follows:)

Tilt Sensor Alert on Bridge 5900 Over the Mississippi River
The X-Axis Tilt Sensor is in Alarm

- B. **Sonar Sensor.** If either sonar sensor detects a decrease in streambed reference elevation of 12 inches, the system will also go into alarm mode. At the same time it will reset its reference elevation to the current elevation. Should there be an additional scour of another foot, the system will issue another alarm. (Example follows:)

Sonar Sensor Alert on Bridge 5900 Over the Mississippi River
The Sonar Sensor on Pier 22 is in Alarm

At initial deployment there are five email recipients prescribed by the Minnesota DOT.

After the initial alarm message is sent, a second identical message is sent out 30 minutes later. In addition, the modem remains powered up for the next 60 minutes after the initial message to allow queries into the system. During that time the system may be accessed over the Internet at the following URL address:

3.3 Data Record Format

The system continuously monitors for scour sensors that might have been activated. The data record for this transmission consists of the following comma-separated data items:

Field	Description
1	Date and time
2	Record number
3	Alarm; 0=no alarm detected, 1 = X axis tilt, 2 = Y axis tilt, 3 = sonar 20, 4 = sonar 22
4	X axis tilt in degrees
5	Y axis tilt in degrees
6	X axis tilt reference in degrees
7	Y axis tilt reference in degrees
8	Sonar 20 elevation in feet
9	Sonar 22 elevation in feet
10	Stage (elevation of stream surface in feet)
11	Temperature in degrees C at the Master Station electronics enclosure
12	Remote battery voltage
13	Master battery voltage

The following is an example of a file of data records as the system was tested prior to shipment. (A header record precedes the data records.)

```
"TOA5", "MN5900Mas_IP", "CR800", "12969", "CR800.Std.09", "CPU:MnDOT Bridge 5900 Over
Miss River.CR8", "53018", "Bridge5900Status"
"TIMESTAMP", "RECORD", "Alarm", "XTilt", "YTilt", "XTiltRef", "YTiltRef", "Sonar20", "Sonar2
2", "Stage", "MasTemp", "MasBatt", "RemoteBatt"
"TS", "RN", "", "", "", "", "", "", "", "", "", "", "", ""
"", "", "Smp", "Smp", "Smp", "Smp", "Smp", "Smp", "Smp", "Smp", "Smp", "Smp", "Smp"
"2011-08-25 10:00:00", 0, 0, -0.27, 0.04, -0.45, 0.05, 642.3, 641.7, 630.6, 23.5, 12.7, 13.1
"2011-08-25 10:10:00", 1, 1, -0.18, 0.06, -0.23, 0.05, 642.3, 641.7, 630.6, 23.5, 12.7, 13.1
"2011-08-25 10:20:00", 2, 1, -0.32, 0.38, -0.23, 0.05, 642.3, 641.7, 640.6, 23.5, 12.7, 13.1
"2011-08-25 10:30:00", 3, 1, -0.33, 0.84, -0.23, 0.05, 642.5, 642.2, 640.4, 23.7, 12.8, 13.3
"2011-08-25 10:40:00", 4, 1, -0.32, 0.85, -0.23, 0.05, 642.5, 642.2, 640.4, 23.7, 12.8, 13.4
"2011-08-25 10:50:00", 5, 0, -0.34, 0.82, -0.23, 0.05, 642.5, 642.2, 640.4, 23.7, 12.8, 13.6
```

In these six example records, the records show that the X tilt sensor issued an alert at 10:10:00 and reset its reference level. The Alarm field remained at "1" until 10:40 when the second alarm e-mail was sent.

3.4 Email Addresses Where Data is Sent

These are the email addresses of the recipients initially provided by the Minnesota DOT:



3.5 Weekly Email Status Message

Every Monday morning at 6:15 an email message that provides the battery voltage and temperature of the enclosure is sent to selected recipients. The purpose of this email is to provide assurance that the system is working and communicating. The following is a sample Weekly Status Message:

Weekly Status of MNDOT Bridge #5900 Over The Mississippi River
Battery Voltage = 12.9
Temperature = 21.7



Section 4

MAINTENANCE AND TROUBLESHOOTING

Routine maintenance of the AS-3 system consists mainly of inspecting and cleaning various components. Observing the following precautions will help ensure trouble-free operation:

- Inspect any gaskets. Make sure they are clean and in good condition.
- Inspect battery terminals. Make sure they are clean and free of corrosion.
- Inspect cable fittings. Make sure they are tight and keeping moisture out.
- Check cables for abuse.
- Check solar panel for any obstructions, dirt, bird droppings, etc.
- Check antennas.

If System Stops Recording Data or Stops Transmitting:

- Check for proper battery voltage, which should be above 12.2 volts.
- Check solar panel for damage