

MN 2000
EB-443
C.2

Design your own clothes

FLAT PATTERN METHOD

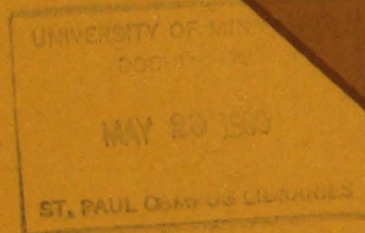

This archival publication may not reflect current scientific knowledge or recommendations. Current information available from University of Minnesota Extension: <http://www.extension.umn.edu>.



North Central Regional Extension Publication 88-1980

EXTENSION BULLETIN 443-1980

Sponsored by the Extension services of Illinois, Indiana, Iowa, Kansas, Michigan, Minnesota, Missouri, Nebraska, North Dakota, Ohio, and South Dakota. In cooperation with SEA-Extension, USDA.



Many people have a hidden desire to design their own patterns. Although the complete process of designing a garment and making the pattern is quite complicated, you can use some techniques to adapt a commercial design to make one of your own.

Contents

Methods of Pattern Making	3
Design Analysis.	3
Flat Pattern Techniques	4
Button Closings.	4
Fitted Facings.	5
Darts.	6
Yokes	13
Seamlines.	15
Necklines.	16
Collars and Sleeves.	17
Pockets	19
References.	19

Lois Goering, Extension Specialist
Textiles and Clothing
Agricultural Extension Service
University of Minnesota

Extension Bulletin 443—1980
North Central Regional Extension Publication 88—1980

The author wishes to express appreciation to Norma Hollen for her leadership in the field of pattern making and her encouragement in the preparation of this publication.

Methods of Pattern Making

There are three major methods of creating patterns for garments: flat pattern designing, draping, and drafting. In flat pattern designing you begin with a pattern and make changes to create your own design. In draping, you work with a body form and drape fabric on it to create a design and make a paper pattern. To draft a pattern, you begin with body measurements and a design, and you create a pattern. In this publication, you will find information to help you create the pattern for your own garment design using flat pattern techniques.

In most flat pattern designing you begin with a basic pattern that fits you. Or, you can begin with a pattern designed almost as you wish and by making a few changes have your own design. *Always* start with a

pattern that fits you well. Copy the pattern you begin with on to tissue paper and use the traced copy for designing. This way you can use your original pattern again. Although flat pattern designing is not difficult, it is a process that demands accuracy. If your work is not accurate, the garment may not sew together the way you intended, or the design may not look the way you expected it to look.

This publication includes some of the basic techniques that you can use for many pattern changes. If you find that you enjoy designing your own patterns, you may want to try additional design changes. When you get to that point, use one of the references listed on the last page or enroll in a university or vocational school class in flat pattern designing.

Design Analysis

The inspiration for patterns you design may come from magazines, catalogs, store windows, or your own ideas. Analyzing the design is the critical first step in pattern making. The following are some details to consider:

- Which lines are structural and which ones are only for design purposes?
- How is shape arrived at in the garment:
 - Where are the darts?
 - If there are no darts, where are the gathers, tucks, seams or flare that give the garment shape?
- Does the garment have the amount of ease found in a basic garment?
 - If not, where has fullness been added?
 - How much fullness has been added: slight, moderate, or much?
- How much distance is between details?
 - How close are pockets to side seams, waistline, or bustline?
 - Where does a seam cross the design?
 - Where do design lines begin and end?
 - Does a design line in the bodice continue into the skirt?

- Where is the grainline on each part of the garment?
- What kind of neckline does the garment have?
 - Is the basic neckline used?
 - What kind of collar is present?
- What kind of sleeves does the garment have?
 - Are sleeves set in, kimono, dolman, dropped, or some other type?
 - How long are the sleeves?
- How will the design look on you?
 - Will you need to have a seam cross your body in a slightly different location so the design will look better on you?
 - Do you look good with the type and amount of shaping in the garment?

Carefully examine garments pictured in magazines, catalogs, and store windows and learn to quickly analyze them. Watch carefully for the design details that make garments fashionable. It may be a detail at the neckline, shoulderline, or sleeve. Maybe it is the hemline or the fullness of the skirt. Usually you can add some of those details to your favorite old pattern if you are conscious of what the fashionable new details are.

Flat Pattern Techniques

Button Closing

Many designs use a button closing instead of placing the center front on the fold. This design change requires little time. The overlap-underlap must be designed, the button and buttonhole placement determined, and a facing designed. In women's clothing, the buttonholes go on the right side of the bodice front, and the buttons are placed on the center front line of the left side of the bodice front. So they won't stretch out of shape, buttonholes are generally made with the lengthwise or crosswise grain of the fabric.

To add the overlap-underlap, an extension must be added to the center front. The lap should equal half the diameter of the button plus $\frac{1}{4}$ to $\frac{1}{2}$ " (about 1 cm). If large buttons are used the lap should be made wider.

To decide on location of the buttons, place the buttons on the bodice front and arrange as you wish. Guidelines to keep in mind in locating buttons:

- Buttons are usually evenly spaced, but can be arranged in groups.
- One button should be placed at or near the bustline (the point of greatest strain).
- The distance from the neckline to the center of the top button usually is half the diameter of the button plus $\frac{1}{4}$ " (6 to 8 mm).
- The space between the waistline and the bottom bodice button usually is the same as the space between the other buttons. A button or belt buckle is placed at the waistline.
- Sew the buttons on the center front line.

To mark the buttonhold location, remember that buttonholes usually begin $\frac{1}{8}$ " (3 mm) outside of the center front and extend back into the bodice. The length is equal to the diameter of the button plus $\frac{1}{8}$ " (3 mm), or in case of a thick button, plus the thickness of the button. If you use a rough button, allow a little more length in the buttonhole.

If you use vertical buttonholes, place them on the center front line. Vertical buttonholes begin $\frac{1}{8}$ " (3 mm) above the center of the button

To complete the design change, add a seam allowance at the edge of the overlap. Your completed bodice front pattern with button closing will look like this. You are now ready to make a facing for the garment front.

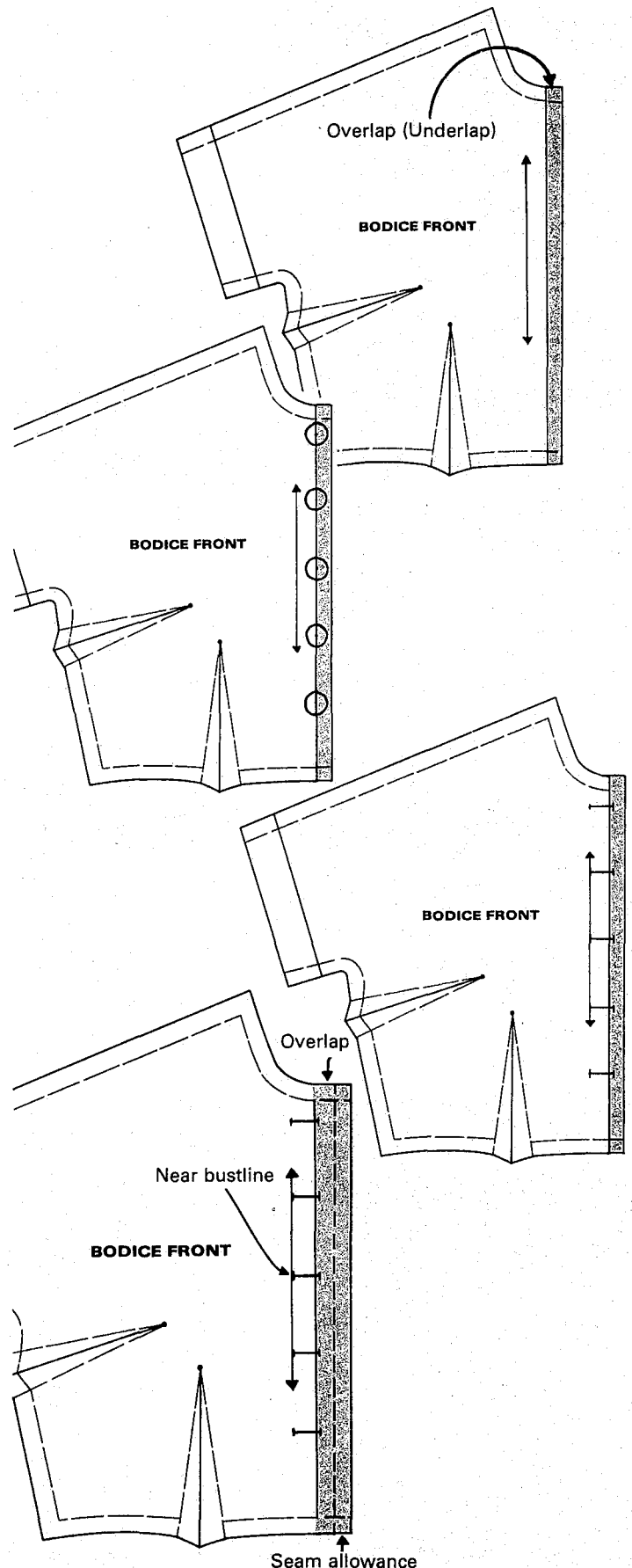

Fitted Facings

Fitted facings are used to finish edges of garments in many locations:

- armholes
- button and buttonhole closings
- collars
- hem-type areas such as ends of sleeves, bottoms of blouses, skirts, and pants
- necklines
- pockets and pocket flaps
- waistlines

A fitted facing is shaped like the edge of the garment that it is facing and has the same grainline direction as that part of the garment.

To make a pattern for a fitted facing,

- Fold in any darts or tucks in the garment part you are going to face.
- Place the edge to be faced under a piece of tissue paper. The paper should be big enough so you can make a facing $2\frac{1}{2}$ " (6.5 cm) wide.
- Trace the edges of the pattern you are facing. Be sure the pattern edge that you are tracing lies flat.
- Draw the inner edge of the facing. The facing generally should be at least 2 to $2\frac{1}{2}$ " (5-6.5 cm) wide so the edge will not show or work to the outside of the garment when it is worn. Make the inner edge a smooth line.
- Add the grainline marking so the facing is on the same grain as the garment at center.
- Add seam allowances where the facing will be joined to another facing or garment edge.

To make a pattern for a self-facing, (a good alternative whenever the edge being faced is on straight grain), make the facing as directed under "To make a pattern for a fitted facing."

- Do not add seam allowances to the facing edge to be attached to the garment or that edge of the garment.
- Tape the facing to the main part of the garment pattern on the seam line.

Using a self-facing eliminates seam allowances and bulk in the area where the facing is attached.

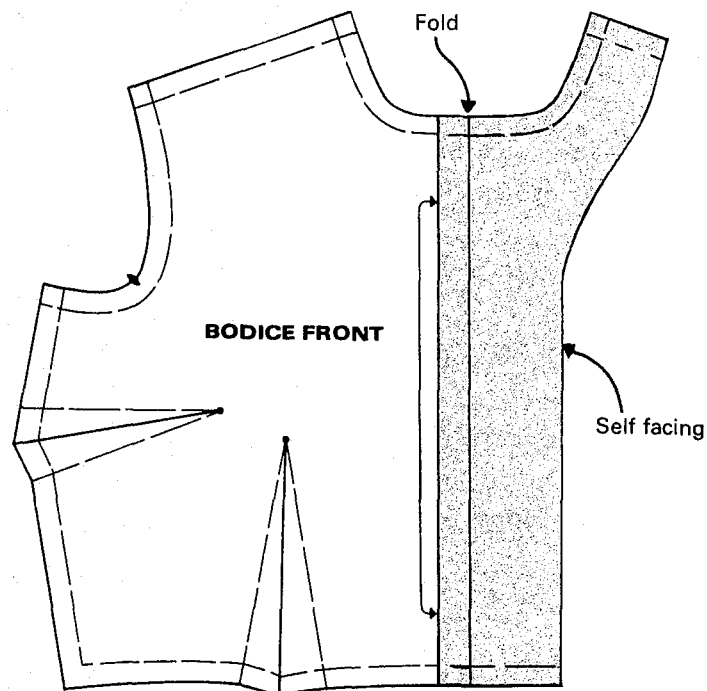
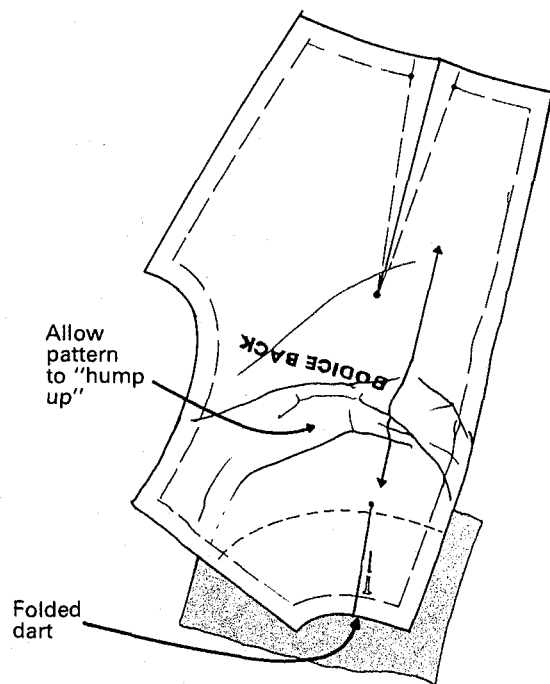

Darts

FACTS ABOUT DARTS

Darts are the basic tools of the designer. They are used to make garments fit areas of the body that are not flat, or they are used as decoration. The types of darts we are concerned with here are those used for fitting. It is important to realize, however, that not all darts are used for fitting. As you look at designs and analyze them for patternmaking or as you create your own designs, you will need to decide if the darts are decorative darts, fitting darts, or both. Fitting darts *cannot* be eliminated unless they are changed to gathers, tucks, or some other method of including the needed fullness.

Fitting darts are used to make a flat piece of fabric fit a curved body. Before you begin to design with darts, a few general details about darts will help you use them more effectively. Things to keep in mind about darts:

- A basic bodice front has both a bust-fitting and a waist-fitting dart. The bust-fitting dart is usually in the underarm position, but it can come from the neck, shoulder, armhole, waist, or center front seam. Usually the waist-fitting dart is in the waistline seam, but it can be moved to other positions.
- Fitting darts point to the fullest part of the body. In the bodice front this is the bustline. In the bodice back, darts point toward the shoulder blades. In skirts and pants, darts point toward the hipline.

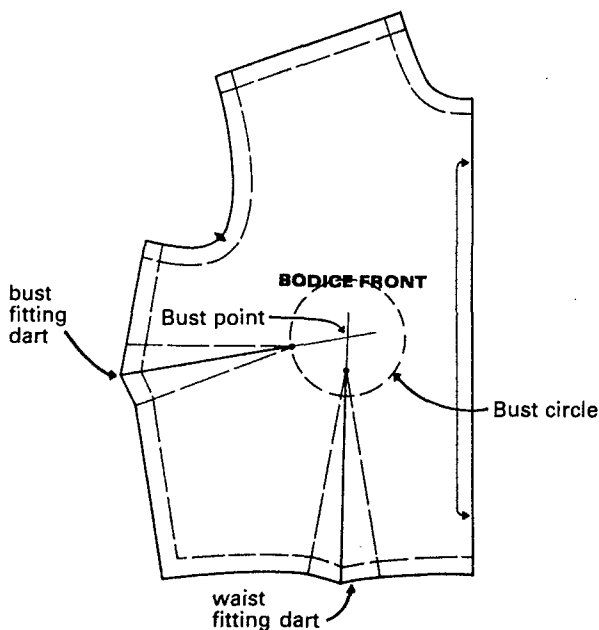

- Fitting darts **MUST** be long enough to reach the bust circle and **MUST NEVER** go beyond the bust point. If one of the fitting darts has a larger angle than the other, it should go farther into the bust circle. If both of the darts are equal in size, they should both end at or just inside the bust circle.
- If two darts begin at the same seamline, they usually can't both point at the bust point. You may have one point to the bustpoint and the other point into the bust circle, or both darts can end the same distance from the bustpoint pointing into the bust circle.
- Decorative darts do not point toward the fullest part of the body and do no fitting. The angle of purely decorative darts must be small so they don't create a bulge in the fabric.

To mark the bust point on your pattern, draw lines through the center of the bust and waist darts. The bust point is the place where the two lines cross. This bust point should be in the same location as the tip of your bust when you wear the garment.

To draw the bust circle on your pattern, use a compass. When designing, the bust circle is drawn with a 1½" (3.8 cm) radius for sizes 8, 10, and 12 and a radius of 2 to 2½" (5 to 6.5 cm) for larger sizes. The bust circle is the area on a pattern that covers the full part of the bust. Accuracy is important since the direction and length of darts are determined by the size of the bust circle.

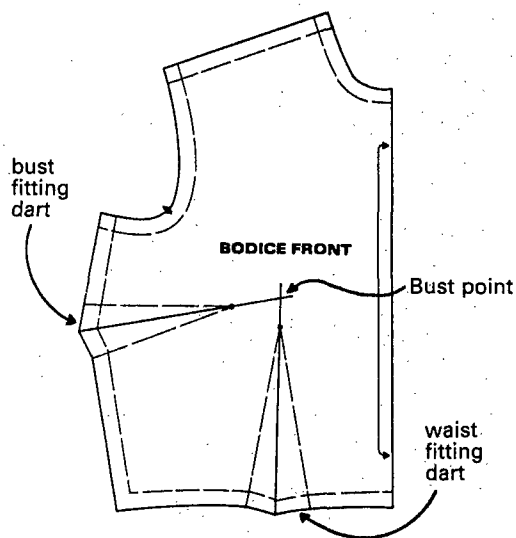

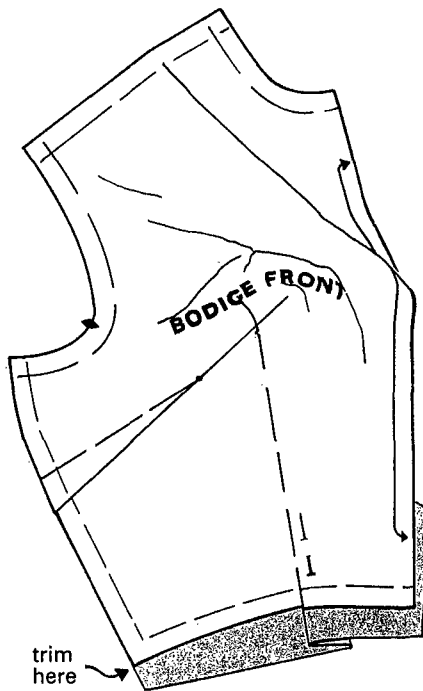

To move a bodice dart, follow this sequence:

- Work with a copy of the bodice front pattern.
- Locate the bust point and draw in the bust circle.
- Mark the location of the new dart by drawing a line from the seamline to the bust point. Be sure the dart location is the same distance from key fitting points (neckline, armhole, waistline, etc.) as shown in your drawing or the garment you are copying.
- Slash along the center of the dart you want to move, to but not through, the bust point.
- Slash along the line for the new dart to but not through the bust point.
- Pivot the pattern on the bust point and close the dart that is being moved. Bring the two stitching lines together as if the dart were being stitched. Allow the new dart to open so the pattern lies flat. Tape tissue paper under the opening.
- Redraw the dart stitching lines by locating the point of the dart in the center of the spread near the bust circle. Use a ruler to draw the dart stitching lines to the ends of the slash.
- Shape the seam end of the new dart as shown.

To shape the end of a dart so it will stitch into the seam smoothly, fold the dart in the paper pattern in the direction it will be pressed in the finished garment. Vertical darts are pressed so the fold is nearest the center of the garment. Horizontal darts are pressed with the fold toward the hemline. When the dart is folded in place, cut even with the edge of the pattern or use a tracing wheel to mark the seam and cutting lines.

MOVING AND CONVERTING DARTS

There are several methods to use to move darts in designing patterns. The slash method shown here is one of the easiest. Darts can be moved in bodices and skirts using this method. As you are moving darts, keep in mind that darts can be

- moved from one seamline to another
- combined into one large dart
- divided into two or more smaller darts
- changed into gathers and seamlines
- changed into flare
- changed into dart tucks
- released (just not stitched) to make boxy jackets or unfitted dresses or blouses

Bodice front darts can be moved to any seam as long as they point to and end in the bust circle. After you try moving the bust-fitting dart to the shoulder as shown here, experiment with moving the darts to other seams.

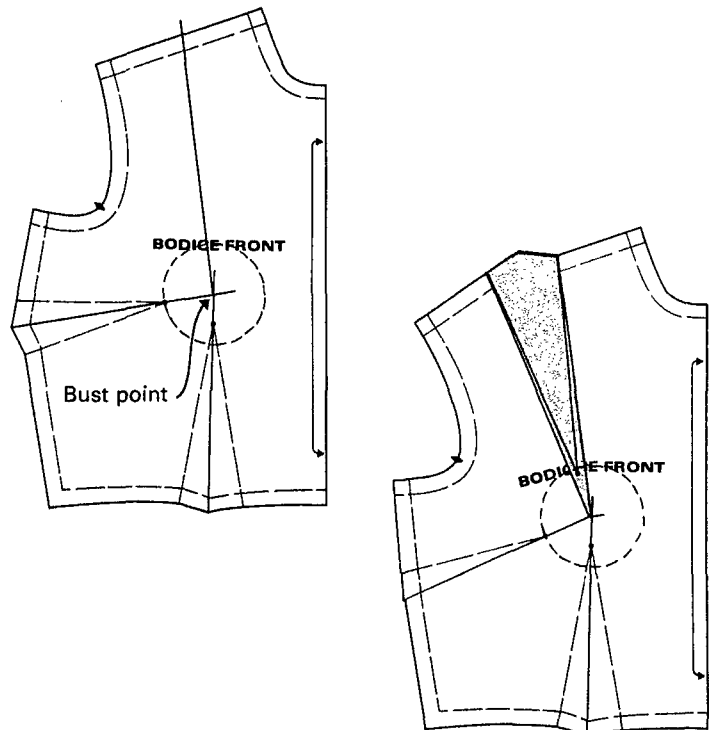

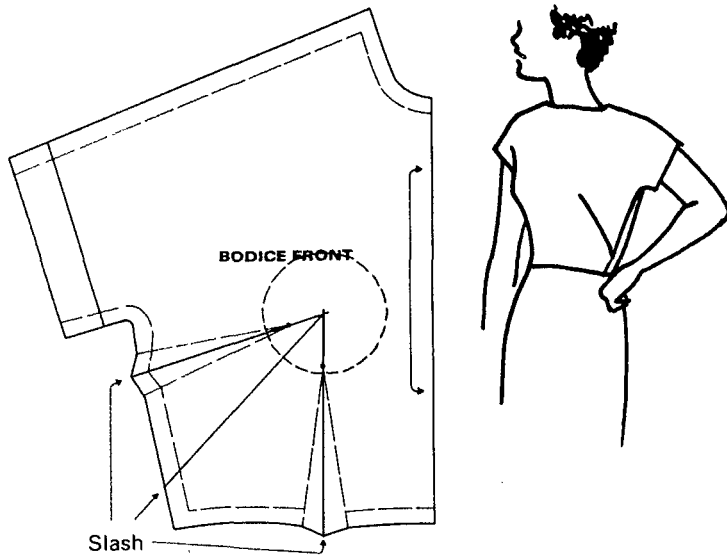

To divide darts, decide where you want to locate the new darts. Think carefully about the effect in the completed garment. In this example, the darts will be parallel in the completed garment. You may want to move a dart and divide it into two or three new darts to create a special design.

- Locate the bust point, draw the bust circle, and draw the design lines for the new darts.
- Slash through the dart being closed. Slash along the new dart lines and to the bust point.
- Close the original dart. Tape tissue paper under the opening. Tape the new darts so that the space is divided evenly between the two darts. Draw the new dart stitching lines to the bust circle.
- Shape the end of the darts.

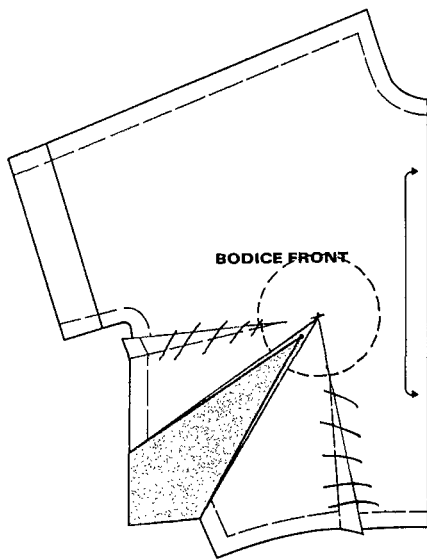

To combine darts, decide where you want to put the combined dart. Both of the bodice front darts can be moved and combined into one large dart. The procedure is the same as in moving one dart, except that both of the original darts are closed and the new dart is larger.

- Locate the bust point on the pattern and draw on the bust circle. Draw a line in the new dart location.
- Slash from the seamlines to the bust point through the center of both of the darts being moved. Slash to the bust point on the new dart line. Be careful to cut *to but not through* the bust point.
- Close the two darts by lapping the dart stitching lines at the seamline. Tape in place. Tape tissue paper under the opening.
- Draw the new dart stitching lines. A combined dart such as this one should extend almost to the bust point, so that it will fit smoothly when worn. Shape the seam end of the dart.

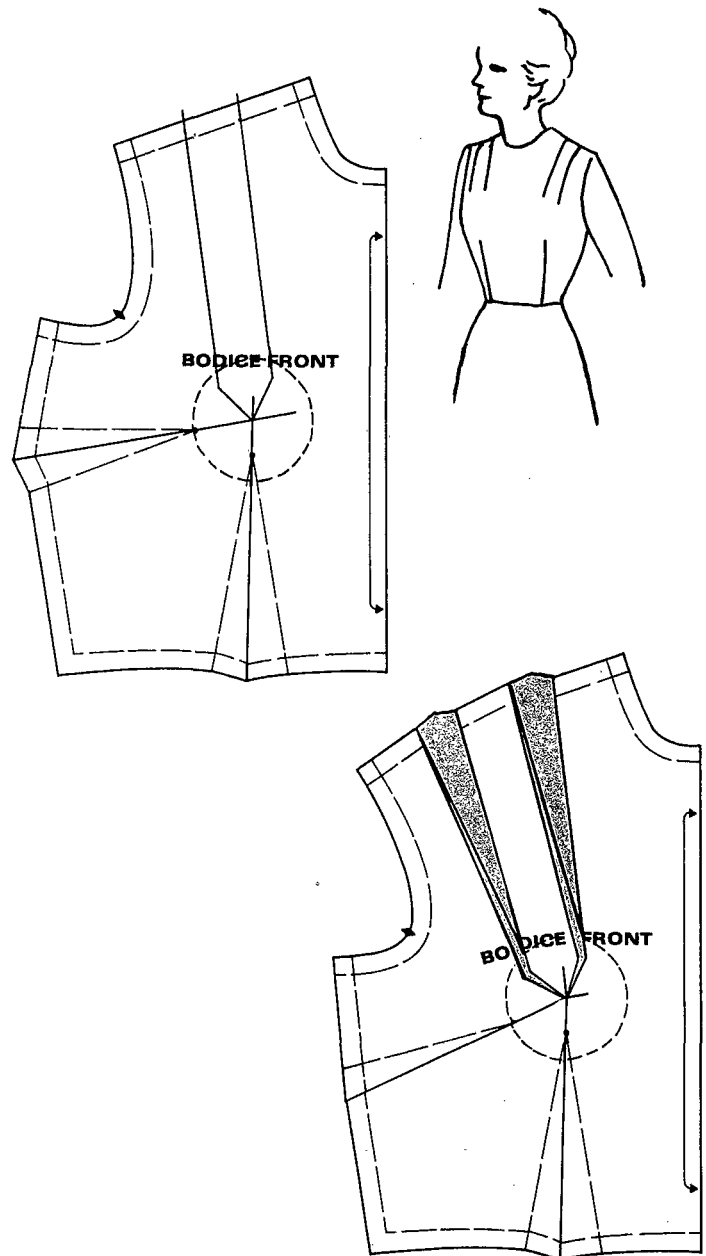

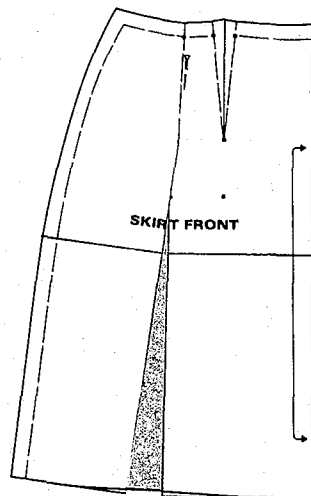
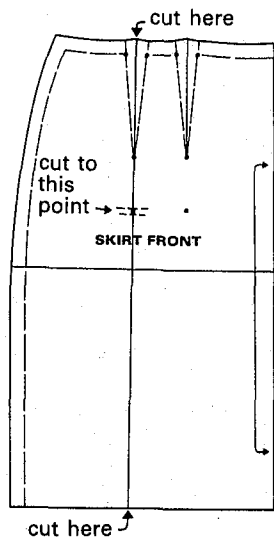
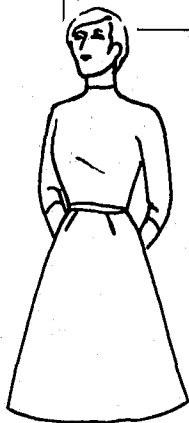
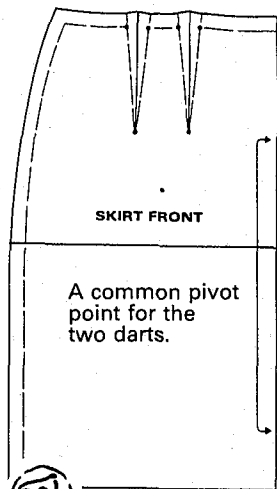
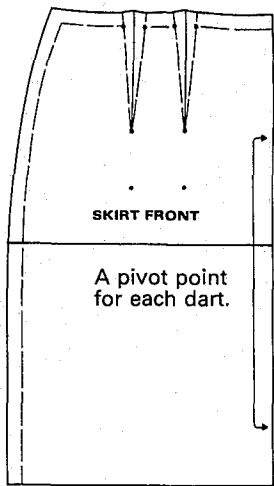

Skirt darts can be moved the same as bodice darts, however, the curves in the hip area are different than those in the bust, so there is not as obvious a point to pivot the pattern parts. When working with skirts, the pivot point for each of the darts is halfway between the end of the dart and the hipline in line with the middle of the dart. If two darts are being moved, one pivot point can be used halfway between the two darts.

Skirt darts can be converted into flare, changed into gathers, or moved in the area above the hipline.

To convert darts to flare, use either one or both darts. In most A-line skirts, one of the two waistline darts has been converted to flare:

- Cut through the side dart to its pivot point.
- Cut from the hem to the dart pivot point.
- Close the dart and let the skirt spread until the pattern lies flat.

Tape dart closed. Tape tissue paper under the opening. Draw in new hem line.

To add additional flare so that an A-line skirt can be converted to a flared skirt,

- Cut and tape other dart closed.
- Slash from the hem to the waistline in several places and spread evenly on both sides of the grainline. Slash the side section to the seam line to make the side seam straight. Tape pattern to tissue paper. The amount of flare you add depends on how full you want the skirt to be. Create a similar flare for the front and back patterns.

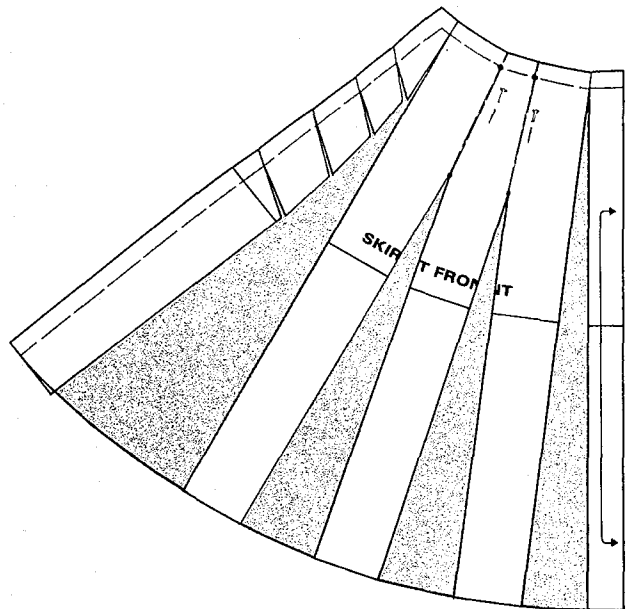

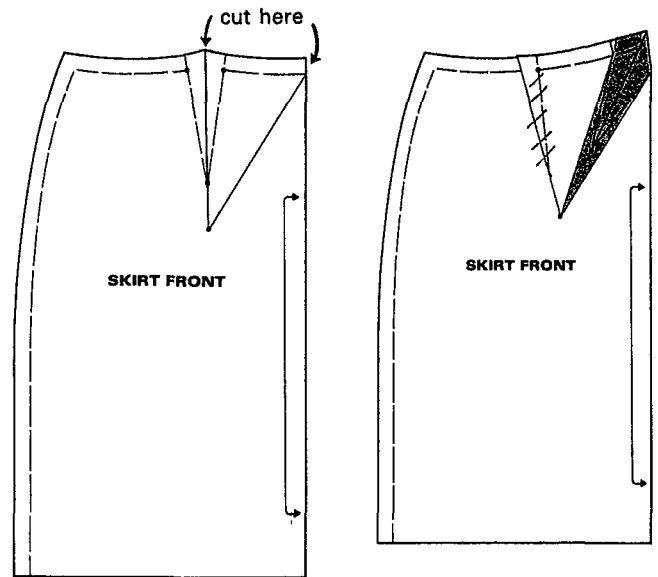
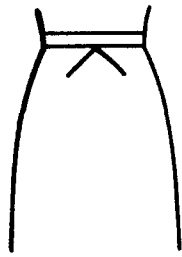

To move a dart in a skirt, locate the dart pivot point.

- Draw in the new dart line to the pivot point of the dart you are moving.
- Cut through the center of the old dart to the pivot point. Cut on the new dart line to the pivot point.
- Close the old dart and put tissue paper below the opening for the new dart.
- Draw in the new dart stitching lines and shape the end of the dart.

RELEASING DARTS

For some designs, the effect is more pleasing if the dart is partially or fully released.

To release a bodice dart,

- A partially released dart is stitched part way.

- Or, fold the dart only in the seamline. The dart stitching line would not be stitched at all.
- In some designs the waist fitting dart is released or simply not sewn in.
- The patterns for all these begin by changing the bodice pattern to look like this.

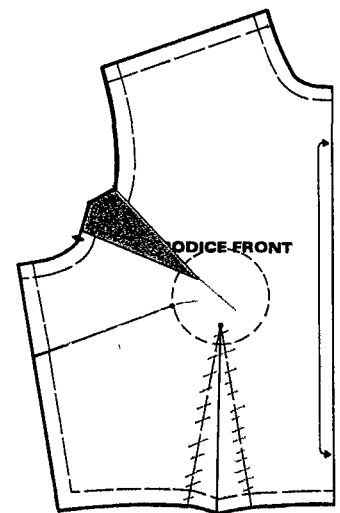
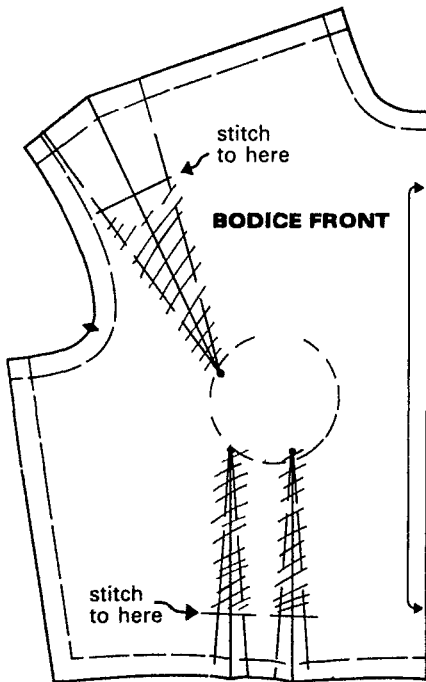

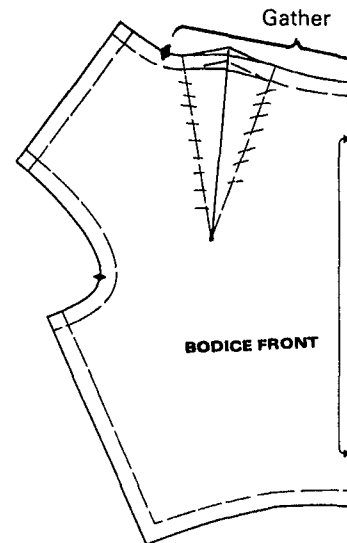
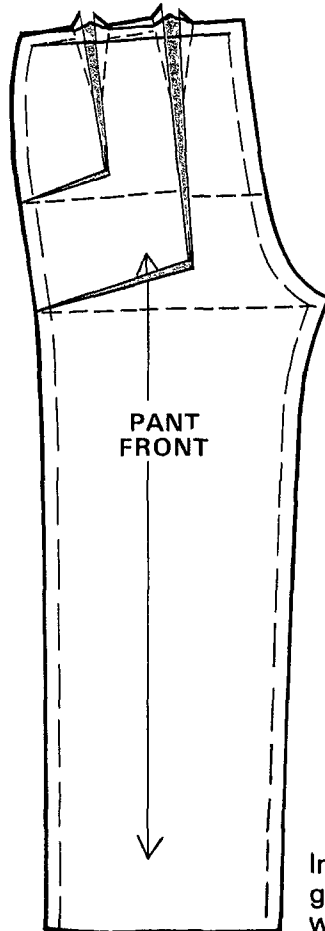
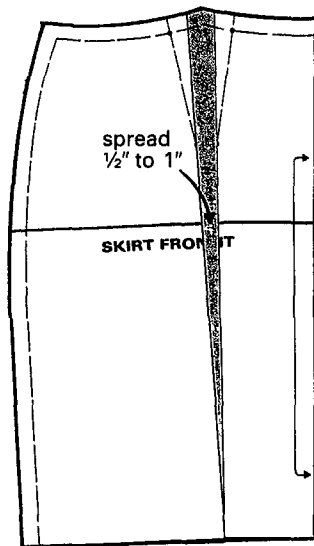
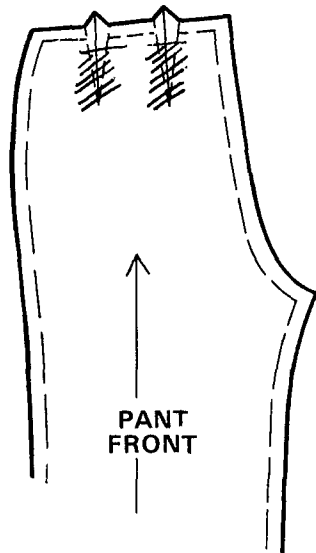

To release darts in skirts and pants, decide how far to stitch the dart and cross off (just don't stitch) the rest of the dart. Open ended darts give a pleat type of look to a pant/skirt front.

To make trouser pleats; and add fullness to pants or a skirt,

- Slash the pattern through the center of the darts and to the side seam at hip and crotch level in pants, and to the hemline in a skirt as illustrated.
- Spread the pattern to add the amount of fullness you wish (probably $\frac{1}{2}$ to 1 inch or 1.3 to 2.5 cm at the widest part of the spread). Tape to tissue paper.
- To perfect the waistline seamline, fold the pattern on the original dart lines as if the darts were stitched and pressed. Cut across the top of the pattern.
- When sewing pants/skirt to waistband, fold in the pleat bringing original dart stitching lines together and fasten to waistband.

CONVERTING DARTS TO GATHERS

In a skirt or bodice any of the darts can be changed into gathers. Begin by moving the darts to the location you want the gathers.

To make gathers from darts,

- Draw a smooth line across the wide end of the dart and cross out the dart stitching lines.
- Put a notch on the pattern where you want the gathers to stop. Remember that you will have to gather the fabric into a larger space than the dart occupied.

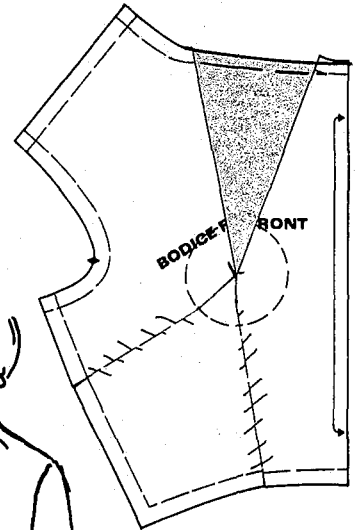
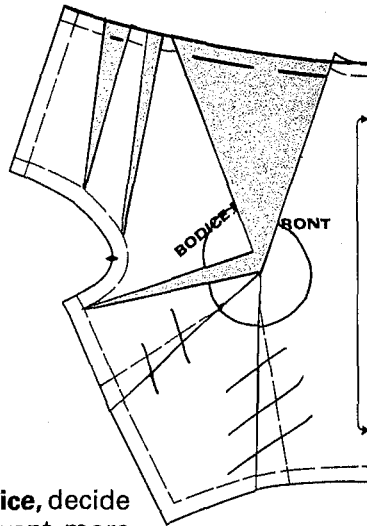
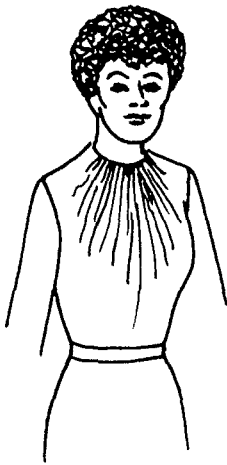

To add extra fullness to the gathers in a bodice, decide how much fullness you want. You may want more fullness in gathers than you get simply by moving darts to that area of the pattern.

When extra fullness is added, use the chart below as a guide to determine the amount of fullness to add. Remember that heavy or stiff fabrics require less fullness than soft or lightweight fabrics.

AMOUNT OF FULLNESS TO USE

	Gathered Edge to Ungathered Edge (Skirt-Sleeve)	to Ungathered Edge (Waistband-Armseye)
Moderate	1½" (3.8 cm) to	1" (2.5 cm)
Moderately full	2" (5 cm) to	1" (2.5 cm)
Full	3" (7.5 cm) to	1" (2.5 cm)

To add extra fullness to gathers in a skirt, add the fullness to gathers above the hipline or through the entire length of the skirt. To add fullness above the hipline, slash and spread the pattern as shown. Tape to tissue paper.

To add fullness through the entire length of the skirt, slash pattern as shown and spread pattern parts evenly from the waist to the hem. The side seam in a straight skirt is curved above the hipline to shape the skirt to fit the body. The side seam can be straightened by slashing the side piece as shown. The shaping is then done by gathering the extra fabric to fit the waistline.

Reshape the waistline to a smooth curve from the center of the pattern to the side.

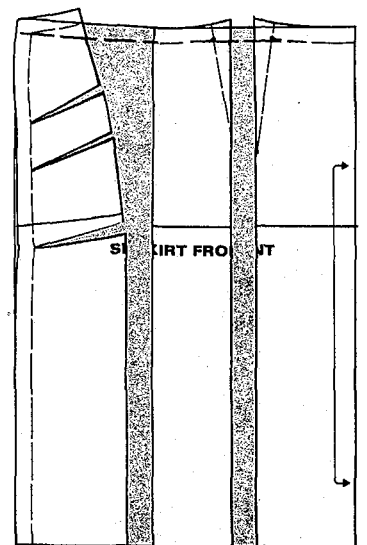
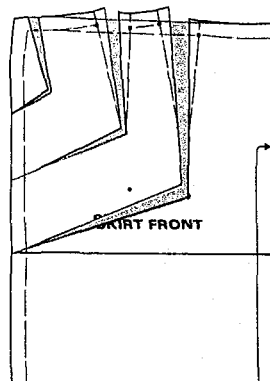
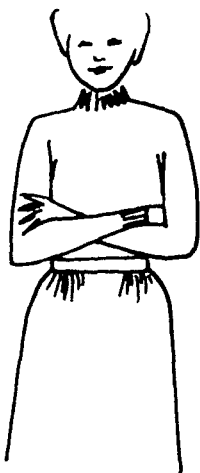

Yokes

Many of today's designs use yokes. They can be added easily to bodices, skirts, or pants. Some yoke seams are fitting seams. Others are simply design lines.

Design lines can be added in any location and in any shape. As you are drawing yoke lines, remember that a yoke you wish to be straight across the garment should cross the center front or back at right angles. A dip or peak at the center line will cause an odd shape at that point.

To make a yoke pattern, analyze the design to determine where the yoke line should be located. Look carefully at where it comes in relation to other major seams and fitting points on the garment.

- Draw a line where you want the yoke seamline on the pattern. Place a notch on the line. Cut.
- Add seam lines to both parts of the pattern.
- Draw the grainline on the yoke. You may wish to place the yoke on the bias for special effect.

To make a yoke line with dart originating at yoke, move the bust-fitting dart to the new location and draw in dart stitching lines as shown on page 7.

- Fold in the dart and draw the yoke line.
- Place notches on the yoke line.
- Cut the pattern apart on the yoke line.
- The dart in the yoke will remain closed, so tape it shut.
- Open the "shoulder" dart in the bodice. This can be converted to gathers. You may also wish to convert the waist-fitting dart to gathers to repeat the design theme of the yoke area.

Add seam allowances and notches to the two parts of the pattern.

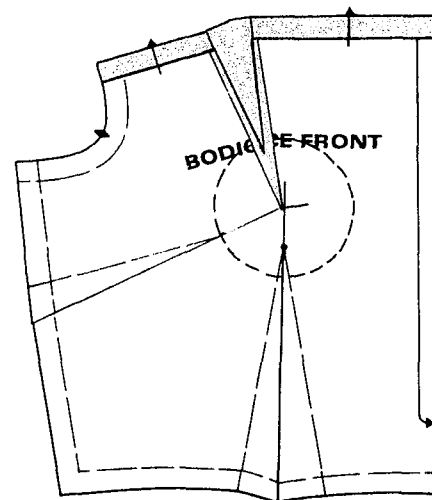
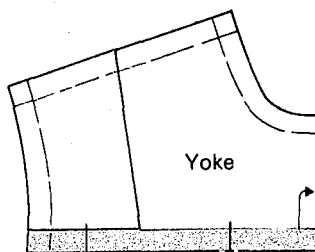
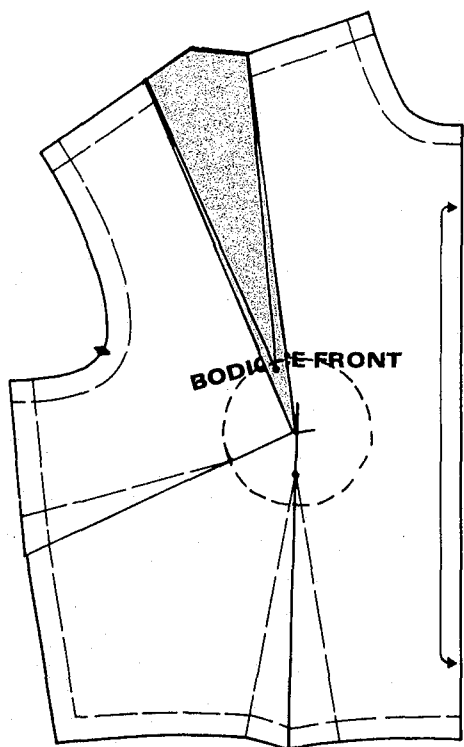
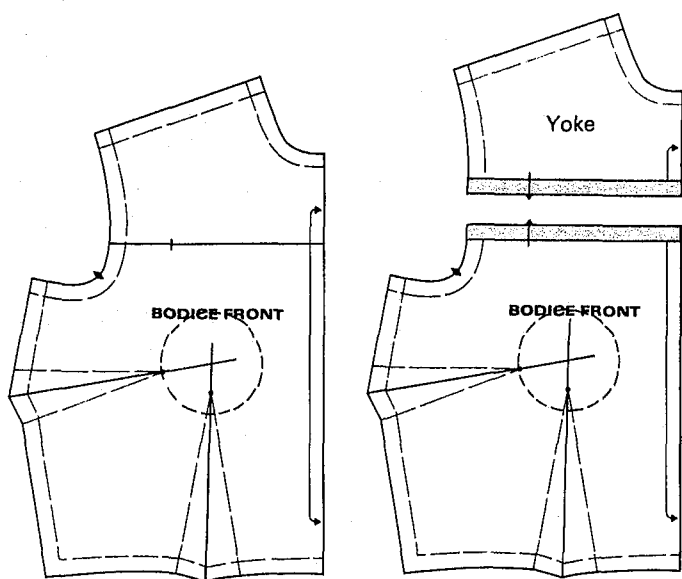

To move darts to the yoke seamline, remember that if the yoke line crosses a pivot point in either a skirt or a bodice, the dart can be lengthened to the pivot point and moved to the yoke line. In the finished pattern, it looks as if the dart has been eliminated, but it is included in the seam.

- Lengthen the dart to the pivot point, mark a new dart line, add a notch, cut the new dart line from the side seam (illustr. a), and fold the original dart closed. Tape (illustr. b).
- Draw the new yoke line and add notches.
- Cut the pattern apart on the yoke line.
- Add seam allowances and markings (illustr. c).

The completed skirt is shown in illustration (d).

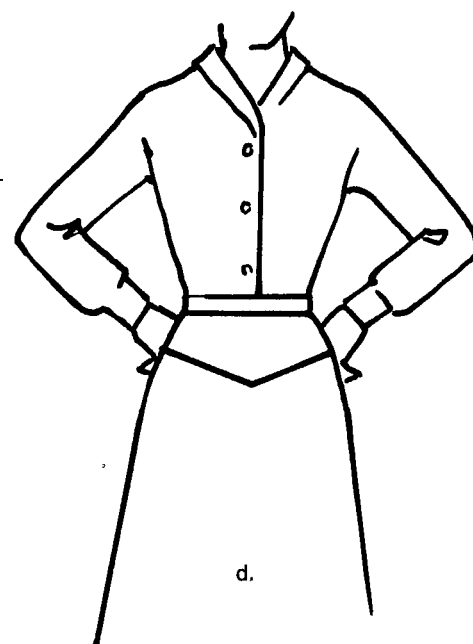
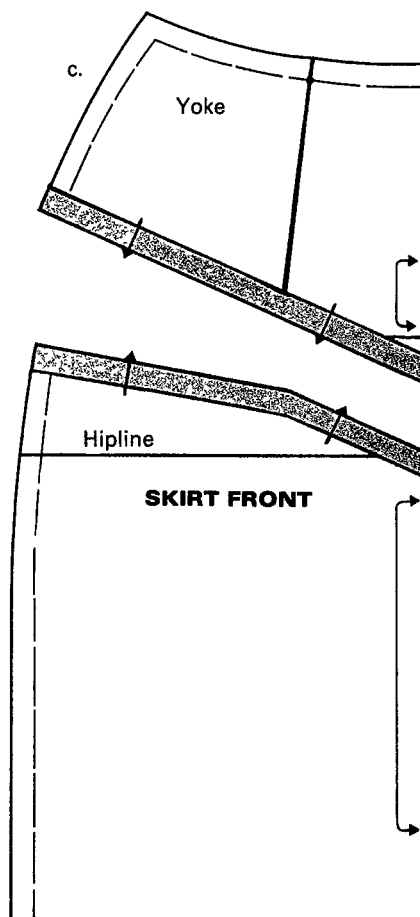
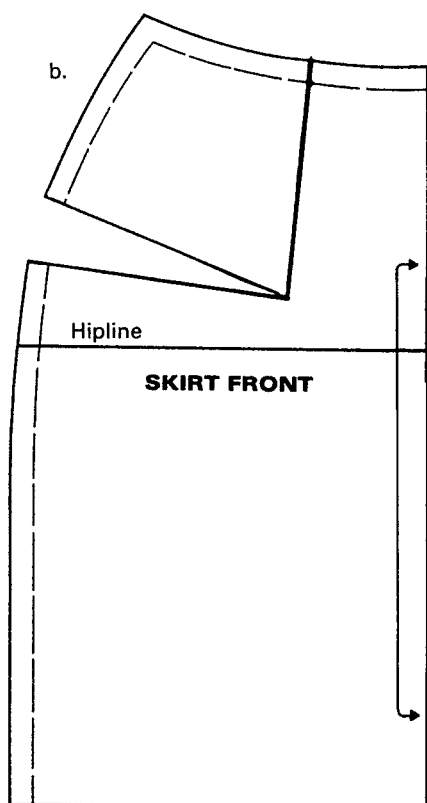
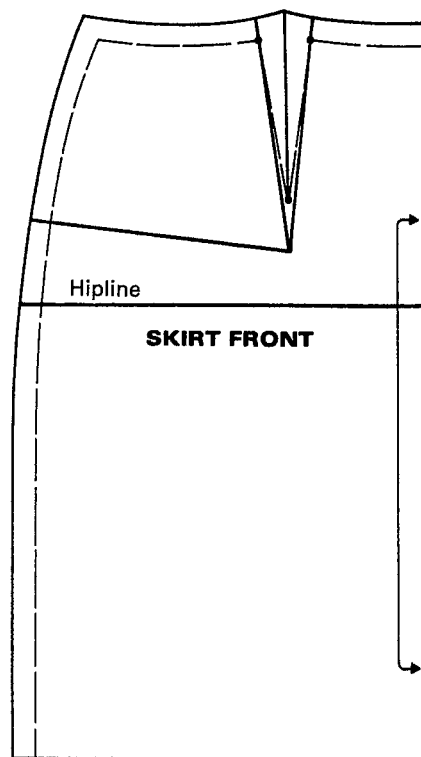

Seamlines as Fitting Lines

One of the primary seams used in fitting is the princess seam. For a seam line to be a fitting line it must point to the bust point, extend to the bust, or cross over the bust point. In the basic princess seam, both the waist-fitting and the bust-fitting darts are incorporated in a seam that crosses directly over the bust point. The bust-fitting dart is moved to the armhole or shoulder seam to accomplish this.

To make a princess line pattern, analyze the design. In this case the bust-fitting dart must be moved to the armhole. The waist-fitting dart should be moved over, if necessary, to achieve a pleasing line. Always begin with a pattern that fits you so the fullest part of the pattern will fit the fullest part of the bust.

- Draw a smooth curve from the armhole to the bust point. Put notches on the pattern above and below the bust circle.
- Move the bust-fitting dart to the armhole position. Move the waist-fitting dart if necessary.
- Draw the grainline on the side bodice pattern parallel to center front.

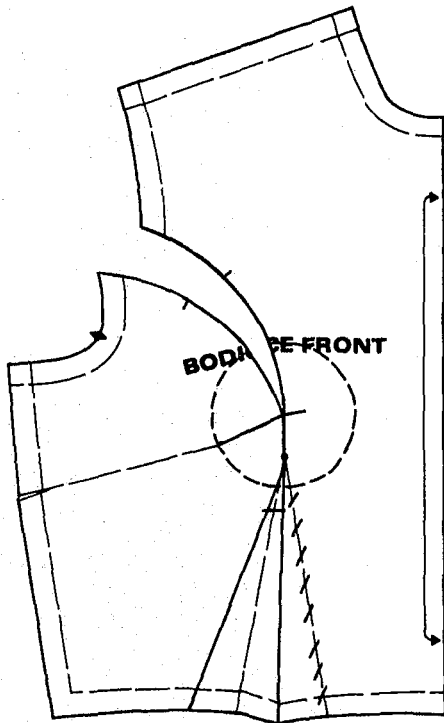
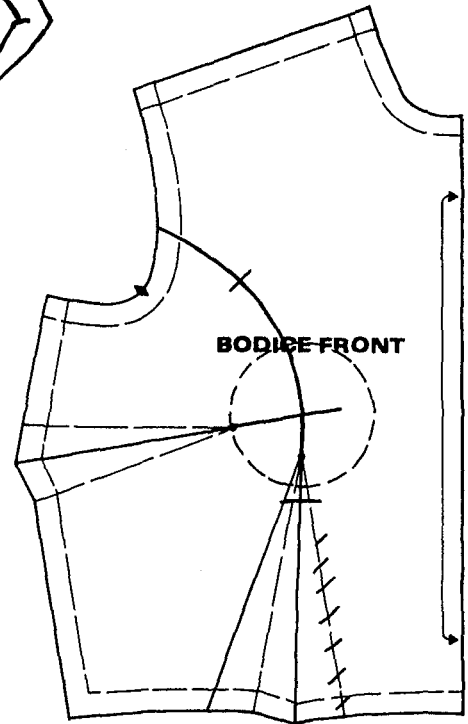
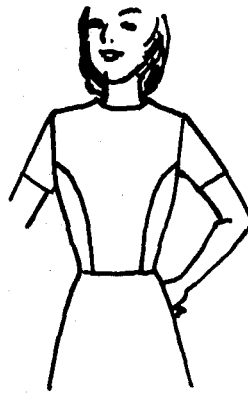

- Separate the pattern pieces, and add seam allowances.

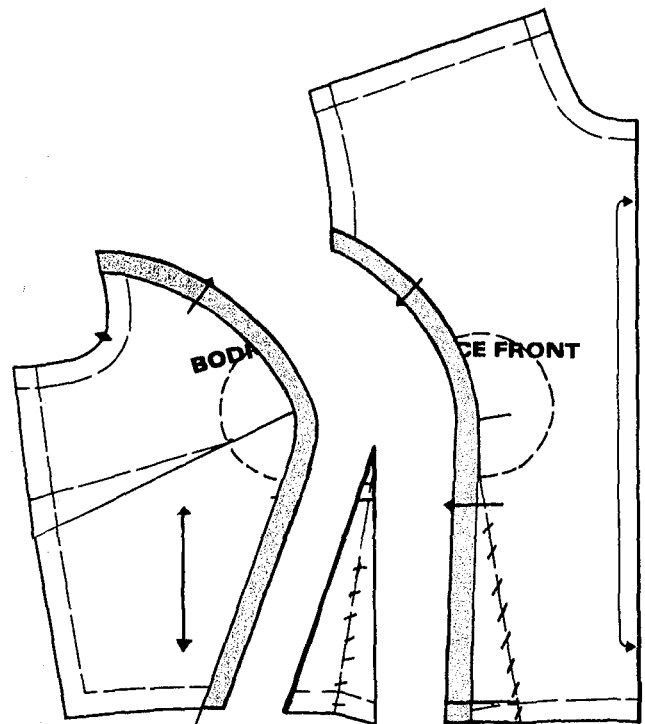

Necklines

The neckline can be changed to any position or shape you wish. Generally, the neckline can be lowered at the shoulder, the center (front, or back), or all around. To decide how your newly designed neckline will look pin the neckline shape on a bodice with a basic neckline. Check to see that the general shape and position of the lowered neckline is becoming. Remember that a new facing is needed for the new neckline. With a lowered neckline you may not need a zipper or other closure. A shorter zipper would look better if a zipper is still needed. If buttons are used as a closure on a garment with a lowered neckline, respace the buttons and buttonholes as described on page 4.

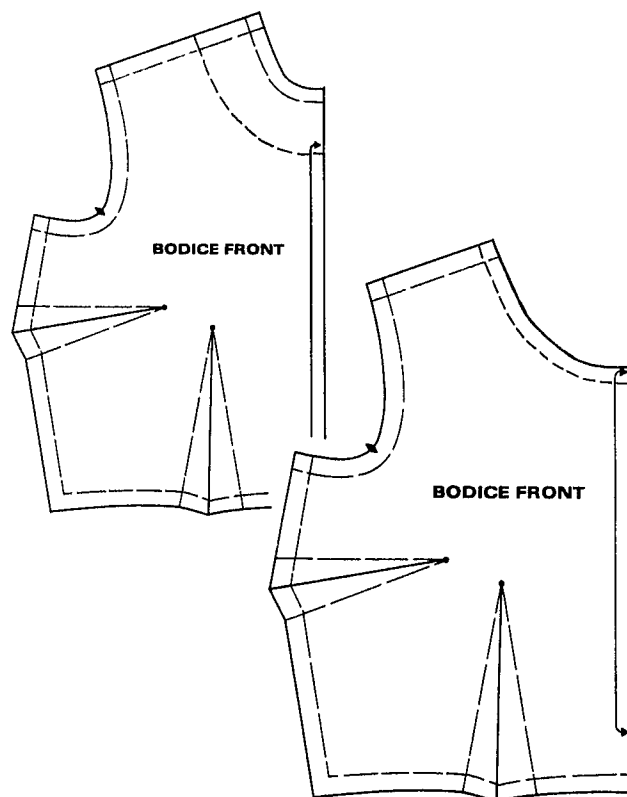

To lower a neckline, draw the new neckline shape on the pattern. If needed, make changes on both front and back. Be sure to keep the front and back shoulder seam in proportion. Remember that there may be ease in the back shoulder seam. Cut off the unneeded part of the pattern. Add seam allowance to new neckline.

Make pattern for neck facing as shown on page 5.

To prevent gaping neckline, tighten the neckline by removing $\frac{1}{4}$ " (6 mm) length from the neck-shoulder point.

Another way to remove some of the looseness at the neckline is to move that looseness to the dart area.

- Hold the pattern up to your body. Pinch out the excess fullness in the neckline. Measure this amount.
- Slash pattern from lower neckline curve to the bust point and through both fitting darts to the bustpoint.
- Lap pattern at the neckline the amount you pinched out of the pattern neckline. Let the pattern spread at both dart lines.
- Reshape darts and neckline as needed. Add seam allowance to the neckline.
- Make appropriate changes in the neck facing.

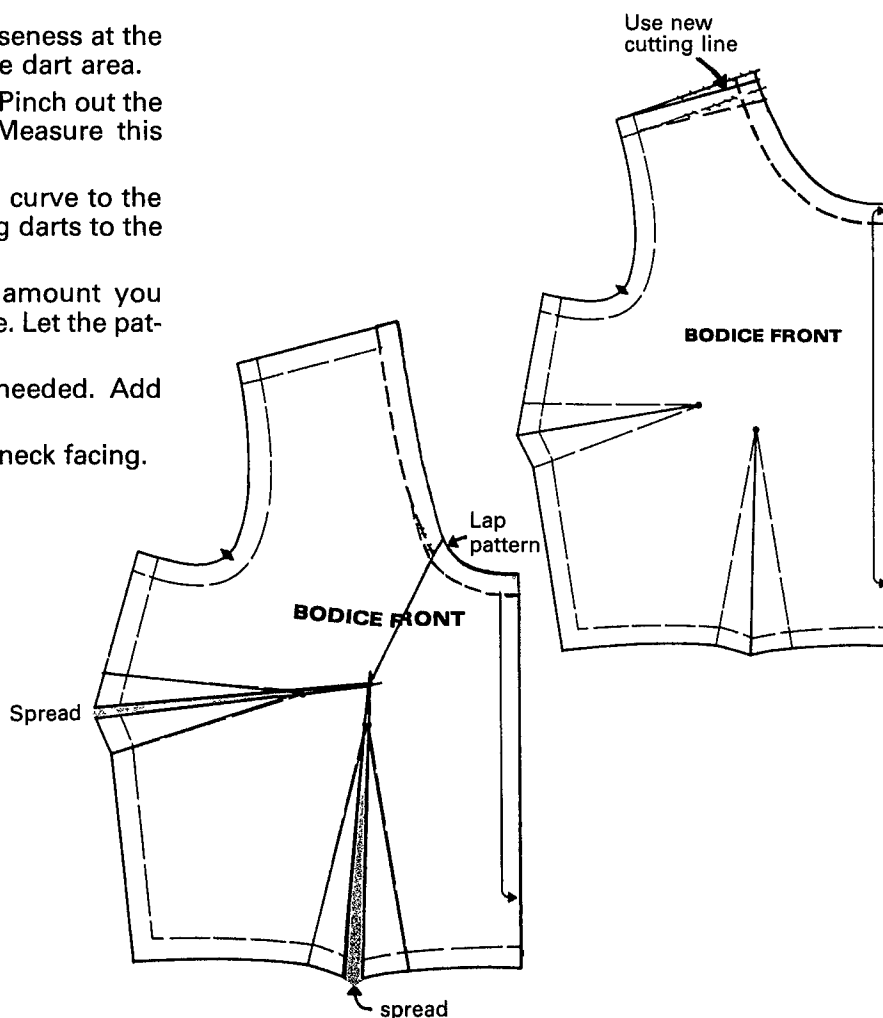

Collars and Sleeves

Collars and sleeves can be designed but you may prefer to use patterns for collars and sleeves which you have from purchased patterns. Generally, collar and sleeve patterns can be interchanged between garment patterns as long as you are working with a basic neckline and armhole. Be sure to use patterns that are the same size, and when possible, from the same pattern company. If the pattern necklines or armholes are not the same, use the neckline (or armhole) that goes with the collar (or sleeve) that you are using.

COLLARS:

A few basics which may help if you want to design collars:

- The neckline seam on a collar should be $\frac{1}{4}$ " (6 mm) shorter than the bodice neckline seam from center front to center front. To check the length of the neckline seam stand your tape measure on its edge as you measure.
- A flat collar has a neckline seam similar in shape to the bodice neckline.

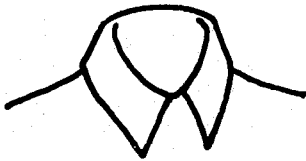

Full-roll collar



Partial-roll collar



Flat collar



Comparison of the shape of the neckline edge of the collar patterns.

The straighter the neckline seam, the more roll the collar will have.

The flatter the collar, the wider it can be and the more you can vary the shape of the outer edge. For example, a sailor collar is a flat collar.

To design a flat collar, place the bodice front and back patterns together at the shoulder seam, overlapping the outer end of the shoulder seam $\frac{3}{4}$ " (2 cm).

- Trace the neckline and mark the shoulder seam location.
- Draw the outer edge of the collar in a smooth curve. The width of the collar may vary with your design. An adult flat collar is often 3" (7.5 cm) wide.
- Add seam allowances and label collar.

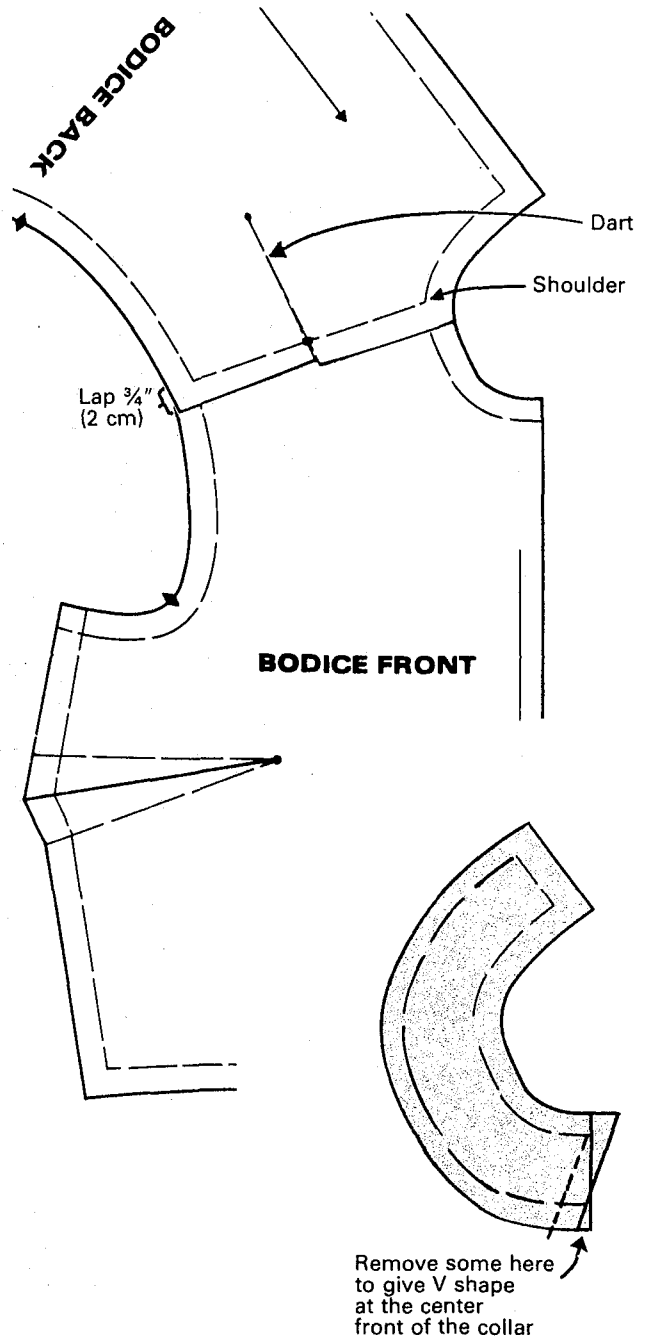

SLEEVES:

A basic sleeve can be changed to give it more fullness and different shape. You can add fullness at the bottom or top.

To add fullness at the sleeve bottom,

- Begin with a short sleeve pattern.
- Slash the pattern from the lower edge to the sleeve cap seamline. Clip in on seam allowance to seam line so the pattern will be flat.
- Spread the pattern the same amount on both sides of the center of the sleeve.

Refer to the chart on page 12 for suggestions on the amount of fullness to add. Becoming fullness depends on fabric, design, and figure size.

- Sketch a smooth curve for the bottom of the sleeve, adding a little length at the center.

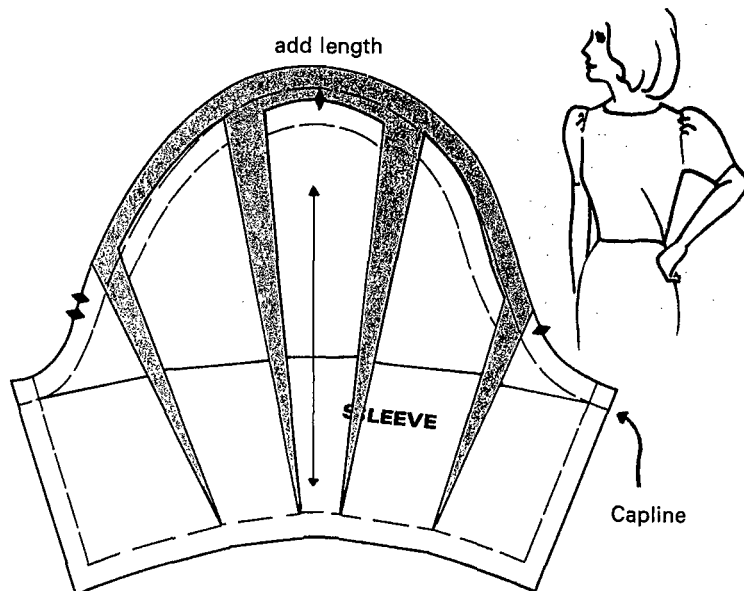
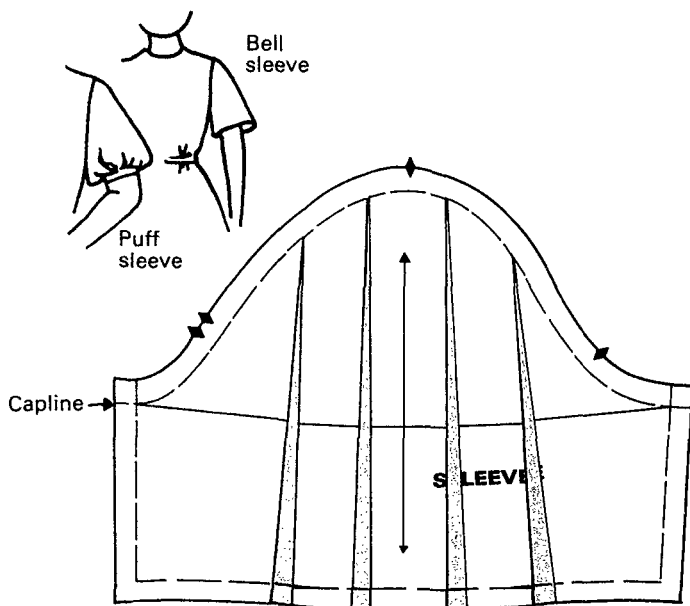

To gather at the top,

- Begin with a short sleeve pattern.
- Slash through the sleeve cap to the lower edge.
- Spread the sleeve cap the same amount on both sides of the sleeve. Refer to the chart on page 12 for suggestions on the amount of fullness to add.
- Add length to the sleeve cap as shown to allow it to puff.
- Face or bind the lower edge of the sleeve.

To design a drop shoulder (or cap sleeve), design it either beginning with a kimono sleeve bodice or a basic armhole. This sleeve is actually a very short version of the kimono sleeve.

When working with a basic armhole, tape tissue paper under the armhole, extend the shoulder seam line to the length you want in the new sleeve. Lower the armhole about 1" (2.5 cm). If you are heavy you may need to lower it more. Connect the shoulder line to the lowered armhole with a straight or slightly curved line. When working with a kimono sleeve, shorten the sleeve to the length you want.

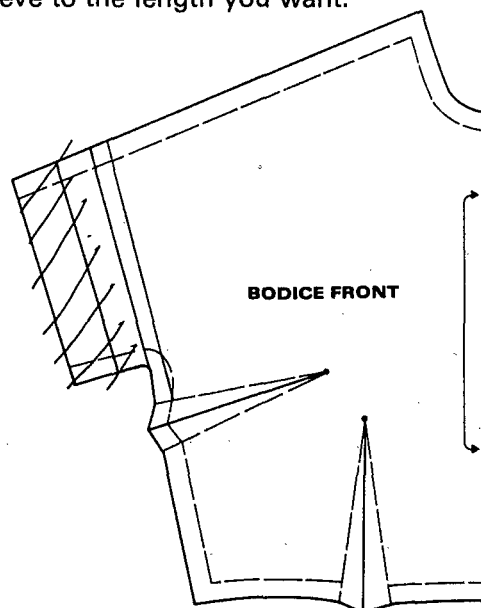
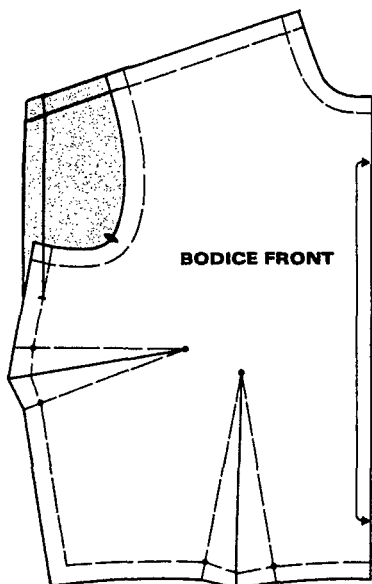

Pockets

Pockets are an easy design feature to add to garments. Patch pockets can be any shape and size. In designing patch pockets, be sure that the size and placement are becoming to your figure. To be functional, a pocket should be deeper than it is wide.

To make slanted skirt or pants pockets, you need a pattern for the pants/skirt front, the pocket, and the pocket facing. Make all three patterns at once by using two layers of paper under the pant/skirt pattern as the pocket is designed.

- Pin 2 layers of paper under the pocket area of the pant/skirt pattern.
- Design the top line of the pocket and the line for the shape and depth of the pocket. Trace these lines onto all 3 layers with a tracing wheel. Draw the grainline in the pocket area the same as the pant/skirt grainline.
- Cut the pants/skirt pattern and one layer of paper on the top line of the pocket. Cut the two bottom layers of paper on the line indicating the bottom of the pocket. Complete pattern pieces by adding seam allowances.

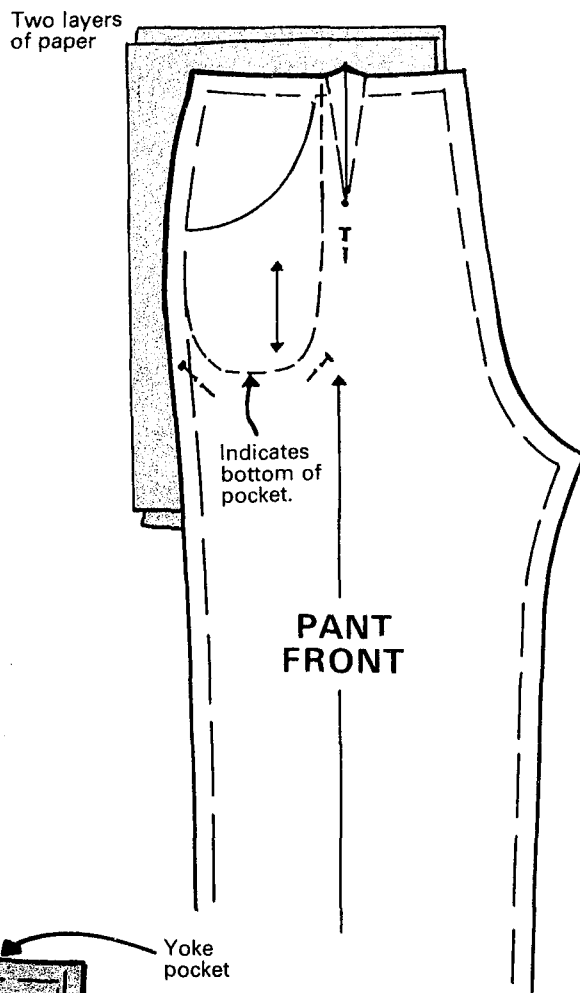
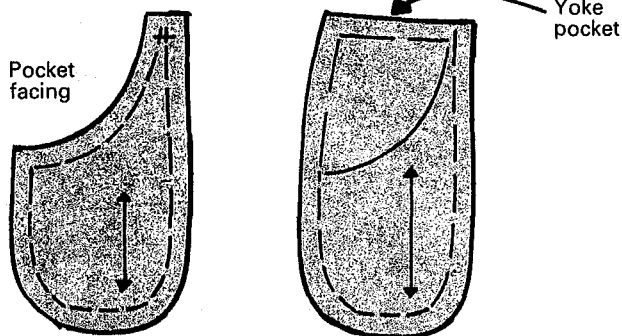

References

Only basic flat pattern designing techniques have been included here. For more help with flat pattern designing, check your local library for the following books:
Pattern Making by the Flat Pattern Method, Norma Hollen, Burgess Publishing Company.
Design Your Own Dress Patterns, Adele P. Margolis, Doubleday & Company.

Flat Pattern Design, Allyne Bane, McGraw-Hill Book Company.
Patterngrams—How to Copy Designs at Home, Nancy Olson, Fairchild Publications, Inc.

