

Evaluation of the E-TRAN Vehicle Propulsion Concept

CTS
TL
152.8
.H46
1994

UNIVERSITY OF MINNESOTA

CENTER FOR
TRANSPORTATION
STUDIES
.....

Research

Acknowledgements

The authors wish to acknowledge support of this work from the Minnesota Department of Transportation (Mn/DOT) and the University of Minnesota's Center for Transportation Studies (CTS) under Contract # 69777. Also, we acknowledge the assistance of Mr. Nicholas R. Musachio of E-TRAN, Inc., the inventor of the E-TRAN concept, in providing detailed reference information.

Report Documentation Page

1. Report No. MN/RC-94/03		2.		3. Recipient's Accession No.	
4. Title and Subtitle Evaluation of the E-TRAN Vehicle Propulsion Concept			5. Report Date January, 1994		
			6.		
7. Author(s) Michael P. Hennessey and Max Donath			8. Performing Organization Report No.		
9. Performing Organization Name and Address Department of Mechanical Engineering Center for Advanced Manufacturing, Design and Control and the Center for Transportation Studies University of Minnesota 111 Church Street S.E. Minneapolis, Minnesota 55455			10. Project/Task/Work Unit No.		
			11. Contract(C) or Grant(G) No. (C) Mn/DOT 69777-90		
12. Sponsoring Organization Name and Address Minnesota Department of Transportation Office of Research Administration 117 University Avenue St. Paul Minnesota, 55155			13. Type of Report and Period Covered Final Report 1992-1993		
			14. Sponsoring Agency Code		
15. Supplementary Notes					
16. Abstract (Limit: 200 words) <p>The viability of the patented E-TRAN electric roadway and vehicle concept was examined from an engineering systems point of view. Specific recommendations are made regarding the end-usage and development of the propulsion concept. Based on this study, two research areas were identified and investigated in more detail: (a) quantify the auxiliary power needs due to power input discontinuities and (b) the dynamic effects of road pantograph bounce.</p> <p>Auxiliary power needs arise because of power input discontinuities, either due to: (1) power strip segment failures, (2) lane changing, and/or (3) E-TRAN grid discontinuities, which includes getting the vehicle to and from the grid. Simulation results indicate that power strip segment failures will have the least effect on system performance. E-TRAN grid discontinuities will have serious effects on the system while the effects of lane changing will affect performance at a level in between the other two.</p> <p>The dynamic effects of a road pantograph in contact with a road mounted power strip was also studied, first using simulated models and then verified by experiment. From a mechanical point of view, key issues that affect the design include friction, wear and dynamic bounce effects. Since good correspondence was achieved between the experimentally measured and simulated support forces and pantograph angular displacement, the models can be used for future design analysis.</p>					
17. Document Analysis a. Descriptors electric vehicles dynamics electrified roadways pantograph			18. Availability Statement No restrictions. Document available from: National Technical Information Services, Springfield, Virginia 22161.		
19. Security Class (this report) Unclassified		20. Security Class (this page) Unclassified		21. No. of Pages 56	22. Price

**Evaluation of the E-TRAN Vehicle
Propulsion Concept
Final Report**

by

Michael P. Hennessey
Max Donath
Department of Mechanical Engineering
Center for Advanced Manufacturing, Design and Control
and the Center for Transportation Studies at the
University of Minnesota
111 Church Street S. E.
Minneapolis, Minnesota 55455

January 1994

Submitted to

MINNESOTA DEPARTMENT OF TRANSPORTATION
OFFICE OF RESEARCH ADMINISTRATION
117 UNIVERSITY AVENUE 2nd FLOOR
ST. PAUL, MINNESOTA 55155

This report represents the results of research conducted by the authors and does not necessary reflect the official views or policy of the Minnesota Department of Transportation. This report does not contain a standard or specified technique.

Summary

In this report, we describe the patented E-TRAN electric roadway & vehicle concept and then proceed to evaluate the viability of the concept from an engineering point of view. First a systems engineering study was performed to address high level and certain logistical issues. The applicability of the propulsion concept is assessed for different market areas parameterized by top vehicle speed and vehicle mass (e.g. low speed, high mass, etc). A comparison is made between other competing or similar concepts. Specific recommendations are made regarding the end-usage of the propulsion concept and future recommended development of the technology. In summary, it was discovered that electrical safety and reliability and maintainability of the power strip/road pantograph concept pose serious practical problems. Because of this and other specified reasons, the E-TRAN concept at its present stage can only be considered for the case of low speed, small mass vehicles (e.g. factory vehicles, go-carts and the like). In spite of our critical remarks in certain technical areas, we believe that the E-TRAN technology has a future for various pockets of the transportation sector (certainly for the applications listed and possibly more) and encourage them to proceed wisely to exploit the opportunities available to them, starting out with the more tractable applications. Based on this system engineering study, two follow-on research areas were identified and examined in more detail: quantifying the auxiliary power needs due to power input discontinuities and the dynamic effects of road pantograph bounce.

The auxiliary power needs were studied for a typical near term application of this propulsion concept. Auxiliary power needs arise because of power input discontinuities, either due to: (1) power strip segment failures, (2) lane changing, and/or (3) E-TRAN grid discontinuities, which includes getting the vehicle to and from the grid. These effects are simulated using a dynamic model of a typical vehicle (i.e. a Ford Aerostar van) combined with the corresponding inverse dynamic model and a function simulating the particular type of power input discontinuity. Quantitative simulation results indicate that the power strip segment failures are the least severe on performance, lane changing is a more severe effect, and finally, the E-TRAN grid discontinuities are the most problematic.

The dynamic effects of a road pantograph in contact with a road mounted power strip was also studied. During usage, the road pantograph located beneath the vehicle allows power to be drawn from the power strip for use in powering the motor driven vehicle. From a mechanical point of view, key issues pertain to friction, wear and dynamic bounce effects which impact the reliability and maintainability of the pantograph/strip concept. A dynamic model of a 1 degree of freedom road pantograph was developed for both contact and noncontact (i.e. bounce) situations. These dynamic "bounce" effects were simulated using a dynamic model of the road pantograph and associated road surface and strip conditions. To corroborate the dynamic model and address pantograph design issues, an instrumented experimental pantograph/road simulator was fabricated. Good correspondence was achieved between the experimentally measured and simulated support forces (peak-peak within 17 %) and pantograph angle (within 2 %). As a result, the model is a good basis for future design studies. To illustrate use of model, key parameters that influence the design were studied through simulation for the nominal pantograph that was constructed.

Introduction

1. Brief E-TRAN Concept Description

Conceptually, E-TRAN (as described in the company literature and patent [8,7] -- see Appendix A) offers a means of allowing people to use an ordinary vehicle and roadway (with minor modifications) while realizing the benefits of being "plugged-in" to the local power company. These benefits include:

- Low operating cost,
- Energy efficiency, and
- Low air pollution

Each vehicle is equipped with a motor & controls, transmission, and appropriate electrical contacts (see Figure 1). The roadway has a sequence of segmented power strips mounted to it which are powered as the vehicle passes over them. A power switching device, driven by road embedded vehicle presence sensors switches power on and off to the appropriate strips at the appropriate time. Proper rectification resolves polarity issues. Unlike tracked systems, steering is allowed as in an ordinary automobile. A "floating ground" idea is used in the interests of safety. To date, the E-TRAN concept has been prototyped on several "go-carts" and a full size vehicle (see Figure 2).

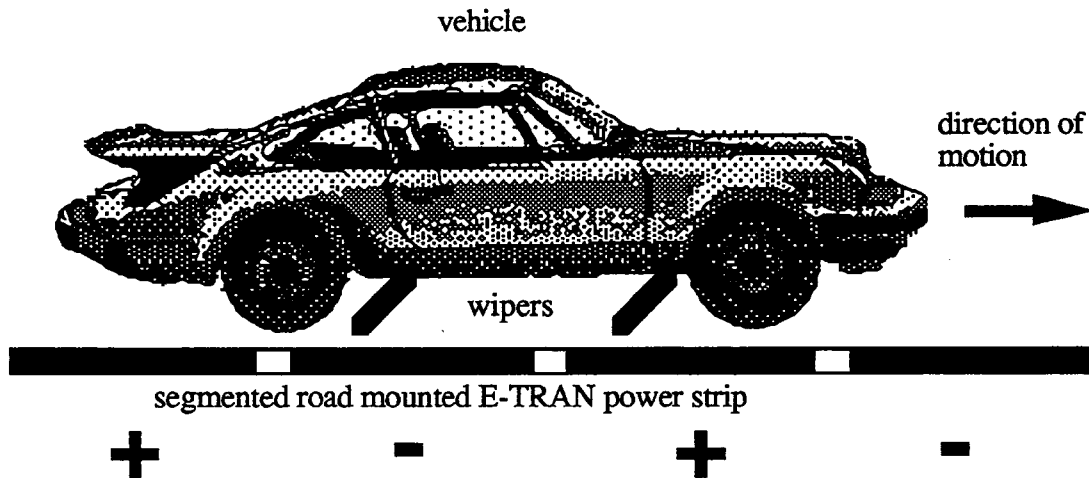

Figure 1 E-TRAN vehicle propulsion concept.

E-TRAN differs from other electric vehicle concepts such as battery powered vehicles and the inductively coupled electric roadway concept developed by the University of California at Berkeley, the Lawrence Livermore National Laboratory, and others [1,2,6,9]. Unlike battery powered vehicles, E-TRAN does not have a limited range (as long as the vehicle remains on the E-TRAN power grid), although it depends on the existence of a road mounted power strip. One key conceptual technical difference

between E-TRAN and the inductively coupled electric roadway concept is the need for reliable mechanical contacts (i.e. "wipers" or road "pantographs") between the roadway and the vehicle.



(a) IZUZU Trooper equipped with E-TRAN system including prototype pantographs

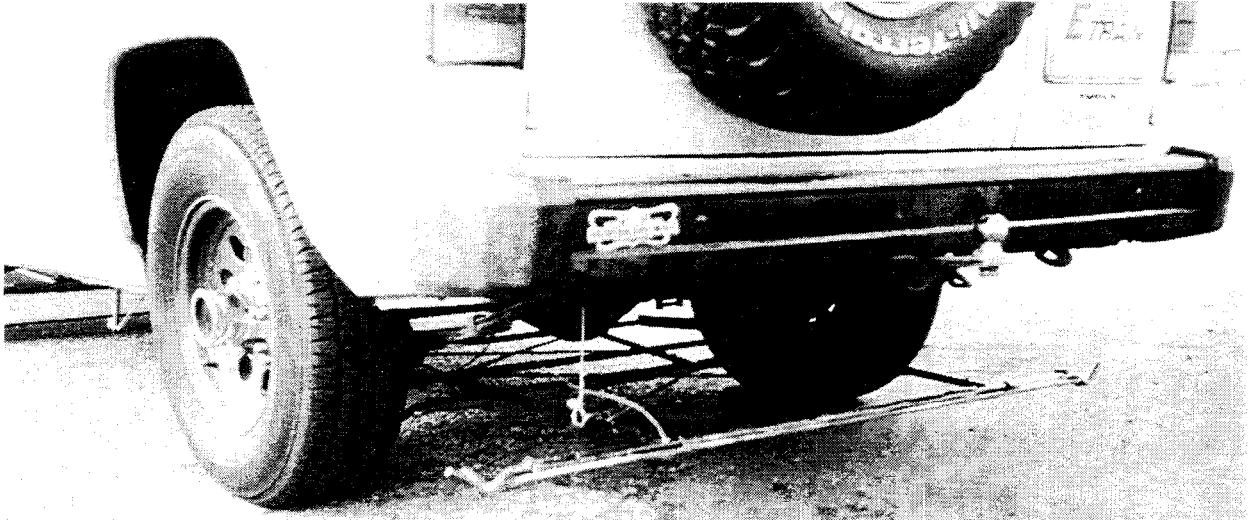

(b) enlarged view of prototype pantograph system on IZUZU Trooper

Figure 2 E-TRAN vehicle propulsion concept applied to an IZUZU Trooper.

2. General Evaluation Approach

Since its initial concept development, E-TRAN has been proposed as a panacea for solving the energy and environmental problems of the transportation industry. It has been proposed for use on automobiles, buses, and as a light rail substitute. Advantages over competing technologies such as gasoline engines, battery powered vehicles, solar powered vehicles, and light rail transit are cited (see Appendix A ([8,7])). Much of the analysis implicitly assumes that the basic technology is viable and that it can be ubiquitously applied to ground based transportation systems with only minor customization issues to reckon with. At the beginning of this project there was a significant amount of interest in the technology because of the potential benefits if proven successful. Emphasis (by E-TRAN, Inc. and others) was on high level system issues; e.g. energy savings, cost per lane mile, how to meter the power usage, etc.

Our charter is to independently evaluate the viability of this technology from an engineering point of view. Fundamental issues (primarily electrical and mechanical) relevant to the problem are examined. We will analyze the applicability of the E-TRAN concept to the many different ground based transportation markets with emphasis on *both* high level system issues and fundamental mechanical and electrical issues. A portion of this report is an update of a preliminary evaluation performed in 1992 (Hennessey and Donath [4]) and material presented at the 4th University of Minnesota Center for Transportation Studies Research Conference [3].

3. Overview of Report

The evaluation effort is comprised of three separate but related activities. It begins with a System Engineering Study. The applicability of the propulsion concept is assessed for different market areas parameterized by top vehicle speed and vehicle mass.

Based on the study, two specific research problems were investigated. These were: Auxiliary Power Needs for the E-TRAN Electric Roadway & Vehicle Transportation Concept and Experimental Verification of a Road Pantograph Dynamic Model. These research problems were selected because they address fundamental issues relevant to the E-TRAN concept (e.g. reliability and maintainability), are independent of any particular design, represent a well-defineable piece of work, and fit well within the evaluation charter and level of effort committed to the project.

Auxiliary power needs arise because of power input discontinuities, either due to: (1) power strip segment failures, (2) lane changing, and/or (3) E-TRAN grid discontinuities, which includes getting the vehicle to and from the grid. Also, from a mechanical point of view, key issues pertain to friction, wear and dynamic bounce effects which impact the reliability and maintainability of the pantograph/strip concept.

Finally, the report ends with a Summary and Conclusions along with several appendices containing supporting information related to E-TRAN (contained in a less formal, separate document to minimize publication costs; the Appendices are available directly from the authors).

4. Bibliography

- [1] Berman, N., "Roadway Vehicle," *U.S. Patent No. 4,129,203*, issued December 12, 1978, filed June 13, 1977.
- [2] Bolger, J. G., and Kirsten, F. A., *Investigation of the Feasibility of a Dual Mode Electric Transportation System*, Lawrence Berkeley Laboratory, Berkeley, CA, Report LBL-6301, 1977.
- [3] Donath, M. and Hennessey, M., "E-TRAN Vehicular Technology Assessment," 4th Annual Transportation Research Conference, Minneapolis, MN, May 19-20, 1993.
- [4] Hennessey, M., and Donath, M. "Quantifying Auxiliary Power Needs for the E-TRAN Electric Vehicle Propulsion Concept," ISI Annual User's Conference on the MATRIXTM Product Family, San Jose, CA, March 16, 1993.

- [5] Hennessey, M. and Donath, M., "The E-TRAN Vehicle Propulsion Concept: First Impressions," *Internal Memo -- The Productivity Center and the Center for Transportation Studies at the University of Minnesota*, September 15, 1992.
- [6] Lechner, E. H. and Shladover, S. E., "The Roadway Powered Electric Vehicle -- An All-Electric Hybrid System," VIII International Electric Vehicle Symposium, Washington, D.C., October 1986.
- [7] Musachio, N. R., "Electric Vehicle Transportation System," *U.S. Patent No. 5,045,646*, issued September 3, 1991, filed July 20, 1989.
- [8] Musachio, N. R., *E-TRAN -- The Electric Vehicle Roadway*, E-TRAN, Inc. company literature, St. Paul, MN.
- [9] Walter, C. E. and Salisbury, J. D. "Roadway Powered Electric Vehicle Performance," SAE International Congress and Exposition, Detroit, MI, February 28 - March 4, 1983.

Table of Contents

Page Number

Section I: System Engineering Study

Abstract.....	1
1. Introduction -- General Approach.....	2
2. Possible Market Niche for E-TRAN.....	2
2.1 Market Parameters.....	2
2.2 Case 1 -- High Mass, High Speed.....	3
2.3 Case 2 -- Low Mass, High Speed.....	9
2.4 Case 3 -- High Mass, Low Speed.....	9
2.5 Case 4 -- Low Mass, Low Speed.....	10
3. Comparison with Other Approaches.....	11
4. Summary of E-TRAN Market Niche.....	12
5. Specific Recommendations/Other Observations.....	13
6. Bibliography.....	16

Section II: Auxiliary Power Needs for the E-TRAN Electric Roadway & Vehicle Transportation Concept

Abstract.....	17
1. Introduction.....	19
2. Dynamic Vehicle Power Model.....	19
2.1 Standard Vehicle Dynamic Model.....	19
2.2 Incorporating Vanishing Power Input Discontinuities.....	20
2.3 Additional Modeling Details.....	20
3. Specific Simulation Studies.....	21
3.1 Power Strip Segment Failures.....	21
3.2 Lane Changing.....	24
3.3 Grid Discontinuities.....	27
4. Summary and Conclusions.....	27
5. Bibliography.....	29

Section III: Experimental Verification of a 1 Degree of Freedom Road Pantograph Dynamic Model

Abstract.....	30
1. Introduction.....	33
2. Specific Objectives.....	33
3. 1 Degree of Freedom Pantograph Dynamic Model.....	33
3.1 Contact Model.....	34
3.2 Noncontact Model.....	35
4. Simulation Issues.....	36
5. Pantograph/Road Simulator.....	38
6. Experimental Results.....	39
7. Simulation Results.....	40
8. Summary and Conclusions.....	44
9. Bibliography.....	45

Summary and Conclusions.....	46
------------------------------	----

Volume II: Appendices (Available directly from the authors)

- A. E-TRAN Literature
- B. National Electric Code
- C. Some Competing Concepts
- D. Schunk Graphite Technologies Comments on the Pantograph Technology for E-TRAN
- E. MATRIXx™ Superblocks (Power Study)
- F. E-TRAN Simulation Parameters (Power Study)
- G. MATRIXx™ Superblocks (Pantograph Dynamics)
- H. Road Pantograph Test Machine Design Requirements
- I. Road Simulator Concepts
- J. Road Pantograph/Power Strip Test Machine Mechanical Drawings
- K. LabVIEW Panel and Diagram for Pantograph Data Acquisition
- L. E-TRAN Vehicle Propulsion Technology Assessment Proposal
- M. Quarterly Progress Reports
- N. Example of an Engineering Scale Effect

Section I

Evaluation of the E-TRAN Vehicle Propulsion Concept -- System Engineering Study

Abstract

The applicability of the E-TRAN propulsion concept is assessed for different market areas parameterized by top vehicle speed and vehicle mass (e.g. low speed, high mass, etc). Comparison between other competing or similar concepts is performed as well. Specific recommendations are made regarding the end-usage of the propulsion concept and advice given regarding development of the technology. In summary, it was discovered that electrical safety, reliability and maintainability of the power strip/road pantograph concept pose serious practical problems. Because of this and other specified reasons the E-TRAN concept at its present stage can only be considered for the case of low speed, small mass vehicles (e.g. factory vehicles, go-carts and the like). In spite of our critical remarks in certain technical areas, we believe that the E-TRAN technology has a future for various pockets of the transportation sector (certainly for the applications listed and possibly more) and encourage them to proceed wisely to exploit the opportunities available to them, starting out with the more tractable applications. Based on this study, two follow-on focused research areas were identified and examined in more detail: quantifying the auxiliary power needs due to power input discontinuities and the dynamic effects of road pantograph bounce.

1. Introduction -- General Approach

Since its initial concept development, E-TRAN has been proposed as a panacea for the transportation industry. It has been proposed for use on automobiles, buses, and as a light rail substitute. Advantages over competing technologies such as gasoline engines, battery powered vehicles, solar powered vehicles, and light rail transit are cited (see Appendix A ([8,7])). Much of the analysis implicitly assumes that the basic technology is viable and that it can be ubiquitously applied to ground based transportation systems with only minor customization issues to reckon with. At the beginning of this project, there was a significant amount of interest in the technology because of the potential benefits if successful. Emphasis (by E-TRAN, Inc. and others) was on high level system issues; e.g. energy savings, cost per lane mile, how to meter the power usage, etc.

Our charter is to independently evaluate the viability of this technology from an engineering point of view. We will examine fundamental mechanical and electrical issues relevant to the problem (versus only high level system issues). In particular, we will analyze the applicability of the E-TRAN concept to the many different ground based transportation markets with emphasis on *both* high level system issues and fundamental mechanical and electrical issues. This section of the report is an update of a preliminary evaluation performed in 1992 (Hennessey and Donath [5]) and material presented at the 4th University of Minnesota Center for Transportation Studies Research Conference [4].

The system engineering study focuses on:

- Market analysis
- Comparison with other approaches
- Summary of suggested market niche
- Specific recommendations/other observations

The purpose of the market analysis is to attempt to realistically narrow down the range of possible applications. In the interest of objectivity, other approaches are examined as well. Based on the above, a list of suggested requirements for E-TRAN applications is given. Finally, a list of specific recommendations and other observations are noted.

2. Possible Market Niche for E-TRAN

2.1 Market Parameters

In order to compare E-TRAN to other approaches and evaluate it objectively, it is useful to introduce some parameters which suggest a convenient means of categorizing transportation systems. First, this analysis will be restricted to ground-based systems. Secondly, one must not forget what transportation systems do fundamentally; they provide a mechanism for keeping *mass in motion*. Because of this, *dynamics* will play a key role in transportation systems. Practically, one can ask the questions: How much mass? How fast (i.e., speed)? What are the acceleration requirements? To simplify matters, two parameters will be considered as a means of categorizing different ground-based transportation systems:

- Gross vehicle mass,¹ and
- Top vehicle speed.

¹ We will assume that the vehicle is at full capacity

This parameterization, while simplistic, offers considerable insight into where E-TRAN is best suited. For each parameter, one bit of resolution will be introduced to allow reference to a *low* or *high* mass vehicle and to the speed as being *low* or *high*. To quantify matters, the following are assumed:

- High mass > ~ 2000 pounds (e.g., typical weight of cars, buses, etc.)
- Low mass < ~ 2000 pounds
- High speed > ~ 30 mph up to at least 70 mph (i.e., typical highway speeds)
- Low speed < ~ 30 mph (i.e., typical urban traffic speeds)

E-TRAN's applicability to the following 4 cases will now be described:

- Case 1 -- high mass, high speed
- Case 2 -- low mass, high speed
- Case 3 -- high mass, low speed
- Case 4 -- low mass, low speed

2.2 Case 1 -- High Mass, High Speed

Typical existing or near-term systems in this category include:

- Cars, trucks, and buses (battery powered or IC engine variety) and
- High speed rail systems (electric or older technology).

A number of technical issues have been identified for this particular case:

- Electrical safety
- Driving accuracy
- The "lane changing" effect
- Grid discontinuities
- Reliability and maintainability of pantograph/power strip

It is believed that the electrical safety and the pantograph/power strip reliability and maintainability issues are the most critical issues. In the following, we will describe the following issues: electrical safety, driving accuracy, "lane changing" effect, grid discontinuities, and reliability and maintainability of the pantograph/power strip.

Electrical Safety

Due to the high mass and high speed requirements, high power levels will be required to propel the vehicle. This implies high voltages and currents (certainly greater than "touchable" levels). Safety will be an issue anytime there is an exposed live voltage (i.e., typically > 220 VAC) wire on the ground. Mike Griffon of WabCo (a producer of cast iron shoes for trolleys and other related pantograph products; located in Spartanburg, SC) also sees this as an important safety issue. Even though *theoretically*, the E-

TRAN system only powers the strips beneath (or close to) the vehicle for a short period of time (typically a few tens of milliseconds depending on the speed²), system reliability and safety are extremely significant issues that cannot be overemphasized. Specifically, it is critical for the E-TRAN developers to take into consideration the following potential scenarios:

- The occurrence of a sensor failure or false triggering, and/or
- The occurrence of a short in the system, and/or
- The occurrence of a power switching failure in which the wrong strip is powered, and/or
- The occurrence of a traffic accident, and/or
- The occurrence of vandalism

We do not believe that there is any engineered system in use today where during component failure, a member of the general public can readily come in contact with live voltage (and current) lines. Some type of physical isolation must be present. The closest analogy to this type of system would be an electric fence for use in containing farm animals. However, these latter systems are designed so that the shock will definitely not kill.

The electrical safety community has codes and guidelines that apply to this problem. For example, the system is in violation of the National Electrical Code (see [9] or Appendix B). This implies that the lane (or highway) on which E-TRAN is to be installed be designated as an area off-limits to pedestrians (much like high speed rail or subway systems). In other words, the "ordinary" highway will have to have modifications made to it which are likely to be expensive or impractical. Possibilities include a fence or a continuous proximity sensor along the lane which if triggered, disables power to the local strips. (This latter approach is commonly used around industrial equipment). Another alternative is to construct a separate, dedicated E-TRAN lane or highway; however this idea invalidates the premise that E-TRAN can easily mix with existing traffic and highways. Yet another alternative is to significantly reduce the voltage and current levels. However, safe, touchable levels would invalidate the concept for the case of high mass, high speed vehicles.

Driving Accuracy

If the electrical contacts attached to the vehicle are to remain entirely underneath the vehicle (which one would want from a safety and cosmetic point of view), then the required driving accuracy could be affected, especially on vehicles with a small lateral wheel base. For example, for a vehicle with a small lateral wheel base (such as a Ford Festiva), the driver would have to accurately steer within the lane in order to remain on the E-TRAN strip.

Figure 3 illustrates this effect for the case of a Ford Festiva (or other small lateral wheel base vehicles). A typical lane is 12 ft wide (this is standard on many highways). If we assume that the E-TRAN strip is 4" wide (which is typical of subway rails, etc.) and that the vehicle's wiper (or pantograph) spans the full inner width of the vehicle (i.e. 4 ft wide), one can calculate the lateral motion tolerance of the vehicle while simultaneously straddling the powered E-TRAN strip and remaining within the lane (both left and right). The extreme positions of the vehicle (while still on the E-TRAN strip) are shown in Figure 3. The vehicle may laterally move $(48 - 4 / 2) - 48 / 2 = 22"$ from the center of the lane to the right and similarly 22" to the left. We may therefore state the driving accuracy needed to remain on the strip as $\pm 22"$. A practical maximum may be slightly less so let us assume that it is $\pm 20"$. This situation is in contrast to the case where no E-TRAN strip is present, i.e. ordinary driving of a 5 ft wide Ford Festiva where the

² Except at startup (such as in a traffic jam or accident) when the period could last for more than 0.5 - 1.0 second.

lateral tolerance is: $(12 - 5) / 2 \text{ ft} = 42''$ in both directions. Given the lateral tolerances with and without E-TRAN we may calculate the percent reduction in lateral steering freedom when using E-TRAN as: $[(42 - 20) / 42] 100 \% = 52 \%$. This is very significant.

Based on observed driving habits and highway lane widths, the driving accuracy issue raises additional undesirable safety, ergonomic, and road wear issues (such as "channeling"). On curved roads, the effect is even more pronounced and has been observed while driving the current E-TRAN vehicle around a corner. Vehicles such as buses also pose interesting power strip tracking problems.

"Lane Changing" Effect

The ramifications of having a non-flush E-TRAN strip mounted to the roadway must also be considered. Changing lanes at high speeds would introduce additional loading to the vehicle/pantograph/strip system. The severity of the loading is dependent on the pantograph/strip design such as the strip geometry and the pantograph stiffness. This would tend to shorten the life of vehicle suspension components, pose interesting safety and stability problems for existing 2 wheeled vehicles (e.g. motorcycles), and raises safety and reliability problems for drivers of typical automobiles. Based on the experimental pantograph work that was conducted (described below), it was observed that very small surface irregularities (e.g. due to potholes, railroad tracks, speed bumps, and driver "alert" patterns, etc.) can generate large forces, especially as the vehicle speed increases. For this reason, road surface irregularities should be minimized in any design. Finally, note that a flush or sub-pavement level strip (i.e. in a slot) would not allow contact to be easily established and/or contribute to problems with debris buildup in the slot.

Grid Discontinuities

The logistics of getting the vehicle to and from the E-TRAN "grid" and traveling across grid discontinuities introduces additional power source issues. To get to and from the E-TRAN grid, one will still need another source of vehicle power which will lead to an increase in the weight of the vehicle. If batteries are used, it is estimated (by a DOE source) that at least 400 lb of batteries are needed for a 30 mile range and a 1,000 lb vehicle. This requirement will depend on the individual driver's total length of commute to and from the grid. A longer distance spent off the grid and/or a larger vehicle (e.g. > 2,000 lb) will of course increase the weight of the batteries needed. This dependence on other vehicle propulsion modes (and the added weight) reduces the effectiveness of E-TRAN.

We anticipate that it will not be practical to have a continuous grid. This will therefore require a method for handling grid discontinuities. For example, because of the many different pathways through intersections, it is not practical to design an E-TRAN grid geometry that covers all of the possible cases. This will require that there be an additional power mode for allowing vehicles to at least, get through intersections. This issue is even more significant if vehicles are required to accelerate from rest on a steep hill at traffic lights, through intersections without E-TRAN strips available for power. This observation points to a reduction in the independence and effectiveness of the E-TRAN concept and increases its dependence on the availability of a "dual" mode, e.g. batteries. Other examples of grid discontinuities exist, e.g. it will be necessary to span "dead" sections of the E-TRAN strip which have failed for one reason or another.

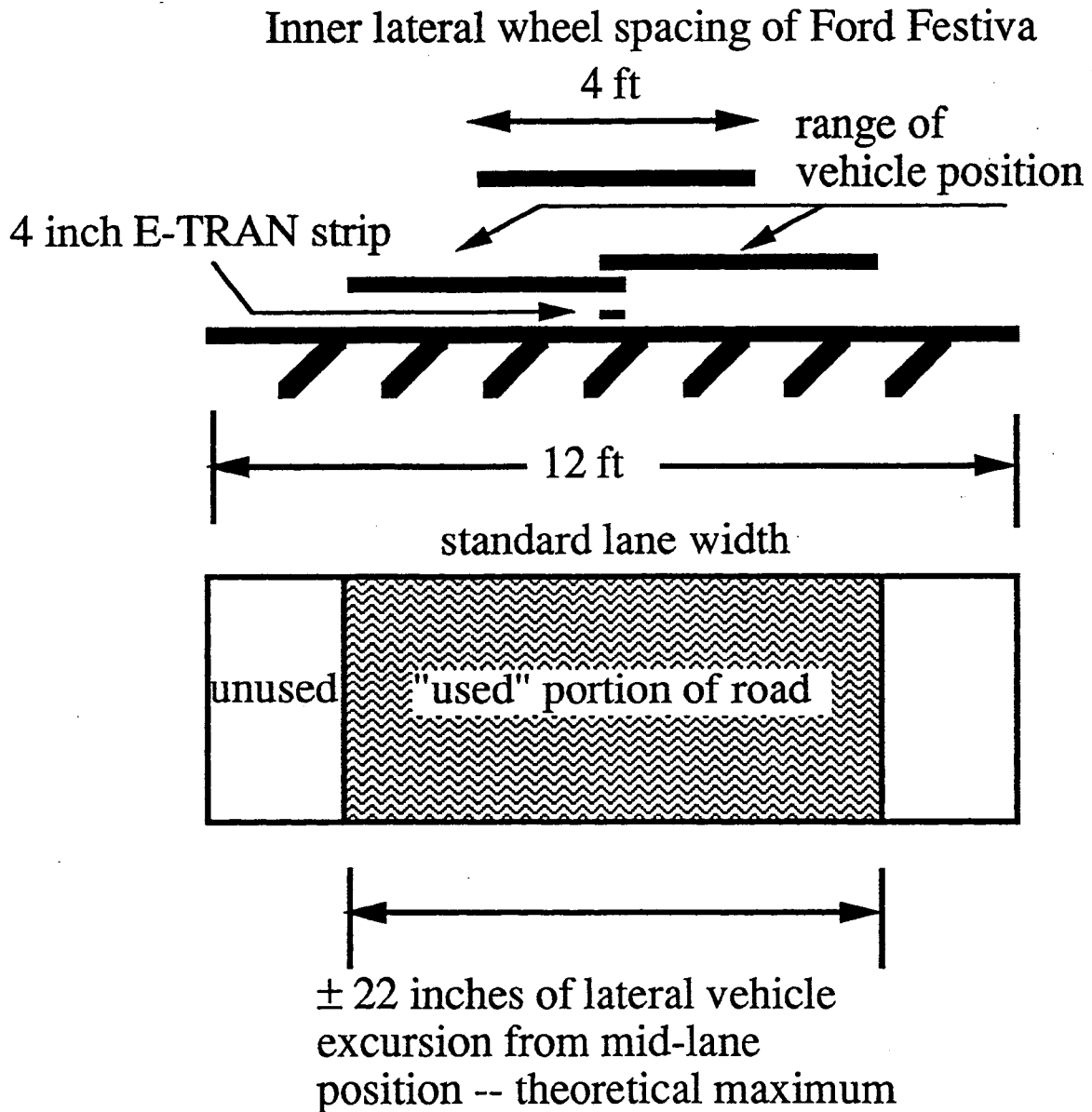

Practical maximum may be less (e.g. ± 20 inches) compared with ± 42 inches without E-TRAN.

Conclusion: $(22/42)100\% = 52\%$ reduction in lateral steering freedom.

Figure 3 Illustration of how driving accuracy is affected by a small lateral wheel base.

Reliability and Maintainability of Pantograph/Power Strip

A serious and fundamental issue deals with the reliability and maintainability of the wiper (or "pantograph") mechanisms which would establish contact between both the positive and negative power strips. While reliability and maintainability are hard to quantify for a concept (i.e., not an actual system that is in daily use or that can be tested), we conjecture that in the near-term, this concept will be extremely difficult to maintain, have severe reliability problems and will likely be prohibitively expensive. Our rationale is based on the requirement for a wiper mechanism which can accommodate (or tolerate) both *lateral*³ and longitudinal displacement variations -- unlike electrically powered trains. During operation, the wiper mechanism and brush will experience *significant* lateral impact forces -- either due to lane changing, normal variations in steering, or other road induced disturbances (such as bumps, potholes, obstacles, etc.). In order to reduce brush wear in the presence of the lateral displacement problem, there is a need for a mechanism that possesses the ability to handle some lateral motion (e.g., a pivot as on a castor -- as shown conceptually in the E-TRAN patent). At high speeds, dynamic instabilities can ensue and cause significant problems. Reliability, wear, fatigue, bearing-lock, material failure, excessive heat, friction, noise, and vibration will all have to be addressed. Arcing has been and could continue to be a performance and safety problem. Another related issue concerns the static electricity buildup on the brush and other components of "fuzz," dirt, and small metallic particles and objects. This has been observed on the current prototype system and reduces the effectiveness of current collection. Also, from a cosmetic point of view it is unappealing. Galvanic corrosion could also be a serious problem.⁴

Similar comments about reliability and maintainability apply to the strips mounted to the roadway. It is difficult to get paint to adhere to the road, let alone strips which are not flush with the roadway. Vehicle loading (e.g. lane changing 18 wheelers) and pavement motion (e.g. flexing) will only make the problem worse. Furthermore, loose or damaged strips will present a significant safety hazard to drivers. Even with a flush strip concept, the wiper problems do not go away.

In northern climates, the strip/wiper concept would be subject, during normal operation, to a significant amount of abuse including rain, snow, ice, sleet, corrosive salts, abrasive sand, thermal expansion and contraction, and snow plows. At a minimum, this would significantly escalate road and vehicle repair and maintenance costs. During heavier snowfall or freezing rain, even heated strips may not prevent ice buildup and the resulting power loss. Given present day technology, the concept is simply not applicable to northern climates. Also, the strip could become quite slippery during normal operation, affecting traction when lane changing.⁵

It should also be noted that researchers at Lawrence Livermore Laboratory and others (Berman [2], Bolger, [3], Lechner and Schadover [6], and Walter [14]) who developed a prototype system conceptually similar to E-TRAN (i.e., "steer one's car while plugged into the local power company") avoided this electrical contact problem totally. They used inductive coupling which eliminates the need for "2 degree of freedom (DOF)" high speed electrical contacts; power transmission occurs through a gap which minimizes friction, wear, etc. This is, in a way, a subtle lesson learned from the LLL project (which certainly has its own set of problems), but an important one.

It is interesting to compare our comments above to the experience that others have had with rolling contacts used in tracked systems (i.e., no steering involved). According to Mike Griffon of WabCo (previously described), roller type contacts for tracked systems (which are simpler than those required for E-TRAN) have basic reliability problems and in recent years, WabCo has had to revert back to the "old fashioned way of doing things" (simply use a cast iron shoe that slides but does not rotate). The above issues are familiar to mechanical engineers involved in tribology, material science, mechanical design, vibration, and dynamics of machinery and cannot be dismissed. Lateral guidance control (which is related

³ By lateral, we include *both* translational and rotational motion effects.

⁴ Observation by ICF Kaiser Engineers, Sacramento, CA.

⁵ Observation by ICF Kaiser Engineers, Sacramento, CA.

to the problem discussed above) is very common in certain high speed industrial processes, such as in "web winding" (winding of paper rolls in paper factories), coating applications, and so on. However, lateral guidance control (which could eliminate steering) for road vehicles is still in its infancy.

Suppose one concedes that the lateral steering problem case needs much more research before it becomes viable and then one proposes an E-TRAN *track* concept (i.e., no steering) so that a "2 DOF" wiper is not needed; then what? We feel that the concept is challenging, but technically valid (use wipers like that used on subways, etc.). However, one must evaluate it in comparison to other competing technologies. Since E-TRAN with a "track" is essentially a high speed rail concept, what advantages does it offer over existing propulsion methods for high speed light rail? We believe very little, since although the number of wires (or rails) might be reduced by one (with E-TRAN, there is now one wire instead of two), the track (or road) must now be instrumented with vehicle presence sensors & associated wiring which adds additional cost to the system and raises additional reliability and maintainability issues that need to be addressed. A form of power switching control (again with associated wiring) will be needed. Furthermore, an E-TRAN wire (or rail) may be more expensive than two ordinary rails used on existing systems because of the required segmentation and installation of insulating elements (i.e., it is not an *off-the-shelf* cable).

Conclusion

In conclusion, for the case of high mass, high speed ground-based transportation applications, we believe that the E-TRAN concept is not yet appropriate. Specifically, it may not be a replacement for existing power propulsion systems for cars, trucks, or buses. For the case of light rail systems, it may not offer a technical or cost advantage. Similar comments apply to the invention described in the Chevron "sister" patent (by Jay D. Rynbrandt in 1984, see [12]) -- it relies on the existence of reliable electrical contacts at high speeds in the presence of both lateral and longitudinal displacements along with vehicle loading, etc. It is believed that the Chevron concept is less credible than E-TRAN's because of the large lateral spacing between the + and - strips. This would tend to further reduce the lateral steering freedom.

The above remarks do not mean that the high mass, high speed E-TRAN problem is impossible to solve. It is an open question that can only be answered rigorously by designing, building, and testing such a system and we cannot quickly offer a formal "proof" that it will or will not work. This is often the case in engineering. However, based on our engineering experience, a project of this type *potentially* has all of the elements (e.g., high market expectations, serious mechanical reliability issues to deal with, demanding performance requirements, safety issues, and government regulations) of never "making it" and could seriously tax one's commitment, interest, and financial resources before it is solved to the customer's satisfaction or it fails. It should *only* be pursued after significant field tests of a lower speed, smaller scale system have proven successful. (One measure of this would relate to hours of service in the field or hours between repairs, MTBF, etc.) After the successful completion of field testing and a more thorough study of the scaled up problem, we would then encourage the pursuit of the "high mass, high speed" problem, since the size of this market could result in significant benefits.

As an aside, the notion of devising an ordinary vehicle concept (for use on freeways) that is propelled in real time by the local power company is a very good idea, but there are a significant number of practical system level problems to overcome. Are utilities prepared to provide the needed power for this additional load? Do they presently have the capacity to handle predicted day time loads for E-TRAN? Keep in mind that to cover excess daytime peak loads (which coincides with E-TRAN's peak usage), the power plants that utility companies bring on line are those that are least used, i.e. the ones that are most polluting to the environment and the most inefficient. How practical and cost effective is the power distribution equipment (including cabling, switches, etc.)? Are utilities prepared to invest in new additional low-pollution, energy efficient plants? It is interesting to note that Bender [1] who has studied the problem of propulsion systems for automated highway systems (or "AHS") concludes that road electrification (i.e. a third rail type system with some sort of lateral guidance which has hardware similar to an E-TRAN system) is not as economical as IC engines -- this of course assumes that the basic technology is viable. The increase in costs is attributed to system costs (i.e. more infra-structure and vehicle add-ons).

Even if the E-TRAN concept were viable for the high mass, high speed case, what advantage would it have over a high speed light rail system that transports large numbers of individual battery powered vehicles with people in them (i.e., the “ferry concept” as in [10,13] -- see Appendix C)? Or, how would it compare to a design in which an ordinary vehicle is capable of functioning both on ordinary roads *and* on a high speed light rail system? These ideas, and others, would need to be further compared with E-TRAN.

2.3 Case 2 -- Low Mass, High Speed

Transportation systems that tend to fit in this category are:

- Motorcycles (and other two or three narrow wheeled vehicles),
- Various industrial conveyance systems, and
- “Ultra” subcompacts (similar to the tiny cars found in Europe).

For the case of two narrow-wheeled vehicles, the E-TRAN concept would not apply because “outrigger” wipers would inevitably interfere with steering of the vehicle at high speeds causing a significant safety hazard. In the case of industrial conveyance processes (e.g. in a bottling factory), one is usually very interested in reducing the number of degrees of freedom within the system in order to make it simpler (i.e., one does not want a steering (or orientation) degree of freedom). Therefore, the E-TRAN concept as *originally posed* is not applicable. Therefore, one is essentially talking about an E-TRAN track again with little if any advantage⁶ over the many existing technologies for solving these types of problems. Finally, in the case of an “ultra” subcompact (as well as in general for the low mass, high speed case), one has the “wiper” problem to deal with (as discussed above). So, in conclusion, for the case of low mass, high speed applications, we believe that E-TRAN has little or nothing to offer.

2.4 Case 3 -- High Mass, Low Speed

Transportation systems in this category include:

- Electric buses and trolleys, buses, shuttles, or vans used at tourist sites, airports, malls, or small dedicated low speed urban roadways, and
- Subways.

We believe that the E-TRAN concept is valid for these types of applications; however, it seems to offer only a few significant advantages over existing technologies. For example, there are electric buses in use today (typically in metro Europe or in metro U.S.) that can already do the following:

- Drive and steer on an existing roadway with some modifications to the roadway (must install cables overhead).
- Switch to a battery powered mode⁷ when there is a traffic accident or other obstruction, and drive around the traffic so that the vehicle does not get “stuck.” This feature also allows all of the buses to be parked compactly in an ordinary bus garage when not in use and there is no need for a special “turn-around” station.

⁶ Recall that the tradeoff (optimistically) is 2 wires versus 1 and in the E-TRAN concept, one needs to instrument and control power to the track.

⁷ Some use regenerative braking as a third mode.

- Get on and off the cable system automatically from the driver's seat. In the past, (e.g., only fifteen years ago in Cambridge, MA), a driver had to get out of the bus and yank on a cord appropriately so that proper contact was re-established. The system for doing this is of course, battery powered.
- Function reliably under all reasonable weather and road conditions (including rain, snow, ice, corrosive salts, and abrasive sand on the surface of the road). This is a key issue.

Given that existing buses can do all of this already, it is difficult to make a case for E-TRAN⁸.

Three problems must be addressed:

- One has to instrument and control the power delivered to the road (reliably and cost effectively) which was not required before (i.e., with an electric bus).
- There is the safety issue given that the E-TRAN wire is on the roadway or to the side of the vehicle.
- There is the issue of how to deal with non-ideal weather conditions (again, assuming that the E-TRAN wire is on the roadway or to the side of the vehicle).

All of the above problems must be addressed for the benefit of "one less wire", a more aesthetic roadway (i.e., no overhead cables), or the possibility of introducing a heterogeneous E-TRAN vehicle population (note that is unlikely that effective pantographs could be fabricated for use on vehicles other than buses because of the vertical height issue -- an E-TRAN system however does not possess this restriction and other types of vehicles could be powered on the same infra-structure). It is important to recognize that the E-TRAN cable system may cost more because the E-TRAN wire is a very special one (unlike cable wire for electric buses) that must be segmented appropriately with insulating elements installed in between the conducting elements. I. C. F. Kaiser Engineering (a trolley system company of San Francisco, CA) has independently estimated the cost per mile of an E-TRAN bus system to be roughly equivalent to that of an overhead trolley system (i.e., ~ \$2 M/mile).

The same argument applies to the case of subways as well. If a bus is to function indoors the concept seems reasonable but there are probably not that many applications that require non-tracked systems. A non-tracked system refers to a system where there is interest in having a person steer the vehicle; otherwise, why not use a tracked system (for safety), such as a subway, instead?

The one notable case where E-TRAN has an advantage over other systems is when the weather is not an issue, the roadway is smooth, aesthetics are very important and it is acceptable to mount a strip (and associated underground wiring) to the roadway. While much of the United States has weather with temperatures below the freezing level for a significant proportion of the time, the southern tier of states and many foreign countries have ideal weather conditions for an E-TRAN system. A tradeoff would exist: aesthetics would be an advantage for E-TRAN over current electric buses (because no overhead cables are required) and safety would be an advantage for the electric bus over E-TRAN (because the power source is remotely located, away from people).

2.5 Case 4 -- Low Mass, Low Speed

Transportation systems fitting into this category include the following:

- Amusement rides (e.g., "go-carts"),
- Factory bound "route" vehicles carrying several people and some material (e.g., people in large factories often use "Cushman" type golf carts for transportation purposes), and

⁸ Certainly the case for outdoor use in northern climates.

- Toy cars,
- Miscellaneous battery powered vehicles such as those used to transport people in airports, etc.

Initially, we believe that this category is the best marketplace for E-TRAN. One gets around the dynamic problems because of the lower speeds. Due to the low mass, lower voltages are possible which alleviates the main safety problem. These applications are typically indoors (or in an "indoor-like" environment) which therefore eliminates many of the practical sliding contact and safety problems. In cases with tight space requirements, there may not be sufficient room for installing trolley cables overhead, an advantage for E-TRAN. In many of these applications, there is an interest (or desire) to let someone steer the vehicle. For example, in the go-cart application, the old fashioned way of solving the problem is to use a battery powered small vehicle which drives on a roadway with a 4" x 1/4" vertical metal plate embedded in the center of the lane which passively constrains the vehicle's resultant motion. E-TRAN offers a clear economical advantage (i.e. operating costs) over the battery powered approach since it is more energy efficient to be plugged directly into the local power company (i.e., there is no need to charge batteries which is inherently an inefficient process). Also, the child still gets to steer somewhat. Many of the above comments also apply to the other applications (i.e., small route vehicles, go-carts, and toy cars).

3. Comparison with Other Approaches

Since the advent of the automobile there have been a large number of electric vehicle propulsion concepts proposed (and implemented in some cases). Our purpose here is not to review every electric vehicle concept; rather we will focus on concepts that are somewhat related to the E-TRAN concept, such as road electrification ideas. Some of the concepts may not be viable for one reason or another. The concepts reviewed include:

- PATH and System Control Inc.'s inductively coupled road electrification concept
- J. Bender's road electrification concept (described in 1991 AHS paper)
- N. Berman patent (1978)
- J. Rynbrant patent (1984)
- Tempo America personal transportation system
- "Eagle" transportation system
- Miscellaneous concepts

Key information describing each of the concepts is provided in Appendix C. We will summarize each concept and describe its relevance to E-TRAN.

PATH and System Control Inc.'s Inductively Coupled Road Electrification Concept (e.g. see [2,3,6,14])

This propulsion concept involves embedding a primary coil beneath the road and a secondary coil beneath the vehicle and in close proximity to the road surface. During normal operation, power is transferred to the vehicle without any physical contact being established between the road and the vehicle -- unlike E-TRAN. Experimental work has proven successful with the not-insignificant infra-structure costs being one of the main impediments to implementation.

J. Bender's Road Electrification Concept

In Bender's AHS paper (see [1]), road electrification is discussed from a system point of view. A third rail type system is proposed in conjunction with lateral guidance. Electrical safety and system costs

are serious issues that would have to be resolved. Because of the economic issue, IC engines are recommended.

Nelson Berman Patent (1984) [2]

Nelson Berman's "ELECTROTUG" concept is essentially a third rail concept. The vehicle is powered by towed trailer that maintains contact with the recessed third rail via a lateral positioning device and associated contact (or brush). Some key issues pertain to electrical safety, the practicality of tugging a trailer, reliability & maintainability of the current collection, and infra-structure costs.

J. Rynbrant Patent (1984) [12]

This idea is also a third rail type of concept. Unlike E-TRAN however, there are two continuously powered rails instead of one discontinuously powered rail. Steering by the driver is allowed by design. Like E-TRAN though, there is the electrical safety issue and the pantograph reliability and maintainability issue to reckon with.

Tempo America Personal Transportation System [13]

The Tempo Personal Transportation System is an automated pallet concept whereby vehicles are transported on a moving pallet that the vehicle is strapped to. Some key issues pertain to infra-structure & operating costs and logistical issues such as passing, etc.

"Eagle" Transportation System [10]

The "Eagle" Transportation System is also an automated pallet concept. Unlike the Tempo system though, magnetic levitation is used to propel the pallets. Similar kinds of issues apply here as well.

Miscellaneous Concepts

In the course of searching for transportation concepts related to E-TRAN, to our surprise, a large number of frivolous and unrealistic, and at times even comical concepts were encountered. Perhaps this is because of the ubiquitous nature of transportation, i.e. anybody and everybody can relate to it, regardless of their technical background. Also, as Henry Ford has demonstrated, a successful transportation invention can pay off handsomely. While the existence of these types of concepts is interesting in of itself, in the interests of space, we will not present them here.

4. Summary of Suggested E-TRAN Market Niche

Based on the above analysis and comparison with other approaches, we feel that the E-TRAN propulsion concept has the following requirements (at least at this time and for the near future):

- **Low vehicle speed** (i.e., $< \sim 30$ mph).
- **Dedicated E-TRAN lane** -- primarily needed for safety reasons (i.e., pedestrians are not allowed on the lane). Exactly how it will be isolated from the general public will depend on the sophistication of the customer and end user.
- **Indoor (or "indoor-like") environment** (smooth, obstacle free) -- such as that found in the southern tier of states.
- Low gross vehicle mass is preferred so that low power levels can be used, therefore ensuring safe operation. If safety problems can be overcome, then much larger vehicle masses are possible.
- Applications where tight space requirements or aesthetics may preclude trolley cables.
- Constrained path motion (i.e., when steering of a vehicle about a nominal pathway is desired). In other words, when a track is undesirable. The dimension of the vehicle's wheel base will also

factor into the degree of constraint that is required. Long “straight-aways” and gentle turns are clearly preferred.

- During normal usage the vehicles need to be in close proximity to the E-TRAN grid. This reduces the dependence on other vehicle propulsion modes (e.g. batteries) which increases E-TRAN's effectiveness.
- It is acceptable to mount a strip to the roadway and install associated wiring underground or on the roadway.
- Applications where the option exists to power a variety of different types of vehicles on the same system.
- High energy efficiency (and low operating costs (excluding system costs)).
- Small down time (e.g., do not want to spend many hours charging batteries).
- Pollution shifted to a central location (power plants).

Possible applications include:

- Amusement rides (such as “go-carts”),
- Factory bound vehicles carrying several people and materials,
- Buses, shuttles, or vans used in highly structured transportation settings such as tourist sites, airports, malls, or dedicated low speed urban roadways in a southern climate.

Because of all of the practical E-TRAN requirements (e.g., the speed limit, the ideal weather condition or indoor locations, and the dedicated lane), reliability issues (e.g., the roadway sensors, strips, and wipers), and the solutions offered by existing technology, it is our belief that the size of the E-TRAN market may be relatively small⁹ when compared to the general market for ground based transportation systems or the automotive market.

5. Specific Recommendations/Other Observations¹⁰

Our recommendations to E-TRAN, Inc. are as follows:

- Focus on the “low mass, low speed” warm climate or indoor market (not the high speed, high mass market) first, if E-TRAN, Inc. is seriously interested in turning a profit in the near term. If desired, any revenue achieved from the low mass, low speed market can then be put toward research and development on the high mass, high speed problem.
- Clean up the design of the existing system; specifically address the following problems (note: items (1) -- (3) apply primarily to the go-cart system):
 - (1) Proper mechanical design of both the strips and the pantographs (E-TRAN, Inc. will need a mechanical designer for this task). The current “outrigger” wiper is functionally,

⁹ However, there is definitely a market for E-TRAN technology even at low speeds. For example, consider airport “people-movers.” Similarly, one might expect an E-TRAN market to emerge among the potential applications listed above.

¹⁰ Since this system engineering study was first drafted, some of these recommendations are being addressed. Other recommendations are as valid today as they were in August 1992.

aesthetically, and from a safety perspective, unacceptable. The current wiper/strip geometry and choice of material is far from optimal, even at low speeds.

- (2) Implement the proposed switching strategy; maintaining live 220 volts DC on the floor is a major safety hazard and is unacceptable. This of course will require the use of vehicle presence sensors and appropriate power switching hardware. (*Note: a limited demonstration was performed at the 1992 Energy Show in St. Paul, MN.*)
- (3) Construct a true “dual-mode” system (the other mode being battery power) that will allow the vehicle to get on and off the track, start from a dead stop, or span a dead zone on the track. (*Note: a limited demonstration was performed at the 1992 Energy Show in St. Paul, MN.*)
- (4) The vehicle used for the project should be the *same* as that used in the planned product (or closely compatible) -- not a go-cart unless that is the product that E-TRAN, Inc. wants to develop.
- (5) Resolve the basic electrical design issues such as: (a) AC or DC, (b) voltage level, and (c) speed controller specifications that are needed, etc.
- (6) The motor and transmission (if needed) should be properly sized. This comment ties in to the need for a focused product design.
- (7) A thorough and critical subsystem and system level test needs to be implemented including testing the system’s response to typical component failure modes (e.g., loss of grid elements, etc.). Successful completion of critical tests will demonstrate that the design is robust and safe.
- (8) Perform a detailed cost analysis of the entire system.

These tasks should keep E-TRAN, Inc. busy for at least a year depending on available manpower and will bring E-TRAN, Inc. closer to having an actual product that can be sold.

- As part of an overall business plan, E-TRAN, Inc. needs a sound and realistic marketing plan based on detailed analysis of the current market (a first cut at the problem is described in this system engineering study). From this, they can accurately and realistically identify their market niche and work on *product development* of specific items (e.g., shuttle van, a factory vehicle, a go-cart, etc.) and identify product families and a logical product evolution. A detailed cost analysis should be part of this effort along with specifying ideal customer profiles. Without such a plan in place, the direction and success of the company is at best questionable.
- The direction of the company should not be driven totally by the type of equipment that is donated (i.e., it is important to use what is really needed even if it is not free). This comment also ties into the above regarding the need for a marketing plan. With a business plan, E-TRAN, Inc. will have a set course and will not be tempted by distractions.
- E-TRAN, Inc. needs experienced mechanical engineering representation on their technical team. E-TRAN, Inc. can only work the problem so far with electronics technicians. Electrical engineers should also be on board.
- E-TRAN, Inc. may find it worthwhile to work together with a small battery powered vehicle manufacturer (e.g., the Cushman Corp. based in Lincoln, NE). *Note: recently, Cushman Corp. has donated a motor and controller to E-TRAN, Inc.*

- E-TRAN, Inc. should forget about trying to set an electrical vehicle speed record in the near future -- it is risky, costly, and from a business point of view it is not consistent with the objective of pursuing the low speed, low mass vehicle market. Certainly, all of the other important issues raised (such as reliability) might be ignored just to pursue the speed record. However, on a *real* production system, these issues are not going to go away.
- E-TRAN, Inc. needs to perform a more in-depth analysis of other competing concepts and existing systems -- not just at the conceptual level of understanding.

Other observations include the following:

- The E-TRAN effort seems to have gone on for a significant period of time without any objective detailed technical studies performed, etc.
- The only way E-TRAN technology can have an impact on the high speed transportation market is to log thousands of hours reliably at highway speeds on an E-TRAN test track using a life-size real vehicle. This effort will certainly not be without risk or cost because a track that allows one to travel at highway speeds must be quite long. Please note that CALTRAN has already invested \$6 million into an inductively powered system (presently located at the Richmond Field Station of the University of California). They have not yet sold the public sector or industry on the economics of their system.
- In the E-TRAN literature (Appendix A ([8,7]) a special point is made regarding energy efficiency and its associated economics; especially when comparing E-TRAN to battery powered vehicles -- a factor of four to five is stated. The analysis is unfair because there are many other important issues involved. If one wants to focus only on cost effectiveness and energy consumption, walking and biking are even better than the E-TRAN concept. In the cost analysis comparison between battery powered vehicles and E-TRAN, the capital equipment costs (e.g., E-TRAN installation costs, vehicle modification costs for both E-TRAN and the battery powered case), E-TRAN maintenance costs, etc. have been selectively ignored. We believe that a more accurate cost calculation would reveal that E-TRAN is *less than* four times as cost effective as battery powered vehicles.
- E-TRAN, Inc. needs to improve its approach to basic electrical safety. For example, to dramatize that there was no electrical potential between an energized strip and the ground (because of the isolation transformer), Nick Musachio placed his wet hand on one of the energized strips measured to be in excess of 110 VAC and then proceeded to repeat the demonstration with the other strip. He also told us about an electrical safety related incident prior to the installation of an isolation transformer. Clearly, electrical safety issues must become a priority for E-TRAN Inc.'s future efforts.
- Engineering scale effects have been ignored, i.e. just because a child's toy works, it doesn't mean that a scaled up model (to real life) will also work reliably (e.g. see a classic structural analogy in Appendix N (Petroski [11])).
- In spite of our critical remarks in certain technical areas, we believe that the E-TRAN technology has a future for various pockets of the transportation sector (certainly for the applications listed and possibly more) and encourage them to proceed wisely to exploit the opportunities available to them, starting out with the more tractable applications.

6. Bibliography

- [1] Bender, J. G., "An Overview of Systems Studies of Automated High Systems," *IEEE Transactions on Vehicular Technology*, Vol. 40, No. 1, February 1991.
- [2] Berman, N., "Roadway Vehicle," *U.S. Patent No. 4,129,203*, issued December 12, 1978, filed June 13, 1977.
- [3] Bolger, J. G., and Kirsten, F. A., *Investigation of the Feasibility of a Dual Mode Electric Transportation System*, Lawrence Berkeley Laboratory, Berkeley, CA, Report LBL-6301, 1977.
- [4] Donath, M. and Hennessey, M., "E-TRAN Vehicular Technology Assessment," 4th Annual Transportation Research Conference, Minneapolis, MN, May 19-20, 1993.
- [5] Hennessey, M. and Donath, M., "The E-TRAN Vehicle Propulsion Concept: First Impressions," *Internal Memo -- The Productivity Center and the Center for Transportation Studies at the University of Minnesota*, September 15, 1992.
- [6] Lechner, E. H. and Shladover, S. E., "The Roadway Powered Electric Vehicle -- An All-Electric Hybrid System," VIII International Electric Vehicle Symposium, Washington, D.C., October 1986.
- [7] Musachio, N. R., "Electric Vehicle Transportation System," *U.S. Patent No. 5,045,646*, issued September 3, 1991, filed July 20, 1989.
- [8] Musachio, N. R., *E-TRAN -- The Electric Vehicle Roadway*, E-TRAN, Inc. company literature, St. Paul, MN.
- [9] National Fire Protection Association (NFPA) 70, *National Electrical Code®1987*, Article 110-17: Guarding of Live Parts (600 Volts, Nominal, or Less): (a) Live Parts Guarded Against Accidental Contact, 1986 NFPA, Batterymarch Park, Quincy, MA 02269.
- [10] Paxton, L., "The Eagle Transportation System," Technical Report and U.S. Patent 3,750,803 description, 5050 North Avenue, Carmichael, CA.
- [11] Petroski, H., "Vitruvius's Auger and Galileo's Bones: Paradigms of Limits to Size in Design," *ASME Journal of Mechanical Design*, Vol. 114, March 1992, pp. 23-28.
- [12] Rynbrandt, J. D., "Electric Car and Roadway System," *U.S. Patent No. 4,476,947*, issued October 16, 1984, filed June 26, 1981.
- [13] TEMPO America, "The TEMPO Personal Transportation System," Technical Brochure, TEMPO America, 295 N. Mobil Avenue, Camarillo, CA 93010, July 1992.
- [14] Walter, C. E. and Salisbury, J. D. "Roadway Powered Electric Vehicle Performance," SAE International Congress and Exposition, Detroit, MI, February 28 - March 4, 1983.

Section II

Evaluation of the E-TRAN Vehicle Propulsion Concept -- Auxiliary Power Needs for the E-TRAN Electric Roadway & Vehicle Propulsion Concept

Abstract

E-TRAN auxiliary power needs arise because of power input discontinuities that cut the power input, either due to: (1) power strip segment failures, (2) lane changing, and (3) E-TRAN grid discontinuities including getting the vehicle to and from the grid. These effects are simulated using a 1-dimensional dynamic model of a typical vehicle (i.e. a Ford Aerostar van) combined with the corresponding inverse dynamic model and a power disabling feature generated by the particular type of "vanishing" power input discontinuity. Quantitative simulation results indicate that the power strip segment failures are the least severe, lane changing is a more severe effect, and finally, the E-TRAN grid discontinuities are the most severe. These results can be used to size the auxiliary power mode (e.g. batteries).

Nomenclature:

Variables and Functions

x	-- vehicle's position on roadway (m or km)
$v = \frac{dx}{dt}$	-- vehicle's speed or "velocity" (m/sec or km/hr)
$a = \frac{d^2x}{dt^2}$	-- vehicle's acceleration (m/sec ² or km/hr ²)
F	-- vehicle propulsion force, tangent to road (N)
t	-- time (sec or hr)
P	-- power (kw)
E	-- energy (kwhr)
s	-- power state (1.0 or 0.0)
$\theta(x)$	-- local angular inclination of road surface, + for uphill, etc. (rad), typically $ \theta \leq 0.15$

Parameters and Constants

C_0	-- tire rolling resistance coefficient, 0th order term
C_1	-- tire rolling resistance coefficient, 1st order term (sec/m)
C_2	-- tire rolling resistance coefficient, 2nd order term ((sec/m) ²)
C_3	-- tire rolling resistance coefficient, 3rd order term ((sec/m) ³)
M	-- effective vehicle mass (kg)
W	-- effective vehicle weight (N)
A	-- frontal area of vehicle (m ²)
C_d	-- vehicle's drag coefficient
l_s	-- length of power strip segment (m)
$1/N$	-- strip failure rate (i.e. every Nth strip fails under front wiper), note: $N = \infty$ is equivalent to no strip failures (N is an integer > 1)
g	-- acceleration of gravity (9.8 m/sec ²)
ρ_a	-- mass density of air (1.29 kg/m ³)

Subscripts

a	-- air
d	-- desired or drag
acc	-- acceleration
$grad$	-- grade
$aero$	-- aerodynamic
$roll$	-- rolling
s	-- strip
T	-- Total

1. Introduction

Based on the system engineering study of section I, numerous specific research problems have been identified, such as: the effect of power input discontinuities, a viable roadway "pantograph," power distribution issues, power strip design, economics, etc. to name a few. The focus of this section is on studying the effect of vanishing power input discontinuities (i.e. no power applied) which can occur due to:

- Power strip failures
- Ordinary lane changing
- Bridging E-TRAN "grid" discontinuities including getting to and from the grid

Naturally, the existence of these vanishing discontinuities increases the dependence of the E-TRAN propulsion concept on some other auxiliary vehicle propulsion modes (e.g. batteries). More specifically, for a typical vehicle we will quantify:

- The effect of these vanishing discontinuities on the desired velocity profile of the vehicle
- The peak power deficit
- The net energy demand required of the auxiliary power mode

These effects significantly impact the selection of the auxiliary power mode. This study will rely on a simple vehicle dynamic model developed below. This work was presented at the 1992 MATRIXTM User's Group Meeting [2].

2. Dynamic Vehicle Power Model

In this section a simple 1-dimensional vehicle dynamic model will be reviewed and incorporated into a larger model that allows for vanishing power input discontinuities.

2.1 Standard Vehicle Dynamic Model

A simple 1-dimensional vehicle dynamic model that incorporates inertia, external loading, road grade, aerodynamic drag, and rolling friction is as follows (from [1]¹¹):

$$M \frac{dv}{dt} = F - W \sin \theta - \frac{1}{2} \rho_a C_d A v^2 - (C_0 + C_1 v + C_2 v^2 + C_3 v^3) W \cos \theta \quad (1)$$

In this dynamic model the external loading force, F may be viewed as the input to the model and x and v may be viewed as the outputs of the model. Since we are interested in modeling the power input to the system, we can simply multiply Equation (1) by the vehicle's velocity (v) to convert it to a power based vehicle model:

$$P = P_{acc} + P_{grad} + P_{aero} + P_{roll} \quad (2)$$

where $P = F v$ is the instantaneous power input to propel the vehicle and the individual contributions to the power draw are:

$$\begin{aligned} P_{acc} &= M \frac{dv}{dt} v && \text{-- inertial effect} \\ P_{grad} &= W v \sin \theta && \text{-- effect of road grade} \\ P_{aero} &= \frac{1}{2} \rho_a C_d A v^3 && \text{-- aerodynamic drag} \end{aligned} \quad (3)$$

¹¹ with slight modification.

$$P_{\text{roll}} = (C_0 + C_1 v + C_2 v^2 + C_3 v^3) W v \cos \theta \quad \text{-- rolling friction}$$

Note that if $v \neq 0$ we can use the power based model described by Equation (2) (instead of the force input model described by Equation (1)). Also, the model may be inverted to calculate the power needed (P) for a particular driving cycle (e.g. as characterized by the commanded velocity profile $v(t)$). In Appendix E the corresponding MATRIXx™ (see [3]) superblocks (*power_request* for inverse dynamics and *vehicle* for dynamics) are given. Finally, both initial position and velocity of the vehicle (i.e. $x(0)$ and $v(0)$) can be specified by setting appropriate integrators.

2.2 Incorporating Vanishing Power Input Discontinuities

The effect of vanishing power input discontinuities can be modelled by cascading the inverse dynamics model with the dynamics model and some additional blocks that are capable of zeroing out the vehicle input power depending on the origin of the particular vanishing power input discontinuity being simulated. Figure 1 depicts a functional block diagram of the model used. On an actual vehicle the vanishing power input would correspond to temporarily ignoring the accelerator foot pedal input. As shown in Figure 1 this modeling effort is quite simple in the case of lane changing and general grid discontinuities (i.e. simply multiply the desired power by zero). However, in the case of strip failures, it is more involved and one needs to keep track of the actual vehicle position (hence the need for the position feedback loop shown in Figure 1) and zero out the power input to the vehicle when one of the vehicle mounted wipers (or pantographs) is in contact with the failed power strip segment.

To be more precise, in the case of failed power strip segments, we will assume that the strip consists of only alternating + and - segments of equal length l_s (also equal in length to the effective wiper spacing on the vehicle); i.e. no insulating elements are allowed. Results from this modeling effort can be applied (approximately) to actual designs which as a practical matter will need small insulating elements between adjacent power strip segments. While one would expect power strip segment failures to occur somewhat randomly, one can conveniently parameterize the severity of the power strip segment failures with one parameter (N) and assume a uniform failure rate. Here $1/N$ represents the failure rate and we are assuming that every N th strip segment is assumed to have failed when the *front* wiper is in contact with it.

In Appendix E the corresponding MATRIXx™ superblocks are given. Individual blocks in the simulation (as shown in Figure 1) include those for modelling the inverse dynamics (*power_request* superblock), vehicle dynamics (*vehicle* superblock), available power (equivalent to a "×" block), determining the energy deficit, and keeping track of whether or not the vehicle's front wiper is on a failed strip element (*strip_failure* superblock).

2.3 Additional Modeling Details

For all of the simulations performed, several additional modeling refinements and/or specifications were needed. First, the integration time step Δt was determined by the length of the power strip segment and the maximum velocity so that $\Delta t = l_s / (10 \times \max|v|)$; this ensures that at least 10 vehicle position data points were collected per power strip segment. Second, care must be taken to avoid dividing by zero in the velocity feedback loop present in the dynamic model. Several blocks that redefine both the velocity and acceleration (if the magnitude of the velocity is sufficiently small) are needed to avoid this numerical ill-conditioning problem. Finally, since we are primarily interested in energy and power deficits (i.e. not surpluses), during deceleration we can assume that optimal braking occurs (i.e. there is no contribution (+ or -) to the energy deficit during this phase) and for convenience, the actual acceleration is set equal to the commanded acceleration.

3. Specific Simulation Studies

All three types of vanishing power input discontinuities were simulated for the case of a typical vehicle, a Ford Aerostar van (see Appendix F for the dynamic parameters specified) powered by E-TRAN and propelled at modest speeds (50 km/hr -- peak velocity).

3.1 Power Strip Segment Failures

Several simulations were performed to investigate the effect of different severity levels of power strip segment failures (as parameterized by $N = 2$ or 10) and different road grades ($\theta = 0.0$ rad or $\arctan(0.1)$) for a typical driving cycle given by a velocity profile, i.e. accelerate from rest, constant velocity, decelerate to rest. In Figure 2 the actual vehicle power, actual velocity, and the energy deficit are plotted for the most severe case considered (i.e. $N = 2$, $\theta = \arctan(0.1)$). Based on this simulation we observe the following:

- The velocity profile is "jagged" (i.e. not a C^1 function); this can also be seen from Equation (1)
- The "steady-state" vehicle velocity is approximately 60% of the commanded vehicle velocity in spite of the severe grade and severe rate of power strip segment failures
- The peak power input to the vehicle occurs during the acceleration portion of the velocity profile and drops significantly during the constant velocity portion of the profile
- The duration of the power loss is a function of the vehicle's velocity, e.g. it is constant during constant vehicle velocity
- The energy deficit increases essentially linearly with time
- Note that because of the braking issue raised earlier the deceleration phase can be ignored

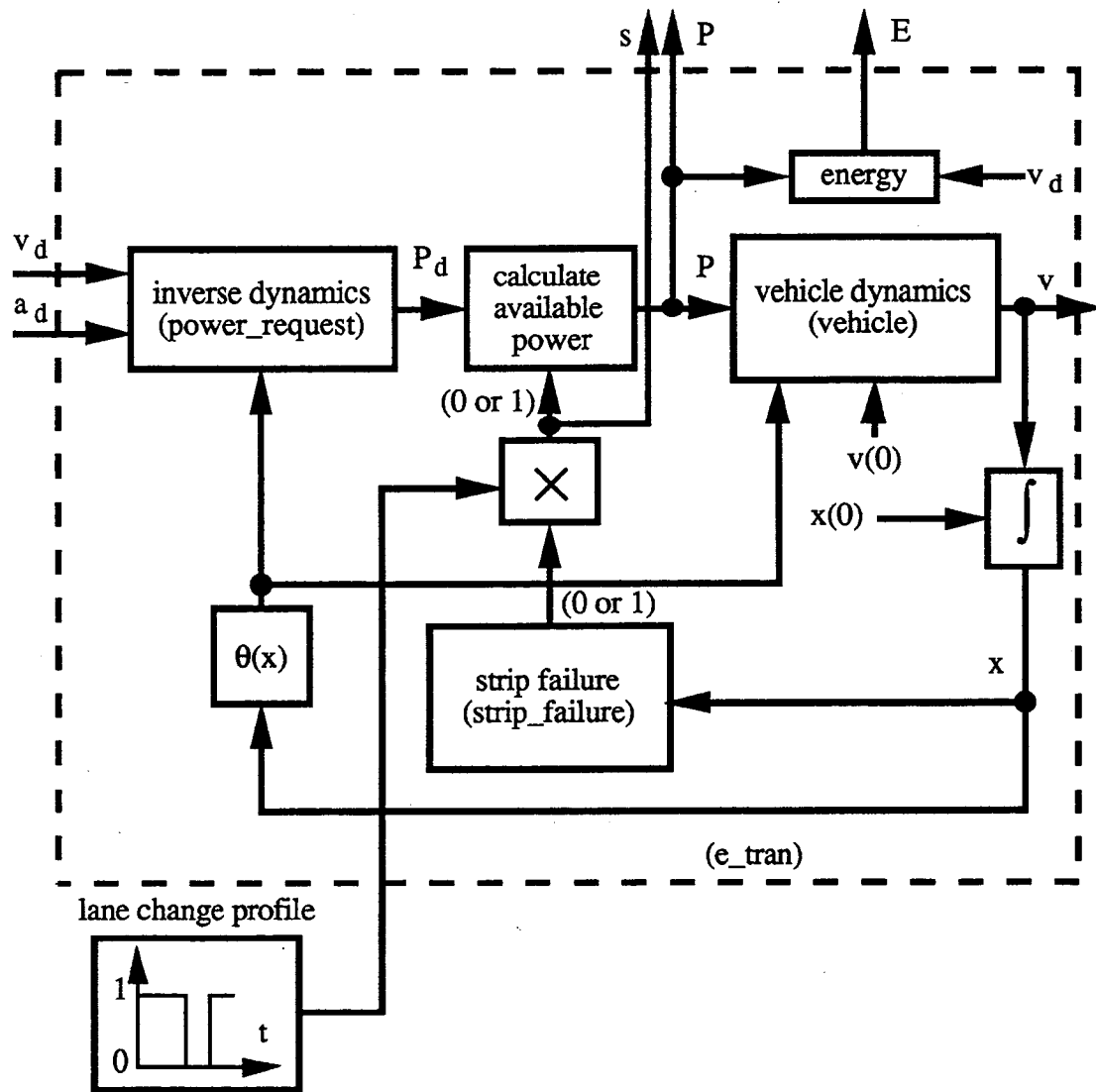
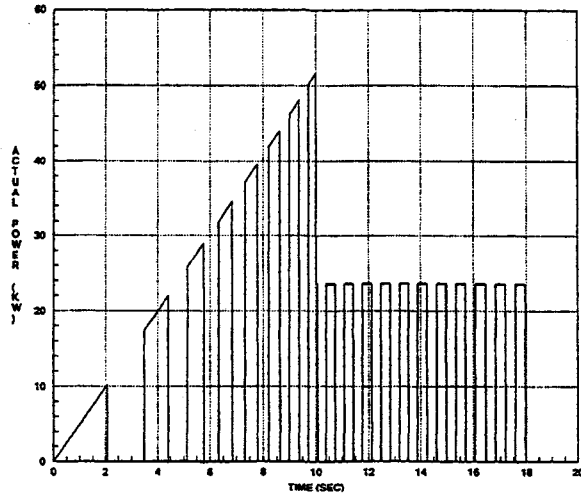
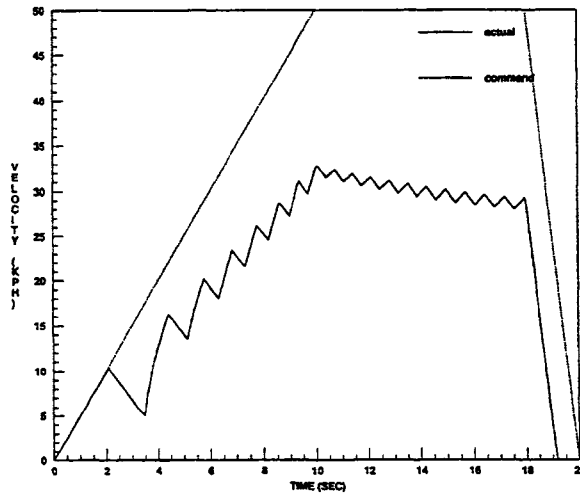

Figure 1 Functional block diagram of E-TRAN powered vehicle subject to vanishing power input discontinuities. Superblock names are indicated in parentheses.



(a) actual power



(b) vehicle velocity

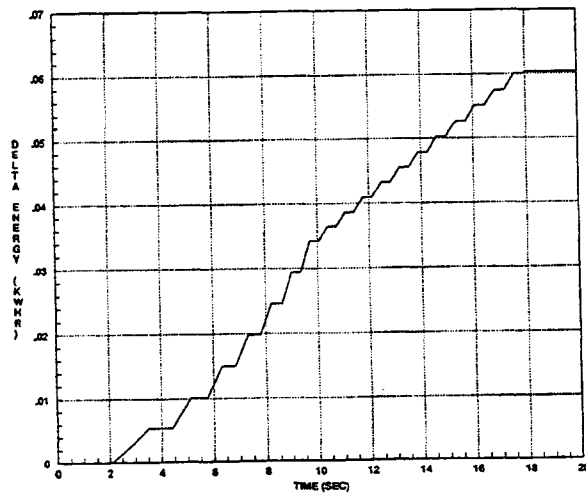

(c) energy deficit

Figure 2 Simulation results for $N = 2$, $\theta = \arctan(0.1)$ case.

In Figure 3 the actual vehicle power, actual velocity, and the energy deficit are plotted for the least severe case considered (i.e. $N = 10$, $\theta = 0.0$). Based on this simulation we observe the following:

- The "steady-state" vehicle velocity is approximately 95% of the commanded vehicle velocity
- Other comments above apply here as well (e.g. regarding the actual velocity profile description, etc.)

Based on these simulations we can conclude that power strip segment failures do not represent a significant problem and the E-TRAN concept is even robust with respect to power strip segment failures (provided that the vehicle is not initially at rest on a failed power strip segment). This stems in part from the low rolling resistance and high mass of the vehicle. Only when the power strip segment failure rate becomes severe (e.g. $N = 2$) is there much of a problem. Also, as a practical matter, even every tenth power strip segment failing would be viewed as severe; for this case there is only a 5% reduction in "steady-state" vehicle velocity. A mechanical design issue related to the above simulations concerns the need for an insulating element between successive power strip segments. Provided that they are less than 1/10 the length of the power strip segment (easily done) there is little effect should there be a loss of power during passage of the front wiper over the insulating element.

3.2 Lane Changing

Several simulations were performed to investigate the effect of lane changing. During lane changing the vehicle moves laterally from one lane to another and there will be a short period of time from when the wipers lose contact with the power strip in one lane until they reestablish contact with the power strip in the new lane. Using the same commanded velocity profile as in the above simulations, the effect of a 4.0 sec lane change was simulated for the case of no grade and for the case of a severe grade (i.e. $\theta = \arctan(0.1)$). Since typically lane changing occurs at a high steady-state speed, this was assumed in the simulations. For simulation purposes, one can simply use the power strip segment failure model with $N = \infty$ (or a sufficiently large number, i.e. $> x_T / l_s$, x_T -- total distance travelled) and zero out the power input to the vehicle during lane changing. Figure 4 illustrates the data obtained.

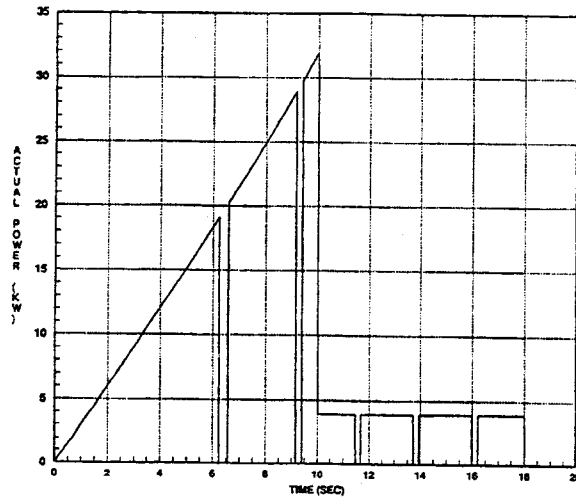

(a) actual power

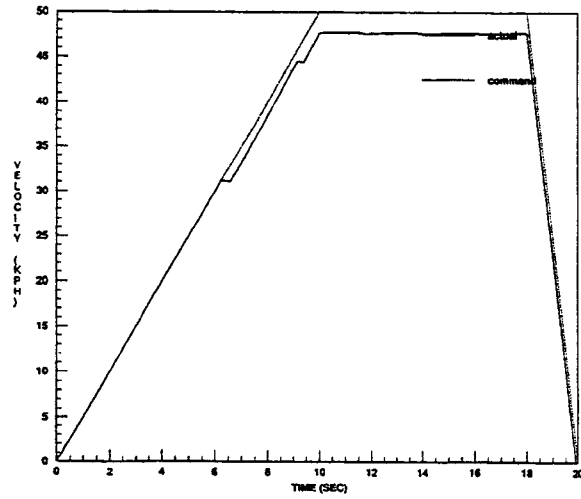

(b) vehicle velocity

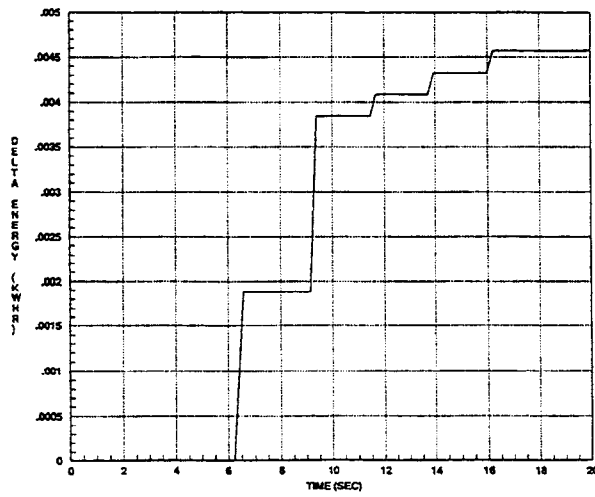

(c) energy deficit

Figure 3 Simulation results for $N = 10$, $\theta = 0.0$ case.

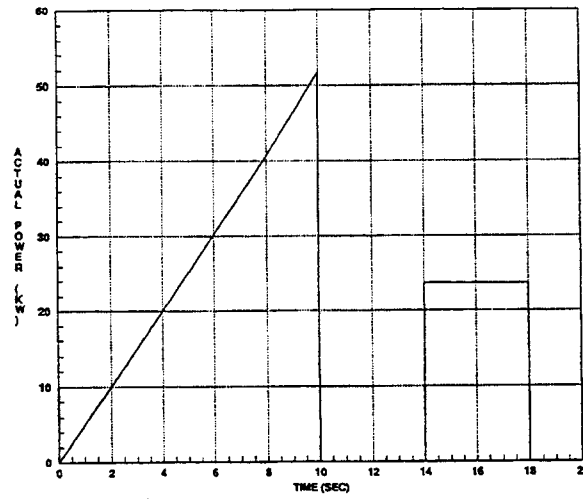

(a) actual power

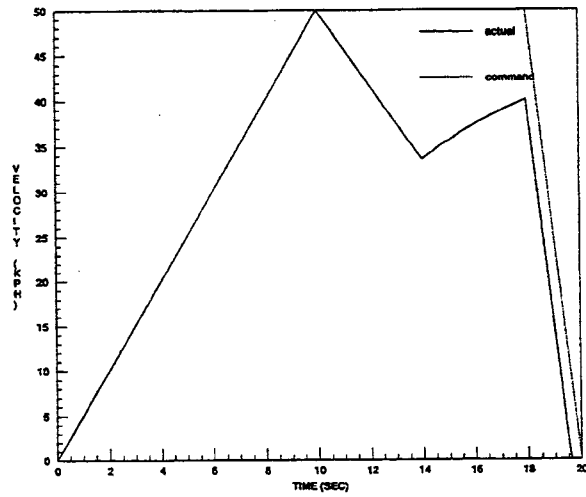

(b) vehicle velocity

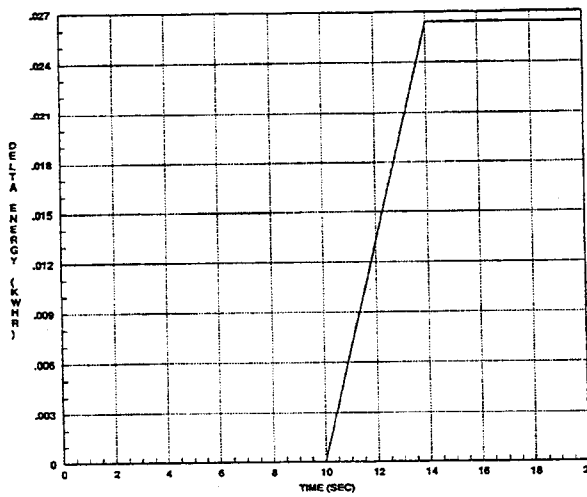

(c) energy deficit

Figure 4 Simulation results for lane changing ($\theta = \arctan(0.1)$, 4.0 sec lane change).

Based on the simulation results we can make some conclusions. The most significant conclusion is that lane changing has the potential of being a more severe effect than power strip segment failures since the duration of the lost power would typically be longer. For example, in the simulation performed, the vehicle's velocity drops abruptly from 50 km/hr to 34 km/hr in only 4.0 sec. A longer lane change or one that occurs during the beginning of the acceleration phase would have an even more significant effect. In conclusion, quick lane changing at high speeds is recommended which mitigates the effect of lane changing on the E-TRAN system.

3.3 Grid Discontinuities

A third and more severe type of vanishing power input discontinuity results from inherent E-TRAN power grid discontinuities, such as might be anticipated at intersections, and from getting the vehicle to and from the E-TRAN grid. Since the exact impact of these grid discontinuities will depend on the specifics of the E-TRAN application (such as the grid geometry and the vehicle's desired path, both on and off the grid), we will quantify the peak power demands and the energy deficit on a scaled basis (i.e. per unit distance) for a typical vehicle. For simulation purposes, one can use the power strip segment failure model with $N = \infty$ (or a sufficiently large number, i.e. $> x_T / l_g$). Figure 5 illustrates the power and energy deficits incurred during a 100.0 m excursion entirely off of the E-TRAN grid. For a 100.0 m excursion the peak power demand is 32.0 kw and the energy deficit is 0.045 kwhr. Depending on the details of the specific E-TRAN implementation, one can estimate the peak power demands and energy demands of the auxiliary power mode using data contained in Figure 5. Clearly, this type of vanishing power input discontinuity is the most severe and also raises economic issues associated with the auxiliary mode.

4. Summary and Conclusions

Auxiliary power needs were quantified for the E-TRAN electric roadway and vehicle concept. These auxiliary power needs arise because of vanishing power input discontinuities. Using a 1-dimensional dynamic model (simulated in MATRIXTM) that couples an *inverse dynamics* vehicle model with a vehicle *dynamic* model and additional blocks that model power losses, the effects of three specific types of vanishing power input discontinuities were studied for the case of a typical vehicle -- a Ford Aerostar van. These vanishing power input discontinuities are due to:

- Power strip segment failures
- Lane changing
- Bridging E-TRAN "grid" discontinuities including getting the vehicle to and from the grid

While the impact of the different power input discontinuities depends to some extent on driver habits, we believe that of the effects considered, power strip segment failures are the least severe. Simulations show that even when half of the strip elements have failed (uniformly and with no failure initially for the front wiper), it is still possible to achieve 60% of the desired "steady state" velocity. Any reasonable failure rate (e.g. 5% or less) will not present a problem, provided that the vehicle is not initially at rest on the failed power strip segment. Lane changing represents a more severe type of vanishing power input discontinuity and the degree of severity scales with the duration of the lane change. In one of the specific simulations performed, for a 4.0 sec lane change, the vehicle's speed was reduced from 50 km/hr to 34 km/hr, a significant reduction. Furthermore, this scenario was not a worst case scenario. The effect of lane changing can be mitigated by lane changing quickly at high speeds. Finally, the most severe form of power input discontinuity pertains to E-TRAN grid discontinuities including getting the vehicle to and from the grid. For the specific vehicle simulated, approximately 0.045 kwhr are required for each 100 m spent off of the grid (this of course does not include other vehicle power demands such as air conditioning). In conclusion, the E-TRAN electric vehicle concept needs an auxiliary power mode that can be readily accessed in real-time (i.e. within milliseconds) and the exact power demands must be quantified for the specific E-TRAN application. These power demands can be significant, especially if the vehicle is to spend a significant amount of time off of the E-TRAN power grid.

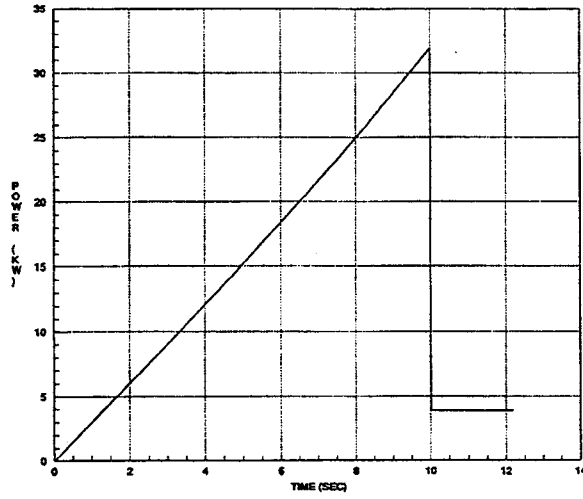

(a) power needed

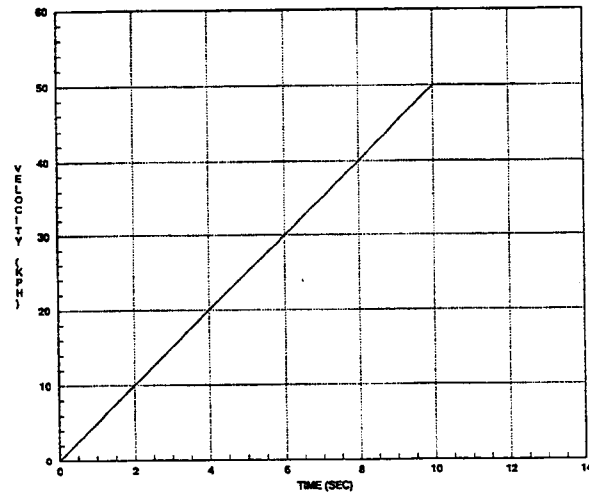

(b) desired vehicle velocity

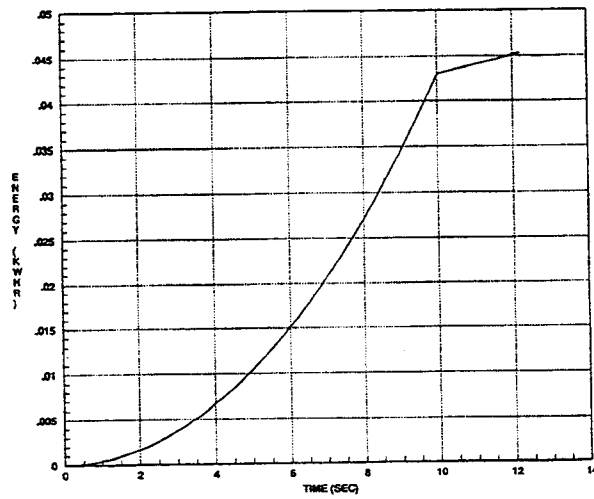

(c) energy deficit

Figure 5 Simulation results for $x_T = 100.0$ m, $\theta = 0.0$ rad.

5. Bibliography

- [1] Cole, G. H., *SIMPLEV: A SIMPLE ELECTRIC VEHICLE SIMULATION PROGRAM (VERSION 1.0)*, DOE/ID-10293, Idaho National Engineering Laboratory, June 1991.
- [2] Hennessey, M. and Donath, M. "Quantifying Auxiliary Power Needs for the E-TRAN Electric Vehicle Propulsion Concept," ISI Annual User's Conference on the MATRIXx™ Product Family, San Jose, CA, March 16, 1993.
- [3] Integrated Systems Incorporated, *System Build Version 2.01 Core Module -- User's Guide* (for use with MATRIXx™), Edition 8, MD6002-010, Santa Clara, January 1990.

Section III

Evaluation of the E-TRAN Vehicle Propulsion Concept -- Experimental Verification of a 1 Degree of Freedom Road Pantograph Dynamic Model

Abstract

The dynamic effects of an E-TRAN road pantograph in contact with a road mounted power strip are studied. During usage, the road pantograph (supported underneath the vehicle) allows power to be drawn from the strip for powering the motor driven vehicle. From a mechanical point of view, friction, wear and dynamic bounce effects impact the reliability and maintainability of the pantograph/strip concept. To study bounce effects, a dynamic model of a 1 degree of freedom road pantograph was developed for both contact and noncontact situations. These dynamic "bounce" effects were simulated using a MATRIXx™ based model of the road pantograph and associated road surface (and strip). To corroborate the dynamic model, an instrumented experimental pantograph/road simulator was fabricated. Fair correspondence was achieved between the experimentally measured and simulated support forces (peak-peak within 17 %) and pantograph angle (within 2 %). Parametric variations in the design were also studied through simulation. The work presented serves as a paradigm for designing, building, and testing road pantographs for specific applications.

Nomenclature:

Parameters

θ_0	-- reference or equilibrium pantograph angle for torsional spring (rad)
K_θ	-- torsional stiffness of pantograph torsional spring (Nm/rad)
m_p	-- lumped mass of pantograph (kg)
l_p	-- length of pantograph arm (m)
b_θ	-- torsional damping of pantograph torsional spring (Nm/(rad/sec))
μ	-- coefficient of Coulomb friction between pantograph wiper tip and road surface
g	-- acceleration of gravity (9.8 m/sec ²)
τ_s	-- torsional joint Coulomb friction (Nm)
l_b	-- length of "ramp" bump on road surface (m)
h_b	-- height of "ramp" bump on road surface (m)
x_b	-- x coordinate location of beginning of bump (m)

Variables, Functions and Sets

θ	-- pantograph angle (rad)
(x_s, z_s)	-- Cartesian coordinates of vehicle pantograph support point (m,m)
(x_w, z_w)	-- Cartesian coordinates of wiper tip of pantograph (m,m)
$z_r(x_r)$	-- road surface profile (m)
F_{x_s}	-- pantograph support force in x direction (N)
F_{z_s}	-- pantograph support force in z direction (N)
F_n	-- normal contact force between road surface and pantograph wiper tip (N)
x_r	-- independent variable representing lateral road position (m)
$z'_r(x_r)$	-- first spatial derivative of road surface profile in z direction
$z''_r(x_r)$	-- second spatial derivative of road surface profile in z direction (1/m)
ϕ	-- local road angle, $\text{Tan}^{-1}(z'_r)$ (rad)
$\dot{\theta}$	-- first time derivative of pantograph angle (angular rate, rad/sec)
$\ddot{\theta}$	-- second time derivative of pantograph angle (angular acceleration, rad/sec ²)
\dot{x}_s	-- first time derivative of x_s vehicle position (vehicle velocity, m/sec), i.e. "road speed"
\dot{z}_s	-- first time derivative of z_s vehicle position (vehicle velocity, m/sec)
$\sin(\bullet)$	-- sine function, etc.
$\text{sgn}(\bullet)$	-- algebraic sign (i.e. +1 or -1) of a real scalar
C^n	-- the set of all real valued scalar functions that possess a continuous nth derivative (e.g. $n = 1$ or 2); note if $n = 0$ (i.e. when just considering the function), the superscript is dropped

Inputs

\ddot{x}_s -- second time derivative of x_s vehicle position (vehicle acceleration, m/sec²)

\ddot{z}_s -- second time derivative of z_s vehicle position (vehicle acceleration, m/sec²)

1. Introduction

Based on the system engineering study of Section I, numerous specific research problems have been identified. These include: developing a viable roadway "pantograph," studying the dynamic effects of pantograph bounce, "vanishing" power input discontinuities, power distribution issues, power strip design, economics, etc. to name a few. The focus of this section is primarily on studying the dynamic effect of pantograph "bounce" or loss of contact between the pantograph and the road/strip surface. Pantograph bounce can significantly affect the performance of the system by reducing the contact time thereby causing power losses and arcing. It also introduces undesirable loading to both the pantograph and the support on the vehicle which can cause damage over time.

Previous researchers have studied pantographs for use in transmitting power above electric trains. Because of the significant usage of electric trains in Europe and Japan over many decades (unlike the U. S.), the European and Japanese literature includes many articles on pantograph devices. Sample papers on pantographs include topics on experimental and analytical evaluation of dynamics (such as in Seering, et al [6] or Eppinger, et al [1]), kinematic and static analysis (as in Funabashi, et al [2]), spring equilibrators theory (Shin and Streit [7]), and high speed contact performance (e.g. Manabe [5]). While this body of work is relevant to our problem, fundamental differences exist between road pantographs and overhead pantographs; both from an application point of view (e.g. catenaries are not driven on) and from a mechanical point of view. More specifically, there exists vertical compliance in the catenary and displacement disturbances are not as severe. For example, consider a bump on the road or power strip versus low frequency catenary vibrations. Because of this, in the overhead pantograph case, the input to the pantograph may be accurately approximated as a displacement rate input (e.g. as in Seering, et al [6]). In the road pantograph case however, a detailed road surface/pantograph interaction model is preferred. A paper conceptually similar to the work presented here is found in Graham et al (see [3]) where an air cushion suspension system is designed for the power pickup of an inductively powered electric bus.

2. Specific Objectives

Realizing the critical role of the sliding contact pantograph in the E-TRAN concept (and other similar pantograph systems) based on our preliminary evaluation, there is a need to further study the pantograph/road surface interaction. This can be accomplished through appropriate dynamic modeling, simulation and experimentation. A road pantograph test machine and test pantograph was designed and assembled for this purpose. In addition, a 1 degree of freedom (DOF) road pantograph dynamic simulation was developed. Using these tools, we will:

- Investigate the effects of road bumps on the pantograph's trajectory (i.e. the "bounce" effect)
- Monitor pantograph support and contact force levels during simulated usage over an irregular road surface (i.e. one with bumps)
- Achieve correspondence between theory, simulation, and experimental results

This approach provides a paradigm for designing, building, and testing of a road pantograph for a specific application. During the design phase, viable pantograph concepts would be generated based on application requirements. Through dynamic computer simulations (and other related analyses) a final pantograph design would be developed. After this, the pantograph would be built and tested. In this paper, we illustrate key aspects of this process (including modeling, simulation, and experimentation) for the case of a simple 1 DOF pantograph.

3. 1 Degree of Freedom Pantograph Dynamic Model

Since we are only considering vehicle motion primarily in one direction (i.e. longitudinally along the roadway) and since there is a practical need to design a pantograph that deflects (as opposed to becoming entangled) when in contact with road obstacles, it is appropriate to consider a simple 1 DOF pantograph. This pantograph pivots about a point on the vehicle while the passive pantograph arm drags

behind on the road surface -- see Figure 1. This model, while simple, retains all essential aspects of the problem. It features friction, support compliance and damping, basic geometrical aspects, and a road & vehicle displacement input. While power strip suspension could be included, we will assume that the road surface/power strip is essentially rigid. Pantograph "bounce" can originate from either contact with a "bump" on the road surface or from pantograph support displacement disturbances. We will investigate the former because it is simpler to investigate experimentally. Two types of dynamic models are needed; one during contact and one during noncontact. In both cases, the input to the model is the motion of the pantograph support on the vehicle (this corresponds to driving the vehicle) and the outputs are geometric and force variables of interest.

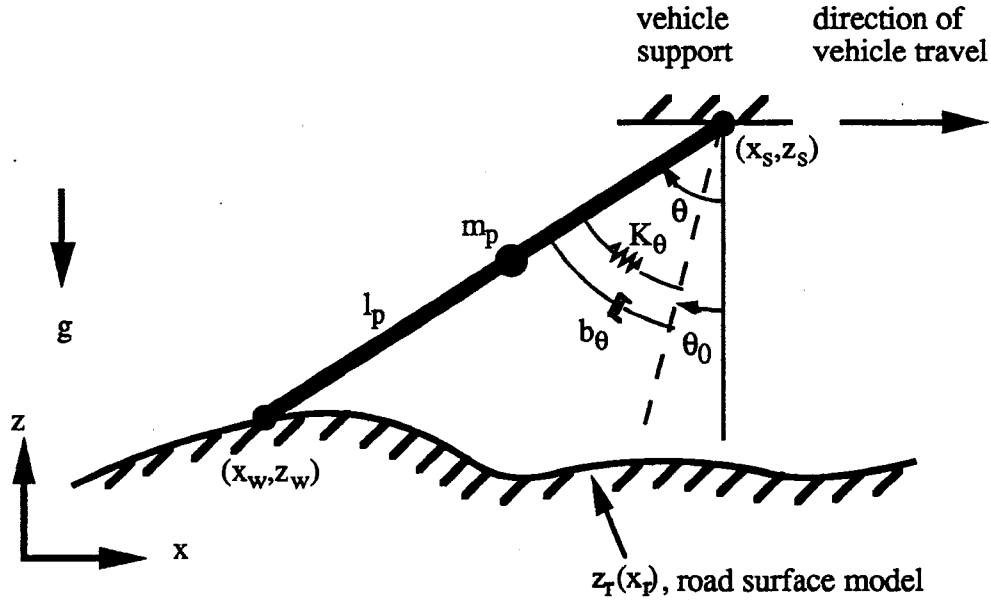

Figure 1 One DOF sliding contact road pantograph dynamic model.

3.1 Contact Model

From a free body diagram analysis of the pantograph arm the following equations may be derived:

$$F_{x_s} - F_n \sin \phi - \mu F_n \cos \phi = m_p \frac{d^2}{dt^2} \left(x_s - \frac{l_p}{2} \sin \theta \right) \quad (1)$$

$$F_{z_s} - m_p g + F_n \cos \phi - \mu F_n \sin \phi = m_p \frac{d^2}{dt^2} \left(z_s - \frac{l_p}{2} \cos \theta \right) \quad (2)$$

$$\tau_s \text{sgn}(\dot{\theta}) + b_\theta \dot{\theta} + K_\theta (\theta - \theta_0) - F_{x_s} \left(\frac{l_p}{2} \right) \cos \theta + F_{z_s} \left(\frac{l_p}{2} \right) \sin \theta - F_n \left(\frac{l_p}{2} \right) \sin(\theta + \phi) - \mu F_n \left(\frac{l_p}{2} \right) \sin(\theta + \phi) = 0 \quad (3)$$

The above equations represent a summation of forces in both x and z directions, along with a summation of torques about the mass centroid of the pantograph arm, respectively. The above model assumes that the road model is known which in turn determines θ , $\dot{\theta}$, and $\ddot{\theta}$. Therefore, there are 3 equations that can be solved for 3 unknown forces (F_{x_s} , F_{z_s} , and F_n). Support motion (i.e. velocity and acceleration in the x and z direction) serves as the input to the model. After some algebraic manipulation, these equations may be solved to yield:

$$F_n = \frac{N}{D} \quad (4)$$

where:

$$N = \left(\frac{K_\theta}{l_p}\right)(\theta - \theta_0) + \left(\frac{b_\theta}{l_p}\right)\dot{\theta} + \left(\frac{\tau_s}{l_p}\right)\text{sgn}(\dot{\theta}) + \left(\frac{m_p}{2}\right)(g\sin\theta + \sin\theta \dot{z}_s - \cos\theta \dot{x}_s + \left(\frac{l_p}{2}\right)\ddot{\theta}) \quad (5)$$

and:

$$D = \sin(\theta + \phi) + \mu\cos(\theta + \phi) \quad (6)$$

$$F_{x_s} = F_n(\mu\cos\phi + \sin\phi) + m_p\dot{x}_s - \left(\frac{m_p l_p}{2}\right)\cos\theta \ddot{\theta} + \left(\frac{m_p l_p}{2}\right)\sin\theta \dot{\theta}^2 \quad (7)$$

$$F_{z_s} = -F_n(\cos\phi - \mu\sin\phi) + m_p g + m_p \dot{z}_s + \left(\frac{m_p l_p}{2}\right)\sin\theta \ddot{\theta} + \left(\frac{m_p l_p}{2}\right)\cos\theta \dot{\theta}^2 \quad (8)$$

Of course $F_n > 0$ during contact. Also, another assumption pertains to the location of the point of contact. We will assume that there is only one point of contact (at the end of the pantograph arm); i.e.:

$$z_r(x^*) < z_s - l_p\cos\theta + (x^* - (x_s - l_p\sin\theta)) / \tan\theta \quad (9)$$

for $x_s - l_p\sin\theta < x^* \leq x_s$.

Finally, given road profiles, one can evaluate $\dot{\theta}$ and $\ddot{\theta}$ by implicitly differentiating the following geometric contact condition given by:

$$z_r(x_s - l_p\sin\theta) = z_s - l_p\cos\theta \quad (10)$$

$\dot{\theta}$ and $\ddot{\theta}$ are then given by:

$$\dot{\theta} = \frac{z'_r \dot{x}_s - \dot{z}_s}{l_p\sin\theta + z'_r l_p\cos\theta} \quad (11)$$

$$\ddot{\theta} = \frac{z'_r(l_p\sin\theta \dot{\theta}^2 + \dot{x}_s) + z''_r(\dot{x}_s - l_p\cos\theta \dot{\theta})^2 - l_p\cos\theta \dot{\theta}^2 - \ddot{z}_s}{l_p\sin\theta + z'_r l_p\cos\theta} \quad (12)$$

where $z_r \equiv z_r(x_s - l_p\sin\theta)$, etc.

3.2 Noncontact Model

The noncontact model equations are the same as the contact model equations with the constraint $F_n = 0$, i.e.:

$$F_{x_s} = m_p \frac{d^2}{dt^2} (x_s - \frac{l_p}{2}\sin\theta) \quad (13)$$

$$F_{z_s} - m_p g = m_p \frac{d^2}{dt^2} (z_s - \frac{l_p}{2}\cos\theta) \quad (14)$$

$$\tau_s \text{sgn}(\dot{\theta}) + b_\theta \dot{\theta} + K_\theta(\theta - \theta_0) - F_{x_s} \left(\frac{l_p}{2}\right)\cos\theta + F_{z_s} \left(\frac{l_p}{2}\right)\sin\theta = 0 \quad (15)$$

Unlike the contact model however, θ , $\dot{\theta}$, and $\ddot{\theta}$ are not determined by the road model and a different solution mechanism is required (i.e. it's not algebraic). Given appropriate initial conditions $\theta(0)$ and $\dot{\theta}(0)$,

one can integrate out the solution of the nonlinear differential equations from the angular acceleration $\ddot{\theta}$:

$$\ddot{\theta} = \frac{2}{I_p} (\cos\theta \dot{x}_s - \sin\theta \dot{z}_s - g\sin\theta - \left(\frac{2K_\theta}{m_p l_p}\right)(\theta - \theta_0) - \left(\frac{2b_\theta}{m_p l_p}\right)\dot{\theta} - \left(\frac{2\tau_s}{m_p l_p}\right)\text{sgn}(\dot{\theta})) \quad (16)$$

The support forces are outputs given by:

$$F_{xs} = m_p \ddot{x}_s - \left(\frac{m_p l_p}{2}\right) \cos\theta \ddot{\theta} + \left(\frac{m_p l_p}{2}\right) \sin\theta \dot{\theta}^2 \quad (17)$$

$$F_{zs} = m_p g + m_p \ddot{z}_s + \left(\frac{m_p l_p}{2}\right) \sin\theta \ddot{\theta} + \left(\frac{m_p l_p}{2}\right) \cos\theta \dot{\theta}^2 \quad (18)$$

Note that linear approximations to Equation (16) are only valid over small angular changes. In our case we are interested in the large angular excursion solution and linear approximations are not accurate enough. Because of this, our analysis will rely on numerical solutions (versus closed-form analytical solutions).

4. Simulation Issues

A dynamic simulation package (i.e. MATRIXx) was used to provide numerical solutions to the pantograph dynamics problem -- for a complete listing of the blocks and their structure see Appendix G of [4]. Some special issues arose concerning the:

- Realization of the dynamics equations
- Coordination of both contact and noncontact dynamic models and the duration of the simulation
- Integration time step
- Parameter selection, initial conditions, and inputs
- Handling of non-C or non-C¹ road surface geometries

Realization of Dynamic Equations

For convenience, in all cases an analog block diagram representation using "SYSTEM BUILD" (as opposed to writing code directly) was used to represent the dynamic equations. Modularity was adhered to with 35 simulation blocks comprising the entire simulation.

Coordination of Dynamic Models and the Duration of the Simulation

Before running the noncontact portion of the simulation, a set of initial conditions (i.e. $\theta(0)$ and $\dot{\theta}(0)$) is required. Because of this, one must identify these initial conditions at the appropriate time and reset integrators appropriately. To facilitate this an "integrator reset" superblock was created. The integrator reset block accepts three signals continuously: (1) the signal to be integrated, (2) an integrator reset pulse, and (3) the reset value in pulsed form (to allow zero as an admissible reset value). This was a custom block that requires 1 internal discrete integrator for every time the integrator is to be reset. To minimize the integrator reset logistics and number of internal integrators and focus primarily on the bounce effect, the integrator is only reset once. In essence then, the simulation assumes the following sequence of events:

- The pantograph tip is initially in contact with the road surface
- While moving along a flat road surface it comes into contact with a "bump"
- It leaves contact with the road surface (i.e. it "bounces") and returns to reestablish contact

Integration Time Step

The integration time step (i.e. Δt) used was approximately 1/5 the ratio of the length of the bump divided by the vehicle's lateral speed. For typical highway speeds and bumps that were simulated, $\Delta t \approx 0.2$ ms.

Parameter Selection, Initial Conditions, and Inputs

The parameters and initial conditions used in the simulation were selected to closely match those in the experiment described below. They are listed in Table 1.

Table 1 Pantograph Parameters, Initial Conditions, and Inputs

Parameters

$$\theta_0 = 0.59 \text{ rad}$$

$$K_\theta = 0.35 \text{ Nm/rad}$$

$$m_p = 0.102 \text{ kg}$$

$$l_p = 0.184 \text{ m}$$

$$b_\theta = 9.6\text{E-}04 \text{ Nm/(rad/sec)}$$

$$\mu = 0.2$$

$$g = 9.8 \text{ m/sec}^2$$

$$\tau_s = 3.535\text{E-}04 \text{ Nm}$$

$$l_b = 0.0492 \text{ m}$$

$$h_b = 0.0187 \text{ m}$$

$$x_b = 1.3024 \text{ m}$$

Initial Conditions

$$\theta(0) = 0.96 \text{ rad}$$

$$\dot{\theta}(0) = 0.0 \text{ rad/sec}$$

$$(x_s, z_s) = (0.1507, 0.1055) \text{ m}$$

$$(x_w, z_w) = (0.0, 0.0) \text{ m}$$

$$\dot{x}_s(0) = 16.0 \text{ m/sec}; \text{ note: in our case this is essentially the input to the system}$$

$$\dot{z}_s(0) = 0.0 \text{ m/sec}$$

Inputs

$$\ddot{x}_s = 0.0 \text{ m/sec}^2$$

$$\ddot{z}_s = 0.0 \text{ m/sec}^2$$

$$\text{Road Model: } z_r(x_r) = 0 \text{ } \{x_r \leq x_b \text{ or } x_r > x_b + l_b\} \text{ -- on flat road}$$

$$z_r(x_r) = \left(\frac{h_b}{l_b}\right)(x_r - x_b) \text{ } \{x_b < x_r \leq x_b + l_b\} \text{ -- on "ramp" bump}$$

The "ramp" bump essentially induces a large angular increment in a short period of time thereby producing a large angular rate initial condition for the noncontact pantograph arm dynamics model.

Handling of Non-C or Non-C¹ Road Surface Geometries

At a practical level, road surfaces may not be smooth due to different road types, local variation, settling, vehicle loading, etc. Mathematically speaking, if the road surface is characterized as a function of the longitudinal excursion along the road (i.e. $z_T(x_T)$) this function (and some of its derivatives) may not be continuous. If the road surface profile $z_T(x_T)$ is characterized by a C^2 function, the above formulas for $\dot{\theta}$ and $\ddot{\theta}$ (i.e. Equations (11) and (12)) can be used directly. However, if $z_T(x_T)$ is not a C^2 function care must be taken in evaluating $\dot{\theta}$ and $\ddot{\theta}$. In our case $z'_T(x_T)$ is not continuous at the base of the bump. This can be resolved by resetting the integrator that outputs $\dot{\theta}$ appropriately when the pantograph tip is at the base of the bump. As for the discontinuity at the top of the bump in $z_T(x_T)$, we will switch to the noncontact model at that time. Because of the above comments, one can expect discontinuities in the force versus time profiles; both at the bottom of the ramp bump and at the top of the ramp bump.

5. Pantograph/Road Simulator

Dynamic computer simulations alone can not guarantee that the design will work appropriately. Experimentation is needed as well. Conversely, experimentation alone is not practical because of its time consuming nature, therefore appropriate computer simulations are warranted as well. To permit experimental testing of different road pantographs on different road surfaces, a pantograph/road simulator was constructed. It consists of a modified vertical axis tire balancer, spinning disk (serving as the moving road), 1 DOF test pantograph, and associated instrumentation -- see photograph in Figure 2. For baseline experiments, the surface of the spinning disk is made of sheet metal with a linear ramp serving as the road bump. This road bump, while perhaps severe, will serve as a benchmark case on which to test our actual pantograph and the pantograph simulation. Modified power strip segments could be mounted to the disk to permit electrical testing (e.g. current draw, etc.) if desired. The disk spins at approximately 500 rpm and the contact radius is such that one can simulate typical highway speeds (30 kph to 90 kph). The pantograph arm resembles the iconic representation shown in Figure 1. In this design, provision has been made for readily changing certain parameters such as the mass of the arm, the spring's equilibrium point, the torsional stiffness (i.e. through spring replacement), the length of the arm, and the type of contact material (i.e. "brush"). Instrumentation used includes a high resolution (0.5 degree) rotary potentiometer for measuring the angle of the pantograph (i.e. θ) and 2 channels of a 6 axis load cell to measure the support forces F_{xS} and F_{zS} .

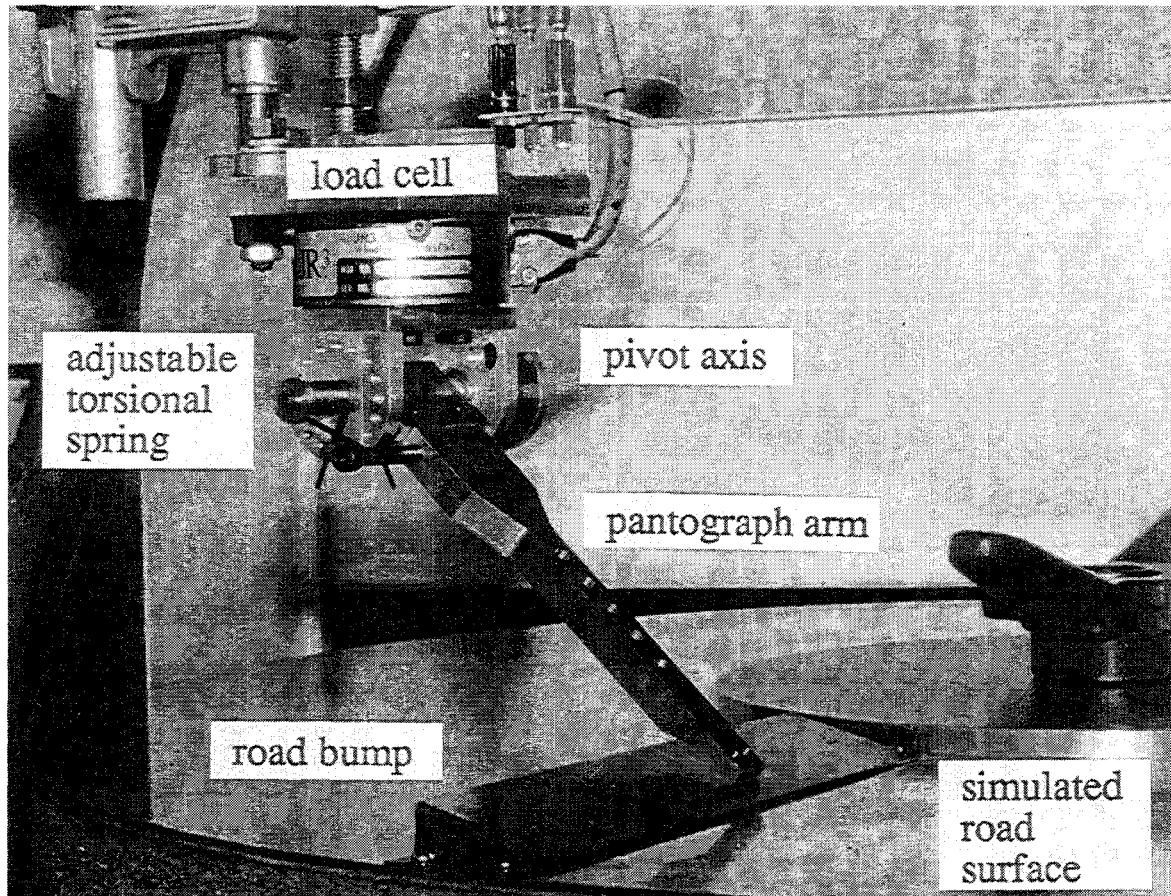

Figure 2 Experimental pantograph/road simulator test machine.

6. Experimental Results

A number of experimental runs were conducted in order to ensure a high degree of correspondence between theory and simulation (see Table 1 for parameter list) and the measured signals. The experimental procedure consisted of gently releasing the preloaded pantograph arm onto the spinning disk. This was necessary due to the large dynamic time constant of the tire balancer, the existence of the ramp, the periodic nature of the road simulator, and the speed of the spinning disk. Because of this, one could not guarantee that the pantograph arm tip would contact the disk in any particular location and multiple runs were necessary to make sure that the initial conditions of the experiment were essentially the same as in the

simulation (i.e. $\dot{\theta}(0) = 0$). We are particularly interested in the short period of time during which the pantograph tip comes into contact with the ramp bump, is forced to move up along the incline and is "launched" into the air and returns to reestablish contact. This entire sequence constitutes a pantograph "bounce." Data was collected using LabVIEW2¹² with a 0.2 ms sampling rate (see Appendix K for the front panel and diagram used). Figures 3-5 show both the simulated and actual pantograph angle (θ) and support forces (F_{xs} and F_{zs}) during pantograph bounce.

¹² LabVIEW2 is a data acquisition package produced by National Instruments, Inc. that use data acquisition boards designed for most high end Macs or IBM PCs.

Figure 3 illustrates very good correspondence between the simulation and the measured θ during the experiment. Initially and prior to when the pantograph tip contacts the ramp bump, θ is essentially constant. Once the pantograph tip traverses along the road bump (a duration of only about 3 ms) it is launched into the air (over a range of about 60°) through an appropriate parabolic-like trajectory (as a function of time) returning to reestablish contact with the road surface. Notice that because of trigonometric nonlinearities, the trajectory is not a perfect parabola. Overall, the duration of the bounce is 118 ms (simulated) compared with 116 ms (actual) for a 2 % difference.

With the force sensor biases removed, fair correspondence between the simulated and actual force data is achieved; both in terms of the general shape of the angular and support force profiles as well as the specific numerical values at particular times (see Figures 4 and 5). Overall, actual peak-peak force values are within 17 % of the simulated support force peak-peak levels and the maximum pantograph angle is within 2 % of the simulated value.

The simulation predicts that both support forces (i.e. F_{xs} and F_{zs}) will be discontinuous at the beginning of pantograph contact with the ramp. This is because the slope of the road surface is discontinuous at this point (see Equations (11) and (12) and the road model from Table 1). Next, the force levels change slightly in an approximately linearly fashion during contact with the road bump (approximately 3 ms). After this the force levels change discontinuously when contact is lost with the road surface. In the next phase we see the force levels monotonically decreasing to a minimum while the pantograph angle increases to a peak. Finally, the force direction reverses (in both F_{xs} and F_{zs}) and the force levels increase until contact is reestablished. The experimental data tends to reflect the above sequence of events with the possible exception of the force profile during initial contact with the ramp bump -- i.e. the data appears delayed slightly and/or exhibits an additional oscillation or peak. It is believed this effect is due to some inherent structural flexibility in the experimental apparatus which is not taken into account anywhere in the model. Consistent with this conjecture is the fact that in earlier data runs this effect was even more pronounced (before the structure was stiffened significantly).

7. Simulation Results -- Parameter Variations

One advantage of the simulation model is that it can be used to investigate the effect that different parameters have on the system. In a general sense there are three different types of parameters (or inputs) to consider, namely: (a) those associated primarily with the road itself, (b) those associated the pantograph, and (c) vehicle motion effects (or system inputs). While there are many parameters that one could vary, we will focus on parameters of special relevance to the road pantograph design or ones that the system is highly sensitive to. Road parameters may be viewed as a constraint to the pantograph design problem and include such parameters as Coulomb friction, μ , and the height of the linear bump. Key design parameters for the pantograph include the mass, m_p , the torsional stiffness, K_θ , and the bias force characterized by θ_0 . Finally, a key system input is the nominal vehicle speed $\dot{x}_s(0)$. Below we will quantify the effects of each of these 6 parameters and present "design" curves (for the angular trajectory $\theta(t)$) based on perturbations from the nominal simulation performed above (in section 6).

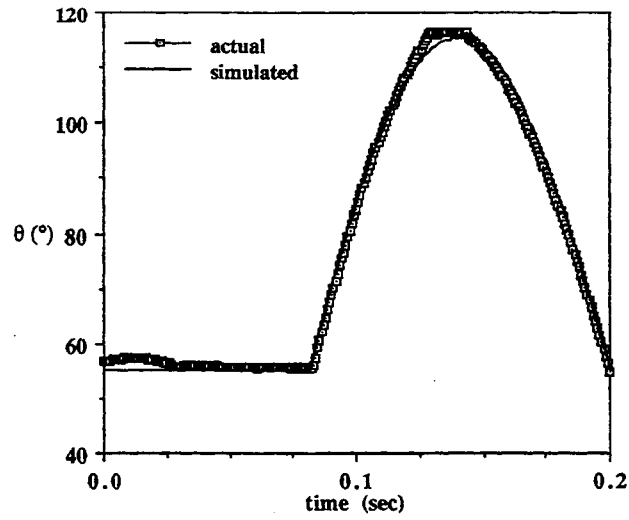

Figure 3 Plot of θ versus time during pantograph bounce.

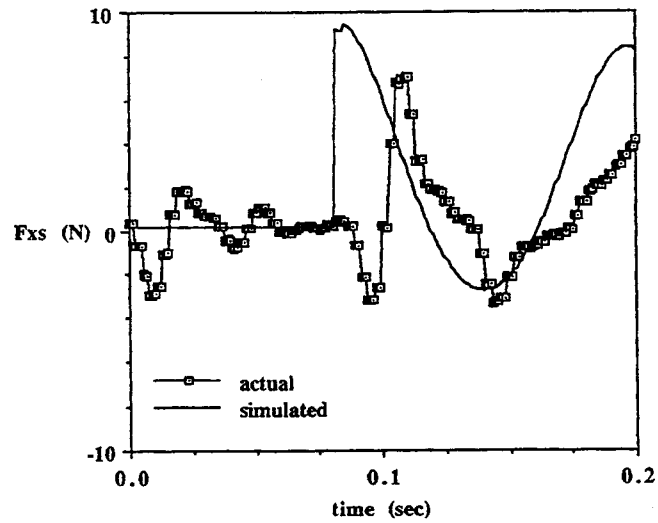

Figure 4 Plot of lateral pantograph support force F_{xs} versus time during pantograph bounce.

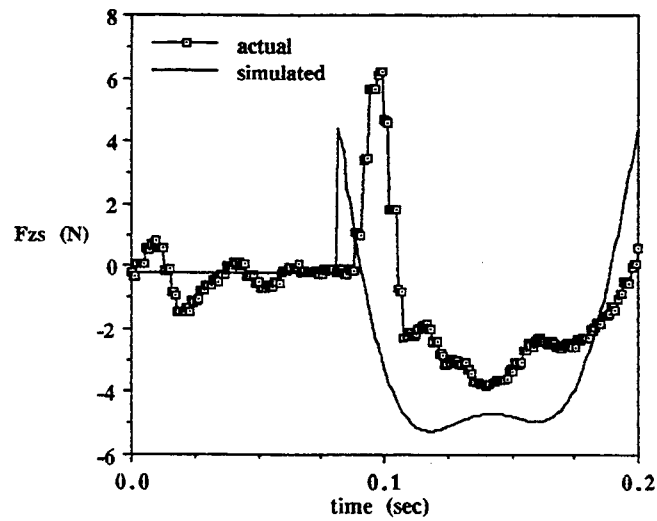

Figure 5 Plot of vertical pantograph support force F_{zs} versus time during pantograph bounce.

Road Parameters

Road friction, μ , does not affect the angular trajectory (provided that contact is established along the entire length of the bump). This is because the initial conditions for the noncontact model are determined by purely geometric conditions. However, as seen from Equations (7) and (8), it can significantly affect the force levels during contact. The height of the linear road bump may be viewed as one measure of how bumpy the road is, i.e. if h_b is large (small), the road is bumpy (smooth). Figure 6 illustrates the effect of a factor of 2 variation in h_b from nominal. Notice how sensitive the peak height is, varying from a low differential peak value of 27° ($h_b = 0.00935$ m) to a high differential peak value of 125° ($h_b = 0.0374$ m). In general, this simulation provides an example of how sensitive the road pantograph motion is to the road surface geometry. Clearly, there exist practical limitations on how bumpy the road can be. The road pantograph will function much better on a flat, smooth road with no bumps.

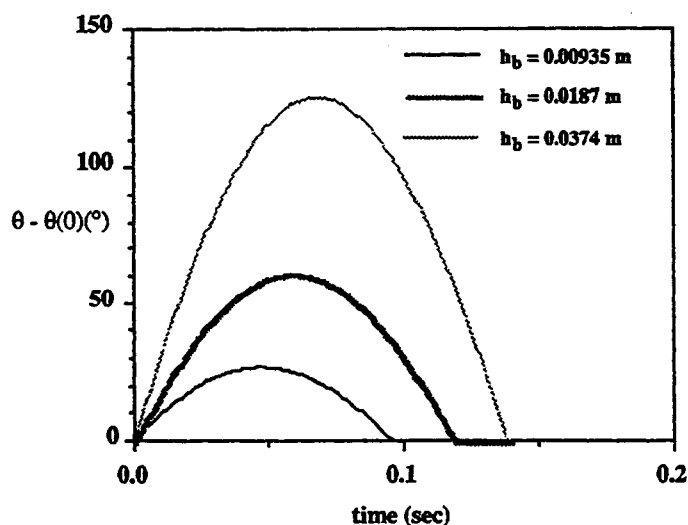

Figure 6 Effect of road bump height on pantograph angular peak height.

Pantograph Parameters

With all other parameters constant (i.e. road parameters and road speed) we can study the effect of some key pantograph design parameters such as the pantograph mass, m_p , the torsional stiffness, K_θ , and the bias force characterized by θ_0 . Figure 7 shows the effect of varying the mass by a factor of 2; notice that as the mass increases, the peak angular height also increases (and vice-versa). This is because the ramp bump essentially acts as a velocity source for the pantograph, setting the initial values ($\theta(0)$ and $\dot{\theta}(0)$) for the noncontact dynamic problem. From a design perspective, this result encourages one to reduce the mass of the pantograph, thereby making it more responsive and reducing the loss of contact time while traversing over road bumps. The tradeoff of mass reduction, is of course structural integrity. Both K_θ and θ_0 have generally the same effect, with the equilibrium angle serving as a means of setting the nominal force level exerted on the road/strip surface. Figure 8 illustrates the effect of a factor of 2 variation of the stiffness; the peak differential angular height varies from 42° to 84° . Similar comments apply for variations in the equilibrium angle as shown in Figure 9 (a factor of 0.5 variation in θ_0 produces a variation of peak differential angular height of 19°). In general increasing either K_θ and θ_0 will reduce the

duration of the loss of contact which is desirable. However, this increase also generates larger force levels, so again a design tradeoff exists.

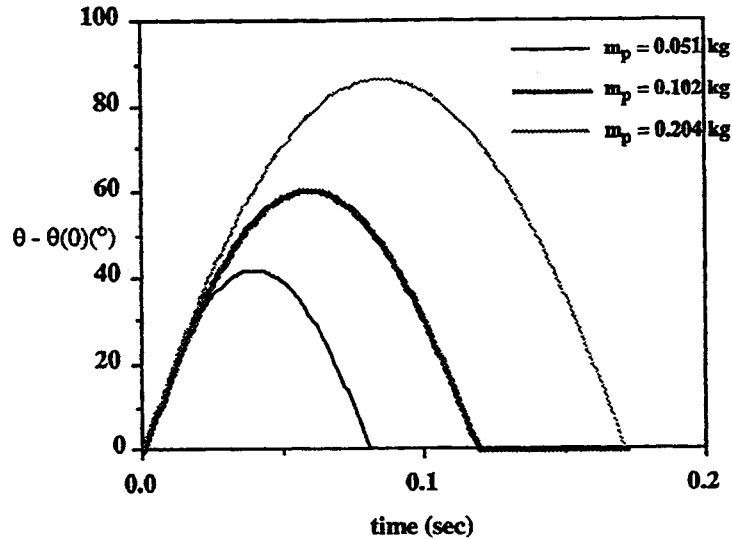

Figure 7 Effect of mass on pantograph angular peak height.

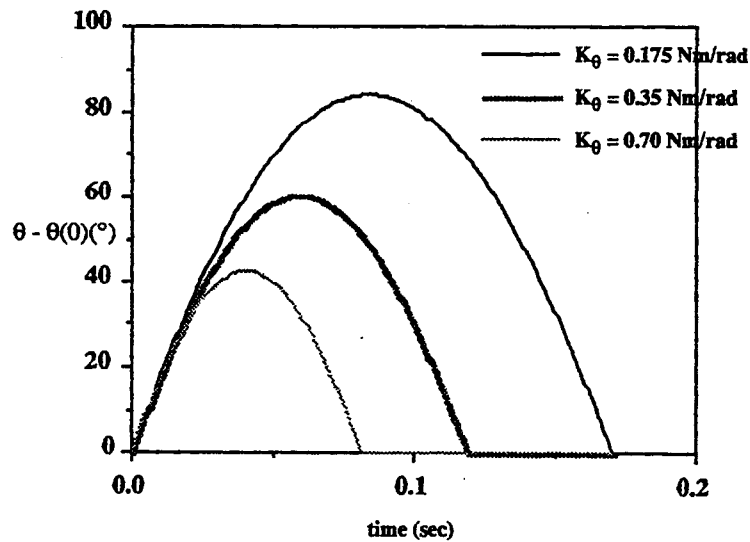

Figure 8 Effect of stiffness K_θ on pantograph angular peak height.

Vehicle Motion Effects

Given a particular pantograph design and road/strip surface, driver inputs will also affect the performance of the pantograph. The pantograph is sensitive to the support accelerations (\dot{x}_s and \dot{z}_s) and the initial conditions ($x_s(0)$, $\dot{x}_s(0)$, $z_s(0)$, and $\dot{z}_s(0)$). To simplify matters, we will focus on the effects of constant road speed ($\dot{x}_s(0)$) on pantograph angular bounce height. Figure 10 shows the variation in pantograph angular bounce height for typical road speeds (i.e. "slow" -- 8.0 m / s, "nominal" -- 16.0 m / s, and "fast" -- 32 m / s). The height variation is significant (e.g. 145° of "bounce at 32.0 m / s versus 25° of bounce at 8.0 m / s) and the performance of the system is highly sensitive to the effects of road speed. These results suggest that as the road speed increases, the road should be smoother and flatter. Even small

surface irregularities can potentially cause problems at high speeds. Because of this, low operating speeds will always be preferred.

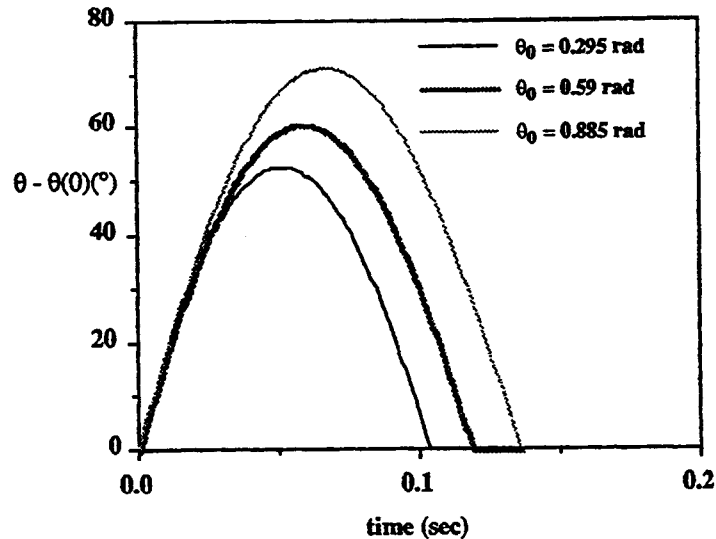

Figure 9 Effect of spring equilibrium angle θ_0 on pantograph angular peak height.

8. Summary and Conclusions

Road pantographs are useful for electric vehicle applications (such as the "E-TRAN" electric vehicle concept) that involve drawing power from a road mounted power strip. During normal operation physical contact is established between the vehicle mounted pantograph brush and the road mounted power strip. Loss of contact is of particular interest from a performance and wear point of view. To examine the dynamic bounce effects of road pantographs, the dynamic characteristics of a 1 DOF test road pantograph were studied theoretically, through simulation, and experimentally. Fair correspondence was achieved between the theoretical modeling, simulation, and the experiments. Support forces (in 2 directions) and the pantograph angle were measured during a simulated pantograph bounce (caused by driving over a bump). Measured peak-peak support forces were within 17 % of those predicted in the simulation and the measured maximum pantograph angle was within 2 % of that predicted by the simulation.

The work presented serves as a paradigm for designing, building, and testing vehicle pantographs for specific applications. It was learned that the road surface/pantograph interaction, while somewhat complicated, can be effectively studied through simulation. The effects of some key system parameters were studied in simulation. This realization suggests that it is possible to reduce design time and expense when designing, building, and testing road pantographs. The next step would be to adopt this approach when designing an actual road pantograph for a specific application. Various designs could be checked out in simulation (e.g. how well do the different pantographs handle different types of bumps, what are the force levels, etc.) prior to fabrication of a good design. The road simulator machine could then be used to experimentally test performance of the pantograph designed prior to integrated vehicle testing.

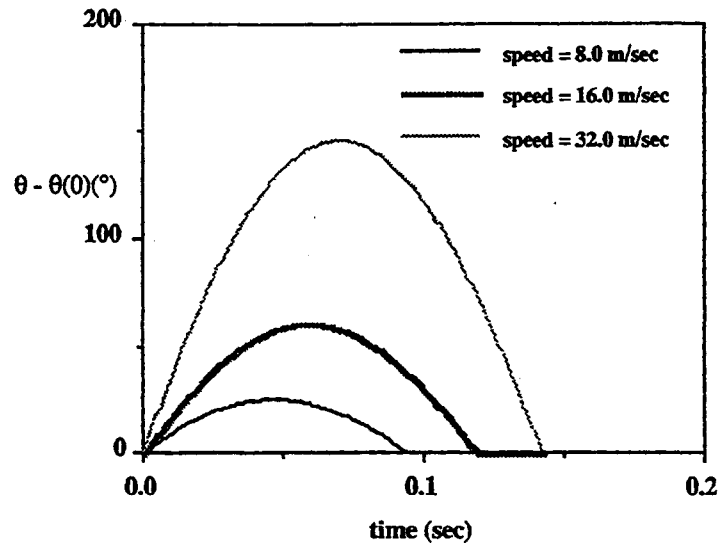

Figure 10 Effect of road speed $\dot{x}_s(0)$ on pantograph angular peak height.

9. Bibliography

- [1] Eppinger, S. D., O'Connor, Seering, W. P., and Wormley, D. N., "Modeling and Experimental Evaluation of Asymmetric Pantograph Dynamics," *ASME Journal of Dynamic Systems, Measurement, and Control*, Vol. 110, June 1988, pp. 168-174.
- [2] Funabashi, H., Horie, M., Tachiya, H., and Tanio, S., "A Synthesis of Robotic Pantograph Mechanisms based on Working Spaces and Static Characteristic Charts," *JSME International Journal*, Series III, Vol. 34, No. 2, 1991.
- [3] Graham, T. A., Sullivan, P. A., and Payne, C. R., "Design of an Air Cushion Suspension for an Electric Bus Inductive Power Pickup," *Canadian Aeronautics and Space Journal*, Vol. 34, No. 2, June 1988, pp. 107-118.
- [4] Integrated Systems Incorporated, *System Build Version 2.01 Core Module -- User's Guide* (for use with MATRIXx™), Edition 8, MD6002-010, Santa Clara, January 1990.
- [5] Manabe, K., "High-Speed Contact Performance of a Catenary-Pantograph System," *JSME International Journal*, Series III, Vol. 32, No. 2, 1989.
- [6] Seering, W., ArmBruster, K., Vesely, C., and Wormley, D., "Experimental and Analytical Study of Pantograph Dynamics," *ASME Journal of Dynamic Systems, Measurement, and Control*, Vol. 113, June 1991, pp. 242-247.
- [7] Shin, E. and Streit, D., "Spring Equilibrator Theory for Static Balancing of Planar Pantograph Linkages," *Mech. Mach. Theory*, Vol. 26, No. 7, pp. 645-657, printed in Great Britain, 1991.

Evaluation of the E-TRAN Vehicle Propulsion Concept -- Summary and Conclusions

The E-TRAN electric vehicle propulsion concept was described and evaluated from an objective engineering point of view. While originally touted as a promising approach to solving some of our country's transportation problems (on highways, etc.), a careful examination of the technology through a *system engineering study* reveals several very difficult practical problems that must be overcome. Specifically, these were (a) **electrical safety** and (b) **reliability and maintainability** of the pantograph/power strip concept. Other serious issues exist as well. As part of the system engineering effort a specific list of conditions were described in order to identify applications for E-TRAN. To summarize, the technology in its present state can only be considered for the "low mass, low speed" case, i.e., factory vehicles, go-carts and the like. Higher mass applications (e.g. buses, shuttles, etc.) are recommended if electrical safety issues (along with other issues) can be resolved.

Two research problems generated by the system engineering study were investigated. One dealt with the effect of power input discontinuities and the other with the dynamic effects of road pantograph bounce. In the case of power input discontinuities, the effect of failed strip elements, lane changing, and grid discontinuities were studied. Grid discontinuities are potentially the most problematic, pointing to the need for an auxiliary power mode (e.g. batteries). Pantograph bounce was studied theoretically, in simulation, and through experimentation. Good correspondence was achieved and the work serves as the basis for an engineering approach to the design, fabrication, and testing of road pantographs for specific applications (e.g. factory vehicles).

In spite of our critical remarks in certain technical areas, we believe that the E-TRAN technology has a future for various pockets of the transportation sector (certainly for the applications listed and possibly more) and encourage them to proceed wisely to exploit the opportunities available to them, starting out with the more tractable applications. At this time no follow-on research is recommended. Our recommendation to E-TRAN, Inc. is that they pursue a focused design effort addressing a specific type of product (e.g. go-cart system, factory vehicle charging station, etc.) and more detailed system engineering and marketing studies, including cost analyses. The results of the studies presented here can serve as a basis for future design analyses by E-TRAN, Inc. personnel.

