

MN DEPT OF TRANSPORTATION
3 0314 00023 8864



Final Report 1998-07



Relationship Between Timber Bridge Characteristics and Asphalt Pavement Wear Surface Performance

CTS
TG
365
.L36
1997



Minnesota Local Road
Research Board



1. Report No. 1998-07		2.		3. Recipient's Accession No.	
4. Title and Subtitle RELATION BETWEEN TIMBER BRIDGE CHARACTERISTICS AND ASPHALT PAVEMENT WEAR SURFACE PERFORMANCE				5. Report Date June 1997	
				6.	
7. Author(s) Timothy D. Larson Robert Seavey Douglas A. Lange				8. Performing Organization Report No.	
9. Performing Organization Name and Address Wood & Paper Science Department University of Minnesota 2004 Folwell Avenue St. Paul, MN 55108				10. Project/Task/Work Unit No.	
				11. Contract (C) or Grant (G) No. (C) 74708 TOC # 8	
12. Sponsoring Organization Name and Address Minnesota Department of Transportation 395 John Ireland Boulevard Mail Stop 330 St. Paul, Minnesota 55155				13. Type of Report and Period Covered Final Report 1996-1997	
				14. Sponsoring Agency Code	
15. Supplementary Notes					
16. Abstract (Limit: 200 words) Asphalt wear surfaces cover 1,378 of Minnesota's timber bridges. This study assessed the magnitude of premature asphalt deterioration on timber bridges; identified the primary mechanisms responsible for wear surface deterioration; and suggested methods for improving asphalt pavement performance on timber bridges. Research methods included surveys, meetings with several county engineers and tours of their timber bridges, interviews with both asphalt and timber bridge industry professionals, and literature reviews. The study revealed that approximately 50 percent of counties experience some problems with premature reduced serviceability of the asphalt pavement wear surfaces that cover their timber bridges. Possible pavement failure mechanisms include low-temperature cracking, reflective cracking from deck fault lines found at deck panel joint lines and deck lamination separations, asphalt fatigue fracturing, and asphalt de-bonding due to oil preservatives interference. The report presents the following proposed solutions for controlling timber bridge asphalt pavement cracking: asphalt pavement saw & seal, asphalt pavement fabric or material underlay, removal of extruded oil-type preservative before surfacing, conditioning of bridge timbers to the expected equilibrium moisture content before bridge installation, and tightening of timber decks through maintenance practices.					
17. Document Analysis/Descriptors timber bridge maintenance wood transportation structures asphalt pavement wear surfaces				18. Availability Statement No restrictions. Document available from: National Technical Information Services, Springfield, Virginia 22161	
19. Security Class (this report) Unclassified		20. Security Class (this page) Unclassified		21. No. of Pages 56	22. Price

Relationship Between Timber Bridge Characteristics and Asphalt Pavement Wear Surface Performance

Final Report Literature Review

Prepared by

Douglas A. Lange

Timothy D. Larson

Robert Seavey

Wood & Paper Science Department
University of Minnesota

June 1997

Prepared for the

Minnesota Department of Transportation
Office of Research Administration
200 Ford Building Mail stop 330
117 University Avenue
St. Paul, MN 55155

The contents of this report reflect the views of the authors who are responsible for the facts and accuracy of the data presented herein. The contents do not necessarily reflect the views or policies of the Minnesota Department of Transportation at the time of publication. This report does not constitute a standard, specification, or regulation. The authors and the Minnesota Department of Transportation do not endorse products or manufacturers. Trade or manufacturers' names appear herein solely because they are considered essential to this report.

Acknowledgments

The financial and logistical support provided by the Local Road Research Board, Wheeler Consolidated, Inc., Sibley County, Meeker County, Scott County and Anoka County for this work is gratefully acknowledged.

Executive Summary

In both the United States and Canada concerns have been expressed in regards to the expected long term serviceability of asphalt pavement wear surfaces on timber bridges. The proper function of an asphalt pavement wear surface on a timber bridge is important for providing both a safe and durable road surface, as well as for protecting the timber structure against premature wear and decay. Since Minnesota currently has a large population of timber bridges, at least 1378 which are covered with an asphalt wear surfaces, there is a foreseen need to evaluate the performance of timber bridge wear surfaces in order to ensure the states' large investment is properly protected. An assessment of the performance of the asphalt pavement wear surfaces on timber bridges was completed, and recommended modifications for improvement were addressed. This report presents these results and recommended future research activities.

The study of timber bridge wear surface performance was conducted in two phases; the first phase was a survey and timber bridge tour, and the second phase a literature review. The objectives for the two phases were:

Phase I

- 1) Assess the magnitude of premature asphalt deterioration on Minnesota timber bridges.
- 2) Identify the primary patterns of asphalt deterioration on Minnesota timber bridges.
- 3) Identify the primary mechanisms responsible for the patterns of wear surface deterioration observed.

Phase II

- 1) Overview of the three categories of cracks occurring in asphalt pavement.

- 2) Identify design characteristics of timber bridges which may produce concentrated stresses in asphalt pavement overlays.
- 3) Explain oil-type wood preservatives interaction with asphalt.
- 4) Suggest methods for improving asphalt pavement performance on timber bridges based on current methods employed against the common forms of cracking.

Phase one and two objectives were met through mailing a survey to the states' county engineers, interviewing several county engineers and touring their timber bridges, meeting with both asphalt and timber bridge industry professionals, and referencing current literature pertaining to timber bridge and asphalt pavement performance. Feedback from the survey indicated that at least 50% of the counties experience some problems with premature reduced serviceability of the asphalt pavement wear surfaces on a portion of their timber bridges.

Possible primary failure mechanisms responsible for causing pavement cracking in timber bridge wear surfaces were identified as:

- 1) Low-temperature cracking, which is the result of thermal contraction stresses exceeding the asphalt tensile strength.
- 2) Reflective cracking, which can occur in timber bridge asphalt pavement overlays as a result of timber deck fault lines found at deck panel joint lines and deck lamination separations.
- 3) Fatigue fracturing or cracking in response to asphalt age, weathering effects and repetitive load stresses.
- 4) Asphalt de-bonding due to wood preservatives softening the asphalt pavement and preventing proper asphalt bond to the timber deck.

Next, several solutions were proposed for controlling timber bridge asphalt pavement cracking including:

1) Pavement Performance

- a) Test the use of the asphalt pavement saw & seal technology to restrict the occurrence of timber bridge wear surface cracks or route & seal to rehabilitate damaged wear surfaces.
- b) Test polymer modified asphalt binders additives or changes in the pavement mix design to increase the flexibility (particularly during the cold season) of the wear surface on timber bridges.
- c) Test the use of the use Sand Anti-Fracture (SAF) hot-mix polymer modified underlay to reduce reflective type cracking on timber bridges.

2) Deck Performance

- a) Test the affect of tightening and shimming the transverse deck stiffener beam in terms of reduced inter-lamination movement and reduced transverse and longitudinal deck deflection.
- b) Determine the regional timber bridge equilibrium moisture content in order to accurately predict the dimensional changes that bridge components will experience after installation, and to more accurately predict bridge component strength in design computations.
- c) Implement a larger number of timber bridge rehabilitation projects with retrofit spreader decks. Doing this will upgrade bridges to changes in roadway geometry and to reduce global deck deflection.

3) Asphalt Surface Adhesion

- a) Implement standard pre-surfacing deck preparation procedures in order to improve asphalt to deck adhesion. These methods should include:
 - i) Blotting off excess creosote

ii) Sweeping and pressure spay washing of decks to remove all loose material

Application of a tack coat if all excess creosote has been adequately removed from the surface.

TABLE OF CONTENTS

CHAPTER-1 INTRODUCTION.....	1
CHAPTER-2 WEAR SURFACE PERFORMANCE SURVEY	3
2.1. OBJECTIVE.....	3
2.2. METHODS	3
2.3. RESULTS	3
2.3.1. <i>Survey</i>	4
2.3.2. <i>Meetings & Bridge Tours</i>	8
2.4. CONCLUSIONS.....	13
CHAPTER-3 LITERATURE REVIEW.....	17
3.1. OBJECTIVES	17
3.2. MECHANISMS PRODUCING ASPHALT PAVEMENT DISTRESS.....	17
3.2.1. <i>Low-Temperature Thermal Induced Pavement Cracking</i>	18
3.2.2. <i>Asphalt Fatigue</i>	20
3.2.3. <i>Reflective Cracking</i>	22
3.3. TIMBER BRIDGE DESIGN AND MECHANICS.....	24
3.3.1. <i>Bridge Structural Design</i>	24
3.3.2. <i>Bridge Deck Fault Lines</i>	28
3.3.3. <i>Wood Moisture Content Variations</i>	30
3.3.4. <i>Wood Preservative Influence on Asphalt Bonding</i>	32
3.4. PROPOSED SOLUTIONS.....	33
3.4.1. <i>Timber Deck Preparation</i>	34
3.4.2. <i>Reflective Cracking Prevention</i>	35
3.4.3. <i>Wear Surface Options</i>	42
3.4.4. <i>Bridge Maintenance and Rehabilitation Practices</i>	44
3.4.5. <i>Timber Deck Rehabilitation</i>	46
CHAPTER-4 CONCLUSION.....	49
4.1. SUMMARY AND RECOMMENDATIONS	49
4.2. RECOMMENDED REFERENCES.....	50
REFERENCES.....	53

LIST OF TABLES

Table 2.1	Survey Results	5
Table 2.2	Asphalt Pavement Distress Pattern and Failure Mechanism	13
Table 3.1	Factors Influencing Low-Temperature Pavement Cracking	19
Table 3.2	Controllable and Non-Controllable Factors	19

LIST OF FIGURES

Figure 2.1	Distribution of Timber Bridge Decks by County	6
Figure 2.2	Transverse Pavement Crack Over Pier Cap Deck Support	9
Figure 2.3	Transverse Pavement Crack Over Abutment Cap Support	9
Figure 2.4	Longitudinal Pavement Crack	11
Figure 2.5	Asphalt Fatigue and Transverse Cracking	11
Figure 2.6	Asphalt Fatigue and De-Bonding Interactions	12
Figure 3.1	Schematic of Thermal Crack Model	21
Figure 3.2	Schematic of Physical Model of Pavement Section	21
Figure 3.3	Modes of Crack Displacement	23
Figure 3.4	Stress Concentrations in Asphalt Overlay Resulting From Induced Movements of Underlying Pavement	23
Figure 3.5	Panelized Longitudinal Nail-Laminated Superstructure	25
Figure 3.6	Beam Bridge with Transverse Laminated Deck	25
Figure 3.7	Simple Span Longitudinally Nail-Laminated Timber Deck	26
Figure 3.8	Illustration of Ship-lap Panel Joint	27
Figure 3.9	Stress-Laminated Superstructure	28
Figure 3.10	Separation of Panels Over Supports	29
Figure 3.11	Lamination Shrinkage Due to Moisture Loss	30
Figure 3.12	Success of Saw and Seal in Minnesota	36
Figure 3.13	Typical Saw and Seal Joint Geometry	37
Figure 3.14	Stress Distribution in the Top of the Asphalt Overlay	39
Figure 3.15	Stress Distribution in the Bottom of the Asphalt Overlay	39
Figure 3.16	Geogrid Reinforcement of Asphalt Pavement Overlay	41
Figure 3.17	Maintenance on Longitudinal Superstructure Timber Bridge Decks	45
Figure 3.18	Deflection Change From Tightening the Transverse Stiffener Beams	46
Figure 3.19	Post-Tensioning Rehabilitation of Longitudinal Superstructure Timber Bridge Decks	48
Figure 3.20	Spreader Deck Rehabilitation of Longitudinal Superstructure Timber Bridge Decks	48

Chapter-1 Introduction

In both the United States and Canada concerns have been expressed in regards to the expected long term serviceability of an asphalt pavement wear surface on timber bridge decks [1,2]. Asphalt overlays are considered effective timber bridge wear surfaces, nonetheless premature pavement distress of these overlays can be a prevalent and even predictable occurrence.

The basic function of the wearing surface on a timber bridge is to provide protection to the timber deck and substructure from vehicle damage, water damage and general exposure to the environment [1]. In additions to these basic functions, a timber bridge wearing surface should also match and maintain the same performance expectations of the adjoining roadways in terms of weight limits, traffic volume and skid resistance. Failure to maintain the integrity of a wear surface may render a timber deck and substructure susceptible to damage and decay.

Surprisingly, wood decay is still the primary cause for reduced performance and subsequent replacement of timber bridges [3], this despite the significant improvements that wood preservatives have offered in extending the timber bridge service life. Fungi may invade timber members through cracks in the wood surface and thrive under optimal moisture conditions. However, when exposure to wetting is properly reduced, timber members can dry to moisture levels below that required to support most fungal growth. In addition to the wood preservative, one of the most effective means of preventing decay and subsequent reduced serviceability of timber bridges is the emplacement of an asphalt wear surface which can provide a moisture barrier for the timber deck and substructure.

In the state of Minnesota, where this study was conducted, there are currently a total of 2108 timber bridges, 1378 which are covered with an asphalt wear surfaces [Minnesota

Department of Transportation, Bridge Management Unit of the Office of Bridges and Structures]. Recent studies have indicated a significant portion of county engineers across the United States have developed a pessimistic attitude toward the performance of timber bridges in their areas [4,5]. Minnesota's counties do not necessarily reflect this opinion, nevertheless with this attitude lingering the hope is that the counties will remain proactive in their approach to routine maintenance on timber bridges to include the wear surfaces. Considering the value of Minnesota's large timber bridge investment, the objective of this report is to adequately assess the reality of maintaining serviceable asphalt wear surfaces on timber bridges, and then provide direction for the state to take in order to ensure the optimal performance of timber bridge wear surfaces.

Chapter-2 Wear Surface Performance Survey

2.1. Objective

- 1) Assess the magnitude of premature asphalt deterioration on Minnesota timber bridges.
- 2) Identify the primary patterns of asphalt deterioration on Minnesota timber bridges.
- 3) Identify the primary mechanisms responsible for the patterns of wear surface deterioration observed.

2.2. Methods

1. Developed a one page survey to gather information about the patterns associated with asphalt wear surface deterioration on timber bridges, and magnitude of wear surface deterioration on timber bridges in Minnesota. Also, conducted follow-up phone interviews with 10% of non-responding counties to verify the results obtained from returned surveys were non-bias.
2. Contacted county engineers in Minnesota and other states for their assistance in defining the timber bridge wear surface problem. Retrieved necessary information from the MN/DOT database. Contacted Wheeler Consolidated and the USDA Forest Products Lab for additional assistance.
3. Visited timber bridge sites to assess asphalt pavement wear surface failure problems.

2.3. Results

The following sections discuss results obtained from a survey of Minnesota county engineers, interviews with private and public sector professionals, and field inspections of timber bridge wear surfaces. Data obtained from the survey of Minnesota county engineers are

summarized in **Table 2.1**.

2.3.1. Survey

The survey provided some interesting results both terms of the engineers' general knowledge of their timber bridge systems and in the reported performance of asphalt pavement on timber bridges.

The counties reported longitudinally nail-laminated (LNL) superstructures accounted for the highest percentage of timber bridges in the state (question 1), transverse nail-laminated (TNL) stringer (beam) superstructures were the second highest, next timber plank decks, then glue laminated (glulam) superstructures, and finally stress-laminated (SL) superstructures. Listed below both the SL and the glulam results in **question 1** are the actual number of SL and glulam bridge types known to be in Minnesota [Minnesota Department of Transportation, Bridge Management Unit of the Office of Bridges and Structures]. Based on the survey results, a reported 119 glulam timber bridges are present in the state, where actual numbers indicate only 1 glulam highway bridge is present in MN. Apparently some counties believe all of the new highway timber bridges installed in their counties are glulam rather than the standard nail-laminated design. This misperceived notion may cause some confusion for the county engineers in terms procedures to be

Table 2.1
Survey Results

1

		Responses			
		%	Raw #	Mean	SD
Surveys Completed		51%	44	NA	NA
1)	Reported timber bridges in Minnesota with the following timber deck types.				
	Longitudinally Nail-Laminated Deck	39%	412	NA	7.8%
	Transversely Nail-Laminated Deck	29%	301	NA	7.2%
	Stress Laminated Deck	1%	7	NA	1.3%
	*Actual number of stress laminated timber bridges in MN.		5	NA	NA
	Glue Laminated Deck	11%	119	NA	5.1%
	* Actual number of glulam timber bridges in MN.		1	NA	NA
	Timber Plank Deck	20%	215	NA	6.5%
2)	Reported timber bridges with asphalt pavement surfaces.	65%	638	NA	8.6%
	** Actual total number of timber bridges with asphalt wear surfaces in MN.	65%	1378	NA	NA
	Number of timber bridges with asphalt pavement accounted for in surveys.	46%		NA	NA
3)	Counties reporting premature failure of asphalt pavement on timber bridges.	50%	20	NA	7.9%
	*** Non-bias verification of reported premature failure.	50%	5		
4)	Counties which actively prevented premature bituminous failure.	6%	1	NA	6.8%
5)	Reported years to failure of asphalt on timber bridges.			4.9	4.8%
6)	Failure rate of asphalt surface based on deck type. (1= low rate, 5 = high rate)				
	Longitudinally Nail-Laminated Deck	NA	NA	2.8	1.6%
	Transversely Nail-Laminated Deck	NA	NA	3.6	1.3%
	Stress Laminated Deck	NA	NA	2.0	1.4%
	Glue Laminated Deck	NA	NA	2.5	0.0%
	Timber Plank Deck	NA	NA	5.0	0.0%
7)	Severity of the following failure types. (1= less sever, 5= more sever)				
	Transverse Cracking	NA	NA	3.4	1.3%
	Alligator Cracking	NA	NA	3.0	1.3%
	Longitude Cracking	NA	NA	2.5	1.4%
	Rutting	NA	NA	1.2	1.0%
	De-bonding from deck	NA	NA	2.8	1.8%
8)	Counties which remove creosote before paving.	14%	5	NA	5.9%
9)	Type of asphalt mix applied to timber decks.				
	Hot-mix asphalt	98%	39	NA	NA
	Cold-mix asphalt	3%	1	NA	NA
10)	Depth of asphalt pavement on timber bridges.				
	Center			3.1	0.7%
	Edge			2.1	0.6%
11)	Type of tack coat sealant applied before paving.				
	CRS-1	39%	14	NA	NA
	CRS-2	25%	9	NA	NA
	Other	14%	5	NA	NA
	None	22%	8	NA	NA
12)	Maintenance performed in the form of tightening transverse stiffener beams.	51%	19	NA	8.2%
13)	Annual maintenance cost per timber bridge.			\$195	\$283

* Information supplied from the Minnesota Department of Transportation Bridge Management Office

** Minnesota DOT bridge inventory listing of timber deck bridges with a asphalt pavement overlay.

*** Results from follow-up interviews with 25% of non-responding counties.

implemented for both bridge maintenance and rehabilitation.

Longitudinally nail-laminated bridges represent the most evenly distributed timber bridge throughout the state (Figure 2.1). Both TNL and timber plank bridges are nearly equal in distribution profile. Again, notice the glulam bridge type is inaccurately represented in this figure and is actually limited to one bridge in one county.

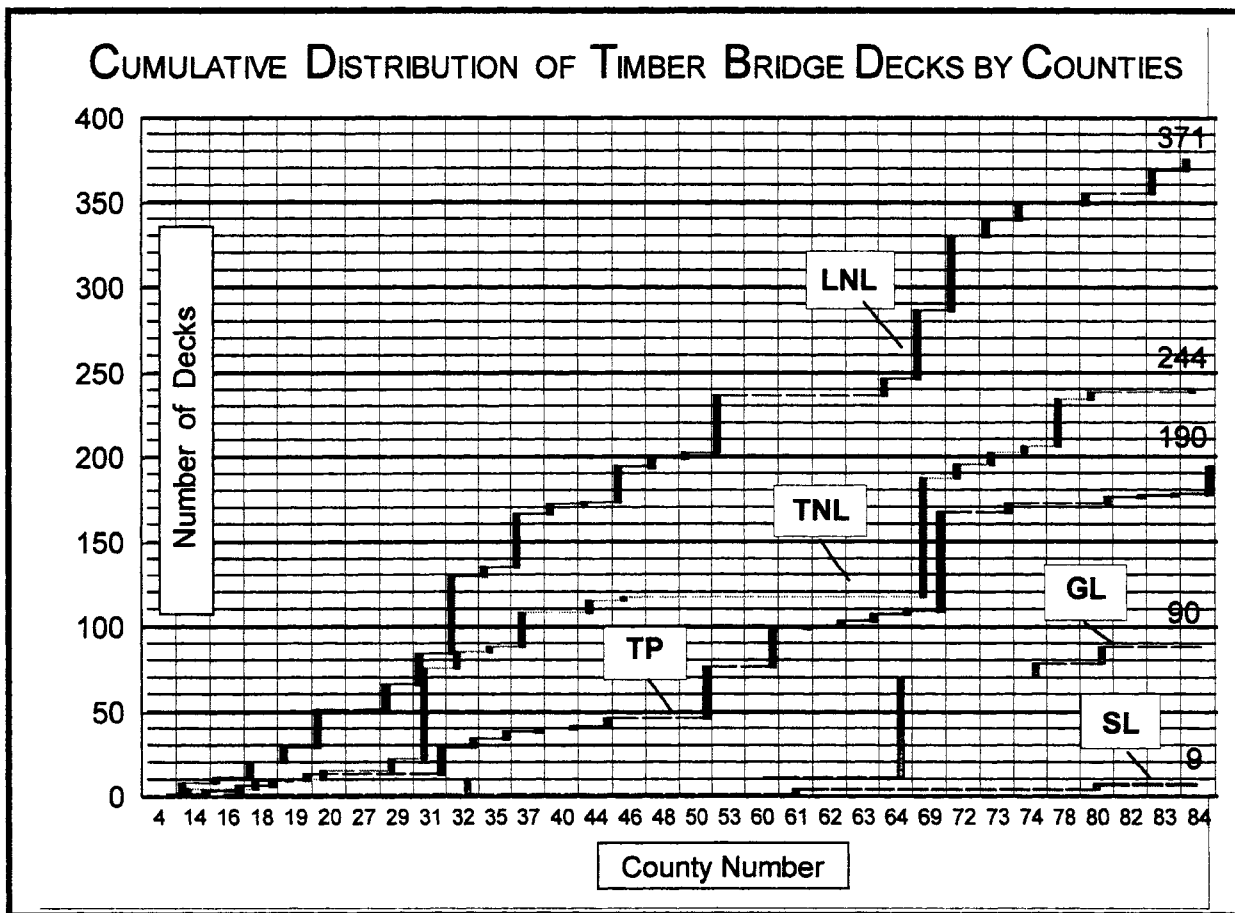

Figure 2.1 Cumulative Distribution of Bridge Decks by County

About two thirds of Minnesota’s timber bridges are covered with asphalt wear surfaces. At least half of the state’s counties report concerns with premature reduced serviceability of these surfaces, but few indicated attempts to apply preventative techniques to circumvent the problem. Minnesota currently has 2108 timber bridges in service, both actual and reported values listed in

question 2 indicate that 65 % of Minnesota's timber bridges have asphalt wear surfaces. At least 50 % of the Minnesota counties report some problems with premature distress of asphalt pavement wear surfaces on their timber bridges (question 3), where as only one county reported actual attempts to prevent premature pavement distress (question 4). The average time span until observed premature wear surface distress occurs was reported to be 4.9 years (question 4), however a high standard deviation of 4.8 years indicates extreme variability in this response. Possible explanations for this variability might involve difference in traffic volume seen on bridges through-out the state and bridge maintenance practices.

Engineers were asked to rate the severity of asphalt wear surface cracking based on deck type. The rating process involved using a rating scale of 1 to 5, 1 being the least problem and 5 the worst problem. According to engineers, SL decks perform the best with a rating of 2.0, however only five of almost 1400 paved bridges are SL. Next in performance were LNL decks, TNL were third, and timber plank bridge decks were reported to be the worst recipients of asphalt pavement with a rating of 5.0 (question 6). Glulam deck performance will not be considered in these results because of the inaccuracy in glulam bridges reported.

Engineers were also asked to rate the severity of pavement crack types using the same rating scale. The transverse crack pattern represented the worst asphalt pavement failure type reported with a rating of 3.4 (question 7). Asphalt de-bonding, "alligator cracking" or asphalt fatigue, and longitudinal cracking were next in severity with scores of 3.0, 2.8 and 2.5 respectively. Asphalt rutting was considered much less of a problem and received a severity rating of 1.2.

Several survey questions reviewed the paving practices counties use for overlaying timber

bridge decks. Extruded creosote was reported as being removed from the bridge deck 14 % of the time prior to asphalt pavement application (question 8). Tack coat sealant is applied to the deck prior to paving 78 % of the time (question 9). Hot-mix asphalt is used in 98 % of the operations (question 10). The average depth of asphalt pavement applied to timber decks is 3.1 inches in the center and sloped to 2.1 inches at the edge (question 11), this matches the recommended pavement geometry for timber bridges put-out by the Minnesota Asphalt Association.

Bridge maintenance in the form of tightening bridge bolts, primarily the transverse stiffener beam bolts, is performed by 51 % of the counties having timber bridges (question 12). The estimated cost of annual bridge maintenance including pavement maintenance is \$195 per bridge with a standard deviation of \$283. Many engineers reported the cost of maintenance was very ambiguous, therefore the reported values may be grossly inaccurate.

2.3.2. Meetings & Bridge Tours

Information collected from timber bridge inspections and interviews with both asphalt and timber bridge industry professionals provided details necessary to identify the primary mechanisms responsible for asphalt deterioration occurring in bridge asphalt wear surfaces. In addition, several solutions for preventing premature asphalt pavement distress were discussed.

During bridge inspections five primary distress patterns were observed in the asphalt pavement wear surfaces covering timber bridge decks: 1) transverse cracking; 2) longitudinal cracking; 3) fatigue or “alligator” cracking; 4) raveling, and 5) asphalt de-bonding. These distress patterns and the contributing factors are discussed in this section.

Pavement distress patterns which appeared to be common among all longitudinal timber bridge decks include transverse cracks directly over all deck supports and longitudinal cracks along the traffic lanes. Transverse pavement cracks commonly align themselves with the center of

bridge pier-cap supports, as seen in this overhead view (Figure 2.2), notice the pier cap support extends past the edge of the bridge deck and the pavement crack has formed nearly on center with the cap. Also, transverse cracks appear at end of the decks over the abutment-cap support (Figure 2.3). An exception to transverse crack

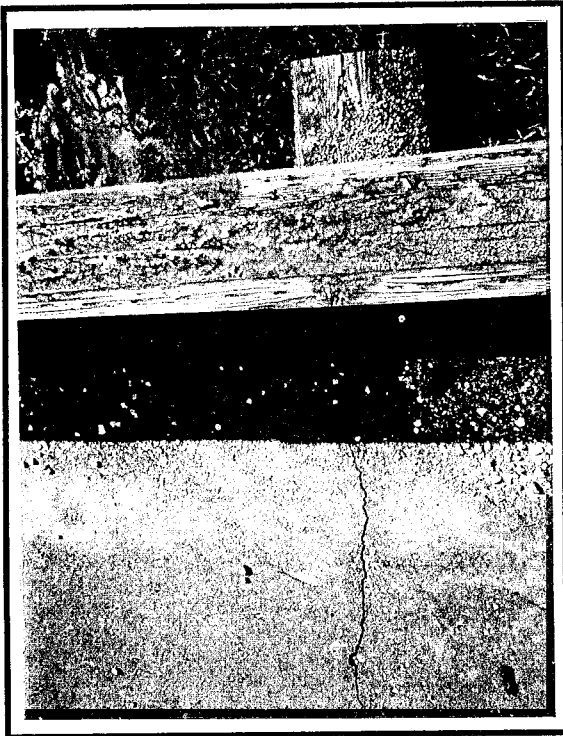

Figure 2.2 Transverse Pavement Crack Over Pier Cap Deck Support

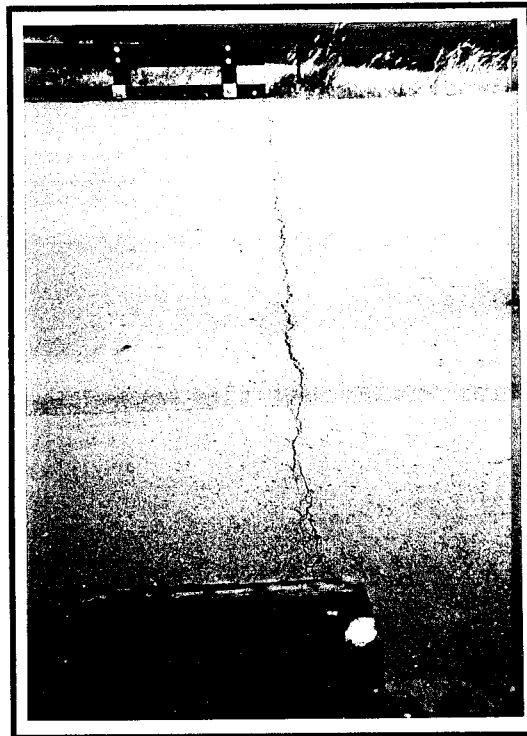

Figure 2.3 Transverse Pavement Crack Over Deck Abutment Cap Support

location of was observed on a rehabilitated LNL bridge with a transverse nail-laminated retro-fit deck, in this instance the transverse cracks were observed half way between the abutment caps and pier caps; in other words at mid-span. Beam (stringer) TNL bridges also had transverse cracks located over the abutment caps and other random transverse cracks across the bridge decks, possibly above deck panel joints. On longitudinal decks, longitudinal pavement cracks were observed both above panel joints and along gaps between the deck laminations, except on the SL

deck (Figure 2.4).

Asphalt fatigue including “alligator” cracking, asphalt de-bonding and pavement raveling was observed in various locations across the timber decks. The worst cases of fatigue seemed to be in proximity to existing transverse and longitudinal pavement cracks (Figure 2.5 and 2.6). While the mechanical nature of the timber deck was determined to be largely responsible for initial transverse and longitudinal pavement crack formation due to independent movement among deck panels and laminations [Ken Johnson, P.E., Wheeler Consolidated, Inc. and Gene Isakson, P.E., Sibley County, MN], the severe pavement distress surrounding these cracks is likely a result of the pavement mix design rather than bridge deck performance. According to Dr. David Newcomb [Associate Professor, Department of Civil Engineering, University of Minnesota], asphalt deterioration is commonly influenced by the presence of excessive pavement voids due to improper pavement mix design or inadequate compaction. Proper asphalt compaction on timber bridge decks is difficult because only small compactors can be used. Excessive percent pavement voids can affect pavement durability through both diminished asphalt adhesion to the aggregates and increased pavement susceptibility to moisture damage. Dr. Newcomb attributes pavement voids to insufficient quantities of asphalt binder presence in the mix and improper pavement compaction. New pavement design specifications incorporate higher quantities of asphalt and higher compaction standards, when these design requirements are followed much of the asphalt fatigue should be effectively reduced. Also the sever cracking observed in **Figure 2.4** may be attributed to poor asphalt adhesion due to inadequate tack coat application on the deck prior to paving (John Isackson, Mn/DOT Road Research). Under conditions of poor adhesion the asphalt may move free from the deck which may allow excessive cracking during deck deflection.



Figure 2.4 Longitudinal Pavement Crack

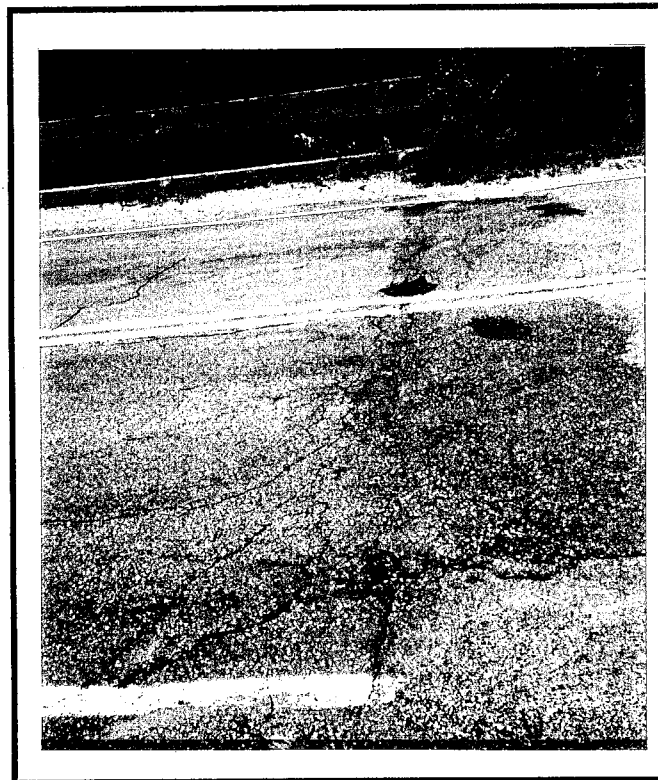

Figure 2.5 Asphalt Fatigue and Transverse Cracking

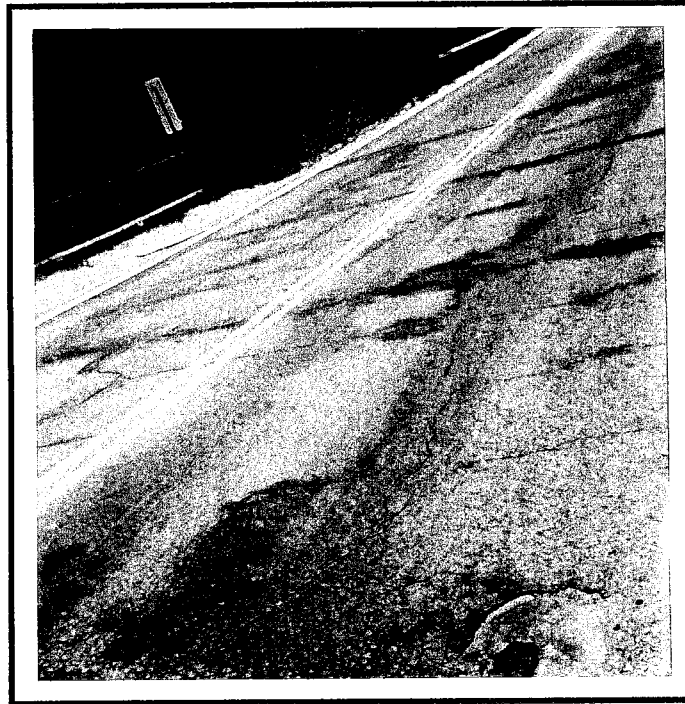

Figure 2.6 Asphalt Fatigue and De-Bonding interactions.

Wood preservatives used to treat timber bridge components were also identified as a possible threat to asphalt pavement performance because they may dissolve asphalt. Creosote, the primary preservative used for treating bridge components, is coal tar distillate derived entirely from the tar produced by the carbonization of bituminous coal [6], and is a solvent of asphalt [Minnesota Asphalt Association and Koch Materials Company]. The only viable alternative, pentachlorophenol an oil-borne preservative, incorporates diesel fuel which is also a solvent of asphalt. After bridge installation these preservatives may extrude out of the timber deck and soften the asphalt pavement overlay. As a result, the asphalt pavement overlays have been observed to easily de-bond from the bridge deck surface.

A list of primary mechanisms inflicting the observed asphalt pavement distress patterns were identified from the previously discussed factors and other information gathered during

interviews. A relationship was drawn between observed crack/distress patterns and the identified mechanisms responsible for pavement failure (Table 2.2).

Distress Pattern	Failure Mechanism
Transverse Cracking	Thermal Stress, Deck Joint Lines, Deck Deflection
Longitudinal Cracking	Load distribution, Deflection, Lamination shrinkage, Deck joint lines
Alligator Cracking	Asphalt mix design, Bridge deflection, Rotting deck timbers
De-bonding	Extruded wood preservatives, Asphalt mix design

Table 2.2 Asphalt Pavement Distress Pattern and Failure Mechanism

2.4. Conclusions

The following are methods suggested for preventing or reducing the occurrence of severe asphalt pavement cracks in timber bridge wear surfaces.

- 1) Stiffen the timber deck by tightening the bolts along the length of the transverse stiffener beam and adding wood shims to take-up space between the deck and the stiffener beam [Gene Isackson, P.E., Sibley County](described further in chapter 3.5d). This practice should help the transverse stiffener beam to better disperse loads laterally across the bridge deck, and therefore decrease both local deck deflection and independent movement between deck lamina. By stiffening the timber deck, asphalt pavement crack initiation and/or propagation may be minimized because the magnitude of stress applied to the pavement at a given location would be reduced. This method is currently being practiced in Sibley County, Minnesota, and is to be tested elsewhere for its effectiveness.
- 2) Asphalt pavement saw & seal crack prevention measure [7]. Asphalt pavement saw & seal involves sawing a stress relief cut in the pavement in order to control the occurrence pavement cracks. If the relief cut function properly, tensile stresses incurred in the pavement will be

dissipated in the relief cut rather than initiating a pavement crack (saw & seal is described further in chapter 3.5b).

- 3) Install an asphalt chip seal or double chip seal rather than asphalt pavement for the wearing surface. The high asphalt content of an asphalt chip seal could provide enough flexibility to withstand the inherent timber deck deformations. Also, a chip seal is easily maintain with additional chip seal layers.
- 4) Install an either an polymer modified asphalt underlay or geotextile underlay to retard pavement cracking. Currently Petrotack ® a geotextile product produced by Amoco Fabrics and Fibers Company is used on timber bridge decks through-out the county to help minimize cracking above deck panel joints, however its effectiveness has not been confirmed in Minnesota's cold climate. Another underlay option, Sand Anti-Fracture Mix (SAF), is a new polymer modified asphalt based underlay material manufactured by Koch Materials Company. Sand anti-fracture mix is designed to help prevent reflective cracking in repave projects, it is currently being tested on several timber bridges and highways in Freeborn County, MN in cooperation with the MN Office of Road Research and Koch Materials Company.
- 5) Remove all excess or extruded wood preservative prior to paving timber decks. Asphalt de-bonding has been associated with the presence of excessive wood preservative on the timber decks. Also, application of an asphalt tack coat in the presence of extruded wood preservative has been suggested to aggravate pavement bonding, therefore consideration may be put into eliminating the tack coat application on new timber decks.

In conclusion, the research direction should be to verify or test these methods for controlling the primary mechanisms responsible for producing premature asphalt pavement distress on timber bridges. Also, based on information both from the survey and from the state's

Bridge Management Office, it is evident that LNL and TNL timber bridges almost exclusively comprise the population of timber bridges having asphalt pavement wear surfaces, therefore these bridge types should receive the majority of attention when considering methods for improving wear surface performance on Minnesota timber bridges.

This page intentionally left blank.

Chapter-3 Literature Review

In the previous chapter observed asphalt distress patterns on timber bridges were related to identified asphalt failure mechanisms (ref. Table 2.2). These failure mechanisms include factors intrinsic to both the pavement design and timber bridge mechanics. This chapter will first review common mechanisms of asphalt distress including low-temperature thermal induced cracking, asphalt fatigue and reflective pavement cracking. Next, timber bridge design and mechanical function will be reviewed to further identify factors influencing wear surface distress. Then, current methods for preventing thermal cracking, asphalt fatigue and reflective cracking will be discussed in terms of bridge mechanics in order to develop a strategy for improving asphalt wear surface performance on timber bridges.

3.1. Objectives

- 1) Overview previously identified mechanisms responsible for producing premature distress in asphalt pavement overlays on timber bridge decks.
- 2) Suggest methods for improving asphalt pavement performance on timber bridges.

3.2. Mechanisms Producing Asphalt Pavement Distress

Asphalt pavement distress on timber bridges includes asphalt cracking, asphalt fatigue, raveling and asphalt de-bonding. Factors which control the initiation and propagation of asphalt pavement cracking are either associated with thermal stresses or loading and/or thermal displacement of the base [8]. Pavement fatigue, on the other hand, is a degenerative response involving bond adhesion failure between the asphalt binder and the pavement aggregates due to environmental factors and/or improper pavement mix design. Also, asphalt pavement on timber

bridges may suffer adverse affects from extruded solvents contained in the creosote or oil-borne wood preservatives used to treat bridge.

3.2.1.Low-Temperature Thermal Induced Pavement Cracking

A thorough review of factors involved in low-temperature cracking lists a variety of variables which may be taken into consideration when addressing this problem [8] (Table 3.1). Notice, these variables can be further broken down into non-controllable and controllable factors (Table 3.2). Referring to the controllable factors listed in **Table 3.2** three distinct categories exist, they are: factors involving asphalt pavement mix design and components; pavement construction characteristics; and base conditions. Even though each of these factors involves a different aspect of asphalt pavement design, they are all ultimately subject to the same mechanism of thermal crack formation.

The basic mechanism of low-temperature asphalt pavement crack initiation and propagation involves a fracture of the pavement when induced tensile stresses exceed the pavement tensile strength (Figure 3.1). The schematic representation of the crack fracture model demonstrates an increase in the magnitude of tension stresses near the pavement surface. Tensile stresses develop in an asphalt matrix as it contracts due to low temperatures. A micro crack will develop in the asphalt surface once induced tensile stress exceeds the strength of the asphalt mixture. Under repeated temperature cycles the crack will propagate and eventually penetrate the full depth of the pavement [9].

Table 3.1
Factors Influencing Low-Temperature Pavement Cracking

[after ref. 8]

1.	Climatic effects
a)	ambient temperature
b)	rate of asphalt cooling
2.	Asphalt binder properties
a)	penetration or viscosity grade
b)	stiffness variations with temperature and rate of loading
3.	Mix design/properties
a)	stiffness variation with temperature and rate of loading and/or mix fracture temperature
b)	coefficient of thermal contraction
c)	tensile strength of the mix
d)	aggregate absorptivity
4.	Pavement Design
a)	sub-grade soil type
b)	base restraint conditions
c)	bituminous layer thickness
5.	Construction Effects
a)	surface flaws
6.	Pavement age and traffic effects
a)	increased stiffness with age
b)	increased fracture temperature under rapid loading conditions

Table 3.2
Controllable and Non-controllable Factors

[after ref. 8]

1.	Controllable Factors
a)	stiffness variation with temperature, a function of the binder
b)	coefficient of thermal contraction, a function of the volume portion of the mix (aggregate)
c)	tensile strength of the mix
d)	aggregate absorptivity
e)	mix or binder modifiers
f)	base restraint conditions
g)	asphalt layer thickness
h)	construction flaws
2.	Non-controllable
a)	Climatic effects
b)	pavement age
c)	traffic effects

Thermally induced stress is greatest in the longitudinal direction due to pavement contraction. The primary pattern of cracking is therefore transverse to the direction of traffic (Figure 3.2). However, if transverse crack spacing is less than the road width then longitudinal cracks may also appear in response to stress being greatest in the transverse direction.

3.2.2. Asphalt Fatigue

Asphalt fatigue describes the effect of environmental degradation and repetitive loading across the asphalt surface. By definition asphalt pavement is a flexible system. However, rapid loading, excessive pavement flexure and high percent pavement voids may eventually allow an asphalt pavement to go into fatigue failure.

The percent voids in a pavement is a design factor which often contributes to asphalt fatigue because the presence of voids in asphalt pavement indicates that the aggregates are not completely covered with asphalt binder. Under stress from loading and freeze/thaw cycles the asphalt binder matrix may reach exhaustion and lose proper adhesion to the pavement aggregate or cohesion with itself due to the presence of voids. Also, asphalt will tend to lose some of its rheological attributes due to aging and weather conditions thereby making it increasingly more susceptible to fatigue response [13]. The fatigue response of asphalt pavement can therefore be greatly affected by both the pavement mix design and the allowed flexure or deflection in the system.

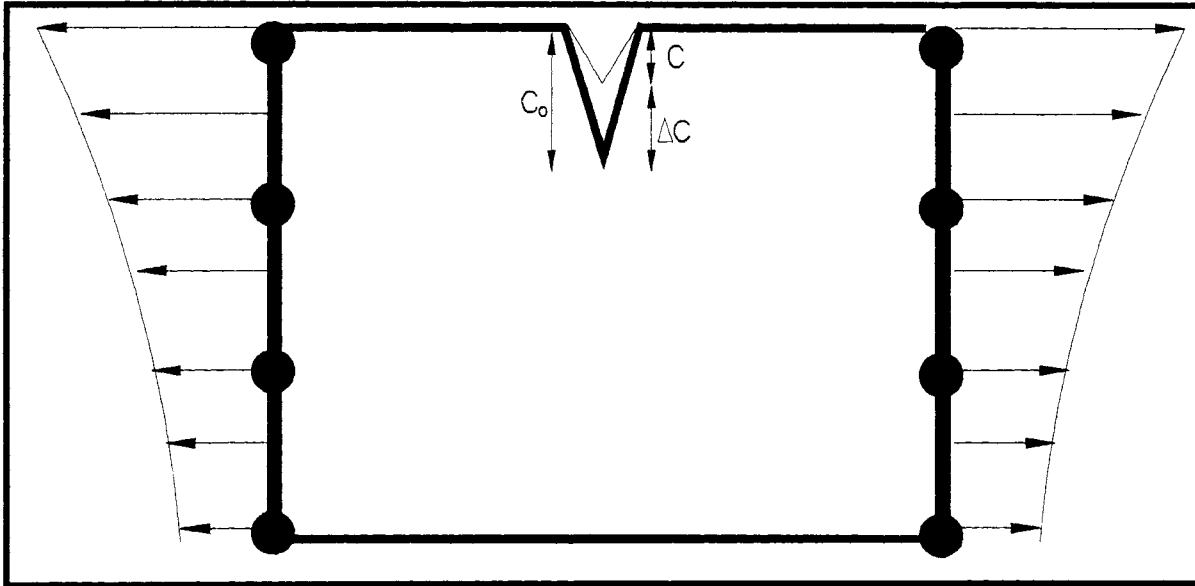

Figure 3.1 Schematic of Thermal Crack Model

[after ref. 34]

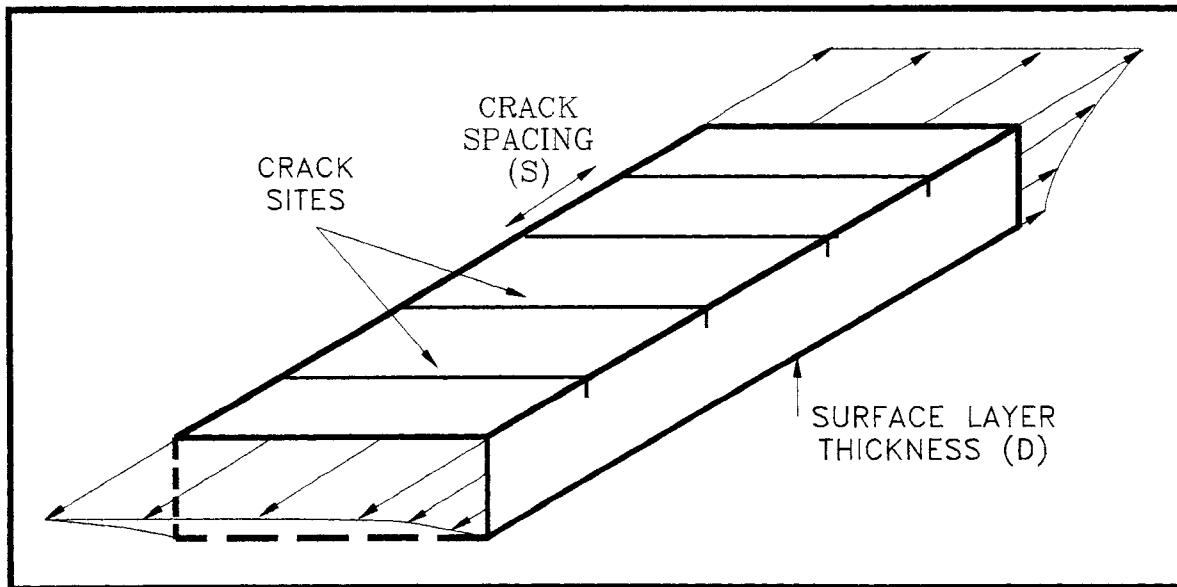

Figure 3.2 Schematic of Physical Model of Pavement Section

[after ref. 34]

3.2.3. Reflective Cracking

Formation and propagation of asphalt cracks by base displacement around a crack or discontinuity in the base is referred to as reflective cracking [9]. Unlike thermal cracks, which begin at the asphalt surface and propagate downward, reflective cracks begin at the bottom of the asphalt overlay and progress upward toward the surface. The cause of reflective cracks are directly related to the type of displacement induced. There are three basic modes of displacement which occur, they are: Mode I - normal tension from thermally induced stresses or strains; Mode II- normal shear from thermally induced displacements of the base or heavy loading; and Mode III- parallel shear from lateral displacement (Figure 3.3). Base displacement could also involve a combination these modes. The presence of cracks or discontinuities in the pavement base allow for of base displacement which can result in a concentration of stresses in the pavement overlay and eventual initiation of a crack (Figure 3.4).

The authors believe that timber decks experience modes of base displacement similar to those seen **Figure 3.3**. Therefore, an asphalt wear surfaces covering a timber deck may also experience reflective cracking. The following discussion on “Timber Bridge Design and Mechanics” presents this argument.

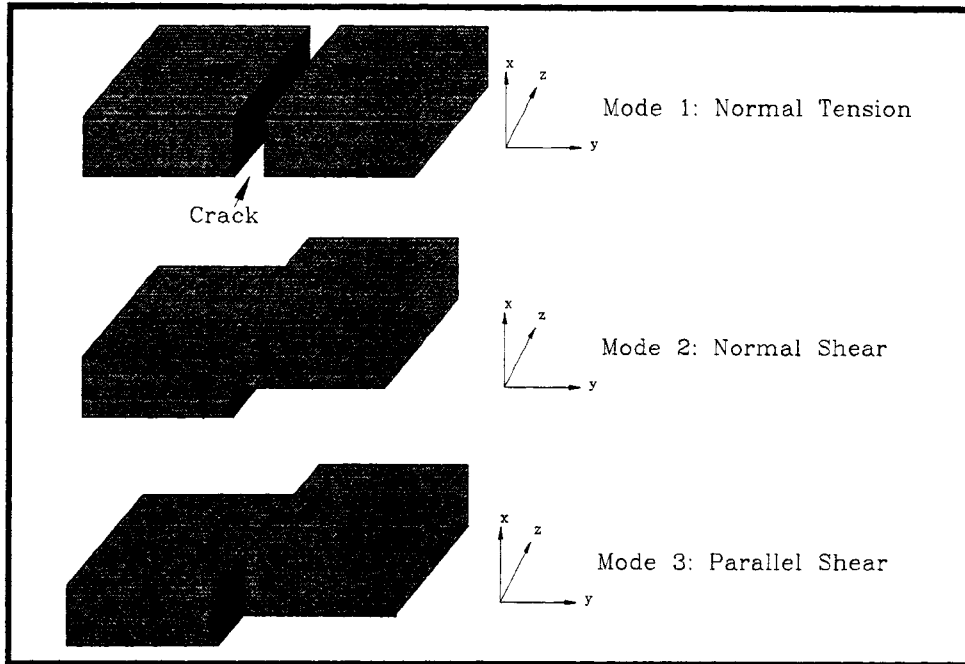

Figure 3.3 Modes of Crack Displacement

[after ref. 9]

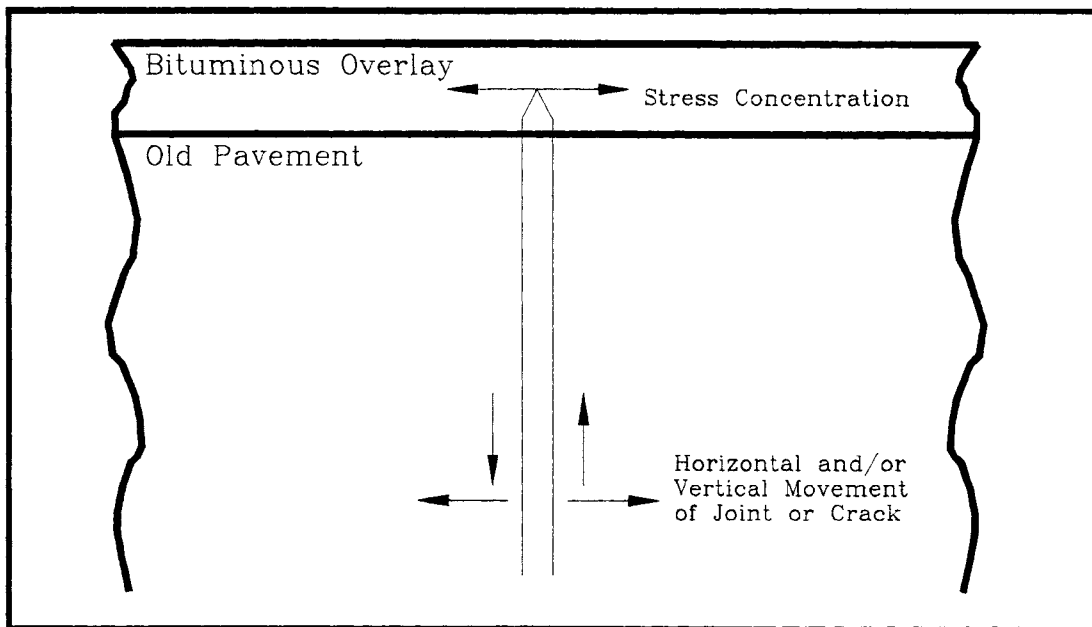

Figure 3.4 Stress Concentrations in Asphalt Overlay Resulting from Induced Movements of Underlying Pavement

[after ref. 7]

3.3. Timber Bridge Design and Mechanics

This review of timber bridge design and mechanical functions to provide a basic understanding of timber bridge performance in relation to asphalt wear surface distress by addressing: 1) Bridge structural design and mechanical attributes; 2) Moisture influence on timber dimension; and 3) Wood preservatives effects on asphalt distress. Using this information we can then properly incorporate current practices of asphalt crack prevention into timber bridge paving methods.

3.3.1. Bridge Structural Design

The two most common timber bridge types employed in Minnesota are longitudinal deck superstructures (or slab span bridges) (Figure 3.5), and beam superstructures (or stringer bridges) with transverse laminated decks (Figure 3.6). Both longitudinal and transverse timber deck are constructed from lumber fastened together using either nails, stressing rods or glue. Nail and stress laminated timber decks may be completely constructed in the field, or ship to the bridge site as prefabricated panels.

Longitudinally nail-laminated (LNL) decks and transverse nail-laminated decks (TNL) consist of planks (laminations) standing on edge and laminated together with long rink-shank nails (or dowels) following a standard nailing pattern. Longitudinal nail-laminated decks fabricated at the bridge site can be identified by the deck lamination layout, notice every tenth lamination extends across the pier cap supports (Figure 3.7), in contrast to prefabricated panelized decks which have no laminations extending across the pier cap supports (ref. Figure 3.5). Nail-laminated decks fabricated in the field, both LNL and TNL, are construction by nailing lamination to one another across the entire width or length of the deck.

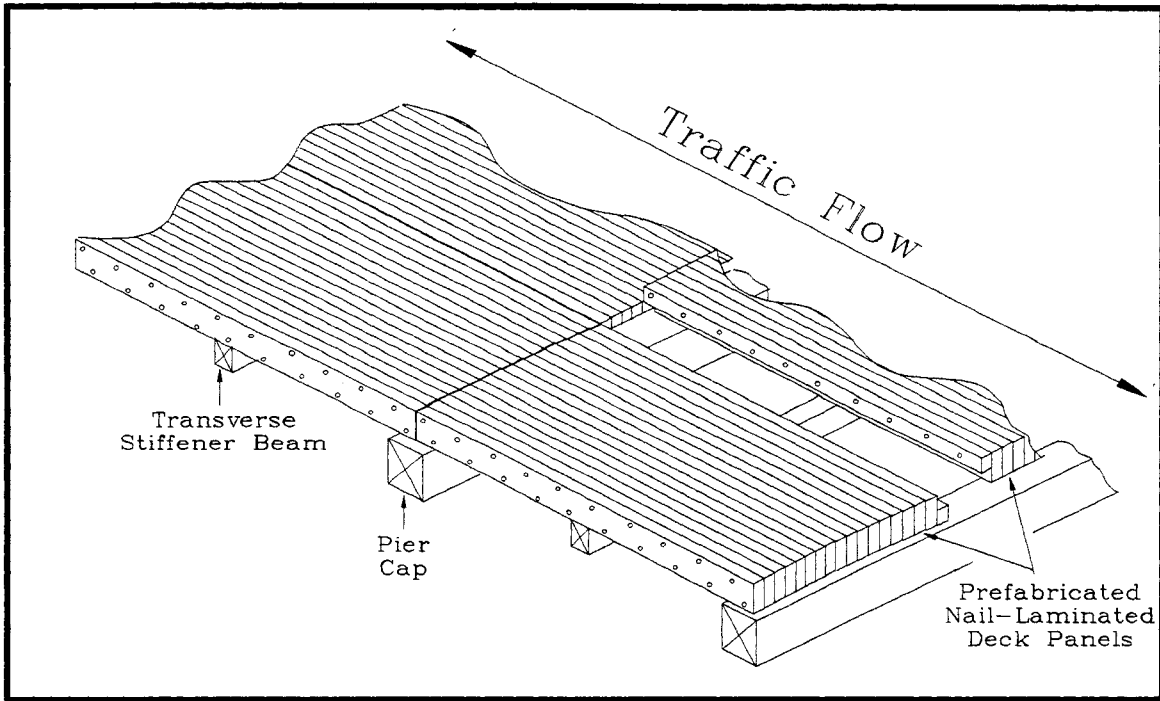

Figure 3.5 Panelized Longitudinal Nail-Laminated Superstructure
(Cut-Away Representation)

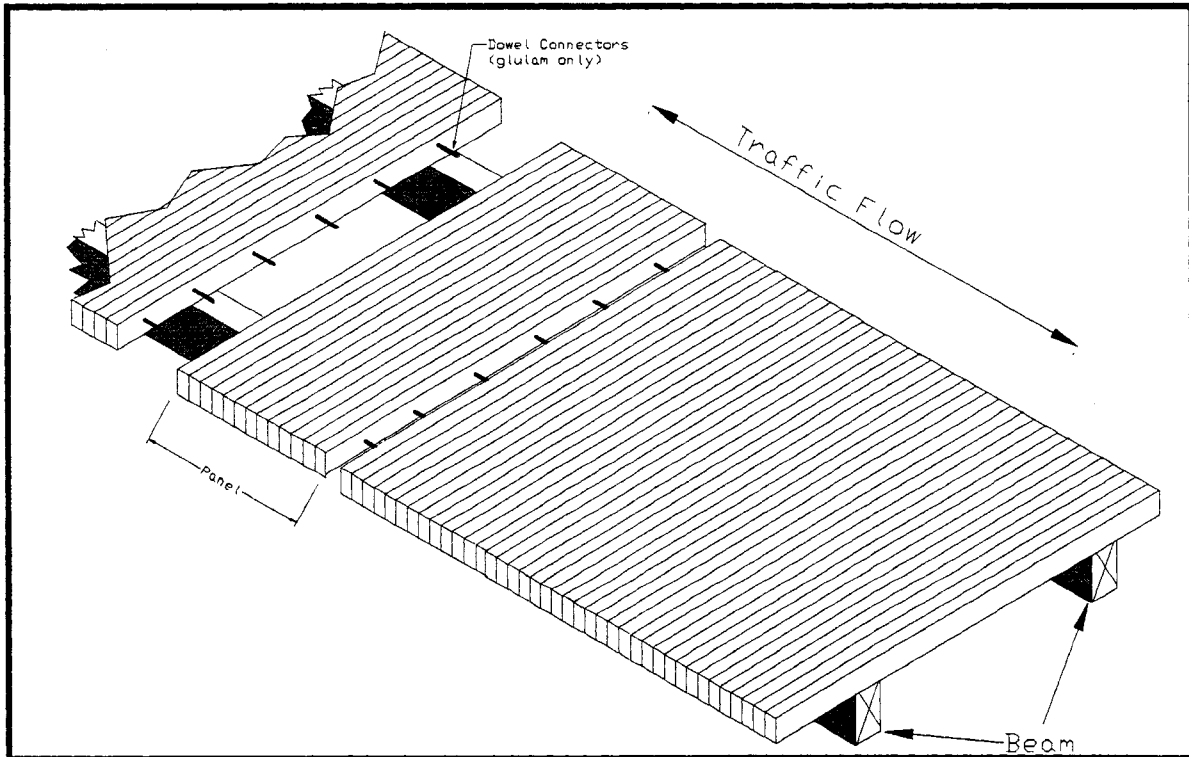

Figure 3.6 Beam Bridge with Transverse Laminated Deck

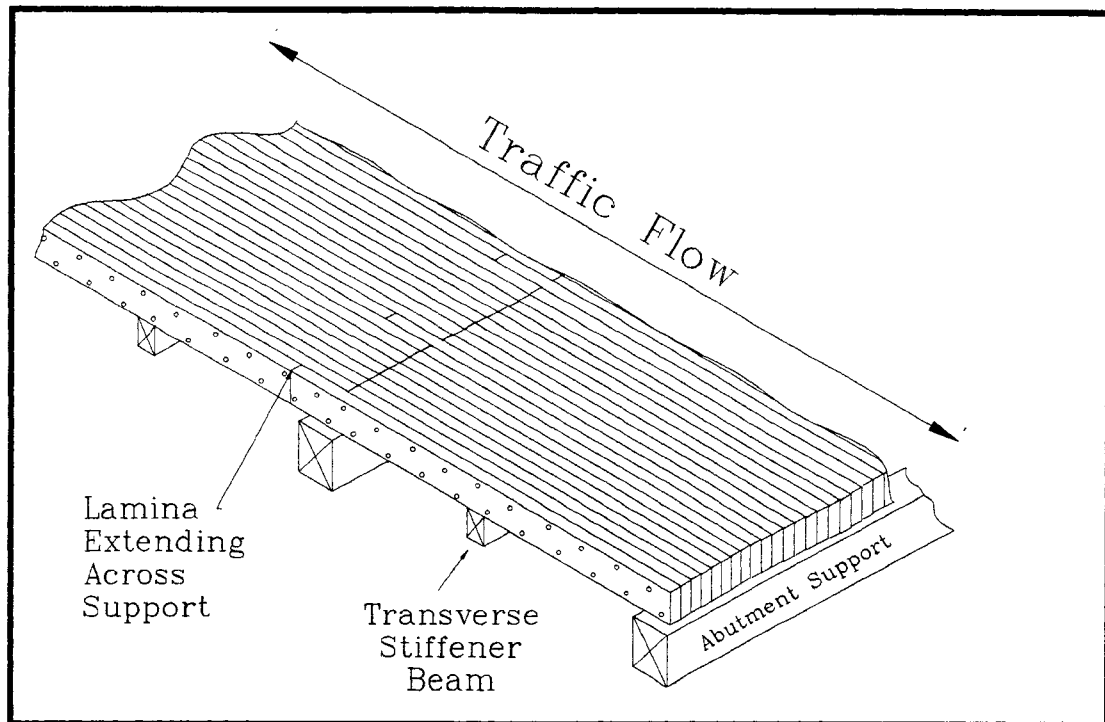

Figure 3.7 Simple Span Longitude Nail-Laminated Timber Deck
(Cut-Away Representation)

Panelized decks, on the other hand, are prefabricated into a series of panels of less than 7' 6" in width by pressing dowels into pre-drilled holes. Panelized decks are connected by means of a ship-lap joint and nails (Figure 3.9)[14]. In general, nail-laminated decks constructed prior to 1970 were filed laminated decks, after that time they were primarily prefabricated panelized decks [15].

Stress-laminated decks may be constructed as either prefabricated panels, or as field assembled continuous systems. The stress-laminated system involves passing a threaded stressing rod through the laminations across the width of the bridge or panel, then tightening nuts onto the threaded rod thereby applying a compressive force to the laminations (Figure 3.8). Continuous stress-laminated bridge decks covering multiple spans incorporate butt-joints in order to extend the deck across the entire bridge length without incorporating a transverse joint over the supports.

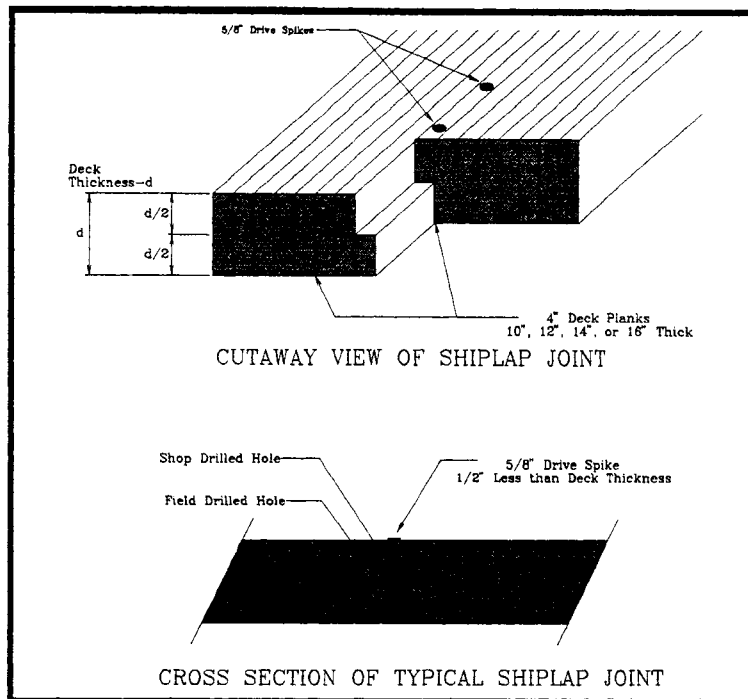

Figure 3.8 Illustration of Ship-lap Panel Joint

[after ref. 21]

With minimum spacing requirements friction between laminations is sufficient to prevent movement between the lamination [1].

Glue laminated (glulam) decks are only produced as prefabricated panels. Glulam deck laminations are permanently fastened together with glue to form panels $3\frac{1}{2}$ ft to $4\frac{1}{2}$ ft wide. Transverse glulam panels may be connected with dowels to increase the load transfer capacity between the panels (ref. Figure 3.6). Longitudinal glulam deck panels are assembled together in similar fashion as nail-laminated panels except ship-lap joints are not always utilized to connect the panels.

Both LNL and longitudinal glulam bridges are fitted with a transverse stiffener beams to increase the lateral load transfer capability between laminations and panels. Transverse stiffener

beams are bolted to the underside of the deck at mid-span locations (ref. Figure 3.5, 3.7). Proper

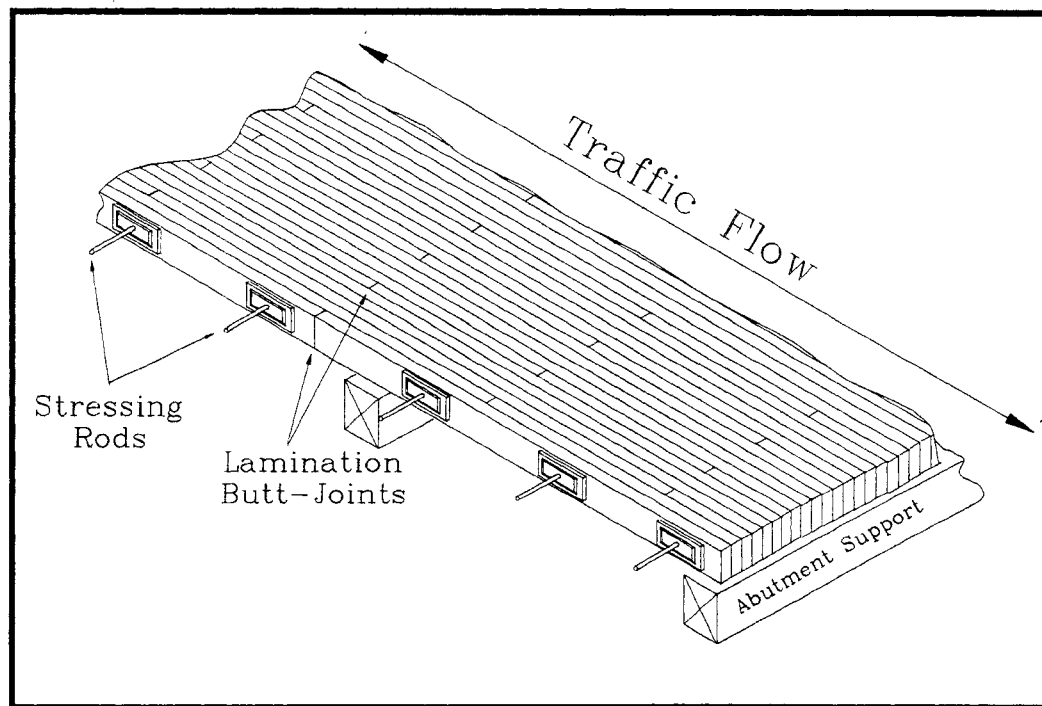

Figure 3.9 Stress-Laminated Superstructure
(Cut-Away Representation)

function of the transverse stiffener beam requires secure fastening to the deck, a loose stiffener beam simply becomes dead load rather than a load transfer mechanism.

3.3.2. Bridge Deck Fault Lines

The term fault lines will be used to describe inherent mechanical functions of timber decks which allow for variable movement between deck components. Fault lines may exist in timber decks due to inadequate load transfer between deck members. Location of fault lines will vary based on the deck design, lamination fastening mechanism and from changes in deck lamina dimension due to moisture content (MC) variation. Transverse fault lines are built-in to most every longitudinal slab-span bridge due to the panelized system lay-outs and/or concentrations of load induced stress over the abutment and pier deck supports. Fault lines may also occur parallel to the traffic direction due to insufficient load transfer between longitudinal panel joints and individual

panel lamina.

Transverse fault lines in multi-span longitudinal decks exist along panel butt-joints located over the pier-cap supports (ref. Figure 3.5, 3.7). As a vehicle load moves across a bridge the incurred deck deflection may cause both an upward movement and a panel separation along the transverse panel joints. For illustration purposes, the depiction of a longitudinal deck demonstrates an over exaggeration of movement over the deck supports (Figure 3.10). The assumed mode of crack displacement along the transverse fault lines would therefore be a combination of displacement mode 1 (normal tension) and mode 2 (normal shear) (ref. Figure 3.3).

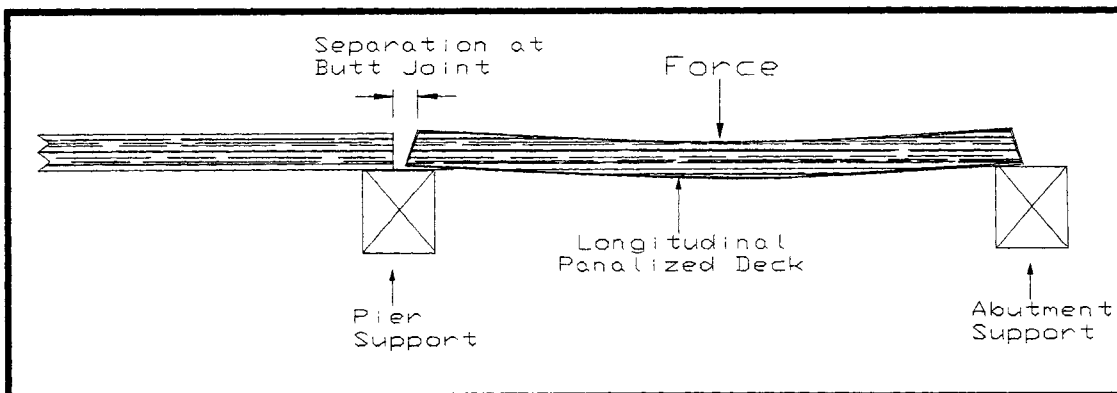

Figure 3.10 Separation of Panels Over Supports

Depending upon the bridge system employed, various transverse and/or longitudinal fault lines may also develop when there is a lack of adequate load sharing present between laminations and panel connections. For example, a nail-laminated bridge decks may tend to lose some of its' ability to distribute loads as a result of fiber crushing by the dowel connectors [15] and loosening of the transverse stiffener beam, and as stress-laminated decks may also drop in load distribution from a loss of compression stress based on temperature and moisture variations [16]. In either case, fewer members support the wheel loads, thus the magnitude of the live load becomes more

concentrated along given laminations.

3.3.3. Wood Moisture Content Variations

Timber laminations may experience dimensional changes after installation due to in-service MC changes. Nail-laminated and stress-laminated deck systems are generally installed at a high MC and will tend to lose moisture after installation. Glulam systems are installed at a low MC and will tend to gain moisture over time. In either case, the wood will swell or shrink with gains or losses in moisture. Decreased dimensional sizes may adversely affect both stress-laminated and nail-laminated decks because shrinkage reduces friction between laminations which results in a decrease load transfer efficiency (Figure 3.11), notice the space between any two lamination created from lamination shrinkage. These MC changes may in turn create longitudinal fault lines in-between laminations.

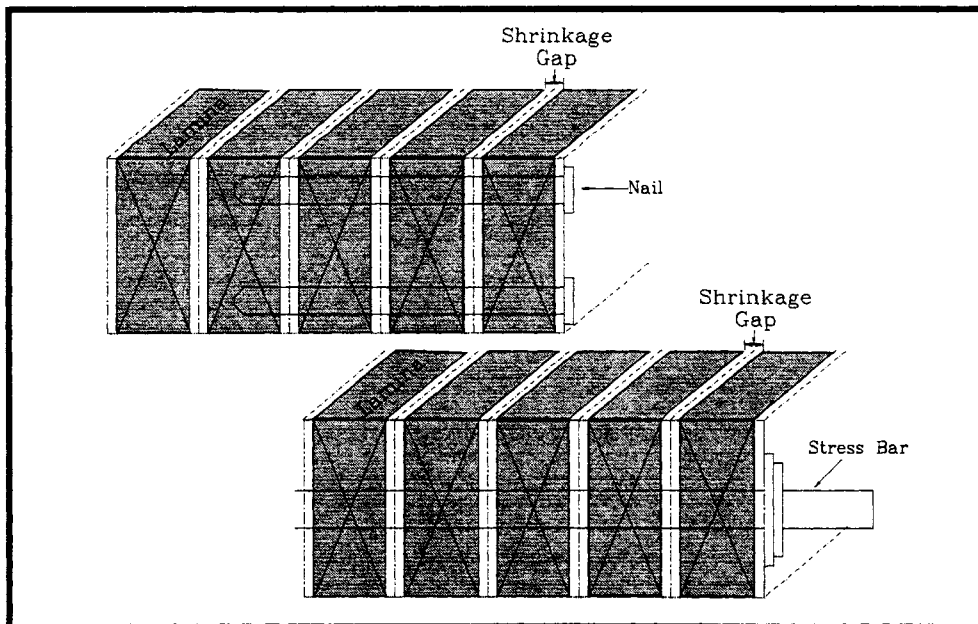

Figure 3.11 Lamination Shrinkage Due to Moisture Loss

Below the fiber saturation point (approximately 30 % MC), wood change dimensionally

with variations in the amount of moisture in the wood fiber (cell) walls. Wood is an anisotropic material with respect to shrinkage, which means it experiences the greatest shrinkage in the direction tangent to annual rings, about half as much perpendicular to the annual ring, and only slightly along the grain [17]. Both direct contact with water and changes in relative humidity will cause fluctuations in wood MC.

Under constant conditions wood will reach and maintain an equilibrium moisture content (EMC). The EMC of laminated timber decks may vary greatly, anywhere from 12% to above 30% [25] depending upon location in the country and in service conditions. The initial MC of nail-laminated and stress-laminated deck systems after installation is generally between 25% and 30% MC [10,26], and EMC for northern climate bridge decks is approximately 15% to 20% [18,19,20].

The maximum expected shrinkage can be obtained based on known shrinkage values, the regional EMC and the anticipated Δ MC. For example, radial and tangential shrinkage values for coastal Douglas-Fir (*Pseudotsuga menziesii*) are 4.8% and 7.6% respectively for a Δ MC of 30% to oven-dry (0%) [17]. The following equation can be used to determine the percent shrinkage expected:

$$S_m = S_o \frac{m_o - m}{30}$$

Where S_m is shrinkage in percent from m_o moisture content to the moisture content m , S_o is the total shrinkage percent.

Based on the above equation and expected Δ MC, longitudinal decks may shrink from 1.9% to 3.0% due to loss of, or from $\frac{1}{4}$ to $\frac{3}{8}$ inch per foot transversely (ref. Figure 3.11).

Because post installation shrinkage in stress-laminated decks decreases the actual width of a longitudinal deck, additional stressing is required after installation in order to maintain the

required compression. Nail-laminated decks can also be affected by shrinkage, the effects will be more localized but less correctable. In either case, depending upon the deck lamination orientation, longitudinal or transverse “fault lines” may form between laminations as a result decrease load transfer efficiency due to shrinkage.

3.3.4. Wood Preservative Influence on Asphalt Bonding

As mentioned in the previous chapter, components of the wood preservatives used to treat timber bridges are solvents of asphalt. The presence of excessive creosote or oil-borne wood preservative on the surface of timber decks has been suggested to soften asphalt pavement and inhibit proper bonding to the deck. Improper asphalt bonding can result in a overlay which is easily dislodged by lateral forces [21].

After installation wood preservative may bleed out of the deck laminations forming a layer on the deck surface. Despite steps are taken to eliminate excess or free preservative from the wood during the treating process displacement of retained preservative may still occur as a result of temperature, moisture changes and percent preservative retention.

The treatment process used for treating timber bridge components is called the empty cell process. In this process preservatives are forced into the wood by pressure. Upon completion of treatment, the bulk of the preservative is forced back out of the wood from positive pressure inside the wood, left behind is a film of preservative lining the wood fiber walls. Excess preservative is further extracted by means of vacuum pressure and post-treatment steam cleaning. Despite these efforts to remove excessive preservative from the timbers, a varying amount of preservative remains in the wood fibers beyond what is required to line the fiber walls.

After installation, the wood preservative may bleed out of the timbers if the retention level is too high. The amount of heat applied to the timber deck from direct solar radiation is a

determining factor in the observed bleeding. During periods of hot days and cool nights, the air inside the wood expands due to adsorption of heat by the dark treated wood or paved surface. Then, in the evening the air internal to the wood contracts and draws in humid air. Finally, during the day as the air internal to the wood expands it pushes air and condensed water out of the cells. This constant in-and-out pumping action will cause excess preservative to be extruded out of the wood if the surface retention level is too high [22]. As a result large amounts of wood preservative may come into contact with the asphalt wear surface.

3.4. Proposed Solutions

Based on current practices, a multiple step approach may be considered for improving the performance of asphalt pavement on timber bridge decks by systematically addressing the following; asphalt bonding, reflective cracking, thermal cracking and asphalt fatigue. First, a change bridge surfacing practices should be implemented to eliminate excess wood preservative from the timber deck in order to improve asphalt bonding. Next, deck panel joint lines should be addressed as probable locations for reflective cracks. Through the use of relief cuts and asphalt underlay materials the adverse effects of reflective cracking may be eliminated. In addition, the wear surface design could be improved by altering the asphalt binder or mix properties in order to decrease low-temperature stiffness and to increase weathering performance. Alternatively, the wear surface could be changed to a flexible asphalt chip-seal surface rather than asphalt pavement. Finally, improvement of timber bridge mechanical performance might minimize asphalt fatigue over regions of the deck which experiences large deflection deformations, and decrease the occurrence of fault line cracks. Each of these proposed solutions are discussed in the following sections.

3.4.1. Timber Deck Preparation

Several basic preparation procedures need to be performed prior to paving a timber deck, if followed these steps should greatly improve asphalt to deck adhesion.

- 1) Extruded creosote or oil preservative on the deck surface should be removed by means of a blotting agent prior to paving. As mentioned, volatile organic components of the preservative can react with asphalt binders thereby softening the asphalt and inhibiting proper asphalt bonding. The presence of extruded creosote is common on many new timber decks and some existing decks that have had the old wear surface removed. Excess or extruded preservative can be removed from the deck by applying a fine material to the deck to work as a absorption or blotting agent [21]. By this method a mixture of dust and 10-20 percent crushed material passing the No. 8 sieve can be spread on a timber deck at a rate of 10-15 pounds per square yard, and rolled with a rubber tire roller. The blotting material is left in place for 1 week or until the preservatives fully absorbed. The deck is then swept of all loose material. The bridge deck may also be allowed to remain exposed for a week or more to permit evaporation of the volatile components. Disposal of this material may pose a problem and therefore should be investigated prior to application.
- 2) After the timber deck is swept it should then be washed with a pressure sprayer to remove all loose material. This is especially important on nail-laminated timber decks where the uneven deck surface can trap loose material in crevasses along laminations and at the deck edge under drainage openings.
- 3) Finally, an evenly spread tack coat should be applied prior to paving except if extruded creosote continues to be a problem. Application of a tack coat in the presence of excess creosote may aggravate asphalt adhesion, additional applications of blotting agent should be considered prior to paving.

3.4.2. Reflective Cracking Prevention

As discussed earlier, reflective cracking occurs in asphalt pavement overlays as a result of thermal or loading displacement of the original pavement. Fault lines, or sites on timber decks where panels are joined, ends of deck panels and separation of laminations could all logically be susceptible to similar type displacement as observed in cracked pavement. Therefore, the same corrective action used to combat reflective cracking in highways may also provide relief from asphalt cracking observed on timber bridges. Two approaches for reducing reflective cracking have demonstrated success in highway asphalt overlays and therefore may help prevent pavement cracking on timber bridges. The first, asphalt saw and seal provides a “control joint” which can expand and contract in order to compensate for induced stress in the pavement during base or deck displacement. The second, underlay or inlay materials work to reduce the magnitude of force applied to the pavement from base displacement by retarding the induced stress.

3.4.2.1. Saw & Seal Joints

Sawing and sealing joints in asphalt pavement is a crack prevention method which has proven to be a highly effective means of reducing reflective cracking on Minnesota highways. With success being defined as forcing 75% or more of the cracks to occur at the sawed joints, sawing and sealing has produced a 76% success rate (Figures 3.12) [7]. This method could be used to provide relief in timber bridge wear surfaces where well defined cracks often occur, primarily over bridge abutment and pier caps where transverse cracks develop (ref. Figures 2.3 and 2.4). Asphalt pavement saw and seal should not be confused with routing and sealing, a remedial crack treatment technique used to repair existing pavement cracks.

The saw and seal joint consists of a transverse cut in the pavement across the pavement directly above observed cracks in the existing base, or 9-12m (30-40 ft) apart in pavement over a new base. The transverse cut includes a shallow reservoir cut and a deep relief cut (Figure 3.13).

The reservoir cut holds the sealant used to protect the opening, while the relief cut ensures a defined point of weakness in the pavement.

Factors which are observed to affect the success rate of sawing and sealing joints include:

1) the type of surface to be overlaid; 2) placement of the saw joint in relation to existing cracks in the original surface; 3) geometry of the saw joint; 4) sealant adhesion ; and 5) sealant elasticity. A complete outline of these details exists in reference [7].

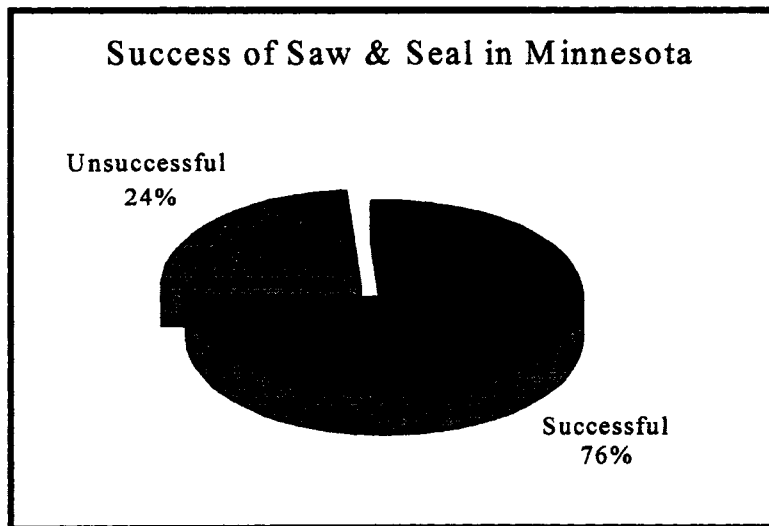

Figure 3.12 Success of Saw and Seal in Minnesota

[after ref. 7]

A proper performing saw and seal joints could presumably provide a benefit to a timber bridge by providing a more uniform and stable driving surface, a better performing water barrier for protection of the bridge components and reducing the bridge maintenance costs. These joints would seem to be most useful if applied to locations above the abutment and pier caps, meaning directly over the transverse panel joints and panel ends. Placement of saw and seal joints in these locations would allow tension and shear forces to be dissipated through the joint, and thus maintain the integrity of the asphalt surrounding the joint.

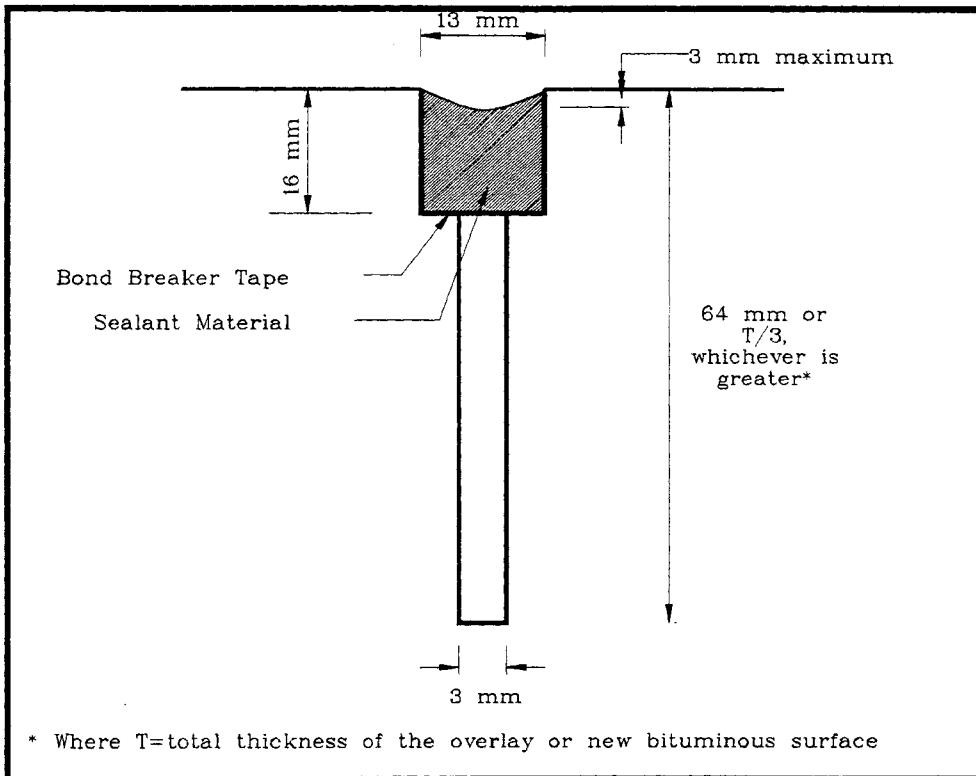

Figure 3.13 Typical Saw and Seal Joint Geometry

[after ref. 7]

Further tests should be performed to evaluate and optimize the use of saw and seal joints on timber bridges. Evaluations of this technique should take into consideration joint geometry (both width and depth of cut), and sealant performance under tensile and shear forces. (i.e. sealant adhesion and elasticity).

Another practice often confused with saw and seal is “route and seal” crack maintenance, a commonly used method for maintaining asphalt pavement integrity. Asphalt route and seal may be an effective means of preventing further degradation of a pavement crack. While the practice of installing a route and seal joint is different than a saw and seal joint, the end result is similar. The existing crack and routed out reservoir produce a similar type profile as seen with a saw and seal joint, the crack represents the relief cut and the routed reservoir represents the saw reservoir

cut (ref. Figure 3.13). The saw and seal cut will provide better initial protection for the asphalt pavement and should be installed only immediately after paving, the route and seal joints are good for remedial pavement treatment and should be installed as needed.

3.4.2.2. Asphalt Underlay Material

As shown in **Figures 3.3 and 3.4**, a stress concentration exists around the crack front because of the existing crack in the underlying pavement. The noticeable difference between two extreme boundary conditions indicates that the stress concentration can be reduced significantly by preventing movement of the underlying pavement (Figures 3.14, 3.15)[9]. These results indicate a significant reduction in induced thermal stress in the immediate area surrounding a pavement crack when base movement is restricted. Therefore, reflective pavement cracking could logically be prevented by either preventing movement of pavement base, or by reducing the magnitude of the stress applied to the pavement. When addressing timber bridges, we might think of stiffening the bridge deck as a means of preventing base movement, and likewise adding a pavement underlay material might reduce the stress applied to the pavement.

Reinforcement of asphalt pavement with geotextile/geogrid fabrics, membranes and polymer modified asphalt inlays is one method which has been implemented for reducing the stress transferred to the pavement from base movement. Each of these methods have shown positive results in reducing the potential for reflective cracking [9,23,24,25]. Placement of a asphalt underlay or inlay reinforcement material at the interface between the existing pavement and the overlay can restrict the movement of the overlay and thus reduce the induced stress. One study demonstrated a reduction of thermal stress by approximately 15 to 20 percent when a geogrid reinforcement material was placed at the interface (Figure 3.16).

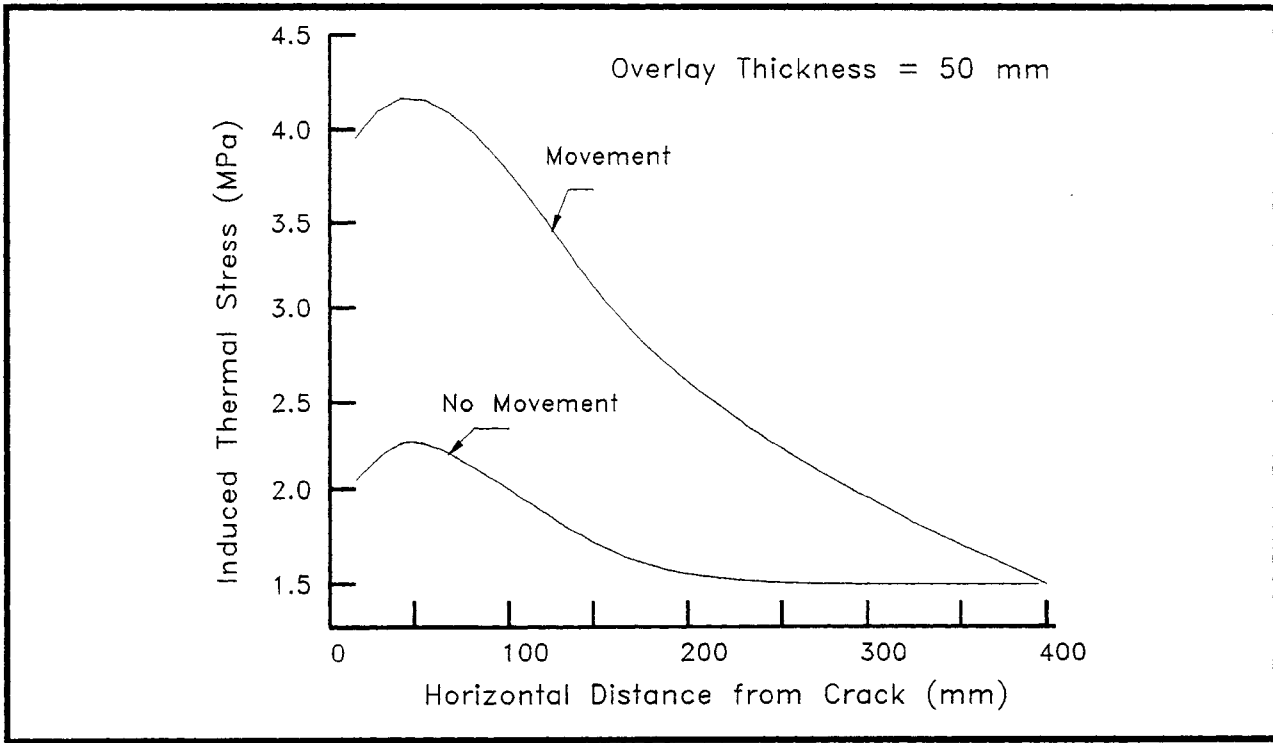

Figure 3.14 Stress Distribution in the Top of the Asphalt Overlay for Different Conditions [after ref. 9]

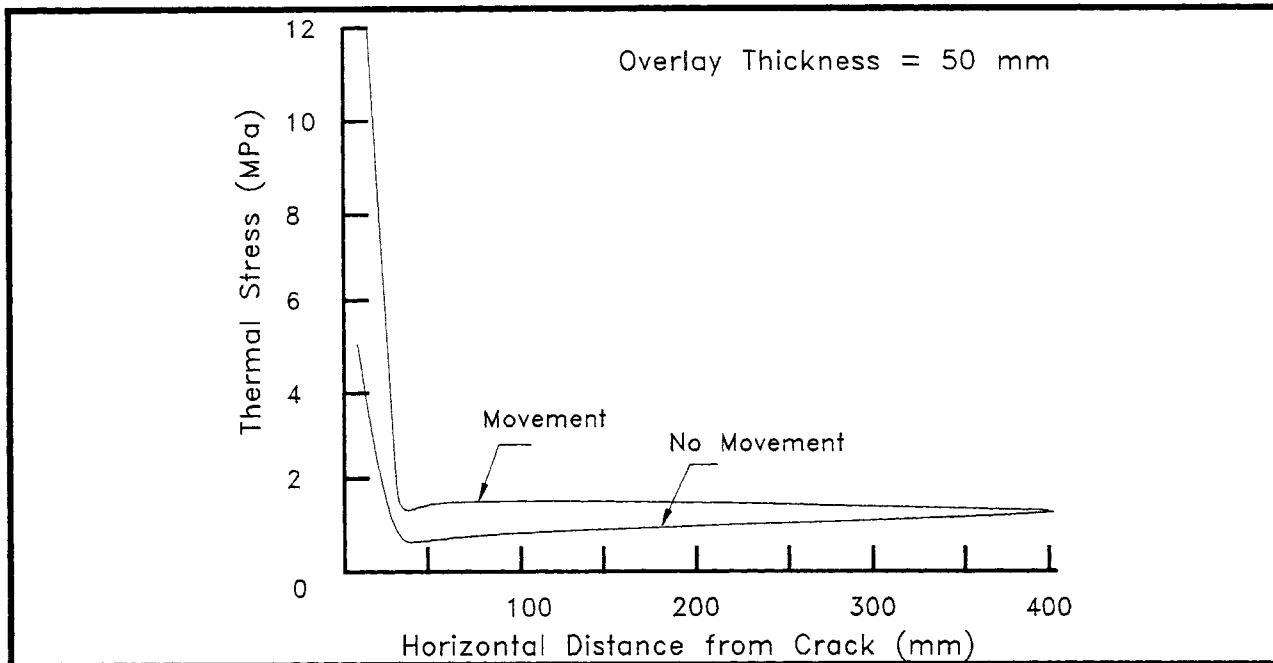

Figure 3.15 Stress Distribution in the Bottom of the Asphalt Overlay [after ref. 9]

The use of geotextile fabrics to reduce the occurrence of reflective cracking has been reported to be successful, however procedural complications may still be limiting its effective use. For example, in Virginia it was reported that both transverse and longitudinal joint line reflective cracking was completely eliminated on several glulam timber bridges which were fitted with the Amoco Petrotack System geotextile underlay prior to surfacing with asphalt pavement (Telephone conversation with Mr. Terri Carlson, Bureau Chief of Transportation, Calvert County, VA). The Petrotack System is a geotextile fabric which has an adhesive backing application to timber decks. Based on this observation the Bureau Chief was able to conclude that the underlay fabric was able to efficiently dissipate the stress applied to the asphalt overlay from the longitudinal and transverse fault lines. However, some complications with extruded creosote were realized during the application process. When the recommended installation procedure was followed, an initial asphalt binder tack coat was applied to the timber deck prior to emplacement of the underlay fabric. Problems were realized when creosote extruded from the deck and softened the asphalt binder tack coat. In order to attain proper performance of the Pertromat System underlay the recommended initial deck tack coat application was eliminated and underlay was placed directly on the deck. The underlay fabric worked as a sponge and soaked up the extruded creosote and in the process attained a suitable bond with the deck surface.

In another project ambient air temperature and moisture were noted as factors in affecting the bonding and ultimate performance of a geotextile underlay. In this situation the application of the underlay fabric and asphalt was attempted during cold damp weather rather than at optimal conditions [24]. This application was observed to have problems due to inadequate bonding of the fabric to the deck surface.

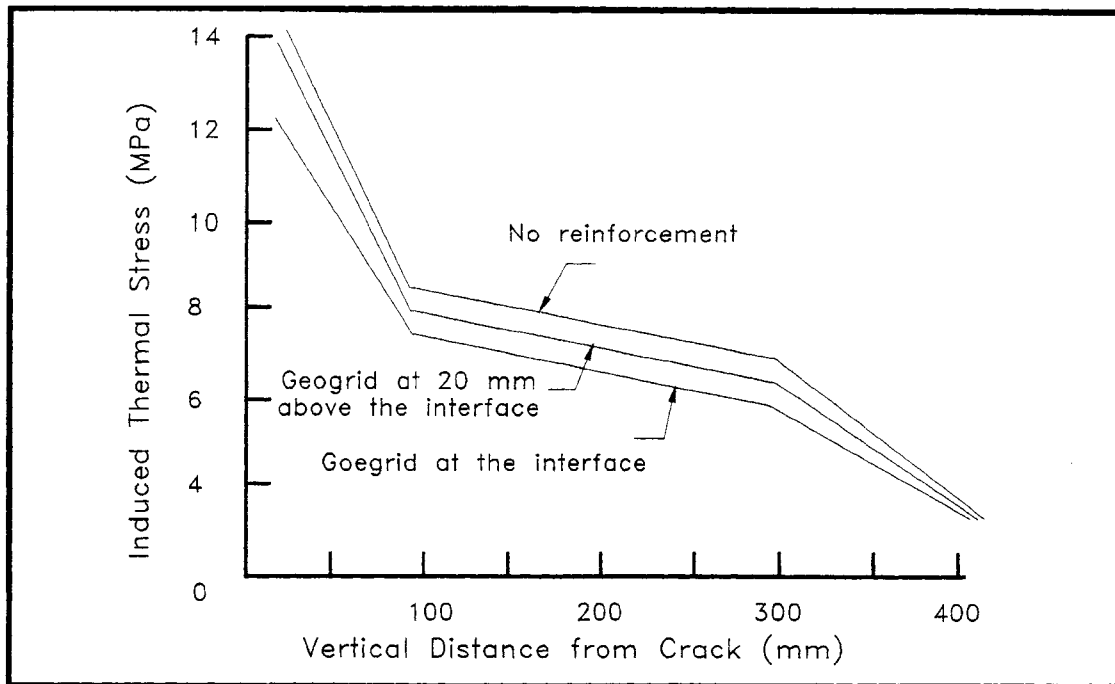

Figure 3.16 Geogrid Reinforcement of Asphalt Pavement Overlay

[after ref. 9]

A possible problem with using fabric underlay on nail-laminated timber decks is the irregular surface of the timber deck. The individual laminations of a nail-laminated deck are not leveled evenly with one another. One can then envision gaps between the fabric underlay and the timber deck because the fabric would not layout smooth across the uneven laminations. A solution to this problem may be to lay down a thin asphalt base on top of the deck to level the deck surface, then apply the fabric to the level surface, and finally lay the wearing asphalt layer on top of the fabric.

Another underlay option is the Sand Anti-Fracture (SAF) mixture, a hot-mix asphalt rich mixture with sand used as the aggregate. Developed in France to treat reflective cracking, the function of SAF is basically the same as fabric underlay material. Comparison tests are currently underway in the United States to determine if SAF mix can resist cracking better than fabric type underlay (Koch Materials Company, St. Paul, MN.). A possible advantage of a SAF mix is the ability to apply it as a hot-mix directly to the base thus utilizing the same equipment and processes

common to asphalt paving. In addition, this mixture could form its own leveling surface since it would be able to fill the irregular surface inherent to a nail-laminated timber deck.

Underlay reinforcement material may work well in combination with saw and seal joints to effectively retard and relieve displacement and thermal stresses across the entire timber deck. Saw and seal joints could be cut in transverse locations where high magnitude stresses are predictable. Where as underlay material might work best in retarding stresses over less predictable longitudinal fault lines. Again, further testing must be performed to indicate whether fabric materials or SAF are appropriate for timber bridge applications.

Two concerns with both of these underlay systems is the affect of shear stress and thermal contraction on the contact surface joining the underlay material to the asphalt pavement. If the geotextile or SAF meets the asphalt pavement at the center of their combine thickness, then the greatest shear stress would be experienced directly at the contact surface. Also, if the two materials have different coefficients of thermal expansion, then temperature fluctuations may loosen the bond between the two materials. Again, field and laboratory studies must be performed to properly answer these questions.

3.4.3. Wear Surface Options

Alternative wear surfaces, asphalt pavement mix design changes and asphalt binder changes which demonstrate improved pavement crack resistance on regional roads should also be tested for timber bridge applications. Asphalt chip seal may be a likely alternative to asphalt pavement as a timber bridge wear surface because it is a more flexible system than pavement. Another option might be to adjust the asphalt binder and pavement design variables in order to decrease thermal contraction, increase asphalt to aggregate adhesion and improving the asphalt's cohesion and rheological properties. Even though phenomenon similar to reflective cracking may

be basic cause for asphalt cracking on timber bridges, a reduction in asphalt susceptibility to low-temperature cracking and fatigue may work to decrease the severity of incurred cracks. The following discussion is not a paving guide, all paving practices should following state approved methods.

The high asphalt content of an asphalt chip seal might make it a viable alternative for surfacing timber decks because it can offer a more flexible surface than asphalt pavement, and therefore should be less susceptible to cracking. Lower costs, improvements in the chip seal application technique and binder additives, and ease of repair could make this surfacing method an effective replacement for asphalt pavement.

Typically chip seal overlays have had some problems with performance due to binder hardening and aggregate displacement [26]. Polymer additives to the asphalt binder have been designed to improve initial chip adhesion and maintain the consistency of the asphalt for much longer periods [27]. The asphalt chip seal could provide greater resistance to cracking because it is generally a more flexible system than asphalt pavement.

Changing the application technique to a double chip seal rather than a single layer has also shown improve the life and performance of the chip seal. By this method a second layer of binder and aggregate are placed down over a base chip seal layer. The second layer aggregate is often a smaller size than the first layer and thus is able to fill into the voids left by the first layer, and thus restricts the second layer from becoming dislodged [26]. The second layer of aggregate also prevents the first layer of aggregate from displacing because it works as locking mechanism when it fills in the first layer voids.

A foreseen problem with using an asphalt chip seal is the lose of the ability to prevent cracks, rather cracks would have to be maintained by means of subsequent chip seal applications.

Also, application of a chip seal on a nail-laminated timber deck may be difficult because the deck typically has an uneven surface caused by variations in lamination height of more than 1/2 an inch. The height variations between laminations may not be fully covered by a chip seal application, therefore the chip seal surface may also be non-uniform.

Simple modifications to the asphalt pavement mix may also be a practical approach to improving the pavements' performance. Asphalt mixes with a higher penetration rating or a polymer modified binder could produce a more durable pavement with improved rheological properties. Modified asphalt pavements should be tested on nail-laminated timber bridges to assess their ability to reduce reflective cracking and resist fatigue and raveling.

3.4.4. Bridge Maintenance and Rehabilitation Practices

Strong preventive maintenance and remedial treatment programs may in themselves adequately maintain the serviceability of both the asphalt wear surface and the timber bridge since the quality and performance of the timber bridge can affect the performance of the an asphalt wear surface and visa versa. Maintenance considerations should at least address pavement integrity, deck stability and timber decay resistance.

Remedial wood preservative treatment for preventing decay involves both state and federal regulations and restrictions, therefore prior to preservative application the state Department of Agriculture should be contacted for training and proper licensing of restricted use pesticides. Also, for current information about remedial preservative treatment of timber bridges contact both the state extension service and the Wood in Transportation National Information Center (Morgantown, WV, phone 304-285-1591) [see ref. 2 for discussions concerning in-use wood preservative insecticide and fungicide treatments].

Timber bridge maintenance also involves tightening bolts holding bridge members in

place. Loss of wood MC and deflective forces may cause many of the bolts in a timber bridge to loosen, in particular the bolts holding the transverse stiffener beam in place on longitudinal slab span bridges. As discussed earlier, when functioning properly the transverse stiffener beam should help disperse live loads across the deck and minimize differential movement between adjoining laminations. A preliminary study was performed to test the effect tightening of the transverse stiffener beams on longitudinal LNL slab-span bridge types has on reduction of deck deflection. In this study the transverse stiffener beam bolts were tightened using lock-nuts, and wood shims were added to occupy remaining gaps between the deck and the stiffener beam (Figure 3.17). Inter-lamination deflection was decreased by 90% across four laminations, and the average deflection reduction was approximately 10%. Figure 3.18 illustrates the wide range of deflections observed for the four adjacent laminations prior to bolt tightening and shimming (control values) and an almost negligible difference after the shims were added. These results indicate that a tightened stiffener beam with full contact with the deck is better able to better transfer forces laterally across the deck.

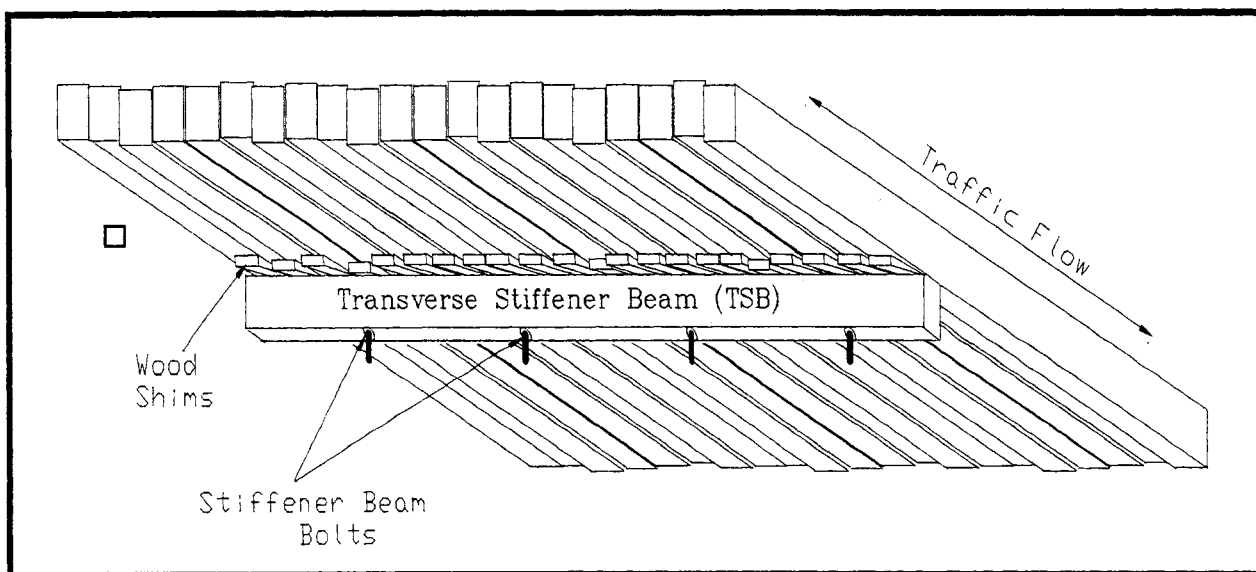

Figure 3.17 Maintenance on Longitudinal Superstructure Timber Bridge Decks

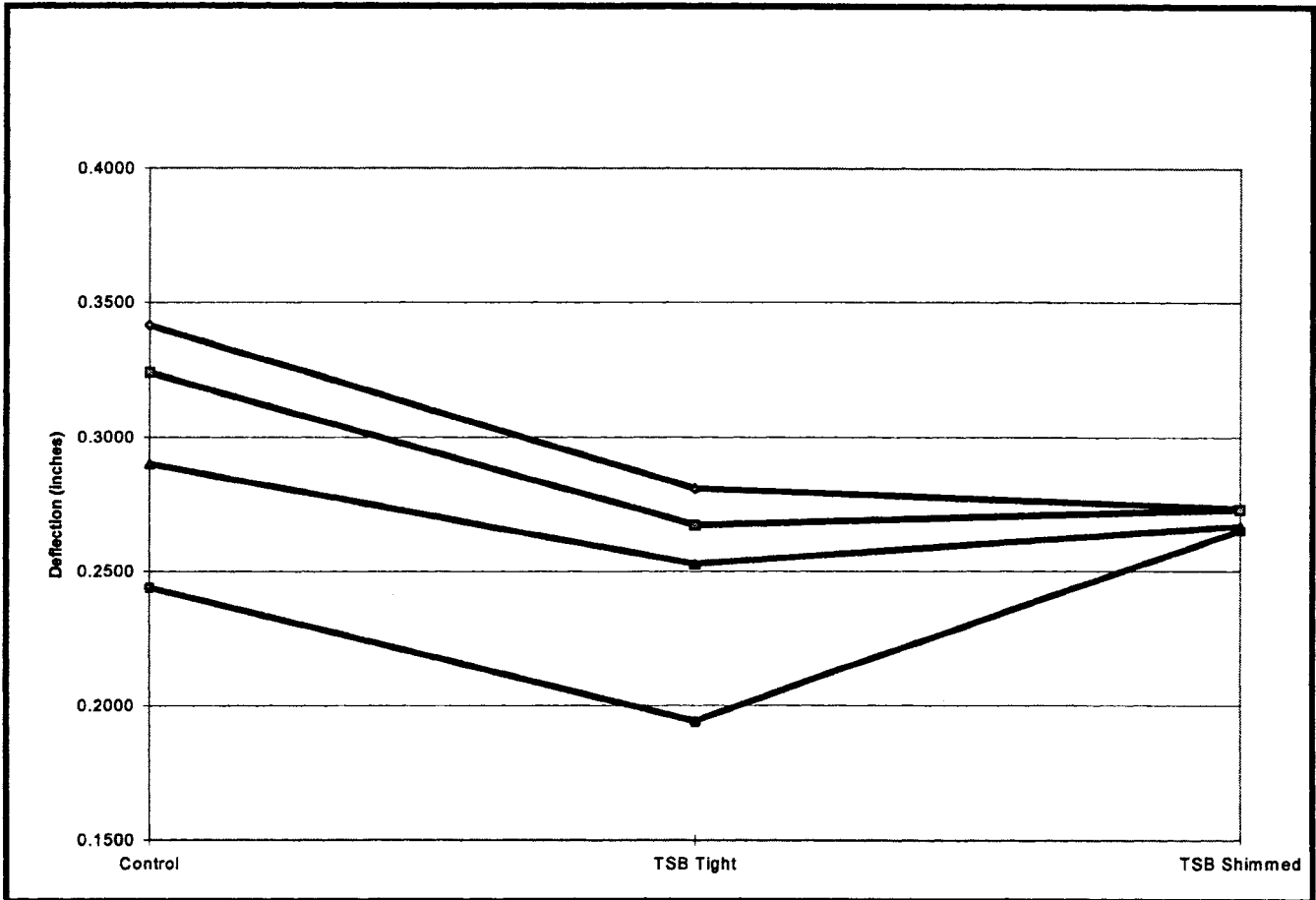

Figure 3.18 Deflection Change From Tightening of Transverse Stiffener Beams

3.4.5. Timber Deck Rehabilitation

Deck rehabilitation can also be an option for improving deck stability of older timber bridges. Over time nail laminated bridges tend to lose some of their ability to distribute loads transversely across the deck. This may be the result of fiber crushing by the connectors, overloading, poor field fabrication, deck moisture variations or inadequate design [15]. The consequence is fewer deck members are actually supporting wheel loads, thus a more concentrate stress is applied to the wear surface. Under these conditions the serviceability of asphalt pavement

may be difficult to maintain.

Timber deck rehabilitation has demonstrated to be an effective means of addressing these conditions. Two rehabilitation options, spreader deck emplacement [15,28] and post-tensioning [29] have been employed to reestablish lateral load distribution. Both of these methods require removal of the existing asphalt surface, but allow for the existing deck to remain in place.

Post-tensioning involves placing transverse stress on the timber deck with a series of high-strength steel rods (Figure 3.19). This method utilizes the same concept as stress laminated timber decks, except the stressing rods are located outside of the deck rather than internally. The stress squeezes the laminations together there by creating a better load distribution across the deck. In stressing the deck the transverse dimension is decreased, therefore additional laminations are added to maintain the original bridge width. While this method has proved effective for rehabilitating LNL decks, the cost of the rehabilitation has often prohibited its use.

The basic concept of spreader deck emplacement is to add an additional deck transverse to the existing deck (Figure 3.20). The spreader deck consists of prefabricated nail laminated deck panels. Spreader deck panels are then assembled and bolted to the original deck. Since irregular surfaces are inherent to timber decks, cement is used to fill voids between the spreader deck and the original deck in order to provide uniform load transfer deck layers. An additional benefit of this technique is the ability to change the width of the deck surface when additional roadway width is desired. Spreader decks have shown to substantially decrease deck deflection through more effective lateral load transfer.

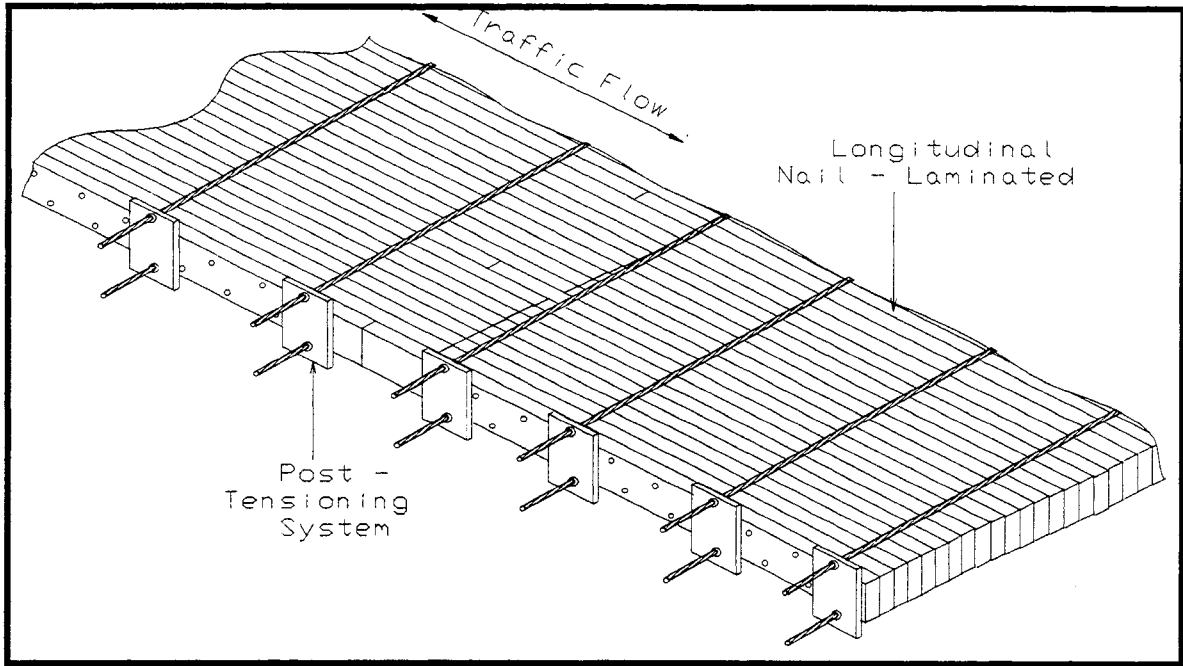

Figure 3.19 Post-Tensioning Rehabilitation of Longitudinal Superstructure Timber Bridge Decks

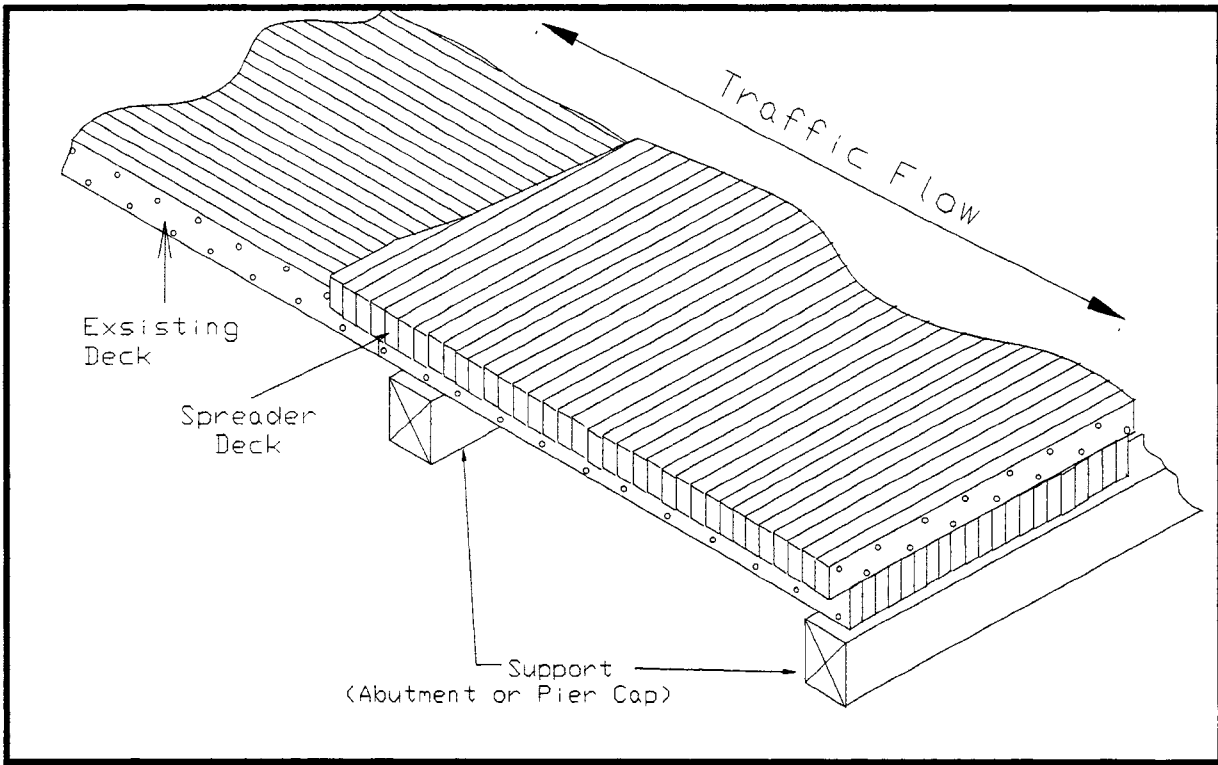

Figure 3.20 Spreader Deck Rehabilitation of Longitudinal Superstructure Timber Bridge Decks

Chapter-4 Conclusion

4.1. Summary and Recommendations

According to a our survey, fifty percent of Minnesota's counties experience some problems with premature timber bridge asphalt wear surface deterioration. Methods for improving the performance of timber bridge wear surfaces were sought given that a functional asphalt wear surface is needed to provide protection from vehicles and the environment.

Wear surface deterioration may occur in response to the mechanical function of timber bridge system, temperature induced strain, asphalt fatigue or asphalt de-bonding from the timber deck. Pavement cracks and deterioration can allow moisture to reach the deck and substructure and possibly induce deck decay and asphalt de-bonding, which may ultimately worsen the asphalt pavement serviceability. Several promising options exist for reducing asphalt deterioration on timber bridge decks, the following is a list of the options which are recommended for further testing and consideration for implementing on Minnesota timber bridges.

1) Pavement Performance

- a) Test the use of the asphalt pavement saw & seal technology to restrict the occurrence of timber bridge wear surface cracks or route & seal to rehabilitate damaged wear surfaces.
- b) Test polymer modified asphalt binders additives or changes in the pavement mix design to increase the flexibility (particularly during the cold season) of the wear surface on timber bridges.
- c) Test the use of the use Sand Anti-Fracture (SAF) hot-mix polymer modified underlay to reduce reflective type cracking on timber bridges.

2) Deck Performance

- a) Test the affect of tightening and shimming the transverse deck stiffener beam in terms of

reduced inter-lamination movement and reduced transverse and longitudinal deck deflection.

- b) Determine the regional timber bridge equilibrium moisture content in order to accurately predict the dimensional changes that bridge components will experience after installation, and to more accurately predict bridge component strength in design computations.
- c) Implement a larger number of timber bridge rehabilitation projects with retrofit spreader decks. Doing this will upgrade bridges to changes in roadway geometry and to reduce global deck deflection.

3) Asphalt Surface Adhesion

- a) Implement standard pre-surfacing deck preparation procedures in order to improve asphalt to deck adhesion. These methods should include:
 - i) Blotting off excess creosote
 - ii) Sweeping and pressure spray washing of decks to remove all loose material
 - iii) Application of a tack coat if all excess creosote has been adequately removed from the surface.

4.2. Recommended References

Finally, the following publications concerning timber bridges are recommended for review:

- 1) Donnelly, C., User Friendly Guide to Timber Bridges.

Obtain by calling: University of New Hampshire Cooperative Extension Publication Center
(603)862-2346.

- 2) Eslyn, W.E. and Clark, J.W., Wood Bridge-Decay Inspection and Control, Agriculture Handbook No. 557, Oct. 1979.

Obtain by calling: Wood in Transportation National Information Center (304)285-1591, or via

internet visit <http://wit.fsl.wvnet.edu/>

- 3) Johnson, K.A., Timber Bridge Design Manual, Wheeler Consolidated, Inc., St. Louis Park, MN, Fourth Edition, 1990.

Obtain by calling: Wheeler Consolidated, Inc. (612) 929-7854

- 4) Leon, R.T., Beltaos, D.O., and Seavey, R.T., Retrofit of Wood Bridges, Minnesota Department of Transportation, Report Number 94-16, 1993.

Obtain by calling: Minnesota Department of Transportation, (612)282-2272.

- 5) Ritter, M.A., Timber Bridges: Design, Construction, Inspection, and Maintenance, United States Department of Agriculture, Forest Service, EM 7700-8, Aug., 1992.

Obtain by calling: Wood in Transportation National Information Center (304)285-1591, or via internet visit <http://wit.fsl.wvnet.edu/>

This page intentionally left blank.

References

- 1) Ritter, M.A., Timber Bridges: Design, Construction, Inspection, and Maintenance, United States Department of Agriculture, Forest Service, EM 7700-8, Aug., 1992.
- 2) Taylor, R.J. and Keenan, F.J., Wood Highway Bridges, Canadian Wood Council, 1992
- 3) Smith, R.L. and Bush, R.J., "A Qualitative Evaluation of the U.S. Timber Bridge Market," Forest Products Journal, Vol. 47, No. 1, 1997, pp. 37-42.
- 4) Smith, R.L. and Bush, R.J., "A Perceptual Investigation into the Adoption of Timber Bridges," Wood and Fiber Science, Vol. 27, 1995, pp. 141-154.
- 5) Eslyn, W.E. and Clark, J.W., Wood Bridge-Decay Inspection and Control, Agriculture Handbook No. 557, Oct. 1979.
- 6) ---, American Wood-Preservers' Association, Standards 1995, Woodstock, Maryland, USA, 21163-0286, 410-465-3169.
- 7) Janisch, D.W., and Turgeon, C., Sawing and Sealing Joints in Bituminous Pavements to Control Cracking, Minnesota Department of Transportation, Report No. MN DOT # 96-27, 1996.
- 8) Haas, R.C.G. and Phang, W.A., "Relationships Between Mix Characteristics and Low-Temperature Pavement Cracking," Proceedings, Association of Asphalt Paving Technologists, Vol. 57, 1988, pp. 290-303.
- 9) Joseph, P.E., and Haas, R.C.G., "Evaluating Alternative Solutions to Reflective Cracking Through Asphalt Overlays," Transportation Research Record No. 1215, Transportation Research Board, 1989, pp. 202-291.
- 10) King, G.N., King, H.W., Harders, O., Arand, W. and Planche, P.P., "Influence of Asphalt

- Grade and Polymer Concentration on the Low Temperature Performance of Polymer Modified Asphalt,” Proceedings, Association of Asphalt Pavement Technologists, Vol. 62, 1993, pp. 23-53.
- 11) Stock, A.F. and Arand, A., “Low Temperature Cracking In Polymer Modified Binders,” Proceedings, Association of Asphalt Pavement Technologists, Vol. 62, 1993, pp. 23-53.
- 12) Meyer, F., Hignell, E.T., Kennepohl, G.A and Haas, R.C.G., “Temperature modifications of sulfur-asphalt mixtures,” Proceedings of Association of Asphalt Technology. Vol. 46, 1977.
- 13) Anderson, D.T., “New approach to asphalt overlay design,” Proceedings, 12th Australian Road Research Board, Vol. 12, pp. 55-67.
- 14) Johnson, K.A., Timber Bridge Design Manual, Wheeler Consolidated, Inc., St. Louis Park, MN, Fourth Edition, 1990.
- 15) Johnson, K.A. and Isakson, E., “Rehabilitation of Slab Span Timber Bridges,” Proceedings of the 13th Structures Congress, Boston, Massachusetts, 1995, pp. 281-289.
- 16) Wacker, J.P., Seavey, R. and Erickson, R., “Cold Temperature Effects on Stress-Laminated Timber Bridges,” National Conference on Wood Transportation Structures, Gen. Tech. Rep. FPL-GTR-94. Madison WI: US Department of Agriculture, Forest Service, Forest Products Laboratory, 1996, pp. 232-238.
- 17) ---, The Encyclopedia of Wood, Sterling Publishing, Inc., New York, 1989, ch. 3, pp. 16.
- 18) McCrutcheon, W.J., Gutkowski, R.M. and Moody, R.C., “Performance and Rehabilitation of Timber Bridges,” Transportation Research Record No. 1053, Transportation Research Board, 1986, pp. 65-69.
- 19) Wacker, J.P. and Ritter, M.A., Field Performance of Timber Bridges, 4. Graves Crossing Stress-Laminated Deck Bridge, Research Paper FPL-RP-539. Madison WI: US Department of

- Agriculture, Forest Service, Forest Products Laboratory, 1995.
- 20) Kainz, J.A., Wacker, J.P., and Nelson, M., Field Performance of Timber Bridges, 9. Big Erick's Stress-Laminated Deck Bridge, Research Paper FPL-RP-552. Madison WI: US Department of Agriculture, Forest Service, Forest Products Laboratory, 1996.
- 21) Bruesch, L., "Surfacing Treated Decks with Bituminous Material," U.S.F.S. Eng. Tech. Information System, Field Notes, Vol. 8, Apr., 1976, pp. 1-3.
- 22) Nicolas, D.D. and Loos, E., Wood Deterioration and its Prevention by Preservative Means, Syracuse University Press, 1973. pp. 149-241.
- 23) Ishai, I., Livneh, M., Kief, O. and Altus, E., "Experimental and Analytical Model For the Role of Reinforced Asphaltic Membranes in Retardation of Reflective Cracking," Proceedings, Association of Asphalt Pavement Technologists, Vol. 62, pp. 130-149.
- 24) Faurot, R.A., Use of Geotextiles as Bridge Paving Underlayment, U.S.F.S. Eng. Tech. Information System, Field Notes, Vol. 16, Feb.-Mar. 1984, pp. 15-17.
- 25) Babilotte, C., Chaverot, P., and others, "L'Efficace et la Stabilité des Sables Anti-Remontée de Fissures Nécessitent L'utilisation de Bitumes Elastomeres," 1993 Proceedings Eurobitume, Vol. 4, pp. 730-734.
- 26) Shuler, S., "Chip Seals for High Traffic Pavement," Transportation Research Record, No. 1259, Transportation Research Board, 1990, pp. 24-34.
- 27) ---, "New Additive Improves Chip Seal Performance," Public Works, Vol. 118, No. 8, Aug., 1987, pp. 58-59.
- 28) Leon, R.T., Beltaos, D.O., and Seavey, R.T., Retrofit of Wood Bridges, Minnesota Department of Transportation, Report Number 94-16, 1993.
- 29) Taylor, R.J. and Csagoly, P.F., Transverse Post-Tensioning of Longitudinally Laminated

Timber Bridge Decks, Ministry of Transportation of Ontario, RR220, 1979.

30) Dimakis, A.G., Oliva, M.G. and Ritter, M.A., Behavior of Stress-Laminated Parallel-Chord

Timber Bridge Decks, Experimental and Analytical Studies, Research Paper FPL-RP-511.

Madison WI: US Department of Agriculture, Forest Service, Forest Products Laboratory, 1992.

31) Oliva, M.G., Dimakis, A.G., Ritter, M.A. and Tuomi, R.L., Stress-Laminated Wood Bridge

Decks, Research Paper FPL-RP-495. Madison WI: US Department of Agriculture, Forest

Service, Forest Products Laboratory, 1990.

32) Meyer, C.B., "New Applications of Structural Composite Lumber in Timber Bridges,"

Proceedings of Structures Congress 13, Vol. 1, Boston MA, 1995, pp. 4-8.

33) Tingley, D.A., Gilam, P.C., and Kent, S.M., "Long Term Performance of FRP Reinforced

Glulam Bridge Girders," National Conference on Wood Transportation Structures, Gen. Tech.

Rep. FPL-GTR-94. Madison WI: US Department of Agriculture, Forest Service, Forest Products Laboratory, 1996, pp. 201-206.

34) Hiltunen, D.R. and Roque, R., "A Mechanics-Based Prediction Model for Thermal Cracking

of Asphalt Concrete Pavements," Proceedings., Association of Asphalt Pavement

Technologists, Vol. 64, 1995, pp. 81-113.

