

---

# High-energy effective action from scattering of QCD shock waves

Ian Balitsky  
JLab & ODU

Minneapolis, 13 May 06

# High-energy scattering as a collision of shock waves

A typical hadron-hadron collision viewed from the c.m. frame has the form of scattering of two shock waves.

Regge limit:  $E \gg$  everything else

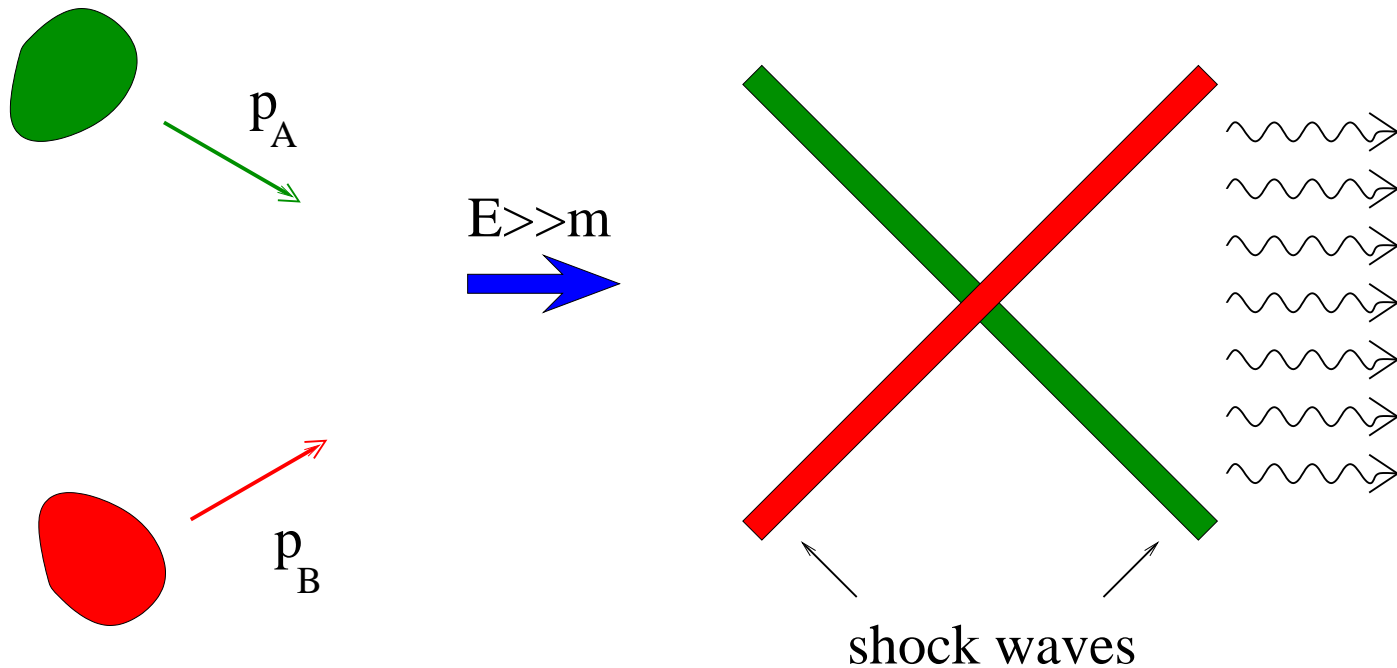

# High-energy scattering as a collision of shock waves

A typical hadron-hadron collision viewed from the c.m. frame has the form of scattering of two shock waves.

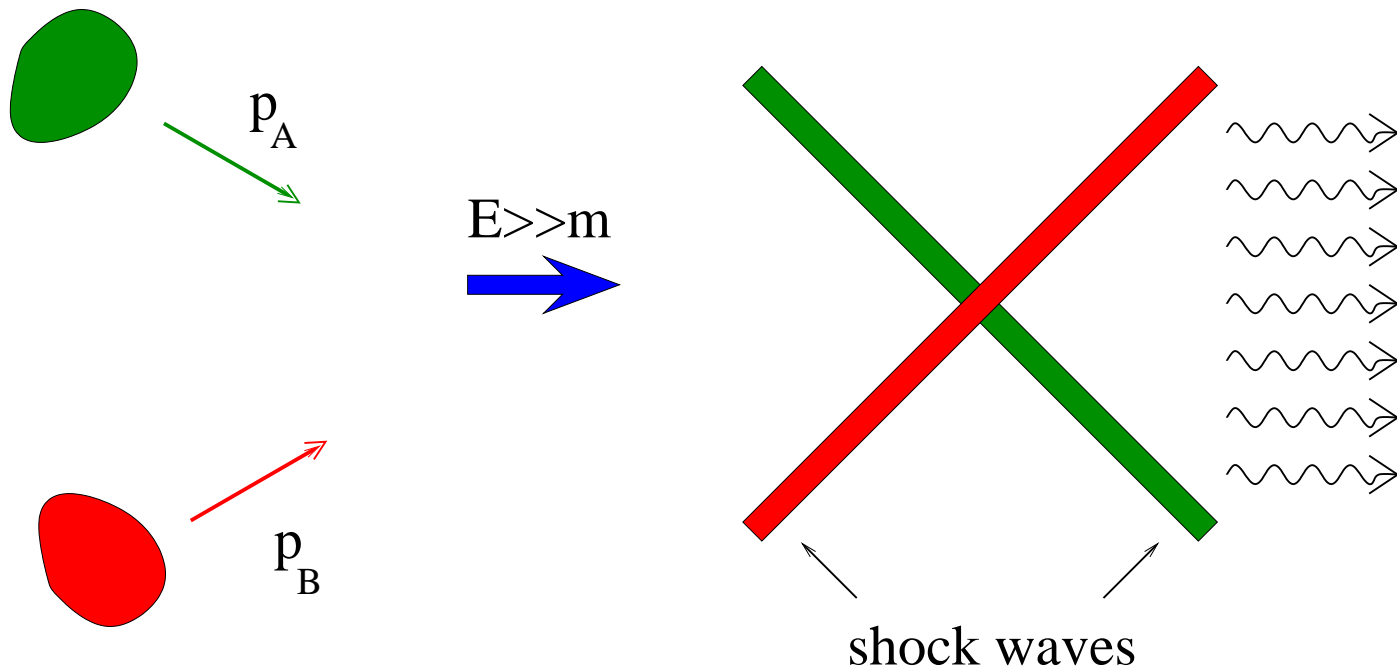

• **Big Q: Produced particles/fields  $\Leftrightarrow S_{\text{eff}}$  ?**

# High-energy scattering as a collision of shock waves

A typical hadron-hadron collision viewed from the c.m. frame has the form of scattering of two shock waves.

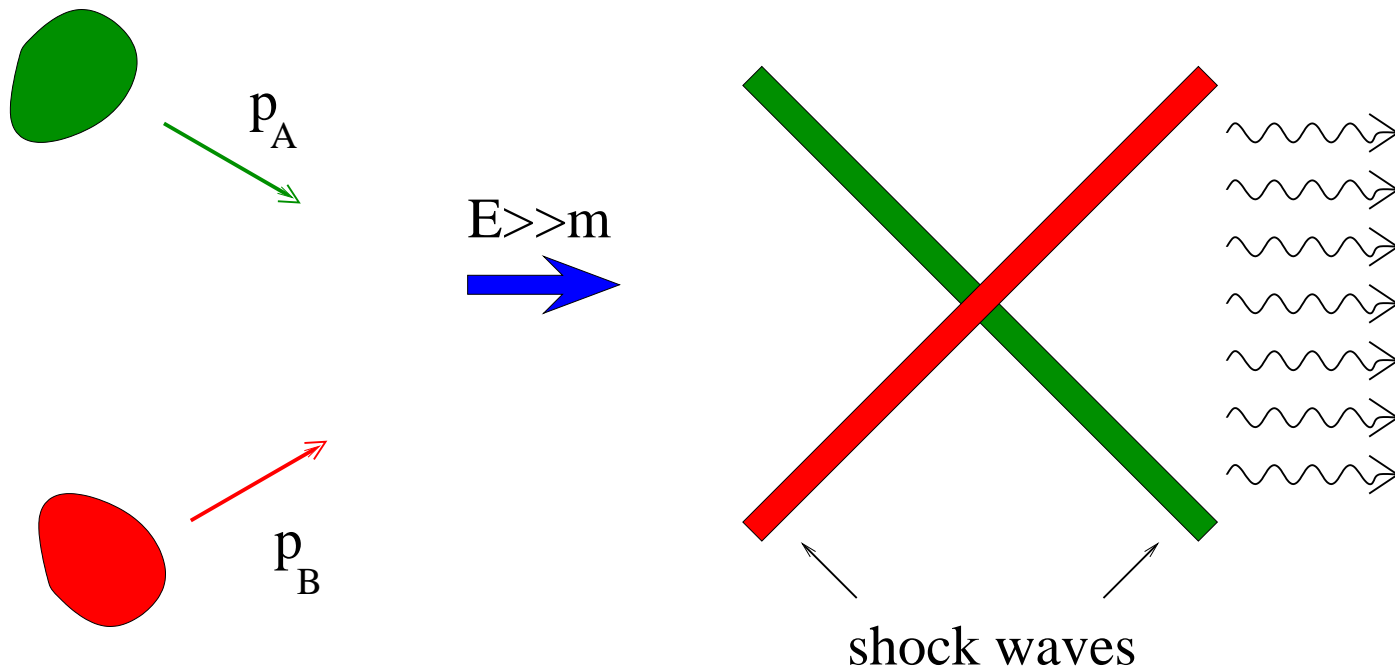

- Q # 0: What is a scattering of two QCD shock waves?
- **Big Q: Produced particles/fields  $\Leftrightarrow S_{\text{eff}}$ ?**

# Rapidity factorization

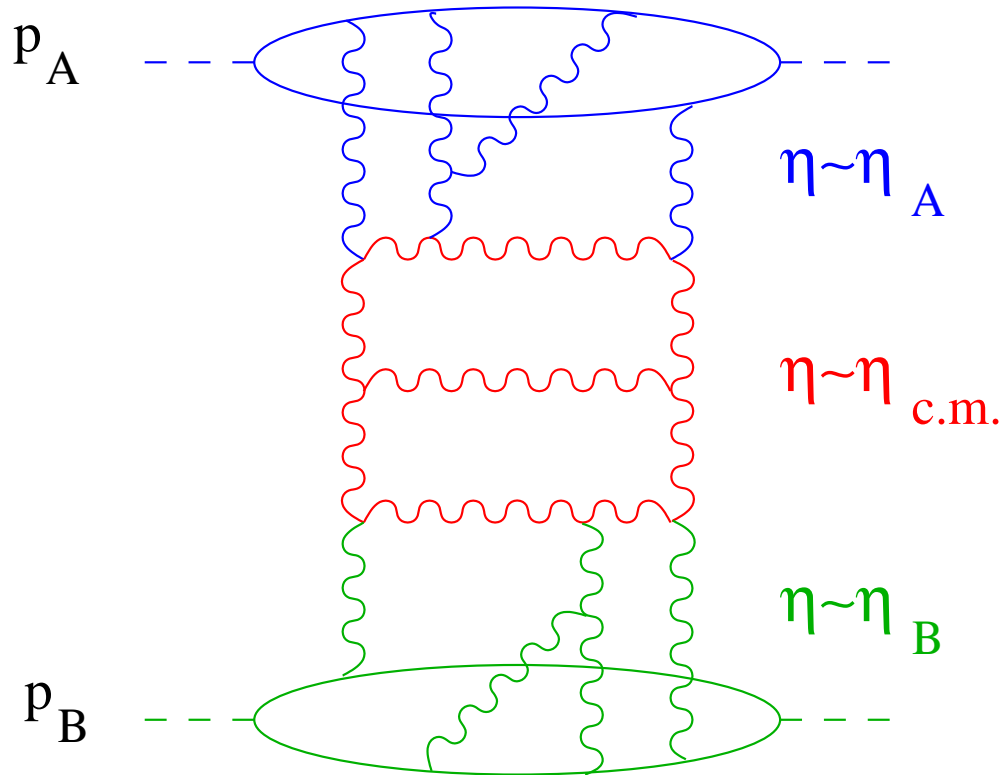

At first, we integrate over “red” gluons moving with rapidities in the central region  $\eta \sim \eta_{c.m.}$ . They interact with the “external” fields (to be integrated over later) with rapidities  $\eta \sim \eta_A$  and  $\eta \sim \eta_B$ .

# Rapidity factorization

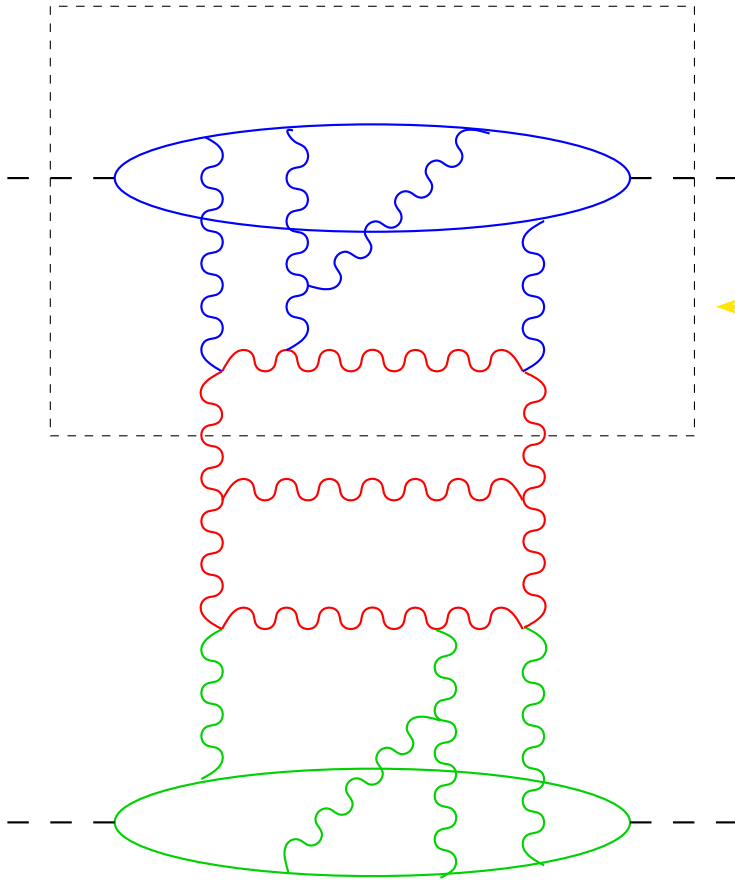

Consider the propagation of the *red* gluon in the background of *blue* gluons with greater rapidity

# Fast-moving hadron $\Rightarrow$ QCD shock wave

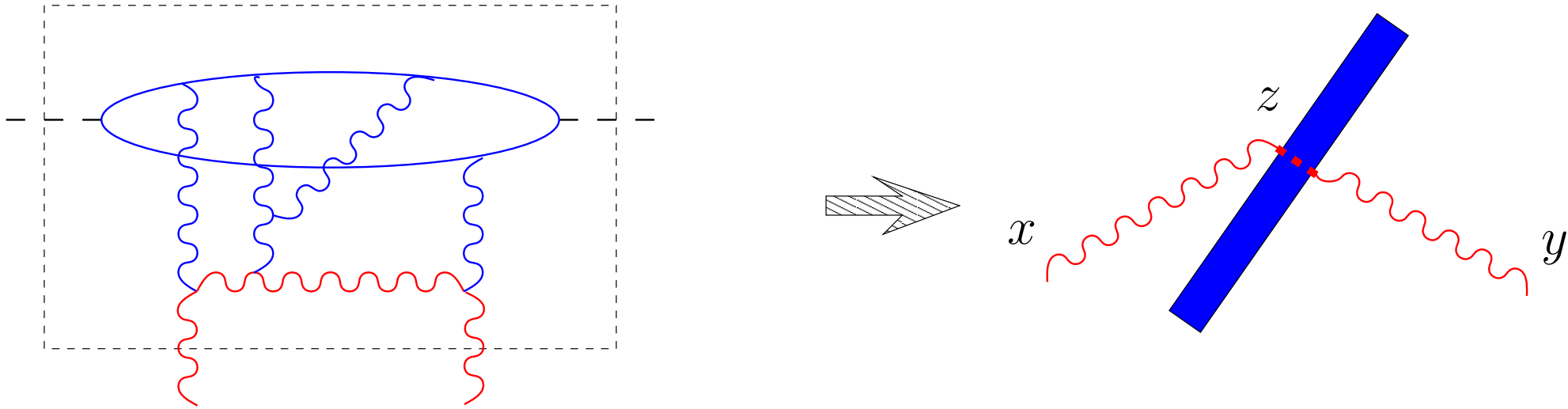

Fast-moving (blue) fields shrink into a pancake  $A_+ \sim \delta(x_-)$  .

# Fast-moving hadron $\Rightarrow$ QCD shock wave

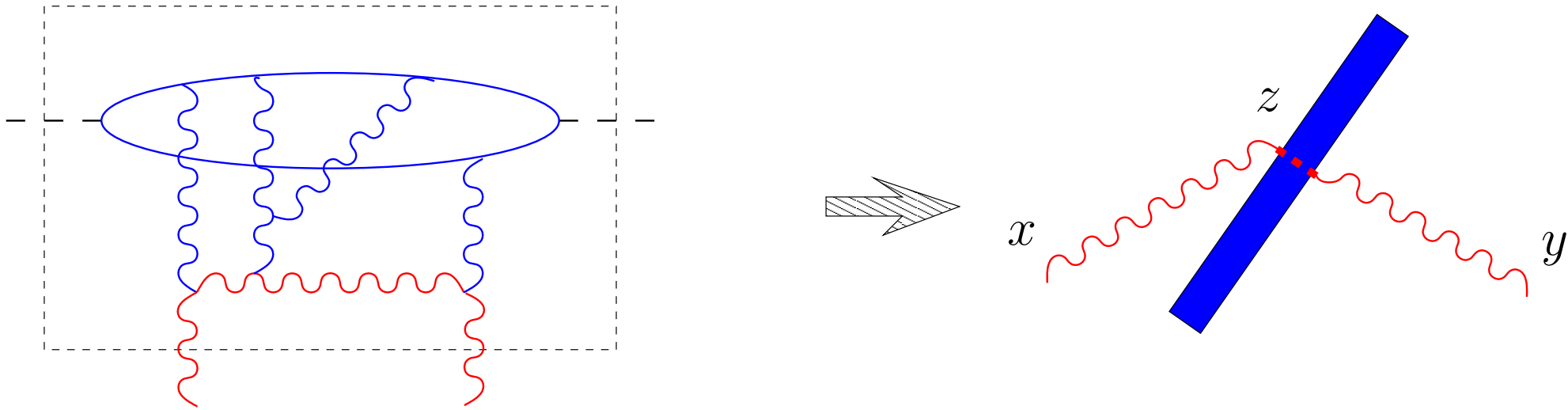

Fast-moving (blue) fields shrink into a pancake  $A_+ \sim \delta(x_-)$  .

Interaction with the shock wave is instantaneous

$\Rightarrow$  no time to deviate in transverse plane



# Fast-moving hadron $\Rightarrow$ QCD shock wave

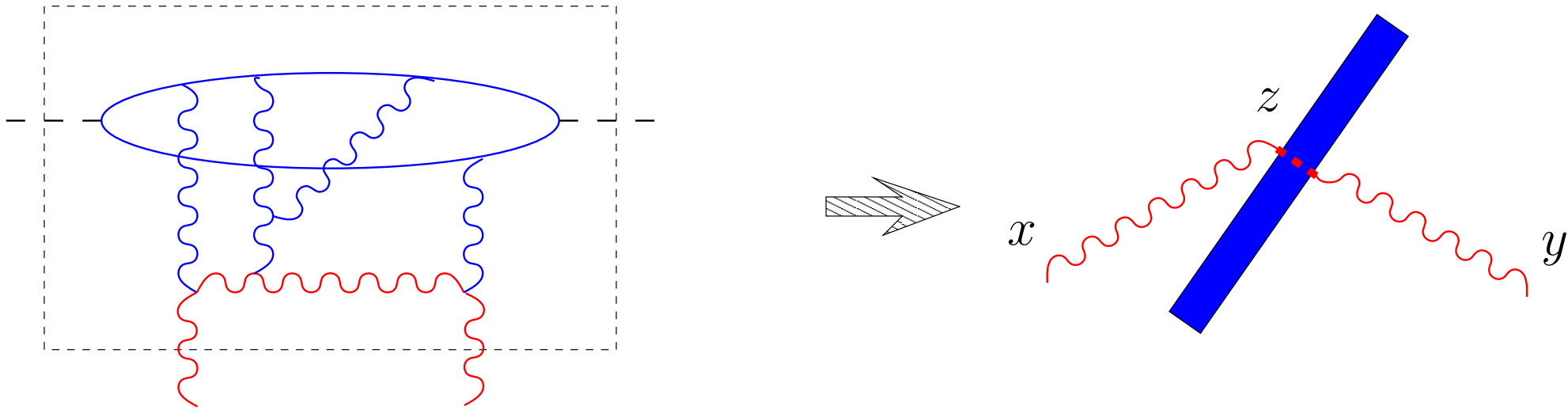

Fast-moving (blue) fields shrink into a pancake  $A_+ \sim \delta(x_-)$  .

Interaction with the shock wave is instantaneous

$\Rightarrow$  no time to deviate in transverse plane

$\Rightarrow$  the interaction is described by the *Wilson line*

$$V_z = [\infty p_2 + z_\perp, -\infty p_2 + z_\perp], \quad [x, y] \equiv P e^{ig \int_0^1 du (x-y)^\mu A_\mu(ux + (1-u)y)}$$

# Covariant vs axial gauge

Covariant gauges: the shock wave is a pancake:  $A_+ \sim \delta(x_-)$ ,  $A_- = A_i = 0$ .

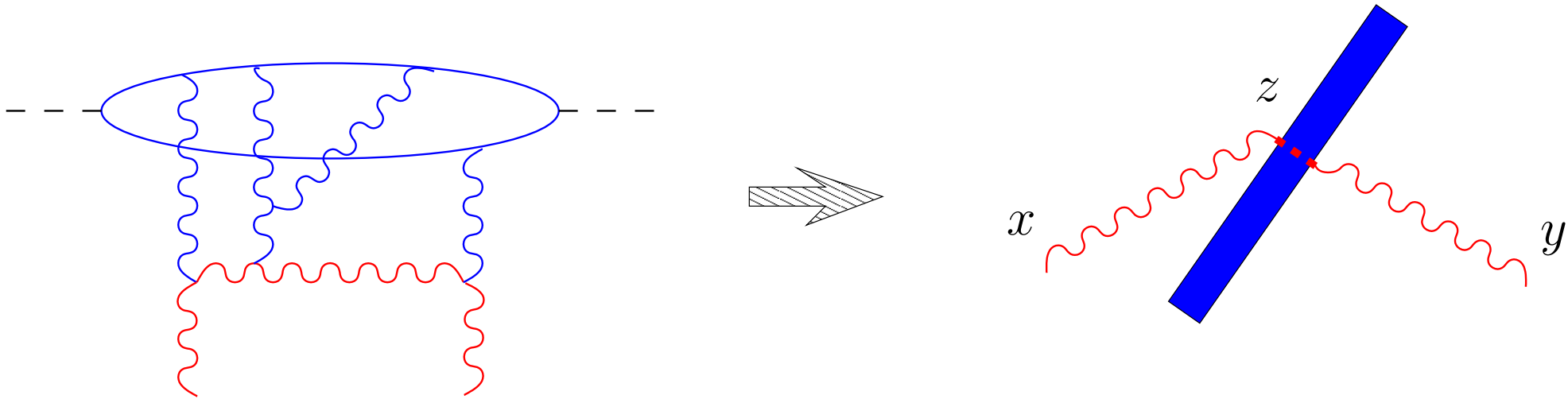

# Covariant vs axial gauge

Covariant gauges: the shock wave is a pancake:  $A_+ \sim \delta(x_-)$ ,  $A_- = A_i = 0$ .

Axial (temporal) gauges: the shock wave is a piece-wise pure gauge

$$A^i = \mathcal{V}_1^i(z_\perp)\theta(z_+) + \mathcal{V}_2^i(z_\perp)\theta(-z_+), \quad A_+ = A_- = 0, \quad \mathcal{V}_i \equiv V^\dagger \frac{i}{g} \partial_i V$$

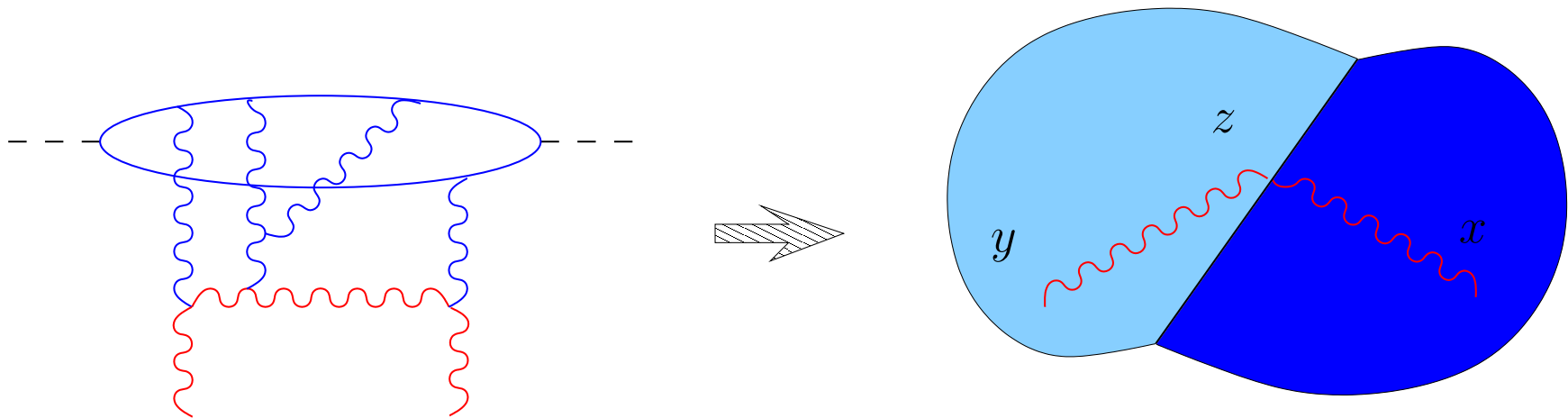

# Covariant vs axial gauge

Covariant gauges: the shock wave is a pancake:  $A_+ \sim \delta(x_-)$ ,  $A_- = A_i = 0$ .

Axial (temporal) gauges: the shock wave is a piece-wise pure gauge

$$A^i = \mathcal{V}_1^i(z_\perp)\theta(z_+) + \mathcal{V}_2^i(z_\perp)\theta(-z_+), \quad A_+ = A_- = 0, \quad \mathcal{V}_i \equiv V^\dagger \frac{i}{g} \partial_i V$$

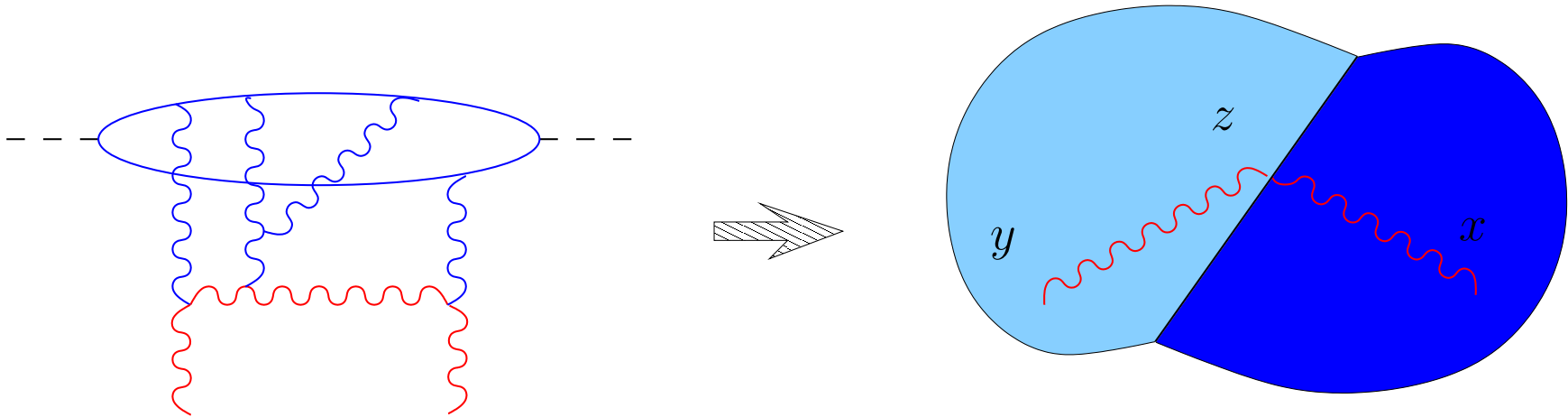

The source for such a field is

$$\exp\left\{i \int d^2 z_\perp \{\mathcal{V}_1^i(z_\perp) - \mathcal{V}_2^i(z_\perp)\} (0, F_{-i}, 0)_z\right\}$$

$$(0, F_{-i}, 0)_z \equiv \int du [z_\perp, up_1 + z_\perp] F_{-i}(up_1 + z_\perp) [up_1 + z_\perp, z_\perp]$$

# Second shock wave

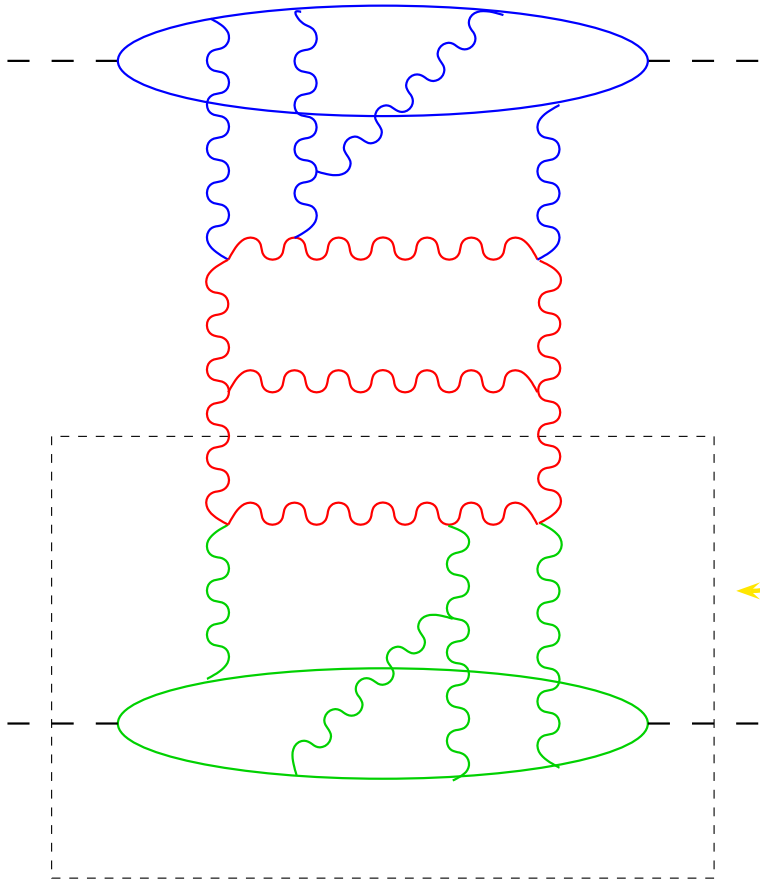

Consider now the propagation of the **red** gluon in the background of **green** gluons with greater rapidity

Covariant gauges:

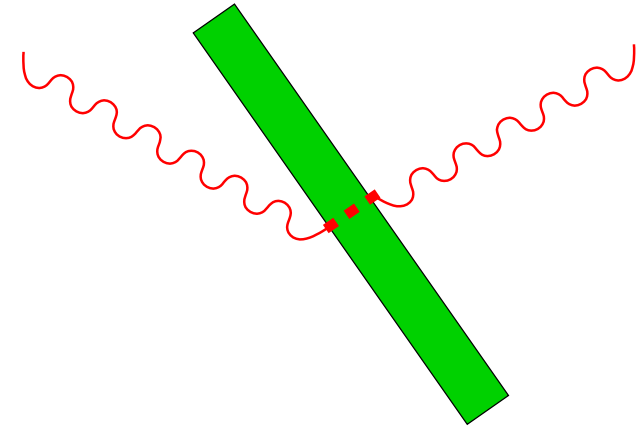
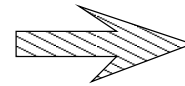
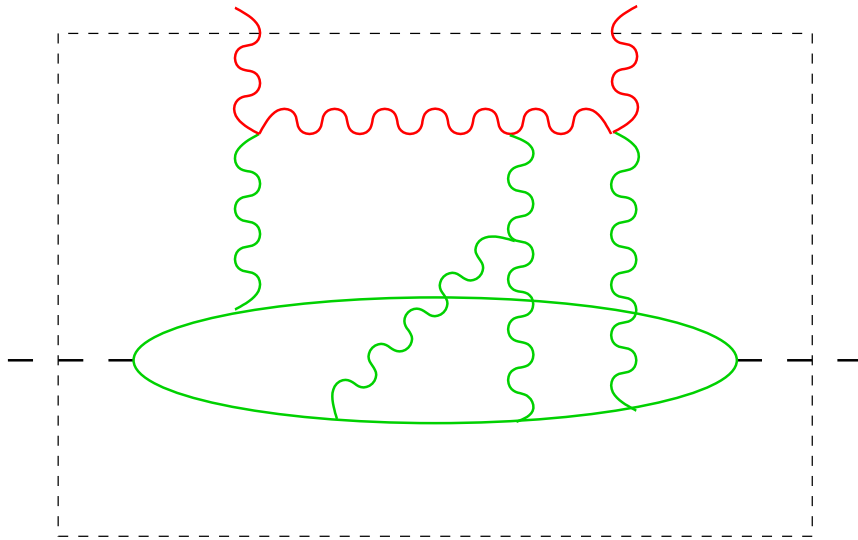

Axial gauges:

$$\mathcal{U}_i \equiv U^\dagger \frac{i}{g} \partial_i U$$

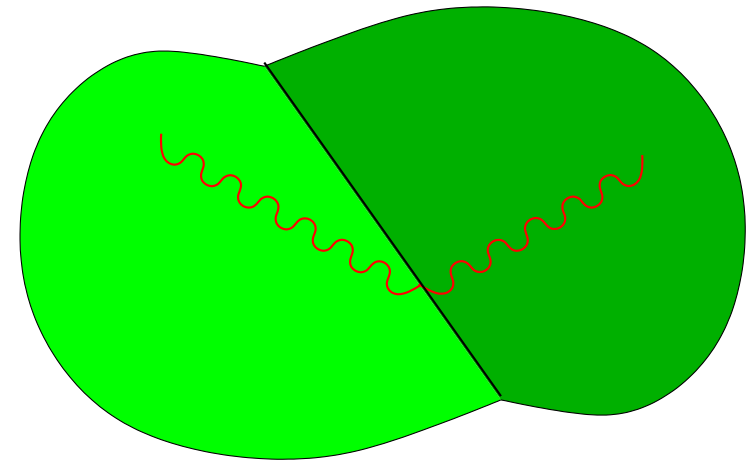
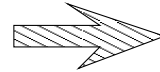
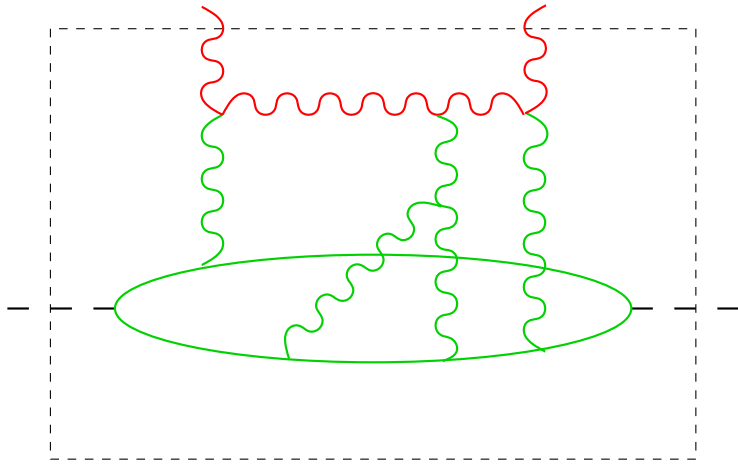

The source is

$$\exp\left\{i \int d^2 z_\perp (\mathcal{U}_1^i - \mathcal{U}_2^i)(z_\perp)(0, F_{+i}, 0)_z\right\}$$

$$\begin{aligned} [0, F_{+i}, 0] &\equiv \int du [z_\perp, up_2 + z_\perp] F_{+i}(up_2 + z_\perp) [up_2 + z_\perp, z_\perp] \\ &= [0, \infty p_2]_z i \frac{\partial}{\partial z_i} [\infty p_2, 0]_z + [0, -\infty p_2]_z i \frac{\partial}{\partial z_i} [-\infty p_2, 0]_z \end{aligned}$$

# Scattering of two shock waves

Gluons in the central region of rapidity move in the “external” fields of two shock waves

In the axial gauges

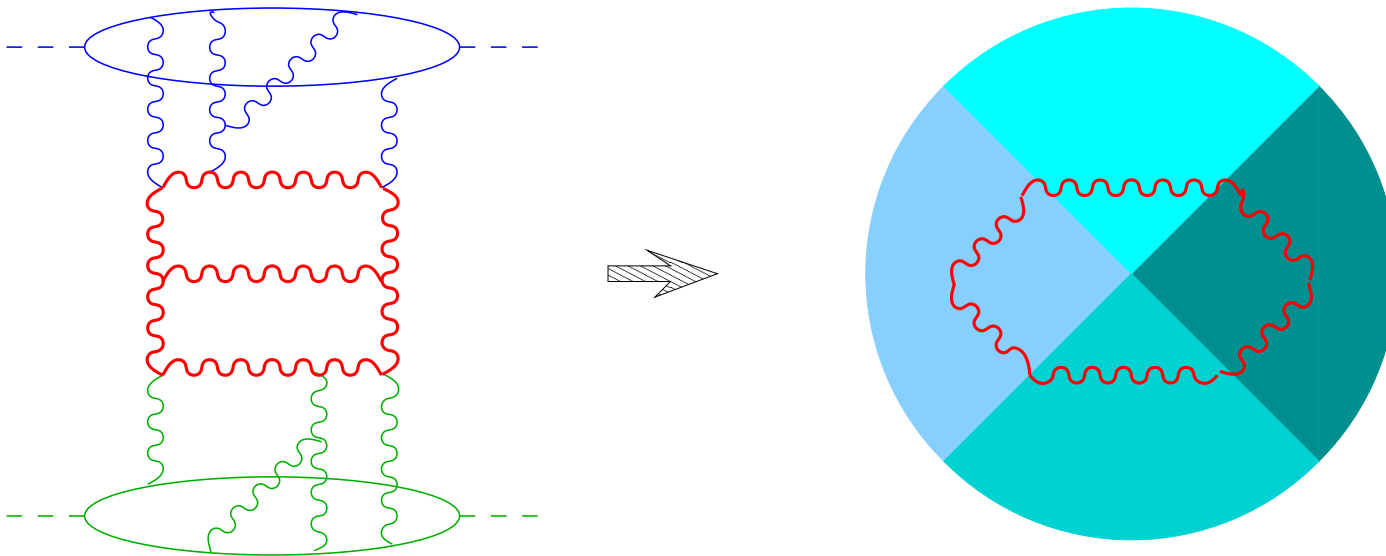



# Scattering of two shock waves

Gluons in the central region of rapidity move in the “external” fields of two shock waves

In the axial gauges

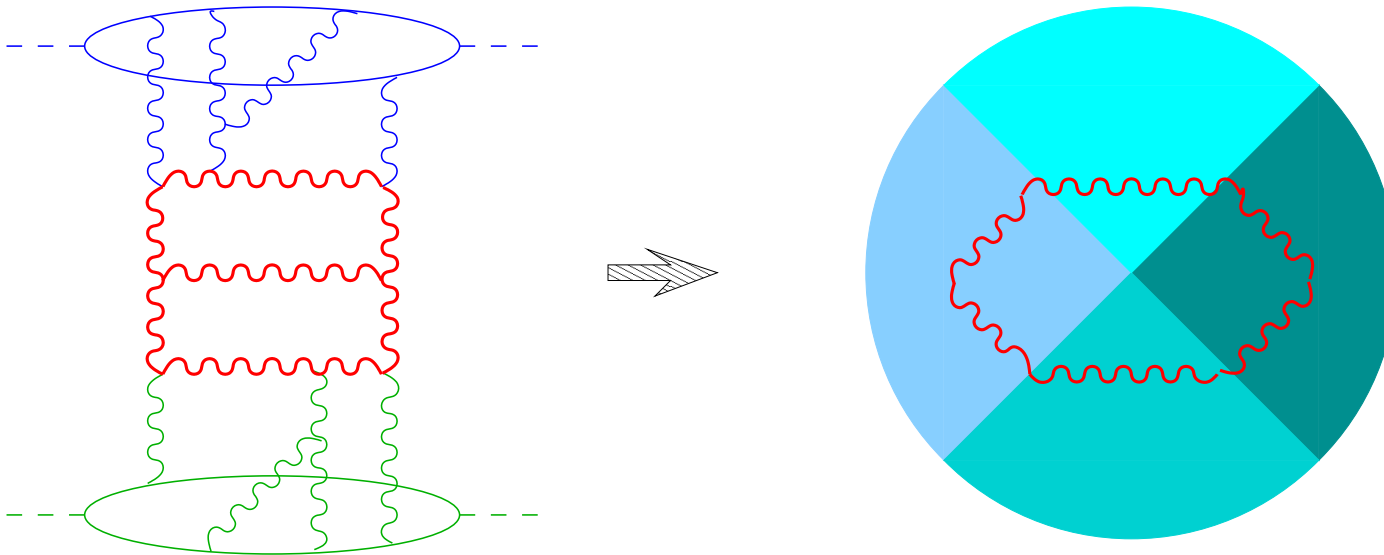

Integration over  $A$  fields gives the effective action

$$e^{iS_{\text{eff}}(U_i, V_i, \Delta\eta)} = \int D A e^{iS_{\text{QCD}}(A) + i \int d^2 z_{\perp} \{ (\mathcal{V}_1^i - \mathcal{V}_2^i)_z (0, F_{-i}, 0)_z + (\mathcal{U}_1^i - \mathcal{U}_2^i)_z [0, F_{+i}, 0]_z \}}$$

Rapidity  $\Leftrightarrow$  slope of the Wilson line

$$\Delta\eta = \eta_1 - \eta_2$$

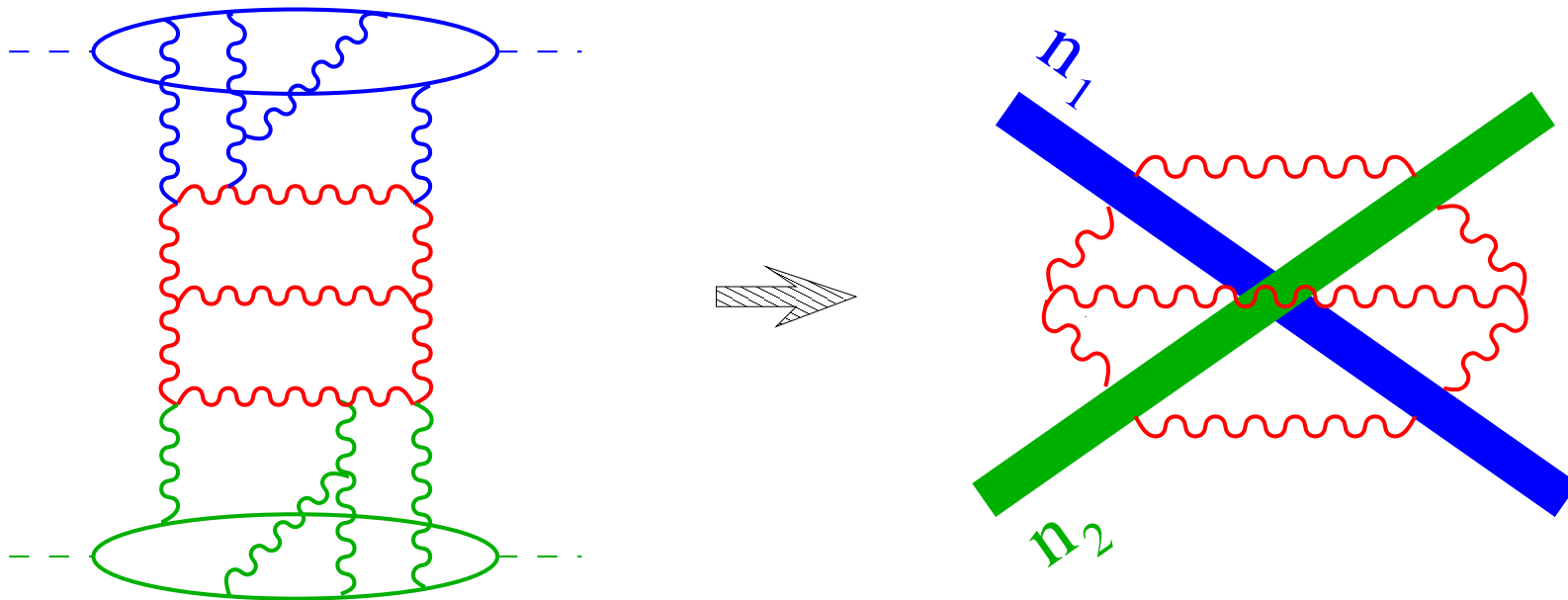

$$e^{iS_{\text{eff}}(U_i, V_i, \Delta\eta)} = \int D A e^{iS_{\text{QCD}}(A) + i \int d^2 z_{\perp} \{ (\mathcal{V}_1^i - \mathcal{V}_2^i)_z (0, F_{-i}, 0)_z + (\mathcal{U}_1^i - \mathcal{U}_2^i)_z [0, F_{+i}, 0]_z \}}$$

$$(0, F_{-i}, 0)_z = (0, \infty n_1)_z i \partial_i (\infty n_1, 0)_z + (0, -\infty n_1)_z i \partial_i (-\infty n_1, 0)_z,$$

$$[0, F_{-i}, 0]_z = [0, \infty n_2]_z i \partial_i [\infty n_2, 0]_z + [0, -\infty n_2]_z i \partial_i [-\infty n_2, 0]_z$$

$S_{\text{eff}}$  gives the small- $x$  evolution of the Wilson-line operators

BASIC IDEA:  $\alpha_s = \alpha_s(Q_s) \ll 1 \Rightarrow$  SEMICLASSICS IS RELEVANT

McLerran & Venugopalan

# Classical YM equation

---

BASIC IDEA:  $\alpha_s = \alpha_s(Q_s) \ll 1 \Rightarrow$  SEMICLASSICS IS RELEVANT

McLerran & Venugopalan

$$D^\nu F_{\nu\mu} = \frac{\partial}{\partial A_\mu}(\text{sources})$$

# Classical YM equation

---

BASIC IDEA:  $\alpha_s = \alpha_s(Q_s) \ll 1 \Rightarrow$  SEMICLASSICS IS RELEVANT

McLerran & Venugopalan

$$D^\nu F_{\nu\mu} = \frac{\partial}{\partial A_\mu}(\text{sources})$$

Two methods of the solution on the market:

- Numerical simulations.
- Perturbative expansion in strength of one of the shock waves

Venugopalan & Krasnitz

McLerran et al, Kovchegov & Mueller

# Classical YM equation

BASIC IDEA:  $\alpha_s = \alpha_s(Q_s) \ll 1 \Rightarrow$  SEMICLASSICS IS RELEVANT

McLerran & Venugopalan

$$D^\nu F_{\nu\mu} = \frac{\partial}{\partial A_\mu}(\text{sources})$$

Two methods of the solution on the market:

• Numerical simulations.

Venugopalan & Krasnitz

• Perturbative expansion in strength of one of the shock waves

McLerran et al, Kovchegov & Mueller

$\Leftrightarrow$  expansion in powers of commutators  $[U, V]$  (calculated up to  $[U, V]^2$ )

# The expansion in commutators

---

If  $[U, V] = 0$

$$\bar{A}_+ = \bar{A}_- = 0, \quad \bar{A}^i = \mathcal{U}_1^i \theta(x_+) + \mathcal{U}_2^i \theta(-x_+) + \mathcal{V}_1^i \theta(x_-) + \mathcal{V}_2^i \theta(-x_-)$$

= piece-wise pure gauge .

QED-like: no interaction  $\Rightarrow$  no particle production

# The expansion in commutators

---

If  $[U, V] = 0$

$$\bar{A}_+ = \bar{A}_- = 0, \quad \bar{A}^i = \mathcal{U}_1^i \theta(x_+) + \mathcal{U}_2^i \theta(-x_+) + \mathcal{V}_1^i \theta(x_-) + \mathcal{V}_2^i \theta(-x_-)$$

= piece-wise pure gauge .

QED-like: no interaction  $\Rightarrow$  no particle production

If  $[U, V] \neq 0$  one can take this ansatz

$$\bar{A}_+^{(0)} = \bar{A}_-^{(0)} = 0, \quad \bar{A}^{i(0)} = \mathcal{U}_1^i \theta(x_+) + \mathcal{U}_2^i \theta(-x_+) + \mathcal{V}_1^i \theta(x_-) + \mathcal{V}_2^i \theta(-x_-)$$

as a trial configuration for the classical solution and improve it order by order in  $[U, V]$  by calculating Feynman diagrams in the background of the trial configuration.



# The expansion in commutators

Solve the YM eqn for  $Q_\mu(x)$  by iterations  $\Leftrightarrow$  calculate Feynman diagrams in the external field  $\bar{A}^{(0)}$

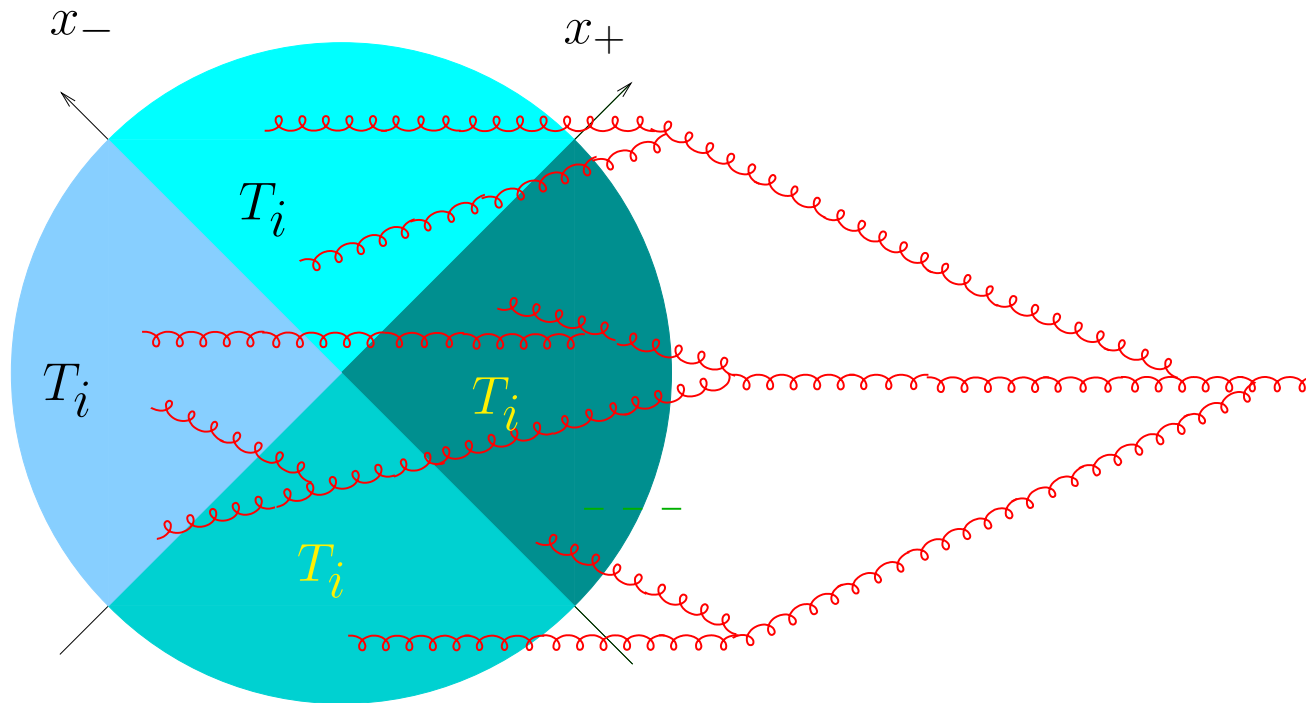

$T$  - linear term

$$T_\mu = D^\nu \bar{F}_{\nu\mu}^{(0)} - \frac{\partial}{\partial A_\mu} (\text{sources})$$

# Zero-order approximation: a piece-wise pure gauge field

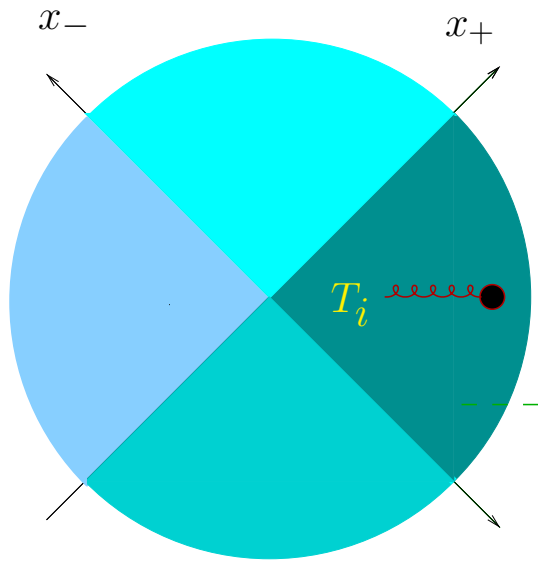

$$\bar{A}_+ = \bar{A}_- = 0$$

$$\begin{aligned} \bar{A}^i &= \mathcal{W}_F^i \theta(x_+) \theta(x_-) + \mathcal{W}_L^i \theta(-x_+) \theta(x_-) \\ &+ \mathcal{W}_R^i \theta(x_+) \theta(-x_-) + \mathcal{W}_B^i \theta(-x_+) \theta(-x_-) \end{aligned}$$

$$\mathcal{W}_F^i(x_\perp) = \mathcal{U}_1^i + \mathcal{V}_1^i + E_F^i = \text{pure gauge}$$

$$\mathcal{W}_L^i(x_\perp) = \mathcal{U}_2^i + \mathcal{V}_1^i + E_L^i = \dots$$

$$\mathcal{W}_R^i(x_\perp) = \mathcal{U}_1^i + \mathcal{V}_2^i + E_R^i = \dots$$

$$\mathcal{W}_B^i(x_\perp) = \mathcal{U}_2^i + \mathcal{V}_2^i + E_B^i = \dots$$

In the first order

$$E_i^a(x_\perp) = ig \int d^2 z (U_x U_z^\dagger + V_x V_z^\dagger - 1)^{ab} \frac{(x-z)_\perp^k}{2\pi^2 (x-z)_\perp^2} ([\mathcal{U}_i, \mathcal{V}_k]_z - i \leftrightarrow k)^b$$

$$\text{bF gauge } D^\mu Q_\mu = 0 \rightarrow (i\partial_i + g[\mathcal{U}_i + \mathcal{V}_i, \cdot]) E^i = 0$$

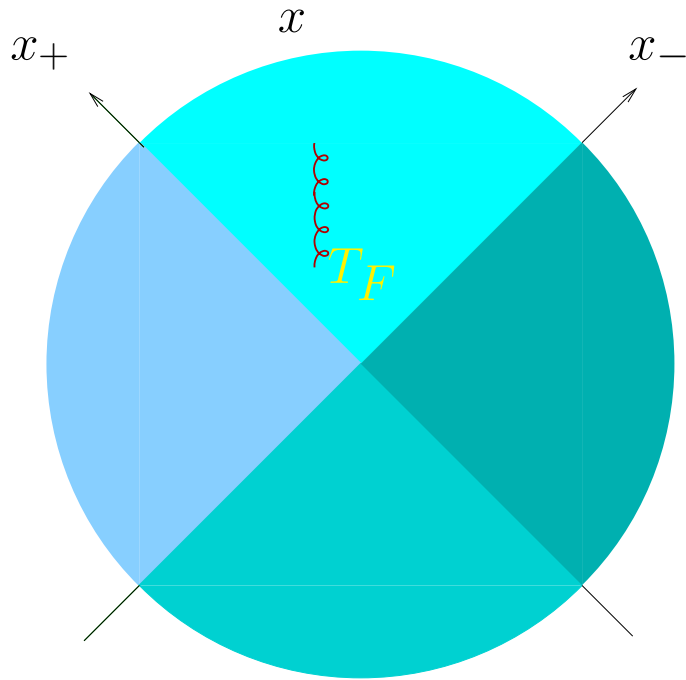

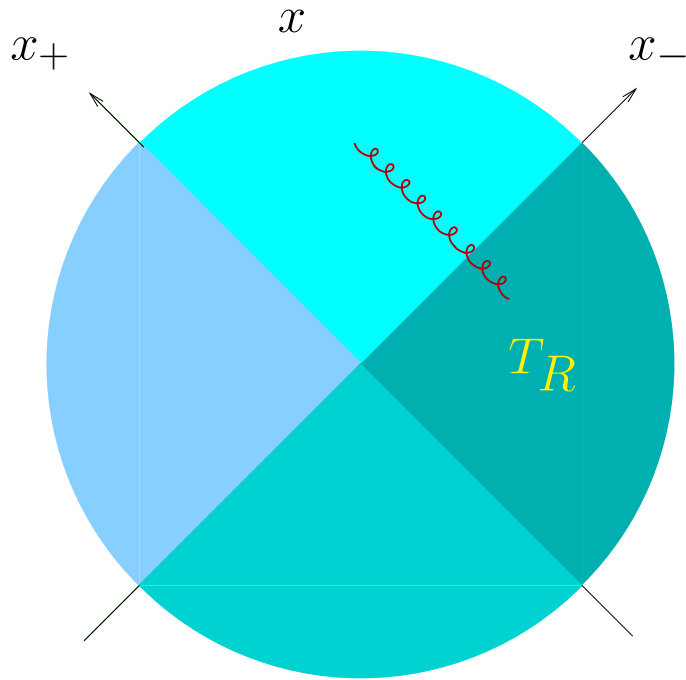

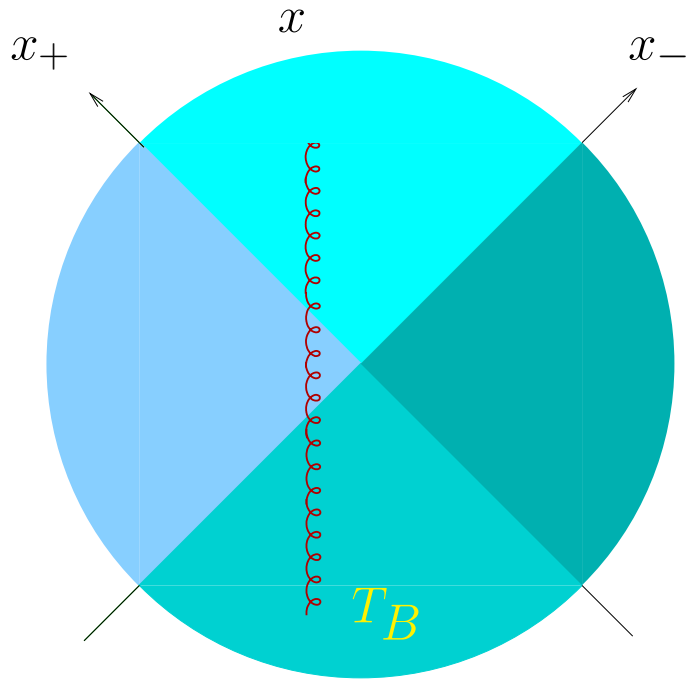

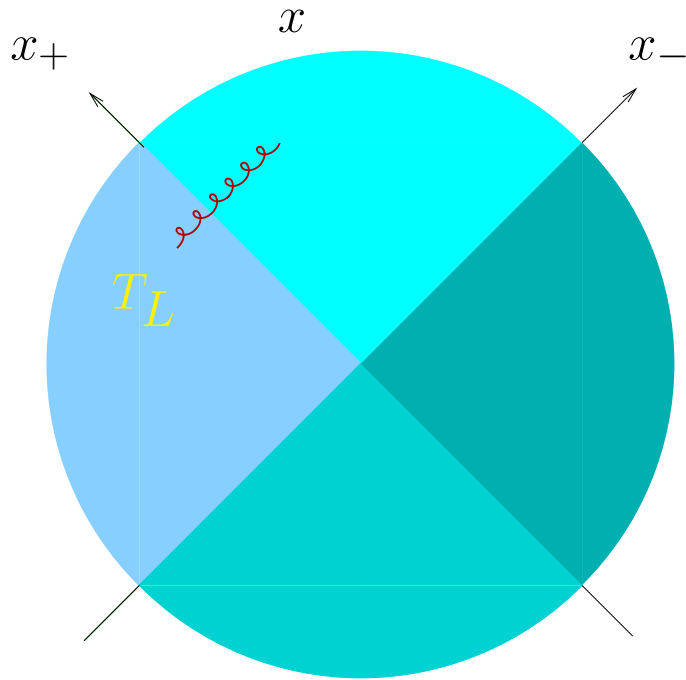

Lipatov vertex (effective vertex of gluon emission):

$$L_\mu^{(1)}(k) = k^2 Q_{(1)\mu}^{\mathcal{W}_F}(k) \Big|_{k^2=0} =$$
$$2E_\perp^\mu + 2\frac{p_1^\mu}{k_-} [\mathcal{V}_{1i} - \mathcal{V}_{2i}, E_R^i - E_2^i] + 2\frac{p_2^\mu}{k_+} [\mathcal{U}_{1i} - \mathcal{U}_{2i}, E_L^i - E_2^i]$$

Effective action = product of two Lipatov vertices.

In the  $[U, V]^2$  order

$$L_\mu^a L^{a\mu} = 4E_a^i E^{ai}$$

# The effective action

The trial configuration:

$$A_- = A_+ = 0 \text{ and}$$

$$A_i = \theta(x_+) \theta(x_-) \mathcal{W}_{Fi} + \theta(x_+) \theta(-x_+) \mathcal{W}_{Ri} \\ + \theta(-x_+) \theta(x_-) \mathcal{W}_{Li} + \theta(-x_+) \theta(-x_-) \mathcal{W}_{Bi}$$

In each of the four quadrants of the space the field is a pure gauge

$$\mathcal{W}_{Fi} = \mathcal{U}_{1i} + \mathcal{V}_{1i} + E_{Fi}$$

$$\mathcal{W}_{Li} = \mathcal{U}_{2i} + \mathcal{V}_{1i} + E_{Li}$$

$$\mathcal{W}_{Ri} = \mathcal{U}_{1i} + \mathcal{V}_{2i} + E_{Ri}$$

$$\mathcal{W}_{Bi} = \mathcal{U}_{2i} + \mathcal{V}_{2i} + E_{Fi}$$

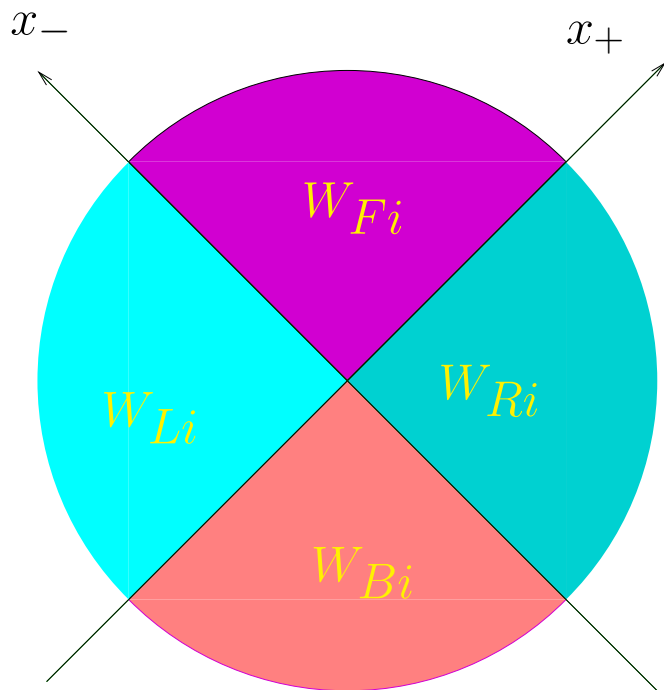



# The effective action

The trial configuration:

$$A_- = A_+ = 0 \text{ and}$$

$$A_i = \theta(x_+)\theta(x_-)\mathcal{W}_{Fi} + \theta(x_+)\theta(-x_+)\mathcal{W}_{Ri} \\ + \theta(-x_+)\theta(x_-)\mathcal{W}_{Li} + \theta(-x_+)\theta(-x_-)\mathcal{W}_{Bi}$$

In each of the four quadrants of the space the field is a pure gauge

$$\mathcal{W}_{Fi} = \mathcal{U}_{1i} + \mathcal{V}_{1i} + E_{Fi}$$

$$\mathcal{W}_{Li} = \mathcal{U}_{2i} + \mathcal{V}_{1i} + E_{Li}$$

$$\mathcal{W}_{Ri} = \mathcal{U}_{1i} + \mathcal{V}_{2i} + E_{Ri}$$

$$\mathcal{W}_{Bi} = \mathcal{U}_{2i} + \mathcal{V}_{2i} + E_{Fi}$$

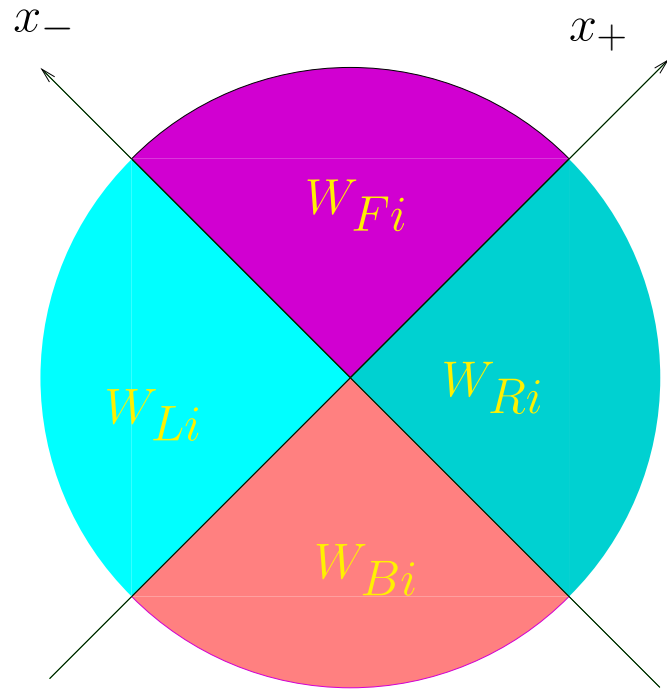

$$T_i = 2\delta(x_+)\delta(x_-)E_i \Rightarrow$$

$$S_{\text{eff}} = \int dz dz' T_i^a(z) G^{ab}(z, z') T^{bi}(z') \simeq \alpha_s \Delta \eta \int d^2 z_{\perp} E_i^a(z_{\perp}) E^{ai}(z_{\perp})$$

# Gauge-invariant form of the effective action

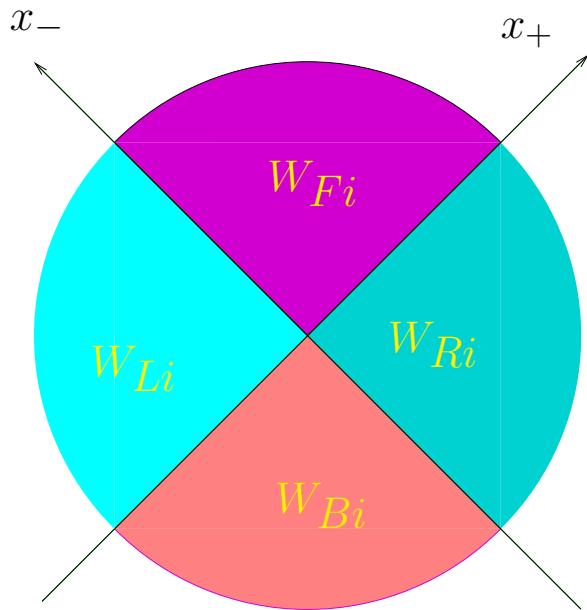

$$S_{\text{eff}}(V_1, V_2, U_1, U_2; \Delta\eta) = (\mathcal{V}_1 - \mathcal{V}_2)^{ai} (\mathcal{U}_1 - \mathcal{U}_2)_i^a + \frac{\alpha_s \Delta\eta}{4} L_i^a L^{ai}$$

$$\begin{aligned} L_i^a &= 2(\mathcal{W}_F - \mathcal{W}_L - \mathcal{W}_R + \mathcal{W}_B)_i^a \\ &= 2(E_F - E_L - E_R + E_B)_i^a \end{aligned}$$

# Gauge-invariant form of the effective action

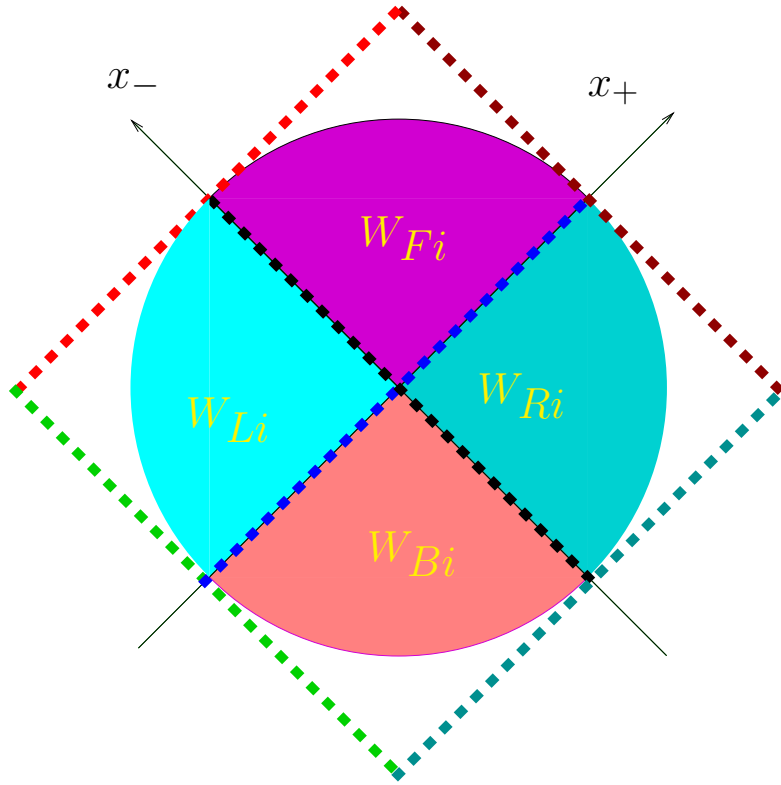

$$S_{\text{eff}}(V_1, V_2, U_1, U_2; \Delta\eta) = (\mathcal{V}_1 - \mathcal{V}_2)^{ai} (\mathcal{U}_1 - \mathcal{U}_2)_i^a + \frac{\alpha_s \Delta\eta}{4} L_i^a L^{ai}$$

$$L_i^a = 2(\mathcal{W}_F - \mathcal{W}_L - \mathcal{W}_R + \mathcal{W}_B)_i^a = 2(E_F - E_L - E_R + E_B)_i^a$$

Gauge invariant representation (HIMST):

$$\frac{1}{4} L^{ai} L_i^a = \text{tr}[\infty p_1, F_{-i}, -\infty p_1]_{\infty p_2} [\infty p_2, F_{+i}, -\infty p_2]_{\infty p_1} \times [\infty p_1, -\infty p_1]_{-\infty p_2} [-\infty p_2, \infty p_2]_{-\infty p_1} + \text{cyclic perm.}$$

$$[\infty p_1, F_{-i}, -\infty p_1] \equiv \int_{-\infty}^{\infty} du [\infty p_1, up_1] F_{-i}(up_1) [up_1, -\infty p_1]$$

# Gauge-invariant form of the effective action

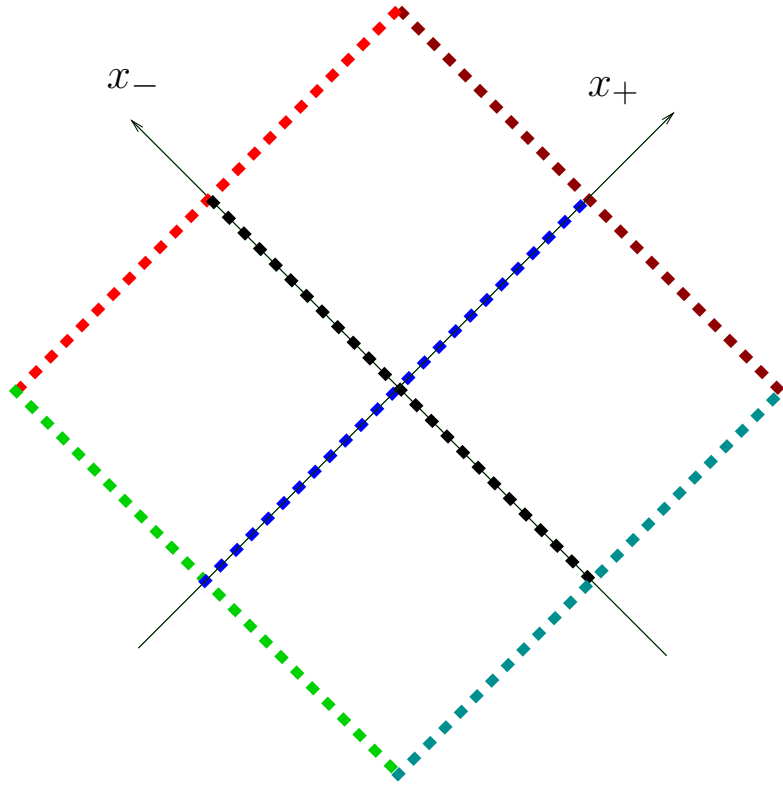

$$S_{\text{eff}}(V_1, V_2, U_1, U_2; \Delta\eta) = (\mathcal{V}_1 - \mathcal{V}_2)^{ai} (\mathcal{U}_1 - \mathcal{U}_2)_i^a + \frac{\alpha_s \Delta\eta}{4} L_i^a L^{ai}$$

$$L_i^a = 2(\mathcal{W}_F - \mathcal{W}_L - \mathcal{W}_R + \mathcal{W}_B)_i^a = 2(E_F - E_L - E_R + E_B)_i^a$$

Gauge invariant representation (HIMST):

$$\frac{1}{4} L^{ai} L_i^a = \text{tr}[\infty p_1, F_{-i}, -\infty p_1]_{\infty p_2} [\infty p_2, F_{+i}, -\infty p_2]_{\infty p_1} \times [\infty p_1, -\infty p_1]_{-\infty p_2} [-\infty p_2, \infty p_2]_{-\infty p_1} + \text{cyclic perm.}$$

$$[\infty p_1, F_{-i}, -\infty p_1] \equiv \int_{-\infty}^{\infty} du [\infty p_1, up_1] F_{-i}(up_1) [up_1, -\infty p_1]$$

# Functional integral over the Wilson-line variables

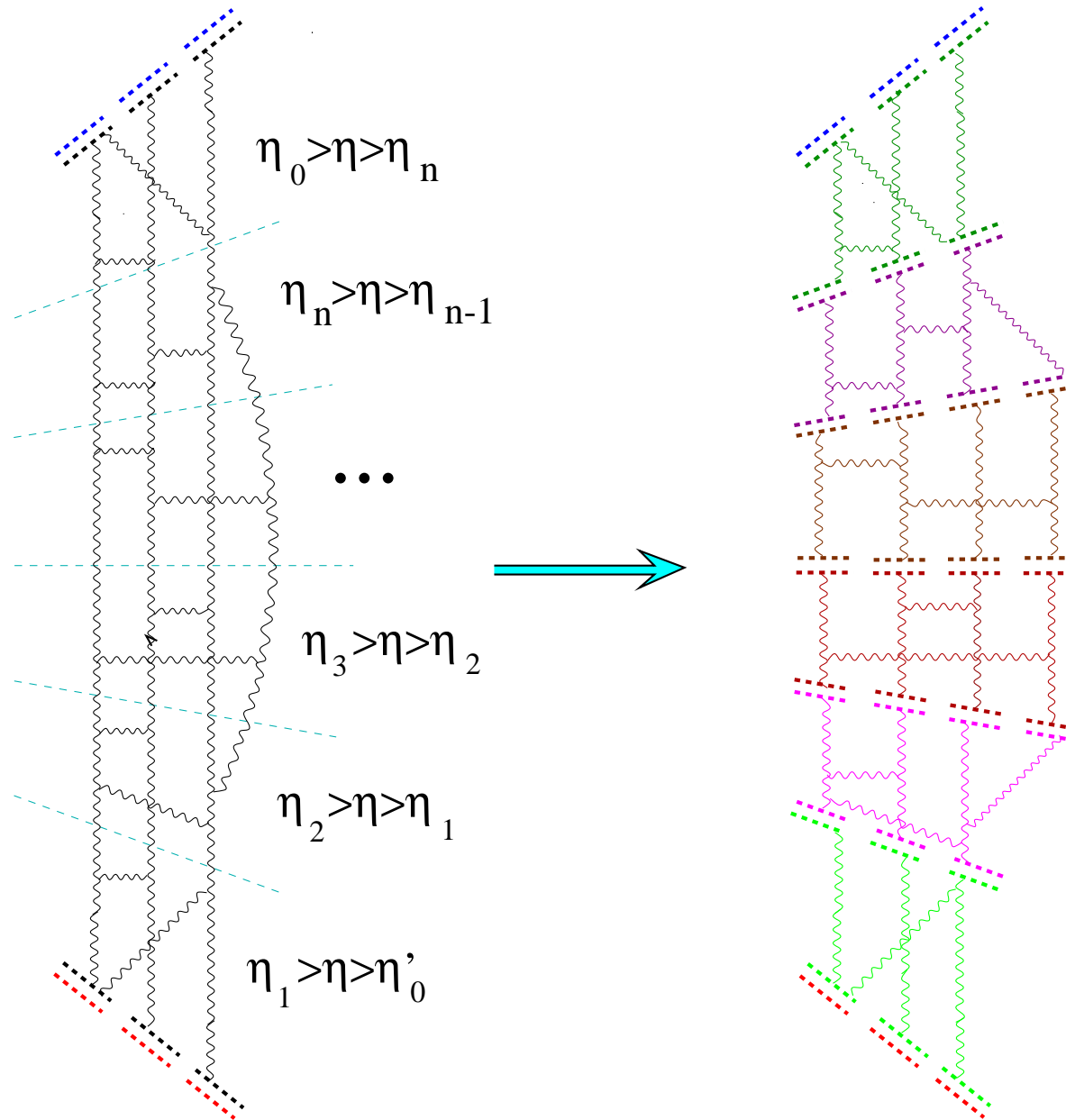

# Functional integral over the Wilson-line variables

$$e^{iS_{\text{eff}}(U_1, U_2, V_1, V_2; \eta_1 - \eta_2)} = \int_{U_{\eta_2} = U} DU_{1x}^\eta DU_{2x}^\eta DV_{1x}^\eta DV_{2x}^\eta e^{i \int d^2 x_\perp [(\mathcal{V}_1 - \mathcal{V}_2)_i^a (\mathcal{U}_1^{\eta_1} - \mathcal{U}_2^{\eta_1})^{ai} + \int_{\eta_2}^{\eta_1} d\eta \mathcal{L}(U_1, U_2, V_1, V_2, \eta)]}$$

$$\mathcal{L}(U_k, V_k, \eta) = -(\mathcal{V}_1^\eta - \mathcal{V}_2^\eta)_i^a \frac{\partial}{\partial \eta} (\mathcal{U}_1^\eta - \mathcal{U}_2^\eta)^{ai} - i \frac{\alpha_s}{4} L_i^a(U, V) L^{ai}(U, V) \}$$

$L_i$  is local in terms of  $W$ 's but unfortunately non-local in terms of  $U$  and  $V$ .

This formula contains both “upside down” and “bottom up” small- $x$  “fan” evolutions  $\Rightarrow$  pomeron loops

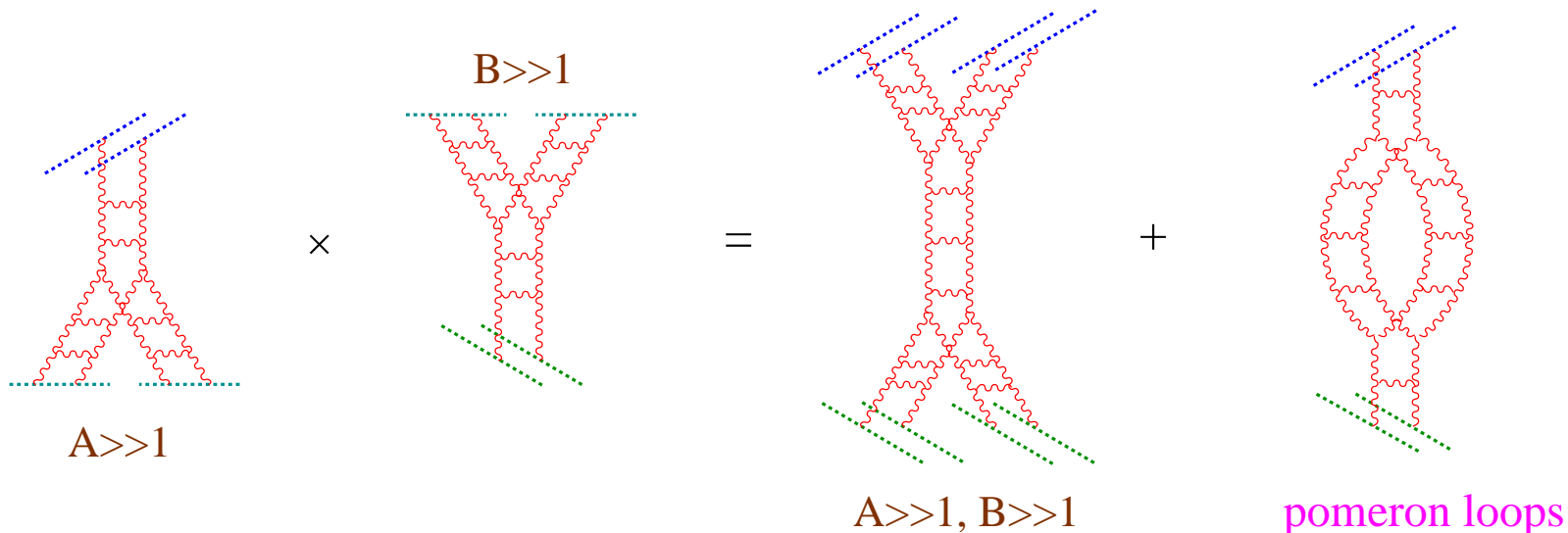

- High-energy hadron-hadron scattering  $\Leftrightarrow$  collision of two QCD shock waves (Color Glass Condensates?)
- For two nuclei, A and B, the expansion in commutators of Wilson lines is a symmetric expansion in both  $\frac{B}{A}$  or  $\frac{A}{B}$  parameters.
- $\mathcal{L}(U, V) \ni$  pomeron loops ( $\Rightarrow$  unitarity?)

- High-energy hadron-hadron scattering  $\Leftrightarrow$  collision of two QCD shock waves (Color Glass Condensates?)
- For two nuclei, A and B, the expansion in commutators of Wilson lines is a symmetric expansion in both  $\frac{B}{A}$  or  $\frac{A}{B}$  parameters.
- $\mathcal{L}(U, V) \ni$  pomeron loops ( $\Rightarrow$  unitarity?)

## Outlook

- The  $[U, V]^2$  term in  $\mathcal{L}$
- Big Q: What is the field produced by the collision (in all orders in  $[U, V]$ )?
- $\Leftrightarrow$  Big Q:  $S_{\text{eff}}$  in (in all orders in  $[U, V]$ ) ?



An example of Feynman diagram not taken into account by the diamond action

