

COPY NO. PR 423

**Vol 2**

**COUNTERMEASURES TO PROTECT BRIDGE PIERS  
FROM SCOUR**

**FINAL REPORT**

Prepared for  
National Cooperative Highway Research Program  
Transportation Research Board  
National Research Council

**NCHRP 24-7**

**Gary Parker, Carlos Toro-Escobar, Richard L. Voigt, Jr.  
St. Anthony Falls Laboratory, University of Minnesota  
Minneapolis, Minnesota**

**In Cooperation with**

**Bruce W. Melville, Anna Hadfield, and Christine Lauchlan, University of Auckland,  
Auckland, New Zealand**

**Yee-Meng Chiew, Nanyang Technological University, Singapore**

**Arthur C. Parola and D. Joseph Hagerty, University of Louisville, Kentucky**

**December 1998**

The University of Minnesota is committed to the policy that all persons shall have equal access to its programs, facilities, and employment without regard to race, religion, color, sex, national origin, handicap, age or veteran status

Prepared for: NCHRP  
Date Submitted: May 30, 1998  
Last Revised: Jan. 8, 1999  
Disk Locator: Zip Drives NCHRP #4; Rev-Final; VOL1-REVx; VOL1-fronts; Titlepg-v1  
CH1-INTRrv, CH2Country, CH2-LITrv, CH2-WORKrv, CH3-SAF1rv-SAF8rv, CH4-AUP1rv-AUP3rv,  
CH5-NANYrv, CH6-SUMrv, CH7-FIELDrv, CH8-GABrv, CH8Designrv, Front-2rv, Refsectrv,  
TITLEPG-v1,v2, ToC-v1,v2.

### Acknowledgment

This work was sponsored by the American Association of State Highway and Transportation, in cooperation with the Federal Highway Administration, and was conducted in the National Cooperative Highway Research Program which is administered by the Transportation Research Board of the National Research Council.

### Disclaimer

This copy is an uncorrected draft as submitted by the research agency. A decision concerning acceptance by the Transportation Research Board, and publication in the regular NCHRP series will not be made until a complete technical review has been made and discussed with the researchers. The opinions and conclusions expressed or implied in the report are those of the research agency. They are not necessarily those of the Transportation Research Board, the National Research Council, the Federal Highway Administration, the American Association of State Highway and Transportation Officials, or of the individual states participating in the National Cooperative Highway Research Program.



## ABSTRACT

This report is in fulfillment of NCHRP Project 24-7, Countermeasures to Protect Bridge Piers from Scour. The focus of the report concerns alternatives to standard riprap installations as pier scour countermeasures. Two kinds of countermeasures were examined: flow altering countermeasures such as sacrificial piles and armoring countermeasures such as mattresses of cable tied blocks. None of the flow altering countermeasures were found to be overly effective. Under flood conditions in sand bed streams, riprap placed in the absence of a geotextile or granular filter layer was found to gradually settle and lose effectiveness over time even under conditions for which the riprap is never directly mobilized by the flow. This settling is due to deformation and leaching of sand associated with the passage of bedforms. Riprap performance can be considerably improved with the use of a geotextile, especially if the geotextile is sealed to the pier. Another countermeasure that provides excellent protection is a mattress of cable tied blocks underlain by a geotextile tied to the pier. Design suggestions are provided for a number of armoring countermeasures.

## **ACKNOWLEDGEMENTS**

Pat Swanson, Senior Editor at St. Anthony Falls Laboratory, put in many hours above and beyond the call of duty to prepare this report. Benjamin Erickson, Assistant Scientist, spent extensive hours formatting photographs, figures and the supplementary videotape associate with this report. The authors sincerely thank the many personnel of various state departments of transportation for their time and help in regard to bridge scour and countermeasures.

# TABLE OF CONTENTS - VOL. 1

ABSTRACT .....	i
ACKNOWLEDGMENTS.....	ii
TABLE OF CONTENTS - VOL. 1 .....	iii
TABLE OF CONTENTS - VOL. 2 .....	v
LIST OF FIGURES.....	ix
1. INTRODUCTION .....	1
2. DESIGN RECOMMENDATIONS FOR SELECTED COUNTERMEASURES.....	2
2.1 IMPLEMENTATION NOTES FOR GEOTEXTILE FILTERS AND GRANULAR FILTER LAYERS.....	3
2.2 COUNTERMEASURE DESIGN GUIDELINES .....	5
2.2.1 <i>Design Recommendations for Riprap with Prior Excavation and with Geotextile or Granular Filter.....</i>	5
2.2.2 <i>Design Recommendations for Riprap Without Prior Excavation but with Geotextile or Granular Filter.....</i>	9
2.2.3 <i>Design Recommendations for Riprap Without Prior Excavation, Without Geotextile or Granular Filter.....</i>	13
2.2.4 <i>Design Recommendations for Cable Tied Blocks .....</i>	15
2.2.5 <i>Design Recommendations for Grout Filled Bags.....</i>	19
2.2.6 <i>Design Recommendations for Gabions .....</i>	22
3. REFERENCES .....	26
APPENDIX A. NOTATIONS.....	27

## TABLE OF CONTENTS – VOL. 2

ABSTRACT .....	i
ACKNOWLEDGMENTS .....	ii
TABLE OF CONTENTS – VOL. 1.....	iii
TABLE OF CONTENTS - VOL. 2 .....	iv
LIST OF FIGURES.....	ix
LIST OF TABLES.....	xv
EXECUTIVE SUMMARY .....	xviii
<b>1. INTRODUCTION AND RESEARCH APPROACH .....</b>	<b>1</b>
1.1 THE RESEARCH APPROACH .....	1
1.2 GUIDE TO THIS VOLUME.....	1
1.3 THE RESEARCH TEAM .....	2
<b>2. LITERATURE REVIEW, COUNTERMEASURE SCREENING AND WORK PLANS.....</b>	<b>3</b>
SUMMARY OF CHAPTER.....	3
2.1 LITERATURE REVIEW .....	3
2.1.1 <i>Introduction to Literature Review</i> .....	3
2.1.2 <i>Scour Around Bridge Piers</i> .....	3
2.1.3 <i>The Use of Riprap as a Scour Countermeasure</i> .....	4
2.1.4 <i>Alternatives to Riprap</i> .....	8
2.1.4a <i>Armoring Countermeasures</i> .....	9
2.1.4b <i>Flow Altering Countermeasures</i> .....	18
2.1.5 <i>Conclusion</i> .....	24
2.2 COUNTERMEASURE SELECTION AND SCREENING .....	25
2.2.1 <i>Introduction</i> .....	25
2.2.2 <i>Screening Approach</i> .....	25
2.2.2a <i>Definitions for Screening Criteria</i> .....	26
2.2.3 <i>Descriptive Summary of the Rating for each Countermeasure</i> .....	29
2.2.4 <i>Survey Highlights</i> .....	34
2.3 WORK PLANS .....	56
2.3.1 <i>Prioritization of Countermeasures</i> .....	56
2.3.1a <i>Excluded Countermeasures</i> .....	56
2.3.1b <i>High-Priority Countermeasures</i> .....	57
2.3.1c <i>Medium-Priority Countermeasures</i> .....	57
2.3.1d <i>Low-Priority Countermeasures</i> .....	57
2.3.2 <i>Armoring Countermeasures</i> .....	59
2.3.2a <i>Standard Riprap</i> .....	59
2.3.2b <i>Anchors</i> .....	62
2.3.2c <i>Artificial Riprap</i> .....	65
2.3.2d <i>Cable Tied Blocks</i> .....	69
2.3.2e <i>Gabions and Reno Mattresses</i> .....	73
2.3.2f <i>High Density Riprap</i> .....	76
2.3.2g <i>Pavement</i> .....	79
2.3.2h <i>Rock Bolting</i> .....	81

2.3.2i Sacked Concrete .....	84
2.3.3 <i>Flow Altering Countermeasures</i> .....	87
2.3.3a Collars and Horizontal Plates .....	87
2.3.3b Flow-deflecting Vanes or Plates .....	89
2.3.3c Permeable Sheet Piles .....	92
2.3.3d Sacrificial Piles .....	95
2.3.3e Slot in Pier.....	98
2.3.3f Suction Applied to Pier .....	100
2.3.4 <i>Implementation</i> .....	103
2.3.4a Overview.....	103
2.3.4b Work Plan for St. Anthony Falls Laboratory.....	103
2.3.4c Work Plan for University of Auckland .....	104
2.3.4d Future Extension of the Work.....	105
<b>3. EXPERIMENTAL INVESTIGATIONS AT ST. ANTHONY FALLS LABORATORY.....</b>	<b>106</b>
3.1. OVERVIEW OF CHAPTER .....	106
3.2 BASIC NOTATION.....	107
3.3 MODEL SEDIMENT AND RIPRAP .....	111
3.4 RUN PROTOCOL .....	112
3.5 SUMMARY OF RUNS PERFORMED AT ST. ANTHONY FALLS LABORATORY .....	116
3.6 EXPERIMENTAL RESULTS.....	118
3.6.1 <i>Calibration Runs</i> .....	118
3.6.2 <i>Runs with No Protection</i> .....	118
3.6.3 <i>Runs with the Original Coarse Riprap</i> .....	126
3.6.4 <i>Runs with the Standard (modified) Riprap</i> .....	132
3.6.5 <i>Runs with Riprap and Partial Geotextile</i> .....	136
3.6.6 <i>Runs with Dumped Riprap</i> .....	144
3.6.7 <i>Runs to Test Geotextile Placement</i> .....	147
3.6.8 <i>Runs with Cable Tied Blocks</i> .....	149
3.6.9 <i>Runs with Grout Filled Bags</i> .....	162
3.6.10 <i>Runs with Permeable Sheet Piles</i> .....	170
3.6.11 <i>Runs with Pier Attached Vanes</i> .....	175
3.6.12 <i>Combination Runs with Cable Tied Blocks and Riprap</i> .....	178
3.6.13 <i>Combination Runs with Permeable Sheet Piles and Riprap</i> .....	182
<b>4. EXPERIMENTAL INVESTIGATIONS AT THE UNIVERSITY OF AUCKLAND .....</b>	<b>185</b>
4.1 EXPERIMENTAL FACILITIES AND SETUP .....	185
4.2 SUMMARY OF RUNS PERFORMED AT THE UNIVERSITY OF AUCKLAND.....	186
4.3 EXPERIMENTS ON RIPRAP PERFORMANCE .....	187
4.3.1 <i>Introduction</i> .....	187
4.3.2 <i>General Failure Mechanisms and Placement Effects</i> .....	188
4.3.3 <i>Thickness Effects</i> .....	194
4.3.4 <i>Flow Depth</i> .....	198
4.3.5 <i>Geotextiles</i> .....	199
4.3.5a Experiments in the 0.44 m Wide Flume.....	199
4.3.5b Experiments in the 1.52 m Wide Flume .....	205
4.3.6 <i>Degradation</i> .....	206
4.4 EXPERIMENTS ON SACRIFICIAL PILES .....	213
4.4.1 <i>Introduction</i> .....	213
4.4.2 <i>Experimental Apparatus</i> .....	215
4.4.3 <i>Experimental Technique</i> .....	216
4.4.4 <i>Summary of Results</i> .....	217
4.5 EXPERIMENTS ON SUBMERGED VANES (IOWA VANES) .....	222
4.5.1 <i>Introduction</i> .....	222
4.5.2 <i>Clear Water Experiments - Type I Vanes</i> .....	229

4.5.2a	Observations and the Effects of Vane and Layout Parameters.....	231
4.5.3	<i>Mobile Bed Experiments - Type I Vanes</i> .....	232
4.5.4	<i>Mobile Bed Experiments - Type II Vanes</i> .....	234
4.5.5	<i>Conclusions</i> .....	236
<b>5.</b>	<b>EXPERIMENTAL INVESTIGATIONS AT NANYANG TECHNOLOGICAL UNIVERSITY</b> .	<b>238</b>
5.1	INTRODUCTION .....	238
5.2	EXPERIMENTAL FACILITIES AND SETUP .....	238
5.3	EXPERIMENTS ON RIPRAP .....	241
<b>6.</b>	<b>SUMMARY OF THE EXPERIMENTAL RESULTS</b> .....	<b>246</b>
6.1	OVERVIEW OF CHAPTER .....	246
6.2	NOTES CONCERNING THE USE OF A GEOTEXTILE FILTER OR GRANULAR FILTER LAYER .....	246
6.2.1	<i>Riprap</i> .....	248
6.2.2	<i>Cable Tied Blocks</i> .....	249
6.2.3	<i>Grout Filled Bags</i> .....	249
6.2.4	<i>Sacrificial Piles</i> .....	249
6.2.5	<i>Iowa Vanes</i> .....	249
6.2.6	<i>Permeable Sheet Piles</i> .....	249
6.2.7	<i>Combination: Riprap and Permeable Sheet Piles</i> .....	250
6.2.8	<i>Combination: Cable Tied Blocks and Riprap</i> .....	250
6.2.9	<i>High Density Riprap</i> .....	250
6.2.10	<i>Notes on Gravel Bed Streams</i> .....	250
<b>7.</b>	<b>FIELD SURVEY</b> .....	<b>251</b>
7.1	INTRODUCTION.....	251
7.2	KEY FINDINGS .....	256
7.3	NORTH CAROLINA.....	259
7.3.1	<i>US 13 Tar River Bridge in Pitt County</i> .....	259
7.3.2	<i>Highway 11 Contentnea Creek Bridge in Lenoir County</i> .....	259
7.3.3	<i>US 421 Muddy Creek Bridge in Forsyth County</i> .....	260
7.3.4	<i>Highway 8 Town Creek Bridge in Stokes County</i> .....	260
7.4	SOUTH CAROLINA .....	261
7.4.1	<i>Smith Branch Bridge in Columbia</i> .....	261
7.4.2	<i>I-26 South Tyger River Bridge in Spartanburg County</i> .....	262
7.4.3	<i>Enoree River Deyoung Bridge</i> .....	263
7.5	ARIZONA AND CALIFORNIA .....	263
7.6	ARIZONA .....	263
7.6.1	<i>Pima County Bridges</i> .....	264
7.6.2	<i>I-10 Gila River Bridge Southeast of Phoenix</i> .....	265
7.6.3	<i>Highway 587 Gila River Bridge</i> .....	265
7.6.4	<i>Highway 87 Gila River Bridge near Olberg</i> .....	266
7.6.5	<i>Gila River Indian Reservation Bridge</i> .....	266
7.6.6	<i>Santa Cruz River Bridges South of Tucson</i> .....	266
7.6.7	<i>Rillito Creek Bridges Northwest of Tucson</i> .....	267
7.6.8	<i>Ina Road Bridge over Santa Cruz River</i> .....	268
7.6.9	<i>Santa Cruz River Avra Valley Road Bridge Northwest of Tucson</i> .....	268
7.6.10	<i>Arizona 95 Colorado River Bridge at Parker</i> .....	269
7.7	CALIFORNIA .....	269
7.7.1	<i>I-5 Sacramento River Bridge and I-880 Guadalupe River Bridge near San Jose</i> .....	270
7.7.2	<i>I-80 Ulatis Creek Bridge in Solano County</i> .....	270
7.7.3	<i>I-80 Sweeney Creek Bridge in Solano County</i> .....	271
7.7.4	<i>CA 128 Apricot Draw Bridge near Winters</i> .....	271
7.7.5	<i>I-505 Cache Creek Bridge in Yolo County</i> .....	272

7.7.6	I-880 Guadalupe River Bridge in North of San Jose .....	273
7.7.7	Conn Creek Silverado Trail Bridge in Napa County .....	275
7.7.8	Highway 160 American River Bridge .....	275
7.7.9	Highway 32 Stony Creek Bridge .....	275
7.7.10	Yolo County Road 99W Buckeye Creek Bridge near Dunigan .....	276
7.8	MAINE .....	276
7.8.1	I-295 Tukeys Bridge in Portland .....	276
7.9	MASSACHUSETTS .....	277
7.9.1	Route 13 North Nashua River Bridge in Leominster .....	277
7.9.2	Blackstone River Depot Street Bridge in Grafton .....	278
7.9.3	Neponset River Dedham Street Bridge in Canton .....	278
7.10	CONNECTICUT .....	279
7.10.1	Naugatuck River Division Street Bridge in Ansonia .....	279
7.11	MARYLAND .....	281
7.11.1	Dickerson Run Bridge 6007 in Carroll County .....	281
7.11.2	Little Pipe Creek Bridge 6006 in Carroll County .....	281
7.11.3	Copps Creek Bridge 6055 in Carroll County .....	281
7.11.4	Big Pipe Creek Bridge 6025 near Taneytown .....	281
7.11.5	Beaver Branch Bridge 10054 in Frederick County .....	282
7.11.6	Israel Creek Bridge 10094 in Frederick County .....	282
7.11.7	Montgomery County Bridge .....	282
7.11.8	Little Monocacy River Bridge 15070 in Montgomery County .....	283
7.11.9	Peggy's Run Bridge 3080 in Baltimore County .....	283
7.11.10	James Run Bridge 12009 in Harford County .....	283
7.11.11	Summary on Bridge Scour in Maryland .....	284
7.12	PENNSYLVANIA .....	285
7.12.1	Schuylkill River Vine Street Bridge in Philadelphia .....	285
7.12.2	PA 36 Bear Run Bridge in Clearfield County .....	286
7.12.3	US 219 Bear Run in Clearfield County .....	287
7.12.4	PA 4010 Sugar Creek in Bradford County .....	288
7.12.5	PA 4014 Leonard's Creek Bridge in Bradford County .....	288
7.12.6	PA 4027 Buck's Creek Bridge in Bradford County .....	288
7.12.7	PA 3019 Sugar Creek Bridge in Bradford County .....	289
7.12.8	PA Route 3035 Sugar Creek Bridge in Bradford County .....	290
7.12.9	Route 6 Sugar Creek Bridge in Bradford County .....	290
7.12.10	Towanda Creek Bridge 3008 in Bradford County .....	291
7.12.11	Highway Segments along PA 414 .....	291
7.12.12	Route 0220 South Towanda Creek Bridge .....	292
7.12.13	Route 2014 Loyalsock Creek Bridge in Montoursville .....	292
7.12.14	Route 15 Lycoming Creek Bridge in Lycoming County .....	292
7.12.15	Route 4003 Fishing Creek Bridge near Bloomsburg .....	293
7.13	WASHINGTON .....	293
7.13.1	US 12 Rainey Creek Bridge near Randle .....	293
7.13.2	US 12 Cowlitz River Bridge East of Randle .....	294
7.13.3	US 12 Naches River Bridge West of Naches .....	295
7.13.4	WA 24 Yakima River Bridge at Yakima .....	296
7.13.5	US 97 Toppenish Creek Bridge South of Toppenish .....	296
7.13.6	WA 240 Yakima River Bridge near Richland .....	297
7.14	OREGON .....	297
7.14.1	Willamette River Banks in Salem .....	298
7.14.2	OR 22 Gooseneck Creek Bridge near Buell .....	298
7.14.3	OR 58 Salmon Creek Bridge at Oakridge .....	299
7.14.4	Coquille River State Highway Bridge in Coos County .....	300
7.15	TENNESSEE .....	301

7.15.1 Hatchie River Bridge in Jackson.....	301
7.15.2 Bridges near Memphis, Hardin County, and Humphreys County.....	302
7.15.3 Nonconnah Creek Route 175 Bridge.....	303
7.15.4 Nonconnah Creek Quince Road Bridge near Memphis.....	304
7.15.5 Nonconnah Creek Perkins Road Bridge in Shelby County.....	305
7.15.6 I-40 Wolf River Bridge in Shelby County.....	305
7.15.7 US 51 Wolf River Bridge.....	306
7.15.8 US 51 Hatchie River Bridge in Tipton County.....	306
7.15.9 Route 19 Relief Bridge at Shoaf's Island in Lauderdale County.....	306
7.16 FLORIDA.....	307
7.17 MISSISSIPPI.....	307
7.18 ALABAMA.....	308
7.18.1 I-65 Bridge South of Huntsville.....	308
7.19 NEW YORK.....	308
7.19.1 NY 17 Susquehanna River Bridge (Bin 1054831/2).....	308
7.19.2 NY 26 Susquehanna River Bridge (Bin 10118431/2).....	308
7.19.3 Route 23 Otselic River Bridge (Bin 3312170).....	309
7.19.4 Route 25 Otselic River Bridge (Bin 1018700).....	309
7.19.5 Susquehanna River Main Street Bridge in Oneonta (Bin 1095269).....	309
7.19.6 Route 23 Bridge in Oneonta (Bin 1095269).....	310
7.19.7 NY 443 Embankment along Fox Creek (Near Zimmer Road).....	310
7.19.8 Route 30 Bridge at Sacandaga Reservoir (Bin 1031170).....	311
7.19.9 Stony Clove Creek Silver Hollow Road Bridge.....	311
<b>8. INTERPRETATION, APPRAISAL, APPLICATIONS.....</b>	<b>312</b>
8.1 CHAPTER SUMMARY.....	312
8.2 GABIONS AND RENO MATTRESSES.....	312
8.2.1 Durability: Gabions and Reno Mattresses.....	312
8.2.2 Specifications: Gabions and Reno Mattress, Zinc Coated.....	313
8.2.3 Specifications: Gabions, Galvanized and PVC Coated.....	315
<b>9. REFERENCES.....</b>	<b>344</b>
<b>APPENDIX A - DATA TABLES.....</b>	<b>A-1</b>
<b>APPENDIX B. GUIDE TO VIDEO ON BRIDGE SCOUR.....</b>	<b>B-1</b>
<b>APPENDIX C. NOTATIONS.....</b>	<b>C-1</b>



## LIST OF FIGURES

Figure 2.1.	Riprap.....	4
Figure 2.2.	Gabions.....	10
Figure 2.3.	Grout filled bags.....	12
Figure 2.4	Cable tied block mattress.....	14
Figure 2.5	Tetrapods and related units.....	16
Figure 2.6	Sacrificial piles.....	18
Figure 2.7	Upstream sheet pile.....	20
Figure 2.8	Collar.....	20
Figure 2.9	Iowa vanes.....	21
Figure 2.10	Vertical plates.....	22
Figure 2.11	Delta wing plates.....	22
Figure 2.12	Pier attached vanes.....	23
Figure 2.13	Summary of average rankings.....	30
Figure 2.14	Artificial riprap.....	66
Figure 2.15	Cable tied blocks.....	70
Figure 2.16	Grout filled bags.....	85
Figure 2.17	Sacrificial piles in a triangular array.....	95
Figure 2.18	Suction at pier.....	101
Figure 3.1	Schematic diagram of the Main Channel facility.....	108
Figure 3.2	a) View of the Main Channel Facility looking upstream. b) View of the main channel facility during an experiment.....	109
Figure 3.3	Schematic diagram of the Tilting Flume facility.....	109
Figure 3.4	a) View of the Tilting Flume facility looking upstream. b) View of the Tilting Flume facility looking downstream.....	110
Figure 3.5	Grain size distributions of the sediment and riprap.....	111
Figure 3.6a	Results for unprotected scour at circular piers.....	121
Figure 3.6b	Results for unprotected scour at rectangular piers.....	122
Figure 3.6c	Comparison of data for unprotected scour with the Colorado State University predictor.....	122
Figure 3.7a	View of the Tilting Flume at the end of Run 4 of TC-NP1, showing prominent dunes and scour near the circular pier.....	124
Figure 3.7b	View of the Tilting Flume at the end of Run 4 of TC-NP1, showing the deep scour realized near the rectangular pier.....	125

Figure 3.8	a) Sketch of placement of riprap around a circular pier. b) Sketch of placement of riprap around a rectangular pier.....	126
Figure 3.9	a) View of riprap placement around the cylindrical pier in the Main Channel. b) View of riprap placement around the rectangular pier in the Main Channel. ....	127
Figure 3.10	a) View of riprap placement around the cylindrical pier in the Tilting Flume. b) View of riprap placement around the rectangular pier in the Tilting Flume.....	127
Figure 3.11	a) Side view of the rectangular pier at the end of Run 4 of series TF-RR1. b) View of the same rectangular pier looking upstream. c) View looking upstream of the rectangular pier at the end of Run 4 of series TF-RR2. ....	130
Figure 3.12	Performance of the riprap in series TF-RR1 and TF-RR2. ....	131
Figure 3.13	Performance of the riprap in series MC-RNG and TF-RNG. ....	133
Figure 3.14	View of the rectangular pier at the end of Run 3 of series MC-RNG. ....	134
Figure 3.15	a) View of the rectangular pier at the end of Run 4, series TF-RNG. b) View of the cylindrical pier at the end of Run 4 of series TF-RNG. c) View of the cylindrical pier at the end of Run 4 of series MC-RNG. d) View of the rectangular pier at the end of Run 4 of series MC-RNG.....	135
Figure 3.16a	Sketch of placement of geotextile around a circular pier.....	136
Figure 3.16b	Sketch of placement of geotextile around a rectangular pier.....	137
Figure 3.17	a) View of geotextile and riprap placement around the cylindrical pier for series MC-RPG. b) View of geotextile and riprap placement around the rectangular pier for series MC-RPG. ....	138
Figure 3.18	Performance of the riprap with partial geotextile for series MC-RPG and TC-RPG.....	140
Figure 3.19	a) View of the rectangular pier at the end of Run 3 of series MC-RPG, showing the excellent performance of the riprap in anchoring the geotextile. b) View of the excavated sand bed in front of the rectangular pier at the end of Run 3 of series MC-RPG, showing how riprap settling anchors the geotextile. c) View of the excavated sand bed to the side of the rectangular pier at the end of Run 3 of series MC-RPG, again illustrating edge settling of riprap and geotextile anchoring. ....	141
Figure 3.20	a) Side view of the riprap failure near the rectangular pier of Run 4 of series MC-RPG. b) Downstream view of the riprap failure near the rectangular pier (Run 4 of series MC-RPG). c) Downstream view of the riprap failure near the cylindrical pier (Run 4 of series MC-RPG). ....	142
Figure 3.21	a) View of the riprap and geotextile upstream of the rectangular pier at the beginning of Run 4 of series MC-RPG. This and subsequent views of the same pier for the same run were taken from videotape. The view is upstream from inside the pier. b) View a few minutes later, showing exposure of the geotextile as riprap is eroded away. c) Subsequent view showing the beginning of uplift of the geotextile. A scour hole is apparent below the geotextile. d) Subsequent view showing a deeper scour hole below the geotextile, with the leading edge of the geotextile flipped up against the pier. e) Frontal view showing some rearmoring of the scour hole by riprap from upstream. f) Final view showing riprap falling into the deep scour hole. ....	143
Figure 3.22	Placement of dumped riprap over a geotextile.....	144

Figure 3.23	Performance of the dumped riprap with partial geotextile for series MC-RNX as compared to the case with prior excavation, series MC-RPG.....	146
Figure 3.24	Riprap layer at the rectangular pier at the end of Run 3 of series MC-RNX. ....	146
Figure 3.25	a) Schematization of the geotextile installation under water. b) View of actual installation of the geotextile underwater. ....	147
Figure 3.26	Illustration of the low-water installation technique for geotextile and riprap. The flow has been temporarily halted to improve visibility. ....	148
Figure 3.27	a) Sketch of placement of cable tied blocks around a circular pier. b) Sketch of placement of cable tied blocks around a rectangular pier. ....	150
Figure 3.28	a) View of placement of cable tied blocks around the circular pier in the Tilting Flume. b) View of placement of cable tied blocks around the rectangular pier in the Tilting Flume.....	151
Figure 3.29	a) Close-up of the cylindrical pier at the end of Run 3 of series TF-CB. The mattress of cable tied blocks has settled, and the leading edge of a dune is passing over it. b) View of the rectangular pier at the end of Run 3 of series TF-CB .....	152
Figure 3.30	a) View of the rectangular pier showing edge failure at the end of Run 4 of series TF-CB. b) View of the cylindrical pier showing the deformation of the mattress at the end of Run 4 of series TF-CB. ....	153
Figure 3.31	Cable tied blocks used for the Main Channel experiments. ....	154
Figure 3.32	Schematic placement of cable tied blocks and geotextile around a bridge pier.....	154
Figure 3.33	a) View of placement of the cable tied blocks around the cylinder pier in the Main Channel. b) View of placement of cable-tied blocks around the rectangular pier in Main Channel.....	155
Figure 3.34	Performance of the cable tied blocks with partial geotextile of series MC-CB1 as compared to the cable tied blocks without geotextile of series TF-CB.....	157
Figure 3.35	Comparison of the performance of cable tied blocks in the runs of series MC-CB1, MC-CB2 and MC-CB3.....	157
Figure 3.36	a) View of the circular pier at the end of Run 4 of series MC-CB2, showing the excellent performance of the cable tied blocks in anchoring the geotextile. b) View of the rectangular pier at the end of Run 4 of series MC-CB2, showing the excellent performance of the cable tied blocks in anchoring the geotextile. ....	159
Figure 3.37	a) Top view of the cable tied block incipient failure near the circular pier at the end of Run 4 of series MC-CB3. b) Top view of the cable tied block failure near the rectangular pier at the end of Run 4 of series MC-CB3. ....	160
Figure 3.38	a) View of uplift failure at the rectangular pier at the end of Run 4 of series MC-CB3. b) Another view of the uplift failure.....	161
Figure 3.39a	Placement of grout filled bags around the rectangular and circular piers for series MC-GB1. ....	162
Figure 3.39b	Placement of grout filled bags around the rectangular pier for series MC-GB2.....	163
Figure 3.39c	Placement of grout filled bags around the rectangular pier for series MC-GB3.....	163
Figure 3.39d	Placement of grout filled bags around the rectangular pier for series MC-GB4, MC-GB5 and MC-GB6.....	164

Figure 3.40	Comparison of performance of grout filled bags for the rectangular circular piers in series MC-GB1.....	166
Figure 3.41	Performance of the grout filled bags at the rectangular pier for all the runs.....	167
Figure 3.42	Pattern of bag dispersal observed at the end of the last run of each series. a) Series MC-GB1. b) Series MC-GB2. c) Series MC-GB3. (d) Series MC-GB4. (e) Series MC-GB5. (f) Series MC-GB6.....	168
Figure 3.43	a) Sinking of the grout bags. b) Dispersion of the grout bags. c) Undermining of the grout bags. d) Failure of the grout bags. ....	169
Figure 3.44a	Sheet pile configuration for series TF-SP1. ....	171
Figure 3.44b	Sheet pile configuration for series TF-SP2 .....	171
Figure 3.44c.	Sheet pile configuration for series TF-SP3. ....	171
Figure 3.45a	View of the rectangular pier at the end of series TF-SP1 .....	172
Figure 3.45b	View of the rectangular pier at the end of series TF-SP2 .....	172
Figure 3.45c	View of the rectangular pier at the end of series TF-SP3. ....	173
Figure 3.46	Performance of permeable sheet piles.....	175
Figure 3.47	a) Schematic of the pier-attached vanes in series TF-PV1. b) Schematic of the pier-attached vanes in series TF-PV2. ....	176
Figure 3.48	Performance of pier-attached vanes. ....	177
Figure 3.49	a) Top view of setup at the rectangular pier for series MC-CMB. b) Side view of setup at the rectangular pier for series MC-CMB. ....	179
Figure 3.50	Comparison of the performance of cable tied blocks + riprap (series MC-CMB) against riprap alone (series MC-RPG) and cable tied blocks alone (series MC-CB3).....	180
Figure 3.51	a) View of the rectangular pier at the end of Run 2 of series MC-CMB. b) View of the rectangular pier at the end of Run 3 of series MC-CMB. ....	181
Figure 3.52	a) Top view of the configuration at the circular pier for series TF-CMB. b) Side view of the configuration at the circular pier for series TF-CMB. c) Top view of the configuration at the rectangular pier for series TF-CMB. d) Side view of the configuration at the rectangular pier for series TF-CMB.....	182
Figure 3.53	Performance of the combination countermeasure (series TF-CMB) as compared with riprap alone (series TF RPG) and permeable sheet piles along (series TF-SP1).....	183
Figure 3.54	a) Top view of the circular pier at the end of Run 4 of series TF-CMB. b) Side view of the circular pier at the end of Run 4 of series TF-CMB. c) Top view of the rectangular pier at the end of Run 4 of series TF-CMB. d) Side view of the rectangular pier at the end of Run 4 of series TF-CMB.....	184
Figure 4.1	Placement of riprap at a cylindrical pier. ....	187
Figure 4.2	Illustration of the effect of bedforms on riprap layers. ....	189
Figure 4.3	a) Effect of riprap placement on ultimate disposition.....	190
Figure 4.4	Scour reduction achieved as a function of $U/U_c$ for various initial placement levels. ....	191

Figure 4.5	Scour reduction achieved as a function of $U/U_{rc}$ for various initial placement levels. ....	192
Figure 4.6	Depth of scour measured from the original bed surface versus $U/U_{rc}$ . ....	193
Figure 4.7	Effect of ratio of riprap size to ambient sediment size on scour. ....	193
Figure 4.8a	Illustration of the failure of a riprap layer for $t = 3D_{r50}$ . ....	195
Figure 4.8b	Illustration of the failure of riprap layer for $t = 1 D_{r50}$ . ....	196
Figure 4.9a	Riprap protection for differing thicknesses with $Y/D = 0$ . ....	197
Figure 4.9b	Riprap protection for differing thicknesses with $Y/D = 0.286$ . ....	197
Figure 4.10	Effect of flow variation on scour reduction. ....	199
Figure 4.11	Illustration of the placement of the geotextile. ....	201
Figure 4.12	Failure sequence of filter layer resulting in uplift pressure bulge in filter material. ....	203
Figure 4.13	Failure sequence of filter layers resulting in rollup failure. ....	204
Figure 4.14	Experimental setup for the degradation runs. ....	207
Figure 4.15	Comparison of thickness effects for a degrading bed for the case $c = 4D$ , $D_{r50} = 16$ mm. ....	210
Figure 4.16	Comparison of thickness effects for a degrading bed for the case $c = 4D$ , $D_{r50} = 22$ m. ....	210
Figure 4.17	Comparison of local scour levels in uniform and nonuniform sediments for $c = 4D$ and $t = 2D_{r50}$ . ....	211
Figure 4.18	View of the sediment bed following a typical degradation experiment. ....	212
Figure 4.19	Differences in research performed when there are deviations in the direction of flow. ....	214
Figure 4.20.	Definition of parameters for sacrificial piles. ....	215
Figure 4.21.	Cross section of the 1.52 m wide, flow recirculating flume. ....	216
Figure 4.22	Illustration of a typical experiment on sacrificial piles under mobile bed conditions. ....	217
Figure 4.23	Clear-water scour depths for sacrificial pile arrangement no. 2 ( $u_* / U_{*c} = 0.9$ ). ....	218
Figure 4.24	Mobile-bed scour depths for sacrificial pile arrangement no. 5 ( $U/U_{cs} = 1.48$ ). ....	221
Figure 4.25	Definitions of parameters for submerged vanes. ....	223
Figure 4.26	Progression of scour depth over time. ....	231
Figure 5.1	Size distributions of the sediment and riprap used in the experiments. ....	239
Figure 5.2	Riprap performance for series A1, A3 and A4. The vertical lines denote values of $U_{rc}/U_c$ from Eqs. (3.7a) and (3.7b). ....	242
Figure 5.3	Riprap performance for series A2. The vertical lines denote values of $U_{rc}/U_c$ from Eqs. (3.7a) and (3.7b). ....	243
Figure 5.4	Riprap performance for Series A5. The vertical lines denote values of $U_{rc}/U_c$ from Eqs. (3.7a) and (3.7b). ....	243
Figure 5.5	Riprap performance for series A6. The vertical lines denote values of $U_{rc}/U_c$ from Eqs. (3.7a) and (3.7b). ....	244

Figure 5.6	Riprap performance for series A7. The vertical lines denote values of $U_r/U_c$ from Eqs. (3.7a) and (3.7b).....	244
Figure 5.7	Riprap performance for series B1, B2 and B3. The vertical lines denote values of $U_r/U_c$ from Eqs. (3.7a) and (3.7b).....	245
Figure 6.1	Regime diagram for rivers. ....	247
Figure 7.1	Shows baskets that have deformed and ruptured. ....	253
Figure 7.2	Shows cable tied blocks placed in channels underneath a multilane bridge. ....	254
Figure 7.3	Shows undermining of the blocks related to the geotextile matting immediately downstream of a small grade control structure. ....	254
Figure 7.4	Grout bags installed at a small bridge. ....	254
Figure 7.5	Shows some undercutting of grout bags at ends and sides. ....	255
Figure 7.6	Shows grout mass undercut and cantilevered from the adjacent abutment.....	255
Figure 7.7	Shows a new soil-cement structure under construction. ....	255
Figure 7.8	Shows an embankment which sustained damage but did not fail during a flood. ....	256
Figure 8.1	a) Schematization of the geotextile installation under water. b) View of actual installation of the geotextile underwater. ....	322
Figure 8.2	Illustration of the low-water installation technique for geotextile and riprap. The flow has been temporarily halted to improve visibility. ....	322
Figure 8.3	Riprap installation with prior excavation. ....	324
Figure 8.4	Riprap and geotextile cover with prior excavation. ....	325
Figure 8.5	Riprap installation without prior excavation. ....	328
Figure 8.6	Riprap and geotextile cover without prior excavation. ....	329
Figure 8.7	Installation of cable tied block mattresses.....	335
Figure 8.8a	Installation of grout filled bags. ....	337
Figure 8.8b	Grout filled bag and geotextile cover.....	338
Figure 8.8c	Illustration of the dispersive sliding of grout filled bags under conditions for which the equivalent riprap did not fail. ....	338
Figure 8.9a	Gabion installation. ....	342
Figure 8.9b	Gabion and geotextile cover. ....	342

## LIST OF TABLES

Table 2.1	Total bridges surveyed.....	36
Table 2.2	Bridges with scour problems.....	36
Table 2.3	Scour countermeasures used by survey respondents .....	37
Table 2.4	Screening Summary - Mean Scores .....	44-49
Table 2.5	Screening Summary - Standard Deviation.....	50-55
Table 2.6	Summary on prioritization of countermeasures .....	58
Table 3.1	Summary of experimental runs.....	106
Table 3.2	Grain size distribution of the sediment .....	111
Table 3.3a	Grain size distribution of the original riprap for the Main Channel.....	112
Table 3.3b	Grain size distribution of the original riprap for the Tilting Flume .....	112
Table 3.4	Computed values of $U_c$ .....	113
Table 3.5a	Design flow conditions for the Main Channel: $d_{50} = 0.7$ mm .....	114
Table 3.5b	Design flow conditions for the Tilting Flume: $d_{50} = 0.7$ mm .....	114
Table 3.6a	Design flow conditions for the Main Channel: $d_{50} = 0.5$ mm .....	114
Table 3.6b	Design flow conditions for the Tilting Flume: $d_{50} = 0.5$ mm .....	115
Table 3.7	Experimental riprap sizes.....	116
Table 3.8	Results for calibration runs in the Main Channel.....	118
Table 3.9a	Results for circular pier with no protection in the Main Channel: series MC-NP1 ....	118
Table 3.9b	Results for rectangular pier with no protection in the Main Channel: series MC-NP1 .....	119
Table 3.9c	Results for circular pier with no protection in the Main Channel: series MC-NP2 ....	119
Table 3.9d	Results for rectangular pier with no protection in the Main Channel: series MC-NP2 .....	119
Table 3.10a	Results of circular pier with no protection in the Tilting Flume: series TC-NP1 .....	120
Table 3.10b	Results of rectangular pier with no protection in the Tilting Flume: series TC-NP1 .....	120
Table 3.10c	Results of circular pier with no protection in the Tilting Flume: series TC-NP2 .....	120
Table 3.10d	Results of rectangular pier with no protection in the Tilting Flume: series TC-NP2 .....	120
Table 3.11a	Standard unprotected scour depths for a circular pier in the Main Channel .....	123
Table 3.11b	Standard unprotected scour depths for a rectangular pier in the Main Channel .....	123
Table 3.11c	Standard unprotected scour depths for a circular pier in the Tilting Flume.....	123
Table 3.11d	Standard unprotected scour depths for a rectangular pier in the Tilting Flume .....	124
Table 3.12	Dune heights $\Delta$ for series MC-NP1 and TC-NP1 .....	125

Table 3.13a	Results of series TF-RR1 for the circular pier .....	128
Table 3.13b	Results of series TF-RR1 for the rectangular pier.....	128
Table 3.14a	Results of series TF-RR2 for circular pier .....	129
Table 3.14b	Results of series TF-RR2 for rectangular pier .....	129
Table 3.15a	Results of series MC-RNG for the circular pier.....	132
Table 3.15b	Results of series MC-RNG for rectangular pier.....	132
Table 3.16a	Results of series TF-RNG for the circular pier .....	133
Table 3.16b	Results of series TF-RNG for the rectangular pier.....	133
Table 3.17	Characteristics of geotextile.....	137
Table 3.18a	Results of series MC-RPG for the circular pier .....	138
Table 3.18b	Results of series MC-RPG for the rectangular pier.....	139
Table 3.19a	Results of series TC-RPG for the circular pier.....	139
Table 3.19b	Results of series TC-RPG for the rectangular pier.....	139
Table 3.20a	Results of series MC-RNX for the circular pier.....	145
Table 3.20b	Results of series MC-RNX for the rectangular pier .....	145
Table 3.21	Results of series MC-RPL for the rectangular pier .....	148
Table 3.22a	Results of series TF-CB for the circular pier .....	152
Table 3.22b	Results of series TF-CB for the rectangular pier.....	151
Table 3.23a	Results of series MC-CB1 for the circular pier.....	155
Table 3.23b	Results of series MC-CB1 for the rectangular pier .....	155
Table 3.23c	Results of series MC-CB2 for the circular pier .....	156
Table 3.23d	Results of series MC-CB2 for the rectangular pier .....	156
Table 3.23e	Results of series MC-CB3 for the circular pier .....	156
Table 3.23f	Results of series MC-CB3 for the rectangular pier .....	156
Table 3.24a	Results of series MC-GB1 for the circular pier.....	164
Table 3.24b	Results of series MC-GB1 for the rectangular pier.....	165
Table 3.24c	Results of series MC-GB2 for the rectangular pier.....	165
Table 3.24d	Results of series MC-GB3 for the rectangular pier.....	165
Table 3.24e	Results of series MC-GB4 for the rectangular pier.....	165
Table 3.24f	Results of series MC-GB5 for the rectangular pier.....	165
Table 3.24g	Results of series MC-GB6 for the rectangular pier.....	166
Table 3.25a	Results of series TC-SP1 for the circular pier.....	173
Table 3.25b	Results of series TF-SP1 for the rectangular pier .....	173
Table 3.25c	Results of series TF-SP2 for the circular pier .....	174
Table 3.25d	Results of series TC-SP2 for the rectangular pier .....	174
Table 3.25e	Results of series TF-SP3 for the circular pier .....	174



Table 3.25f	Results of series TF-SP3 for the rectangular pier .....	174
Table 3.26a	Results of series TF-PV1 for the circular pier.....	176
Table 3.26b	Results of series TF-PV1 for the rectangular pier .....	176
Table 3.26c	Results of series TF-PV2 for the circular pier.....	177
Table 3.26d	Results of series TF-PV2 for the rectangular pier.....	177
Table 3.27	Results of series MC-CMB for the rectangular pier.....	178
Table 3.28a	Results of series TF-CMB for the circular pier.....	183
Table 3.28b	Results of series TF-CMB for the rectangular pier .....	183
Table 4.1	Summary of experimental results for riprap with geotextile.....	202
Table 4.2	Results of synthetic filter experiments performed in the 1.52 m wide flume .....	205
Table 4.3	Scour reduction achieved by sacrificial piles (clear water conditions) .....	219
Table 4.4	Scour reduction achieved by optimum sacrificial pile arrangement (mobile bed scour) .....	220
Table 4.5	Submerged vane layouts for Type I vanes used during the present study .....	224-227
Table 4.6	Submerged vane layouts for Type.Ii vanes used during the present study .....	228-229
Table 4.7	Experimental setup and scour reduction achieved using submerged vanes under clear water conditions .....	230
Table 4.8	Vane parameters and scour reduction achieved under mobile bed conditions using Type I and II vanes.....	233
Table 4.9	Summary of scour reduction achieved using different vane angles.....	236
Table 4.10	Relative importance of vane arrangement parameters .....	236
Table 5.1a	Characteristics of the bed sediment.....	239
Table 5.1b	Characteristics of the riprap .....	239
Table 5.2	Summary of data pertaining to experimental setup.....	240
Table 5.3	Values of $u_{*c}$ and $U_c$ for the experiments .....	240
Table 5.4	Values of $U_{rc}$ for the experiments .....	241
Table 8.1	Wire specifications.....	314
Table 8.2	Further specifications for gabions and Reno mattresses .....	316

In addition to design, the following issues are addressed in bullet form in Chapter 8 and the User's Guide of Volume I; applicability (gravel bed streams versus sand bed streams, saline environments, rivers subject to ice etc.), effectiveness (unacceptable, marginal or acceptable), constructability (a technology for underwater geotextile installation and sealing is proposed), reliability, maintainability (debris effects, effects of river degradation etc.) and cost.

# 1. INTRODUCTION AND RESEARCH APPROACH

## 1.1 THE RESEARCH APPROACH

The goal of NCHRP project 24-7 is to delineate, evaluate and develop design criteria for alternative countermeasures against scour at existing bridge piers. Only sites that were otherwise stable were considered in the evaluation, so as to winnow out extraneous factors.

The standard approach in use today for scour remediation at existing bridge piers is to dump riprap around the pier. Over the years, however, a number of alternatives to riprap have been proposed. Some of these are armoring countermeasures such as cable tied blocks, grout filled bags and gabions. Others of these are flow altering countermeasures such as sacrificial piles and Iowa vanes. The lack of design, cost and maintenance criteria inhibits the application of these countermeasures. This project was intended to help fill in this gap and bring the best of the alternatives to the forefront of design.

The research approach of this project can be summarized as follows.

- Conduct a literature survey of countermeasures.
- Screen the resulting list of countermeasures for effectiveness.
- Develop a work plan for each promising countermeasure.
- Carry out as much of the work plan as possible within the rubric of the present project, including field site visits, experiments and evaluation of materials aspects.
- Prepare an evaluation of effectiveness, constructability, reliability, maintainability and cost for each promising countermeasure.
- Develop design guidelines for each of these countermeasures.

The project report consists of two volumes. Volume I is a User's Guide for the applied engineer. Volume II, i.e. the present one, summarizes the entire work program and results.

## 1.2 GUIDE TO THIS VOLUME

This report is lengthy. Some directions may be of use to the reader; several are suggested below.

- The literature review on countermeasures for scour at bridge piers is given in *Chapter 2*.
- Work plans for the study of a wide variety of countermeasures are also given in *Chapter 2*, along with the results of a field survey of bridge engineers as to their use.
- Results of experimental studies of scour countermeasures are given in *Chapters 3, 4 and 5*. The experimental results are summarized in *Chapter 6*.
- Several of the authors of this report conducted an extensive series of field site visits in conjunction with this project. The visits are summarized in *Chapter 7*.
- The results of an investigation of the durability of, and specifications for, gabions, casings, and Reno mattresses are given in *Chapter 8*.
- An important part of this study involves the evaluation of countermeasures for effectiveness, constructability, reliability, maintainability and cost. The evaluations are reported in *Chapter 8*.
- Notes on design of the most promising of the countermeasures are given at the end of *Chapter 8*.
- Data tables pertaining to the experiments, references and notes on a video showing scour countermeasures, countermeasure failure and geotextile installation are provided in the *Appendices*.

### 1.3 THE RESEARCH TEAM

The research team consisted of the following individuals.

St. Anthony Falls Laboratory, University of Minnesota

Carlos M. Toro Escobar, research fellow

Richard L. Voigt, Jr. research fellow

Gary Parker, professor

Department of Civil Engineering, the University of Auckland, New Zealand

Bruce Melville, reader

Christine Lauchlan, graduate student

Anna Hadfield, graduate student

Department of Civil Engineering, Nanyang Technological University, Singapore

Yee-Meng Chiew, senior lecturer

Department of Civil Engineering, University of Louisville

Arthur C. Parola, associate professor

Dr. Joseph Hagerty, professor

The research teams at St. Anthony Falls Laboratory and the University of Auckland were primarily responsible for the experiments. Meng Chiew provided advice to both experimental groups. Richard Voigt, Joseph Hagerty, and Arthur Parola conducted the field site visits. All members participated in screening countermeasures. Northwest Hydraulics Consultants, Polaris Group, and Lametti & Sons, assisted with the evaluation of effectiveness, constructability, reliability, maintenance and cost of countermeasures. In this regard, assistance was also provided by Brad Hall, Charlie Neill, Joel Toso, and Jim VanHoven. The draft report was reviewed by Agres Associates, Teng Engineering, and West Consultants; review efforts at these firms were led by Peter Lagasse, Robert Iverson, and Jeff Bradley.

## 2. LITERATURE REVIEW, COUNTERMEASURE SCREENING AND WORK PLANS

### SUMMARY OF CHAPTER

This long chapter is organized as follows. First, a literature review is presented. The results of a survey of bridge engineers and a screening of countermeasures are outlined. Work plans are devised for all countermeasures relevant to the project. Finally, an outline of the part of the work plans implemented under the auspices of NCHRP 24-7 is presented.

### 2.1 LITERATURE REVIEW

#### 2.1.1 Introduction to Literature Review

The section is devoted to a literature review of countermeasures to protect bridge piers from scour. It is in fulfillment of Task 1 of the original Research Project Statement. The first countermeasure considered in detail is also the traditional one, riprap. Research into both riprap performance and placement guidelines are considered. The next set of countermeasures considered consists of armoring countermeasures which serve as alternatives to riprap. These include concrete-grouted riprap, rock-and-wire mattresses and gabions, sacked concrete, cable tied blocks, tetrapods and dolos, high-density particles, grade control structures and pavement. The final set considered consists of flow-altering countermeasures. These include sacrificial piles, vanes, modified pier texture, sheet piles and collars.

The reader should note that some of the figures in this section are below the standard of the rest of the report. This is because they have been extracted from the original literature in question.

#### 2.1.2 Scour Around Bridge Piers

The subject of scour around bridge piers has a long history. The present review is focused on countermeasures to scour rather than scour itself. With this in mind, the survey of the literature on bridge scour is not intended to be comprehensive.

There exist a number of comprehensive surveys of scour around bridge piers. One of the earlier ones is that of Anderson (1974), where relations due to Ahmad, Blench, Breusers, Chitale, Inglis-Poona, Laursen, Neill and Shen are introduced and compared. Breusers et al. (1977) provide a much more comprehensive review, with 90 references cited. The paper provides an overview of the mechanisms of scour, its prediction, possible countermeasures, design criteria and suggestions for future research. Valuable reviews can also be found in Melville (1975), Hopkins et al. (1980), Raudkivi and Sutherland (1981), Dargahi (1982), and Melville and Sutherland (1988).

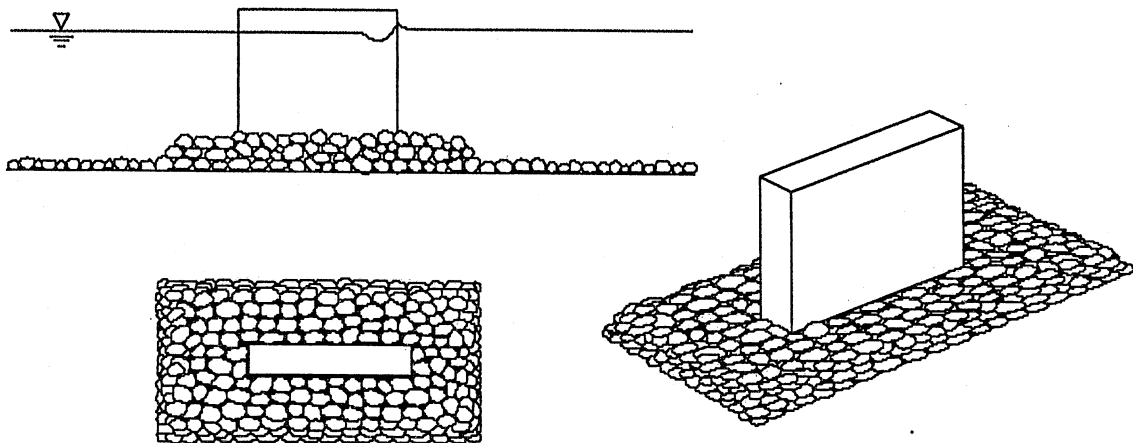
Two of the most recent compilations of results concerning pier scour can be found in Breusers and Raudkivi (1991) and Richardson et al. (1993). The entire field is surveyed in detail in the Interim Report for NCHRP Project 24-8; "Scour at Bridge Foundations; Research Needs" (Parola et al., 1995). At present the equations used in practice for the evaluation of bridge scour appear to fall into two categories: the Fort Collins approach, as typified by the relation presented in Richardson et al. (1993), and the Auckland approach, as typified by the relations presented in Melville and Sutherland (1988) and Breusers and Raudkivi (1991).

A comprehensive summary of Indian experience on the subject of scour at bridge piers can be found in Indian Institute of Bridge Engineers (1993). Of particular value is information on scour in clay- and boulder-bed streams. The recent Ph.D. thesis of Ahmed (1995) not only provides an excellent survey

of the literature on the mechanics of bridge scour, but also provides several interesting cases of the application of scour prediction relations to actual streams.

### 2.1.3 The Use of Riprap as a Scour Countermeasure

The philosophy behind all armoring countermeasures is the creation of a physical barrier against pier scour by means of the placement of large, heavy units that cannot be easily moved by the flow. A bridge pier that is designed correctly should require no extra countermeasures for scour. The footing would either be placed on bedrock or buried to a sufficient depth to allow for scour without failure in the course of an appropriately selected design flood. It is not always possible, however, to design bridge piers and footings to these specifications. In addition, the input parameters used in the design may be found, in retrospect, to have been incorrect, or not known to sufficient accuracy. With this in mind, it can be expected that occasions will arise where the remedial augmentation of protection of the bridge pier will be required.



**Figure 2.1.** Riprap.

When a pier is found to have sustained an unacceptable amount of local scour, the most common countermeasure is the installation of riprap around the base (Figure 2.1). It is remarkable that relatively few studies have been devoted to the determination of appropriate guidelines for the implementation of this simple and widely-used technique. As late as 1990, Richardson et al. (1990) note that “there are few studies to establish dependable guidelines...” for the placement of riprap around bridge piers.

The basis for most studies and design procedures for riprap is experience with bank protection. An early study summarizing several design criteria for bank riprap is that of Searcy (1967); Neill (1973) made extensive use of these results in his design manual for bridge hydraulics. Another excellent review and design document for riprap-lined channels is that by Anderson et al. (1970). An update of design practice for riprap revetment is provided by Brown and Clyde (1989). Two standard design manuals for riprap are U.S. Army Corps of Engineers (1991a, b) and Federal Highway Administration (1989).

Among the factors of the most importance for riprap performance are rock size, gradation, angularity, thickness, and filter design. The use of a filter, or alternatively a geotextile (filter cloth), is of particular importance in ensuring that finer material does not leach through or winnow around the riprap. Edge effects are also important in regard to protecting the riprap against failure.

The pioneering study of bridge scour by Laursen and Toch (1956) includes a brief mention of the use of riprap at piers as a means of protection against scour. They state that the riprap should be placed “well beneath the stream bed - it should not be dumped around the pier or abutment on top of the stream. The greatest protection will be obtained if the riprap material is placed just above the level that is

considered dangerous to the structure.” In regard to riprap size, they state the following: “...the riprap material should be considerably larger than any stream material in the stream bed... A mixed material with minimum voids will give the greatest protection.” In light of subsequent experience, their recommendation in regard to the placement of riprap may be somewhat misleading, as riprap placed under the streambed cannot be inspected to determine if it is still functioning. The need for inspectability is highlighted by the fact that riprap can fail cumulatively as a result of several floods, rather than in a single flood.

It is interesting to note that Neill's (1973) otherwise comprehensive design manual for bridges contains little information as regards the issue of riprap sizing around bridge piers. As late as 1989, Li et al. (1989) could produce a document on riprap sizing in which the criteria for bridge piers appears to be based on little more than inference. Their general technique is based on the evaluation of an average boundary shear stress from a Manning formulation of momentum balance, and the evaluation of a critical shear stress for grain motion based on a Shields criterion. In line with most other studies of riprap, the critical shear stress is found to vary linearly with median riprap stone size  $D_{50}$ . The design shear stress is taken to be a multiple of the critical shear stress so as to include a safety factor. The applied shear stress is taken to be a multiple of the average boundary shear stress. In the case of bridge piers, this multiple is taken to be equal to 4 based on considerations of potential flow.

The above comments notwithstanding, there are a limited but significant number of literature citations pertaining to design procedures for the placement of riprap around bridge piers. Much of the work has its origins in the research of Isbash (1935), which in fact was not specifically concerned with bridge piers. Isbash considered the stability of stones dumped into flowing water, and deduced the following stability criterion:

$$N_{sc} = E \quad (2.1)$$

where  $N_{sc}$  is a dimensionless mobility factor for the stone given by

$$N_{sc} = \frac{U_{rc}^2}{g(S_s - 1)D_r} \quad (2.2)$$

$U_{rc}$  is the critical velocity for motion of the stone,  $D_r$  is the effective diameter of the riprap stone,  $S_s$  is the specific gravity of the stone and  $g$  is the acceleration of gravity. The parameter  $E$  takes a value of 1.5 for rocks placed in flowing water and a value of 2.9 for rocks that have rolled and found a “seat”.

It should be noted that a relation of the form of Eq. (2.2) can be derived from a standard criterion of motion of Shields' type and the assumption of an appropriate relation for drag on the grain. An example of such a derivation can be found in Chiew (1995). Neill (1967) studied the incipient motion of uniform gravel on flat beds and deduced the following relation based on dimensional analysis and empirical grounds:

$$N_{sc} = 2.5 \left( \frac{D_r}{y_o} \right)^{-0.20} \quad (2.3)$$

where  $y_o$  denotes the depth of flow. Neill also showed that an earlier relation due to Straub (1953) could be placed in a very similar form. The form due to Straub, which has an exponent of  $-1/3$  rather than the value  $-0.20$  in Eq. (2.3), is also consonant with the assumption of a constant Shields stress for the onset of motion and a Manning-Strickler resistance relation.

Maynard (1987) generalized Neill's result to graded riprap, obtaining the following empirical relation;

$$N_{sc} = 2.63 \left( \frac{D_{r30}}{y_o} \right)^{-0.20} \quad (2.4)$$

Here  $D_{r30}$  denotes a riprap size such that 30 percent by weight of the stones are finer.

The first quantitative application of these concepts to the sizing of riprap near bridge piers is that of Quazi and Peterson (1973). They conducted small-scale tests using a round-nose pier and model riprap placed flush with the bed of the approach flow. The riprap was extended sufficiently far upstream so that the grain size characterizing the roughness of the approach flow was the same as that of the riprap. While these and other imposed conditions limit the direct applicability of the results to the field, the following useful result was obtained;

$$N_{sc} = 1.14 \left( \frac{D_r}{y_o} \right)^{-0.20} \quad (2.5)$$

The implication is that the approach velocity for stability of the riprap around the pier must be about 0.66 times the corresponding value for a stone resting flush against the bed in the absence of the pier. This conclusion is similar but not identical to one that might be reached based on considerations of potential flow alone, according to which the mean velocity of the approach flow should be about half the maximum mean velocity in the vicinity of the pier. Breusers et al. (1977) used this latter observation in conjunction with the results of Hancu (1971) and Nicolette and Ramette (1971) to derive the following relation for the stability of riprap near a bridge pier from Eq. (2.1);

$$N_{sc} = 0.353 \quad (2.6)$$

This relation would appear to be inferior to Eq. (2.5) in that it was not tested against experimental or field data. It is noted in Parola (1993) that Eq. (2.6) gives unrealistically conservative estimates for riprap size.

Placement of riprap near bridge piers is as important as riprap size. Engels (1929) recommended the placement of rock in a horseshoe shape upstream of the pier. Inglis et al. (1949) recommended placing the rock at the lowest practicable elevation, in that the formation of high mounds around the pier induced large scour holes downstream which could destabilize the riprap. Laursen (1958), Sousa Pinto (1959), Neill (1973), Bonasoundas (1973) and Breusers et al. (1977) all provide recommendations on riprap placement. For example, Bonasoundas (1973), recommends placing riprap in the shape of an egg with the blunt end facing the flow. The overall recommended width is 6D, where D denotes the width of the pier perpendicular to the flow. The recommended length is 7D, 2.5D of which is upstream of the pier. Bonasoundas (1973) presents his own relation for approach velocity for stable riprap, which is not presented here for brevity.

Breusers et al. (1977) indicate that riprap near bridge piers will perform most successfully if riprap can be placed at the trough elevation of the largest bed features. They cite an example from Neill (1964) in which the piers were surrounded by large heaps of stone, extending up to low-water stage. One of the piers collapsed during a flood, apparently because the "protected" pier acted as if it were much wider than the original unprotected pier.

One of the most comprehensive studies of riprap stability near bridge piers is that by Parola (1991, 1993). In this study, four types of rectangular piers and one type of cylindrical pier were tested. The grain size of the sediment covering the bed of the approach flow was typically 2 mm, and differed from that of the riprap tested. For simplicity angular riprap of a uniform diameter varying from 6 to 25 mm was used. The riprap was placed in a layer three grains thick around the pier. Some of the tests were performed with the riprap mounded about the base of the piers; other tests were performed after placing the riprap in preformed scour holes. The mode of scour in the absence of riprap was in all cases clear water scour.

Parola used the data to determine an empirical design relation for rectangular piers according to which  $N_{sc}$  is a function of  $D/D_r$ , where D denotes pier width diameter for a circular pier, and  $D_r$  denotes characteristic riprap size. According to this relation  $N_{sc}$  increases from 0.8 at  $D/D_r = 33$  to 1.2 at  $D/D_r = 4$ . His relation for round piers corresponds to  $N_{sc} = 1.4$ .

Parola notes that his study could be extended by considering a poorly sorted riprap, the lateral extent of riprap protection and general lowering of the streambed.



It is of value to compare the results of Parola (1993) with the guidelines for placing riprap near bridge piers given in Richardson et al. (1992). Their design relation takes the form

$$N_{sc} = \frac{2.89}{K^2} \quad (2.7)$$

where  $D_r$  is interpreted to be the median size of the riprap used in applying Eq. (2.7) in conjunction with Eq. (2.8) and  $K$  takes the value 1.5 for a round-nose pier and 1.7 for a rectangular pier. The values for  $N_{sc}$  obtained from the above equation are similar to those obtained by Parola (1993). Since Richardson et al. (1992) offer no independent data base for the above relation, the agreement likely reflects the use of the data given in Parola (1993), but made available earlier to the authors.

Richardson et al. (1992) recommend the following riprap placement.

- a) The horizontal extent should be at least two times the pier width.
- b) The top of the riprap should be at the same elevation as the bed.
- c) The thickness of the riprap should be at least  $3 D_{r50}$ .
- d) The maximum rock size should not exceed  $2 D_{r50}$ .
- e) Where required and possible, a filter cloth or filter layer should be placed below the riprap layer.

Many of the above guidelines are taken directly from considerations of riprap for bank protection. Further elaboration on the design of filter layers can be found in e.g. Brown and Clyde (1989). It is of value to note, however, that most of the guidelines concerning filter layers for riprap placed around bridge piers are not actually based on studies of bridge piers, but are rather adapted from the literature on bank protection. Any correct adaptation must recognize the fact that mean and dynamic pressure gradients near the streambed around piers can be several times those near otherwise unobstructed flow (Hjorth 1975).

A very recent study of riprap failure at model bridge piers is that of Chiew (1995; see also Chiew, 1992a). The bridge pier was 0.07 m in diameter. The bed sediment was uniform material with a size of 0.96 mm. Three grades of well-sorted riprap were used with median diameters of 2.60 mm, 4.00 mm and 4.85 mm, respectively. The reference case was that of clear water scour. In order to place the riprap, a circular ring was lowered so as to surround the bridge pier, and all the sediment between the ring and the bridge pier was removed to a set depth. The resulting hole was then filled with riprap to the same depth as before. Approach flow velocities were then gradually increased until the riprap layer disintegrated, resulting in failure.

The experiments revealed the three modes of failure listed below.

- a) Riprap shear failure, according to which the riprap stones cannot withstand the horseshoe vortex associated with the scour mechanism.
- b) Winnowing failure, according to which the underlying finer material is removed through the voids of the riprap.
- c) Edge failure, according to which instability at the edge of the coarse riprap layer and the bed sediment results in a scour hole that destabilizes the whole layer.

Chiew develops and presents an iterative scheme for the sizing of riprap against shear failure, the basic principles of which are similar to those described above. In his method, the parameter  $N_{sc}$  is not only a function of the ratio  $D_r/Y$ , but in addition of  $D_r/d_{50}$  where  $D_r$  denotes the median grain size of the sediment on the bed of the river in the absence of riprap. The method is compared against those of eight others and is found to give reasonable results.

Chiew notes that the riprap may fail due to winnowing or edge failure even if the above-mentioned design criteria are satisfied. It was found that a thickness of riprap of more than one particle

prevented winnowing failure in the laboratory. Edge failure could be prevented by making the layer of riprap sufficiently thick, and its lateral extent sufficiently large.

Fotherby (1992, 1993), Bertoldi et al. (1994), and Jones et al. (1995a,b) also document recent tests on riprap performance near bridge piers. Since the focus of their work is on alternatives to riprap, however, the documents are discussed in more detail in a subsequent section below.

The above list by no means exhausts the literature on the protection of bridge piers by riprap. Sousa Pinto (1959) provides an early example of an experimental study of riprap around bridge piers, in which attention is paid to riprap grading. Although Gill's (1970) study is directed mostly toward contraction scour, a portion is devoted to riprapped bridge piers. Posey (1974) provides a valuable study of the use of filter layers below riprap against piers. Dargahi (1982) discusses common practice for the use of riprap near bridge piers in Sweden, India, the Netherlands, and the USA. Worman (1987, 1989), after reviewing standard Swedish design techniques, attempts to provide design criteria for a single layer of riprap without a filter layer. Godbole and Mehnendale (1989) provide a review of Indian design practice. Croad (1990) presents a laboratory study of riprapped piers. He found that the riprap protection performed best when placed flush with the initial bed level. A few other references of interest include Lewis (1972), Wang and Shen (1985), Graziano and Jones (1990), Pagan-Ortiz (1991) and Atayee (1993a, b).

The above literature review suggests several issues in regard to the use of riprap near bridge piers which would merit further investigation. Some of these are enumerated below.

1. Most riprap tested under controlled conditions tended to be in the pea gravel range. The difference between the riprap size and river bed material was not too large. In order to reliably eliminate Reynolds effects and more closely approximate conditions in sand-bed streams, the physical scale at which the tests are conducted should be increased.
2. It is well known, from experience with riprap as bank protection, that riprap gradation plays an important role as regards performance, both in rendering the riprap layer structurally stable and in preventing the leaching of sand from below. Poorly-sorted riprap should thus be used in controlled tests to determine performance and design parameters.
3. The increasing use of geotextiles (filter cloths) suggests an alternative to a filter layer. Geotextiles should be tested for the case of bridge piers. In order for the test to be reliable, the scale of the tests must not be reduced too far below field scale.
4. The placement of riprap has been shown to be important; however no generally accepted criteria are available for the lateral extent or finished level of the riprap layer. In particular, there exist conflicting recommendations for the finished level of riprap protection.
5. Little is known about the behavior of riprap protection where general degradation of the sediment bed occurs.
6. Most of the proposed methods are determined from tests conducted under clear-water conditions. How a riprap layer would respond under live-bed conditions is not well known. The issue is of particular importance in the presence of bedforms.
7. The effect of time on the stability of riprap layers should be considered. A scour hole takes time to develop; for example, equilibrium clear-water scour holes often takes days to form in the laboratory. In the same way it is of value to examine the stability of riprap layers subjected to a long flood duration. The experimental data of Chiew (1995) indicated that a riprap layer that remained intact when subjected to a duration of 15 minutes of flow failed when the flow duration was increased to 1 hour.

#### **2.1.4 Alternatives to Riprap**

In principle, a correctly designed bridge pier and footing should not require any remedial protection. However, cases commonly arise for which remedial protection is required. For these cases, riprap has been the remedy of choice, due to its general availability and the long design experience with

riprap in a variety of settings. There are, however, a number of reasons why riprap cannot be the universal choice for remedial pier protection.

In some regions, riprap is either unavailable due to the lack of a ready supply of durable stone, or too expensive to warrant use. In other regions, environmental regulations concerning the placing of objects in rivers make the use of riprap difficult. In other cases stone is available, but not in the size ranges needed to provide protection against scour. For these practical reasons it is of value to consider alternatives to riprap. In addition, it is always in the engineer's interest to consider alternative countermeasures which accomplish the same goal as riprap either more effectively or in a more acceptable way.

The alternatives to riprap considered to date can be divided broadly into two classes. The first of these consist of armoring countermeasures. Here the following types of armoring countermeasures are considered:

1. Gabions and Reno mattresses.
2. Grout filled bags and mats.
3. Cable tied blocks.
4. Tetrapods, dolos and related units.
5. High-density riprap
6. Grade control structures.
7. Other armoring countermeasures such as grouted concrete, pavement, and flexible bed armor.

It should be noted here that one other measure that might be classified as an armoring countermeasure, namely structural foundation rehabilitation (e.g. extended footings, caissons or pile caps), has been excluded from consideration in this project, even though it has been found to be successful in some cases. While the experience with armoring alternatives in the context of bridge piers is considerably less than that for riprap itself, many of them have been tested in the laboratory and field. For example, tetrapods and dolos have been used successfully in the coastal environment for many years.

The second type of alternative to riprap consists of flow-altering countermeasures. The principle here is to modify the flow so as to reduce the potential for scour rather than prevent it by structural means. These alternatives are much more tentative in nature, with relatively few field installations. They include the following.

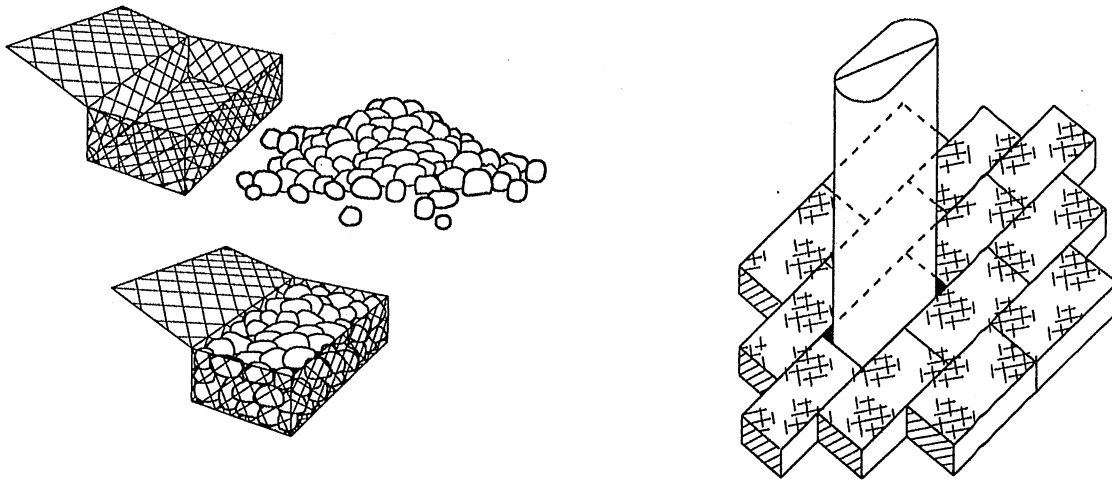
1. Sacrificial piles.
2. Upstream sheetpiles.
3. Collars and horizontal plates.
4. Flow-deflecting vanes or plates.
5. Modified pier shape or texture.
6. Slots in piers and pier groups.
7. Suction applied to the bridge pier.

#### 2.1.4a Armoring Countermeasures

**Gabions and Reno mattresses.** The terms "gabion" and "Reno mattress" are used almost interchangeably. Both refer to containers constructed of wire mesh or other material and filled with loose rock (Figure 2.2). Whereas gabions typically refer to containers that, when filled, take the shape of a brick or sausage, Reno mattresses refer to containers with a short vertical dimension and large lateral extent.

Steel wire gabions were first manufactured commercially by the Officine Maccaferri in 1884 to repair a breach of the Reno River in Italy. Since then they have gained wide popularity as a means of protection against erosion. They have several advantages compared with other means of bank protection. Because they are filled with loose rock, they are porous, and thus not as susceptible to uplift forces as more

solid countermeasures such as articulated concrete mattresses. Gabions can easily be stacked in very stable configurations. Should the configuration become unstable, the flexibility of the wire mesh allows gabions to mold themselves so as to restore stability. Finally, gabions allow for the use of relatively small stones in a way that yields the protection characteristic of much larger rock units.



**Figure 2.2.** Gabions.

Gabions have been in common use in Europe and are increasing in popularity in the United States. Examples of implementation include Lavagnino (1974) and Schuster (1974). Brown (1979) provides some examples of their use in the coastal environment. Brown and Clyde (1989) provide guidelines for the use of both gabions and Reno mattresses as bank protection. U.S Army Engineers (1983) provide some similar, though simplified, guidelines for the use of gabions as bank protection by landowners and local governments.

A considerable body of useful information concerning gabions can be found in the Maccaferri Handbook and other information available from the company. While there is a large, essentially anecdotal body of information concerning their use in the field, independent tests and quantitative design guidelines are relatively few. One example, however, is that of Brown (1979), who reports on both laboratory testing and experimental installations of gabions as a means of protecting against coastal erosion under wave action. It is noted in the report that "...the unique merit of gabions and mattresses is that they provide a flexible structure capable of remaining coherent despite gross deformations. The use of rigid material in their manufacture is obviously contrary to this concept."

Perhaps the most substantial attempt undertaken to date in the United States to obtain quantitative design guidelines for gabions and mattresses in the fluvial environment is that due to Simons et al. (1984) with the use of scale model testing. The construction procedures used to make the gabions were based on those provided by the Maccaferri Company. The model testing was based on a 1:3 scale ratio and standard Froude modeling. The rock-filled mattresses were laid in a single layer so as to form a nearly horizontal continuous surface. The mattresses were placed over filter cloth, which in turn rested on a bed of sand. The experiments do not provide a direct test of the performance of gabions when placed around a bridge pier. They nevertheless provide information concerning a) the resistance to flow offered by gabions, b) the pattern of rock movement within gabions when subjected to a flow sufficient to mobilize the individual stones, and c) the performance of filters below gabions.

Simons et al. (1984) were able to obtain some specific design criteria for the use of Reno mattresses. They found that the critical Shields stress required to displace a rock within the wire cage is

over twice the value that would be required to move the same rock were it not contained in the mattress. Even when the mattresses deformed due to high velocities, they found that they were still effective in protecting the bed against erosion as long as the thinnest portion of the mattress is thicker than the median rock size. In order to achieve the same stability from riprap alone, they found that the riprap size would have to be twice as large as those used in the mattresses, and the layer of riprap would have to be thicker than that of the mattresses.

Useful results were also obtained concerning filter performance. In addition, tests were performed using grouted mattresses. The material used for grouting was sand-asphalt mastic. Grouting apparently improved the integrity of the filter layer at very high velocities. The issue of uplift was not discussed in the context of grouted mattresses.

Two other sources of information concerning gabions in the fluvial environment are the U.S. Army Corps of Engineers (1991b) and Maynard (1995). The former document provides a compilation of design criteria for gabions, including wire and basket characteristics. In the latter document, Maynard (1995) attempts to provide a unified framework for the analysis of riprap and gabion stability. It is pointed out that the velocity criterion for rock stability given in Simons et al. (1984) is independent of depth, whereas the velocity criterion for riprap itself is dependent upon depth, e.g. as given by the Neill criterion of Eq. (2.3) above. Maynard uses the data of Simons et al. (1984) to derive a version of Eq. (2.3) applicable to gabions. A minimum gabion thickness of twice the average rock size is recommended. Maynard's reanalysis of the data in Simons et al. suggests a stable gabion-mattress thickness equal to about one-third the thickness of equivalent loose riprap.

The design procedure in Maynard (1995) is limited to flows with low levels of turbulence. The applicability of the results to the field environment thus needs further investigation. In highly turbulent flows, movement of rock within the gabions can result in wire failure.

Racin (1993) reports on the performance of gabions in the coastal environment. The observations are based on seven years of field monitoring of gabion installations along the Pacific Coast of the United States. The gabions were generally found to perform satisfactorily. A method of quantifying the service-life of gabion structures is presented in terms of the time required for the wire mesh strength to decline to 50 percent of its original value. Based on the limited observations, a service life of about 21 years is expected, after which repair or replacement is required. In the intratidal zone, where more severe exposure is anticipated, a more rapid reduction in the wire strength is expected. Racin (1991) describes the comparative reduction in wire strength due to corrosion under controlled laboratory conditions. For corrosive environments, PVC-coated-galvanized wire mesh is reported to perform better than wire mesh that has only been galvanized.

Novak (1988, updated 1993) studied the performance of 10-30 year old gabion installations. Satisfactory performance was found for retaining walls; gabions performed well in some cases of stream bank protection as well. Damage to the wire mesh was reported where gabions were used as lining for steeply graded ditches, or as weirs.

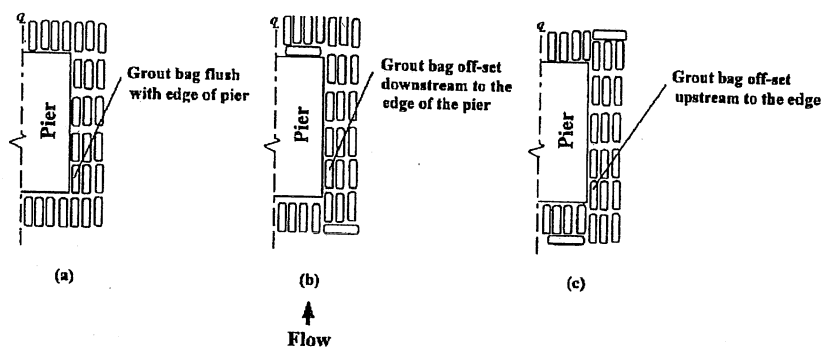
Considering the observations of Maynard (1995), Racin (1993), Racin (1991) and Novak (1988, updated 1993), damage to the mesh wire of gabions, which can result in failure of the entire installation, appears to be a major reliability problem as regards the performance of gabion installations. The damage to the mesh wire may be from the following processes: a) movement of filling rock in highly turbulent flows leading to wire damage, deformation of the basket and ultimately to unsatisfactory performance of the installation, and b) long-term corrosion and reduction in strength of the wire mesh leading to installation failure, possibly in combination with the first-mentioned factor. The first process is relatively easy to test in laboratory; the second one requires either field monitoring or long-term laboratory testing.

The research team has recently received a relatively pessimistic evaluation of the use of gabions in the field for bridges. Novak (1988, updated 1993) reports that many field installations of gabions in coarse-bedded streams have failed or not performed to expectations. A personal communication from S. Georgopolous, a highway engineer for the state of New York, to Parola (1995), a member of the research team for this project, discourages their use by the New York Department of Transportation.

The above comment notwithstanding, the literature review suggests that gabions can indeed play a useful role as regards the protection of bridge piers in at least some environments. Formal testing of them in this context appears, however, to be slight. The literature review suggests the following possible topics for more detailed tests.

1. A set of basic experiments on gabion and mattress performance near bridge piers is required. The experiments should cover various gabion sizes, stacking modes and lateral coverage. They should allow for the development of design criteria for gabions to a standard that is at least equivalent to that available today for riprap.
2. Experimental and field tests on gabion placement are required to determine the most effective mode of installation.
3. A further area of concern is the disintegration of the wire mesh with time. Failure of the wire mesh can lead to catastrophic failure of the protection scheme when the stones filling the gabions are small.

**Grout filled bags and mats.** Grout mats and grout bags are fabric shells that are filled with concrete (Figure 2.3). The mat is a single, continuous layer of fabric with pockets, or cells that are filled with concrete. Grout bags are smaller units that can be stacked in a manner reminiscent of gabions.



**Figure 2.3.** Grout filled bags.

It is not intuitively obvious that grout-filled mats or bags would offer major advantages as compared to riprap or rock-filled gabions. There are, however, several reasons for their consideration. In some regions durable rock for riprap may not be available, or may be too expensive for use. Environmental rules in other regions may classify riprap as a potential pollutant while allowing the concrete used in the bags and mats. In the case of small bridges, the bags can be installed where it is difficult to bring in equipment for the placement of riprap. Finally, concrete is a construction material familiar to bridge engineers, the characteristics of which are well known.

Bertoldi et al. (1994) report that grout mats have been employed by the U.S. Army Corps of Engineers to prevent bank erosion, and that the Maryland Department of Transportation is field testing them as a countermeasure for local scour. They have been used at a number of sites on the Ohio River and its tributaries.

The main body of literature pertaining to grout filled mats and bags is contained in Fotherby (1992, 1993), Bertoldi et al. (1994), and Jones et al. (1995a,b). As this work is referred to several times below, it is useful here to review the scope of the work in question.

The experiments of Fotherby (1992, 1993) pertain to performance tests of riprap, footings, grout mats, and tetrapods as countermeasures for local scour at bridges. The testing was done using clear water in a flume with a width of 1.8 m (6 ft) and a length of 21.3 m (70 ft). The dimensions of the pier in the horizontal plane were 152 mm (6 inches) by 305 mm (12 inches). A total of 148 tests were conducted, including 84 tests with a sand bed and 64 tests on a flat, fixed bed.

The experiments of Bertoldi et al. (1994) and Jones et al. (1995a, b) were conducted in the same channel as those of Fotherby. They were designed to test riprap, extended footings, grout bags, grout mats, tetrapods, cable-tied blocks, and high-density particles as countermeasures for bridge pier scour. The pier, which was rectangular with the same dimensions as that of Fotherby (1992, 1993), was located in a recess to allow sediment to form an erodible bed. A medium sand was glued to a false bottom upstream and downstream of the recess to form an inerodible bed with a natural sand roughness. A total of 274 experiments were conducted.

Fotherby tested a yoke-shaped configuration for grout-filled mats which protected the front and both sides of the bridge pier. The mats extended a distance outward from the pier ranging from one to two times the pier width. The tops of the mats were placed flush with the bed, in accordance with practice for riprap. A number of other runs were conducted with grout bags underlain by a filter cloth. Both single layers of bags and stacked bags were tested. In some of the experiments the bags were connected either rigidly or in a flexible way.

In order to obtain good performance from the mats, it was necessary to bind them firmly to the pier itself. When they were placed on the model river bed rather than flush to it, the installation of anchors was required to prevent uplift failure. It was strongly recommended, however, that the mats be installed with their top surfaces flush to the bed. The grout bags were prone to catastrophic failure if they were too small. Otherwise the mode of failure was a gradual erosion process similar to that in riprap. It was found that a geotextile was essential for the successful performance of grout bags, especially when the bags were stacked on the surface rather than placed in a pre-excavated hole. Properly sized bags were found to be more effective if used to extend a single layer of protection laterally, rather than if they were stacked.

It was found that properly-installed grout mats and grout bags reduce scour depth to a degree generally comparable with riprap. They thus appear to be an effective countermeasure against scour.

While Fotherby's tests were promising, she did not place her results in a hydraulic framework that allows for design criteria similar to those for riprap. An attempt at such a framework is one of the major contributions of Bertoldi et al. (1994) and Jones et al. (1995a,b), which represents an extension of Fotherby's work. For example, the height of grout bags was selected for use as an equivalent riprap grain size  $D_r$  in determining a stability criterion of the Isbash type, i.e. (Eq. 2.1) and (Eq. 2.2).

Bertoldi et al. confirmed the need for anchors in the case of grout mats placed on top of a loose, erodible bed. It was again found that placement is extremely important for successful performance. Properly placed grout mats extending 1.5 pier widths were found to provide significant protection to bridge piers. In the case of grout bags, bags along the side of the pier aligned flush with its front end tended to be prone to failure. A staggered placement provided better protection. The researchers note that the effectiveness of grout bags as a countermeasure is dependent upon the use of a filter fabric, tightness of mat fit to the face of the pier, and the lateral extent of the mat apron.

Dimensionless stability parameters based on the Shields and Isbash incipient motion formulas, as well as similar parameters based on overturning forces, allow a tentative scale-up of the laboratory results to the field.

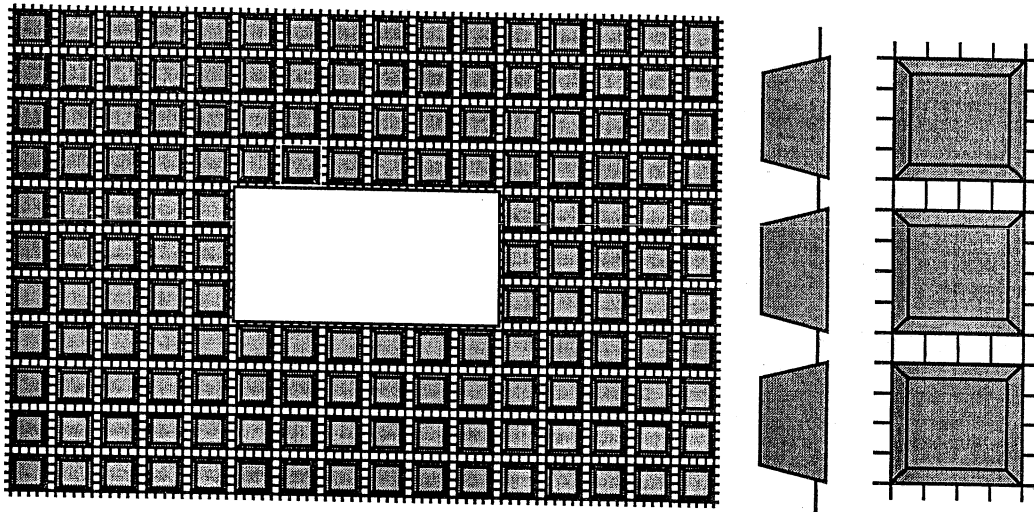
Both grout mattresses and grout bags show promise as countermeasures. Some problems that remain to be investigated can be enumerated as follows.

1. A lift criterion is needed to determine when grout mattresses fail by rollup.
2. Practical means of placing grout mattresses need to be devised and tested. Two of the most important issues in this regard are the use of anchors and the degree of sealing between the mattress and the pier.

3. Standard design criteria for grout-filled bags must be developed in a form similar to those for riprap. In the absence of such criteria it is difficult to determine the relative cost of the two countermeasures.

**Cable tied blocks and mats.** Cable tied blocks are illustrated in Figure 2.4. They have a long history in river engineering. The simplest implementation of this concept has been in coarse-bedded streams capable of moving stones so large that they scale with the channel depth (e.g. Miles, 1995). In such cases it is often impractical or impossible to use riprap of the desired size. Instead, stones or blocks of manageable size can be tied together by cables to produce a network capable of resisting the mobilizing force of a severe flood. A more standard implementation is the articulated concrete mattress used for bank protection by the Army Corps of Engineers.

The technological base for articulated concrete mattresses is relatively advanced. A standard specification document for revetment work using articulated concrete mattresses can be found in U.S. Army Corps of Engineers (1987). Cable tied concrete mats constitute a closely allied means of protection against erosion. McCorquodale (1994) has prepared a set of guidelines for their placement. He recommends their use as a means of preventing erosion in a variety of contexts. Their advantages include a) flexibility, b) ability to withstand strong currents, c) a pre-attached geotextile, d) resistance to ice and e) cost-competitiveness. Specifications for safe block size involve estimates of the flow velocity and bed and side slope; these provide a base for the potential development of design criteria for bridge piers. Anchoring and tie-in mats are recommended to ensure stability. In some cases local grouting is recommended wherever there is danger of abrasion of the geotextile.



**Figure 2.4.** Cable tied block mattress.

Cable tied blocks or mattresses are produced commercially by a number of companies. One company, for example, offers a variation they call “cabled-concrete armormats”. They recommend these for the following applications: flood control protective works, bluff and bank stabilization, toe protection for bulkheads and seawalls, protective covers for outfalls and subaqueous pipelines, beach accretion systems, and lastly, scour protection for bridges, piers and foundations. The documentation does not indicate either experience with bridge piers or design specifications for their installation around bridge piers.



Specific tests of cable tied blocks as a means of protection for bridge piers can be found in Bertoldi et al. (1994) and Jones et al. (1995a,b). An overall view of the experimental setup was provided above. Two types of cable-tied blocks, one with a trapezoidal geometry and the other with a hexagonal geometry, were tested under a variety of conditions. The cable tied blocks were placed in the form of a mattress completely girdling the bridge pier.

The results obtained were somewhat similar to those obtained by the same authors for grout-filled mattresses. They note that "the critical difference between significant scour and no scour regardless of the approach velocity appears to be the seal between the face of the pier and the countermeasure." Most of the experiments were performed with a geotextile. When the geotextile was absent, it was found that "local scour progressed as if the mat were not there." While satisfactory performance was obtained from both types of blocks, there were marginal differences between the trapezoidal and hexagonal geometries.

The two observed failure modes for cable tied block mats were similar to those for grout filled mats. The first of these is an overturning and rolling-up of the leading edge, which can occur in the absence of sufficient anchoring or toeing in. The second, which occurs at much higher flow velocities when the leading edge is anchored, consists of uplift of the inner mat.

Another study of cable-tied blocks as a pier scour countermeasure can be found in McCorquodale et al. (1993). Guidelines for the dimensions of the revetment were developed with the aid of a hydraulic model study. Cable-tied blocks were found to perform quite effectively if used in combination with a filter cloth.

Neill and Morris (1980) describe an example of a bridge pier on the Thompson River, B.C. Canada, which was subject to severe scour. A variety of options were considered for remediation, including the installation of sheet pile, grouting, and foundation underpinning. The scheme ultimately accepted involved the placement of a cable-tied concrete mat above a layer of riprap.

Areas of further research concerning cable-tied block mats are similar to those required for grout filled mats, and so have been enumerated previously.

***Tetrapods, dolos and related units.*** The lack of readily available stones sufficiently large to resist wave action during extreme storms led to the development of concrete-cast tetrapods, dolos and related devices for shore protection (Figure 2.5). According to the U.S. Army Coastal Engineering Research Center (1977), the first use of tetrapods in the U.S. was for the extension of the breakwater of Crescent City, California, in 1957. Two layers of 25-ton tetrapods were used to extend the breakwater. Since that time the use of tetrapods and related devices as a means of shore protection has proliferated. They have been successfully used for breakwaters, groins, jetties and sea walls.

The concrete units in question include tetrapods, dolos, tribars, accropodes, and core-loc units. A summary of these units can be found in Turk and Melby (1995). All are designed to give a maximum amount of interlocking using a minimum amount of concrete. They are successful in the coastal environment in that they are designed to dissipate the energy of waves. One reason for their stability is their shapes, which are chosen to achieve a higher degree of interlocking than can be expected even with the most angular riprap. Since they are of standard size, however, they do not provide a means for preventing the leaching of bed material from below. With this in mind, it is not guaranteed that they would provide a successful means of scour protection around bridge piers. It should be noted, however, that in the coastal environment the devices are now used almost exclusively in conjunction with geotextile filters, which are likely also to be necessary for pier scour protection.

Tetrapods were tested as a means of protection for bridge piers by Fotherby (1992, 1993), Bertoldi et al. (1994), Jones et al. (1995a,b), and Bertoldi and Kilgore (1993). Fotherby performed a comparative test of riprap and tetrapods. Tetrapod stability was cast into the form of Eqs. (2.1) and (2.2), using the equivalent spherical diameter as a means of evaluating the effective diameter  $D_r$ . Fotherby's study suggested that tetrapods offer little advantage compared to riprap in terms of stability. Tetrapod stability

was not significantly affected by placement density over the range of conditions covered. Stability did increase with the lateral extent of placement.

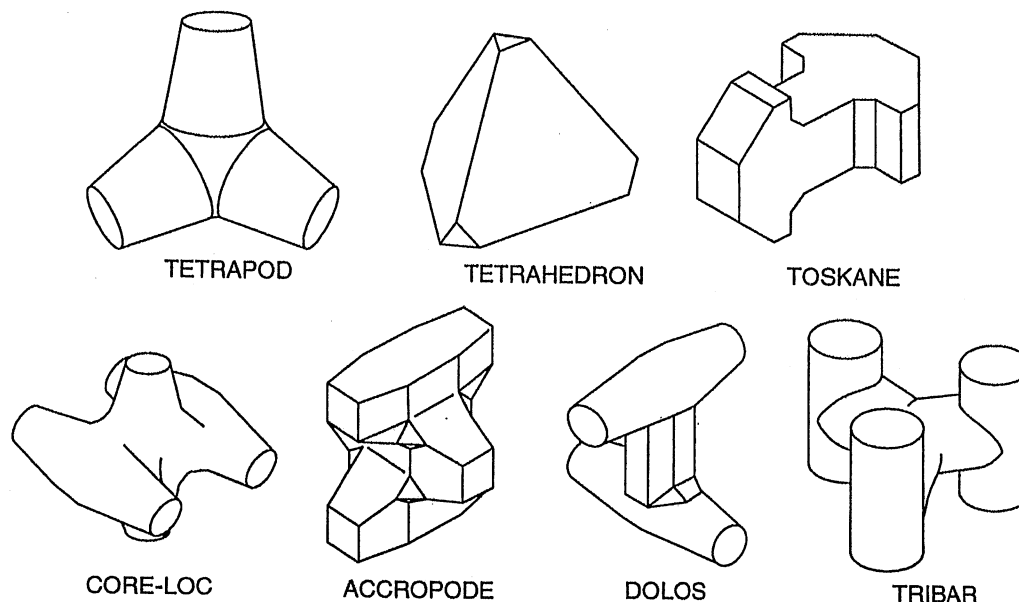


Figure 2.5. Tetrapods and related units.

Bertoldi et al. (1994) extended the work of Fotherby using the same facility. Their effective diameter for tetrapods is also the same as that of Fotherby. They obtained a general stability diagram of the Izbash type based on Eq. (2.2) for tetrapods and riprap within which the two types are not readily distinguishable. A Shields type stability diagram, however, suggested that tetrapods might be more effective than riprap of a similar equivalent size. Filter cloths were not used in the studies. This notwithstanding, the authors recommend their use, in recognition of the fact that the potential for leaching of sand from between the units is higher than for poorly sorted riprap.

Fotherby and Ruff (1995) report on the use of a variation on tetrapods known as toskanes as a countermeasure for bridge scour. They found toskanes to be more effective than either tetrapods or dolos. Their report is a model of engineering research, in that it includes comprehensive testing, the development of design criteria and designs including cost estimates for a number of bridge sites in Pennsylvania.

The most pressing research need in regard to tetrapods and related units is a determination of the filter requirements for good performance. A second need is a comparison of the various unit types to determine the one most preferable for the fluvial, as opposed to the coastal environment. Fotherby and Ruff (1995) have made considerable progress in regard to this last point.

**High-density riprap.** Riprap as a means of protection against scour has an inherent disadvantage. A substantial part of the stability associated with the weight of large stones is counteracted by the large drag force they experience due to their protrusion into the high-velocity flow above the bed. An effective way to solve this problem might be the use of high-density riprap particles.

There are very few reports documenting the effectiveness of high-density riprap. Two such reports, which document the same set of tests, are those of Bertoldi et al. (1994) and Jones et al. (1995a,b). The first of these indicates that the idea was suggested earlier by Poreh and Trent, but no reference was provided. Three tests were performed using model riprap composed of lead with sizes of 0.4 mm and 2.5 mm. These were placed over a bed of medium sand. No filter layer was used.

These limited tests provided promising results. It was pointed out, however, that the high-density riprap should not be smaller than the bed material they were meant to protect. In addition, the testing of a thicker layer of riprap would appear to have been advisable.

A serious question concerning the further investigation of high-density riprap is its availability. Jones et al. (1995a) suggest that the particles could be composed of recycled material such as scrap metal and crushed auto bodies. They recognize, however, the possibility of environmental problems.

In the last two years one of the authors has had the opportunity to work on a project involving the tailings basin of the Hibbing Taconite Mine, an iron mine in northern Minnesota. Channels in the tailings basin are typically riprapped with waste rock generated by the mine. The waste rock is highly angular, extremely durable and, due to the iron content, of a high density, with a specific gravity between 4 and 5. Evidence obtained from the mine engineer indicates that it performs extremely well as riprap on banks. The large quantities available in northern Minnesota from present and previous mining operations suggest that its use as a riprap might be economically feasible under some conditions.

With the above comments in mind, at least three areas of further research are suggested in regard to dense riprap.

1. Research is required to determine environmentally acceptable sources of high-density riprap, and to determine the economics of its use as a function of distance from source.
2. A set of paired experiments using ordinary riprap and, for example, iron-rich waste rock should be performed to determine design criteria for heavy riprap. While the stability parameter defined by Eq. (2.2) does include riprap specific gravity as a parameter, it may not account for the difference in protrusion between ordinary and heavy riprap, which would have a smaller diameter for the same weight and the same value of  $N_{sc}$ .
3. A field installation using two adjacent piers on the same bridge, both with the same approach conditions, should be considered. One would be riprapped with ordinary material in the conventional way, and the other would be riprapped with high-density riprap. Their relative performance during a flood would then be observed. In particular, care would be taken to detect any preferential tendency for the heavy riprap to settle.

**Grade control structures.** Grade-control structures are wall-like structures built across the entire width of a channel. Their purpose is to prevent the upstream migration of degradation in a river. They can be constructed from a variety of materials, including concrete, masonry, rock rubble, gabions and sheet pile. Some guidelines concerning grade control structures can be found in e.g. Lagasse et al. (1991).

Two examples of the use of grade control structures for bridges illustrate their usefulness. Galay (1983) reports of an example of a bridge on the Brenta River, Italy, where the piles were severely exposed due to upstream-migrating degradation. The construction of a high weir directly downstream of the bridge not only halted upstream-migrating degradation, but forced the bed to aggrade just upstream of the weir, restoring favorable conditions at the bridge piers. The original problem of degradation appears to have been at least partly driven by gravel mining.

Chang (1992) provides a very similar example on the San Diego River, California. Channel degradation was produced by sand and gravel mining downstream of the bridge, exposing the piles. The process was halted, and the problem remedied by means of the installation of a sheet-pile grade control structure.

In the context of bridges, grade control structures are designed to protect all the piers rather than a single one. They constitute an armoring countermeasure only to the extent that they provide a structural barrier to further bed erosion. Their status is thus somewhat different from the other armoring countermeasures discussed here. The most interesting and potentially useful topics for research on the subject of grade control structures concern their interaction with other countermeasures such as riprap, as indicated below.

1. How much degradation can riprap and other countermeasures withstand before they fail?
2. What is the minimum height of a grade control structure relative to the footings sufficient to prevent failure?
3. What is the most reliable grade control structure for a given environment?

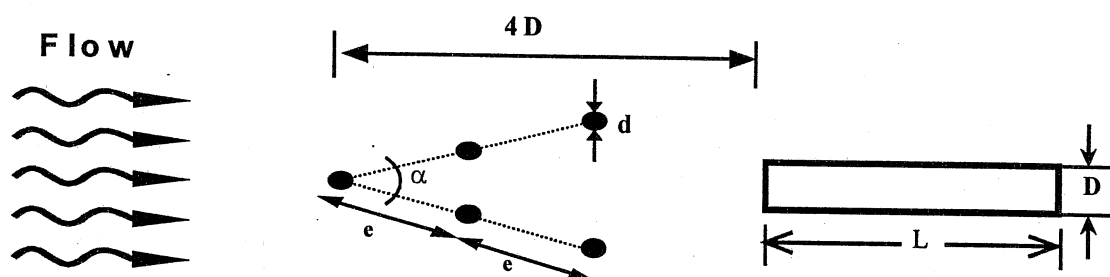
**Other armoring countermeasures.** Other armoring countermeasures that have been used to protect against bank or bed erosion include:

- a. grouted riprap (e.g. Brown and Clyde, 1989) and soil cement (e.g. Peterson, 1986);
- b. grouted stones within gabions (e.g. Simons et al., 1984);
- c. modular paving units (e.g. Adams and Middlecamp, 1985), Tri-lock units (e.g. Brown and Clyde, 1989; Resource Consultants and Engineers, 1993), and tile mats; and
- d. monolithic concrete or asphalt pavements installed directly over a bed or bank (e.g. Brown and Clyde, 1989).

These techniques deserve at least some further consideration in determining whether they belong in the repertoire of countermeasures for scour around bridge piers.

#### 2.1.4b Flow Altering Countermeasures

**Sacrificial piles.** Sacrificial piles consist of piles placed upstream of a bridge pier for the purpose of protecting it from scour (Figure 2.6). The term "sacrificial" is somewhat misleading, because the piles are designed not to fail, but rather to protect the pier. Although single sacrificial piles have been tested, the method appears to work best when they are employed in triangular or diamond-shaped groups, partly because a single pier may become ineffective with a shift in flow alignment. The piles themselves may incur substantial scour, but they shield the pier by deflecting the high-velocity flow and creating a wake region behind them.



**Figure 2.6.** Sacrificial piles.

The earliest study of sacrificial piles is contained in the classical study of Chabert and Engeldinger (1956). In this study the piles were placed in a triangular pattern upstream of the pier. The number, position and layout of the piles was varied systematically. Up to a 50 percent reduction in scour depth was reported. The study did not result, however, in the development of design guidelines for their installation.

Two studies in which these ideas were further pursued are those of Shen et al. (1966) and Chang and Karim (1972). In the study of Shen et al. a cylindrical pile was placed upstream of a rectangular pier.

A maximum reduction in scour depth of 60 percent was observed when the pile was placed two diameters upstream of the pier. The study of Chang and Karim is of interest because the method was tested both in the laboratory and the field. In the laboratory tests the following pier configurations were tested: round-nosed rectangular pier, square-nosed rectangular pier, and two cylindrical piers in a line. The number of sacrificial piles varied from 1 to 6. Both piles that protruded above the water surface (the usual case) and submerged piles were tested. The pier and piles were subjected to flows that resulted in conditions ranging from clear-water scour to scour with a fully mobile bed. As much as a 27 percent reduction of scour depth was realized in the laboratory. These data were all collected from experiments of short duration.

The field studies were conducted on a bridge over the Big Sioux River, South Dakota. The bridge is supported on three pairs of circular piers. Three piles were driven upstream of one of these in a triangular pattern. The pile spacing was about three pile diameters. As much as a 44 percent reduction in scour depth was realized in the field.

Three more recent papers in which sacrificial piles are mentioned are Herbertson and Ibrahim (1992), Paice and Hey (1993) and Wang (1994). The paper by Paice and Hey is of particular interest because it includes both laboratory and field studies. A diamond-shaped configuration of piles was tested in the laboratory, and found to result in a reduction in scour depth of as much as 63 percent. Pile groups were then installed at three different field sites. By the time of writing, none of the sites had been subjected to floods of the magnitude necessary to test performance. One of the bridges, however, is on a tidal reach of the Severn River. Preliminary data gathered over five tidal cycles support the claim that sacrificial piles reduce scour at bridge piers.

It would appear that a reasonable amount of information is available concerning the performance of sacrificial piles. Their performance at poorly aligned piers has not, however, been adequately investigated. The laboratory tests were all conducted for rather short durations and it is not known whether the apparently encouraging results are representative of genuine scour depth reductions or only reductions in the rate of scour. The effects of debris contamination of the piles also needs investigation. Other aspects needing investigation are possible aesthetic disadvantages and the use of sacrificial piles at bridge pier sites in navigation channels.

**Upstream sheetpiles.** The classic study for this case is due to Levi and Luna (1961). The study focuses upon a single obstacle located upstream of a rectangular bridge pier with sharp leading and trailing noses. A variety of aspect ratios for the obstacle were tried. The case of aspect ratios near unity in fact corresponds to a single sacrificial pile. Of more interest, however, is the case for which the lateral dimension is much greater than the longitudinal dimension. In this case the obstacle takes the form of a sheetpile; a reduction in scour depth of 40 percent or more was commonly realized. Photographs provided in the paper indicate that deposition was induced in the lee of the sheetpile, thus alleviating the scour at the bridge pier immediately behind.

Maza (1967) also comments on the experiments of Levi and Luna (1961). Maza suggests that the width of the screen should be equal to the bridge pier, and that it need protrude above the bed only one-third of the depth in order to perform adequately. A reduction in scour depth of as much as 70 percent is indicated for this configuration. It is indicated, however, that the countermeasure may not be very effective when the approach flow is skewed.

Maza (1967) reports on a variation of sheetpile structure which he calls an inclined screen. Details concerning this countermeasure are rather sketchy.

Protective sheetpiles (Figure 2.7) do not appear to have been explored further in the literature. This notwithstanding, there is a large body of literature on permeable dikes and snow fences that would suggest that a porous design that allows some of the water and sediment to pass through might be more effective. The sheetpile could consist of three partially encompassing panels so as to provide protection when the angle of attack is skewed. Design problems requiring further analysis include a) the effect of varying depth on sheet pile performance and b) the effect of debris on the sheet pile.

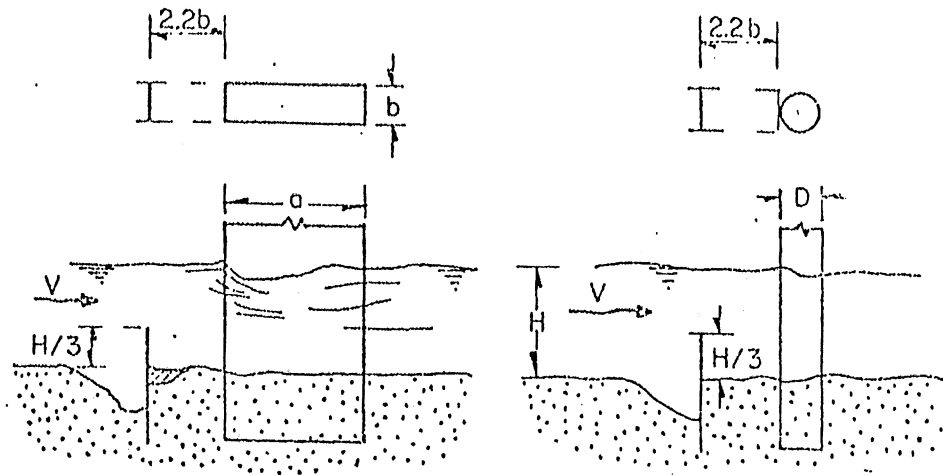


Figure 2.7. Upstream sheet pile.

**Collars and horizontal plates.** A collar consists of a thin, round horizontal plate or disc placed on a bridge pier above (or below) the erodible bed (Figure 2.8). The use of such a device to control scour was suggested by e.g. Chabert and Engeldinger (1956). This work inspired two more groundbreaking papers, i.e. Thomas (1967) and Tanaka and Yano (1967). Thomas explains the role of the disc as essentially that of suppressing the downwelling and upwelling of flow associated with the formation of the horseshoe vortex. The suppression of the horseshoe vortex in turn suppresses scour. Tanaka and Yano provide an extensive data base illustrating the conditions under which the disc is effective in reducing scour.

Three more extensive laboratory studies of collars can be found in Ettema (1980), Dargahi (1987), and Chiew (1992a). Ettema obtained a 50 percent reduction in scour depth when a circular collar was placed somewhat below the mean bed level. Dargahi obtained an even greater reduction in scour with a non-circular "Joukowski collar". Chiew has organized his data together with those of Tanaka and Yano and Ettema to devise a dimensionless diagram expressing the effectiveness of a collar. The three dimensionless parameters are the ratio of equilibrium scour depth with and without the collar (dependent variable) against the elevation of the collar above the bed divided by the flow depth and the ratio of collar width to pier width (independent variables). The collar appears to be most efficient when it is positioned somewhat below the mean depth of flow, and when the ratio of collar width to pier width is greater than 2.

Chiew (1992) found that the combination of a collar with a slot in the bridge pier was particularly effective in reducing scour. Fotherby (1992), while not performing experiments on collars, has provided several dimensionless graphs that include nearly all the data base (Thomas, Tanaka and Yano, Ettema and Chiew), and which can be used as a basis for a partial design.

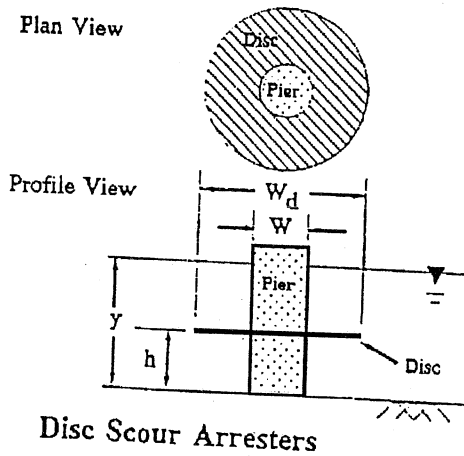


Figure 2.8. Collar.

A field test of a collar does not appear to have been performed. There are, however, several problems associated with collars that must be considered in the laboratory before a field installation could be considered. The first of these concerns positioning. The vertical positioning of the collar must be within a rather precise range in order to obtain maximum performance. In particular, the collar should be placed somewhat below the mean elevation of the bed, the precise location being as yet undetermined. In a reach that undergoes significant scour and fill, a single disc would likely be insufficient to protect against the entire range of high flows. (It is of value to note in this regard, however, that Chabert and Engeldinger, 1956, considered the case of multiple spanwise collars.) In addition, collars have the potential to catch debris.

**Flow-deflecting vanes or plates.** At least four such devices have been suggested as a means to reduce scour on bridge piers. The device with the longest tradition is the Iowa vane. Iowa vanes were first designed as submerged vertical flow deflectors placed along the bed of a stream that act to suppress secondary flow, and thus ultimately to suppress bank erosion on the outside of bends (Odgaard and Kennedy, 1983; Odgaard and Mosconi, 1987, Figure 2.9). Subsequent research led to the development of a slightly twisted shape for the vanes (Odgaard and Spoljaric, 1986). Odgaard and Wang (1991a,b) report the efficacy of Iowa vanes to prevent siltation at intakes, to reduce shoaling problems in navigation channels, and to improve flow conditions at diversions as well. Iowa vanes have been installed at a number of field sites, including some with bridges, and have performed creditably. Their use as a means of suppressing scour around bridge piers is documented in Odgaard and Wang (1987). The study suggests that they have promise as a scour control device, but data are limited.

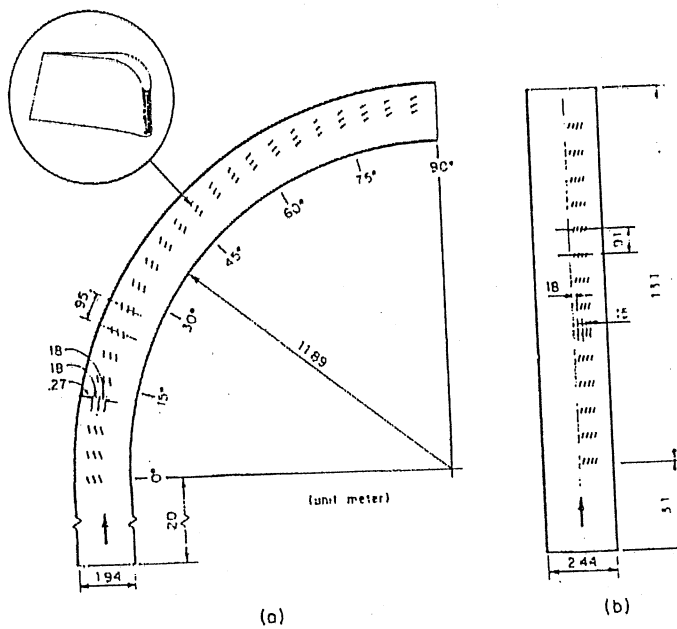


Figure 2.9. Iowa vanes.

The three other devices are rather more speculative. Mahavadi et al. (1996) report on the use of vertical plates to suppress pier scour (Figure 2.10). Each of two plates extends from one of the leading edge corners of a rectangular pier. In most configurations the plates were skewed to the direction of attack. They report that the vertical plates, when used in concert with riprap, could reduce scour by as much as 50 percent and limit the amount of riprap needed. The plates have an advantage over collars in that they can be driven into the streambed, and thus provide protection even when the channel is subject to varying degrees of general scour. A major potential disadvantage for vertical plates and all other flow deflecting devices is the potential to collect debris.

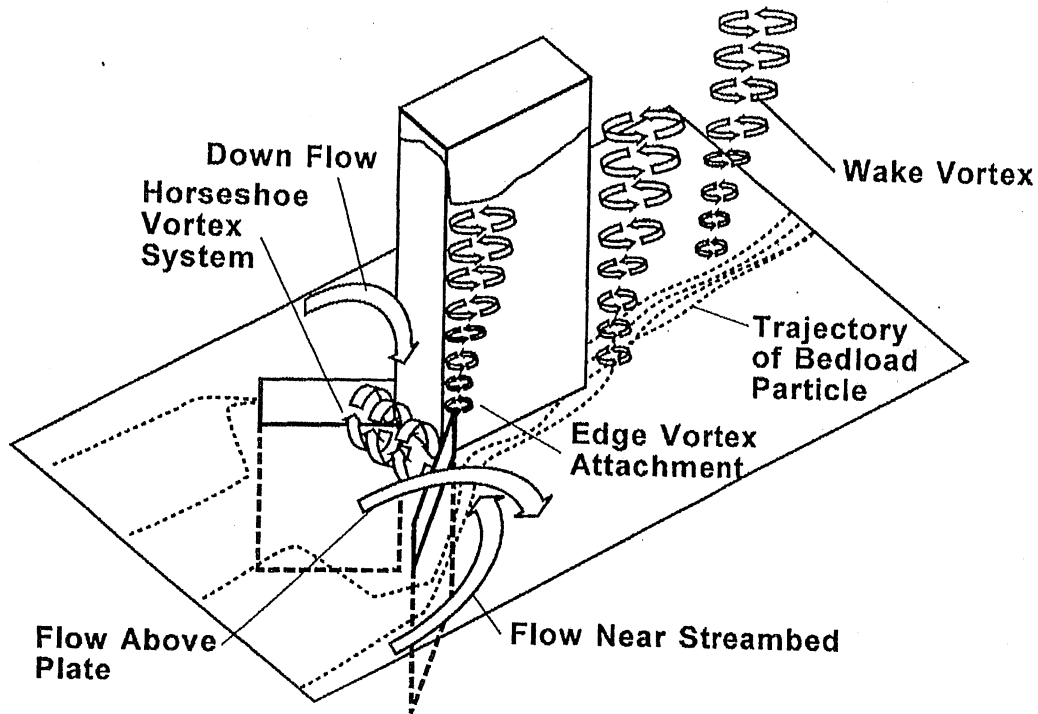


Figure 2.10. Vertical plates.

Gupta and Gangadharaiah (1992) report on the use of a plate in the form of a delta wing to suppress pier scour (Figure 2.11). The delta wing is placed horizontally, with the narrow leading edge associated with pier scour. They report reductions in scour depth ranging from 32 to 67 percent. Again, the potential for debris problems must be considered before a field installation could be tested. The device may have limited effectiveness in a reach subject to considerable general (e.g. contraction) scour.

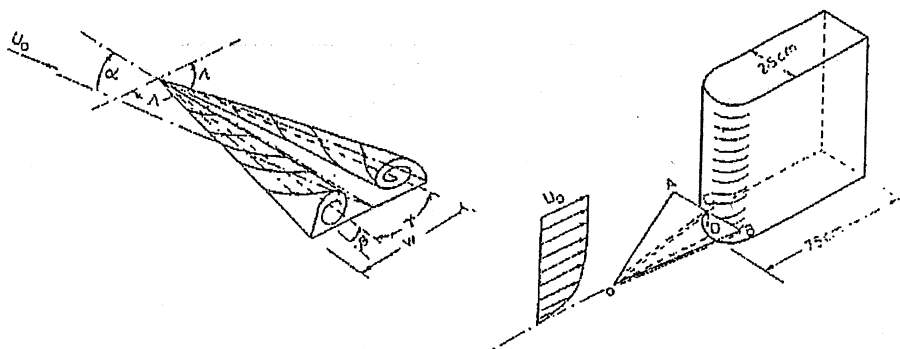


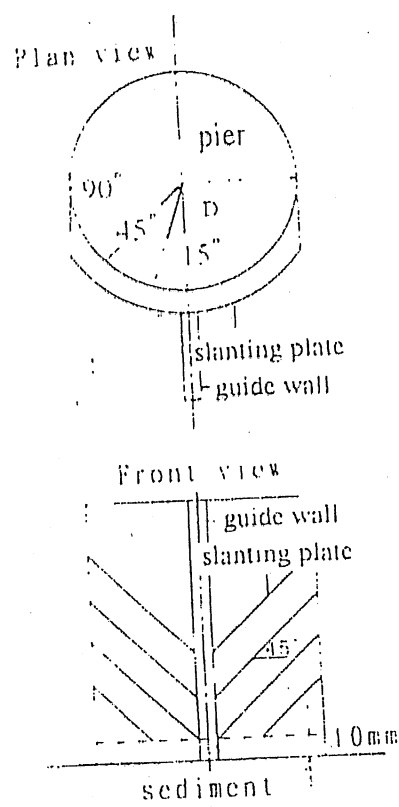
Figure 2.11. Delta wing plates.



Daido and Yano (1995) installed vanes directly on the pier (Figure 2.12). A vertical splitter wall is placed so that it extends upstream from the center of the pier. On either side of the splitter wall is a series of vanes attached to the surface of the pier, stacked vertically and angled upward in the downstream direction. The goal is the direct suppression of the downwelling zone of the horseshoe vortex. While the thirteen experiments reported therein do not allow for a complete evaluation of the technique, they report reductions in scour depth as high as 90 percent. The method clearly deserves more attention. Since the vanes can be placed along the entire pier length below a given depth, there need not be placement problems associated with general scour. In addition the vanes themselves do not extend much beyond the pier, and thus may not pose a substantial obstacle for the collection of debris. (The same consideration may, however, limit their effectiveness.)

While all four of the above-mentioned flow-deflecting plates appear promising, Iowa vanes and the pier-attached vanes of Daido and Yano may be the most profitable for future study.

Figure 2.12. Pier attached vanes.



**Modified pier shape or texture.** Among the many descriptions of potential techniques for the reduction of scour on bridge piers reported in Shen et al. (1966), mention is made of tests on a pier with a) a roughened upstream face and b) a roughened upstream face and apron. No significant reduction in scour was observed.

Neill (1973) and Breusers and Raudkivi (1991) report on bridge piers with a vertical taper. As might be expected, a pier that is tapered so that it is wide below and narrower above creates less of the vertical pressure gradient associated with the generation of the horseshoe vortex, and thus suppresses scour. Scour is exacerbated when the taper is reversed. The effectiveness of tapering may be sensitive to the angle of attack. The use of a circular cylindrical pier, rather than an elongated pier, is advantageous in limiting scour in that the former is completely unaffected by the skewness of flow.

Modified pier texture does not appear to be promising as a means of suppressing bridge scour. Modified pier shape may deserve more exploration as a technique. The taper may not be easily retrofitted, however, and may present structural problems as well.

Foundation rehabilitation, including extended footings, might also be classified as a modified pier shape. The topic is excluded from consideration in the present project, however.

**Slots in piers and pier groups.** Chiew (1992a) reports on the use of a slot in a bridge pier to reduce scour. The principle is the diversion of the downflow associated with the horseshoe vortex away from the bed (i.e. through the slot), thus reducing the intensity of the impinging downflow. The design was suggested by the successful performance of perforated breakwaters in the North Sea. An appropriately positioned slot with a gap width equal to one quarter of the pier width was effective in reducing the scour

depth by up to 20 percent. When the slot was combined with a collar, scour could in some cases be completely eliminated.

Chiew's tests of a slot, with or without a collar are encouraging, but hardly definitive in terms of design. The concept deserves further study. Potential problems as regards structural stability and debris accumulation can be foreseen.

Vittal et al. (1994) study a related scheme, according to which a single pier is replaced with a triangular group of much smaller round piers. The passage of flow between the piers suppress the horseshoe vortex, and thus scour, in the same way as the slot. The configuration of interest to the authors is one such that any one pier can pass through the gap of the other two. They claim a reduction in scour depth of about 40 percent. They find the technique to be more effective than a solid pier fitted with a slot equal to half the pier diameter. In addition, it was as effective as a solid pier fitted with a collar 3.5 times as wide as pier width.

The scheme of Vittal et al. appears to have promise. It is clearly related to the concept of sacrificial piles. The success of the technique is partially dependent upon whether or not a group of three smaller piers can provide the same structural stability as a single solid pier. The three smaller piers are likely to be much more expensive than the single larger pier.

***Suction applied to the bridge pier.*** Suction is known to be a successful technique in regard to aerodynamic boundary layer control. Rooney and Machemehl (1977) appear to be the only researchers to test the technique in the context of bridge piers. The embedded length of the pier was fitted with 30 drilled holes (six holes at each of five levels ranging from just above the sediment bed to below the surface of the bed) from which water could be extracted. Suction was created by pumping. Two rates of pumping were tested. At the low rate the scour was reduced by 50 percent. At the high rate it was eliminated completely. The study is interesting in that scour due to current-wave action as well as currents alone was investigated.

This single study suggests considerable unrealized potential for suction as a means to suppress scour. Optimism must be tempered, however, by recognition of the need to have a means of driving the pump at any field installation, and by the potential for clogging of the holes.

### **2.1.5 Conclusion**

This literature survey suggests a wide range of both armoring and flow-altering countermeasures that could be used to protect against scour at bridge piers. In particular, there appear to be a number of viable alternatives to riprap. This literature survey will provide one of several bodies of information to be used for classifying countermeasures according to a) the sufficiency and accuracy of design criteria for their use, b) the availability of field performance tests, and c) the likelihood that further research on the subject would lead to major improvements in design or the development of heretofore untried techniques.

## 2.2 COUNTERMEASURE SELECTION AND SCREENING

### 2.2.1 Introduction

This section describes the development and implementation of a screening approach for the various countermeasures identified in the **Literature Review** that constitute alternatives to riprap. It serves to fulfill Task 2 and Task 3 of the original Research Project Statement,

The 33 countermeasures selected for screening are listed below in alphabetical order. Riprap is included for the sake of comparison.

<ul style="list-style-type: none"> <li>• Alarm systems</li> <li>• Anchors</li> <li>• Articulated mattresses</li> <li>• Artificial riprap</li> <li>• Cable-tied blocks</li> <li>• Collars</li> <li>• Concrete or asphalt pavement</li> <li>• Concrete-filled mattresses</li> <li>• Delta-wing plates</li> <li>• Extended footings</li> <li>• Grouted riprap</li> </ul>	<ul style="list-style-type: none"> <li>• High-density riprap</li> <li>• Horizontal plates</li> <li>• Iowa vanes</li> <li>• Modified pier texture</li> <li>• Modified upstream pier face</li> <li>• Modular paving units</li> <li>• Monitoring during floods</li> <li>• Peak flood bridge closure</li> <li>• Pier-attached vanes</li> <li>• Riprap</li> <li>• Rock bolting and grouting</li> </ul>	<ul style="list-style-type: none"> <li>• Rock-filled gabions</li> <li>• Sacked concrete (concrete bags)</li> <li>• Sacrificial piles</li> <li>• Self-launching riprap</li> <li>• Sheet piles</li> <li>• Slots in pier</li> <li>• Suction applied to pier</li> <li>• Tile mats</li> <li>• Tri-lock blocks</li> <li>• Vehicle restriction</li> <li>• Vertical plates</li> </ul>
---	---	---

Since the nature of the information available to the research team presented potential subjectivity problems, screening of potential countermeasures selected from the literature survey was conducted independently by each of six team members. This technique created the additional benefit of allowing for an objective calculation of a standard deviation of the responses to all questions in the survey. This standard deviation provided an indication of the level of consensus pertaining to any specific countermeasure.

A questionnaire was developed and mailed to over 170 individuals at state and federal highway agencies, as well as private consultants. This questionnaire served as an aid to research team members for ranking countermeasures by providing up-to-date information on the success of specific countermeasures which have been implemented by particular agencies.

The compilation of the results of the screening, in conjunction with the wealth of information received from the literature survey and questionnaire responses, provides a good basis upon which to select countermeasures for further study. This chapter describes the results of (1) countermeasure screening, (2) ranking in order of the total scoring for each countermeasure, (3) a descriptive summary of the ratings for each countermeasure, and (4) survey highlights.

### 2.2.2 Screening Approach

The basis for the criteria used to screen each of the above countermeasures is delineated below. The approach itself is outlined in the following three pages. Points were assigned to each of the rating criteria by each of six team members. Following the approach are twelve pages showing the mean rating for each

of the criteria as applied to each of the 33 countermeasures. The final page of this section (Countermeasure Selection & Screening) outlines how the methodology was implemented.

### 2.2.2a Definitions for Screening Criteria

Feasibility- For a given situation is the method or technique applicable.

Effectiveness - When is the method technically effective (Does it reduce scour for a single event or season.) (Under how wide of range is the method effective)

Constructability - Does the method require specialized labor, supplies or placement equipment or can it be done using standard equipment and readily available materials. This obviously must allow for some regional variation. Environmental constraints.

Durability - is the method capable of working for a period of several flood seasons without requiring replacement or repair.

Maintainability - is the method easily maintained or does it require specialized equipment and supplies. Frequency of maintenance period required by method.

Cost - Self evident, should include original and maintenance cost on a \$/effective reliable pier year basis.

Special - Includes specific considerations of the countermeasure which merit special credit or penalties. Social and Environmental acceptability are included as separate sub items.

Screening Methodology

**Step 1: Feasibility**  
applicable)

(under which of the following conditions is the technique

a. Site Characteristics

limited application <-----> Widely applicable  
(1 pt) (8 pts)

Bed characteristics

Type of stream

- Cobble bed \_\_\_\_\_ pts
- gravel bed \_\_\_\_\_ pts
- sand bed \_\_\_\_\_ pts
- bedrock \_\_\_\_\_ pts
- cohesive bed \_\_\_\_\_ pts
- heavily silted (mucky) \_\_\_\_\_ pts

Pier position

- Main span \_\_\_\_\_ pts
- Flood Plain \_\_\_\_\_ pts
- Adjacent to abutment \_\_\_\_\_ pts

Channel configuration

- Split \_\_\_\_\_ pts
- Single \_\_\_\_\_ pts

b. Hydrograph Characteristics

limited application <-----> Widely applicable  
(1 pt) (10 pts)

- Flashy \_\_\_\_\_ pts (500 sq. mi. or less) time of concentration < 1 day
- Moderate \_\_\_\_\_ pts (500 - 20,000 sq. mi.) 1 day to 1 week
- Long term \_\_\_\_\_ pts (20,000 mi<sup>2</sup> + ?) > 1 week
- Ephemeral \_\_\_\_\_ pts
- Tidal \_\_\_\_\_ pts

c. Bridge Type

limited application <-----> Widely applicable  
(2 pts) (20 pts)

- New construction \_\_\_\_\_ pts
- Protection on existing bridge \_\_\_\_\_ pts

d. Other Factors

very susceptible<---->not susceptible  
0 pts (5 pts)

- Ice susceptibility \_\_\_\_\_ pts
- Debris susceptibility \_\_\_\_\_ pts
- Salt water \_\_\_\_\_ pts
- Regional problems \_\_\_\_\_ pts

**Step 2: Technical Effectiveness**

limited <-----> wide ranging  
2 pts 25 pts

- Hydraulic \_\_\_\_\_ pts
- Geotechnical \_\_\_\_\_ pts
- Geomorphic \_\_\_\_\_ pts

Hydrologic \_\_\_\_\_ pts  
 Climatic \_\_\_\_\_ pts  
 Structural \_\_\_\_\_ pts  
 Synergistic Effects \_\_\_\_\_ pts  
 Inspectability \_\_\_\_\_ pts

**Step 3: Difficulty in construction**

low <-----> average <-----> high  
 30 pts                      15 pts                      0 pts

Level of expertise required \_\_\_\_\_ pts  
 Need for specialized equipment \_\_\_\_\_ pts  
 Extraordinary construction time \_\_\_\_\_ pts  
 Environmental Impacts \_\_\_\_\_ pts

**Step 4: Durability**

Short <-----> Medium <-----> Long  
 5 yrs                      10 yrs                      20 yrs  
 20 pts                      40 pts                      80pts

Length of period method works \_\_\_\_\_ pts  
 without maintenance

(guideline 4 pts/year (max. 120 pts))

**Step 5: Difficulty with Maintenance**

low <-----> average <-----> high  
 120 pts 60 pts                      0 pts

Difficulty with maintenance \_\_\_\_\_ pts

**Step 6: Cost**

\$\_\_\_\_/pier protection year (It is expected that regional variation will exist)

low <-----> average <-----> high  
 120 pts 60 pts                      0 pts

Relative cost basis \_\_\_\_\_ pts

**Step 7: Special Factors**

Acceptability

Socially Acceptable	_____ pts	5 pts	Acceptable <-----> Pleasing
Aesthetics	_____ pts	5 pts	15 pts
Environmentally acceptable	_____ pts	5 pts	15 pts
			30 pts

Specific Considerations (Define below)

Detrimental <-----> Highly Beneficial  
 - 60 pts                      + 60 pts

Score: \_\_\_\_\_ pts

**TOTAL SCORE : \_\_\_\_\_ pts.**

The screening methodology was implemented as follows

1. Evaluate bridges based on 7 criteria using the screening procedure developed. Each individual response inherently involved some subjectivity; however, having responses from several team members minimized subjectivity effects.
2. Summarize rankings of all countermeasures for individual criteria.
3. Summarize combined cumulative criteria rankings of all countermeasures.
4. Conduct summary of cost per effective pier protection year for each method where data is available.
5. Combine results of this procedure with bridge data obtained from the survey and elsewhere to develop a potential dollar savings to the bridge community.
6. Review ranking from (5) to assess whether a countermeasure needs further technical work or simply better dissemination of information.
7. If further technical work is needed, select these based on potential savings to industry times the percentage likelihood of success in development, (i.e., a method requiring a minimal amount of additional "testing" will rank higher than a method with little chance for technical success under the scope of this project).

### **2.2.3 Descriptive Summary of the Rating for each Countermeasure**

Reliable and available cost data for implementing specific countermeasures was unfortunately extremely limited; as a result, it was not possible to complete items (4) and (5) of the methodology implementation to the extent originally intended. It is apparent from the questionnaires returned that some states have excellent case history data, including cost information, while others use riprap because it has historically been used. An evaluation providing the most cost-effective means of scour protection is an essential element of countermeasure selection in the future. For the purpose of the survey, however, the cost element aspect of the screening has been based on relative information available at the time of the survey.

The detailed results for each survey are reported in Tables 2.4 and 2.5. Figure 2.13 summarizes the score of each countermeasure, expressed as a percentage of total points possible. The ranking of the various countermeasures ranges from riprap, scoring 62 percent of the total points possible, to tile mats, scoring 32 percent. Each individual team member made a conscious effort to reduce any bias due to their being more knowledgeable about some countermeasures and less knowledgeable about others. To avoid skewing the points from scorer to scorer, i.e. those who might lean toward scoring higher and those who might score measures lower overall, a normalization was conducted to adjust the scores of each team member to a comparable basis. Each countermeasure was evaluated for its effectiveness pertinent to each of the parameters used in the screening. The countermeasures are listed in descending order of percent scored to provide a relative "ranking." Rankings do not imply effectiveness or preference but rather illustrate the relative positioning of all potential countermeasures for further evaluation.

The graphical representation of Figure 2.13 summarizes the overall ranking of the 33 scour countermeasures evaluated in the screening. From this summary, it is apparent that no countermeasure scored above 65% of the total possible points available to the hypothetical perfect countermeasure. A factor which must be understood, and which was clear from the returned questionnaires, is that variation in site specific characteristics from region to region or from bridge to bridge causes the selection of a particular countermeasures to vary. The rankings based in part on the survey, therefore, should not be interpreted to mean that riprap is twice as effective or preferred as tile mats. However, the rankings do strongly indicate that all scour countermeasures, including riprap, have a number of areas for which further technical information will benefit engineers in the field.

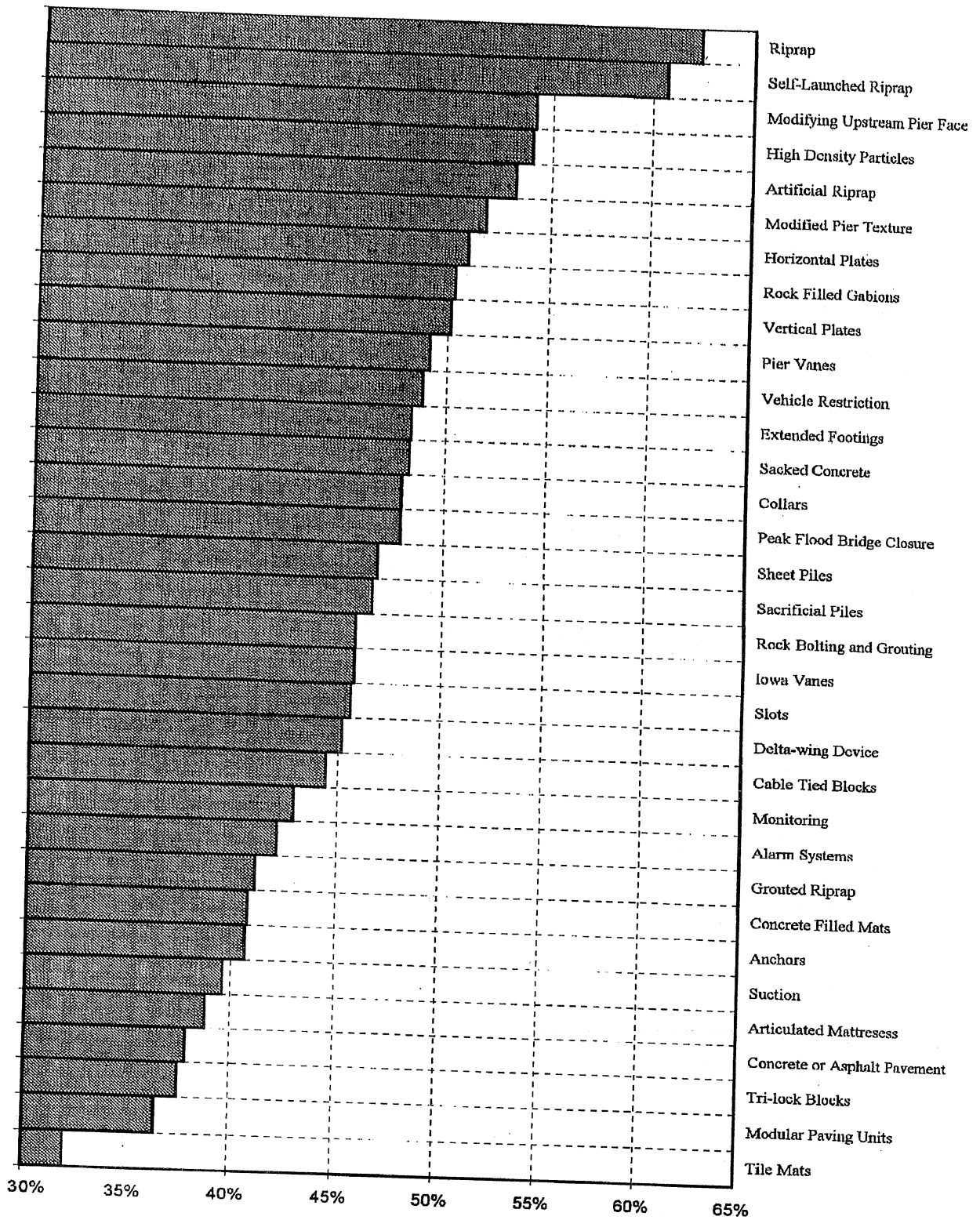


Figure 2.13. Summary of average rankings.



Riprap scored most favorably, no doubt in part due to the familiarity of all team members with its use as a countermeasure. This is the historic countermeasure of choice by most agencies and, as such, experience with it far outdistances any other countermeasure. This is not to imply that it is the best countermeasure for any given application. The screening ranked riprap well above the mean as regards to effectiveness on all foundations except bedrock. In addition it was thought to work reasonably well regardless of channel configuration, pier position, or hydrograph characteristics. While riprap can be placed as part of new construction, it was found to be typically used more on existing bridges. Debris is less likely to be a problem than with many other countermeasures; however, regional problems exist due to the availability of suitable rock. Riprap ranked favorably in all technical effectiveness categories, with a noticeably high scoring in synergistic effects. Riprap, as the method with the most history, requires little specialized expertise or equipment, and in most cases minimal time for installation. Riprap was listed among the most durable countermeasure, and tied with dumped riprap as relatively the most cost effective, possibly for no other reason than it is the best known method. While found to be socially acceptable, it fell below average as regards aesthetics and environmental acceptability.

The use of anchors or reinforced soil ranked 27th. They were judged to be feasible in limited foundation conditions, and to require specialized expertise and equipment. As this method typically involves no blockage to the water passageway, they scored favorably in categories such as debris, hydraulic performance, aesthetics, and social and environmental acceptability. For the same reason, the technique should not be affected by ice but would be difficult to inspect.

The term articulated concrete mattress is chosen in the context of systems utilizing large tied blocks, as is typical of many U.S. Army Corps of Engineers bank protection applications. Such a mattress may be viewed as a large version of cable tied blocks, and so scored similarly, placing 28th. While exhibiting good individual block stability, the technique was evaluated to be less feasible for ephemeral, flashy, or moderate hydrograph streams. Other concerns centered around the ability of articulated concrete mattresses to effectively envelop a pier and prevent gap-induced scour.

Artificial riprap (tetrapods, dolos, etc.) scored very favorably, ranking 5th. This method placed significantly above the mean in most areas, and garnered particularly good scores for durability and maintenance requirements. Among its weaker points were environmental impact effects and possible lengthy installation time.

Cable tied concrete blocks, based primarily on anecdotal information, ranked slightly ahead of concrete filled fabric mats at 22nd. The method was felt to exhibit favorable characteristics for ephemeral, flashy, and moderate hydrograph streams, as well as floodplain installations. Due to material durability concerns, it scored poorly for salt water applications. The team also has concerns for the level of expertise required and the need for specialized installation equipment. Another concern was maintenance factors relating to the level of repairs required if a cable or cables should rupture. A very positive item for this countermeasure was the potential for directly attaching a geotextile filter to the bottom of the system.

A variation on the driven pile theme is collars or caissons which ranked 14th. When placed around the bridge pier, these may prove the most functional of the group. Primarily limited to new bridges, caissons may be effective on silt or cohesive foundations. While some additional time would be required for construction, installation of caissons would utilize existing technology. Application may be limited or not feasible where bridge piers are closely spaced because flow blockage caused by the caissons would become problematic.

Concrete filled fabric mats, placing 26th overall, were evaluated to have less feasibility than conventional riprap for some bed conditions. In particular, keying-in the mats on bedrock was questioned. They scored among the best of the alternatives to riprap for heavily silted soils, however. They scored on par with many of the techniques for most evaluation criteria, but fell generally short in environmental and acceptability areas. In addition, cost and maintenance factors were significant in their low placement. Is it necessary to replace the whole mat as part of the repair process? If so, this could be very costly on a

continuing basis. Mats did rate well as regards debris susceptibility. They may cause less disruption of the bed than riprap.

A variation on the horizontal plate theme is a delta wing type device, which ranked 21st. It was viewed as having many of the same features as a horizontal plate, but was viewed less favorably in environments susceptible to ice and debris. Additionally, it scored unfavorably for level of expertise required for proper installation. While little is known about such a device, it is expected that correct positioning is critical if the countermeasure is to assist rather than exacerbates the scour problem.

Extended footings, ranking 12th overall, scored favorably for feasibility in tidal applications and synergistic effects. Their stand-alone feasibility scored below the mean for sand bed and heavily silted bed foundation conditions. By default, their primary application is limited to new construction. Extended footings are not susceptible to ice and require no specialized construction equipment or expertise but do require extended construction time. The nature of extended footings makes them as durable as the bridge piers themselves, but they are relatively costly to install. Being generally out of sight, they score well on social acceptability and aesthetics.

Concrete grouted riprap placed low in the overall ranking at 27th. The method scored poorly on feasibility for use with finer grain sediments such as silt. It received an unfavorable rating for synergistic effects and environmental impacts caused during construction. The limited information available has indicated that durability and maintenance may be more problematic than many other methods. Concrete grouted riprap has been relatively cost effective but scores poorly on aesthetics and environmental acceptability.

While little information is available, high density particles ranked 4th based on their potential for future use. Having most of the characteristics of conventional riprap but having increased stability due to greater density and thereby creating less blockage to the flow passageway at bridges, high density particles were given a good specific consideration score. The method was also judged to do well on aesthetics based on its potential for reduced protrusion and relatively easy maintenance. Disadvantages included poor feasibility or unsuitability for use on heavily silted foundation conditions, as well as possible environmental impacts.

Horizontal plates placed 7th, primarily due to generally solid scores in most all categories. Like most other flow altering countermeasures, they are somewhat better suited to main span bridges than to floodplain applications, if for no other reason than the more extended periods of use demanded by a scour countermeasure implemented on the main span. Exposed horizontal plates are naturally subject to potential debris and ice problems, but with proper material selection may be quite adaptable and insensitive to salt water.

Iowa vanes were originally designed as a technique for bank protection; however, they are potentially suited for use as a bridge pier scour countermeasure. The technique placed 19th with low ratings for ice and debris problems. The method also requires an above-average level of expertise to correctly implement. With proper technique and positioning flow guidance systems, Iowa vanes could be effective in mitigating bridge pier induced scour.

Modified pier texture placed 6th due in large part to a very high score for minimal equipment needs, and correspondingly low environmental impact during construction, reliable durability, and an acceptable (low) relative cost basis. Questions remain as to the technical effectiveness of this countermeasure, such as the use of a countermeasure on a microscopic scale to correct a macroscopic problem.

Another technique which directly affects bed scour production at piers is modification of the upstream face of the pier, such as rounding. This is not viewed by all to be a "countermeasure," but in the view of the project team and others who have researched the topic, it is among the most effective techniques. It ranked 3rd overall based on strong performances in many categories. As a method which reduces the scour-producing mechanism rather than mitigating the scour production by the mechanism, it shows promise for all types of foundation conditions, and maintains excellent synergistic effects. Since the method would involve direct modification to the pier, it is primarily suited to new bridges. However, it is

applicable under most hydrologic and climatic conditions, is reliably durable, and can be readily inspected. The nature of the countermeasure limits its effectiveness to stable non-shifting channels, and performance is highly subject to skewing of the approach flow angle. Viewed by the general public as a bridge pier rather than a countermeasure, aesthetics and social and environmental acceptability were rated favorably.

Modular paving units constitute another variation on the theme of tile mats and articulated erosion control block systems. For similar technical reasons (limited feasibility and high costs) as with tri-locks outlined below, they ranked next to last at 32nd. They are construed to be somewhat more costly than concrete erosion control systems such as tri-lock, but may be viewed as more aesthetically acceptable.

Pavement or asphalt paving is limited in application to the ephemeral rivers of the arid southwest and for that reason ranks near the bottom at 30th. The technique may be cost effective for suitable applications. Further assessment of its performance and its predominant mode of failure should prove beneficial to the bridge scour community in arid environments.

A potential technique whereby a series of angular positioned plates, i.e. Pier vanes, are placed along the face of a pier in a manner that hydrodynamically redistributes the downflow, and ultimately reduces the scour inducing horseshoe vortex, placed 10th in the evaluation. The plates may prove advantageous for heavily silted beds where other countermeasures are limited. The plates could be mounted with minimal construction disturbance which would render them more environmentally favorable than many other techniques. The fact that the plates protrude from the face of the pier would make them susceptible to debris and ice. It is anticipated that such a system would require specialized expertise and have some problems with durability. By the nature of the design the plates would be less effective for tidal or angularly varying flows or flows with strongly varying angles of attack.

A measure similar to anchors or reinforced soil, rock bolting and grouting, placed 18th. This countermeasure is limited to bedrock foundations. The technique is difficult to inspect, requires specialized expertise and equipment, and is limited to new bridges. It is structurally sound and reliably durable. In addition, it ranked high on hydraulic and climatic performance, as well as environmental acceptability.

Rockfilled gabions scored reasonably well, placing 8th among the 33 countermeasures. The feasibility of placement in deeper channels is questionable. Gabions appear to be well suited for ephemeral streams. However, due to the materials typically used, some saltwater problems are expected. Gabions were viewed favorably on most technical effectiveness categories, except for the ability to synergise with other countermeasures. By their nature, they are comparably easy and inexpensive to install and are viewed relatively environmentally favorable. They typically need some maintenance, however.

Sacked concrete scored 13th overall. Its high ranking was aided by strong scores due to the minimal need for expertise or equipment, and for its rapid implementation. Although relatively cost effective, sacked concrete may have problems with water quality (particularly salt) and climatic conditions. The sacked concrete method rates unfavorably for environmental acceptability and fares among the poorest for aesthetics and social acceptability.

Sacrificial piles ranked in the middle at 17th, with their primary benefit being quick implementation. Several disadvantages include an inability to drive piles in certain types of foundation conditions such as bedrock and cobbles, problems with debris, their questionable durability, undesirable aesthetics and negative social acceptability.

As one might expect, self launching or dumped riprap scored similar to conventional riprap, placing second with minor variations. Among the differences noted were a slight decrease in the potential effectiveness on cobble, gravel and cohesive bed streams, as well as location feasibility. It scored relatively comparably in terms of hydrograph suitability, but was deemed less functional in tidal situations. Due to its method of placement it was indeed more susceptible to the effects of ice, debris, and climate, and was deemed less synergistic than riprap. Construction may require some additional expertise but can be rapidly implemented. Lastly, it may be viewed by the public to lack aesthetic ambience.

Non-sacrificial sheet piles placed 16th with essentially the same problems as sacrificial piles. While effective in some applications, they were viewed as socially and aesthetically undesirable.

Slots within the pier, designed to reduce the pressure differential which causes detrimental flow patterns, are experimental at this point. However, they could prove effective if pier size is not increased dramatically to structurally accommodate the slots. Even though ranking below the mean at 20th, slots scored well for use on heavily silted beds where other methods may have problems. They also ranked high for environmental acceptability and for ephemeral and flashy streams, where exposure makes other countermeasures less desirable. This technique is strictly limited to new construction and is likely to encounter problems with ice and debris.

Suction ranked near the bottom at 28th with a poor score in the general area of feasibility under a range of hydrologic conditions. The design of such a countermeasure necessitates a clean, submerged tap for the system to operate properly; hence, debris is particularly problematic in that small branches which otherwise would cause no problems can clog intake ports, rendering the system useless. For this reason, durability and maintenance received low scores. The team members believed that a high level of expertise is required for proper positioning of the portals, again resulting in a low score.

Tile mats placed last among the countermeasures evaluated, mostly due to a perception of very limited feasibility and an exceptionally high relative cost basis. Tile mats appear to be an expensive and labor intensive technique that other mat techniques can replicate more cost effectively.

Tri-lock articulated erosion control systems ranked near the bottom at 31st. They were deemed similar to tile mats, in that both need to be placed on a relatively smooth bed in dry or nearly dry conditions. These factors limit their application. Unit cost would be less than tile mats, and some potential floodplain or ephemeral stream applications could exist where the blocks can be grassed over in an aesthetically pleasing fashion. Some of the team members have experience with a variety of similar systems and have found a general inability for such systems to withstand any bed degradation or bed shifting. Once topographic changes have occurred, the blocks become unstable and can be plucked from the matrix, after which unraveling can lead to catastrophic failure of the countermeasure.

Vertical plates on the upstream face of the pier ranked 9th overall. The general consensus was that while not in present use, such a countermeasure may be effective in reducing scour. Any implementation of a plate-like apparatus on the upstream face of the pier is inherently subject to debris problems.

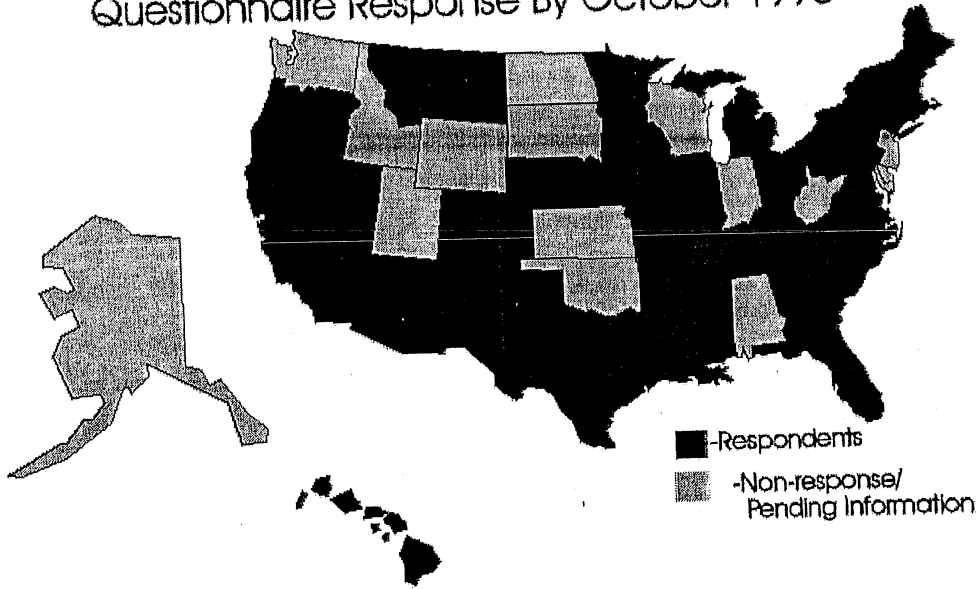
Four other solutions to alleviate public endangerment caused by bridge scour were also listed in the screening, but are questionable countermeasures in the context of NCHRP Project 24-7. These are scour monitoring, alarm systems, bridge closure and vehicle restriction. These are not physical countermeasures which prevent scour, but rather countermeasures which prevent human casualties.

#### **2.2.4 Survey Highlights**

This section highlights the results of the questionnaire survey sent out in September 1995. A copy of the questionnaire follows at the end of this section.

Responses containing significant information were received from 35 states. In addition, other states responded, indicating that the state was presently accumulating information but did not yet have it compiled. The information received has proven invaluable to the project team throughout the course of the NCHRP 24-7 project. Excellent geographic coverage was attained (see U.S. map), with all regions of the United States represented. Following is a list of states from which in-depth responses were received.

# Questionnaire Response By October 1995



## NCHRP 24-7 Questionnaire Respondents

Arizona	Iowa	Missouri	Oregon
Arkansas	Kentucky	Montana	Pennsylvania
California	Louisiana	Nebraska	Rhode Island
Colorado	Maine	Nevada	South Carolina
Connecticut	Maryland	New Hampshire	Tennessee
Florida	Massachusetts	New Mexico	Texas
Georgia	Michigan	New York	Vermont
Hawaii	Minnesota	North Carolina	Virginia
Illinois	Mississippi	Ohio	

The survey encompassed a total of 220,057 bridges with the foundation characteristics as follows:

**Table 2.1.** Total bridges surveyed  
(Percentage by Foundation Type)

Sediment Type	Percent
Sand	46.0
Cohesive	22.3
Mixed	11.2
Gravel	10.0
Bedrock	6.0
Uncertain	4.3
Silt	0.1

Of these bridges, the following percentages were summarized by foundation condition as experiencing some degree of scour.

**Table 2.2.** Bridges with scour problems  
(Percentage by Foundation Type)

Sediment Type	Percent
Sand	48.2
Cohesive	18.6
Mixed	13.6
Gravel	10.2
Uncertain	4.9
Bedrock	4.6
Silt	0.0

It can be seen from the above two tables that the percentages according to type of bridges, with scour problems do not differ strongly from the percentages according to type for all bridges. For example, while 46 percent of all bridges in the survey are on sand, 48.2 percent of bridges with scour problems are on sand. Small though the difference may be, it is likely sufficiently significant to warrant further in-depth study. Such a study can provide further insight into the foundation type most susceptible to scour. A simple analysis of the above two tables, however, suggests at least the following questions:

- Are bridges on cohesive foundations 17 percent less likely to have scour problems than bridges in general?
- Are bridges founded on sand 5 percent more likely to have scour problems?
- Are silt foundations as uncommon as indicated by the tables?
- Or do the responses reflect some inconsistency in either record keeping or perception?

The following table summarizes the scour countermeasures listed as having been tried by the respondents to the questionnaire. It was calculated that a total of 36,513 bridges of the 220,057 in the survey have some type of countermeasure, including monitoring. Of this total, 8,606 bridges have some type of physical countermeasure.

Table 2.3. Scour countermeasures used by survey respondents

Countermeasure Name	Nr	Percent
Dumped riprap	5913	16.19
Self launching riprap	72	0.20
Rock gabions	567	1.55
Other flexible revetment	37	0.10
Pavement	253	0.69
Sacked concrete	97	0.27
Concrete-grouted riprap	27	0.07
Concrete-filled mat	51	0.14
Tetrapods	1	0.00
Extended footings	778	2.13
Cable tied blocks	6	0.02
Tile mats	0	0.00
High density particles	0	0.00
Vanes (pier or bed)	1	0.00
Sacrificial Piles	22	0.06
Slots	0	0.00
Flow direction plates	6	0.02
Modified pier texture	0	0.00
Anchors	0	0.00
Jetties	43	0.11
Spurs	420	1.15
Retards	35	0.10
Check dams	93	0.25
Rock bank protection	79	0.22
Rubble	6	0.02
Bank protection	3	0.01

Countermeasure Name	Nr	Percent
Other methods		
Soil cement	7	0.02
Palisades	1	0.00
Grout filled	0	0.00
Underpinning	2	0.01
Overflow barbs	4	0.01
Flow diversion (or relief)	22	0.06
Adding subcaps and piles	1	0.00
Adding pile bents	0	0.00
Grouting under footings	0	0.00
Replace bridge	0	0.00
Remove pier and replace superstructure	2	0.01
Make span bridge continuous	2	0.01
Brace piles in transverser director	5	0.01
Pile bent **	2	0.01
Monitoring	27770	76.06
Alarm systems	22	0.06
Bridge closure	111	0.30
Vehicle restriction	0	0.00
Other	24	0.06

\*\* Pile bent: Anchor bent vs. lateral movement. by casting concrete encasement around piles and anchored into rock with grouted dowels

As seen in the above table, dumped riprap constitutes nearly 70 percent of all physical countermeasures installed in the U.S. at this time. The team was pleased to see that over 30 different types of countermeasures have been installed in the field. The following quotes derived from the completed questionnaires are provided as general interest items:

- "Unwilling to invest funds in unfamiliar methods."
- "The majority of problem bridges are not on stable streams but rather on streams that meander a lot."
- "Few scour problems with the exception of stream stability."
- "The majority of bridges have experienced stream stability problems, not scour."
- "A number of scour problems we have encountered were due to debris."
- "Why only stable streams?"

In addition to those comments listed above, several others noted that most of the problems in these states were with unstable streams.

Questionnaire NCHRP 24-7

**Effectiveness of Countermeasures to  
Protect Bridge Piers from Scour**

State:  
Name (Optional):  
Company/Agency:  
Address:

Telephone No.:            Area Code ( ) - \_\_\_\_\_  
FAX No.                    Area Code ( ) - \_\_\_\_\_  
E-mail address:           .....

This survey will be considered in evaluating countermeasures to mitigate scour at bridge piers. Your experience is very important. Please attach any comments you feel are valuable to the bridge community, whether they are specifically addressed or not. For example, these may include successful or unsuccessful implementations of bridge scour mitigation techniques. As part of the project, several team members will be undertaking site visits of bridges in all regions of the United States. Please help us to identify examples of traditional or novel scour mitigation techniques, and both successful and unsuccessful applications of them for possible site visits.

1. Classify your experience level as it relates to scour at bridges:

<b>Number of Bridges:</b>	<b>Over 20</b>	<b>10 to 20</b>	<b>5 to 10</b>	<b>2 to 5</b>	<b>1 or less</b>
Scour Evaluations					
Bridge (scour) inspections					
Mitigation Measures					

Number of bridges in your jurisdiction \_\_\_\_\_.

2. Is local scour around bridge piers a problem to your agency?

- Yes, definitely
- Yes, Occasionally
- No, due to successful control or measures
- No, due to favorable site conditions

If you answered NO, due to favorable site conditions, please send the form back in the enclosed return envelope--otherwise continue to questions 3 and 4 below:



3. Please give approximate number of bridges for which countermeasures have been implemented by your agency.

Countermeasures		Approx. Number of Sites		
		Successful	Unsuccessful	As yet undermined
Armoring Countermeasures	Dumped riprap			
	Self launching riprap			
	Rock and wire mattress and gabion			
	Other flexible revetment or bed armor			
	Concrete or asphalt pavement			
	Sacked concrete			
	Concrete-grouted riprap			
	Concrete-filled fabric mat			
	Tetrapods			
	Extended footings			
	Cable tied blocks			
	Tile mats			
	High density particles			
	Anchors			
Other (Specify)				
Flow altering Countermeasures	Vanes attached to pier or bed			
	Sacrificial Piles			
	Slots			
	Flow direction plates			
	Modified pier texture			
	Overflow barbs			
	Flow diversion (flow relief)			
	Other (specify)			

Note: the following countermeasures, while relevant to bridge scour in general, have been excluded from the present study which is focused solely on scour of existing piers at stable bridge crossings. We would, nevertheless appreciate your comments.

Countermeasures		Approx. Number of Sites		
		Successful	Unsuccessful	As yet determined
Flow altering Countermeasures	Spurs			
	Retards			
	Check dams			
	Other			
Preventive Countermeasures	Monitoring			
	Alarm systems			
	Bridge closure during peak floods			
	Vehicle restriction			
	Other (Specify)			

4. If any of the countermeasures of question 3 were unsuccessful, please indicate the reason(s) why.

Countermeasure Name	Prohibitive Cost (✓)	Difficult Placement (✓)	Under design (✓)	Technical Failure (✓)

\* Failure caused by limited design information or due to possible underdesign.  
 \*\* Failure related to poor technical performance of the technique.

Comments: \_\_\_\_\_  
 \_\_\_\_\_  
 \_\_\_\_\_

5. Review of Foundation Condition (Bridges 20 ft. or longer over waterways)

(a) The percentage of bridges encountering scour problems per type of bed material:

Cohesive \_\_\_% Sand \_\_\_% Gravel \_\_\_% Bedrock \_\_\_% Mixed \_\_\_% Uncertain \_\_\_%

(b) If information is accessible, document the percentage of total bridges owned/maintained by your agency with the following bed conditions:

Cohesive \_\_\_% Sand \_\_\_% Gravel \_\_\_% Bedrock \_\_\_% Mixed \_\_\_% Uncertain \_\_\_%

(c) For sand bed streams, approximately what percentage go deeper than 6-8 ft. before a more scour-resistant material is encountered: \_\_\_\_%

Please summarize the most representative bridge pier scour conditions encountered by your agency.

Bridge Characteristics		Five Worst Scour Sites				
		1	2	3	4	5
Name						
Location						
Degree of scour	Severe					
	Moderate					
	Low					
Bed Material	% Gravel (cobble-boulder)					
	% Sand					
	% Cohesive					
	% Bedrock					
	Uniform					
	Heterogeneous					
	Bedload (high,med,low)					
	D <sub>90</sub>					
	D <sub>50</sub>					
	D <sub>30</sub>					
Bridge Pier	Number of Piers					
	Width					
	Length					
	Lateral Spacing (piers)					
	Upstream bridge spacing					
	Vertical clearance					

Bridge Characteristics		Five Worst Scour Sites				
		1	2	3	4	5
Pier Shape	Circular					
	Rectangular					
	Elliptic					
	Sharp edge					
	Rounded edge					
	Multiple Piles					
	Other (Specify)					
	Footing type					
	Footing size					
Design parameters for Scour Analysis (Specify Units)	Velocity					
	Water discharge					
	Angle of Attack					
	Flow depth					
	Est. Max. Scour Depth					
	Upstream channel width					
	Channel width under bridge					
	Downstream channel width					
	Ice problems (Yes/No)					
	Debris problems (Yes/No)					

How do you determine type of countermeasure to use?

- |  |  |
|--|--|
| <input type="checkbox"/> Standard procedure                        | <input type="checkbox"/> Depth of the water        |
| <input type="checkbox"/> Design information readily available      | <input type="checkbox"/> Velocity during low flows |
| <input type="checkbox"/> Hydraulic factors (depth, velocity, etc.) | <input type="checkbox"/> Cost                      |
| <input type="checkbox"/> Easy Installation                         | <input type="checkbox"/> Other (please list)       |

How do you determine when to install countermeasures, as opposed to monitoring for scour during floods?

- Remoteness of site
- Necessity to close down lanes to monitor
- Clearance between water surface and bridge
- Ease of monitoring
- Ease of countermeasure installation
- Bed material characteristics
- Cost of countermeasure
- Staff and equipment necessary to monitor
- Susceptibility to scour. (Are the scour evaluation results believable?)
- Frequency of storm required to make bridge scour critical (safe for  $Q_{100}$  but critical for  $Q_{500}$ )
- Frequency of overtopping floods
- ADT

Do you consider monitoring during floods a countermeasure? \_\_\_\_\_.

If YES, describe the procedure you use.

- \_\_\_\_\_ Scour Action Plan. Spells out who, where, what, when, how.
- \_\_\_\_\_ Visual observations to look for signs of failure.
- \_\_\_\_\_ Physical or electronic measurements to determine scour depth
- \_\_\_\_\_ Other (Please describe)

6. If you have successfully or unsuccessfully used novel or unique countermeasures and would like to comment on the technique or results, please do so below. Please feel free to attach engineering drawings, reports field notes copies, photographs, cost data, etc. :

\_\_\_\_\_  
\_\_\_\_\_  
\_\_\_\_\_  
\_\_\_\_\_

7. Identify sites, if any that you would recommend as case studies for this project:

\_\_\_\_\_  
\_\_\_\_\_  
\_\_\_\_\_

Any other comments you feel would be useful: \_\_\_\_\_  
\_\_\_\_\_  
\_\_\_\_\_

Please append any material that you feel may be of benefit to the project.

Thank you for your time and cooperation,

Richard L. Voigt, Jr.  
University of Minnesota  
St. Anthony Falls Laboratory  
Minneapolis, MN 55414  
Ph. (612) 627-4010; FAX (612) 627-4609  
E-mail: voigt001@maroon.tc.umn.edu

**Mail, FAX or E-mail at your convenience**  
**Due Date: October 6, 1995**

Table 2.4. Screening Summary - Mean Scores

Countermeasure:	Limits		Mean Value	Riprap	Alarm Systems	Anchors	Articulated Mattress	Artificial Riprap	Cable Tied Blocks	Collars	Concrete Filled Mats	Extended Footings	Delta-wing Device	Grouted Riprap
	Min	Max												
<b>Step 1: Feasibility</b>														
<b>a. Site characteristics</b>														
<b>Bed characteristics</b>														
cobble bed	1.00	8.00	4.34	5.00	4.00	3.33	2.67	5.50	3.83	5.00	4.17	5.00	5.00	5.40
gravel bed	1.00	8.00	5.07	5.67	5.00	4.50	4.50	5.83	5.83	5.67	5.00	5.33	5.67	5.00
sand bed	1.00	8.00	5.70	6.67	6.00	4.17	5.67	6.00	6.33	6.67	5.83	3.83	5.83	3.40
bedrock	1.00	8.00	3.93	3.33	6.00	3.83	2.17	2.33	3.67	3.83	2.33	5.17	5.00	2.40
cohesive bed	1.00	8.00	4.26	4.83	6.00	2.33	4.33	2.83	4.33	5.67	3.83	4.50	5.00	2.40
heavily silted (mucky)	1.00	8.00	4.24	5.75	4.50	1.25	4.25	3.00	4.25	6.00	5.00	3.25	5.75	1.33
<b>Pier position</b>														
main span	1.00	8.00	4.82	6.17	4.67	4.33	4.67	5.67	5.17	5.17	4.33	4.83	5.33	4.20
flood plain	1.00	8.00	5.08	6.33	3.67	5.00	5.67	5.67	6.33	4.83	6.17	6.00	3.83	5.20
adjacent to abutment	1.00	8.00	4.58	6.17	4.67	4.00	4.50	5.17	4.50	4.67	4.50	4.67	3.83	3.20
<b>Channel configuration</b>														
split	1.00	8.00	4.63	5.50	4.67	4.00	4.50	5.33	4.67	5.33	4.33	4.67	4.33	4.40
single	1.00	8.00	5.66	6.50	4.67	5.50	5.67	6.33	5.83	5.50	5.83	6.00	5.17	5.80
<b>b. Hydrograph characteristics</b>														
Ephemeral	1.00	10.00	6.00	6.67	3.00	6.33	6.67	6.00	7.17	6.17	5.83	5.50	5.00	5.80
Flashy	1.00	10.00	5.38	6.50	3.00	4.83	4.50	5.50	6.50	6.00	4.83	4.50	5.33	5.40
Moderate	1.00	10.00	6.26	7.83	5.67	6.00	4.83	7.83	7.83	6.83	6.17	6.50	6.50	5.40
Long term	1.00	10.00	6.44	7.50	6.33	6.00	5.50	7.50	7.50	6.83	6.00	6.83	6.83	5.60
Tidal	1.00	10.00	6.15	9.00	8.00	8.50	6.50	9.00	6.50	6.50	6.00	9.00	4.50	4.50
<b>c. Bridge type</b>														
New construction	2.00	20.00	13.01	15.50	6.67	15.33	12.83	13.67	15.17	16.33	13.17	15.67	13.33	14.80
Protection on existing bridge	2.00	20.00	10.93	16.83	10.00	10.00	11.33	14.50	13.50	6.00	12.33	5.50	10.17	12.80
<b>d. Other factors</b>														
Ice susceptibility	1.00	5.00	2.91	3.00	3.00	4.00	3.33	3.50	3.67	2.17	3.50	4.17	1.83	3.20
Debris susceptibility	1.00	5.00	2.94	4.00	3.00	3.67	3.83	3.33	4.17	2.17	4.33	2.17	1.50	3.80
Salt water	1.00	5.00	3.50	4.75	3.50	3.00	2.50	4.00	2.00	3.50	3.25	4.00	3.75	2.67
Regional Problems	1.00	5.00	3.30	3.00	3.50	3.00	3.00	3.00	3.25	3.25	3.00	3.25	3.25	2.33

Table 2.4. Screening Summary - Mean Scores (Cont'd)

Countermeasure:	Limits		Mean Value	Riprap	Alarm Systems	Anchors	Articulated Mattress	Artificial Riprap	Cable Tied Blocks	Collars	Concrete Filled Mats	Extended Footings	Delta-wing Device	Grouted Riprap
	Min	Max												
<b>Step 2. Technical Effectiveness</b>														
Hydraulic	2.00	25.00	14.62	18.33	13.67	17.50	15.00	17.00	15.50	14.50	16.17	12.83	14.67	12.00
Geotechnical	2.00	25.00	13.66	16.00	15.67	12.17	12.33	15.50	12.17	15.17	11.67	12.50	14.83	9.60
Geomorphic	2.00	25.00	12.82	15.50	15.00	10.50	11.33	15.50	14.67	11.67	9.17	10.83	14.50	7.00
Hydrologic	2.00	25.00	14.09	16.17	13.67	9.83	13.67	15.33	15.33	13.67	15.00	12.83	15.33	12.40
Climatic	2.00	25.00	14.88	17.17	10.33	16.50	14.00	15.67	15.17	16.00	13.67	16.83	17.00	12.80
Structural	2.00	25.00	14.25	15.67	11.00	16.67	13.50	14.83	17.67	16.00	13.50	14.17	11.83	10.60
Synergistic effects	2.00	25.00	13.13	16.00	7.67	14.50	11.83	13.83	13.83	14.17	11.67	14.67	16.33	9.80
Inspectability	2.00	25.00	14.28	16.17	11.00	8.33	14.33	14.50	14.67	16.33	13.50	13.60	16.83	13.20
<b>Step 3. Difficulty in construction</b>														
Level of expertise required	0.00	30.00	16.84	26.17	11.67	10.83	12.83	19.17	14.00	21.17	18.17	20.83	10.17	20.40
Need for specialized equipment	0.00	30.00	16.69	25.00	11.67	9.67	12.50	15.00	12.50	20.50	17.83	20.50	13.33	18.00
Extraordinary constr. time	0.00	30.00	17.91	27.50	15.00	15.00	17.50	12.50	17.50	12.50	20.00	10.00	15.00	20.00
Environmental impacts	0.00	30.00	19.05	19.83	23.33	20.83	15.83	15.83	18.33	20.83	13.67	20.33	21.50	14.60
<b>Step 4. Durability (3pts/yr)</b>														
Time without maintenance	1.00	120.00	43.75	55.00	28.33	35.00	39.00	61.00	48.00	58.40	37.00	86.00	39.00	32.50
<b>Step 5. Difficulty with maintenance</b>														
Difficulty with maintenance	0.00	120.00	59.08	77.50	63.33	39.17	45.83	77.50	46.67	56.67	43.33	49.17	55.00	44.00
<b>Step 6. Cost</b>														
Relative cost basis	0.00	120.00	56.67	86.00	60.00	47.00	43.00	69.00	40.00	48.00	52.00	35.00	54.00	65.00
<b>Step 7. Special Factors</b>														
Acceptability														
Social acceptability	5.00	15.00	8.24	8.33	6.67	10.67	8.83	7.50	8.50	10.00	6.17	12.17	8.83	6.40
Aesthetics	5.00	15.00	8.44	8.00	7.50	13.00	9.25	8.00	7.50	9.25	4.75	11.25	8.75	4.67
Environmental acceptability	5.00	30.00	13.79	12.33	11.67	15.00	10.83	11.17	13.33	15.50	8.67	15.50	17.17	6.60
Specific considerations (Define)	-60.00	60.00	1.00	16.67	-6.67	0.00	-6.67	5.00	-1.67	-4.17	-3.33	0.00	3.33	1.67
<b>TOTAL SCORE</b>	-4.00	998.00	492.30	639.83	440.00	435.08	428.17	555.33	475.67	510.23	442.33	509.35	484.17	430.27

Table 2.4. Screening Summary - Mean Scores (Cont'd)

Countermeasure:	Limits		Mean Value	Rock Filled Gabion	Sacked Concrete	Sacrificial Piles	Self-Launched Riprap	Sheet Piles	Slots	Suction	Tile Mats	Tri-lock Blocks	Vehicle Restriction	Vertical Plates
	Min	Max												
<b>Step 1: Feasibility</b>														
<b>a. Site characteristics</b>														
<b>Bed characteristics</b>														
cobble bed	1.00	8.00	4.34	5.17	3.67	3.33	4.83	2.83	5.83	4.40	2.17	2.50	4.00	4.50
gravel bed	1.00	8.00	5.07	5.33	5.17	4.83	5.33	4.33	6.00	4.60	3.00	2.83	5.00	6.17
sand bed	1.00	8.00	5.70	6.00	5.83	6.67	6.67	6.67	6.17	5.40	4.50	5.17	6.00	6.83
bedrock	1.00	8.00	3.93	3.17	2.00	2.33	3.33	2.33	5.17	4.60	2.17	2.00	6.00	4.00
cohesive bed	1.00	8.00	4.26	3.00	4.33	4.00	4.50	3.67	5.00	5.20	2.50	3.33	6.00	4.50
heavily silted (mucky)	1.00	8.00	4.24	3.75	3.50	2.75	5.75	2.50	7.00	5.00	2.75	4.00	4.50	4.75
<b>Pier position</b>														
main span	1.00	8.00	4.82	4.67	4.83	4.50	5.83	4.67	4.50	5.20	2.67	3.33	5.33	5.50
flood plain	1.00	8.00	5.08	6.00	5.67	4.83	5.33	4.83	4.00	3.20	5.00	5.33	5.33	4.00
adjacent to abutment	1.00	8.00	4.58	5.00	5.00	4.67	5.50	4.67	3.50	4.20	3.33	4.00	5.33	4.00
<b>Channel configuration</b>														
split	1.00	8.00	4.63	5.17	4.67	4.00	5.33	4.33	4:17	4.40	4.00	4.00	5.33	4.50
single	1.00	8.00	5.66	6.00	5.83	5.67	6.50	5.67	5.17	5.80	5.17	5.17	5.33	5.50
<b>b. Hydrograph characteristics</b>														
Ephemeral	1.00	10.00	6.00	7.50	5.67	5.17	6.83	5.50	7.00	4.80	6.17	6.17	4.33	5.33
Flashy	1.00	10.00	5.38	6.33	5.00	6.00	6.50	5.83	7.00	3.80	4.33	4.33	5.00	6.00
Moderate	1.00	10.00	6.26	6.50	6.00	7.17	7.83	6.83	7.00	6.00	3.67	4.00	5.67	7.17
Long term	1.00	10.00	6.44	6.50	6.00	7.17	7.50	7.17	6.83	6.80	4.50	4.50	6.33	7.50
Tidal	1.00	10.00	6.15	6.50	5.00	6.50	8.50	6.50	6.50	4.50	3.50	3.50	6.00	4.50
<b>c. Bridge type</b>														
New construction	2.00	20.00	13.01	13.83	12.17	12.83	15.33	12.83	13.67	14.60	11.50	12.67	6.67	13.33
Protection on existing bridge	2.00	20.00	10.93	12.83	14.00	13.83	16.67	13.83	2.17	9.00	7.67	11.33	11.00	10.50
<b>d. Other factors</b>														
Ice susceptibility	1.00	5.00	2.91	3.50	3.00	2.00	2.83	2.33	1.83	2.00	3.17	3.17	2.67	2.33
Debris susceptibility	1.00	5.00	2.94	3.67	4.00	1.50	3.83	1.67	1.17	1.20	3.83	4.00	2.67	1.67
Salt water	1.00	5.00	3.50	2.50	2.25	3.50	4.50	3.25	3.75	3.25	3.25	2.75	4.00	3.75
Regional Problems	1.00	5.00	3.30	2.75	3.00	3.00	3.00	3.00	3.50	3.50	3.00	3.00	4.00	3.25



Table 2.4. Screening Summary - Mean Scores (Cont'd)

Countermeasure:	Limits		Mean Value	Rock Filled Gabion	Sacked Concrete	Sacrificial Piles	Self-Launched Riprap	Sheet Piles	Slots	Suction	Tile Mats	Tri-lock Blocks	Vehicle Restriction	Vertical Plates
	Min	Max												
<b>Step 2. Technical Effectiveness</b>														
Hydraulic	2.00	25.00	14.62	16.83	14.83	13.17	18.33	13.50	12.00	13.00	14.83	13.67	13.67	15.00
Geotechnical	2.00	25.00	13.66	14.67	13.83	11.83	15.17	12.67	12.50	13.40	10.67	12.33	15.67	15.83
Geomorphic	2.00	25.00	12.82	11.17	11.67	12.17	15.50	13.00	12.67	13.00	11.67	12.17	15.00	14.83
Hydrologic	2.00	25.00	14.09	16.50	13.67	14.50	15.33	14.50	14.17	10.60	12.50	13.67	13.67	15.17
Climatic	2.00	25.00	14.88	15.17	11.00	17.00	16.33	18.17	17.00	15.20	14.00	14.83	10.33	17.00
Structural	2.00	25.00	14.25	17.17	12.50	15.33	13.67	17.00	8.83	13.40	14.33	14.83	11.00	14.67
Synergistic effects	2.00	25.00	13.13	12.00	11.50	13.33	13.50	13.17	14.00	14.80	12.33	13.67	7.67	16.50
Inspectability	2.00	25.00	14.28	16.17	11.67	16.33	16.50	16.33	18.00	17.00	12.00	13.33	11.00	16.83
<b>Step 3. Difficulty in construction</b>														
Level of expertise required	0.00	30.00	16.84	22.50	22.17	19.17	23.67	20.00	11.67	10.40	11.50	11.83	23.33	16.67
Need for specialized equipment	0.00	30.00	16.69	21.83	23.00	17.50	24.17	19.17	14.50	12.00	14.50	13.17	18.33	18.83
Extraordinary constr. time	0.00	30.00	17.91	27.50	27.50	22.50	30.00	22.50	11.00	15.00	15.00	17.50	15.00	17.50
Environmental impacts	0.00	30.00	19.05	18.33	16.33	17.17	20.17	16.33	18.67	17.00	15.00	15.83	23.33	21.17
<b>Step 4. Durability (3pts/yr)</b>														
Time without maintenance	1.00	120.00	43.75	41.40	36.40	30.00	53.40	33.00	49.00	28.00	25.00	27.00	63.33	42.00
<b>Step 5. Difficulty with maintenance</b>														
Difficulty with maintenance	0.00	120.00	59.08	53.33	72.50	59.17	76.67	58.33	65.00	44.00	45.83	50.83	76.67	63.33
<b>Step 6. Cost</b>														
Relative cost basis	0.00	120.00	56.67	72.00	77.00	68.00	86.00	62.00	58.00	58.00	20.00	36.00	56.67	64.00
<b>Step 7. Special Factors</b>														
Acceptability														
Social acceptability	5.00	15.00	8.24	8.67	5.83	5.83	8.33	5.83	8.50	8.00	8.83	10.50	4.67	8.83
Aesthetics	5.00	15.00	8.44	7.50	5.00	4.25	7.75	4.25	7.50	8.00	10.00	11.75	9.50	8.75
Environmental acceptability	5.00	30.00	13.79	14.67	10.83	13.83	12.50	15.00	18.83	14.00	9.50	14.50	11.33	16.67
Specific considerations (Define)	-60.00	60.00	1.00	0.00	1.67	1.67	16.67	0.00	-6.67	-15.00	-10.00	-3.33	-10.00	3.33
<b>TOTAL SCORE</b>	-4.00	998.00	492.30	533.07	515.48	489.00	625.90	490.00	482.08	421.25	359.33	415.17	506.67	526.50

47

Table 2.4. Screening Summary - Mean Scores (Cont'd)

Countermeasure:	Limits		Mean Value	High Density Particles	Horizontal Plates	Iowa Vanes	Modified Pier Texture	Modifying Pier Face	Modular Paving Units	Monitoring	Pavement	Peak flood Closure	Pier Vanes	Rock Bolting and Grouting
	Min	Max												
<b>Step 1: Feasibility</b>														
<b>a. Site characteristics</b>														
<b>Bed characteristics</b>														
cobble bed	1.00	8.00	4.34	5.83	5.17	3.67	5.83	6.50	2.50	4.00	3.17	4.00	5.83	4.50
gravel bed	1.00	8.00	5.07	6.00	5.83	5.17	5.83	6.50	2.83	5.00	4.00	5.00	6.50	4.00
sand bed	1.00	8.00	5.70	6.17	6.00	7.17	6.00	6.50	5.17	6.00	3.67	6.00	7.00	2.00
bedrock	1.00	8.00	3.93	2.50	4.83	2.83	5.83	6.00	2.00	6.00	4.83	6.00	5.17	6.67
cohesive bed	1.00	8.00	4.26	3.17	5.33	3.50	5.50	5.83	3.33	6.00	2.83	6.00	5.50	1.33
heavily silted (mucky)	1.00	8.00	4.24	2.50	6.00	3.75	7.50	7.75	4.00	4.50	1.75	4.50	6.25	1.00
<b>Pier position</b>														
main span	1.00	8.00	4.82	6.17	5.67	5.17	5.17	5.17	3.17	4.67	3.50	5.33	4.33	5.17
flood plain	1.00	8.00	5.08	5.67	4.00	4.67	5.00	5.17	5.17	4.67	5.17	5.33	5.50	5.17
adjacent to abutment	1.00	8.00	4.58	5.50	4.50	5.00	4.50	5.00	3.83	4.67	4.00	5.33	5.00	4.83
<b>Channel configuration</b>														
split	1.00	8.00	4.63	5.33	5.00	4.17	5.00	4.83	4.00	4.67	3.83	5.33	4.17	4.83
single	1.00	8.00	5.66	6.33	5.67	6.33	5.67	5.83	5.17	4.67	5.33	5.33	6.33	5.50
<b>b. Hydrograph characteristics</b>														
Ephemeral	1.00	10.00	6.00	6.33	5.83	5.67	7.50	7.33	6.17	4.33	7.50	4.33	7.50	6.83
Flashy	1.00	10.00	5.38	5.00	5.50	6.17	6.50	6.67	4.33	4.33	4.50	5.00	7.17	5.50
Moderate	1.00	10.00	6.26	6.83	6.67	7.17	6.67	7.00	4.00	5.00	4.33	5.67	7.33	6.83
Long term	1.00	10.00	6.44	6.83	6.50	7.50	6.67	6.67	4.50	5.67	4.33	6.33	7.33	6.83
Tidal	1.00	10.00	6.15	9.00	6.50	4.50	9.00	4.50	3.50	6.00	1.00	6.00	4.50	9.00
<b>c. Bridge type</b>														
New construction	2.00	20.00	13.01	13.00	12.83	13.67	14.17	15.00	12.00	6.67	12.17	6.67	15.33	15.83
Protection on existing bridge	2.00	20.00	10.93	14.00	10.17	13.67	9.17	6.83	10.50	10.33	7.33	11.00	12.50	9.33
<b>d. Other factors</b>														
Ice susceptibility	1.00	5.00	2.91	3.33	2.00	1.83	3.83	2.83	3.17	2.67	3.00	2.67	1.83	4.50
Debris susceptibility	1.00	5.00	2.94	4.00	1.67	1.50	3.67	2.33	4.00	2.67	3.83	2.67	1.50	4.00
Salt water	1.00	5.00	3.50	3.25	4.25	3.75	4.50	4.25	2.75	4.00	3.00	4.00	4.50	3.50
Regional Problems	1.00	5.00	3.30	2.75	3.50	3.50	3.50	3.75	3.00	6.50	2.50	4.00	3.50	3.50

Table 2.4. Screening Summary - Mean Scores (Cont'd)

Countermeasure:	Limits		Mean Value	High Density Particles	Horizontal Plates	Iowa Vanes	Modified Pier Texture	Modifying Pier Face	Modular Paving Units	Monitoring	Pavement	Peak flood Closure	Pier Vanes	Rock Bolting and Grouting
	Min	Max												
<b>Step 2. Technical Effectiveness</b>														
Hydraulic	2.00	25.00	14.62	18.67	15.00	15.50	12.17	11.00	13.67	13.67	9.83	13.67	14.33	19.00
Geotechnical	2.00	25.00	13.66	16.33	16.50	13.50	12.83	15.83	12.33	15.67	7.83	15.67	14.17	14.00
Geomorphic	2.00	25.00	12.82	16.33	13.67	14.33	11.67	12.17	12.17	15.00	7.33	15.00	14.33	12.50
Hydrologic	2.00	25.00	14.09	15.33	15.33	15.33	15.33	17.00	12.83	13.67	9.50	13.67	14.83	14.50
Climatic	2.00	25.00	14.88	16.00	17.00	15.67	15.67	17.33	14.83	10.33	9.83	10.33	15.67	17.33
Structural	2.00	25.00	14.25	12.33	16.83	16.17	16.17	19.00	14.83	11.00	10.83	11.00	16.50	17.50
Synergistic effects	2.00	25.00	13.13	15.67	15.50	15.67	14.00	17.33	13.67	7.67	8.67	7.67	15.67	15.17
Inspectability	2.00	25.00	14.28	11.83	16.83	15.00	16.17	18.33	13.33	11.00	16.50	11.00	15.33	8.17
<b>Step 3. Difficulty in construction</b>														
Level of expertise required	0.00	30.00	16.84	22.83	17.83	11.83	17.33	18.33	12.83	11.67	19.17	23.33	12.17	10.00
Need for specialized equipment	0.00	30.00	16.69	20.00	18.83	12.50	23.00	16.33	14.17	10.00	20.50	18.33	15.50	8.00
Extraordinary constr. time	0.00	30.00	17.91	25.00	22.50	15.00	17.50	15.00	17.50	15.00	17.50	15.00	12.50	15.00
Environmental impacts	0.00	30.00	19.05	12.50	22.00	22.17	22.83	22.00	15.83	23.33	15.33	23.33	23.33	21.67
<b>Step 4. Durability (3pts/yr)</b>														
Time without maintenance	1.00	120.00	43.75	45.60	40.00	36.00	62.00	73.00	27.00	30.00	23.80	66.67	35.00	57.00
<b>Step 5. Difficulty with maintenance</b>														
Difficulty with maintenance	0.00	120.00	59.08	80.00	68.33	55.83	62.50	62.50	50.83	66.67	56.67	83.33	63.33	35.83
<b>Step 6. Cost</b>														
Relative cost basis	0.00	120.00	56.67	68.00	66.00	48.00	67.00	62.00	30.00	60.00	55.00	43.33	58.00	56.00
<b>Step 7. Special Factors</b>														
Acceptability														
Social acceptability	5.00	15.00	8.24	8.67	9.67	8.50	8.83	10.50	10.50	6.67	8.17	3.33	9.17	10.00
Aesthetics	5.00	15.00	8.44	11.75	10.00	8.75	7.50	10.00	11.75	7.50	6.25	7.50	8.75	12.50
Environmental acceptability	5.00	30.00	13.79	14.50	15.83	16.67	17.17	19.67	14.17	11.67	12.17	10.00	15.33	18.33
Specific considerations (Define)	-60.00	60.00	1.00	13.33	0.00	1.67	-8.33	0.00	-6.67	-6.67	-5.00	-10.00	3.33	3.33
<b>TOTAL SCORE</b>	-4.00	998.00	492.30	574.18	541.08	478.42	548.33	569.58	404.67	446.83	405.47	498.67	511.83	486.50

Table 2.5 Screening Summary - Standard Deviation

Countermeasure:	Limits		Mean Value	Riprap	Alarm Systems	Anchors	Articulated Mattress	Artificial Riprap	Cable Tied Blocks	Collars	Concrete Filled Mats	Extended Footings	Delta-wing Device	Grouted Riprap
	Min	Max												
<b>Step 1: Feasibility</b>														
<b>a. Site characteristics</b>														
<b>Bed characteristics</b>														
cobble bed	0.62	1.39	1.01	1.10	0.75	0.92	1.01	0.62	1.11	1.39	0.91	0.85	1.06	0.73
gravel bed	0.49	1.26	0.88	0.78	0.57	0.79	1.26	0.52	0.66	1.01	0.94	0.73	1.05	0.49
sand bed	0.52	1.32	0.87	0.54	0.75	1.18	1.32	0.98	1.05	0.67	0.91	1.18	1.07	0.67
bedrock	0.49	1.51	1.09	1.46	0.75	1.48	0.87	0.78	1.51	1.31	0.88	1.15	1.13	0.83
cohesive bed	0.23	1.57	1.12	1.48	0.75	0.67	1.15	1.25	1.15	1.22	1.18	1.29	1.44	0.61
heavily silted (mucky)	0.00	1.21	0.78	1.14	0.71	0.17	0.99	0.85	0.99	1.17	0.75	1.11	0.71	0.16
<b>Pier position</b>														
main span	0.23	1.21	0.80	0.66	0.43	0.73	0.83	0.46	0.34	1.11	0.61	0.96	1.05	0.52
flood plain	0.33	1.47	1.07	1.01	0.33	0.98	1.32	1.08	1.05	1.43	1.07	1.02	1.21	0.91
adjacent to abutment	0.43	1.50	1.21	1.18	0.43	1.23	1.44	1.18	1.16	1.38	1.16	1.19	1.31	0.91
<b>Channel configuration</b>														
split	0.43	1.56	1.05	1.09	0.43	0.85	1.19	1.05	1.12	1.38	0.92	0.88	1.51	0.83
single	0.43	1.21	0.82	0.62	0.43	0.84	0.92	0.61	0.82	0.97	0.82	0.75	1.21	0.52
<b>b. Hydrograph characteristics</b>														
Ephemeral	0.49	1.79	1.36	1.46	0.49	1.59	1.62	1.79	1.43	1.45	1.68	1.67	1.67	1.21
Flashy	0.00	0.00	0.00	0.00	0.00	0.00	0.00	0.00	0.00	0.00	0.00	0.00	0.00	0.00
Moderate	0.16	1.46	0.92	1.00	0.71	1.13	1.00	1.00	1.00	0.96	1.04	1.05	1.19	0.61
Long term	0.43	1.67	1.33	1.32	0.82	1.33	1.59	1.32	1.32	1.31	1.62	1.45	1.56	1.34
Tidal	0.00	0.00	0.00	0.00	0.00	0.00	0.00	0.00	0.00	0.00	0.00	0.00	0.00	0.00
<b>c. Bridge type</b>														
New construction	1.18	3.60	2.35	1.83	1.18	1.83	2.61	2.22	1.95	2.22	2.52	1.62	3.28	1.43
Protection on existing bridge	0.44	3.21	1.78	1.40	1.41	2.79	1.89	1.52	1.85	1.55	1.49	1.32	2.18	1.04
<b>d. Other factors</b>														
Ice susceptibility	0.00	0.00	0.00	0.00	0.00	0.00	0.00	0.00	0.00	0.00	0.00	0.00	0.00	0.00
Debris susceptibility	0.16	0.96	0.42	0.40	0.28	0.54	0.34	0.46	0.96	0.66	0.23	0.52	0.47	0.44
Salt water	0.17	0.71	0.41	0.17	0.42	0.49	0.60	0.40	0.28	0.45	0.71	0.40	0.33	0.59
Regional Problems	0.14	0.99	0.57	0.57	0.14	0.57	0.57	0.57	0.59	0.59	0.57	0.59	0.59	0.33

Table 2.5 Screening Summary - Standard Deviation (Cont'd)

Countermeasure:	Limits		Mean Value	Riprap	Alarm Systems	Anchors	Articulated Mattress	Artificial Riprap	Cable Tied Blocks	Collars	Concrete Filled Mats	Extended Footings	Delta-wing Device	Grouted Riprap
	Min	Max												
<b>Step 2. Technical Effectiveness</b>														
Hydraulic	2.01	3.70	2.81	2.69	2.01	2.49	3.19	2.53	2.43	2.57	2.63	2.46	3.63	2.24
Geotechnical	1.14	4.03	2.52	2.70	1.14	2.46	2.81	2.43	3.17	2.50	2.38	4.03	2.63	2.03
Geomorphic	1.10	3.61	2.20	3.15	1.41	1.76	2.48	2.43	2.71	1.62	1.68	2.61	2.49	1.10
Hydrologic	2.01	4.41	3.18	3.63	2.01	3.58	2.84	3.53	3.53	3.17	3.32	3.79	3.32	2.85
Climatic	0.00	0.00	0.00	0.00	0.00	0.00	0.00	0.00	0.00	0.00	0.00	0.00	0.00	0.00
Structural	1.02	4.48	2.42	3.26	1.02	2.77	2.53	3.12	3.13	3.16	2.53	4.48	2.64	1.04
Synergistic effects	1.81	4.18	2.91	3.15	1.88	3.39	1.99	2.72	3.76	3.30	2.36	2.88	4.18	2.41
Inspectability	0.92	3.77	2.54	3.67	1.02	0.92	3.16	3.12	3.31	2.54	3.16	2.36	2.78	3.14
<b>Step 3. Difficulty in construction</b>														
Level of expertise required	0.00	0.00	0.00	0.00	0.00	0.00	0.00	0.00	0.00	0.00	0.00	0.00	0.00	0.00
Need for specialized equipment	1.10	4.64	2.93	2.45	2.16	2.92	3.08	2.83	3.20	3.33	2.75	3.02	3.92	1.10
Extraordinary constr. time	0.00	0.00	0.00	0.00	0.00	0.00	0.00	0.00	0.00	0.00	0.00	0.00	0.00	0.00
Environmental impacts	1.68	4.15	2.79	3.01	2.16	3.29	1.68	2.97	2.71	4.10	2.63	3.54	3.16	1.82
<b>Step 4. Durability (3pts/yr)</b>														
Time without maintenance	2.60	17.23	7.91	9.17	2.94	4.00	12.03	9.63	7.82	14.87	2.68	8.76	8.76	3.32
<b>Step 5. Difficulty with maintenance</b>														
Difficulty with maintenance	0.00	0.00	0.00	0.00	0.00	0.00	0.00	0.00	0.00	0.00	0.00	0.00	0.00	0.00
<b>Step 6. Cost</b>														
Relative cost basis	0.00	18.83	9.25	11.17	0.00	8.90	9.12	12.20	4.24	4.38	10.35	6.32	13.15	8.25
<b>Step 7. Special Factors</b>														
Acceptability														
Social acceptability	0.00	14.42	6.91	14.42	12.65	0.00	8.00	4.47	4.47	8.54	4.00	5.66	4.00	4.47
Aesthetics	0.00	0.00	0.00	0.00	0.00	0.00	0.00	0.00	0.00	0.00	0.00	0.00	0.00	0.00
Environmental acceptability	0.00	0.00	0.00	0.00	0.00	0.00	0.00	0.00	0.00	0.00	0.00	0.00	0.00	0.00
Specific considerations (Define)	0.00	0.00	1.00	0.00	0.00	0.00	0.00	0.00	0.00	0.00	0.00	0.00	0.00	0.00
<b>TOTAL SCORE</b>	51.68	122.57	86.11	103.67	53.76	77.62	103.81	95.94	86.96	107.74	78.02	96.56	100.71	62.76

Table 2.5 Screening Summary - Standard Deviation (Cont'd)

Countermeasure:	Limits		Mean Value	Rock Filled Gabion	Sacked Concrete	Sacrificial Piles	Self-Launched Riprap	Sheet Piles	Slots	Suction	Tile Mats	Tri-lock Blocks	Vehicle Restriction	Vertical Plates
	Min	Max												
<b>Step 1: Feasibility</b>														
<b>a. Site characteristics</b>														
<b>Bed characteristics</b>														
cobble bed	0.62	1.39	1.01	1.25	1.01	1.29	1.15	1.34	1.04	1.15	0.82	1.05	0.75	1.16
gravel bed	0.49	1.26	0.88	1.19	0.72	0.96	0.92	0.97	1.02	1.08	0.85	1.15	0.57	0.87
sand bed	0.52	1.32	0.87	0.98	0.72	0.54	0.54	0.54	1.04	0.96	0.73	1.21	0.75	0.52
bedrock	0.49	1.51	1.09	1.37	0.49	1.25	1.46	1.25	1.28	1.08	0.66	0.89	0.75	1.30
cohesive bed	0.23	1.57	1.12	1.30	1.08	0.80	1.57	0.97	1.39	1.04	1.22	1.19	0.75	1.46
heavily silted (mucky)	0.00	1.21	0.78	1.18	1.00	0.71	1.14	0.60	0.49	1.02	1.21	1.10	0.71	1.03
<b>Pier position</b>														
main span	0.23	1.21	0.80	0.23	0.52	0.73	0.87	0.78	1.01	1.21	0.61	1.01	0.59	0.93
flood plain	0.33	1.47	1.07	1.02	1.15	1.28	1.19	1.28	1.10	1.11	0.98	1.12	0.59	1.17
adjacent to abutment	0.43	1.50	1.21	1.33	1.26	1.38	1.22	1.38	1.29	1.40	0.88	1.41	0.59	1.36
<b>Channel configuration</b>														
split	0.43	1.56	1.05	1.21	1.12	0.85	1.08	0.92	1.28	1.08	0.94	1.17	0.59	1.19
single	0.43	1.21	0.82	0.75	0.82	0.61	0.62	0.61	1.15	0.91	0.77	1.04	0.59	0.97
<b>b. Hydrograph characteristics</b>														
Ephemeral	0.49	1.79	1.36	0.93	1.64	1.59	1.43	1.52	0.94	1.56	1.59	1.59	0.59	1.62
Flashy	0.00	0.00	0.00	0.00	0.00	0.00	0.00	0.00	0.00	0.00	0.00	0.00	0.00	0.00
Moderate	0.16	1.46	0.92	0.93	1.10	1.15	1.00	0.91	0.98	0.80	0.73	0.75	0.16	0.91
Long term	0.43	1.67	1.33	1.41	1.47	1.40	1.32	1.21	1.53	1.15	1.59	1.59	0.43	1.32
Tidal	0.00	0.00	0.00	0.00	0.00	0.00	0.00	0.00	0.00	0.00	0.00	0.00	0.00	0.00
<b>c. Bridge type</b>														
New construction	1.18	3.60	2.35	2.20	2.89	3.15	1.83	3.15	3.17	2.99	2.38	2.46	1.18	3.28
Protection on existing bridge	0.44	3.21	1.78	0.96	2.32	1.91	1.43	1.91	0.44	3.19	1.95	1.54	1.02	1.93
<b>d. Other factors</b>														
Ice susceptibility	0.00	0.00	0.00	0.00	0.00	0.00	0.00	0.00	0.00	0.00	0.00	0.00	0.00	0.00
Debris susceptibility	0.16	0.96	0.42	0.67	0.40	0.37	0.52	0.37	0.52	0.33	0.34	0.28	0.16	0.46
Salt water	0.17	0.71	0.41	0.60	0.44	0.20	0.35	0.17	0.33	0.59	0.59	0.59	0.28	0.33
Regional Problems	0.14	0.99	0.57	0.59	0.57	0.57	0.57	0.57	0.66	0.66	0.57	0.57	0.28	0.59

Table 2.5 Screening Summary - Standard Deviation Cont'd)

Countermeasure:	Limits		Mean Value	Rock Filled Gabion	Sacked Concrete	Sacrificial Piles	Self-Launched Riprap	Sheet Piles	Slots	Suction	Tile Mats	Tri-lock Blocks	Vehicle Restriction	Vertical Plates
	Min	Max												
<b>Step 2. Technical Effectiveness</b>														
Hydraulic	2.01	3.70	2.81	3.12	2.61	2.88	2.69	3.03	3.07	2.28	2.86	2.89	2.01	3.45
Geotechnical	1.14	4.03	2.52	2.92	2.76	2.12	2.92	2.15	2.80	2.62	3.02	2.81	1.14	2.27
Geomorphic	1.10	3.61	2.20	2.90	1.83	1.43	3.15	1.41	2.22	2.68	1.83	2.11	1.41	2.79
Hydrologic	2.01	4.41	3.18	3.73	3.47	3.07	3.53	3.07	3.45	2.39	3.37	2.84	2.01	3.42
Climatic	0.00	0.00	0.00	0.00	0.00	0.00	0.00	0.00	0.00	0.00	0.00	0.00	0.00	0.00
Structural	1.02	4.48	2.42	3.29	1.95	2.31	3.31	2.10	2.42	1.69	2.80	2.50	1.02	2.68
Synergistic effects	1.81	4.18	2.91	2.76	1.81	2.75	3.55	2.72	3.49	2.86	3.08	2.48	1.88	4.06
Inspectability	0.92	3.77	2.54	3.45	2.38	2.29	3.77	2.29	3.09	1.79	2.58	2.74	1.02	2.78
<b>Step 3. Difficulty in construction</b>														
Level of expertise required	0.00	0.00	0.00	0.00	0.00	0.00	0.00	0.00	0.00	0.00	0.00	0.00	0.00	0.00
Need for specialized equipment	1.10	4.64	2.93	3.00	2.00	1.87	2.20	2.61	4.64	4.60	3.51	3.41	2.94	2.61
Extraordinary constr. time	0.00	0.00	0.00	0.00	0.00	0.00	0.00	0.00	0.00	0.00	0.00	0.00	0.00	0.00
Environmental impacts	1.68	4.15	2.79	3.37	2.22	4.15	3.12	3.60	3.18	2.28	2.00	1.68	2.16	2.76
<b>Step 4. Durability (3pts/yr)</b>														
Time without maintenance	2.60	17.23	7.91	4.81	5.83	6.32	9.78	6.87	17.23	5.22	5.66	5.59	9.09	9.55
<b>Step 5. Difficulty with maintenance</b>														
Difficulty with maintenance	0.00	0.00	0.00	0.00	0.00	0.00	0.00	0.00	0.00	0.00	0.00	0.00	0.00	0.00
<b>Step 6. Cost</b>														
Relative cost basis	0.00	18.83	9.25	9.12	8.67	7.16	9.63	7.16	15.59	12.46	6.32	5.37	16.08	8.29
<b>Step 7. Special Factors</b>														
Acceptability														
Social acceptability	0.00	14.42	6.91	5.66	2.00	2.00	14.42	0.00	12.65	13.42	8.94	4.00	12.00	4.00
Aesthetics	0.00	0.00	0.00	0.00	0.00	0.00	0.00	0.00	0.00	0.00	0.00	0.00	0.00	0.00
Environmental acceptability	0.00	0.00	0.00	0.00	0.00	0.00	0.00	0.00	0.00	0.00	0.00	0.00	0.00	0.00
Specific considerations (Define)	0.00	0.00	1.00	0.00	0.00	0.00	0.00	0.00	0.00	0.00	0.00	0.00	0.00	0.00
<b>TOTAL SCORE</b>	51.68	122.57	86.11	91.83	80.74	83.43	101.82	82.63	122.57	97.11	90.45	86.37	82.37	94.07

Table 2.5 Screening Summary - Standard Deviation Cont'd)

Countermeasure:	Limits:		Mean Value	High Density Particles	Horizontal Plates	Iowa Vanes	Modified Pier Texture	Modifying Pier Face	Modular Paving Units	Monitoring	Pavement	Peak flood Closure	Pier Vanes	Rock Bolting and Grouting
	Min	Max												
<b>Step 1: Feasibility</b>														
<b>a. Site characteristics</b>														
<b>Bed characteristics</b>														
cobble bed	0.62	1.39	1.01	0.87	1.11	0.83	1.25	0.93	1.05	0.75	0.96	0.75	1.18	1.29
gravel bed	0.49	1.26	0.88	0.75	1.07	0.77	1.25	0.93	1.15	0.57	1.10	0.57	0.93	1.06
sand bed	0.52	1.32	0.87	1.07	1.06	0.59	1.10	0.93	1.21	0.75	1.25	0.75	0.57	0.57
bedrock	0.49	1.51	1.09	0.93	1.31	1.25	1.25	1.23	0.89	0.75	1.34	0.75	1.28	1.08
cohesive bed	0.23	1.57	1.12	1.25	1.38	1.12	1.41	1.37	1.19	0.75	1.34	0.75	1.22	0.23
heavily silted (mucky)	0.00	1.21	0.78	0.60	0.75	1.07	0.20	0.17	1.10	0.71	0.52	0.71	0.99	0.00
<b>Pier position</b>														
main span	0.23	1.21	0.80	0.87	0.92	0.96	1.21	1.11	1.07	0.43	1.09	0.59	0.97	1.04
flood plain	0.33	1.47	1.07	1.15	1.17	1.22	1.47	1.40	1.21	0.43	1.15	0.59	1.26	1.04
adjacent to abutment	0.43	1.50	1.21	1.29	1.44	1.50	1.44	1.50	1.48	0.43	1.36	0.59	1.50	1.25
<b>Channel configuration</b>														
split	0.43	1.56	1.05	1.12	1.33	1.04	1.33	1.56	1.17	0.43	1.07	0.59	1.04	1.18
single	0.43	1.21	0.82	0.73	1.01	0.83	1.01	1.15	1.04	0.43	1.12	0.59	0.83	0.84
<b>b. Hydrograph characteristics</b>														
Ephemeral	0.49	1.79	1.36	1.49	1.56	1.43	1.09	1.29	1.59	0.59	1.57	0.59	1.16	1.48
Flashy	0.00	0.00	0.00	0.00	0.00	0.00	0.00	0.00	0.00	0.00	0.00	0.00	0.00	0.00
Moderate	0.16	1.46	0.92	1.00	1.19	0.91	1.19	1.33	0.75	0.49	1.46	0.16	0.88	1.00
Long term	0.43	1.67	1.33	1.28	1.67	1.32	1.54	1.54	1.59	0.71	1.67	0.43	1.32	1.28
Tidal	0.00	0.00	0.00	0.00	0.00	0.00	0.00	0.00	0.00	0.00	0.00	0.00	0.00	0.00
<b>c. Bridge type</b>														
New construction	1.18	3.60	2.35	2.83	3.60	2.63	3.03	2.08	2.61	1.18	2.60	1.18	2.31	2.27
Protection on existing bridge	0.44	3.21	1.78	1.57	3.21	1.71	3.04	2.36	1.71	1.28	1.38	1.02	1.95	2.63
<b>d. Other factors</b>														
Ice susceptibility	0.00	0.00	0.00	0.00	0.00	0.00	0.00	0.00	0.00	0.00	0.00	0.00	0.00	0.00
Debris susceptibility	0.16	0.96	0.42	0.28	0.46	0.37	0.67	0.54	0.28	0.16	0.34	0.16	0.37	0.57
Salt water	0.17	0.71	0.41	0.44	0.33	0.44	0.35	0.33	0.59	0.28	0.57	0.28	0.20	0.45
Regional Problems	0.14	0.99	0.57	0.59	0.60	0.66	0.66	0.66	0.57	0.99	0.66	0.28	0.66	0.66



Table 2.5 Screening Summary - Standard Deviation Cont'd)

Countermeasure:	Limits		Mean Value	High Density Particles	Horizontal Plates	Iowa Vanes	Modified Pier Texture	Modifying Pier Face	Modular Paving Units	Monitoring	Pavement	Peak flood Closure	Pier Vanes	Rock Bolting and Grouting
	Min	Max												
<b>Step 2. Technical Effectiveness</b>														
Hydraulic	2.01	3.70	2.81	2.85	3.12	3.56	3.34	3.70	2.89	2.01	3.08	2.01	3.55	2.91
Geotechnical	1.14	4.03	2.52	2.56	2.53	2.53	2.69	3.03	2.81	1.14	2.11	1.14	3.03	3.68
Geomorphic	1.10	3.61	2.20	2.56	2.62	2.05	3.06	2.01	2.11	1.41	1.74	1.41	2.87	3.61
Hydrologic	2.01	4.41	3.18	3.23	3.32	3.23	3.53	3.94	2.89	2.01	3.37	2.01	3.10	4.41
Climatic	0.00	0.00	0.00	0.00	0.00	0.00	0.00	0.00	0.00	0.00	0.00	0.00	0.00	0.00
Structural	1.02	4.48	2.42	2.24	2.93	2.01	2.01	2.62	2.50	1.02	2.75	1.02	1.78	3.13
Synergistic effects	1.81	4.18	2.91	3.33	3.85	3.33	3.31	3.73	2.48	1.88	2.22	1.88	3.33	3.22
Inspectability	0.92	3.77	2.54	3.36	2.78	2.51	3.17	3.11	2.74	1.02	3.31	1.02	2.38	1.21
<b>Step 3. Difficulty in construction</b>														
Level of expertise required	0.00	0.00	0.00	0.00	0.00	0.00	0.00	0.00	0.00	0.00	0.00	0.00	0.00	0.00
Need for specialized equipment	1.10	4.64	2.93	3.16	2.61	3.67	2.45	3.31	3.29	1.41	2.74	2.94	3.78	3.10
Extraordinary constr. time	0.00	0.00	0.00	0.00	0.00	0.00	0.00	0.00	0.00	0.00	0.00	0.00	0.00	0.00
Environmental impacts	1.68	4.15	2.79	3.08	2.83	3.17	2.83	3.10	1.68	2.16	3.12	2.16	3.06	3.37
<b>Step 4. Durability (3pts/yr)</b>														
Time without maintenance	2.60	17.23	7.91	9.85	9.38	7.27	9.96	14.39	5.59	2.83	2.60	8.64	7.48	12.93
<b>Step 5. Difficulty with maintenance</b>														
Difficulty with maintenance	0.00	0.00	0.00	0.00	0.00	0.00	0.00	0.00	0.00	0.00	0.00	0.00	0.00	0.00
<b>Step 6. Cost</b>														
Relative cost basis	0.00	18.83	9.25	14.25	10.04	5.22	11.80	12.77	4.90	0.00	8.00	18.83	12.13	13.37
<b>Step 7. Special Factors</b>														
Acceptability														
Social acceptability	0.00	14.42	6.91	12.65	0.00	2.00	10.00	0.00	8.00	12.65	12.81	12.00	4.00	4.00
Aesthetics	0.00	0.00	0.00	0.00	0.00	0.00	0.00	0.00	0.00	0.00	0.00	0.00	0.00	0.00
Environmental acceptability	0.00	0.00	0.00	0.00	0.00	0.00	0.00	0.00	0.00	0.00	0.00	0.00	0.00	0.00
Specific considerations (Define)	0.00	0.00	1.00	0.00	0.00	0.00	0.00	0.00	0.00	0.00	0.00	0.00	0.00	0.00
<b>TOTAL SCORE</b>	51.68	122.57	86.11	111.33	99.55	84.67	108.99	109.02	90.19	51.68	98.50	84.09	94.27	102.99

55

### **2.3 WORK PLANS**

In this section the results of the screening and field survey have been used to delineate a total of 20 countermeasures for pier scour that warrant prioritization for further study. Of these, 5 countermeasures were excluded from the present study for reasons outlined below. A work plan was formulated for each of the remaining 15. This section concludes with an outline of the work chosen for implementation as part of the present project.

#### **2.3.1 Prioritization of Countermeasures**

In total 20 possible countermeasures for scour around bridge piers were chosen as relevant to the present project, and thus were prioritized for future study. These countermeasures were divided into two basic types: armoring countermeasures and flow altering countermeasures, as listed below.

##### **Armoring countermeasures:**

- Anchors
- Artificial riprap (tetrapods, dolos, toskanes etc.)
- Cable tied blocks
- Extended footings
- Gabions and Reno mattresses
- Grade control structures
- Grouted riprap
- High density riprap
- Modular paving and tiling units
- Pavement
- Rock bolting
- Sacked concrete (grout filled bags and mattresses)
- Standard riprap

##### **Flow-altering countermeasures:**

- Collars and horizontal plates
- Flow-deflecting vanes or plates
- Modified pier texture
- Porous sheet piles
- Sacrificial piles
- Slot in pier
- Suction applied to pier

The methodology for the screening approach used to prioritize the various countermeasures is given in the preceding section. An essential part of screening was a subjective element used to determine a) which existing techniques have the most potential for further development and refinement, and b) which techniques not yet deployed in the field have the most promise. Screening was performed through the means of a standardized form, and also by means of a round-table discussion. Results are summarized in Table 2.6.

#### **2.3.1a Excluded Countermeasures.**

As a result of this process five countermeasures were excluded from the study. Extended footings were eliminated in that they are very similar to structural rehabilitation, and are thus excluded in the original problem statement. Grade control structures were excluded as they typically address the width of the river rather than scour at individual piers. They merit further consideration, however, under the

auspices of NCHRP Project 24-8. The experience of the research team with modular paving and tiling units was that once a single unit fails, the entire installation can be subject to rapid failure. Present placement techniques would additionally limit application. The method was not considered sufficiently promising in the context of bridge piers to warrant further study. Grouted riprap was rated low in the survey of field engineers. As grouting would reduce permeability, it could cause failure of the entire riprap layer due to uplift, thus negating the natural benefit caused by raveling of loose riprap into a scour hole. Finally, modified pier texture, while perceived as effective by the respondents to the survey, is not viewed as a countermeasure, but rather as a part of initial design and construction.

### 2.3.1b High-Priority Countermeasures.

Four of the countermeasures were deemed of high priority for further research. The main reason for this is the likelihood that further testing could allow for improved field implementation in a minimal amount of time. The first of these is standard riprap. Standard riprap provides the baseline against which to test all alternative countermeasures. Areas not yet well delineated as regards design include gradation, placement, the effect of high Froude number flows, stability in the face of stream degradation and the use and placement of geotextiles. Cable tied blocks, while not yet used routinely as a bridge scour countermeasure, show high potential for further development. When fastened together with cables, the blocks should show considerably greater resistance to erosion than any single block. In addition, the potential for mass-production of a standardized design that is easily installed appears reasonably high. Questions arise, however, about the mode of failure, the areal extent of cover needed, the use of anchors and the tie-in with the pier itself. Sacked concrete, including grout filled bags and mattresses, would appear to provide one of the simplest and most cost-effective alternatives to riprap. An innovation suggested in the work plan, imbricated stacking, could enhance their resistance to the flow. Finally, gabions and Reno mattresses have a time-honored use in bank protection. A recent report from New York State has suggested that they have not performed well in the field there. It is possible, however, that this problem can be overcome with appropriate changes in design.

### 2.3.1c Medium-Priority Countermeasures.

Nine of the countermeasures were included under the category of medium priority. Artificial riprap such as tetrapods, dolos and toskanes have already been tried as scour countermeasures at bridges. They are given only medium priority here due to a recent, rather thorough study on toskanes for the Pennsylvania Department of Transportation. Sacrificial piles have already been tried on a few bridges in the field, and encouraging results have been obtained. Flow-deflecting vanes and plates such as Iowa vanes and pier-installed vanes have proved successful for other erosion problems, and have some notable but as-yet unrealized potential for bridge piers. Collars and horizontal plates have shown promise in numerous laboratory studies, but have never been evaluated comprehensively. High density riprap replaces size with weight. Each stone thus should offer greater resistance to the flow, while being less exposed to the drag and lift of the flow. A simple means of testing high-density riprap is offered in terms of rock waste from taconite mines. Permeable sheet piles offer the hope of protection against pier scour using the same principle as permeable dikes in rivers and snow fences. In the case of bridges on bedrock, rock bolting would appear to be a useful alternative to the blasting of large quantities of rock. Finally, anchors constitute a supplemental method by which stability may be added to grout filled mattresses and mats consisting of cable tied blocks.

### 2.3.1d Low-Priority Countermeasures.

Three countermeasures were included in this category. The concept of a slot in pier, while holding some promise as a countermeasure to be installed at the time of bridge construction, would prove hard to retrofit without damaging the structural integrity of the pier itself. Suction applied to a pier requires a mechanical system that must not malfunction precisely when it is most likely to be under stress, i.e. at the peak of a flood. It is also particularly subject to jamming with debris. Finally, pavement may have some

local applications on ephemeral streams in arid environments, but may destabilize itself by too thoroughly sealing the bed.

Work plans are included here for all 15 countermeasures that were not excluded from consideration. Of these work plans, 12 require experimental work before field testing can begin; another three, specifically anchors, pavement and rock bolting either require no laboratory work or are unsuitable for laboratory study. The work plans could be implemented on a stand-alone basis. It would be more effective, however, to tie various ones together for maximum result. For example, cable tied blocks may perform best when the leading edge is stabilized with anchors; a proper evaluation of their performance would involve a comparison with standard riprap.

**Table 2.6. Summary on Prioritization of Countermeasures**

Priority	Countermeasure
High-priority countermeasures	<ul style="list-style-type: none"> <li>• Standard riprap</li> <li>• Cable tied blocks</li> <li>• Sacked concrete</li> <li>• Gabions and Reno mattresses</li> </ul>
Medium-priority countermeasures	<ul style="list-style-type: none"> <li>• Artificial riprap</li> <li>• Sacrificial piles</li> <li>• Flow-deflecting vanes and plates</li> <li>• Collars and horizontal plates</li> <li>• High density riprap</li> <li>• Permeable sheet piles</li> <li>• Rock bolting (bedrock bridges)</li> <li>• Anchors</li> </ul>
Low-priority countermeasures	<ul style="list-style-type: none"> <li>• Slot in pier</li> <li>• Suction</li> <li>• Pavement</li> </ul>
Excluded countermeasures	<ul style="list-style-type: none"> <li>• Extended footings</li> <li>• Grade control structures</li> <li>• Modular paving and tiling units</li> <li>• Grouted riprap</li> <li>• Modified pier texture</li> </ul>

The research team tried to be as innovative as possible in devising the work plans. Examples of this innovation include the proposal to use rock waste from a mine for testing high density riprap, the use of imbrication to increase the stability of units of stacked concrete, the importation of technology from permeable dikes and snow fences to the concept of porous sheet piles, the use of rock bolting to provide stability at bedrock sites without excessive blasting, the proposal for pier attached vanes as an alternative to Iowa vanes and the proposed field testing of collars and horizontal plates. Even in the case of standard riprap, an evaluation of resistance to channel degradation is proposed.

It should be emphasized here that it is not sufficient to evaluate a scour countermeasure in regard to local scour around a pier alone. The survey conducted for NCHRP Project 24-8 revealed that undermined bridge piers are often affected by a combination of both pier and abutment scour. It appears, then that the effects of the two may not be simply additive. The importance of at least some evaluation of a countermeasure when subjected to a combination of pier and abutment scour has been written into the work plan for standard riprap. The research team recommends including, when possible, this combination effect for laboratory studies of all alternatives to standard riprap as well.

In the case of the twelve work plans involving experimental work, a cost estimate is given as a stand-alone project, and as part of a larger project. This is because including the testing of any given

countermeasure within a larger project allows for a) reduced start-up costs and b) economies of scale. Appropriate pricing for field work has in all these cases been deferred until after the completion of the laboratory work.

### 2.3.2 Armoring Countermeasures

#### 2.3.2a Standard Riprap

The use of granular material as riprap has a long tradition in both river and coastal protection works. In the case of riprap as a countermeasure against scour around a bridge pier, Engels (1929) has cited an example that dates back as early as 1893. Here "standard riprap" refers to the use of natural stones with a specific gravity of around 2.65 for such purpose. This is in contrast to such variations as tetrapods, high density riprap, gabions etc., and for which work plans are also presented in this report.

The principle behind using riprap as a countermeasure against scour is that large stones are heavier than the grains of the river bed itself, and hence should be able to withstand the elevated shear stresses that form around a bridge pier. The efficiency of standard riprap in reducing scour is primarily dependent on the rock size, gradation, angularity, thickness, lateral extent of coverage, finished level of riprap layer and filter design. The use of a filter is to ensure that underlying fine sediment particles do not leach through the voids of the individual stones composing the riprap. The edge between the coarse riprap stones and the fine sediment particles on the river bed may form a zone of weakness where a secondary scour hole can develop, which can then lead to the failure of the riprap layer by raveling into the secondary hole.

#### Experience with unit design

No "unit design" is required for standard riprap, as the material in question is essentially natural. Instead, guidelines for median grain size, size distribution, and placement techniques are required. Although the use of natural stones as a countermeasure against scour has been practiced for over a century, relatively few systematic studies have been devoted to the determination of guidelines for the implementation of this technique. Most of these involve the use of an Isbash-type criterion for sizing the stones (e.g. Neill, 1967, 1973; Maynard, 1987). The basis for existing design procedures for riprap is bank protection. A summary of standard design criteria for riprap can be found in Richardson et al. (1993). Quazi and Peterson (1973), Parola (1991, 1993) and Chiew (1995) provide contributions to unit design that pertain specifically to the case of bridge piers. Experience with riprap is such that design techniques for its use are relatively mature. This does not mean, however, that there is not room for significant improvement.

#### Experience with field application

**Bridge piers** Standard riprap is the most common countermeasure for bridge pier scour; some 6000 cases of its use are reported in the field survey documented in the First Interim Report of this study. This comment notwithstanding, the success of the technique seems never to have been comprehensively evaluated, so that its efficacy in protecting against bridge pier scour remains surprisingly uncertain. It appears that riprap performs well during moderate floods. Under extreme flow conditions, however, especially when sand dunes are present, the reliability of the riprap layer decreases.

**Other** The use of riprap stones in the protection of river banks has a long history. When appropriately designed and constructed, the riprap layer can successfully protect the bank from erosion.

#### Notes on

**a) applicability** The technique is perhaps the most universally applicable of the countermeasures considered in this study. Under the right circumstances, riprap can be quite successful in protecting bridge piers against scour. However, its performance under a wide variety of flow

conditions, and in particular under live-bed conditions when bedforms are present, has not conclusively been determined.

**b) design** A range of design guidelines can be found in the published literature and in design manuals. The differences in these guidelines suggest that a complete degree of standardization has not been achieved. A standardized set of design guidelines should outline its efficiency in regard to the choice of grain size distribution, the presence or absence of bedforms, and the passage of extreme floods.

**c) construction and maintenance** No specialized construction technique is needed for the use of riprap as a pier scour countermeasure. Difficulties do arise in regard to the installation of a filter layer or geotextile should one be needed.

**d) performance evaluation** The performance of a standard riprap layer around a bridge pier does not appear to have been systematically tested in the field. Such a field test is needed. The test could be conducted using a pair of piers, one with and one without the riprap layer.

**e) cost** The cost of using standard riprap as a pier scour countermeasure is expected to be the lowest of all countermeasures considered in this report as long as the type of riprap stone required is readily available. No special expertise in design and construction procedures is needed.

#### Major research needs

A close examination of the published literature reveals that there is still some lack of systematic investigation on the performance of riprap as a countermeasure against bridge pier scour. Although some research studies have been conducted in the last few years on riprap around bridge piers under clear-water conditions (e.g. Parola, 1991, 1993; Chiew, 1995), there is still a dearth of information on how riprap performs under the conditions of a) live-bed flow, for which bedforms may be present and b) a river channel subject to degradation, where there is a stress in riprap in addition to flooding. In addition, there are few tests on the efficiency of a filter layer of geotextile used in conjunction with riprap. The effect of grain size distribution on riprap performance has been studied by e.g. Maynard (1987), but clearly deserves more attention.

Another important topic to consider is the extent of protection, especially for long slender piers with skew. Some studies in this regard were made by Hjort (1975), but more detail on the design of the area of protection is needed, especially for non-cylindrical piers.

A final issue of importance pertains not only to riprap but to all countermeasures considered in this report. The bridge piers most likely to be exposed by unacceptable levels of scour are typically those affected by some combination of local pier scour and abutment scour. The assumption that such scour is simply additive for design purposes may be grossly in error in some cases.

Additional laboratory data for both clear-water and live-bed conditions, using uniform and graded riprap, in a stable and degrading channel, and with and without the additive effect of abutment scour should provide a significantly improved understanding of the performance of standard riprap as a pier scour countermeasure. This will enhance the reliability of this technique. Testing the device using a non-cylindrical pier would also help to provide a more comprehensive data base for the development of design guidelines.

#### Recommended experimental program

The experimental program should be designed in the first instance to confirm existing data and design criteria for the performance of standard riprap under clear-water conditions. The effect of rock size, gradation, thickness, lateral extent of coverage, finished level of riprap layer relative to the undisturbed bed level etc. on the performance of the device should be examined systematically. The experimental tests should aim to develop design specifications that can be used in a field implementation.

In addition to the above, the performance of the riprap layer under live-bed conditions, especially when bed features are present, and in a degrading channel should be investigated. The program should

include tests on the use of a filter layer or geotextile, which has the effect of controlling leaching of fine underlying sediment particles from under the riprap layer. Both cylindrical and non-cylindrical piers should be tested to provide a more comprehensive data base for the development of the design guideline. At least a few cases should include combined pier and abutment scour.

With the above comments in mind the following experimental program is recommended.

*Task 1:* Build an experimental facility at a large but manageable scale for the purpose of evaluating the performance of standard riprap as a scour countermeasure at bridge piers. The experimental facility should allow for testing under both clear-water and mobile-bed conditions. It should allow for both rectangular and cylindrical bridge piers. Provisions should be made for the inclusion of a model abutment, so that the performance of riprap under the combined effects of pier and abutment scour can be studied.

*Task 2:* Use the facility to test the effect of rock size, gradation, thickness, lateral extent of coverage, and finished level of riprap layer relative to the undisturbed bed level on the performance of riprap as protection against pier scour. The flow conditions, including undisturbed flow velocity and approach flow depth, should also be varied so as to cover a range of Froude numbers and flood hydrograph durations. The case of combined pier and abutment scour should be included.

*Task 3:* Perform a series of tests to determine the performance of filter layers and geotextiles when used in connection with standard riprap placed around a bridge pier. In order to minimize scale effects, this series of test should be conducted at near-prototype scale.

*Task 4:* Perform a series of tests to determine the performance and failure of riprap under a combination of flood flow and channel degradation. Determine allowable degradation levels for continued performance of the riprap.

*Task 5:* Amalgamate the above results into a report which contains specific design guidelines based on the experiments, and also recommends an appropriate program of field testing.

#### Recommended field program

The field program should be designed to test some of the promising configurations and/or combinations of pier scour countermeasures determined in the course of this study and related studies. In each field test riprap should thus be used in tandem with at least one of the other countermeasures. In the test, an appropriately designed riprap layer should be placed and the scour hole development monitored throughout the test period. Photographic and/or acoustic surveys may be conducted at regular intervals to provide imaging of the riprap layer. The period of field monitoring should be sufficiently long so as to include at least one major flood where bedforms might be present, and to allow for an evaluation of long term durability. Rather than limiting the study to a single bridge, as many sites as possible should be chosen over a wide variety of settings. Insofar as some 6000 cases of the use of riprap in regard to bridges have been identified by the survey of the First Interim Report of this project, such an undertaking would not be too onerous were it coordinated with the various state agencies.

#### Recommended evaluation of cost effectiveness

In most applications riprap is undoubtedly the cheapest countermeasure against bridge scour. It may not always be the most cost-effective countermeasure. Its cost-effectiveness becomes a problem only when material of the desired size is unattainable, is too costly to ship, or cannot be procured in time to implement the pier protection desired. The cost of riprap should be a part of the litmus test by which all other alternative countermeasures such as tetrapods, gabions and vanes are evaluated.

#### Estimated cost of experimental program

As part of a larger project: \$110,000

As a stand-alone project: \$175,000

### References

- Chiew, Y. M., "Mechanics of Riprap Failure at Bridge Piers." *Journal of Hydraulic Engineering, ASCE*, Vol. 121, 9 (1995), pp. 635-643.
- Engels, H. (1929). "Experiments pertaining to the protection of bridge piers against undermining." *Hydraulic Laboratory Practice*, J. R. Freeman (ed.), American Society of Mechanical Engineers, New York.
- Hjorth, P., "Studies on the Nature of Local Scour." *Sweeden Bulletin*, Lund Institute of Technology, Series A, No. 46 (1975), pp. 191.
- Maynard, S. T., "Stable Riprap Size for Open Channel Flows." *Ph.D. Thesis*, Department of Civil Engineering, Colorado State University (1987), 115 p.
- Neill, C. R., "Mean Velocity Criterion for Scour of Coarse Uniform Bed" 12th IAHR Congress, Ft. Collins, CO., *Proc. Vol. 3* (1967), pp. C6.1 - C6.9.
- (Neill, C. R.), *Guide to Bridge Hydraulics*. University of Toronto Press (1973) 191 p.
- Parola, A. C., "The Stability of Riprap Used to Protect Bridge Piers." Federal Highway Administration, *Report FHWA-RD-91-063* (1991).
- Parola, A. C., "Stability of Riprap at Bridge Piers." *Journal of Hydraulic Engineering, ASCE*, Vol. 119, 10 (1993), pp. 1080-1093.
- Quazi, M. E. and Peterson, A. W., "A Method for Bridge Pier Rip-rap Design." First Canadian Hydraulics Conference, Edmont, Canada, *Proc.* (1973), pp. 96-106.
- Richardson, E. V., Harrison, L. J., et al., "Evaluating Scour at Bridges." U. S. Department of Transportation FHWA, *Report 18 (HEC-18) FHWA-IP-90-017* (1993).

### 2.3.2b Anchors

At many bridge sites, rock suitable for use as riprap is not available at affordable costs. Countermeasures other than use of riprap include rock-filled gabions, Reno mattresses, grout filled mats and bags, articulated and/or cable tied concrete mattresses and slabs, as well as pavements. These countermeasures are effective to the degree that they provide a surface layer of armor over erodible bed and bank materials around bridge piers and abutments. A common mode of failure of surficial layer armoring countermeasures is rollup of layer edges and/or displacement of protective layers as integral sheets or large pieces. Uplift and drag forces around piers and abutments cause such failures; resisting these forces by providing greater thicknesses, widths or weights of protective layers may not be nearly as economical as resisting uplift forces by the use of anchors secured in stream beds and banks. However, little design guidance exists for the use of rock or soil anchors specifically at bridge piers and abutments.

#### Experience with unit design

Very comprehensive experience and research has been documented for the use of driven, drilled and grouted anchors in earth retention structures (Weatherby 1982; Mitchell and Villet 1987). Anchors have been used for many years to stabilize structures against overturning forces by providing tensile capacity in foundation systems (e.g., Bruce 1992). In recent innovations, soil and rock slopes have been retained by anchors used in conjunction with almost nominal surface treatments, in so-called "soil nailing" applications (Mitchell and Villet 1987; Task Force 27 1990; Alston and Crowe 1993).

#### Experience with field applications

Many proprietary systems have been developed for the manufacture and installation of soil and rock anchors, an example being Chance helical anchors. Anchors vary in number, spacing and size from units 10 m or more in length, with multiple cables or strands, and capable of resisting tensile forces of hundreds or thousands of kilonewtons, to so-called "pali radice" or pinpiles only three to four meters in



length (Mitchell and Villet 1987; Bruce 1992), to single reinforcing bars driven at spacings of less than a meter and only two to three meters long. Special attention must be given to design of connections between anchors and retaining wall or foundation elements (Task Force 27 1990 p. 180-2; Collin and Berg 1993).

#### Notes on

a) **applicability.** In almost all applications of soil and rock anchors, even in temporary support for excavations, designers are reluctant to use anchors secured in fine-grained soils such as clays and clayey silts, because anchors secured in such materials tend to creep. Consolidation of fine-grained soils under the stresses applied by anchors, and/or viscous shear of such soils along anchors, gradually release the pre-stress loading used in anchors to reduce movements of structural systems that retain excavation sidewalls. Design practice among foundation engineers does not allow use of anchors secured in fine-grained soils for long-term support or stabilization of buildings, walls or dams, unless creep tests show that long-term capacity is adequate (Task Force 27 1990, p. 186-9). On the other hand, anchors may develop very significant short-term capacities in stiff to hard fine-grained soils, and moderate load capacities even in medium to soft clays and clayey silts. Such moderate short-term capacities may be more than adequate to resist the uplift forces on surface-layer armoring countermeasures used against scour at bridge piers and abutments; for that matter, creep may be unimportant in anchors designed to secure surface layers of armoring against scour at bridges.

b) **design.** Little or no information exists on the magnitude of uplift forces actually generated on field installations of pier countermeasures that consist of surface layers of armoring. The uplift force generated in an anchor used with such countermeasures would depend on the anchor spacing (number of anchors per unit area of armoring), thickness and unit weight of the armor layer, pier or abutment geometry, and hydraulic characteristics of the flow field at the bridge pier or abutment.

c) **construction and maintenance.** Ground anchors installed at several bridge sites with differing foundation materials and different surface layer countermeasures would allow monitoring of anchor loads and movements during flood events as well as to provide well-documented data on anchor performance and a variety of soil types.

d) **performance evaluation.** To develop information on which design manuals for countermeasure anchors can be based, it is proposed that anchors be installed in conjunction with several applications of scour countermeasures, and that those anchors be instrumented so that anchor forces and movements can be determined.

e) **cost.** As anchors are in standard use today, a general evaluation of their cost can be made. In the context of bridge pier scour countermeasures such as grouted mats or cable tied blocks, they would constitute an add-on to the cost of the countermeasure itself.

#### Major research needs

The use of anchors should be considered in the research outlined in several other work plans included in this report, including "Sacked Concrete" and "Cable tied Blocks." The research proposed in this work plan is intended to complement and supplement such research on the use and effectiveness of surface-layer armoring countermeasures that are alternatives to the use of riprap.

#### Recommended experimental program

No independent experimental program is recommended for anchors.

#### Recommended field program

The objectives of this research are: 1) to install ground anchors at several bridge sites to include differing foundation materials (from coarse materials such as gravel to fine-grained silts and clays) and different surface layer countermeasures (e.g., grout filled mats and articulated concrete mattresses); and 2) to instrument a sufficient number of those anchors to allow monitoring of anchor loads and movements

during flood events as well as to provide well-documented data on anchor performance in a variety of soil types. To accomplish these objectives, the following work phases and tasks are envisioned.

*Task 1:* Review relevant literature to collect and synthesize existing experience and design rules for the use of soil/rock anchors. Case histories and field studies of anchor performance should be sought in preference to manufacturers' rules for anchor use and guidelines on anchor capacity.

*Task 2:* Analyze the Task 1 data to evaluate the adequacy of the collected data as a basis for design of anchors for surface-layer scour countermeasures at bridge piers and abutments. It is anticipated that experience with anchors in clays and silts will be much less plentiful than experience in coarse soils, and not well documented. In the event that sufficient data are not available to form the basis for anchor design in fine-grained soil types, the project team should undertake a limited number of anchor tests to characterize the performance of several common anchor types in short-term loading in fine-grained soils.

*Task 3:* Submit an interim report and revised work plan within six months. The interim report will document results of Tasks 1 and 2 and include information on the synthesis of available data into preliminary design guidelines for anchors to retain surface-layer scour countermeasures. The interim report also will include information on installation methods for soil/rock anchors to be used at bridge piers and abutments, and guidelines for design of connections between anchors and scour countermeasure elements. A work plan for field testing of selected anchor types at several bridge sites should be submitted as part of this task.

*Task 4:* Identify several bridge sites where comprehensive information is available on subsurface conditions and flow characteristics during flood events. Sites should include various types of soils, but must include fine-grained silts and clays. Sites also must be selected on the basis of a past history or serious anticipation of scour problems and planned installation of surface layer countermeasures against scour.

*Task 5:* Conduct a field study of anchor performance at the selected bridge sites. Instrument a number of anchors at each site so that anchor loads and movements can be determined during flood events. Anchor loads should be related to uplift pressures generated around piers and abutments, and flow parameters describing the experienced flood events, to provide additional information for design of countermeasures. Monitor the performance of the scour countermeasures to evaluate the overall adequacy of the anchors used at each site.

*Task 6:* On the basis of the information gathered during the literature search and collected during the field study, develop design criteria to identify situations in which anchors will not be effective, and to facilitate anchor selection, sizing and spacing for various types of surface-layer scour countermeasures, and design of connections between countermeasure elements and anchors. Provide methods for estimating costs of anchors relative to alternative techniques such as thickening surface layers of armor materials or use of high-density armor materials.

*Task 7:* Submit a final report that summarizes research results in the form of a method for designers to identify conditions under which anchors can be used effectively to retain surface armor layers around piers and abutments, and design recommendations for anchor selection, sizing and spacing, and connections between anchors and countermeasure elements.

#### *Recommended evaluation of cost effectiveness*

Very significant savings may be achieved if anchors can be used to retain relatively thin and inexpensive surface layers of armor to prevent scour around bridge piers and abutments, in lieu of expensive riprap (where size or quality of available rock is not suitable for riprap) or very thick or extensive, and therefore expensive, layers of grouted mattresses or similar surface armor. No reliable body of information exists on anchor performance in this use, especially for anchors in fine-grained clays and silts. Comprehensive experience on the use of anchors in earth retention systems and in foundation augmentation techniques may be imported for guidance of design for anchors under scour countermeasures, with a very limited amount of field testing.

Estimated cost of program

**Funding Recommended:** \$150,000.

**Research Period:** 48 months

References

Alston, C., and Crowe, R. E., "Design and Construction of Two Low Retaining Wall Systems Restrained by Soil Nail Anchors." *Transportation Research Record No. 1414: Segmental Concrete MSE Walls, Geogrid Reinforcements, and Soil Nailing*, Transportation Research Board, Washington, (1993) p. 49-58.

Bruce, D. A., "New Horizons in Ground Anchoring, Pinpiles and Cement Grouting." Proc., In-Situ Soil Modification-Twenty-third Ohio River Valley Soils Seminar, Louisville, (1992) Part 2, p. 1-25.

Collin, J. G., and Berg, R. R., "Connection Strength Criteria for Mechanically Stabilized Earth Walls." *Transportation Research Record No. 1414: Segmental Concrete MSE Walls, Geogrid Reinforcements, and Soil Nailing*, Transportation Research Board, Washington, (1993) p. 32-37.

(Mitchell, J. K., and Villet, W. C. B., *Reinforcement of Earth Slopes and Embankments*. NCHRP Report 290; Transportation Research Board, Washington, (1987) 323 p.

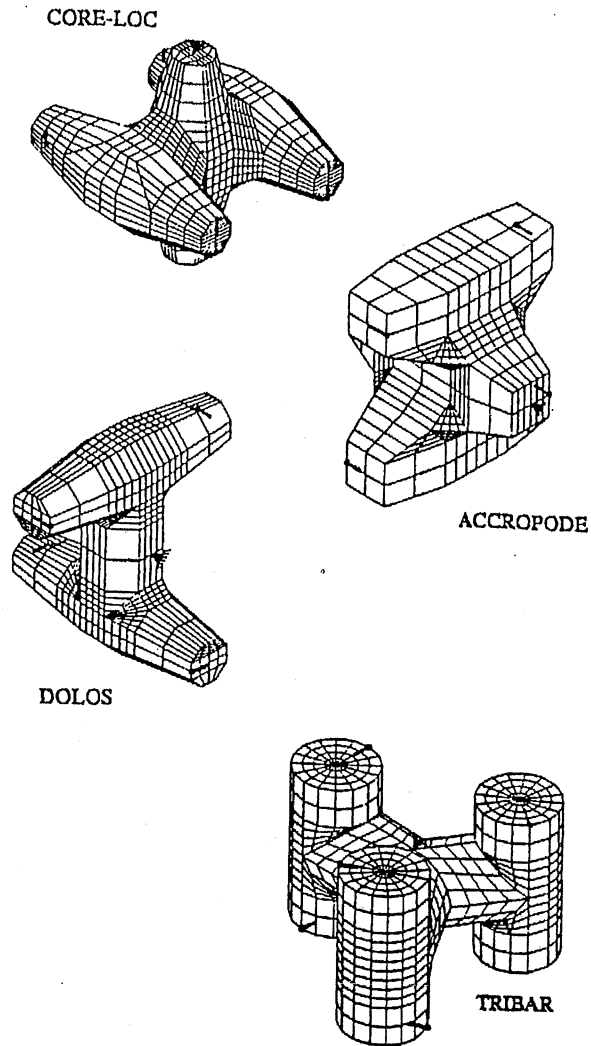
(Task Force 27), *In Situ Soil Improvement Techniques*. AASHTO-AGC-ARTBA Joint Committee, Subcommittee on New Highway Materials Report, AASHTO, Washington, (1990) 324 p.

(Weatherby, D. E.), *Tiebacks*. Report No. FHWA/RD-82/047, Federal Highway Administration, Washington, (1982) 232 p.

2.3.2c Artificial Riprap

Artificial riprap (Figure 2.14) is an alternative to regular riprap that is typically fabricated in the form of standard units. The prototype for artificial riprap is the tetrapod familiar from the coastal environment. The technique becomes cost effective where the cost of acquiring the appropriate natural riprap is higher than fabricating artificial riprap units. These units are generally constructed from reinforced concrete; some are fully metallic or made of composite materials. Various designs for shape and size are available, with such commercial names as Accropodes, Core-Loc™, Dolos, Tetrahedrons, Tetrapods, Toskanes, Tribars, etc. (Turk and Melby, 1995; Ruff and Fotherby, 1995).

All are designed to give a maximum amount of interlocking using a minimum amount of material. They are successful in the coastal environment in that they are designed to break the energy of waves. One reason for their stability is their shape, which is chosen to achieve a higher degree of interlocking than can be expected even with the most angular riprap. Since they are of standard size, however, they do not provide a means for preventing the leaching of bed material from below. With this in mind, it is not guaranteed that they would provide a successful means of scour protection around bridge piers unless appropriate filters are placed between the units and the bed material.



**Figure 2.14.** Artificial riprap.

They were originally developed to protect ocean shorelines. According to the US Army Coastal Engineering Research Center (1977), the first use of tetrapods in the US was for the extension of the breakwater of Crescent City, California in 1957. Two layers of 25-ton tetrapods were used to build out the breakwater. Since that time the use of tetrapods and related devices as a means of shore protection has proliferated. They have been successfully used for breakwaters, groins, jetties and sea walls. On a recent study, Ruff and Fotherby (1995) report 455 references for shoreline protection but only 9 for rivers.

Experience with unit design

There is a large body of experience on the design of artificial riprap for shoreline and river-bank protection. Only a few references could be found pertaining to the specific purpose of protecting bridge piers from scour.

Okada and Muraishi (1990) published an article in the Japanese National Railways Quarterly Report on a "statistical design method for anti-scour block work around bridge piers". The article includes a statistical analysis of 197 sets of data from a survey of "concrete block works" for railway bridge piers which have experienced floods. The authors analyzed the data to derive an empirical method to determine the weight and area of coverage around piers for concrete armor units.

In the United States, the FHWA has recently investigated alternatives to riprap as a scour countermeasure. Two interesting reports pertaining to the work are Bertoldi et al. (1994), which is concerned with Tetrapods, and Ruff and Fotherby (1995), which focuses on Toskanes. A complete design procedure is detailed in the latter report.

#### Experience with field application

**Bridge piers.** Tsujimoto et al. (1987) discuss the field application of artificial riprap to protection works around bridges. The primary focus of the article is whether artificial riprap, when stacked around a pier, alleviates or accentuates pier scour. Photographs in the article show concrete armor units installed around bridge piers in the Kinu River in Japan. The units are identified as hollow tetrahedrons, cubic blocks etc.. Okada and Kunigiro (1986) also report the field use of artificial riprap in Japan. The report by Ruff and Fotherby, 1995 on Toskanes includes several proposed field implementations for bridge piers. A single case of the use of artificial riprap was reported in the survey documented in the First Interim Report of this project.

**Other.** As mentioned previously, the technique has been widely applied for shoreline protection. It is also used for river-bank and dam protection. A report by Fotherby and Ruff (1993) on concrete armor units identified 73 shapes for use in ocean applications. A broad variety of field applications are documented there, as well as nearly 450 references in the literature to them.

#### Notes on

a) **applicability.** The technique is potentially useful wherever riprap can be used. It is particularly applicable when the size of riprap is not small compared to the flow depth, or when the right size and quality riprap is very expensive to transport to the bridge site.

b) **design.** Fotherby (1992, 1993) performed a comparative test of riprap and tetrapods. Tetrapod stability was cast into the form of an Isbash-type relation;

$$\frac{U_{rc}^2}{g(S_s - 1)D_r} = E \quad (2.8)$$

where  $U_{rc}$  is the critical velocity for motion of the stone,  $D_r$  is the equivalent spherical diameter,  $S_s$  is the specific gravity of the material and  $g$  is the acceleration of gravity. The parameter  $E$  takes a value of 1.5 for units placed in flowing water and a value of 2.9 for units that moved and found a "seat". Fotherby's study suggested that tetrapods offer little advantage compared to riprap in terms of stability. Tetrapod stability was not significantly affected by placement density over the range of conditions covered. Stability did increase with the lateral extent of placement. Bertoldi et al. (1994) extended the work of Fotherby using the same facility. Their equivalent spherical diameter for tetrapods is also the same as that of Fotherby. They obtained a general stability diagram of Isbash type based on Eq. (2.8) for tetrapods and riprap within which the two types are not readily distinguishable. Fotherby and Ruff (1995) developed a complete design procedure for the armor unit called Toskanes. Details can be found in the original report. The authors have attempted to be as precise as possible in specifying methods for design and implementation.

c) **construction and maintenance.** Specially constructed molds can be made (usually from steel) that allow for easy pouring of concrete. This yields a relatively precise standardization of unit size and shape. Installation of artificial riprap as a scour countermeasure requires careful placement around the bridge pier. When more than one layer is used, placing the units in their most efficient interlocking position provides greater stability as opposed to dropping them into an arbitrary position irrelevant to the previous layer of armor units. Also, a filter fabric is recommended underneath all artificial riprap applications. If the armor units are large, machinery may be needed to lift and lower them into position. Divers can ensure that the units are properly placed in their most efficient interlocking positions. Maintenance depends on the durability of the material. It may be necessary to replace those units washed out after a major flood event.

d) **performance evaluation.** Few field performance evaluations for artificial riprap are available; two of these are in the Japanese literature. The most common mode failure of armor units appears to be edge failure.

e) **cost.** In the case of artificial riprap the cheapest construction would probably be from molded concrete, perhaps liberally spiked with some form of pelleted or powdered scrap iron. (See the work plan "High Density Riprap".) The question of relevance is whether or not the added expense of molding the units (and adding the iron) would be counterbalanced by the smaller quantity needed for successful installation, and a possibly reduced transportation cost. An answer to this question is necessary in order to determine feasibility. The cost of placement is increased if the units must be placed in specific positions in order to achieve maximum interlocking.

#### Major research needs

The research of Ruff and Fotherby (1995) has answered many of the design questions in regard to the use of Toskanes; the level of research for tetrapods is not far behind. The most pressing research need in regard armor units is a determination of the filter requirements for good performance. A second need is a comparison of the various unit types to determine the one most preferable for the fluvial, as opposed to coastal environment. It appears that Ruff and Fotherby (1995) have made considerable progress in regard to this last point.

Other research needs to be considered with respect to artificial riprap include: area of placement, interlocking capabilities and cost effectiveness relative to riprap.

#### Recommended experimental program

The experimental program should be designed to confirm or modify existing formulations for sizing the armor units. An issue of importance in the experiments concerns the extent of placement and the total volume in comparison with standard riprap. It would be useful to test armor units with different shapes, and perhaps different densities.

The following experimental program is recommended.

*Task 1:* Build an experimental facility at the largest manageable scale for the purpose of evaluating the performance of artificial riprap as a scour countermeasure at bridge piers. The experimental facility should allow for testing under both clear-water and mobile-bed conditions. It should allow for both rectangular and round bridge piers.

*Task 2:* Use the facility to evaluate existing design criteria for armor units. If possible both natural and artificial riprap should be tested. The mode of construction and shape of the artificial riprap should be compatible with other countermeasures already in use in the field. Placement of the armor units should be in accordance with the criterion of maximum interlocking. The results should be verified against tests with standard-density riprap.

*Task 3:* Perform a series of tests to determine whether any modifications of the placement procedure recommended for standard riprap enhances the performance of artificial riprap. Evaluate the effectiveness of geotextiles and/or filter layers.

*Task 4:* Perform an assessment of potential sources for different commercially available armor units that can be applied to protect bridge piers from scour, and evaluate potential *in situ* fabrication techniques for artificial riprap.

*Task 5:* Amalgamate the above results into a report which contains specific design guidelines based on the experiments, and also recommends an appropriate program of field testing.

#### Recommended field program

The program should be devised to test both natural and artificial riprap. Ideally at least two bridges would be tested, one on a low-slope sand-bed stream and one in a mountain stream capable of moving cobbles or coarser material. In the test, one pier would be riprapped in the standard way, and an

adjacent one subject to essentially the same flow conditions would be riprapped with the armor units in accordance with the design specifications determined from the experiments.

The period of field monitoring should be sufficiently long so as to include at least one major flood, and also to allow for an evaluation of long-term durability.

#### Recommended evaluation of cost effectiveness

The evaluation of the cost-effectiveness of artificial riprap can proceed in a straightforward manner, due to the fact that the unit cost of fabrication and placement is well known. A detailed cost evaluation of the installation of Toskanes and riprap at the same bridge site was reported at the January, 1996 Annual Conference of the Transportation Research Board. The cost estimate for Toskanes was over 20 times the estimated cost for standard riprap.

#### Estimated cost of experimental program

As part of a larger project: \$110,000

As a stand-alone project: \$175,000

#### References

- Bertoldi, D. A., Jones, J. S., et al., "An Experimental Study of Scour Protection Alternatives at Bridge Piers." Federal Highway Administration, Turner-Fairbank Laboratory, *Report* (1994).
- Fotherby, L.M. and Ruff, J.F. "Review of Concrete Armor Units, Report for Pennsylvania." Report for Pennsylvania Department of Transportation, Colorado State University, February (1993), 136 p.
- Fotherby, L.M. and Ruff, J.F. "Bridge Scour Protection System Using Toskanes-Phase I." Pennsylvania DOT, *Report 91-02* (1995).
- Okada, K. and Kunigiro, T. "Flood-Time Stability Evaluation For Anti-Scour Concrete Block Work for Pier Protection." Quarterly Report of Railway Technical Research Institute, Japan, Vol. 17, No. 1. (1986), pp. 11-14.
- Okada, K. and Muraishi, H., "Statistical Design Method for Anti-Scour Block Work Around Bridge Piers." Quarterly Report of Railway Technical Research Institute, Japan, Vol. 21, No. 4. (1990), pp. 202-210.
- Tsujimoto, T., Murakami, S., Fukushima, T., and Shibuta, R., "Local Scour Around Bridge Piers in Rivers and Its Protection Works." Memoirs of the Faculty of Technology Kanazawa University, Vol. 20, No. 1. (1987), pp. 11-21.
- Turk, G. F. and Melby, J. A., "Core-Loc(TM). A Major Development in Concrete Armor." *The REMR Bulletin*, Vol. 12, 1 (1995), pp. 1-5.

#### 2.3.2d Cable Tied Blocks

Cable tied blocks in the form of a mat (Figure 2.15) represent a class of countermeasures for scour rather than a single countermeasure. The key feature is the interconnecting of smaller units, each of which might be unstable by itself, into a much larger unit, resulting in a framework capable of withstanding much higher unit forces. Here the term is used to include relatively small units as well as the much larger articulated concrete mattresses commonly used by the US Army Corps of Engineers for bank protection.

These systems typically consist of concrete blocks or slabs interconnected with steel, or in some cases non-metallic cables. For this reason the density of the blocks is typically near 2.3 or 2.4, or thus lighter than the value near 2.65 that would be expected for natural riprap. Cable tied blocks, overcome this disadvantage by distributing the forces induced by hydrodynamic loading, including flow turbulence and vortices, throughout the mat. Such a load redistribution may allow for a reduction in the factor of safety typically needed to overcome the effects of violent but transient flow phenomena.

An additional advantage of this type of system is its ability to be placed flat on the bed with minimal protrusion. This reduces the loading due to drag and lift. The blocks can be constructed in units with a pre-attached geotextile. A properly designed unit could thus be mass-produced to minimize cost without compromising performance.

Experience with unit design

Fairly standard designs are available for articulated concrete mattresses in the context of bank protection. Cable tied block units of the type illustrated in Figure 2.15 are produced by several companies, and have been recommended for a variety of applications. McCorquodale (1994) has provided laboratory-based design guidelines in the context of bridge pier protection. Laboratory tests of cable tied blocks for pier scour protection are reported in Bertoldi et al. (1994) and Jones et al. (1995a,b)

Experience with field application

**Bridge piers.** Replies to the questionnaire submitted in conjunction with the First Interim Report of this project indicate that cable tied blocks have been implemented in six instances as countermeasures for bridge scour. Definitive results concerning their long-term performance are not yet available.

**Other.** Various forms of cable tied blocks have been used for many years on other water applications. As noted above the US Army Corps of Engineers has substantial experience with the use of articulated concrete mattresses; which use very large, flat concrete slabs, as a means of bank stabilization. More recently a number of manufacturers have developed cable tied block mattresses using smaller block sizes for such diverse applications as flood control protection works, bluff and bank stabilization, protective covers for outfalls, etc. The blocks can be arranged so as to present a nearly impermeable surface, or to allow gaps to consist of as much as 40 percent of surface area. They have often been installed in ephemeral channels as an alternative to complete concrete lining, which has often engendered public opposition. Their use in other contexts suggest that cable tied blocks have potential for pier scour protection.

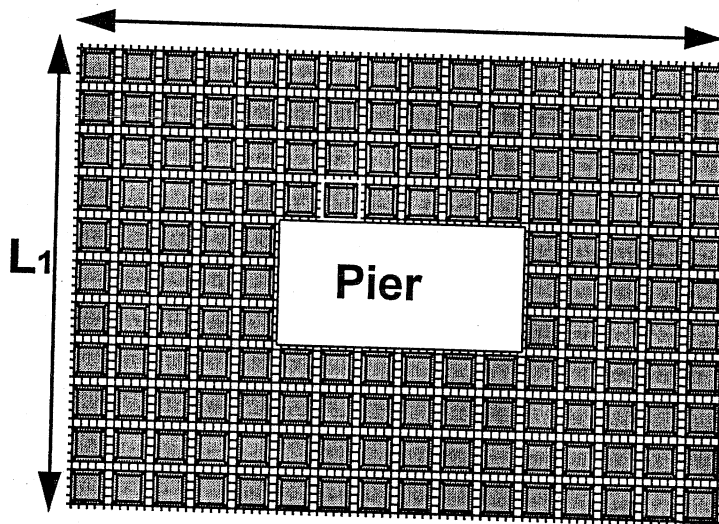


Figure 2.15. Cable tied blocks.



### Notes on

a) **applicability.** The technique is potentially applicable in nearly all locations where standard riprap can be used. It provides an alternative when riprap is unavailable, or when constraints on its delivery prevent its timely use.

b) **design.** Several general unit designs exist for cable tied blocks. These designs have generally been determined by the manufacturer in question. They have typically not been specifically tailored toward pier scour protection. The work of McCorquodale (1994) does, however, provide an important step in this direction. In the context of bridges, issues which remain to be resolved as regards design are sizing of blocks, edge effects, tie-in to the pier, and failure criteria for the entire mat.

c) **construction and maintenance.** Cable tied blocks are presently manufactured commercially, thus confirming their constructability. It is likely possible to modify the method of construction to allow for a design that can be placed easily around bridge piers. Maintenance issues revolve primarily around the durability of the cables; also of importance is the durability of the concrete itself. It may be possible to develop underwater repair methods.

d) **performance evaluation.** The six cases of the use of cable tied blocks reported in the previously discussed survey report may provide a basis for an evaluation of field performance at bridges. More likely an independent field test will be required.

e) **cost.** The cost of standard cable tied blocks is already known. Its present use for applications other than bridges testifies as to its general cost-effectiveness. A more standardized design, as well as specialized installation techniques may be necessary to render them cost-effective as pier scour countermeasures.

### Major research needs

Cable tied blocks constitute a potentially effective countermeasure that has already been tested to determine stability and failure criteria in the context of a variety of applications. Tests used to determine such criteria include the overtopping tests conducted by the US Federal Highway Administration, similar tests by the US Army Corps of Engineers and others. Many of these results should be of use as regards bridge pier protection. Testing specific to river beds and banks and pier protection is, however, required. Some of this has already been done in the laboratory by McCorquodale (1994).

McCorquodale's (1994) test employed "Cable Concrete tm" using laboratory Froude numbers near 0.3. The results are encouraging, and suggest that cable tied blocks are a viable alternative to riprap. Further tests by Bertoldi et al. (1994) and Jones et al. (1995a,b) specifically indicate their viability as a pier scour countermeasure.

The above notwithstanding, the total body of information on the performance of cable tied blocks for piers is still rather small. Issues worth further investigation include block shape, porosity of the mat, failure criteria for the mat and tie-in to round and rectangular piers. In addition, it would be of value to test the method under a wider range of flows, and for coarse-bedded as well as sand-bed conditions.

The issue as regards coarse-bedded streams deserves further amplification. Many countermeasures that work for sand-bed streams, such as standard riprap, can often fail for steep, coarse-bedded mountain streams because either riprap of the required size is unavailable or because the design consistently fails and the material is removed (Miles, 1995). The tying of many heavy units with cables allows for an effective increase in size well beyond each of the units. Some version of cable tied blocks thus may offer an ideal countermeasure for difficult mountain sites.

### Recommended experimental program

The experimental program for cable tied blocks should be designed to expand on the knowledge base available for conventional riprap placement, so as to allow for a comparison of the two. The program should not begin until the anecdotal information from bridge engineers as regards their use has been

evaluated. The central issues of the experimental program should include a) mat size and shape, b) size, shape and porosity of units composing the mat, c) cable configuration, d) failure modes, e) edge effects, f) tie-in to the pier itself and g) the possible use of anchors for added stability.

Experiments are recommended in both the clear-water ("dead-bed") and live-bed configurations, with one set using a sand bed and the other set using a coarse bed for which grain size is not necessarily very small compared to the size of the units within the block mat. The experiments would most wisely be coordinated with others proposed in the following work plans in this report, but specifically including "Standard Riprap" and "Sacked Concrete."

*Task 1:* Build an experimental facility at the largest manageable scale for the purpose of evaluating the performance of cable tied blocks as a scour countermeasure at bridge piers. The experimental facility should allow for testing under both clear-water and mobile-bed conditions. It should allow for both rectangular and round bridge piers, and for both sand-bed and gravel-bed conditions. It should be capable of simulating a wide range of Froude numbers.

*Task 2:* Use the facility to evaluate the effectiveness of cable tied block mats when placed in a manner that replicates the recommended coverage for standard riprap. The matting should be underlain with a suitable geotextile and placed flat on the bed without anchoring. Test runs should be conducted to determine performance and failure criteria, with specific comparison against standard riprap. Special attention should be paid to the treatment of the mat edges and the mat-pier interface.

*Task 3:* Specific studies should be performed on failure of the entire mat due to uplift forces. These studies should include evaluation of the efficacy of the use of two or three layers of matting stacked vertically. The use of anchors for added stability should be explored. The block sizes studied should represent Froude-scaled versions chosen to include the size range presently available from manufacturers. The effect of opening size between the blocks should be studied as well, with the goal of minimizing uplift failure by allowing for the release of pore pressure buildup in the sediment below.

*Task 4:* Perform an assessment of existing and potential manufacturers of cable tied blocks. Present preliminary research results to them for advice in regard to placement. Conduct a series of experiments on placement techniques. One technique to be explored should be spiral placement from the bridge pier or from a barge.

*Task 5:* Amalgamate the above results into a report which contains specific design guidelines based on the experiments, and also recommends an appropriate program of field testing.

#### Recommended field program

It would likely be inappropriate to begin field testing until further work is done with at least one of the manufacturers of cable tied blocks. This work would be directed toward the standardization of design and the development of an effective underwater deployment method. An example of the latter would be the spiral placement of continuous matting from a barge. Once these are complete, two field tests should be conducted. One should be a standard sand-bed installation, and the other should be for a gravel- or cobble-bed mountain stream. The test on the mountain stream would be particularly valuable because cable tied blocks are particularly well suited to a coarse-bedded environment.

In both field tests cable tied blocks should be used at one pier and a standard installation of riprap at an adjacent pier. The cable tied blocks should be pre-installed with a geotextile. The period of field monitoring should be sufficiently long so as to include at least one major flood, and also to allow for an evaluation of long-term durability.

#### Recommended evaluation of cost effectiveness

The cost effectiveness of cable tied blocks is already known for applications other than pier scour countermeasures. The work of McCorquodale(1994) suggests that standardization of design for bridge piers can lower unit costs. Further evaluation of cost-effectiveness should be directed toward determining

this standard design, and in addition to developing relatively inexpensive, reliable means of underwater deployment. Such work is best pursued in cooperation with a manufacturer. Once design and deployment techniques are finalized, the evaluation of cost-effectiveness can proceed with a field test.

#### Estimated cost of experimental program

As part of a larger project: \$90,000

As a stand-alone project: \$155,000

#### References

- Bertoldi, D. A., Jones, J. S., et al., "An Experimental Study of Scour Protection Alternatives at Bridge Piers." Federal Highway Administration, Turner-Fairbank Laboratory, *Report* (1994).
- Jones, J. S., Bertoldi, D. A., et al., "Alternatives Scour Countermeasures." Hydraulic Engineering '95, San Antonio, TX, *Proc.* (1995a), p. 6.
- Jones, J. S., Bertoldi, D. A., et al., "Alternatives to Riprap as a Scour Countermeasure." Fourth TRB Bridge Conference, San Francisco, CA, *Proc.* (1995b).
- McCorquodale, J. A., "Guide for Design and Placement of Cable Concrete Mats." The Manufacturers of Cable Concrete, *Report* (1994).
- Miles, M., "Restoration Difficulties for Fishery Mitigation High-Energy Gravel-Bed Rivers Along Highway Corridors." Gravel-Bed Rivers IV, Gravel-Bed Rivers in the Environment, Gold Bar, Washington, *Proc.* Vol. August 20-26 (1995).

#### 2.3.2e Gabions and Reno Mattresses

The terms "gabion" and "Reno mattress" are used almost interchangeably. Both refer to wire-mesh containers filled with loose rock. Whereas gabions typically refer to containers that, when filled, take the shape of a brick or sausage, Reno mattresses refer to containers with a short vertical dimension.

Steel wire gabions were first manufactured commercially by the Officine Maccaferri in 1884 to repair a breach of the River Reno in Italy. Since then they have gained wide popularity as a means of protection against erosion. They have several advantages compared with other means of erosion protection. Because they are filled with loose rock, they are porous, and thus not as susceptible to uplift forces as more solid countermeasures such as articulated concrete mattresses. Gabions can easily be stacked in very stable configurations. Should the configuration become unstable, the flexibility of the wire mesh allows gabions to mold themselves so as to restore stability. Finally, gabions allow for the use of relatively small stones in a way that yields the protection characteristic of much larger units.

#### Experience with unit design

Due to their extensive use over a long period of time, adequate experience is available concerning the unit design of gabions and Reno mattresses.

#### Experience with field application

**Bridge piers** Gabions have been used in the field for scour protection at bridges. Some 567 instances of their use at bridges are noted in the survey reported in the First Interim Report of this project. Parola (1995, personal communication) reports a rather pessimistic evaluation of field use of gabions at bridges on coarse-bedded streams in New York State. Many of these installations have failed and the New York Department of Transportation no longer allows their use. The results of the above-mentioned survey are, when evaluated as a whole, more positive

**Other** Gabions have been in common use in Europe and are increasing in popularity in the United States. Arising from their wide experience for erosion control purposes, a large body of information exists concerning field application of gabions and Reno mattresses. Examples of

implementation include Lavagnino (1974) and Schuster (1974). Brown (1979) provides some examples of their use in the coastal environment. Brown and Clyde (1989) provide guidelines for the use of both gabions and Reno mattresses as bank protection. US Army Engineer (1983) provides some similar, though simplified, guidelines for the use of gabions as bank protection by landowners and local governments.

Notes on

**a) applicability.** The technique is potentially applicable wherever riprap could be used and can be viewed as an alternative to riprap. It may be particularly applicable where riprap of the size required is difficult and/or expensive to obtain. The use of gabions and mattresses in coarse-bedded streams requires review in light of the experiences of New York State. Corrosion in saltwater environments may limit their use. This limitation may be overcome with the use of a non-ferrous material for the basket wire.

**b) design.** Given their extensive use, quantitative design guidelines for installations of gabions and Reno mattresses around bridge piers are scarce. Perhaps the most substantial attempt to obtain quantitative design guidelines for gabions and mattresses in the fluvial environment is that due to Simons et al. (1984) with the use of scale model testing. Although their experiments do not provide a direct test of the performance of gabions when placed around a bridge pier, they nevertheless provide information concerning a) the resistance to flow offered by gabions, b) the pattern of rock movement within gabions when subjected to a flow sufficient to mobilize the individual stones and c) the performance of filters below gabions.

Simons et al. (1984) were able to obtain some specific design criteria for the use of Reno mattresses. They found that the critical Shields' stress required to displace a rock within the wire cage is over twice the value that would be required to move the same grain were it to be outside the mattress. Even when the mattresses deformed due to high velocities, they found that they were still effective in protecting the bed against erosion as long as the thinnest portion of the mattress is thicker than the median rock size. In order to achieve the same stability from riprap alone, they found that the riprap size would have to be twice as large as those used in the mattresses, and the layer of riprap would have to be thicker than that of the mattresses.

Two other sources of information concerning gabions in the fluvial environment are the US Army Corps of Engineers (1991a) and Maynard (1995). The former document provides a compilation of design criteria for gabions, including wire and basket characteristics. In the latter, Maynard (1995) attempts to provide a unified framework for the analysis of riprap and gabion stability.

**c) construction and maintenance.** Adequate information is available concerning the construction of gabions and Reno mattresses. The Maccaferri Handbook and other information from the company is useful. Gabions and Reno mattresses can be constructed from a wide range of materials, rendering them useful at sites where riprap is difficult to obtain. A disadvantage of gabions compared to conventional riprap relates to placement, particularly in deeper channels where the ability to correctly place the gabions is questionable. For this reason, gabions appear well suited to ephemeral streams. Maintenance requirements depend on durability, with questions over the durability of the wire baskets in corrosive environments.

**d) performance evaluation.** The performance of gabions and Reno mattresses has been thoroughly tested in the field, where they have been used for a number of erosion protection purposes. Few well-documented examples exist of their use at bridge piers. Such a test is needed. The test could be achieved using a pair of piers, one protected with standard riprap (see the work plan "Standard Riprap") and the other protected using gabions and/or Reno mattresses.

**e) cost.** The cost of installing gabions and Reno mattresses at bridge piers can be determined from the similar costs of their installation for other purposes in rivers. By their nature, they are comparatively easy and inexpensive to install. Extra costs of underwater installation near bridges must be considered.

### Major research needs

It seems likely that gabions can play a useful role as regards the protection of bridge piers in at least some environments. Formal testing of them in this context appears, however, to be slight. Two areas of research are needed, as follows:

1) A set of basic experiments on gabion and mattress performance near bridge piers is required. The experiments should cover various gabion sizes and shapes, stacking modes, lateral coverage and the use of filters with gabions and mattresses. They should document the various modes of failure of this type of countermeasure. The experiments should allow for the development of design criteria for gabions to a standard that is at least equivalent to that available today for riprap. In this respect, the approach of Maynard (1995) may be useful. He used the data of Simons et al. (1984) to derive a version of the conventional riprap stability criterion applicable to gabions.

2) Experimental and field tests on gabion placement are required to determine the most effective mode of installation.

### Recommended experimental program

The following experimental program is recommended.

*Task 1:* Undertake laboratory experiments comprising a systematic study of parameters affecting the depth of scour at piers protected by gabions and Reno mattresses. The gabion characteristics investigated should include gabion/mattress size, gabion/mattress shape, gabion/mattress stacking arrangement, lateral coverage and use of filters with gabions. The tests should be conducted for a representative range of flow conditions and bed material characteristics. Rectangular and circular cylindrical piers should be tested.

*Task 2:* Use the new data to develop a design criterion for scour protection at bridge piers using gabions and Reno mattresses. The design criterion should give the required gabion/mattress size, layout, layer thickness, stone size and lateral coverage, for different site conditions.

*Task 3:* Undertake laboratory experiments on methods of gabion placement. Use the test results, together with the results of field testing of placement methods to determine the best method of placing of gabions and Reno mattresses at bridge piers.

*Task 4:* Amalgamate the research results in a report which contains specific design guidelines and also recommends an appropriate field testing program.

### Recommended field program

*Task 1:* Undertake field testing of methods of placement of gabions and Reno mattresses at bridge piers to complement the laboratory testing in Task 3 above.

*Task 2:* Undertake field testing of gabion and Reno mattress protection at bridge piers. Details of an appropriate test site will depend to some extent on the results of the laboratory program, although the chosen site should be representative of the conditions for which this countermeasure is established to be most suitable. The period of monitoring should be long enough so as to include at least one significant flood.

### Recommended evaluation of cost effectiveness

The cost effectiveness of gabions and mattresses will depend on the availability of suitable fill materials, the cost of unit construction and the method and associated cost of installation. The latter is dependent particularly on the depth of water at the bridge site.

The cost effectiveness of this countermeasure may be particularly advantageous at sites where the conventional riprap required is so large that it becomes uneconomic.

Estimated cost of experimental program

As part of a larger project: \$110,000

As a stand-alone project: \$175,000

References

Brown, T.C. "Gabion report on some factors affecting the use of Maccaferri gabions and Reno mattresses for coastal revetments," Manly Vale, NSW, Water Resources Lab., Report No. 156 (1979).

Brown, S.A. and Clyde, E.S. "Design of riprap revetment," Federal Highway Administration, U.S. Department of Transportation, Washington, D.C., Report FHWA-IP-89-016, HEC-11 (1989).

Lavagnino, S., "Gabions Guard River Banks Against 50,000 cfs Flow." *ASCE, Civil Engineering*, Vol. 44, 5 (1974), pp. 88-89.

Maynard, S.T. "Gabion-mattress channel-protection design," *Journal of Hydraulic Engineering*, ASCE, 121(7), (1995) 519-522.

Parola (1995) Personal communication.

Schuster, R. C., "Gabions in Highway Construction." Transportation Research Board, *Report 148* (1974).

Simons, D.B., Chen, Y.H. and Swenson, L.J. "Hydraulic test to develop design criteria for the use of Reno mattresses," Civil Engineering Department, Colorado State University, Fort Collins, Colorado (1984).

U.S. Army Corps of Engineers, "Scour and Deposition in Rivers and Reservoirs." U.S. Army Corps of Engineers, *Report* (1991a).

2.3.2f High Density Riprap

High-density riprap represents a variation on standard-density riprap. It consists of natural stones chosen, or artificial stones constructed, to have a specific gravity substantially higher than the standard value of 2.65.

Standard-density riprap has a specific gravity similar to that of the sediment on the bed of most streams; the necessary weight for stability is achieved by choosing an appropriately large size. Larger stones protrude farther into the flow, and thus feel a larger destabilizing drag, an effect which partially counterbalances the increased weight. Increasing the density of the riprap provides a way to achieve a larger weight while reducing protrusion.

High-density riprap has been tested in the laboratory using cylindrical lead pellets with sizes of 2.3 mm and 6.3 mm (Bertoldi et al., 1994; Jones et al., 1995a,b). The Hibbing Taconite Company, Minnesota, uses iron-rich waste rock from its mining operation to construct dikes and line channels in its tailings basin (e.g. Whipple et al., 1996)

Experience with unit design

Natural high-density riprap requires no unit design. Artificial high-density riprap does not appear to have been fabricated previously, so that no design characteristics are available.

Experience with field application

**Bridge piers.** No examples could be found for the installation of high-density riprap around bridge piers.

**Other.** At least one mining company, the Hibbing Taconite Company of Minnesota has used high-density riprap produced as waste rock from mining operations in order to riprap channels. The information provided concerning its performance is anecdotal but encouraging.

Notes on

- a) **applicability.** The technique is potentially applicable wherever standard riprap can be used. It may be particularly applicable when the size of standard-density riprap is not small compared to the design depth of flow.
- b) **design.** At present virtually no design criteria exist for the use of high-density riprap. It can be surmised, however, that a standardized design procedure similar to that used for standard riprap should not be difficult to achieve. The design criteria would include a standard Isbash-type criterion for sizing a representative size such as  $D_{50}$ , criteria for level and areal extent of placement, a criterion for the lateral extent of placement, and a criterion for filter layer or geotextile placement.
- c) **construction and maintenance.** Natural high-density riprap would require no construction. There are no existing specifications for the construction of artificial high-density riprap. Placement would be similar to that required for standard natural riprap. Maintenance would depend upon the durability of the material.
- d) **performance evaluation.** The performance of high-density riprap has not been tested in the field. Such a field test is needed. The test could be conducted using a pair of piers, one riprapped with standard material and the other riprapped with high-density material.
- e) **cost.** The cost of high-density riprap remains undetermined. Issues that could raise cost include delivery distance in the case of natural material and cost of fabrication for artificial material. This would be at least partially offset by the fact that high-density riprap could be smaller in size than standard riprap, so reducing the total volume installed.

Major research needs

High-density riprap is an intriguing and potentially useful countermeasure that has undergone only very limited testing in the laboratory, and appears not to have been implemented in the field. On the other hand, the literature on riprap and the general sediment transport literature suggest no major surprises in its evaluation as a countermeasure, and in the determination of design criteria. For example, consider the Isbash-type relation for riprap sizing due to Quazi and Peterson (1973);

$$\frac{U_{rc}^2}{g(S_s - 1)gD_r} = 1.14 \left( \frac{D_r}{y_o} \right)^{-0.20}$$

where  $U_{rc}$  denotes the critical velocity for mobilizing the riprap,  $y_o$  denotes flow depth,  $S_s$  is the specific gravity of the riprap,  $D_r$  is its effective diameter, and  $g$  is the acceleration of gravity. The form of the equation suggests that increasing the specific gravity from 2.65 to 5 would be equivalent to using standard riprap that is 3.02 times larger in diameter.

The above conclusion is at least partly justified by the work of Neill (1967), in which the conditions for the initial movement of both standard-density and low-density grains were found to reduce to the same Isbash-type formulation. This conclusion needs to be verified or modified experimentally for high-density grains. The experiments would address the issue of placement area, thickness and level. The design criteria so obtained should then be used in a field installation where performance can be tested at full scale.

Recommended experimental program

The experimental program should be designed to confirm or modify existing Isbash-type formulations for riprap sizing for the case of high-density riprap (see the work plan for "Standard Riprap"). In addition, issues concerning depth, areal extent and level of placement need to be addressed so as to allow for design criteria completely equivalent to those for standard-density riprap. The experimental program should result in design specifications that can be used in a field implementation.

An issue of importance in the experiments concerns placement volume. While the areal extent of high-density riprap around a bridge pier is not likely to differ much from that for standard-density riprap, a placement three grains thick would involve the use of a smaller volume of material. This point needs to be analyzed in detail, as lesser placement volume would help offset the greater cost of the material itself.

In the case of artificial high-density riprap, it may be useful to test not only dense blocks, but dense units in the shape of tetrapods and related units deriving from the coastal environment.

One case that should be included in the experimental program is that for which the size of standard-density riprap required would be a substantial fraction of the depth of flow. This condition is common in relatively steep mountain streams, and is often associated with poor riprap performance. In such a case smaller units of high-density riprap may be much more effective.

With the above comments in mind the following experimental program is recommended.

*Task 1:* Build an experimental facility at the largest manageable scale for the purpose of evaluating the performance of high-density riprap as a scour countermeasure at bridge piers. The experimental facility should allow for testing under both clear-water and mobile-bed conditions. It should allow for both rectangular and round bridge piers.

*Task 2:* Use the facility to evaluate an Isbash-type criterion for riprap sizing for high-density riprap. The specific gravity of the riprap should not be less than 4. If possible both natural and artificial high-density riprap should be tested. The mode of construction and shape of the high-density artificial riprap should be compatible with other countermeasures already in use in the field. Placement of the high-density riprap should be in accordance with design specifications for standard riprap. The results should be verified against tests with standard-density riprap.

*Task 3:* Perform a series of tests to determine whether any modifications of the placement procedure recommended for standard-density riprap enhances the performance of high-density riprap. Evaluate the effectiveness of geotextiles and/or filter layers.

*Task 4:* Perform an assessment of potential sources for natural high-density riprap, and potential fabrication techniques for artificial high-density riprap.

*Task 5:* Amalgamate the above results into a report which contains specific design guidelines based on the experiments, and also recommends an appropriate program of field testing.

#### Recommended field program

The field program cannot be specified in detail until after the completion of the experimental program. This notwithstanding, the following comments are relevant.

The program should be devised to test both natural and artificial high-density riprap. Ideally at least two bridges would be tested, one on a low-slope sand-bed stream and one in a mountain stream capable of moving cobbles or coarser material. In the test, one pier would be riprapped in the standard way, and an adjacent one subject to essentially the same flow conditions would be riprapped with high-density material in accordance with the design specifications determined from the experiments.

The period of field monitoring should be sufficiently long so as to include at least one major flood, and also to allow for an evaluation of long-term durability.

#### Recommended evaluation of cost effectiveness

The cost-effectiveness of both natural and artificial high-density riprap needs to be evaluated. In the case of natural riprap, cost-effectiveness will be largely determined by availability (e.g. from mine-derived waste rock) and distance from source point to point of application.

In the case of artificial riprap the cheapest construction would probably be from molded concrete liberally spiked with some form of pelleted or powdered scrap iron. Many of the issues concerning cost will, then be similar to those associated with tetrapods and other units molded from concrete. The question of relevance is whether or not the added expense of molding the units and adding the iron would be



counterbalanced by the smaller quantity needed for successful installation. An answer to this question is necessary in order to determine feasibility.

The cost-effectiveness of high-density riprap may become particularly advantageous in cases where the standard-density riprap required is so large that it would approach the depth of flow, and thus serve as an obstacle to it. Such cases arise in steep mountain streams.

#### Estimated cost of experimental program

As part of a larger project: \$80,000

As a stand-alone project: \$145,000

#### References

- Bertoldi, D. A., Jones, J. S., et al., "An Experimental Study of Scour Protection Alternatives at Bridge Piers." Federal Highway Administration, Turner-Fairbank Laboratory, *Report* (1994).
- Jones, J. S., Bertoldi, D. A., et al., "Alternatives Scour Countermeasures." Hydraulic Engineering '95, San Antonio, TX, *Proc.* (1995a), p. 6.
- Jones, J. S., Bertoldi, D. A., et al., "Alternatives to Riprap as a Scour Countermeasure." Fourth TRB Bridge Conference, San Francisco, CA, *Proc.* (1995b).
- Neill, C. R., "Mean Velocity Criterion for Scour of Coarse Uniform Bed Material." 12th IAHR Congress, Ft. Collins, CO., *Proc.* Vol. 3 (1967), pp. C6.1 - C6.9.
- Quazi, M. E. and Peterson, A. W., "A Method for Bridge Pier Rip-rap Design." First Canadian Hydraulics Conference, Edmonton, Canada, *Proc.* (1973), pp. 96-106.
- Whipple, K. X., Parker, G., Paola, C. and Mohrig, D., "Dynamic Tailings Basin Study: Final Report." Project Report 378, St. Anthony Falls Laboratory, University of Minnesota (1996), 43 p.

#### 2.3.2g Pavement

At bridge sites in certain regions of the United States, an attempt has been made to prevent or reduce scour around piers and/or abutments by grading the sides and bed of the stream and constructing a reinforced concrete or bituminous concrete pavement, or asphalt overlay, over the surfaces of the channel.

#### Experience with unit design

The field survey reported in the First Interim Report of this project indicated some 253 uses of pavement as a bridge scour countermeasure. No comprehensive evaluation of the performance of pavement sections as scour countermeasures has been made or published. Considerable skepticism, however, has been voiced by bridge designers who doubt the durability of pavements constructed in stream channels and by engineers who anticipate failure of pavements because of uplift stresses generated during flood events.

#### Experience with field applications

The most common field application of pavement as a pier scour countermeasure appears to be ephemeral streams in the Southwest of the United States. In such an environment there is ready access to the stream bed, and the duration of any given flood may be sufficiently short to allow for the pavement to act in a sacrificial role. There may be serious problems associated with the application of the method to other environments. Significant uplift pressure may be generated by groundwater confined under impermeable pavements; groundwater pressures may augment uplift forces generated by turbulence sufficiently that pavement sections are lifted. Transition zones at the ends of paved areas may be sites of incipient failure if flow separations or other conditions undermine the pavement edges.

### Notes on

- a) **applicability.** Pavements can be used to prevent or reduce scour around piers and/or abutments by grading the sides and bed of the streams and constructing a reinforced concrete or bituminous concrete pavement, or asphalt overlay, over the surfaces of the channel. The method would appear to be applicable in ephemeral regions where the pavement can be installed readily between floods. Little is known as to whether or not the method is effective.
- b) **design.** Considerable skepticism has been voiced by bridge designers who doubt the durability of pavements constructed in stream channels and by engineers who anticipate failure of pavements because of uplift stresses generated during flood events. These concerns may be partly alleviated in an arid environment.
- c) **construction and maintenance.** Constructing a pavement in an ephemeral stream channel is relatively easy. No maintenance is intended or required; if the pavement is removed during a flood, it can be replaced. In a perennial stream channel, installation may be more difficult; the possibility of increases in discharge and stage may require the construction of cofferdams or construction only during dry seasons. In addition, significant uplift pressure may be generated by groundwater confined under impermeable pavements; groundwater pressures may augment uplift forces generated by turbulence so that pavement sections are lifted. Transition zones at the ends of paved areas may be sites of incipient failure.
- d) **performance evaluation.** Despite the drawbacks mentioned, pavements have been used in arid regions as scour countermeasures, and the degree of success of such countermeasures merits investigation
- e) **cost.** Little information is available concerning cost. Presumably the method is quite inexpensive to implement on ephemeral streams.

### Major Research Needs

The research needs as regards pavement are such that a focus on a compilation of field experience would appear to be more profitable than experimentation or development of theories explaining behavior of pavements as countermeasures.

### Recommended experimental program

No experimental program is recommended.

### Recommended field program

The objectives of this research are to: 1) develop a database on the use of pavements as scour countermeasures, with a focus on case histories; 2) make an economic comparison of pavements with alternative countermeasures against scour at bridges; and 3) develop guidelines for site characterization relative to the suitability of pavements as scour countermeasures and for design of such pavements. To accomplish these objectives, the following work phases and tasks are proposed.

*Task 1:* Review relevant experience, emphasizing case histories and field applications of pavements as scour countermeasures at bridges, as depicted in published literature and as recorded in highway agency documents. Information should be sought principally by preliminary telephone interviews and written questionnaires, followed by personal interviews and site visits. Primary information sources should be highway agency engineers and design consultants. The main objective of the review should be identification of sites where pavements have been used as scour countermeasures and where information on flow around bridge piers and abutments is extensive or conclusive data can be obtained by retrospective analysis.

*Task 2:* Analyze the Task 1 data to evaluate the state of practice in the use of pavements as scour countermeasures at bridges. Identify sites where extensive data have been obtained or where such data could be developed. Develop a list of sites for comprehensive documentation, if a sufficient

number of such sites exist. If it is not possible to develop a comprehensive database, prepare a summary of the available information and recommend that no further work be done under this project.

*Task 3:* Submit an interim report and revised work plan within six months. The interim report will document results of Tasks 1 and 2 and include information on where, when and how pavements have been used as scour countermeasures at bridges. The interim report also will identify, if possible, sites where sufficient data are available or could be obtained that comprehensive case histories could be written and analyses could be done. A prioritized short list of sites will be submitted, if feasible, for future site visitations by the project research team.

*Task 4:* Develop detailed case histories of ten to fifteen bridge sites where pavements have been used for a significant length of time as scour countermeasures. Equal attention should be given, if possible, to sites where pavements have failed and to sites where they have succeeded as scour prevention/mitigation measures.

*Task 5:* Prepare an economic comparison of pavements and alternative scour countermeasures, on the basis of all of the information collected during completion of Tasks 1 and 2. Data on sites in addition to the information developed in the process of compiling comprehensive case histories should be included in developing this analysis.

*Task 6:* Prepare design criteria to identify situations in which pavements are likely to be feasible and cost-effective as scour countermeasures, and to guide design, specification and construction of such pavements. Develop procedures for economic analysis of alternative countermeasures, based on typical costs developed during the course of Task 5.

*Task 7:* Submit a final report that summarizes research results in the form of design guidelines that provide a method for designers to evaluate the suitability of pavements as scour countermeasures at specific bridge sites and to design, specify and supervise construction of such countermeasures.

#### Recommended evaluation of cost effectiveness

Comprehensive case histories on the use of pavements as scour countermeasures at bridges will provide needed insights into the advantages and disadvantages of that practice, and indicate those conditions under which such countermeasures are not feasible or cost-effective. Provision of design guidelines will make continued use of this countermeasure more systematic, rational and effective by preventing application of this technique at sites where it is not suitable, and by standardizing design rules, specifications and construction practice.

#### Estimated cost of program

**Funding Recommended:** \$250,000.

**Research Period:** 36 months

### 2.3.2h Rock Bolting

Many bridge sites are underlain at shallow depth by layers of intact rock. Rock masses consisting of hard, intact pieces separated by widely spaced tight joints are very resistant to scour forces. As joint spacing decreases and joint opening increases, however, rock masses become more vulnerable to plucking and dislodgment of intact pieces of rock by turbulent flow conditions at bridge piers and abutments. If joints are very closely spaced and wide, pieces of bedrock will be dislodged in much the same manner as will pieces of riprap. Considerable potential exists, nevertheless, to prevent or mitigate scour at bridges founded on rock by simply holding durable and intact pieces of rock in place with rock bolts. If rock bolts can be used in conjunction with wire mesh and concrete surface treatment to protect masses of intact rock pieces from plucking and dislodgment, much expensive excavation in rock can be avoided and bridge

foundation construction will be much more cost-effective. Economic analyses and field trials of rock bolting as a scour countermeasure for bridges founded on rock are warranted.

Experience with unit design

This countermeasure is a new concept, and therefore previous applications cannot be studied.

Experiences with field applications

None available.

Notes on

- a) **applicability.** Considerable potential exists to prevent or mitigate scour at bridges founded on rock by simply holding durable and intact pieces of rock in place with rock bolts.
- b) **design.** Design criteria for use of rock bolts and various surface treatments are available for a variety of geotechnical problems. Criteria for their use as scour countermeasures in rock need to be developed.
- c) **construction and maintenance.** Rather than use rock blasting or other expensive excavation techniques to remove rock to the predicted scour depths, rock masses at bridge sites can be characterized and identified to determine the suitability of rock bolting. Rock bolt type, spacing, length and diameter for site conditions can then be selected. The most effective surface treatment to accompany the selected rock bolt system can be selected.
- d) **performance evaluation.** An economic analysis of rock bolting systems in place needs to be developed and compared to alternative methods for scour mitigation at bridge piers.
- e) **cost.** Rock bolting should prove to be a most cost-effective countermeasure, especially relative to rock blasting.

Major research needs

This research is intended to supplement studies recommended under NCHRP Project 24-8, on the basic mechanisms by which masses of intact pieces of durable rocks are lifted, dislodged and displaced by turbulent flow systems at bridge piers and abutments.

Recommended experimental program

No experimental program is recommended for rock bolting.

Recommended field program

The objectives of this research are: 1) to review any experience gained in the use of rock bolting and surface treatment of rock masses as scour countermeasures; 2) to conduct field trials of rock bolting/surface treatment at selected bridge sites; and 3) to develop an economic analysis of rock bolting compared to alternative means to protect against or mitigate scour in rock at bridge foundations. To accomplish these objectives, the following work phases and tasks are envisioned.

*Task 1:* Review relevant literature, emphasizing case histories and field studies of scour at bridges founded on rock, to identify any prior use of rock bolting as a scour countermeasure. Cases involving bridges founded on non-durable rock types that slake should be excluded from analysis. Literature dealing with scour protection of spillways constructed in rock should be included in the review. The review should focus on cases where flow conditions around bridge piers and abutments, or in spillways and channels, have been documented well. The literature review should be supplemented with a telephone survey of highway agencies and design consultants to query practitioners for relevant experience with rock bolts and/or surface treatments of rock masses for scour protection. Research personnel at the Corps of Engineers, the Tennessee Valley Authority and the Bureau of Reclamation should be visited to obtain assistance in summarizing

relevant experience with rock bolts/surface treatment as scour protection in rock spillways and channels.

*Task 2:* Analyze any data retrieved in Task 1 to evaluate experience gained with rock bolts and surface treatments as scour countermeasures. If sufficient data are obtained about the use and performance of rock bolts in scour protection schemes, an economic analysis should be done to compare the costs of protecting a rock mass by rock bolts and surface treatment, with the costs of other alternative measures such as excavation of rock to depths predicted by scour equations developed for use with soils. Summarize all relevant experience with rock bolts and surface treatments used as scour countermeasures in rock spillways and channels, as well as at bridge sites.

*Task 3:* Submit an interim report and revised work plan within six months. The interim report will document results of Tasks 1 and 2 and include information on the apparent effects, on the success of rock bolting for scour prevention, of geologic factors such as rock joint spacing, joint width and alteration of rock along joints. Experience should be categorized by rock type, geologic structure and degree of rock weathering at the bridge site; investigators also should look for geographic trends in experience, since rock behavior is dependent to some degree on regional climatic and cultural factors.

*Task 4:* Conduct a field study of rock bolting and surface treatment for scour protection of a mass of rock where flow from a dam spillway or other channel could be diverted onto the rock mass, and model bridge piers and abutments could be constructed on the rock mass. Water pressures and velocities above rock blocks and pressures in discontinuities should be measured to allow assessment of turbulent flow fields and uplift forces. The test arrangement should simulate the conditions of flow around piers and abutments. To evaluate the effects of joint width and spacing, parts of the rock mass should be altered to produce more frequent and/or wider joints. Various densities and lengths of rock bolts should be tested, and the surface of the rock mass should be covered with various combinations of wire mesh, wire mats and concrete (of various thicknesses).

*Task 5:* Develop design criteria for the use of rock bolts and various surface treatments as scour countermeasures in rock.

*Task 6:* Submit a final report that summarizes research results in the form of design guidelines that provide a method for designers to 1) identify durable rock types; 2) characterize rock masses at bridge sites; 3) select rock bolt type, spacing, length and diameter for the conditions at a site; and 4) design the most cost-effective surface treatment (e.g., wire mesh and concrete) to accompany the selected rock bolt system.

#### Recommended evaluation of cost effectiveness

Because foundation designers cannot be certain that durable rock masses will not be pulled apart by turbulent flow fields at bridge piers and abutments, such rock masses are characterized as erodible and scour prediction equations developed for use in soils are used to predict scour in the rock. Rock blasting or other expensive excavation techniques are used to remove rock to the predicted scour depths. Such design and construction is overly conservative and unnecessarily costly if the intact pieces of rock can be kept in place by rock bolts and surface retention systems such as wire mesh and concrete anchored to rock bolts. Bridge foundation construction costs may be lowered drastically for bridges founded on masses of durable rock if reliable design methods can be developed to identify situations in which rock bolts can be used effectively and to guide selection and specification of rock bolt/surface treatment systems.

#### Estimated cost of program

**Funding Recommended:** \$350,000.

**Research Period:** 36 months

### 2.3.2i Sacked Concrete

Concrete-filled bags are fabric shells that are filled with concrete (Figure 2.16). They thus represent a kind of artificial riprap. One version, the grout filled mat is a single, continuous layer of fabric with pockets, or cells that can be filled with concrete. Grout filled bags are smaller units that can be stacked in a manner reminiscent of riprap. Sacked concrete can be rapidly deployed, especially in smaller streams. As an alternative to riprap, it can be cost-effective where riprap is not readily available, procurement is delayed or where environmental restrictions prohibit the use of riprap.

An advantage of sacked concrete is that sacks of dry concrete can be placed directly in the riverine environment. The bags will then be hydrated naturally and rapidly.

#### Experience with unit design

The main body of literature on which to base the design of sacked concrete for bridge pier protection is contained in Fotherby (1992, 1993), Bertoldi et al. (1994) and Jones et al. (1995). Important aspects of unit design are as follows: bag size, the use of a geotextile, lateral extent, sealing against the pier, connection, stacking and the use of anchors to protect the leading edge against uplift forces. The design criteria for grout filled mattresses, which constitute a single unit for each bridge, differ somewhat from those for sacked concrete, which is more comparable to standard riprap.

#### Experience with field application

**Bridge piers.** A survey conducted for the present project and reported in the First Interim Report identified 97 applications of grout filled bags and 51 applications of grout filled mattresses for the case of bridge piers. The results appear to be generally successful, especially in the case of grout filled bags. They appear to be relatively cost-effective among alternatives to riprap, but rate low in terms of aesthetics.

**Other.** The U.S. Army Corps of Engineers, for example, has used grout filled bags for bank protection in rivers.

#### Notes on

- a) **applicability.** The technique is potentially applicable wherever conventional riprap can be used. Its use may be limited in a salt-water environment such as an estuary, due to possible loss of integrity of the concrete. Applicability is increased in areas where the use of riprap is prohibited, or where it is not available.
- b) **design.** The major sources of information for the design of countermeasures using sacked concrete are Fotherby (1992, 1993), Bertoldi et al. (1994) and Jones et al. (1995). In the case of grout filled bags, a partial design procedure similar to that for riprap is already available. There are more unknowns in the design of grout filled mattresses.
- c) **construction and maintenance.** Procedures for the construction and placement of sacked concrete are already available. The familiarity with the use of concrete in the context of bridges does not suggest major maintenance problems. The bags used to contain the concrete need not be overly durable; the technique can work as long as they maintain their integrity until sufficient hydration has taken place. In the case of the mat, failure likely involves replacement of the entire unit. In the case of grout filled bags, it may be possible to accomplish maintenance by replacing or reorienting only a few bags.
- d) **performance evaluation.** Results of the survey of bridge engineers reported in the First Interim Report indicate numerous cases where both grout filled bags and grout filled mattresses appear to have performed well.
- e) **cost.** While the total cost for an installation using grout filled bags or mattresses is likely to be higher than that for standard riprap, they appear to be one of the most cost-effective alternatives to riprap.

### Major research needs

A fairly complete set of information on which to base design already exists for the case of grout filled bags. Further research on the relative performance of various methods of stacking and various areal extents of placement, however, would be useful. It may prove, for example, that an imbricated, or shingled placement may be more resistant to scour than standard stacking, as illustrated below. Middleton and Southard (1984), for example, make the following observation as regards natural gravel: "...a tightly-packed bed of well imbricated flat grains should be very difficult to dislodge." A similar scheme is suggested in the work plan "Cable tied Blocks."

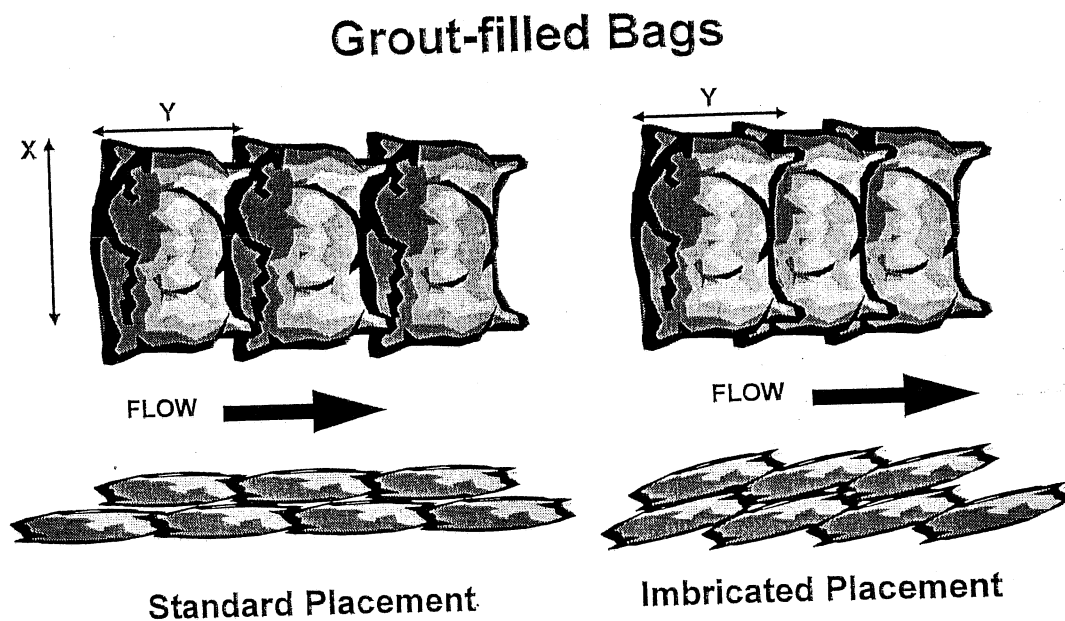


Figure 2.16. Grout filled bags.

One way to improve the performance of sacked concrete is to increase the effective weight of the concrete by spiking it with e.g. fragments of waste steel. The reader is referenced to the work plan, "High Density Riprap."

In the case of concrete mattresses the most important issues requiring further research concern failure modes, the role of sealing between the mattress and the pier and the use of anchors to protect the leading edge against lift. The reader is referred to the work plan, "Anchors."

In both cases further information is required concerning mechanical degradation due to repeated freezing and thawing, and chemical degradation in a saline environment.

### Recommended experimental program

The experimental program for grout filled bags should have as its goal the development of a standard Isbash-type formulation for sizing and performance that should be on a par to that available for standard riprap. Emphasis should be placed on the method of placement; as indicated in the above figure, a different placement of the same sacks may offer a significantly improved resistance to flow forces. In the case of concrete mattresses, the units within the mattress themselves may be imbricated for a more streamlined shape and better resistance to scour. The major goal of the experimental program for grout filled mattresses is a generalized failure criterion based on lift and rollup of the leading edge as a function of the lateral extent and thickness of the mattress, method of placement, and the use of anchors.

With the above comments in mind the following experimental program is recommended.

*Task 1:* Build an experimental facility at the largest manageable scale for the purpose of evaluating the performance of sacked concrete as scour countermeasures at bridge piers. The experimental facility should allow for testing under both clear-water and mobile-bed conditions. It should allow for both rectangular and round bridge piers. The latter feature is particularly important for the case of grout filled mattresses, where sealing with the pier itself must be a topic of investigation.

*Task 2:* Use the facility to verify and complete the development of an Isbash-type criterion for sizing of grout filled bags. Extend the tests to determine optimal areal extent and thickness of placement. Perform tests to determine whether an imbricated placement offers increased resistance to scour. The experimental results should be expressed in a form that allows direct comparison with standard riprap.

*Task 3:* Use the facility to study the performance of grout filled mattresses. The tests should allow for variation of a) areal extent of the mattress, b) mattress thickness, c) shape of the units within the mattress, and d) the degree of sealing with the pier. Experiments should be performed using both round and rectangular piers. A lift-based failure criterion should be delineated that allows for mattress sizing. The use of anchors to alleviate lift failure should be studied.

*Task 4:* Imbed the above results in a report which contains specific design guidelines based on the experiments, and also recommends an appropriate program of field testing.

#### Recommended field program

A field program may not be necessary for sacked concrete. It may be more relevant to perform a detailed review of the numerous sites at which countermeasures of this general type have already been implemented.

An independent field verification may be warranted. In such a test, it would be advisable to choose a sand-bed stream. The protection of three adjacent piers subjected to similar approach conditions, one with grout filled bags, one with a grout filled mattress and one with standard riprap, would be useful.

#### Recommended evaluation of cost effectiveness

The evaluation of cost-effectiveness for sacked concrete should be relatively straightforward, especially in the case of grout filled bags. The cost of both the bags and the concrete is easily estimated. Experience is already available concerning placement costs. The effectiveness of the measure remains to be determined completely, but results similar to riprap can already be expected.

#### Estimated cost of experimental program

As part of a larger project: \$90,000

As a stand-alone project: \$155,000

#### References

- Bertoldi, D. A., Jones, J. S., et al., "An Experimental Study of Scour Protection Alternatives at Bridge Piers." Federal Highway Administration, Turner-Fairbank Laboratory, *Report* (1994).
- Jones, J. S., Bertoldi, D. A., et al., "Alternatives Scour Countermeasures." Hydraulic Engineering '95, San Antonio, TX, *Proc.* (1995a), p. 6.
- Jones, J. S., Bertoldi, D. A., et al., "Alternatives to Riprap as a Scour Countermeasure." Fourth TRB Bridge Conference, San Francisco, CA, *Proc.* (1995b).
- Middleton, G. V. and Southard, J. B., "Mechanics of Sediment Movement." *Notes, SEPM Short Course Number 3* (1984), 401 p.



### 2.3.3 Flow Altering Countermeasures

Work plans for each of the flow altering countermeasures selected for further research and testing are listed below in alphabetical order.

#### 2.3.3a Collars and Horizontal Plates

A collar normally consists of a thin horizontal plate or disc placed around a bridge pier. The thickness of the plate is small so as not to interfere with the incoming flow. The principle behind the use of a collar as a means of bridge pier protection is that it is capable of shielding the sediment particles from erosion by the downflow and horseshoe vortex, thereby suppressing scour.

The efficiency of the collar or plate to arrest pier scour is dependent primarily on its size and location. Clearly a very large collar can eradicate scouring altogether, but it is not practical and may even create other sediment related problems at the edge of the plate and the loose bed. The collar can be located below, above or just at the undisturbed bed level, and the location can affect the amount of scour reduction achieved.

The use of this device as a pier scour countermeasure was suggested more than forty years ago by Schneible (1951) and Chabert and Engeldinger (1956). It was some time later that Thomas (1967) and Tanaka and Yano (1967) presented experimental data to verify the efficiency of this method. More recently Chiew (1992) summarized these data, together with additional data from Ettema (1980) and his own, to determine the effect of the size and location of the collar on its performance. Fotherby (1992) replotted the same data using different dimensionless variables.

#### Experience with unit design

It is not certain how successful this device might be if used as a pier scour countermeasure in the field. The method involves the installation of a horizontal thin plate around the pier body.

#### Experience with field application

**Bridge piers.** No example is known to the writers of the installation of a thin collar around a pier structure as a means of scour protection in the field.

**Other.** The footing that is attached to the bottom of a bridge pier provides a type of protection that is similar to that offered by a collar. The main difference is that the former has a thick projected area whereas the thickness of the latter is minimal. It appears that the efficiency of a footing decreases in live-bed conditions where bedforms are present in the river. The performance of a collar under live-bed conditions is undetermined.

#### Notes on

- a) **applicability.** The technique is potentially applicable; the limited experimental data to date have shown that it can reduce maximum clear-water scour depth substantially.
- b) **design.** At present virtually no design criteria exist for the use of a collar or horizontal plate. It can be surmised, however, that a standardized design procedure outlining its efficiency as a function of the location and size of the collar should not be difficult to achieve. The design criteria could be presented graphically in the form of the amount of scour depth reduction as a function of both the collar size and collar location.
- c) **construction and maintenance.** No specialized construction technique is envisaged in the use of this device as a pier scour countermeasure. As the collar is not designed to take any structural loading, its inclusion merely results in the formation of a composite pier with a different shape. However, the collar may have the potential of trapping debris, which could in turn induce maintenance costs.

**d) performance evaluation.** The performance of a collar or a horizontal plate does not appear to have been tested in the field. Such a field test is needed. The test could be conducted using a pair of piers, one with and one without the collar attachment.

**e) cost.** The cost of using a collar or a horizontal plate as a pier scour countermeasure is expected to be low. No special expertise in its design and construction procedure is needed.

#### Major research needs

A thin collar or horizontal plate is an interesting and potentially workable pier scour countermeasure that has undergone some testing, and appears to be able to arrest scour in the laboratory. The existing data base is not extensive, with most research confined to tests conducted under clear-water conditions with a cylindrical model pier. The choice of appropriate dimensionless variables to account for the performance of a collar or horizontal plate in reducing the depth of scour needs to be re-examined. This is important, as the efficiency of the technique is very sensitive to the location of the collar.

Additional data in the laboratory under both clear-water and live-bed conditions would likely enhance the workability of the technique. Testing the device using a non-cylindrical pier would also help to provide a more comprehensive data base for the development of a design chart.

Testing under varied flood conditions with varied approach depth and velocity is needed. This is because a collar that performs well under conditions that might be met at one point on a hydrograph may perform inadequately at another point on a hydrograph. It is important to realize that the position of the collar is fixed, and cannot be varied during a flood for optimal performance. A collar that is too high above the bed or that has a diameter that is too small may amplify scour.

#### Recommended experimental program

The experimental program should be designed in the first instance to confirm existing data. The effect of the collar size, pier size, approach flow depth and location of the collar relative to the undisturbed bed level on the performance of the device should be examined systematically. The experimental tests should aim to develop design specifications that can be used in a field implementation.

An important aspect of the experiment should be to examine the potential of combining the present device with other scour countermeasures. For example, Chiew (1992) has found that combining the slot-in-pier technique with a collar, the clear-water scour depth can be eradicated altogether. This result is promising and additional tests should be conducted to confirm the result. The reader is referred to the work plans "Standard Riprap" and "Slot in Pier."

With the above comments in mind the following experimental program is recommended.

*Task 1:* Build an experimental facility at a manageable scale for the purpose of evaluating the performance of a thin collar or horizontal plate as a scour countermeasure at bridge piers. The experimental facility should allow for testing under both clear-water and mobile-bed conditions. It should allow for both rectangular and cylindrical bridge piers.

*Task 2:* Use the facility to test the effect of the size and location of the collar on its performance in reducing pier scour. The flow condition, including undisturbed flow velocity and approach flow depth should also be varied. Hydrograph flows should be included so as to determine performance as a function of position on the hydrograph.

*Task 3:* Perform a series of tests to determine the effect of including other pier scour countermeasures, e.g. a slot in the pier which might enhance the performance of the collar in further reducing the depth of scour under various flow conditions.

*Task 4:* Amalgamate the above results into a report which contains specific design guidelines based on the experiments, and also recommends an appropriate program of field testing.

### Recommended field program

The field program cannot be specified in detail until after the completion of the experimental program. This notwithstanding, the following comments are relevant should the field study prove desirable.

The program should be designed to test some of the promising collar configurations and/or combinations of other pier scour countermeasures with a collar for testing in the field. At a minimum, two piers are needed for the field program. In the test, an appropriately sized collar would be attached at a pre-selected location on one of the piers, whereas the other would be left in its original condition. If possible, an additional test could be repeated at another bridge site located in a different river regime.

The period of field monitoring should be sufficiently long so as to include at least one major flood, and also to allow for an evaluation of long-term effect on the device.

### Recommended evaluation of cost effectiveness

The design of a collar or a horizontal plate is not a sophisticated problem, and therefore should not be costly. Furthermore, no additional cost due to any special constructed technique is envisaged for its inclusion as part of the construction of a bridge pier. Retrofitting as well should not be overly expensive. If trapping of debris becomes a serious problem, regular maintenance may be necessary, and this may impose an additional cost to any implementation of the method. The effectiveness of the method in the field remains to be seen, and requires a field test.

### Estimated cost of experimental program

As part of a larger project: \$135,000

As a stand-alone project: \$200,000

### References

- Chiew, Y. M. "Scour protection at bridge piers". J. Hyd. Engrg., ASCE, 118(9), (1992) 1260-1269.
- Ettema, R. "Scour at bridge piers". Report No. 216, School of Engineering, Univ. Of Auckland, Auckland, New Zealand (1980).
- Fotherby, L. M. "Footings, mats, grout bags, and tetrapods protection methods against local scour at bridge piers". M. S. thesis, Colorado State University, Fort Collins, Colorado (1992).
- Schneible, D. E. "An investigation of the effect of bridge-pier shape on the relative depth of scour". M. S. Thesis, University of Iowa, Iowa City, Iowa (1951).
- Tanaka, S., and Yano, M. "Local scour around a circular cylinder". Proc. 12th IAHR Congress, IAHR, vol. 3, (1967) 193-201.
- Thomas, Z. "An interesting hydraulic effect occurring at local scour". Proc. 12th IAHR Congress, IAHR, vol. 3, (1967) 125-134.

### 2.3.3b Flow-deflecting Vanes or Plates

At least four types of flow-deflecting vanes or plates have been proposed as countermeasures for pier scour. These can be enumerated as follows.

1. Iowa vanes (Odgaard and Wang, 1987).
2. Vertical plates (Mahavadi et al., 1996).
3. Delta wings (Gupta and Gangadharaiah, 1992)
4. Pier-installed vanes (Daido and Yano, 1995)

The goal of all these countermeasures is the alteration of the flow field so as to suppress or alter the horseshoe vortex responsible for local scour. Each of the above techniques has been tested in the laboratory, but the research team is aware of little field testing at actual bridges.

Iowa vanes are plates installed in the bed of a stream. In their original incarnation, they were designed to break up secondary flow, and thus mitigate the tendency for lateral migration of banks in rivers. They have proved to be quite effective in this regard. A single set of tests by Odgaard and Wang (1987), in which they were installed immediately upstream of a bridge pier, suggested that they could mitigate bridge scour somewhat. More success was achieved when combined with a vertical collar or plate. The vertical plates of Mahavadi et al. (1996) are placed in the bed of the stream just upstream of the pier and angled outward. They appear to reduce scour by as much as 50 percent, and may also reduce the amount of riprap required. The delta wing of Gupta and Gangadharaiah (1992) is placed horizontally upstream of the pier, with the pointed edge directed upstream. The reduction in scour reported by the authors is somewhat greater than that reported for Iowa vanes, and similar to that reported for vertical plates. The pier-installed vanes of Daido and Yano (1995) curve around the pier with an upward angle of inclination of 45°. They originate from a vertical splitter wall placed at the center of the upstream face of the pier. In some cases it appeared that scour could be completely eliminated by this technique.

#### Experience with unit design

The research team could find no evidence of any field installation of vanes or plates, much less a unit design.

#### Experience with field application

**Bridge piers.** None.

**Other.** There is a large body of field experience with Iowa vanes. An older type of vane on which Iowa vanes are based has a long tradition of use in sediment ejectors at the headworks of irrigation canals. Plates of various designs have a time-honored usage in hydraulic engineering as a means of vortex suppression near intakes for e.g. pumps and turbines. Their performance tends to be sensitive to variations in depth, however.

#### Notes on

**a) applicability.** The lack of field testing or even laboratory testing at near-field scale, leaves most questions concerning applicability unanswered. Possible drawbacks are as follows. The various methods may be inappropriate for bridges on streams subject to large loads of debris. They may also lose their effectiveness if stream alignment relative to the bridge changes. Finally, they may function well at one depth but prove inadequate at another depth.

**b) design.** There is no design procedure for the installation of vanes or plates on bridges. The existing design procedure for Iowa vanes near eroding river banks suggests that such a procedure is feasible.

**c) construction and maintenance.** Experience with Iowa vanes suggests that the vanes or plates could be constructed and installed relatively inexpensively were they to prove effective against scour, and were a standard design procedure available.

**d) performance evaluation.** No field test of any of the techniques discussed above has been conducted in the context of bridge piers. Such a field test is needed. Before doing this, however, the techniques need to be evaluated, winnowed and refined as much as possible in the laboratory.

**e) cost.** A standardized design need not be overly costly. Whether the cost could be reduced below that of standard riprap is highly questionable. This notwithstanding, there may be a niche for vanes and plates as scour countermeasures.

### Major research needs

The vanes and plates discussed above have been subjected to only limited laboratory testing as countermeasures for scour at bridge piers. When expressed in terms of the maximum reduction in scour attained, the results of these tests seem encouraging. Far more important than the maximum reduction in scour attainable, however, is the typical reduction that might be expected under conditions approaching those prevalent in the field. These conditions include greatly varying depth, an approach flow that can vary strongly both in space and time, and the possibility of significant debris attaching to the vane(s) or plate(s).

The most important research need at present is a set of comprehensive baseline data on the performance of vanes and plates under controlled laboratory conditions that nevertheless mimic many of the conditions likely to be encountered in the field. The experiments should be conducted in parallel with studies of riprap in order to evaluate the effectiveness of various types of vanes and plates relative to not just each other, but to more traditional types of pier scour countermeasures. Emphasis should be placed on configurations that could be easily standardized and installed in the field.

### Recommended experimental program

The delta wing, in that it is placed at a fixed location horizontal to the bed, is likely to have a narrow range depth at which it is effective. Accordingly it should not be assigned a high research priority. Both Iowa vanes and vertical plates can have significant buried portions at low flow, allowing them to be effective at high flow as well. By the same token, pier-attached vanes can extend well below the bed at low flow, allowing them to function upon exposure at high flow as well.

The experimental program for vanes and plates should be designed to answer the following questions.

1. What design (e.g. size) and configuration provide the highest degree of scour protection over the widest possible range of flood conditions? Is the degree attainable acceptable for use as a scour countermeasure? How does it compare with riprap?
2. Are there conditions under which the vane(s) or plate(s) could be expected to fail by e.g. undermining, and are these less or more stringent than the conditions for riprap failure?
3. How rapidly does a given countermeasure lose efficacy as the angle of attack deteriorates?
4. How does the countermeasure perform after it has collected a significant amount of debris?

If the answers to the above questions are encouraging for any given implementation, a second set of experiments should be conducted with the aim of delineating the simplest design possible, as well as the design that would appear easiest to install in the field. A simple design will likely be necessary for the mass production that would make unit costs acceptable.

The following specific experimental program is suggested.

*Task 1:* Build an experimental facility for the purpose of evaluating the performance of vanes and plates as scour countermeasures at bridge piers. The experimental facility should allow for testing at two scales. Small-scale experiments should be conducted for the purpose of optimizing vortex and scour suppression. Large-scale experiments should then be conducted to allow for testing at near-field conditions, including both clear-water and mobile-bed states. The facility should allow for both rectangular and round bridge piers.

*Task 2:* Use the small-scale facility to refine the design and placement of the vanes and plates. The facility should be used so as to perform a large number of experiments of relatively short duration.

*Task 3:* Use the large-scale facility to study the performance of each design selected under Task 2 at near-field conditions. The tests should include evaluations of countermeasure performance under both clear-water and mobile-bed conditions. They should include studies of the effect of

angle of attack and debris, and failure criteria (if applicable) for the vanes. A comparison should be made with standard riprap. If warranted, some combination of vane(s) or plate(s) and riprap might be tested in order to evaluate the potential for reducing riprap requirements. The reader is referred to the work plan, "Standard Riprap."

*Task 4:* Develop a first cut at a standardized design for any of the implementations judged effective at the end of Task 3. Conduct further large-scale tests to verify or modify the standard design. Consult with bridge engineers with field experience to maximize the applicability of the design.

#### Recommended field program

The existing experimental information on vanes and plates as pier scour countermeasures is so scanty that it is impossible to say whether or not a field test is merited at this point. Should any of the types mentioned above survive the experimental program, however, a field test is warranted. The field test should be carried out on a sand-bed stream, as gravel or cobbles striking the plates or vanes could damage them. If possible it should be carried out in parallel with a test of standard riprap at an adjacent pier subject to similar approach conditions. The potentially adverse effect of debris on the plates or vanes would require evaluation.

#### Recommended evaluation of cost effectiveness

Should any of the variations of vanes and plates survive the experimental program, an evaluation of cost-effectiveness should be made in combination with the field test. In this case there are three elements to cost-effectiveness: a) ease of manufacture, b) ease of installation and c) performance in the field over the long term. The first of these should be evaluated in conjunction with a suitable manufacturer. The second can be evaluated at the time of installation of the unit for field test. The third element can be evaluated as part of the field test itself.

#### Estimated cost of experimental program

As part of a larger project: \$165,000

As a stand-alone project: \$230,000

#### References

"Wall and Slanting Plate and Piers Surface." 6th International Symposium on River Sedimentation, *Proc.* (1995).

Gupta, A. K. and Gangadharaiyah, T., "Local Scour Reduction by a Delta-Wing-Like Passive Device." VIII APD-IAHR Congress, Pune, India, *Proc.* (1992), pp. B471-B481.

Mahavadi, S. K., C., P. A. et al., "Pier Plates and Control of Local Scour." *Journal of Hydraulic Engineering, ASCE*, Vol. To be published, (1996).

Odgaard, A. J. and Wang, Y., "Scour Prevention at Bridge Piers." *Proceedings Hydraulic Engineering*, (1987), pp. 523-527.

#### 2.3.3c Permeable Sheet Piles

The concept of a permeable sheet pile is a new one developed through the discussion of other countermeasures for bridge scour. The idea is based on a) permeable dikes as river training devices and b) snow fences for the protection of roadways against blown snow. In the former case sediment-laden water is allowed to pass through a lattice that slows the flow down significantly, thus causing the sediment to settle out. In the latter case snow-laden air is encouraged to drop its load before it reaches a road. Both have proved most effective in engineering practice

The porous sheet pile would be set upstream of a bridge pier. It would be placed sufficiently low to prevent interference with the bulk of the approach flow. Instead it would act to deflect some of the near-

bed flow away from the bridge pier, and slow the approach velocity of the remaining near-bed flow sufficiently to weaken the horseshoe vortex near the bed and encourage a shift toward a less erosive environment.

The concept is related to impermeable sheet piles, versions of which have been tested in the laboratory as countermeasures for bridge scour by Levi and Luna (1961) and Maza (1967). It is hoped that porosity would increase the efficacy of the countermeasure by encouraging the deposition of sediment in a zone that would otherwise scour.

#### Experience with unit design

Porous sheet piles do not seem to have been tested either in the laboratory or field as countermeasures to pier scour. Permeable dikes have been used extensively in rivers, and design guidelines are available (e.g. Beckstead, 1975). The accumulated experience with snow fences is likewise extensive. (e.g. Kind, 1981).

#### Experience with field application

**Bridge piers.** No examples could be found for the installation of porous sheet piles upstream of bridge piers as countermeasures against scour.

**Other.** As noted above the field experience with permeable dikes in rivers and snow fences is extensive. They have proven effective in encouraging sediment deposition when used appropriately.

#### Notes on

**a) applicability.** The technique would likely be most applicable on sand-bed streams with low to moderate debris loadings. The sheet piles would not be easy to drive into gravel and cobbles. Large amounts of debris might render a porous sheet pile ineffective, and even possibly produce local scour around the edges that would adversely affect the bridge pier downstream. On the other hand, if the sheet pile were not too close to the pier, the debris might actually enhance its performance. Deposits of sediment downstream of debris in rivers are common.

**b) design.** No design criteria exist for porous sheet piles as scour countermeasures. Design criteria exist for permeable dikes and snow fences, however.

**c) construction and maintenance.** Porous sheet piles would likely be easy to fabricate. They would be no more difficult to install on the beds of sand-bed rivers than Iowa vanes, the installation of which is now routine. They would require little maintenance except possibly the removal of debris. They would be subject to failure during floods if not driven sufficiently deep.

**d) performance evaluation.** The countermeasure remains untested in the context of bridges, and thus would require a field performance evaluation if laboratory tests were promising.

**e) cost.** The cost of manufacturing and installing porous sheet piles is still to be determined. In principle, the simplicity of the scheme suggests that the cost need not be excessive.

#### Major research needs

Since the technique remains virtually untested even in the laboratory, the first step is a comprehensive laboratory investigation. If the results of the laboratory investigation are promising, a field test should be carried out. In addition, the cost of production and installation needs to be explored.

#### Recommended experimental program

The first goal of the experimental program is the determination as to whether or not the method produces scour reduction and pier protection that is in any way comparable with existing methods. If the results of this initial testing are negative, the project should be abandoned in favor of more promising countermeasures. If the results are positive, the tests should progress to a refinement of design and

placement, and a determination of the efficacy relative to standard riprap (see the work plan "Standard Riprap").

*Task 1:* Conduct experiments in a relatively small-scale facility to study feasibility of the scheme. The conditions modeled should be those of a sand-bed stream with a substantial load of sand in suspension during floods. The goal of the experiments would be simply to determine if the countermeasure has promise.

*Task 2:* If the countermeasure proves promising as a result of the Task 1 program, the experimentation should be continued to determine optimum height above the bed, depth of burial, width, distance upstream of the bridge pier, porosity and shape (flat versus curved). These experiments should also be conducted at a relatively small scale.

*Task 3:* Verify the results of Task 2 in a near-field scale facility. Conduct more detailed tests on optimal porosity, a property that may not be modeled well at small scales. Determine performance as a function of varying scour depth and flood stage. Determine the loss of performance with increasing skewing of the approach flow, and possible mitigation of this effect by means of altered shape of the sheet pile. Determine conditions for failure of the sheet pile, either in the sense that it no longer protects the bridge pier or that it is scoured and removed.

*Task 4:* Reduce the results of the above study into a tentative design procedure that can be checked in a field study. Study options for installation.

#### Recommended field program

The field program cannot be specified in detail until after the completion of the experimental program. The following issues, however, should be considered when planning a field test.

The site of the field test must be one where the technique might reasonably be expected to work. An appropriate site would be a sand-bed stream which suspends large quantities of sand during floods. The depth of sand must be sufficient to allow for installation of the sheet piles. A tandem test of a sheet pile installed against one pier versus riprap installed against an adjacent pier would be desirable.

#### Recommended evaluation of cost effectiveness

The evaluation of the cost of manufacture and installation should be relatively easy, as considerable experience exists for the manufacture and installation of sheet piling. The effectiveness of the technique remains unknown, and awaits the laboratory and field program.

#### Estimated cost of experimental program

As part of a larger project: \$120,000

As a stand-alone project: \$185,000

#### References

Beckstead, G., "Design Considerations for Stream Groins." *Report*, Alberta Department of the Environment, Alberta, Canada (1975) 45 p.

Kind, R. J., "Snow Drifting." *Handbook of Snow: Principles, Processes, Management and Use*, Gray, D. M. and Male, D. H., Editors, Pergamon Press (1981).

Levi, E. and Luna, H., "Dispositifs pour Reduire l'affouillement au Pied des Piles de Pont." 9th IAHR Congress, Dubrovnik, *Proc.* (1961), pp. 1061-1069.

Maza, J. A., "Scour in Natural Channels." University of Auckland, School of Engineering, *Report 114* (1967).



### 2.3.3d Sacrificial Piles

Sacrificial piles (Figure 2.17) are piles placed upstream of the bridge pier for the purpose of protecting it from scour. The piles, which themselves may be subject to substantial scour, protect the pier from scour by deflecting the high-velocity flow and creating a wake region behind them. The effectiveness of this method as a pier scour countermeasure is dependent on the number of piles, their protrusion (partly or fully submerged) and the geometric arrangement of the piles in relation to one another and the bridge pier. The piles can be arranged in a variety of configurations. A triangular array, with the apex of the triangle pointing upstream, has been shown to be one of the better configurations among those tested.

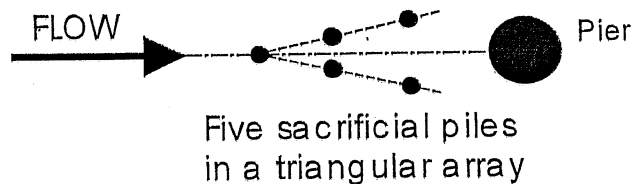


Figure 2.17. Sacrificial piles in a triangular array.

A reasonable amount of information is available concerning sacrificial piles. Most of this is derived from various laboratory studies, including Chabert and Engeldinger (1956), Levi and Luna (1961), Shen et al. (1966), Chang and Karim (1972), Herbertson and Ibrahim (1992), Paice and Hey (1993) and Wang (1994). These studies showed up to 50% scour reduction due to the presence of the sacrificial piles; however the laboratory data were all measured in experiments of limited duration and the results may not be reliable. Chang and Karim (1972) and Paice and Hey (1993) also report some field experience with the technique.

#### Experience with unit design

Sacrificial piles comprise arrays of standard piles and would typically be driven into the river bed. Adequate experience for pile design is available. Sacrificial piles have been installed on several bridges as well, so it is possible to obtain preliminary information from the field concerning design success.

#### Experience with field application

**Bridge piers.** Field tests were conducted by Chang and Karim (1972) and Paice and Hey (1993). The field studies by Chang and Karim were undertaken on a bridge over the Big Sioux River, South Dakota. The bridge is supported on three pairs of circular piers. Three piles were driven upstream of one of these in a triangular pattern. The pile spacing was about three diameters. As much as 44% scour reduction was realized. Paice and Hey (1993) installed pile groups as scour countermeasures at three bridge sites (estuarine, tidal-influenced and non-tidal rivers) in the United Kingdom. At the date of writing, no significant flood events or scour had occurred at any of the sites. One of the bridges is on a tidal reach of the Severn River. Preliminary data over five tidal cycles support the claim that sacrificial piles reduce scour at bridge piers.

**Other.** The technique of using sacrificial piles was evolved specifically for bridge scour protection; no examples could be found of the use of sacrificial piles as a scour countermeasure at other than bridge piers.

#### Notes on

a) **applicability.** The technique is potentially applicable at many bridge crossings. It is particularly suitable for use at bridge piers founded in finer grained alluvial stream beds, i.e. for bed materials ranging from fine sands to medium sized gravels. The technique may be limited in applicability where debris contamination is likely and where the approach flow can be skewed to angles larger than about 20°. Use of the technique at bridge piers sited in navigation channels may be undesirable. Also, the technique may be aesthetically undesirable at certain sites.

**b) design.** No generally accepted design criteria exist for sacrificial piles. However, some design information is available from the model study results. Chang and Karim (1972) found that for a round-nosed pier, three sacrificial piles set at the vertices of an equilateral triangle reduce scour around the pier by at least 40%. The best results were obtained when the vertical angle of the triangle was 20°, the pile spacing was six times the pile diameter, and the apex of the triangle was set at 2.5 times the pier width upstream from the pier nose. Their results showed that, for piers not aligned with the flow, more than three piles are needed to give adequate protection. They also found that submerged piles with length 0.3 to 0.4 times the flow depth are equally effective in reducing scour as piles extending to the water surface, particularly for a pier aligned with the flow. Chabert and Engeldinger (1956) give several plots of model pier scour depth contours in terms of geometric parameters describing the number and pattern of piles in a triangular array. These plots could be used to determine scour depths at protected piers for situations encompassed by the range of model configurations.

**c) construction and maintenance.** Construction of sacrificial piles consists only of driving piles at the proper locations. Since the piles stand independently of the pier, they may be constructed separately at a convenient time; the method can be used to retrofit a bridge pier. Sacrificial piles are permanent in the sense that no maintenance is needed unless there is an abrupt change in the river bed level or flow characteristics. Clearing of debris from the piles may be necessary at some sites.

**d) performance evaluation.** The available field tests of sacrificial piles are inadequate for assessing the performance of the technique. Further field testing is needed. A desirable bridge site for field testing would be one where at least two piers exist with reasonably similar characteristics; the installation would be made at one pier; the other pier would be used to compare results.

**e) cost.** The cost of sacrificial piles can be readily determined from costs for pile driving. Factors that could affect cost include bed material type, site accessibility and difficulty of establishing a platform for pile driving, including local availability of pile driving equipment, and likely maintenance costs such as the need to repair piles damaged by impact of river traffic or debris and the need to clear debris lodged against the pile array.

#### Major research needs

A reasonable research effort has been directed at evaluating sacrificial piles as a scour countermeasure at bridge piers. Two significant sets of laboratory data are available, viz. Chabert and Engeldinger (1956) and Chang and Karim (1972). These suggest that the technique has the potential to effect significant scour depth reductions. However, these data have a shortcoming; the scour depths were measured after quite short times of scouring. It is possible that lesser scour depth reductions would occur if the tests had been run for longer times because the sacrificial piles may affect the rate of scouring rather than the ultimate depth. Before sacrificial piles can be accepted as a viable scour countermeasure, further laboratory verification is necessary. Thereafter, additional research would be undertaken only if the initial testing showed promise.

#### Recommended experimental program

The initial experimental investigation should be designed to confirm or invalidate the potential scour depth reductions afforded by the technique that are indicated by the existing laboratory data. A systematic study of a few variations of a simple triangular array of sacrificial piles is needed. A few, carefully-executed experiments should be undertaken. If these preliminary experiments confirm the earlier data, further experimentation and field testing would be warranted. Additional laboratory experiments would need to demonstrate the sacrificial pile requirements to protect piers for a wide range of pier, flow and sediment characteristics.

The following experimental program is recommended.

*Task 1:* Verify the potential scour depth reductions shown in prior laboratory results of sacrificial piles. These experiments are best done using a simple triangular array of piles upstream of a circular cylindrical pier, the whole in a symmetrical (aligned) configuration. The experiments need to run long enough to ensure that the ultimate scour depth is reduced due to the presence of the sacrificial piles. The experiments also need to be analyzed to show comparative rates of scouring with and without sacrificial piles. Prepare an interim report setting out the results of the initial experiments. Proceed with subsequent tasks only if significant scour depth reductions are demonstrated.

*Task 2:* Undertake laboratory experiments comprising a systematic study of parameters affecting the depth of scour at piers protected by sacrificial piles. Use existing data to augment the new data and develop a design criterion for sacrificial piles. The design criteria should give the required sacrificial pile configuration (number, size, pattern and protrusion of piles) for the practical range of likely pier geometries and flow and sediment characteristics. Flow skewness is recognized as an important variable to be assessed in the experimental program.

*Task 3:* Evaluate the influence of debris collection at the piles on their effectiveness as scour countermeasures.

*Task 4:* Assess the applicability of sacrificial piles in navigation channels and document the aesthetic characteristics of this method of scour protection.

*Task 5:* Amalgamate the research results in a report which contains specific design guidelines and also recommends an appropriate field testing program.

#### Recommended field program

Undertake the field testing recommended in Task 5. It is likely that at least two installations would be established. The design of sacrificial piles for each site would be based on the criteria set out in the Task 5 report. In selecting sites for field testing, it is important to identify sites where two piers with similar characteristics exist; one pier is used for the test with sacrificial piles, the other for comparison without piles. The chosen sites should be representative of at least two different pier types and two different bed material types. At least one site should feature significant flow alignment variations and have the potential for debris contamination of the piles. The period of monitoring needs to extend until at least one major flood has occurred at the given site.

#### Recommended evaluation of cost effectiveness

The cost-effectiveness of sacrificial piles can be determined from known costs of pile driving in the fluvial environment. The factors listed in e) cost would be important cost determinants.

#### Estimated cost of experimental project

As part of larger project: \$110,000

As a stand-alone project: \$175,000

#### References

- Chabert, J. and Engeldinger, P., "Etude des afouillements autour des piles des ponts." Laboratoire National d'Hydraulique, Chatou, France, *Report* (1956).
- Chang, F. F. M. and Karim, M., "An Experimental Study of Reducing Scour Around Bridge Piers Using Piles." South Dakota Department of Highways, *Report* (1972).
- Herbertson, J. G. and Ibrahim, A. A., "Interaction between Bridge Piers and Scour Protection Devices." International Conference on Protection and Development of the Nile and other Major Rivers, Cairo, Egypt, *Proc.* (1992).
- Levi, E. and Luna, H., "Dispositifs pour Reduire l'affouillement au Pied des Piles de Pont." 9th IAHR Congress, Dubrovnik, *Proc.* (1961), pp. 1061-1069.

Paice and Hey, "The Control and Monitoring of Local Scour at Bridge Piers." Hydraulic Engineering Conference ASCE, San Francisco, California, *Proc.* (1993), pp. 1061-1066.

Shen, H. W., Schneider, V. R., et al., "Mechanics of Local Scour." Engineering Research Center, Colorado State University, *Report No. CER66HWS22* (1966a). Shen, H. W., Schneider, V. R., et al., "Mechanics of Local Scour Supplement: Methods of Reducing Scour." Engineering Research Center, Colorado State University, *Report No. CER66HWS36* (1966b).

Wang, T. W., "A Study of Pier Scouring and Scour Reduction." 9th Congress of the APD of the IAHR, Singapore, *Proc.* Vol. 2 (1994), pp. 18-28.

### 2.3.3e Slot in Pier

The principle behind the use of a slot in a pier as a means of bridge pier protection is that it can divert the downflow associated with the horseshoe vortex away from the scour hole. The presence of the slot has the effect of forcing part of the downflow through it instead, thereby reducing the intensity of the impinging downflow onto the scour hole. When the slot is positioned near the water surface, its primary effect is the reduction of the depth of flow, thereby reducing the strength of the downflow. Limited experimental data by Chiew (1992) have shown that an appropriately positioned slot with a gap of one quarter the pier diameter can effectively reduce the maximum clear water scour depth by 20%. A one-half diameter wide slot can offer a clear-water scour depth reduction of up to 30%. When the slot is used in combination with a thin collar, pier scour may be completely eliminated.

As an alternative to the use of a slot through the bridge pier, a recent study (Vittal et al. 1994) advocated the use of a group of three piles (each with smaller diameter than the pier) arranged in a triangular configuration. The principle of this approach is similar to that of the slot, but their experimental data suggest that it is more effective than the technique of a slot in a single pier. A reduction of scour of up to 40% was measured in the laboratory tests.

#### Experience with unit design

This technique has not been used in the field, so that no specific design experience is available. The concept is new, and even experimental data are scanty. However the method requires only the provision of a slot in the pier structure, which is an elementary design problem at the time of installation. Retrofitting with slots is likely far more difficult, if not impossible in most cases.

#### Experience with field application

**Bridge piers.** No examples could be found for either the use of a slot in a pier or group piles in the field.

**Other.** It appears that perforated breakwaters have been used in the North Sea with a certain amount of success.

#### Notes on

**a) applicability.** The technique is potentially applicable provided that the structural integrity of the pier can be ascertained. A potential problem with regard to debris choking the slot must be considered prior to the use of this type of countermeasure for scour protection in the field.

**b) design.** As the proposed method is very new, no design criteria exist for its use in the field. It can be surmised, however, that a design chart which describes the effect of the size and location of the slot on the depth of scour could be determined from more experiments. An approach similar to the K-factors used to quantify the effect of flow depth, grain size and slot size may also be appropriate.

**c) construction and maintenance.** No specialized construction technique is envisaged in this method, provided that the structural integrity of the pier is maintained. Regular maintenance may

be necessary, as debris in the river may choke the slot opening, rendering the countermeasure ineffective.

**d) performance evaluation.** The performance of a slot-in-a-pier has not been tested in the field. In fact, even flume data are scarce. A field test would help to reveal its performance at the prototype scale. The test could be conducted using a pair of piers, one with and one without the slot.

**e) cost.** The cost of slot-in-a-pier countermeasure is unknown at this time. It may be relatively inexpensive to implement at the time of bridge construction. An analysis of cost in the case of retrofitting would require the advice of structural engineers.

#### Major research needs

The installation of a slot in a pier to deflect the downflow from impinging onto the scour hole, thereby reducing the depth of erosion, is a potentially workable technique to reduce scour. The proposed use of this technique as a bridge pier protection device is, however, quite new. Even laboratory data are scarce, and published data are only applicable to clear-water conditions. The concept of using a pile group as an alternative means of slot in pier technique should also be examined in order to arrive at optimum design. Additional experiments would be needed to examine the performance of this technique as a feasible bridge pier protection method.

#### Recommended experimental program

The experimental program should in the first instance be designed to confirm the existing data for the slot-in-pier method. All existing data are confined to a circular pier under clear-water conditions. Additional tests should also be conducted with a rectangular pier, and also under live-bed conditions. In addition, the effect of the location and size of the slot should be examined in more detail to ascertain its performance under different slot configurations and flow conditions.

The experimental study should also examine how changes to the flow parameters, especially the approach flow depth affect the performance of the technique. The program should aim to formulate design specifications for field implementation of this pier scour countermeasure.

An important aspect of the experimental program concerns alternative methods to the single slot-in-pier technique such as the group pile method suggested by Vittal et al. (1994). By examining these alternative methods, the overall performance of this approach to protect a bridge pier may be improved and the practicability of the technique enhanced. As suggested by the data of Chiew (1992), the method may be used in conjunction with other pier scour countermeasures such as a collar to further enhance its efficiency. The experimental program should look into this aspect to fully exploit the potential of this method as a bridge pier scour countermeasure.

With the above comments in mind, the following experimental program is recommended:

*Task 1:* Build an experimental facility at a manageable scale for the purpose of evaluating the performance of slot in pier as a scour countermeasure at bridge piers. The experimental facility should allow for testing under both clear-water and mobile-bed conditions. It should allow for both rectangular and circular bridge piers.

*Task 2:* Use the facility to conduct tests to evaluate the performance of the slot in pier method under varying flow conditions and slot configurations. Determine whether or not an optimal design of slot for one flood flow condition also performs well for other flood flow conditions.

*Task 3:* Conduct a series of tests to evaluate the group pile method under varying flow conditions. Perform a comparison between this method and the single slot in pier method.

*Task 4:* Conduct tests to examine the possibility of combining this technique with other pier scour countermeasure techniques. The existing data on the combination of a slot in the pier and a collar should be reviewed, and additional combinations tested. The reader is referred to the following work plans: "Collars and Horizontal Plates" and "Standard Riprap."

*Task 5:* Amalgamate the above results into a report which contains specific design guidelines based on the experiments, and also recommends an appropriate program for field testing.

#### Recommended field program

The technique is a new one, and a field test is warranted only if the experimental program is promising. Any such field program should be devised to test some of the promising configurations and/or combinations of countermeasures determined in the laboratory. At least two piers are needed for the field program. In the test, a slot of appropriate size would be installed at the proper location on one of the piers, while the other would be left without any slot. It must be noted that if a slot were to be made through a pier of an existing bridge, the structural stability requirements of the bridge would require ascertainment. If possible, the test should be repeated with a second bridge located in a different river regime.

The period of field monitoring should be sufficiently long so as to include at least one major flood, and also to allow for an evaluation of long-term durability. Because of the difficulties associated with the construction of a slot through an existing bridge pier, it may also be useful to test this technique in the laboratory at a very large scale, and to compare the result with that obtained in a smaller flume.

#### Recommended evaluation of cost effectiveness

The design for a slot in a pier is elementary and should generally cause no difficulty where deemed feasible. Furthermore, no special expertise in construction technique is required beyond that routinely employed to build bridges. It is envisaged that the cost of design and construction would not play an important role in the decision making process in assessing whether to adopt this method of scour countermeasure, as long as the construction were structurally feasible. Cost considerations for maintenance become important if debris were found to choke the slot after construction.

#### Estimated cost of experimental program

As part of a larger project: \$135,000

As a stand-alone project: \$200,000

#### References

Chiew, Y. M. "Scour protection at bridge piers". J. Hyd. Engrg., ASCE, 118(9), (1992), 1260-1269.

Vittal, N., Kothiyari, U. C., and Haghghat, M. "Clear-water scour around bridge pier group". J. Hyd. Engrg., ASCE, 120(11), (1994), 1309-1318.

#### 2.3.3f Suction Applied to Pier

The technique involves removal of fluid from the surface of the pier by internal suction (Figure 2.18). The method presumably is derived from the concept of boundary layer control used extensively in aerodynamic engineering. Rooney and Machemehl (1977) appear to be the only researchers to test the technique in the context of bridge piers. In their experiments, the embedded length of the pier was fitted with 30 drilled holes (six holes at each of five levels ranging from just above the sediment bed to below the surface of the bed) from which water could be extracted. Suction was created by pumping from inside the bridge pier, which comprised a hollow 0.1 m diameter circular cylinder. Two rates of pumping were tested. At the low rate (about 0.1 l/s) the scour was reduced by 50 percent. At the high rate (about 0.4 l/s) it was eliminated completely. The study has the interesting feature that scour due to current-wave action as well as currents alone was investigated.

This single study suggests considerable unrealized potential for suction as a means to suppress scour. Optimism must be tempered, however, by recognition of the need to have a means of driving the pump at any field installation, and by the potential for clogging of the holes.

### Experience with unit design

This technique has not been tried in the field, so that no specific design experience is available. However, the method requires only the installation of a pumping system and associated equipment, which are routine tasks.

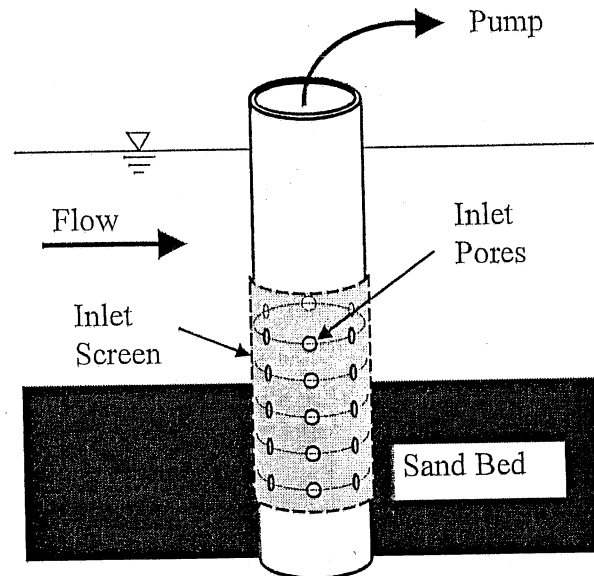


Figure 2.18. Suction at pier.

### Experience with field application

**Bridge piers.** No examples could be found for the installation of suction at the pier face as a scour countermeasure.

**Other.** Suction is known to be a successful technique in regard to aerodynamic boundary layer control. The objective of suction from the boundary layer on an aerofoil is drag reduction through postponement of separation. It is assumed that such methods inspired the study by Rooney and Machemehl (1977). However, it is not known whether alteration of the boundary layer on the surface of a bridge pier is the reason behind the claimed success of the technique as tested by Rooney and Machmehl (1977).

### Notes on

**a) applicability.** The method is potentially applicable at most piers. Factors that need to be considered include; the potential for blockage of the suction holes and the related need for adequate filtering of the holes, and the need for permanent installation of pumping equipment that would operate reliably during periods of high flow and/or scour risk. The latter may dictate the need for provision of standby (diesel) pumping equipment and redundancy generally in the design of the pumping system. The method would be more difficult to retrofit to an existing bridge pier than to incorporate in a new pier.

**b) design.** No design criteria exist for this technique, although some information can be gleaned from the laboratory study. Assuming Froude scaling, the high rate of pumping used by Rooney and Machmehl (1977) in their laboratory tests is equivalent to about 700 l/s at a 2 m diameter (prototype size) pier.

**c) construction and maintenance.** Construction of this technique would involve standard methods of installation of pumps and related equipment. Fitting the equipment to existing bridge piers may be difficult. There would be the need for regular maintenance of all mechanical and electrical equipment comprising the installation.

**d) performance evaluation.** The research team is unaware of any experience of this technique in the field.

**e) cost.** The cost of installing this countermeasure at a new bridge pier is readily estimated from known costs of pumps and ancillary equipment. The possible need for redundancy in the installed plant would need to be considered. The cost of installing the equipment to an existing bridge pier could be significantly higher than at a new bridge, depending on whether the suction pipework needs to be installed 'inside' or can be attached to the outside of the pier. The former could be achieved by the addition of a skin containing the pipework, etc. to the outside of the pier. Operational costs, comprising costs of pumping and costs of maintenance of the equipment, would need to be considered.

#### Major research needs

The use of suction as a scour countermeasure has not been adequately investigated. The only known tests, by Rooney and Machmehl (1977) using a small scale laboratory model, are limited in their scope. A more comprehensive evaluation of this apparently promising technique is needed, both in the laboratory and the field.

#### Recommended experimental program

Experiments should be undertaken for different configurations of suction holes and for at least two pier shapes, e.g. circular and rectangular. The experiments would enable evaluation of the effectiveness of the method in limiting scour depth and determination of the necessary rates of pumping for different conditions. Several pier sizes, up to as near to full scale as is possible in the laboratory, should be investigated to ensure there are no unknown scale effects associated with the technique.

The following experimental program is recommended.

*Task 1:* Undertake a systematic laboratory investigation of the use of suction as a scour countermeasure. Use the test results (a) to assess the effectiveness of the method as a scour countermeasure, and if the assessment is positive; (b) to evaluate relations for design of a suction system, including prediction of pumping rate and suction hole configuration; and (c) to determine whether the suction pipework and intake ports can be fitted to the outside of the pier or whether they need to be installed internally or within a skin attached to the pier.

*Task 2:* Assess potential problems associated with the technique, including clogging of the intake ports and necessary measures to guard against failure of the pumping system.

*Task 3:* Document the research findings in a report, which would include a set of design guidelines for the technique and a recommended field testing program, if deemed appropriate following the findings of the laboratory program.

#### Recommended field program

If the laboratory program confirms the potential of this technique as an effective countermeasure, it will be important to undertake a program of field testing to verify its applicability at the prototype scale. The details of the field program can not be specified at this stage, their being dependent on the outcome of the laboratory testing. Whether the field installation would be executed at an existing or a new pier may depend on the outcome of (c) above.

#### Recommended evaluation of cost effectiveness

The cost-effectiveness of this technique is dependent on the capital and operational costs of the pumping system, including any maintenance costs that may be necessary. For existing bridges, the capital



cost would be heavily dependent on the feasibility, or otherwise, of fitting the suction pipework to the outside of the pier rather than internally, i.e. on the outcome of (c) above.

#### Estimated cost of experimental program

As part of a larger project: \$110,000

As a standalone project: \$200,000

#### References

Rooney, D.M. and Machemehl, J.L., "Using suction to minimize sand bed scour," *Journal of the Hydraulics Division*, ASCE, 103(HY4), (1977). pp. 443-449.

### 2.3.4 Implementation

#### 2.3.4a Overview

It was neither possible nor desirable to implement all the work plans under the auspices of Project 24-7. It was decided that the work plans for three of the four high-priority countermeasures, namely standard riprap, cable tied blocks and sacked concrete be evaluated as entirely as possible under the auspices of the present study. Were the fourth high-priority countermeasure, gabions and Reno mattresses be implemented under the present project, there would be no time to devote to several of the innovative but untested medium-priority countermeasures. With this in mind, and in light of the considerable literature already available on gabions, experimental work on this countermeasure is recommended for deferral to the highest priority of a future second phase of research. On the advice of the panel, it was decided that an investigation of gabions should be limited to a study of material durability of the gabion casing material.

The resources of Project 24-7 do not appear to be adequate for a complete evaluation of any of the medium-priority countermeasures. With this in mind a preliminary study of vanes and plates, permeable sheet piles and high-density riprap was proposed. These appear to be the most promising of the techniques not yet tried extensively in the field. High-density riprap was, however, later dropped for further study in light of discouraging preliminary results.

The work was split between two experimental facilities, St. Anthony Falls Laboratory and the University of Auckland, New Zealand. Both facilities allowed for large-scale testing. Of the research team, Voigt, Parker, Parola and associates performed their experimental work at St. Anthony Falls Laboratory; Melville, Chiew and their associates conducted experimental work at Auckland. Frequent communication by e-mail allowed for a good coordination and synergism of study effort.

#### 2.3.4b Work Plan for St. Anthony Falls Laboratory

Most of the experimental study performed at St. Anthony Falls Laboratory were conducted in the Main Channel, which has a depth of 6 ft, a width of 9 ft and a length of over 250 ft. An existing slurry pump was used to recirculate either sand or gravel. The configuration was set up for both clear-water and live-bed scour. The experiments in sand utilized a relatively uniform material with a grain size near 0.9 mm. The experiments in gravel would utilize a relatively poorly sorted mixture. The largest pier size that could be reasonably tested in the facility has a width of about 1 ft, a value that is not much smaller than field scale. Tests were also be conducted at a 1:3 scale to allow for several piers to be tested simultaneously in the channel. Both round and rectangular piers were used in the tests. The larger piers were made of clear acrylic to facilitate videotape/observation of the near pier flow and sediment patterns.

The execution of the work plan for standard riprap was split between St. Anthony Falls Laboratory and Auckland. Both facilities allowed for study of both clear-water and live-bed conditions. At St. Anthony Falls Laboratory, emphasis was placed upon the effect of riprap gradation, approach flow

Froude number, the combined effects of pier and abutment scour and the difference between rectangular and round piers.

In addition, the work plans for cable tied blocks was executed at St. Anthony Falls Laboratory. The results of the studies on standard riprap allowed some streamlining of these tests without loss of generality. Preliminary studies of sacked concrete (grout filled bags and mattresses), and porous sheet piles were also conducted.

The study of flow-deflecting vanes and plates was also divided between Auckland and St. Anthony Falls. In both cases only preliminary studies were done. The work at St. Anthony Falls focused on pier-attached vanes.

The studies of pier-attached vanes and porous sheet piles were performed using a smaller tilting flume, allowing work to proceed simultaneously in the larger channel. The following time allocation was planned for the work at St. Anthony Falls Laboratory.

Startup:	2.5 months
Standard riprap:	5.0 months
Cable tied blocks:	4.0 months
Sacked Concrete:	1.0 months
Porous sheet piles:	1.0 months
Pier-attached vanes:	0.5 months
TOTAL	14.0 months

In addition to the above work, funds were allocated to a study of material durability of materials used for the casings of gabions.

#### **2.3.4c Work Plan for University of Auckland**

The following laboratory flumes were available to be used for the experimental work at the University of Auckland. For each particular experiments, the most appropriate flume was selected.

- *5-ft wide flume* A glass-sided, tilting facility, which has a depth exceeding 3 ft and length of over 100 ft, this flume is equipped for continuous circulation of water and sediment.
- *1.44-ft wide flume* This flume is also glass-sided and tilting, has a depth of 1 ft and length of over 40 ft, is equipped for continuous circulation of water and sediment, and includes a sediment recess providing about 2 ft overall depth.
- *1.5-ft wide flume* This glass-sided, tilting facility, which has a depth exceeding 1 ft and length of over 60 ft, is equipped with a sediment recess section containing an adjustable floor allowing bed degradation experiments to be performed under conditions of parallel degradation and fixed applied bed shear.
- *8-ft wide flume* This tilting flume has a sediment recess giving depths exceeding 2 ft and a length of about 40 ft. It is equipped for live-bed experiments using the "feed-and-retrieve" technique.

Concerning standard riprap, emphasis was given to live-bed conditions, with four aspects being addressed. These are the effects on riprap stability of placement of riprap; size and gradation of riprap, bed degradation, and bedform migration. Bed degradation experiments will be conducted in the 1.5-ft flume using the adjustable floor section. Other riprap experiments utilized the other flumes as appropriate. The majority of these experiments were conducted with a reasonably uniform 0.8-mm sand and circular cylindrical bridge pier models.

Preliminary studies of Iowa vanes and sacrificial piles were undertaken at the University of Auckland. This work was done in one of the sediment transporting flumes using sand.

The following time allocation was planned for the work at the University of Auckland.

Setup:	1 month
Standard Riprap:	6 months
Iowa Vanes:	1.5 months
Sacrificial Piles	1 month
TOTAL	9.5 months

**2.3.4d Future Extension of the Work**

Were a second phase of the work to be implemented by the same research team, the following time estimates for the implementation or completion of the relevant experimental work plans for the high- and medium-priority countermeasures are suggested. Minimal startup time would be required, in that the facilities would become completely operational during the present project.

Countermeasure	Study Location	Time (months)
Sacked Concrete (completion)	SAFL	3
Pier-attached vanes (completion)	SAFL	4
Porous sheet piles (completion)	SAFL	5
Iowa vanes (completion)	Auckland	3
Gabions and Reno mattresses	Auckland or SAFL	5
Sacrificial Piles	Auckland	5
Artificial riprap	SAFL	5
Collars and horizontal plates	Auckland	6

### 3. EXPERIMENTAL INVESTIGATIONS AT ST. ANTHONY FALLS LABORATORY

#### 3.1. OVERVIEW OF CHAPTER

Countermeasures were tested in two experimental flumes at St. Anthony Falls Laboratory, the Main Channel and the Tilting Flume. The former is the larger of the two. A guide to the experiments is provided below in Table 3.1. The abbreviations MC and TF refer to Main Channel and Tilting Flume, respectively, in Table 3.1.

**Table 3.1.** Summary of experimental runs

Run Series	Description
MC-NP0	Calibration runs in the Main Channel
TF-NP1	Tilting Flume, no scour protection
TF-NP2	Tilting Flume, repeat of TF-NP1
MC-NP1	Main Channel, no scour protection
MC-NP2	Main Channel, repeat of MC-NP1
TF-RR1	Tilting Flume, coarse riprap, prior excavation, no geotextile
TF-RR2	Tilting Flume, repeat of TF-RR1
TF-RNG	Tilting Flume, riprap, prior excavation, no geotextile
MC-RNG	Main Channel, riprap, prior excavation, no geotextile
TF-RPG	Tilting Flume, riprap, geotextile, prior excavation
MC-RPG	Main Channel, riprap, geotextile, prior excavation
MC-RPL	Main Channel, riprap, geotextile, placement in flow
MC-RNX	Main Channel, riprap, geotextile, no prior excavation
TF-CB	Tilting Flume, cable tied blocks
MC-CB1	Main Channel, cable tied blocks, configuration
MC-CB2	Main Channel, cable tied blocks, configuration
MC-CB3	Main Channel, cable tied blocks, configuration
MC-GB1	Main Channel, grout filled bags, configuration 1
MC-GB2	Main Channel, grout filled bags, configuration 2
MC-GB3	Main Channel, grout filled bags, configuration 3
MC-GB4	Main Channel, grout filled bags, configuration 4
MC-GB5	Main Channel, grout filled bags, configuration 5
MC-GB6	Main Channel, grout filled bags, configuration 6
TF-SP1	Tilting Flume, permeable sheet piles, configuration 1
TF-SP2	Tilting Flume, permeable sheet piles, configuration 2
TF-PV1	Tilting Flume, pier attached vanes, configuration 1
TF-PV2	Tilting Flume, pier attached vanes, configuration 2
TF-CMB	Tilting Flume, combination of permeable sheet pile and riprap
MC-CMB	Main Channel, combination of cable-tied blocks and riprap

The above table should be used in conjunction with many of the figures and tables in this chapter.

The essential results obtained in this chapter are as follows.

- In sand bed streams, riprap in the absence of a geotextile filter or granular filter layer tends to sink due to the passage of dunes at flood stage.
- This sinking can be arrested by the use of a geotextile filter placed below the riprap. The areal cover of the geotextile should be less than that of the riprap in order to allow the riprap to anchor the geotextile in place.
- Excellent scour protection is obtained when the riprap and geotextile filter are placed into a prior excavation so that the top of the riprap layer is flush with the average bed elevation (away from any scour hole).
- Adequate protection can be obtained when the riprap is dumped and smoothed on the geotextile filter.
- It is important to seal the geotextile to the pier. A tentative technology for placing the geotextile in flowing water and sealing it to the pier is outlined.
- Cable tied blocks underlain by a geotextile provide an excellent alternative to riprap. No prior excavation is necessary.
- Grout filled bags tend to be much smoother than riprap. They are subject to failure by sliding.
- Submerged permeable sheet piles placed upstream of the pier show little promise as a scour countermeasure.
- Pier attached vanes show little promise as a scour countermeasure.
- Submerged permeable dikes placed upstream of the pier can help stabilize undersized riprap.
- If riprap underlain by a geotextile filter is placed in a prior excavation, it is possible to reduce both the areal cover and thickness of the riprap as compared to that given in HEC-18 (Richardson et al., 1992).
- The same reduction in areal cover can be realized by the use of cable tied block mattresses underlain by a geotextile filter.

### 3.2 BASIC NOTATION

The following notations are fundamental to this report and used throughout. The reader is thus introduced to them immediately:

- |          |   |
|----------|---|
| D        | pier diameter in the case of a cylindrical (circular) pier, and pier width in the case of a rectangular pier, |
| d        | characteristic diameter (e.g. median size $d_{50}$ ) of the ambient bed sediment;                             |
| $D_r$    | characteristic size of the riprap (e.g. median size $D_{r50}$ );  |
| $d_s$    | maximum depth of the scour hole below the local average level of the ambient bed;                             |
| $d_{s0}$ | maximum depth of scour in the absence of any pier protection;   |
| $y_0$    | depth of ambient flow in the vicinity of the bridge pier;   |
| $S_w$    | slope of the water surface;   |
| U        | cross-sectionally averaged approach flow velocity upstream of the pier;                                       |

- $U_c$  critical value of cross-sectionally averaged flow velocity for the initiation of motion of the ambient bed sediment;
- $r_s$  percent reduction in maximum scour depth at a pier achieved by a countermeasure as compared to the absence of any countermeasure; and
- $\Delta$  average dune height.

Other notations are defined as they are introduced. Definitions for all notations used in this report are given in Appendix C.

Two flumes were used in the execution of experimental work for Project 24-7 at St. Anthony Falls Laboratory (abbreviated to SAFL below). They are described below.

Flume	Width (m)	Length (m)	Height (m)	Mode of Operation
Main Channel	2.7	77	1.8	Sediment recirculating, Water feed
Tilting Flume	0.9	15	0.6	Sediment and water feed

The setup for the Main Channel is illustrated in Figure 3.1. As noted above, the channel is 1.83 m (6 ft) deep and 2.74 m (9 ft) wide. The test section is 26 m (85 ft) long. Bulkheads with a height of 0.91 m (3 ft) were installed at the upstream and downstream ends of the test section in order to impound the sediment of the erodible bed. Water is delivered from and returned to the Mississippi River. The sediment, however, is trapped just downstream of the test section and recirculated to a headbox just above the upstream bulkhead.

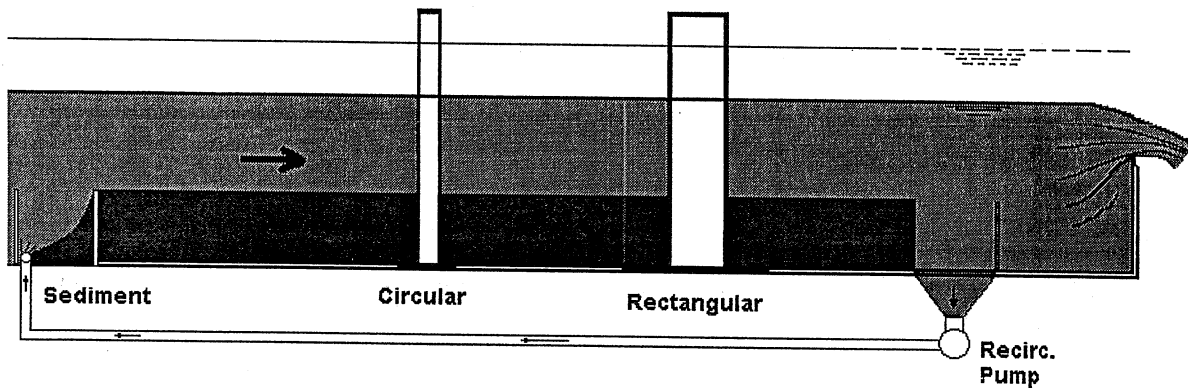
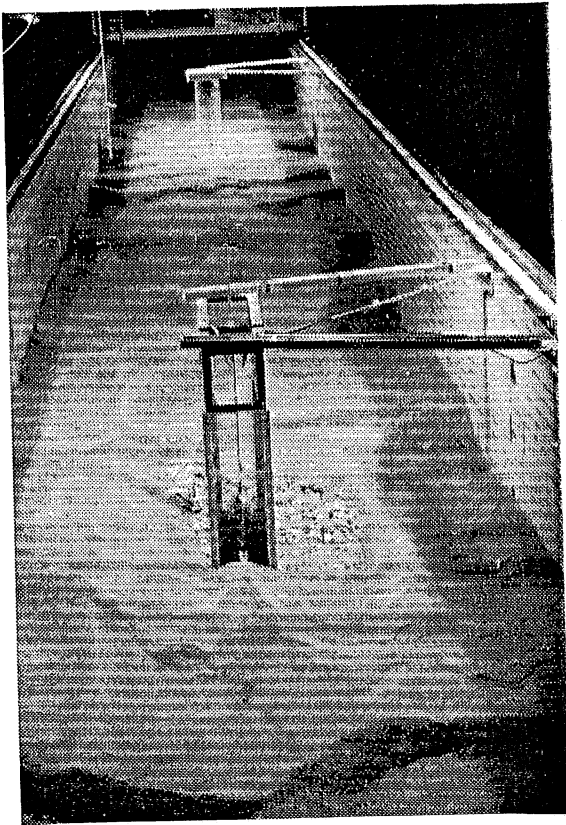
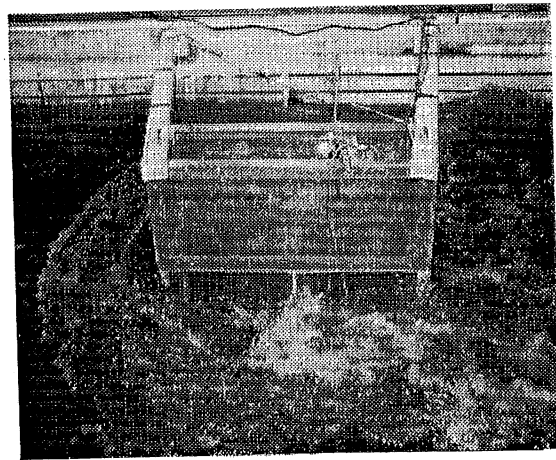


Figure 3.1. Schematic diagram of the Main Channel facility.



(a)

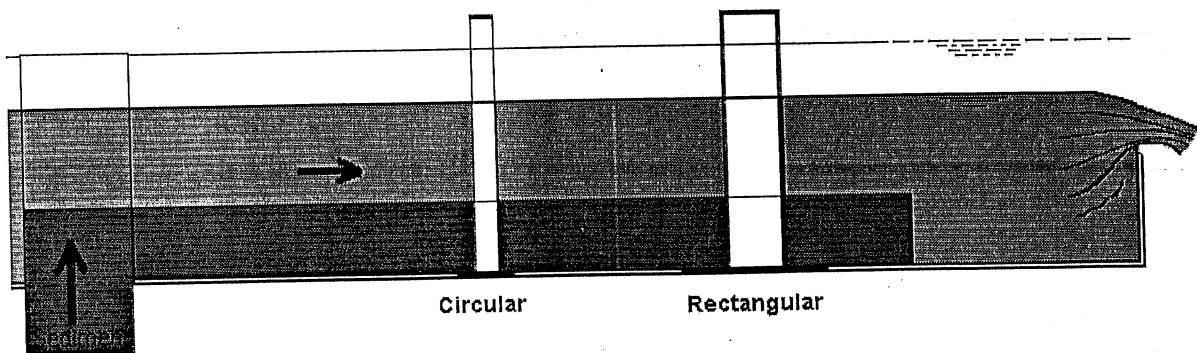


(b)

**Figure 3.2.** (a) View of the Main Channel Facility looking upstream. (b) View of the Main Channel Facility during an experiment.

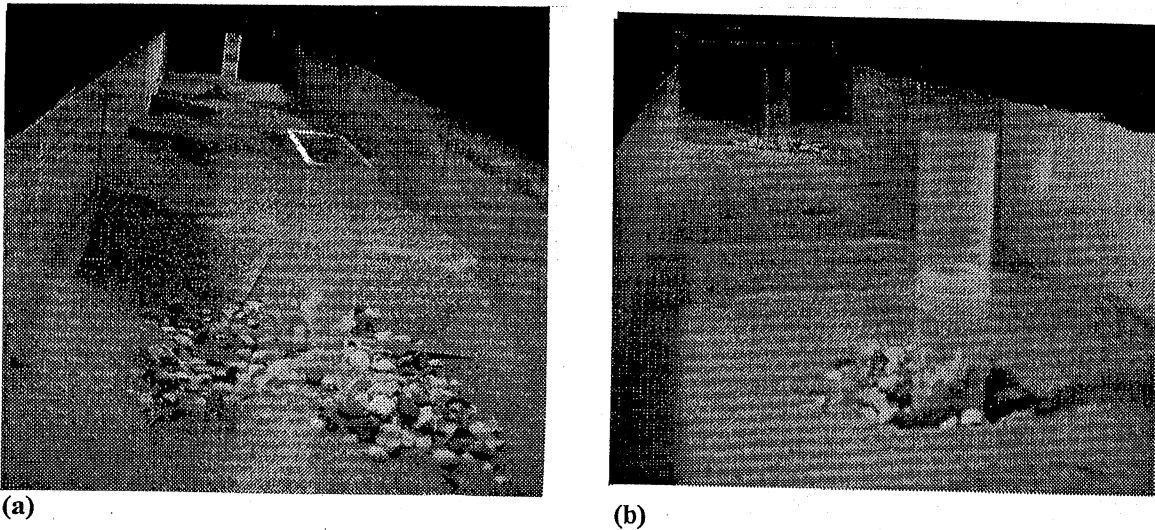
The Main Channel contains two bridge piers. The upstream pier is cylindrical with a diameter of 0.30 m (precisely 1 ft). It is located 8 m (26 ft) downstream of the headbox. 10 m (33 ft) farther downstream is a rectangular pier with a width  $D$  of 0.30 m (precisely 1 ft) and a length of 0.91 m (3 ft). The sediment trap is located another 8 m downstream. Both piers are constructed of clear plastic in order to allow for videotaping the scour process using a camera placed inside the pier. Two photographs of the Main Channel facility are given as Figures 3.2a and 3.2b

The setup for the Tilting Flume facility is shown in Figure 3.3. The channel is 0.91 m (3 ft) wide. Temporary walls have been added to deepen the channel to 0.61 m (2 ft). The test section is 12 m (39.4 ft) long. The sediment within it is impounded by bulkheads with a height of 0.30 m (1 ft). Water is delivered from and returned to the Mississippi River. Sediment is fed to the test section by means of an elevator box with an adjustable speed. When the elevator box is depleted, the run is smoothly halted, sediment is excavated from the tail box, the elevator box refilled, and the run carefully recommenced.



**Figure 3.3.** Schematic diagram of the Tilting Flume facility.

The Tilting Flume also contains two bridge piers, the upstream one being cylindrical with a diameter of 0.10 m (4 in) and the downstream one rectangular with a width of 0.10 m (4 in) and a length of 0.30 m (1 ft). The cylindrical pier is located 6 m downstream of the feed box. 4 m downstream is the rectangular pier, and the tailbox is located 2 m farther downstream. Photographs of the Tilting Flume facility are provided as Figures 3.4a and 3.4b.



**Figure 3.4.** a) View of the Tilting Flume facility looking upstream. b) View of the Tilting Flume facility looking downstream.

Note that the Tilting Flume and the bridge piers within constitute a 1:3 geometric scale model of the Main Channel. This was done to verify scaling. The spacing between the upstream cylindrical pier and the downstream rectangular pier was chosen so as to minimize the effect of the wake of the upstream pier on the downstream pier. Trial experiments were conducted to determine this spacing.

The characteristics of the piers in the two flumes are summarized below. The specifications given in English units are essentially precise.

Flume	Diameter D (cylindrical pier)	Width D (rectangular pier)	Length (rectangular pier)
Main channel	0.305 m (1 ft)	0.305 m (1 ft)	0.914 m (3 ft)
Tilting Flume	0.102 m (4 in)	0.102 m (4 in)	0.304 m (1 ft)

All experiments at SAFL were performed under mobile bed (live bed) conditions. As will become apparent in the discussion below, the fact that the circular (cylindrical) pier was located upstream of the rectangular pier in both the Main Channel and the Tilting Flume was of some consequence in regard to the experimental results. In particular, the mobile bed was in the dune regime for all of the experiments. These dunes were not as well developed in the vicinity of the cylindrical pier as they were at the rectangular pier farther downstream.



### 3.3 MODEL SEDIMENT AND RIPRAP

The ambient bed sediment was sized in order to allow for modeling of fairly typical sand-bed streams. The grain size distribution of the sand as installed is given in graphical form (Figure 3.5) and in tabular form (Table 3.2). In the course of the experiments a finer portion of this mix washed out, resulting in the somewhat coarser reworked distribution A of the same figure and table. The  $d_{50}$  size, for example, increased from about 0.7 mm to about 0.87 mm. Subsequently, a small but steady supply of 0.4 mm sediment from the Mississippi River caused the sediment to eventually become finer, according to reworked distribution B. The median size  $d_{50}$  for this distribution was near 0.50 mm, which was taken as characteristic of all the SAFL runs.

Table 3.2. Grain size distribution of the sediment

Size (mm)	% Finer Sand	% Finer Reworked A	% Finer Reworked B
10	100	100	100
2.8	98.64	87.97	99.9
2	94.38	77.32	99.5
1.4	86.15	66.44	96.7
1	72.63	54.95	91.0
0.7	52.01	42.02	75.8
0.5	34.87	28.31	54.6
0.21	7.34	16.93	2.45
0.105	2.28	8.83	6.25
0.01	0	0	0

In general, the sediment is graded, with significant content between 0.2 and 4 mm. The size distribution is within the typical range for sand-bed streams. The specific gravity of the sand is close to 2.65.

### Grain Size Distribution

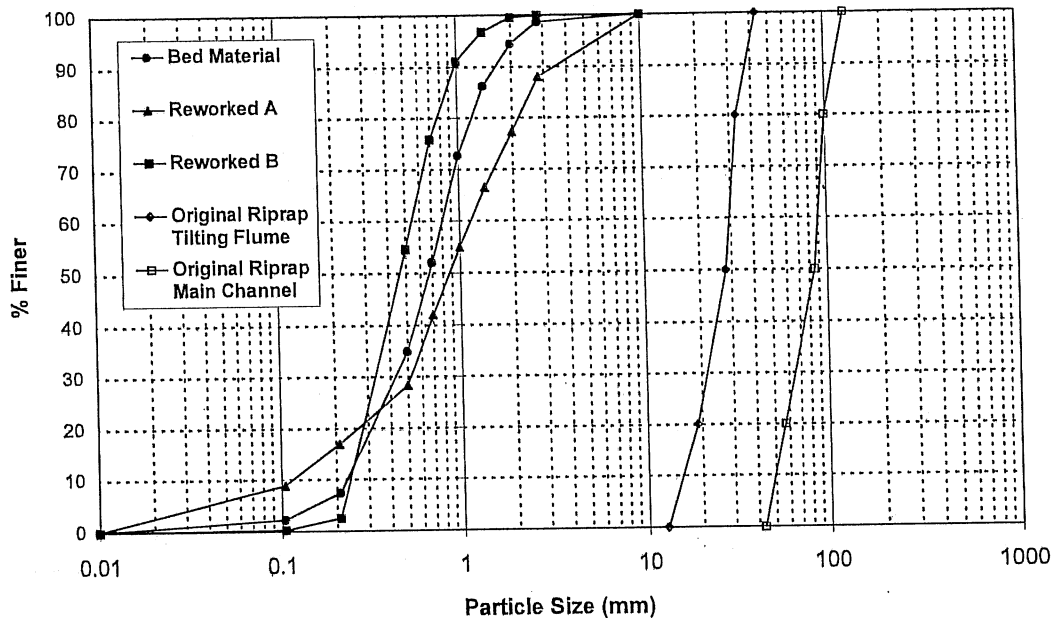


Figure 3.5. Grain size distributions of the sediment and riprap.

Riprap was constructed from the same highly angular crushed limestone quarry run that is commonly used as riprap by the Minnesota Department of Transportation. This material has a specific gravity close to 2.7. Sizing was done using the relations of Parola (1991) and Quazi and Peterson (1973). The original size distribution is given in graphical form in Figure 3.5, and in tabular form in Table 3.3a (Main Channel) and Table 3.3b (Tilting Flume); the median riprap size  $D_{r50}$  was 3.1 in (79.5 mm) and 1.1 in (26.9 mm), respectively. It was found that this original distribution was too coarse to allow for consistent failure due to entrainment at the highest flows of the experiments. In order to ensure that this condition could be studied, the riprap was reconstituted using the finer two-grain size ranges in each case. The reconstituted median size of the riprap,  $D_{r50}$ , was 2.1 in (53.8 mm) in the Main Channel and 0.85 in (21.6 mm) in the Tilting Flume. The first two sets of experiments on riprap in the Tilting Flume were done using the original coarse riprap; the rest were done using the modified riprap. All of the riprap experiments in the Main Channel were done using the modified riprap. More details concerning the selection of experimental riprap size are given in the section, Run Protocol.

**Table 3.3a.** Grain size distribution of the original riprap for the Main Channel

Size Interval (mm)	Size Interval (in)	% Mixture
128 to 100	5 to 4	20
100 to 90	4 to 3-1/2	20
90 to 64	3-1/2 to 2-1/2	30
64 to 45	2-1/2 to 1-3/4	30

**Table 3.3b.** Grain size distribution of the original riprap for the Tilting Flume.

Size Interval (mm)	Size Interval (in)	% Mixture
45 to 32	1-3/4 to 1-1/4	30
32 to 25	1-1/4 to 1	27
25 to 19	1 to 3/4	23
19 to 12	3/4 to 1/2	20

Note that in addition to flume geometry, the 1:3 scale ratio is approximately maintained in the riprap as well. The size of the ambient bed sediment was, however, not scaled down from the Main Channel to the Tilting Flume. Doing so would have placed some of the runs in the Tilting Flume in the ripple regime, one that does not occur in the field during floods.

### 3.4 RUN PROTOCOL

The basis for the run protocol are a) the Engelund-Hansen (1972) relations for sediment transport and resistance in sand-bed streams and b) the relation due to Melville (1997) for the critical average flow velocity at the onset of sediment transport. The Engelund-Hansen relation for flow resistance over a sand bed under lower-regime conditions takes the form

$$\tau_s^* = 0.06 + 0.04(\tau^*)^2 \quad (3.1)$$

where under steady, uniform (normal) flow conditions the dimensionless Shields stress  $\tau^*$  and the portion of the Shields stress due to skin friction  $\tau_s^*$  are given by

$$\tau^* = \frac{v_o S_w}{\left(\frac{\rho_s}{\rho} - 1\right) d_{50}} \quad \tau_s^* = \frac{v_{os} S_w}{\left(\frac{\rho_s}{\rho} - 1\right) d_{50}} \quad (3.2a,b)$$

where  $y_o$  denotes the flow depth associated with normal flow,  $y_{os}$  denotes that portion of the depth associated with skin friction,  $d_{50}$  denotes the median size of the ambient sediment,  $\rho_s$  denotes the density of

the ambient sediment,  $\rho$  denotes the density of water, and  $S_w$  denotes the water surface slope, which equals the bed slope for normal flow. The Engelund-Hansen form of the relation for skin friction takes the form

$$\frac{U}{U_{*s}} = 2.5 \ln \left( 11 \frac{y_{os}}{2.5d_{50}} \right) \quad u_{*s} = \sqrt{gy_{os}S_w} \quad (3.3a,b)$$

where  $U$  denotes the depth-averaged flow velocity,  $u_{*s}$  denotes the shear velocity associated with skin friction and  $g$  denotes the acceleration of gravity.

The Melville (1997) relations for depth-averaged flow velocity at the threshold of motion can be written as

$$\frac{U_c}{U_{*c}} = 2.5 \ln \left( 11.06 \frac{y_{oc}}{2d_{50}} \right) \quad (3.4)$$

where  $u_{*c}$  denotes the critical shear velocity for the onset of motion of the ambient sediment,  $U_c$  denotes the associated critical depth-averaged velocity of flow,  $y_{oc}$  denotes the depth at the threshold of motion and

$$\frac{u_{*c}^2}{\left( \frac{\rho_s}{\rho} - 1 \right) g d_{50}} = \frac{y_{oc} S_w}{\left( \frac{\rho_s}{\rho} - 1 \right) d_{50}} = \tau_c^* = f(R_{ep}) \quad R_{ep} = \frac{\sqrt{\left( \frac{\rho_s}{\rho} - 1 \right) g d_{50} d_{50}}}{\nu} \quad (3.5a,b)$$

In the above relations  $\tau_c^*$  denotes the critical Shields stress for the onset of motion,  $R_{ep}$  denotes a particle Reynolds number and  $\nu$  denotes the kinematic viscosity of the water. The function  $f(R_{ep})$  denotes the standard Shields curve for the onset of sediment motion; Melville (1997) provides analytical approximations for the curve for the case of sediment with a specific gravity of 2.65 in clean water at a temperature of 20° C.

In setting run protocol the design water surface slope  $S_w$  in the Main Channel was set equal to 0.002. As noted above, the Tilting Flume and the bridge piers within it are designed to be a precise 1:3 geometrical model of the Main Channel. The fact that the ambient bed sediment itself is not scaled down, however, means that the design slope in the Tilting Flume must be greater than in the Main Channel. A design value of  $S_w$  of 0.004 was determined in the Tilting Flume by means of an approximate match of flow Froude number between the two flumes, so as to obtain approximate dynamical similarity as well. Flow Froude number  $Fr$  is given by

$$Fr = \frac{U}{\sqrt{gy_o}} \quad (3.6)$$

Critical flow velocities  $U_c$  at these slopes were determined from the Melville (1997) relations. The initial calculations were done with a value of  $d_{50}$  of 0.7 mm. As noted above, this estimate was later revised to 0.5 mm due to mixing with sediment from the Mississippi River. The revised values of  $U_c$  are the ones used in subsequent sections of this chapter.

**Table 3.4.** Computed values of  $U_c$

Flume	Design $S_w$	Original $U_c$ (m/s)	Revised $U_c$ (m/s)
Main Channel	0.002	0.238	0.203
Tilting Flume	0.004	0.205	0.175

Based on the maximum attainable flow depths in the two flumes, four flow conditions were designed for the Main Channel (M1 – M4) as well as four corresponding conditions for the Tilting Flume (T1 – T4). Condition T1 was chosen to correspond to condition M1 etc. These four conditions are

intended to correspond to several points on a flood hydrograph of a river. Design water discharge  $Q$ , flow depth  $y_o$ , flow velocity  $U$ , Shields stress  $\tau^*$ , Froude number  $Fr$  and sediment transport rate  $Q_s$  are given in Table 3.5a for the Main Channel and Table 3.5b for the Tilting Flume. The calculations were done for an assumed value of  $d_{50}$  of 0.7 mm.

**Table 3.5a.** Design flow conditions for the Main Channel:  $d_{50} = 0.7$  mm

Parameter	Depth $y_o$ (m)	Velocity $U$ (m/s)	$U/U_c$	Discharge $Q$ (m <sup>3</sup> /s)	$Fr$	$\tau^*$	$Q_s$ (kg/min)
Critical	0.0186	0.24	1.00	0.0122	0.56	0.032	0
Run 1	0.150	0.45	1.90	0.186	0.37	0.26	3.85
Run 2	0.300	0.70	2.94	0.576	0.41	0.52	26.2
Run 3	0.450	1.03	4.33	1.27	0.49	0.78	103
Run 4	0.600	1.40	5.87	2.30	0.58	1.04	297

**Table 3.5b.** Design flow conditions for the Tilting Flume:  $d_{50} = 0.7$  mm

Parameter	Depth $y_o$ (m)	Velocity $U$ (m/s)	$U/U_c$	Discharge $Q$ (m <sup>3</sup> /s)	$Fr$	$\tau^*$	$Q_s$ (kg/min)
Critical	0.0093	0.21	1.00	0.00179	0.70	0.032	0
Run 1	0.05	0.35	1.71	0.016	0.50	0.17	0.42
Run 2	0.10	0.46	2.24	0.042	0.47	0.35	2.1
Run 3	0.15	0.62	3.02	0.086	0.51	0.52	7.0
Run 4	0.20	0.82	4.00	0.150	0.58	0.69	18.4

In order to execute the above flows in the Tilting Flume, the sediment feed rate and water discharge were set to the design values and the flow allowed to equilibrate. In the Main Channel calibration runs were determined to find the correct tailgate setting for each desired flow condition. Upon calibration the flow discharge and tailgate elevations were set to the appropriate values and the flow allowed to equilibrate.

As noted above, the sediment ultimately became finer in the course of the experiments. The prevailing value of  $d_{50}$  for most of the experiments was closer to 0.5 mm. The calculated design flow conditions with this grain size that were consonant with the water discharges used in flume operation are shown below. As can be seen, the modification is not large.

**Table 3.6a.** Design flow conditions for the Main Channel:  $d_{50} = 0.5$  mm

Parameter	Depth $y_o$ (m)	Velocity $U$ (m/s)	$U/U_c$	Discharge $Q$ (m <sup>3</sup> /s)	$Fr$	$\tau^*$	$Q_s$ (kg/min)
Critical	0.013	0.20	1.00	0.00713	0.56	0.032	0
Run 1	0.150	0.45	2.22	0.186	0.37	0.36	5.5
Run 2	0.279	0.75	3.69	0.576	0.45	0.68	38.1
Run 3	0.410	1.13	5.57	1.27	0.57	0.99	152
Run 4	0.543	1.55	7.64	2.30	0.67	1.32	437

Table 3.6b. Design flow conditions for the Tilting Flume:  $d_{50} = 0.5$  mm

Parameter	Depth $y_o$ (m)	Velocity $U$ (m/s)	$U/U_c$	Discharge $Q$ ( $m^3/s$ )	Fr	$\tau^*$	$Q_s$ (kg/min)
Critical	0.0067	0.17	1.00	0.00104	0.66	0.032	0
Run 1	0.052	0.33	1.88	0.016	0.46	0.25	0.57
Run 2	0.096	0.48	2.74	0.042	0.49	0.47	2.97
Run 3	0.139	0.67	3.83	0.086	0.58	0.67	10.1
Run 4	0.183	0.90	5.14	0.150	0.67	0.89	27.1

The actual flow conditions realized in operations the flumes at Runs 1 – 4 differed somewhat from realization to realization due to impossibility of precisely repeating each condition. This comment notwithstanding, the above tables provide a good idea of the range of conditions covered. Two points are relevant in this regard.

- All of the runs are well into the range of mobile bed (live bed) conditions. These conditions, with their associated bedforms, allow the experiments to provide a reasonable model of mobile-bed rivers in the field.
- The highest Shields stresses are in excess of unity. This places the highest flow conditions in the range of measured bankfull flows in sand-bed streams (Parker et al., 1998). The highest values of  $\tau^*$  and  $U/U_c$  are among the highest ever achieved experimentally in studies of bridge scour (Melville, 1997).

The experiments reported in this section have thus been designed so as to provide models of field conditions in sand-bed streams.

The riprap placed around the bridge piers was designed in accordance with the relations of Quazi and Peterson (1973) and Parola and Jones (1990) (see also the work of Parola, 1993). These relations take the respective forms

$$N_{sc} = 1.14 \left( \frac{D_r}{y_o} \right)^{-0.20} \quad N_{sc} = \frac{2.89}{K^2} \quad (3.7a,b)$$

where

$$N_{sc} = \frac{U_{rc}^2}{\left( \frac{\rho_r}{\rho} - 1 \right) g D_r} \quad (3.8)$$

In the above relations  $U_{rc}$  denotes a critical average flow velocity to move the riprap,  $\rho_r$  denotes riprap density, and  $D_r$  denotes a characteristic riprap size (here taken to be the median size  $D_{r50}$ ). The Quazi-Peterson relation applies to round-nose piers; in the relation of Parola and Jones  $K$  is a parameter taking a value of 1.5 for a round-nose pier and 1.7 for a square-nose pier.

The riprap was sized in accordance with run protocol, so that it would not fail by direct entrainment into the flow at the conditions of Runs 1, 2 and 3, but would be entrained by the flow at Run 4. As noted above, it was necessary to modify the riprap by making it finer in order to ensure failure at the conditions of Run 4. The table below shows a) the values of  $D_{r50}$  for incipient failure at Runs 3 and 4 from Eq. (3.7a); the same values computed from Eq. (3.7b) with  $K = 1.5$ ; c) the original value of  $D_{r50}$  for the experimental riprap and d) the modified value of  $D_{r50}$  for the experimental riprap, both for the Main Channel and the Tilting Flume. Note that the value of  $D_{r50}$  of the modified riprap has been chosen so that neither of the above equations predicts failure at Run 3, but both predict failure at Run 4. This behavior was verified experimentally. The experiments actually employed the modified riprap for the great majority of the experiments. This riprap became the standard riprap for the experimental program.

Table 3.7. Experimental riprap sizes

Parameter	Main Channel	Tilting Flume
$D_{r50}$ , incipient failure, Run 3, Eq. (3.7a)	32.7 mm	12.4 mm
$D_{r50}$ , incipient failure, Run 3, Eq. (3.7b)	49.1 mm	18.2 mm
$D_{r50}$ , incipient failure, Run 4, Eq. (3.7a)	66.0 mm	22.8 mm
$D_{r50}$ , incipient failure, Run 4, Eq. (3.7b)	91.1 mm	31.2 mm
$D_{r50}$ , original experimental value	79.5 mm	26.9 mm
$D_{r50}$ , modified experimental value	53.8 mm	21.6 mm

It is of value to note that with the modified riprap, the ratio  $D_{r50}/d_{50}$  was 77 or more in the Main Channel and 31 or more in the Tilting Flume. That is, the unit size of the countermeasure was large compared to the ambient bed material. Similar large values were obtained for the other armoring countermeasures studied in this chapter.

It proved impossible to set a sediment feed rate in the Tilting Flume that was low enough to replicate Run 1. As a result, this run condition was omitted from the run protocol for the Tilting Flume. The run was occasionally performed in the Main Channel. Since this run condition is nearest to the clear water scour condition, a condition that is already well known, it was excluded from the study of mobile bed (live bed) scour.

Most countermeasures were studied by sequentially performing runs at conditions 2, 3 and 4, i.e. Runs 2, 3 and 4. In so far as the flow conditions were chosen so as to keep bed slope approximately constant in progressing from run to run, the time for equilibration of the flow was essentially that associated with bedform development. In the Tilting Flume, the standard run duration  $T_d$  was 5 hours for Run 2, 2 hours for Run 3 and 0.75 hours for Run 4. In the Main Channel,  $T_d$  was initially set to 8 hours for all runs; as experience was gained this value was reduced for runs at higher discharges. Deviation from this protocol was made in the course of the experiments as indicated by previous results. In many cases a run at a given flow condition was continued after evaluating scour conditions. In such cases, the experiments in a given series may be labeled as e.g. Run 3a, 3b, 3c and 3d.

The rectangular pier in both the Main Channel and Tilting Flume could be rotated. This notwithstanding, none of the results reported here pertain to a skewed angle of attack relative to the mean flow direction in the flume. The presence of well developed three-dimensional dunes, however, caused the local angle of attack of the flow to vary erratically by as much as  $20^\circ$  one way or the other as each dune migrated past the pier. This effect was particularly pronounced in the vicinity of the rectangular pier, where the dunes were better developed.

### 3.5 SUMMARY OF RUNS PERFORMED AT ST. ANTHONY FALLS LABORATORY

The experiments performed at SAFL cover a wide range of countermeasures, with 79 scour tests done in the Main Channel and 98 done in the Tilting Flume. They are enumerated in summary form below. A complete list of the experimental data collected for each experiment is given in Appendix A. Values for the following parameters are listed therein: run duration  $T_d$ , water surface slope  $S_w$ , ambient depth  $y_o$ , ambient cross-sectional averaged flow velocity  $U$ , the ratio  $U/U_o$ , maximum scour depth  $d_s$ , the ratio  $d_s/D$ , the ratio  $d_s/d_{s0}$  and the fraction reduction in scour depth associated with a given countermeasure  $r_s$ , given by

$$r_s = 1 - \frac{d_s}{d_{s0}} \quad (3.9)$$

where  $d_{s0}$  denotes the scour depth in the absence of any protection. In the table,  $r_s$  is expressed in percent. In a few cases measured scour depth was negative, usually implying that the countermeasure never settled to the ambient elevation of the erodible bed. For such cases  $r_s$  is always set equal to 100% in the table.

**Calibration runs** were performed in the Main Channel to verify the ability to set the desired flows. These runs had no bridge piers and no scour protection. The run series is designated MC-NP0.

**Runs with no protection.** Two duplicate sets of such runs were performed in the Tilting Flume and two more duplicate sets were performed in the Main Channel. These runs allowed for the determination of the scour depth  $d_{s0}$  prevailing in the absence of any protection. The run series are TF-NP1, TF-NP2, MC-NP1 and MC-NP2.

**Runs with the original coarse riprap.** Two duplicate sets of these runs were performed in the Tilting Flume. The bed was excavated before installing the riprap. No geotextile filter was used. The results of these runs dictated modifying the riprap so as to obtain failure at Run 4. The run series are TF-RR1 and TR-RR2.

**Runs with the standard (modified) riprap.** These are series MC-RNG in the Main Channel and TF-RNG in the Tilting Flume. The bed was excavated before installing the riprap; no geotextile filter was used.

**Runs with riprap and partial geotextile filter.** In these and all subsequent runs using riprap the standard (modified) riprap was used. The bed was excavated in these runs, and a geotextile filter placed before installing the riprap. The geotextile filter did not extend as far out from the bridge pier as the riprap; hence the terminology "partial". A full geotextile filter coverage was not used in any of the SAFL experiments, due to poor performance documented at the University of Auckland. The relevant series are MC-RPG in the Main Channel and TF-RPG in the Tilting Flume. A short set of runs in the Main Channel, series MC-RPL documents a placement of the geotextile filter under conditions representative of the field.

**Runs with dumped riprap.** In these runs no prior excavation of the bed was made. The bed was smoothed and a partial geotextile filter placed over it. The riprap was then dumped on top. The experiments were performed in the Main Channel as series MC-RNX.

**Runs to test geotextile filter placement.** In these runs a technique was developed to install a geotextile filter over a bed covered with flowing water.

**Runs with cable tied blocks.** Mattresses of cable tied blocks were used for these experiments. Series TF-CB was performed in the Tilting Flume without the use of a geotextile filter. Series MC-CB1, MC-CB2 and MC-CB3 were performed in the Main Channel with a partial geotextile filter below the block mattress.

**Runs with grout filled bags.** These runs were performed in the Main Channel as series MC-GB1, MC-GB2, MC-GB3, MC-GB4, MC-GB5 and MC-GB6. A partial geotextile filter was always placed below the grout filled bags. In the final series of runs the bags were stitched to the geotextile filter.

**Runs with permeable sheet piles.** The sheet piles acted as submerged permeable dikes placed in front of the piers. The runs were performed in the Tilting Flume as series TF-SP1 and TF-SP2.

**Runs with pier attached vanes.** These runs were performed in the Tilting Flume as series TF-PV1 and TF-PV2.

**Combination runs with cable tied blocks and riprap.** These runs were performed with a partial geotextile filter. They correspond to series MC-CMB in the main channel.

**Combination runs with permeable sheet piles and riprap.** For these runs, a permeable sheet pile was placed upstream of the pier, and the pier was protected with riprap underlain by a partial geotextile filter. They correspond to series TF-CMB in the Tilting Flume.

### 3.6 EXPERIMENTAL RESULTS

#### 3.6.1 Calibration Runs

These runs were performed solely in the Main Channel. Their purpose was to verify whether or not it was possible to achieve the design conditions outlined in Tables 3.5a and 3.6a. With this in mind, neither piers nor protection were installed. The complete data are given in Table 1 of Appendix A. The results are summarized in Table 3.8 below.

**Table 3.8.** Results for calibration runs in the Main Channel

Calibration run: no piers				
Flume:		Main channel		
Data set:		MC-NP0		
Run	$y_o$ (m)	$U_c$ (m/s)	U (m/s)	$U/U_c$
1	0.150	0.203	0.453	2.232
2	0.300	0.203	0.700	3.450
3	0.450	0.203	1.027	5.063
4	0.600	0.203	1.398	6.896

It is useful to compare the experimental values of  $U/U_c$  listed above to those listed in Tables 3.5a and 3.6a. It is seen that the design values were achieved experimentally within a reasonable degree of accuracy.

#### 3.6.2 Runs with No Protection

Both the circular and rectangular piers were installed for these runs. Two duplicate sets were performed in the Tilting Flume and two more duplicate sets were performed in the Main Channel: they are series TF-NP1, TF-NP2, MC-NP1 and MC-NP2. These runs allowed for the determination of the maximum time averaged scour depth  $d_{so}$  prevailing in the absence of any protection. The essential results are reported below in Tables 3.9a – 3.9d (Main Channel) and Tables 3.10a – 3.10d (Tilting Flume).

**Table 3.9a.** Results for circular pier with no protection in the Main Channel: series MC-NP1

Calibration run: no protection						
Flume:		Main channel				
Data set:		MC-NP1				
Pier type:		Circular				
Run	$y_o$ (m)	$U_c$ (m/s)	U (m/s)	$U/U_c$	$d_{so}$ (m)	$d_{so}/D$
2	0.354	0.203	0.593	2.926	0.218	0.715
3	0.482	0.203	0.958	4.725	0.343	1.126
4	0.677	0.203	1.240	6.114	0.435	1.426



Table 3.9b. Results for rectangular pier with no protection in the Main Channel: series MC-NP1

Calibration run: No protection						
Flume: Main channel						
Data set: MC-NP1						
Pier type: Rectangular						
Run	$y_o$ (m)	$U_c$ (m/s)	U (m/s)	$U/U_c$	$d_{so}$ (m)	$d_{so}/D$
2	0.323	0.203	0.649	3.199	0.343	1.124
3	0.486	0.203	0.951	4.690	0.451	1.481
4	0.669	0.203	1.253	6.181	0.604	1.982

Table 3.9c. Results for circular pier with no protection in the Main Channel: series MC-NP2

Calibration run: no protection						
Flume: Main channel						
Data set: MC-NP2						
Pier type: Circular						
Run	$y_o$ (m)	$U_c$ (m/s)	U (m/s)	$U/U_c$	$d_{so}$ (m)	$d_{so}/D$
2	0.414	0.203	0.507	2.502	0.171	0.560
3	0.595	0.203	0.776	3.827	0.217	0.713
4	0.787	0.203	1.066	5.257	0.311	1.022

Table 3.9d. Results for rectangular pier with no protection in the Main Channel: series MC-NP2

Calibration run: no protection						
Flume: Main channel						
Data set: MC-NP2						
Pier type: Rectangular						
Run	$y_o$ (m)	$U_c$ (m/s)	U (m/s)	$U/U_c$	$d_{so}$ (m)	$d_{so}/D$
2	0.399	0.203	0.525	2.591	0.334	1.097
3	0.560	0.203	0.826	4.072	0.378	1.239
4	0.753	0.203	1.114	5.491	0.474	1.557

**Table 3.10a. Results for circular pier with no protection in the Tilting Flume: series TC-NP1**

<i>Calibration run: no protection</i>						
<b>Flume:</b>		<i>Tilting flume</i>				
<b>Data set:</b>		<i>TF-NP1</i>				
<b>Pier type:</b>		<i>Circular</i>				
Run	$y_o$ (m)	$U_c$ (m/s)	U (m/s)	$U/U_c$	$d_{so}$ (m)	$d_{so}/D$
2	0.100	0.175	0.536	3.068	0.100	0.987
3	0.150	0.175	0.860	4.925	0.102	1.008
4b	0.200	0.175	1.094	6.261	0.147	1.442

**Table 3.10b. Results for rectangular pier with no protection in the Tilting Flume: series TC-NP1**

<i>Calibration run: no protection</i>						
<b>Flume:</b>		<i>Tilting flume</i>				
<b>Data set:</b>		<i>TF-NP1</i>				
<b>Pier type:</b>		<i>Rectangular</i>				
Run	$y_o$ (m)	$U_c$ (m/s)	U (m/s)	$U/U_c$	$d_{so}$ (m)	$d_{so}/D$
2	0.100	0.175	0.536	3.068	0.152	1.492
3	0.150	0.175	0.860	4.925	0.157	1.542
4b	0.200	0.175	1.094	6.261	0.193	1.904

**Table 3.10c. Results for circular pier with no protection in the Tilting flume: series TC-NP2**

<i>Calibration run: no protection</i>						
<b>Flume:</b>		<i>Tilting flume</i>				
<b>Data set:</b>		<i>TF-NP2</i>				
<b>Pier type:</b>		<i>Circular</i>				
Run	$y_o$ (m)	$U_c$ (m/s)	U (m/s)	$U/U_c$	$d_{so}$ (m)	$d_{so}/D$
2	0.112	0.175	0.478	2.736	0.102	1.005
3	0.195	0.175	0.661	3.783	0.122	1.203
4	0.257	0.175	0.850	4.865	0.136	1.342

**Table 3.10d. Results for rectangular pier with no protection in the Tilting Flume: series TC-NP2**

<i>Calibration run: no protection</i>						
<b>Flume:</b>		<i>Tilting flume</i>				
<b>Data set:</b>		<i>TF-NP2</i>				
<b>Pier type:</b>		<i>Rectangular</i>				
Run	$y_o$ (m)	$U_c$ (m/s)	U (m/s)	$U/U_c$	$d_{so}$ (m)	$d_{so}/D$
2	0.117	0.175	0.457	2.616	0.145	1.429
3	0.186	0.175	0.693	3.965	0.195	1.916
4	0.246	0.175	0.890	5.097	0.212	2.082

### Scour at Circular Piers

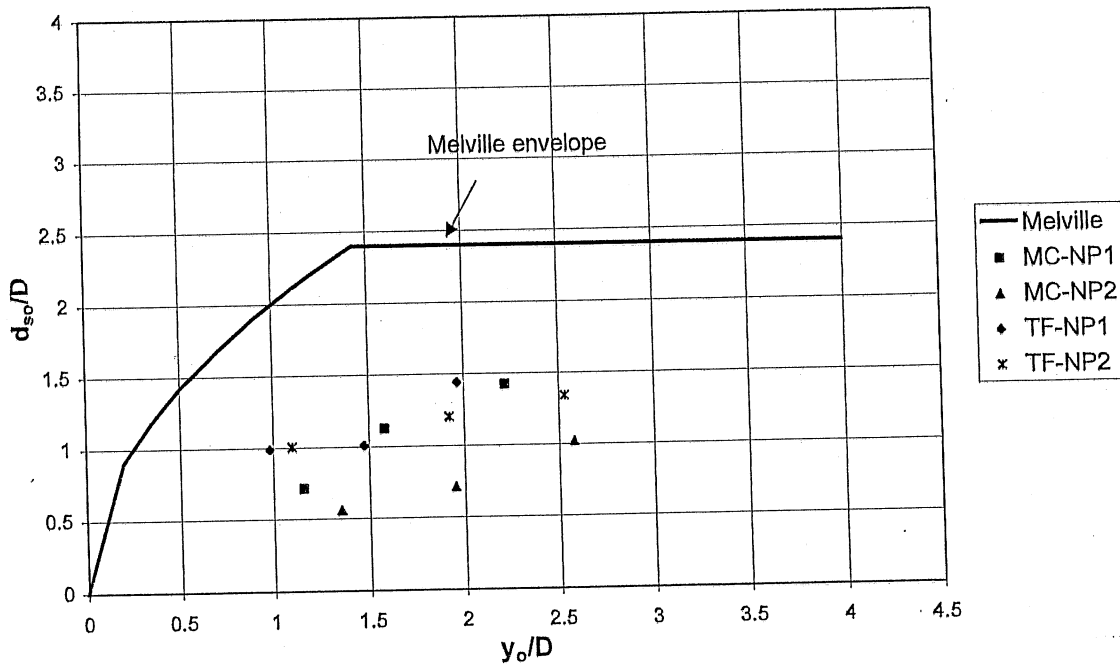


Figure 3.6a. Results for unprotected scour at circular piers.

Melville (1997) provides a set of relations for predicting an envelope of maximum scour depth as a function of a variety of parameters. A perusal of those relations suggests that for each pier type (circular and rectangular) the only parameter that should limit the envelope from achieving its maximum values of dimensionless scour depth  $d_{so}/D$  in the absence of protection of 2.4 (circular pier) and 2.64 (rectangular pier) should be the ratio of depth to pier width  $y_o/D$ . Figures 3.6a and 3.6b show plots of  $d_{so}/D$  versus  $y_o/D$  for the circular and rectangular pier data, respectively. Also shown are the envelopes due to Melville.

It can be seen in both figures above that the maximum scour depths obtained in the course of the present experiments were all below the envelope of Melville. Recall that an envelope describes the maximum scour observed among all studies, not typical values. The results thus fall within the rubric of many previous scour studies. The figures suggest that the scour realized at flow condition 2 was reduced below its asymptotic value by the relatively small ratio  $y_o/D$  of depth to pier width. No such limitation is apparent for flow conditions 3 and 4.

All the data in the figures above intermingle with each other, indicating that the scour depths are statistically repeatable. The only exception consists of the results for Run MC-NP2, all of which show rather low scour depths. The reason for this is unclear.

The unprotected scour depth  $d_{so}$  as defined at the beginning of this chapter represents the maximum average scour depth below the mean elevation of the bed. This is the appropriate value to use in the Melville (1997) formulation. The Colorado State University predictor for maximum scour depth at unprotected piers is given in HEC-18 (Richardson et al., 1992). The scour depth it predicts is not  $d_{so}$ , but rather  $d_{so} + \Delta$ , where  $\Delta$  denotes bedform height. This parameter can be computed from the values of  $d_{so}$  in Tables 3.9a – 3.10d and the dune heights given in Table 3.12. A comparison of the data against the Colorado State University predictor is given in Figure 3.6c. In that figure RM denotes the rectangular pier in the main channel, RT denotes the rectangular pier in the tilting flume, CM denotes the circular pier in the main channel and CT denotes the circular pier in the tilting flume. The comparison between the observed and predicted values is generally good, but scour depths are overpredicted in the case of the

circular pier in the Main Channel. This is likely because dunes were insufficiently developed at this point, as discussed subsequently.

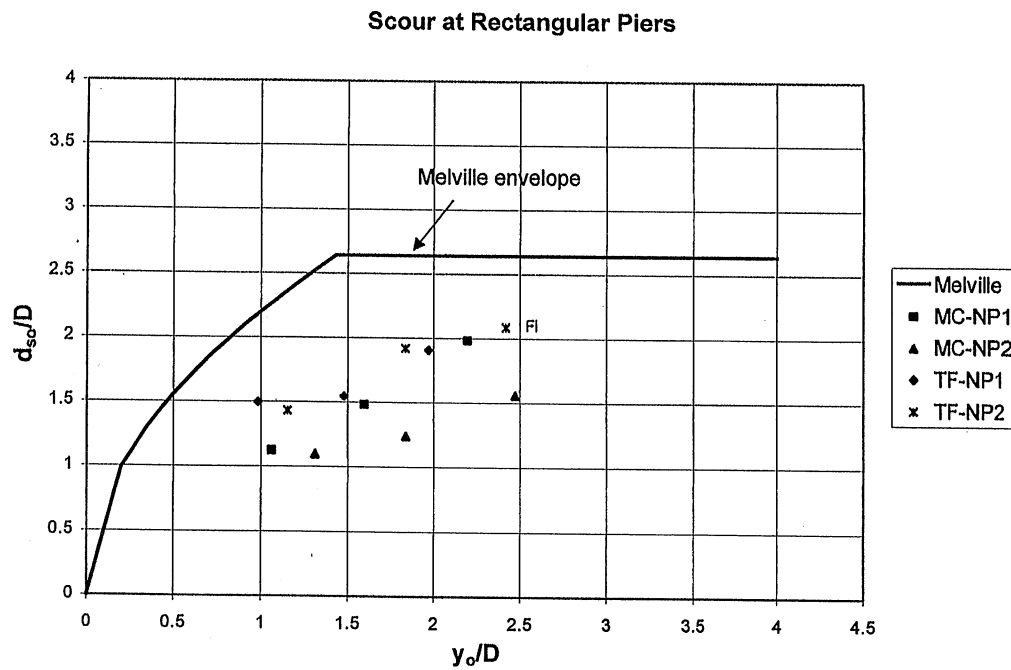


Figure 3.6b. Results for unprotected scour at rectangular piers.

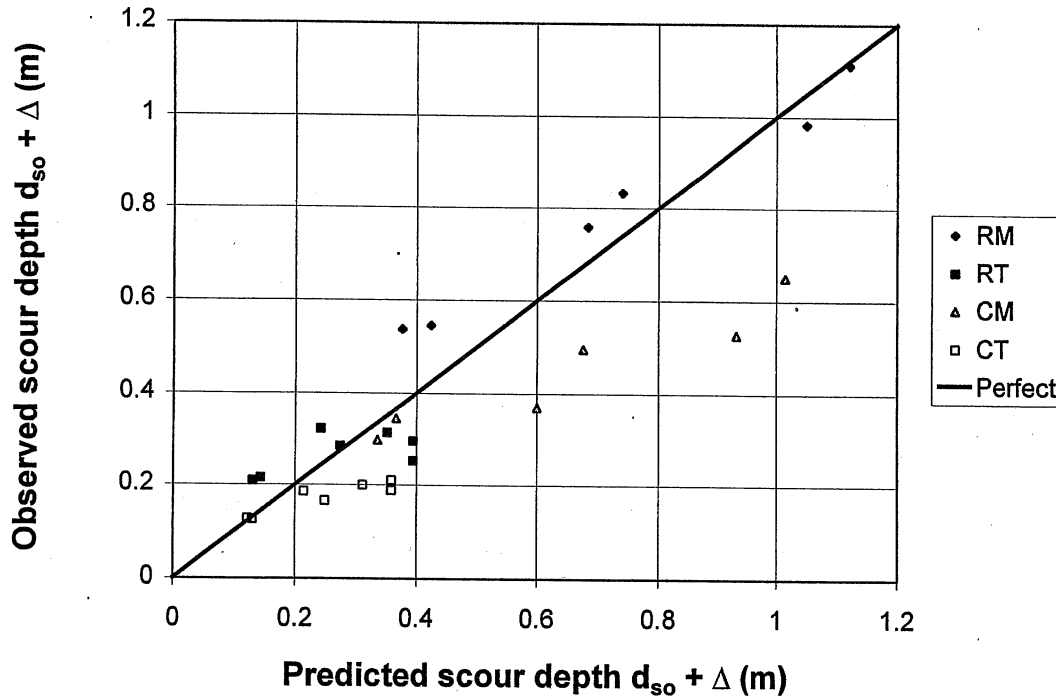


Figure 3.6c. Comparison of the data for unprotected scour with the Colorado State University predictor.

In none of the above experiments did the inerodible bed below the sediment become exposed. There were essentially no restrictions on scour depth. The above data were averaged over the two duplicate runs in order to determine standard expected depths of maximum scour in the absence of protection. These values, listed in Tables 3.11a – 3.11d, were used as the basis for comparison when evaluating the percent reduction in scour  $r_s$  achieved by any given countermeasure.

Table 3.11a. Standard unprotected scour depths for a circular pier in the Main Channel

Standard scour depths with no protection			
Flume: <i>Main channel</i>			
Data Set: <i>MC-NP1 and MC-NP2</i>			
Pier type: <i>Circular</i>			
Run	$U/U_c$	$d_{so}$ (m)	$d_{so}/D$
2	2.714	0.194	0.637
3	4.276	0.280	0.920
4	5.685	0.373	1.224

Table 3.11b. Standard unprotected scour depths for a rectangular pier in the Main Channel

Standard scour depths with no protection			
Flume: <i>Main channel</i>			
Data Set: <i>MC-NP1 and MC-NP2</i>			
Pier type: <i>Rectangular</i>			
Run	$U/U_c$	$d_{so}$ (m)	$d_{so}/D$
2	2.895	0.339	1.111
3	4.381	0.414	1.360
4	5.836	0.539	1.770

Table 3.11c. Standard unprotected scour depths for a circular pier in the Tilting Flume

Standard scour depths with no protection			
Flume: <i>Tilting flume</i>			
Data Set: <i>Y=TF-NP1 and TF-NP2</i>			
Pier type: <i>Circular</i>			
Run	$U/U_c$	$d_{so}$ (m)	$d_{so}/D$
2	2.902	0.101	0.996
3	4.354	0.112	1.106
4	5.563	0.141	1.392

Table 3.11d. Standard unprotected scour depths for a rectangular pier in the Tilting Flume

Standard scour depths with no protection			
Flume:	Tilting flume		
Data Set:	Y=TF-NP1 and TF-NP2		
Pier type:	Rectangular		
Run	$U/U_c$	$d_{so}$ (m)	$d_{so}/D$
2	2.842	0.148	1.461
3	4.445	0.176	1.729
4	5.679	0.203	1.993

A view of the circular pier at the end of Run 4 of series TC-NP1 in the Tilting Flume is shown as Figure 3.7a; the corresponding view of the rectangular pier is shown as Figure 3.7b. Both deep scour near the pier and a prominent pattern of dunes are apparent in the figures. These bedforms were also prominent in the Main Channel. They merit more discussion below in the context of riprap stability.

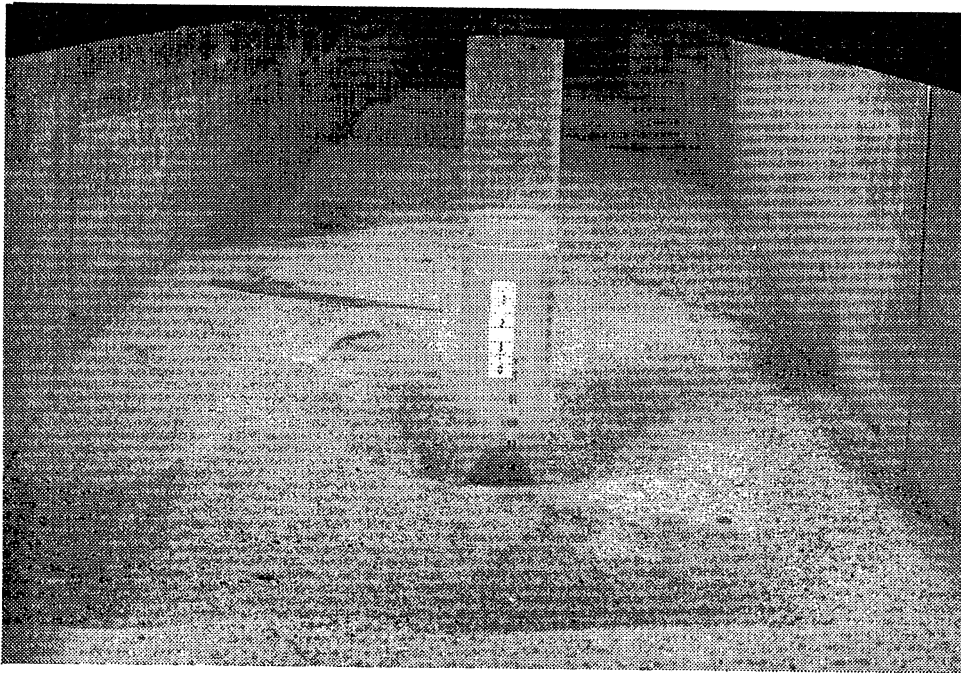
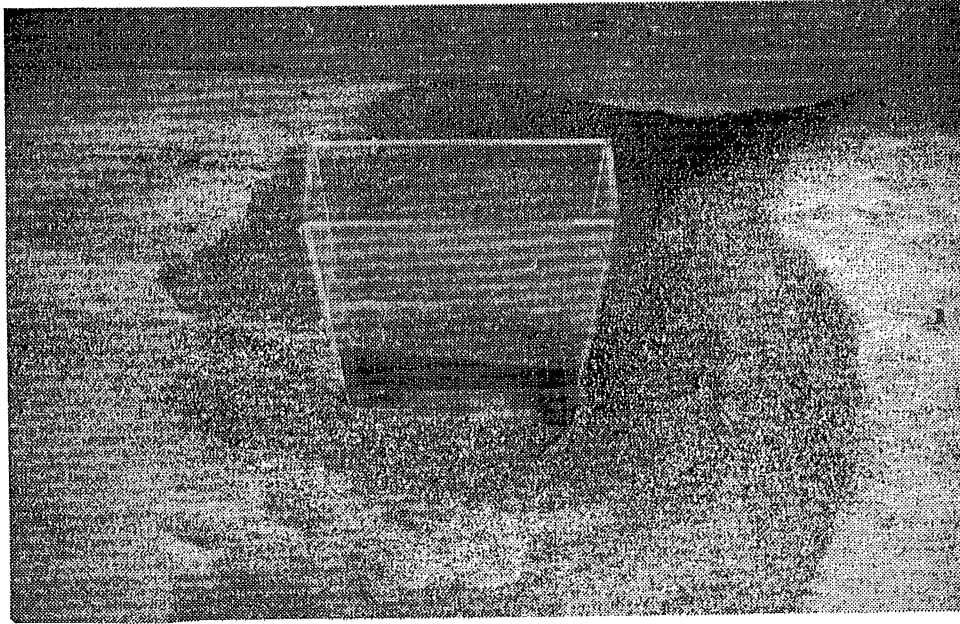


Figure 3.7a. View of the Tilting Flume at the end of Run 4 of TC-NP1, showing prominent dunes and scour near the circular pier.



**Figure 3.7b.** View of the Tilting Flume at the end of Run 4 of TC-NP1, showing the deep scour realized near the rectangular pier.

It can be seen from Tables 3.11a – 3.11d that scour depths were consistently larger at the rectangular pier than the circular pier. Part of this is ascribable to the more severe flow conditions generated by the sharp edges of the rectangular pier. Another factor, however, seemed to be playing a role, i.e. dune development. The average maximum depth of a scour hole appeared to be deeper where dunes were more prominently developed. With this in mind, data were taken in the course of series MC-NP1 and TF-NP1 in order to quantify dune height  $\Delta$ , here defined as half the distance from trough to crest. The results are presented below in Table 3.12 for both the Main Channel and Tilting Flume. In both cases average dune height was determined in the upstream, middle and downstream portions of each facility.

**Table 3.12.** Dune heights  $\Delta$  for Series MC-NP1 and TC-NP1.

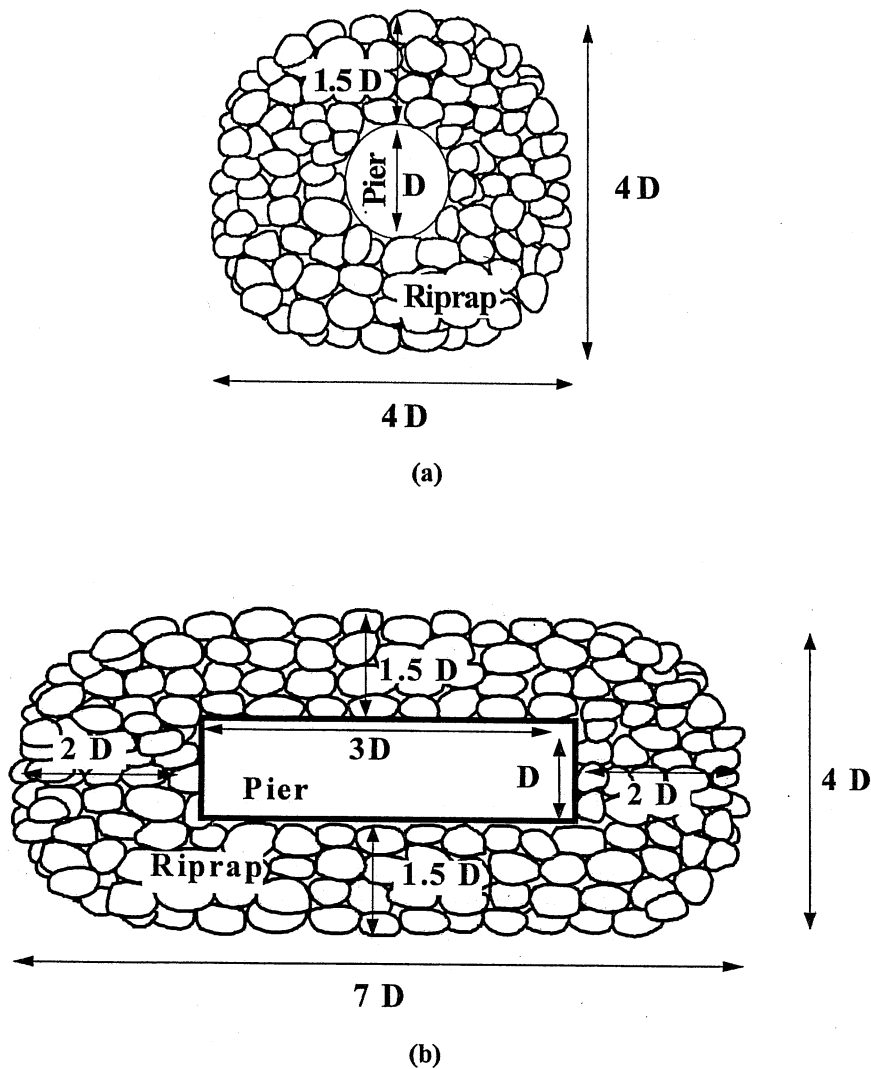
Name	Main Channel (cm)			Tilting Flume (cm)		
	U.S.	MID	D.S.	U.S.	MID	D.S.
Run 1	7.6	7.6	11.4	N/A	N/A	N/A
Run 2	12.7	25.4	20.3	2.5	5.1	6.4
Run 3	15.2	28.0	38.1	6.4	12.7	12.7
Run 4	21.5	31.8	50.8	6.4	8.9	10.2

The above table indicates a general tendency for dune height  $\Delta$  to increase in the downstream direction for nearly all flow conditions. Since the rectangular pier was located downstream of the circular pier, it was affected by larger dune heights. The effect of dunes became particularly evident in terms of the performance of countermeasures, with somewhat better performance generally obtained for the circular pier.

### 3.6.3 Runs with the Original Coarse Riprap

The relevant run series, TF-RR1 and TR-RR2, were performed in the Tilting Flume; they are duplicates of each other. The riprap used was the original coarse riprap with a median size  $D_{r50}$  of 26.9 mm. The bed was excavated before installing the riprap in such a way that the top of the riprap layer was flush with the mean elevation of the bed. This corresponds to a depth of burial  $Y$  of the top of the riprap layer of 0. Experiments conducted at the University of Auckland and reported below consider the case of initially buried riprap with finite values of  $Y$ . No geotextile filter was used.

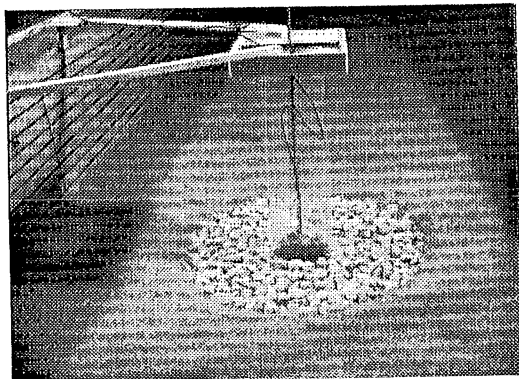
The placement of the riprap as outlined here was standard for all the riprap runs. The thickness of the riprap layer was set equal to  $2 D_{r50}$ . In the case of a circular pier, the riprap formed a circle with a cover diameter  $c = 4 D$ , with the pier in its center. In the case of a rectangular pier, the riprap layer formed a rectangle with rounded edges with a width of cover  $c = 4 D$  in the lateral direction and a length of cover equal to  $7 D$  in the longitudinal direction, with the pier centered in the rectangle. This placement is illustrated below in Figures 3.8a and 3.8b



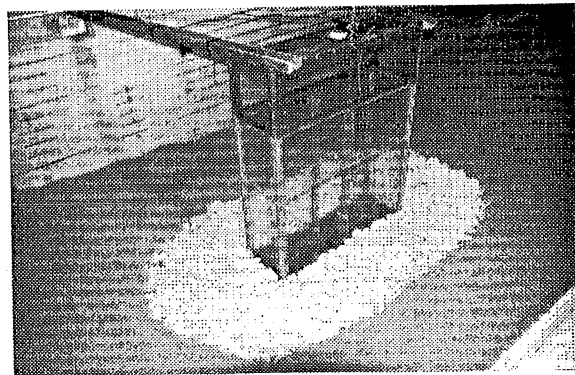
**Figure 3.8.** a) Sketch of placement of riprap around a circular pier. b) Sketch of placement of riprap around a rectangular pier.



The above placement is illustrated below in Figures 3.9 and 3.10 with examples from both the Tilting Flume and the Main Channel. It is not as stringent as that recommended in HEC-18 (Richardson et al., 1992). There it is recommended that the riprap should extend horizontally out a distance of  $2 D$  from any face. Here the corresponding values are  $1.5 D$  in the case of a cylindrical pier and  $1.5 D$  laterally and  $2 D$  longitudinally in the case of a rectangular pier. In HEC-18 it is recommended that the riprap thickness  $t$  be equal to  $3 D_{r50}$ , whereas a thickness of  $2 D_{r50}$  is used here. As outlined subsequently, tests at St. Anthony Falls Laboratory and the University of Auckland justify this less stringent placement as long as a) a geotextile filter is placed below the riprap and b) the bed is excavated prior to riprap placement so that the top of the riprap is flush with the bed. To the extent that adequate protection against scour is realized here, implementation of the placement of HEC-18 would add a margin of safety in most cases.

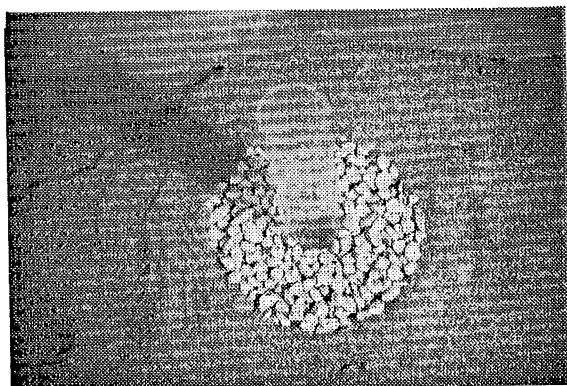


(a)

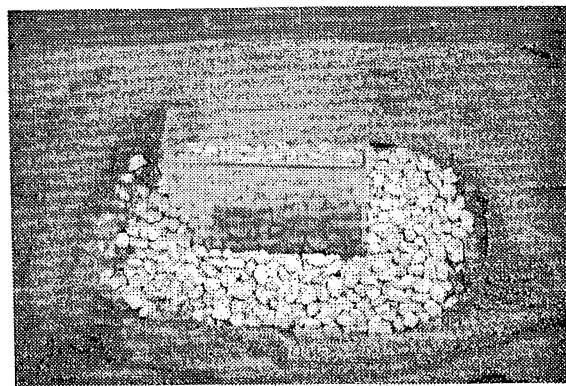


(b)

**Figure 3.9.** a) View of riprap placement around the cylindrical pier in the Main Channel.  
b) View of riprap placement around the rectangular pier in the Main Channel.



(a)



(b)

**Figure 3.10.** (a) View of riprap placement around the cylindrical pier in the Tilting Flume.  
(b) View of riprap placement around the rectangular pier in the Tilting Flume.

As noted above, all the runs using the original riprap were conducted in the Tilting Flume. The measured values of  $U/U_c$  (ratio of flow velocity to critical flow velocity for entrainment of the ambient sediment),  $d_s/D$  (ratio of scour depth to pier width),  $d_s/d_{s0}$  (ratio of scour depth to the prevailing value in the absence of protection) and  $r_s$  (percent reduction in scour depth achieved by the countermeasure) are given in Tables 3.13a and 3.13b for the circular and rectangular pier, respectively of series TF-RR1; the corresponding tables for series TF-RR2 are Tables 3.14a and 3.14b.

**Table 3.13a.** Results of series TF-RR1 for the circular pier

Riprap no. geotextile				
<b>Flume:</b>		Tilting flume		
<b>Data set:</b>		TF-RR1		
<b>Pier type:</b>		Circular		
Run	$U/U_c$	$d_s/D$	$d_s/d_{s0}$	$r_s$
2	3.100	0.304	0.306	69%
3a	4.028	-0.035	-0.032	100%
3b	3.817	-0.165	-0.149	100%
3c	4.165	-0.066	-0.059	100%
3d	4.121	0.005	0.005	100%
4a	5.134	0.800	0.574	43%
4b	5.242	0.129	0.093	91%
4c	5.305	0.277	0.199	80%
4d	4.877	0.673	0.483	52%

**Table 3.13b.** Results of series TF-RR1 for the rectangular pier

Riprap no. geotextile				
<b>Flume:</b>		Tilting flume		
<b>Data set:</b>		TF-RR1		
<b>Pier type:</b>		Rectangular		
Run	$U/U_c$	$d_s/D$	$d_s/d_{s0}$	$r_s$
2	2.994	0.350	0.240	76%
3a	4.114	1.023	0.591	41%
3b	3.889	-0.190	-0.110	100%
3c	4.257	1.082	0.626	37%
3d	4.217	1.066	0.616	38%
4a	5.233	1.415	0.710	29%
4b	5.409	1.522	0.763	24%
4c	5.521	1.538	0.771	23%
4d	4.825	0.976	0.489	51%

**Table 3.14a.** Results of series TF-RR2 for the circular pier

Riprap no. geotextile				
<b>Flume:</b>		Tilting flume		
<b>Data set:</b>		TF-RR2		
<b>Pier type:</b>		Circular		
Run	$U/U_c$	$d_s/D$	$d_s/d_{s0}$	$r_s$
2	2.481	-0.239	-0.240	100%
3a	3.931	-0.230	-0.208	100%
3b	3.917	-0.236	-0.214	100%
3c	3.946	-0.223	-0.202	100%
4a	5.048	0.638	0.459	54%
4b	5.094	0.121	0.087	91%
4c	5.002	0.616	0.443	56%

Table 3.14b. Results of series TF-RR2 for the rectangular pier

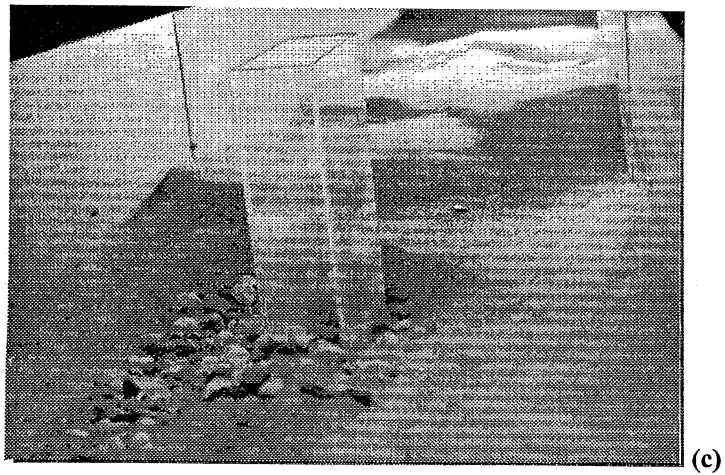
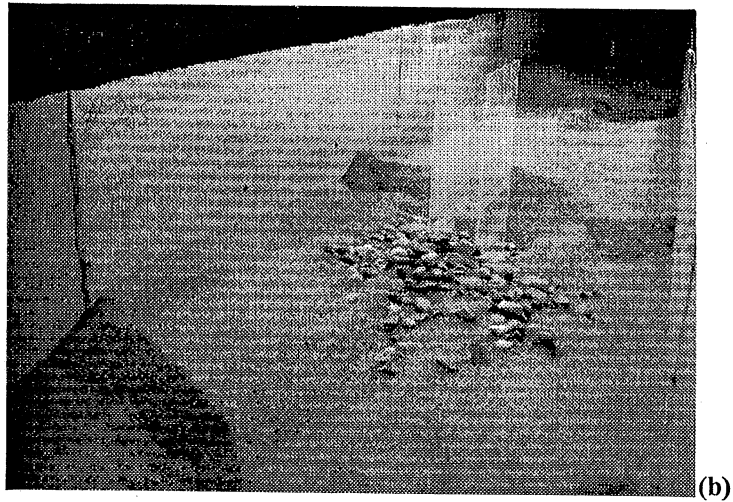
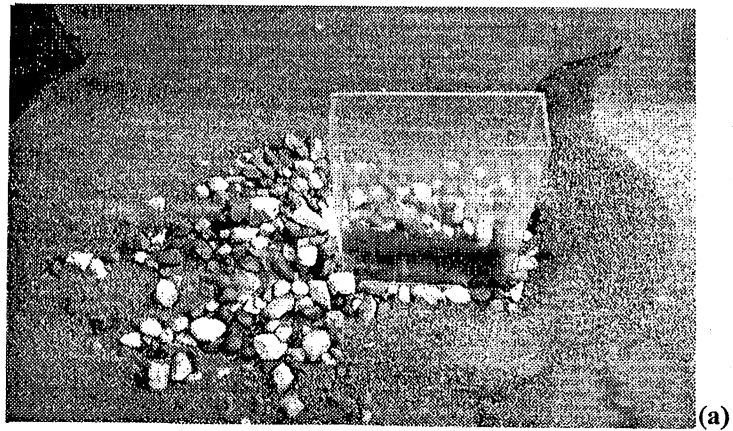
Riprap no geotextile				
Flume: <i>Tilting flume</i>				
Data set: <i>TF-RR2</i>				
Pier type: <i>Rectangular</i>				
Run	$U/U_c$	$d_s/D$	$d_s/d_{so}$	$r_s$
2	2.125	-0.403	-0.276	100%
3a	3.973	1.260	0.729	27%
3b	3.818	1.155	0.668	33%
3c	4.141	1.334	0.772	23%
4a	5.173	1.718	0.862	14%
4b	5.133	1.699	0.852	15%
4c	5.214	1.586	0.796	20%

As indicated by the above tables, Runs 3 and 4 were continued repeatedly in order to determine the asymptotic behavior of the riprap. It can be seen that the countermeasure showed better performance at the circular pier than at the rectangular pier. Part of this difference is ascribable to the more severe flow modification offered by the sharp edges of the rectangular pier. A perhaps larger part, however, is ascribable to the effect of dunes, which were more developed in the vicinity of the rectangular pier.

It is important to realize that the riprap layer did not fail due to mobilization by the flow at either pier even under the most severe condition of Run 4. There was thus no catastrophic raveling of the riprap. As it was desirable to include riprap failure in the present study, the riprap was reconstituted into a finer distribution that became the standard for all subsequent runs. The lack of failure of the riprap in series TF-RR1 and TF-RR2, however, allows for the following observations.

Figures 3.11a and 3.11b show views of the rectangular pier at the end of Run 4d of series TF-RR1. Figure 3.11c shows a similar view at the end of Run 4c of series TF-RR2. Prominent dunes are visible in all three photographs. Rather than being entrained into the flow, the riprap has been gradually reworked and dispersed by the successive passage of dunes. The mechanism appears to be as follows. As each dune passes, it generates a transient scour and fill. The scour is accentuated in the vicinity of the bridge pier. Riprap particles tend to roll to the bottom of the trough with each passage. This rolling, which is irregular due to the aperiodic nature of the dunes, causes the grains to disperse. Settling by rolling is augmented by the tendency of the flow to leach sand from the interstices of the riprap in the zone of low pressure just downstream of the dune crest.

It is of value to note that this mechanism for the gradual emplacement of a layer of stones below the troughs of a field of sand dunes was first observed experimentally by Hooke (1968). In the case of a bridge pier, the combination of rolling and leaching due to dunes is accentuated by the presence of the pier, so that the riprap can settle to a position that is lower than the average trough elevation of the dunes. As discussed later in this report, Lim and Chiew (1998) report that in some cases the riprap can eventually settle to a level corresponding to the scour depth that would be realized without riprap.



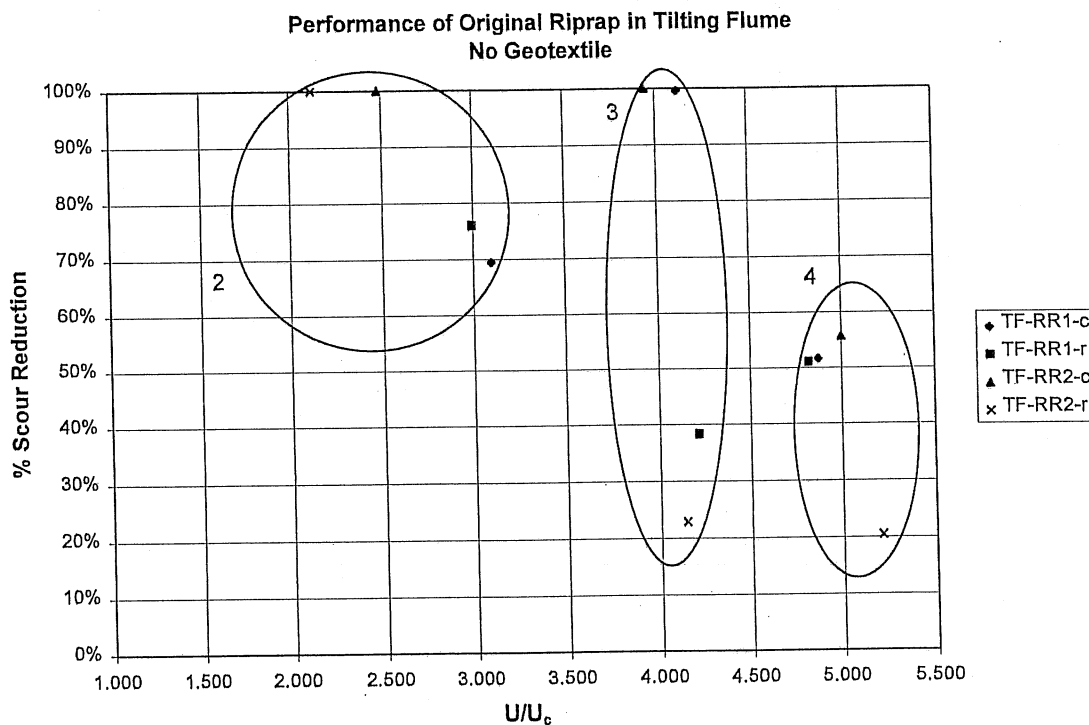
**Figure 3.11.** a) Side view of the rectangular pier at the end of Run 4 of series TF-RR1. b) View of the same rectangular pier looking upstream. c) View looking upstream of the rectangular pier at the end of Run 4 of series TF-RR2.

Significant degradation of scour protection offered by riprap was thus observed in these runs even though the riprap layer never failed by entrainment. This is illustrated in Fig. 3.12. In the figure all of the results corresponding to the conditions of Run 2 (3, 4) have been enclosed with an ellipse and numbered 2 (3, 4) for ease of identification. This format is preserved in similar figures in this section of the report. In order to interpret this and similar figures, the following qualitative criteria are used.

- If the scour reduction  $r_s$  achieved by the countermeasure is greater than 70% at a given flow, the method is said to be acceptable at that flow.
- If  $r_s$  is between 50% and 70%, the countermeasure is said to be 'marginal' at the flow in question.
- If  $r_s$  is below 50%, the countermeasure is said to be ineffective at the flow in question.

In the case of the circular pier, the riprap performance is seen to be acceptable or marginal at Run 2, acceptable at Run 3 and marginal verging on unacceptable at Run 4. In the case of the rectangular pier, the performance is acceptable at Run 2, unacceptable at Run 3 and marginal or unacceptable at Run 4. Especially in the case of the rectangular pier, the countermeasure can be said to have failed even though the riprap never raveled catastrophically in response to the flow.

In summary, the experiments of series TF-RR1 and TF-RR2 highlight the fact that riprap can fail as a countermeasure even though it is never entrained directly by the flow. This result motivated further studies using a geotextile filter in order to help suppress the effect of dunes and stabilize the riprap without excess settling.



**Figure 3.12.** Performance of the riprap in series TF-RR1 and TF-RR2. In the legend, "c" denotes the circular pier and "r" denotes the rectangular pier.

### 3.6.4 Runs with the Standard (modified) Riprap

These runs are Series MC-RNG in the Main Channel and TF-RNG in the Tilting Flume. The runs used the modified finer riprap (which is standard for all subsequent experiments) in order to allow for the entrainment of the riprap by the flow under the conditions of Run 4. With this in mind, the acceptability of the performance of the countermeasure is judged based on the results of Runs 2 and 3, and not Run 4, where failure was expected. The mode of installation of the riprap was the same as that of series TF-RR2 And TF-RR2: the bed was excavated before installing the riprap and no geotextile filter was used.

The results of the tests are shown in Tables 3.15 a and 3.15b for the Main Channel and 3.16a and 3.16b for the Tilting Flume. They are also shown graphically in Figure 3.13.

It is quickly apparent from the tables and figure below that at the conditions of Run 4 the riprap was offering very little protection. That is, in the case of the rectangular pier the scour reduction was only 22% in the Main Channel and 30% in the Tilting Flume. In the case of the circular pier the corresponding values are 53% in the Main Channel and 30% in the Tilting Flume. At this condition the riprap was observed to have failed by direct entrainment into the flow, as expected.

**Table 3.15a.** Results of series MC-RNG for the circular pier

<i>Riprap no geotextile</i>				
<b>Flume:</b>		<i>Main channel</i>		
<b>Data set:</b>		<i>MC-RNG</i>		
<b>Pier type:</b>		<i>Circular</i>		
Run	$U/U_c$	$d_s/D$	$d_s/d_{so}$	% Red
2	3.033	0.301	0.472	53%
3a	4.501	0.256	0.278	72%
3b	4.505	0.257	0.280	72%
4	5.965	0.579	0.473	53%

**Table 3.15b.** Results of series MC-RNG for the rectangular pier

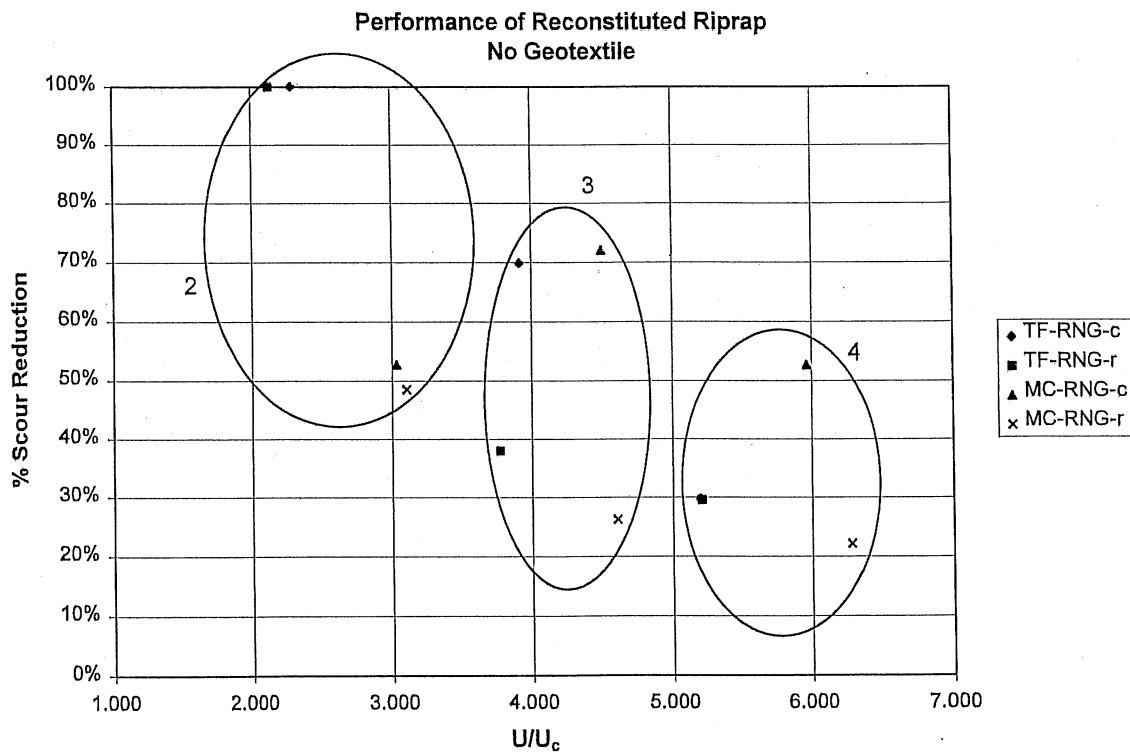
<i>Riprap no geotextile</i>				
<b>Flume:</b>		<i>Main channel</i>		
<b>Data set:</b>		<i>MC-RNG</i>		
<b>Pier type:</b>		<i>Rectangular</i>		
Run	$U/U_c$	$d_s/D$	$d_s/d_{so}$	% Red
2	3.106	0.572	0.515	49%
3a	4.619	1.019	0.750	25%
3b	4.611	1.003	0.738	26%
4	6.284	1.379	0.779	22%

**Table 3.16a.** Results of series TF-RNG for the circular pier

Riprap no geotextile				
Flume:		Tilting flume		
Data set:		TF-RNG		
Pier type:		Circular		
Run	$U/U_c$	$d_s/D$	$d_s/d_{s0}$	% Red
2	2.301	-0.244	-0.245	100%
3	3.917	0.334	0.302	70%
4	5.196	0.978	0.703	30%

**Table 3.16b.** Results of series TF-RNG for the rectangular pier

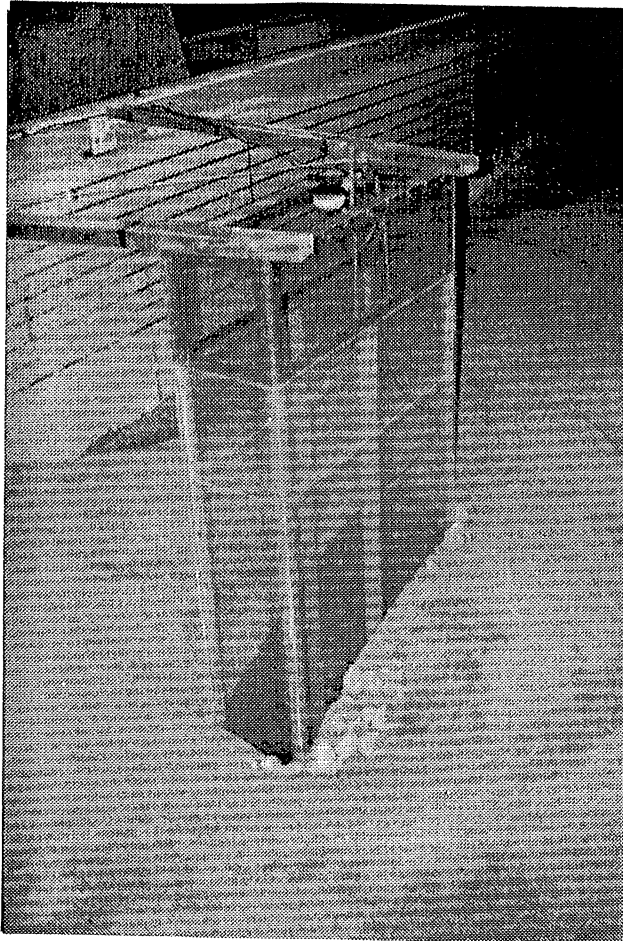
Riprap no geotextile				
Flume:		Tilting flume		
Data set:		TF-RNG		
Pier type:		Rectangular		
Run	$U/U_c$	$d_s/D$	$d_s/d_{s0}$	% Red
2	2.133	-0.247	-0.169	100%
3	3.774	1.073	0.621	38%
4	5.209	1.404	0.704	30%



**Figure 3.13.** Performance of the riprap in series MC-RNG and TF-RNG.

The performance of the riprap should then be judged based on the results of Runs 2 and 3. In the case of Run 2, some degradation of riprap performance is already evident. By Run 3 the performance is quite unacceptable in the case of the rectangular pier, with little scour protection being provided. The results are better in the case of the circular pier, where the performance is at the border between acceptable and marginal. It is suggested here that the results for the rectangular pier be accepted as definitive, as dune height was more developed at the rectangular pier.

The results of series MC-RNG and TF-RNG provided further documentation of the tendency for the riprap to become dispersed and buried due to dune action. Figure 3.14 shows the rectangular pier at the end of Run 3 of series MC-RNG. The riprap is barely visible due to burial. The leaching of sand from the interstices of the gravel was documented by means of a video camera installed inside the pier.



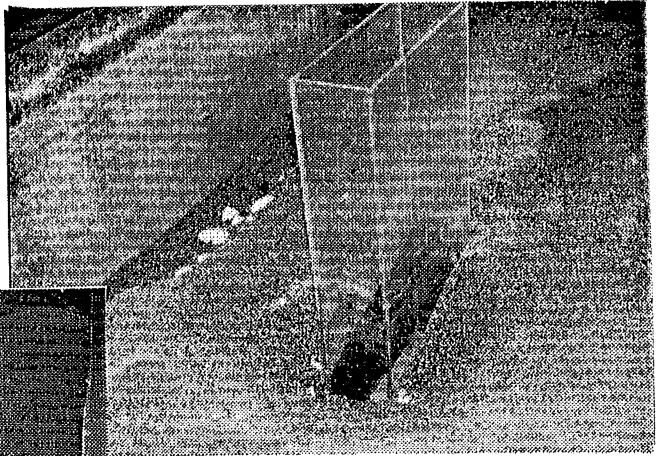
**Figure 3.14.** View of the rectangular pier at the end of Run 3 of series MC-RNG.

The riprap failed quite dramatically in the course of Run 4 in the case of the Tilting Flume. In the case of the Main Channel the failure was less dramatic, but nevertheless readily apparent in terms of the number of riprap particles carried far downstream of the pier. Figures 3.15a and 3.15b show views of the piers in the Tilting Flume at the end of Run 4 of series TF-RNG; the corresponding views of the Main Channel are given in Figures 3.15c and 3.15d.

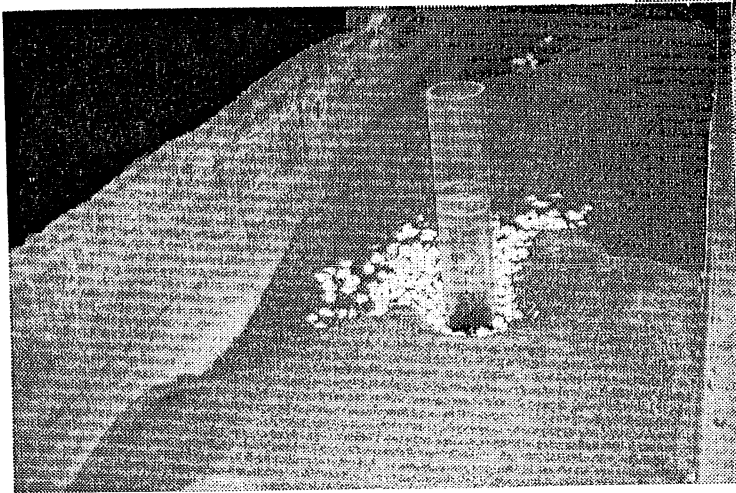
In summary, these runs provide further documentation of the inadequate performance of riprap in the presence of a mobile bed covered with bedforms. As illustrated below, the addition of a geotextile below the riprap helped arrest the tendency for the riprap to settle.

The original research plan called for testing of high-density riprap. The goal was to obtain extra protection with a smaller unit size. The results of the above experiments on riprap with a natural specific gravity suggest, however, that extra density would not only provide no protection against sinking, but might even enhance it. With this in mind, testing of high-density riprap was abandoned as unlikely to yield worthwhile results.



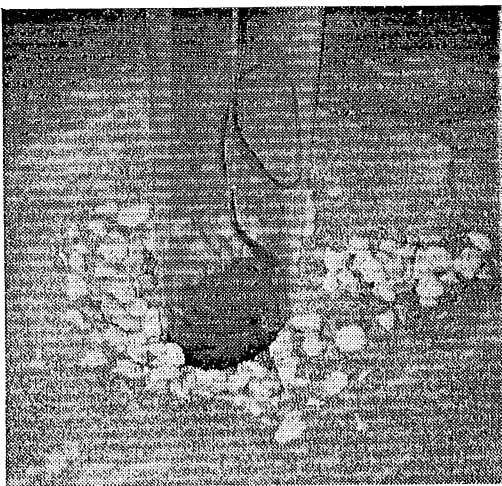


(a)

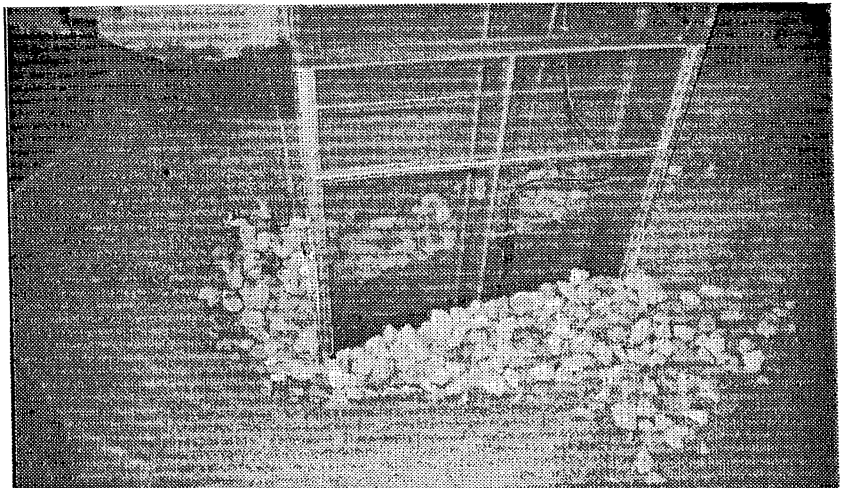


(b)

**Figure 3.15.** a) View of the rectangular pier at the end of Run 4, series TF-RNG. b) View of the cylindrical pier at the end of Run 4, series TF-RNG. c) View of the cylindrical pier at the end of Run 4, series MC-RNG. d) View of the rectangular pier at the end of Run 4, series MC-RNG.



(c)



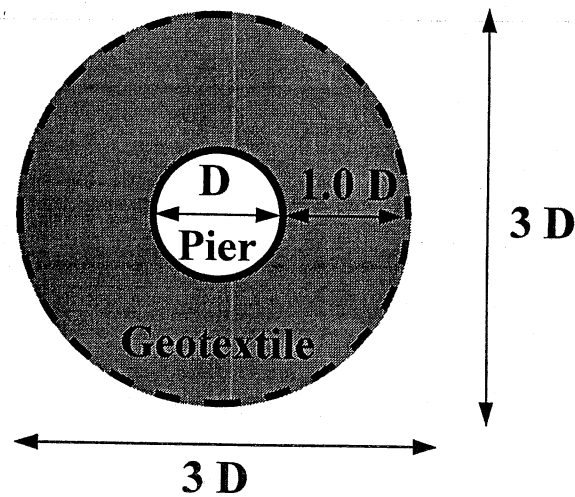
(d)

### 3.6.5 Runs with Riprap and Partial Geotextile

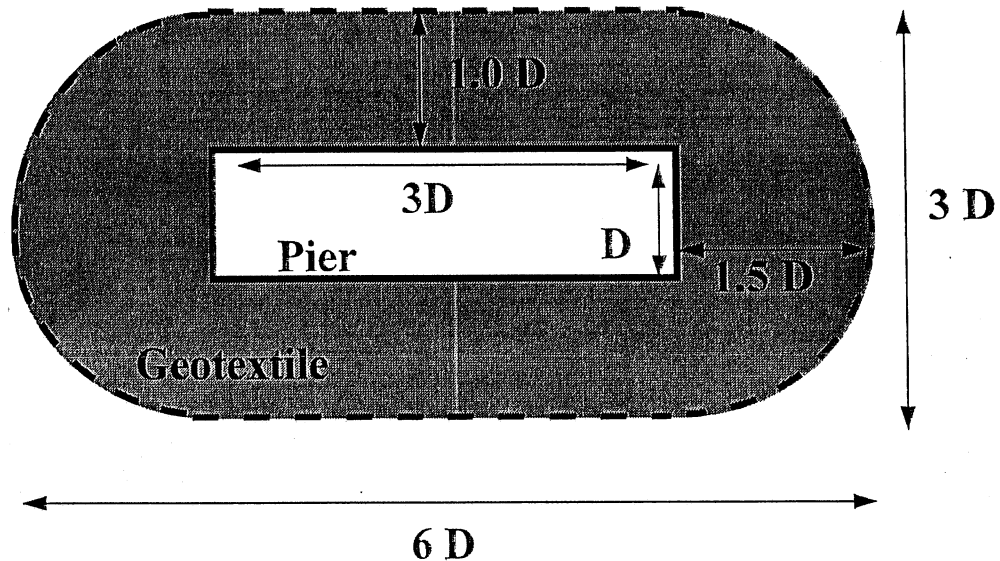
These runs correspond to series MC-RPG in the Main Channel and TF-RPG in the Tilting Flume. Standard riprap was used; the bed was excavated prior to riprap installment. These runs differ from those of series MC-RNG and TF-RNG only to the extent that a geotextile was installed underneath the riprap. The goal was to reduce the burial and dispersion of riprap observed in the previous runs by preventing the leaching of sand from the interstices of the riprap

Earlier experiments conducted at the University of Auckland revealed that when the geotextile has exactly the same areal cover as the riprap, the riprap can fail due to edge effects. That is, edge scour develops just beyond the riprap, which then slides off the geotextile and into the zone of edge scour. The riprap remaining on the geotextile thus loses lateral support and becomes subject to the dispersive effect of dunes. As the riprap gradually abandons the geotextile it is eventually uplifted and rolled over the face of the pier, leaving a previously protected zone in front of the pier completely unprotected.

In order to obtain the benefits of a geotextile without the above deleterious effects, it was decided to design the geotextile so as to cover less area than the riprap. In the case of the circular pier geotextile extended out to 1 D beyond the face of the pier itself, as opposed to 1.5 D for the riprap. In the case of the rectangular pier the geotextile extended 1 D out from a lateral face (as opposed to 1.5 D for the riprap) and 1.5 D out from a longitudinal face (as opposed to 2 D for the riprap). This is illustrated schematically in Figure 3.16.



**Figure 3.16a.** Sketch of placement of geotextile around a circular pier.



**Figure 3.16b.** Sketch of placement of geotextile around a rectangular pier.

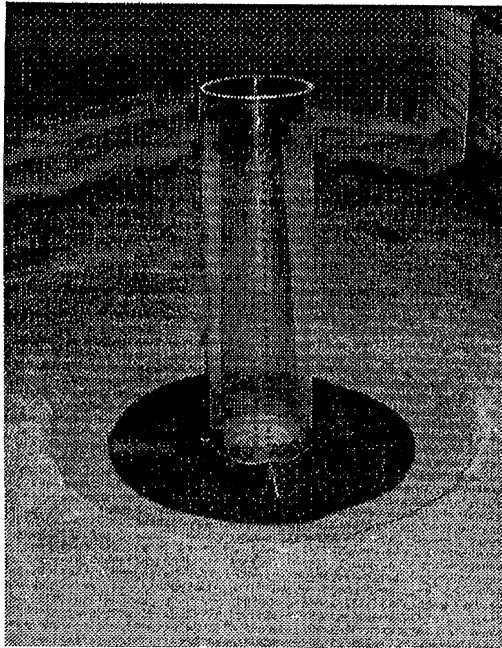
The concept behind this partial coverage is as follows. Edge effects and dune migration can be expected to cause failure of the riprap by side slippage. As long as this riprap is not entrained by the flow, it should become buried and gradually anchor the geotextile in place. The partial coverage should thus encourage self-anchoring and prevent exposure of the geotextile.

The geotextile was chosen after consultation with several manufacturers. It was a professional quality landscape fabric with the following characteristics. This same geotextile was used for all other runs at SAFL employing a geotextile.

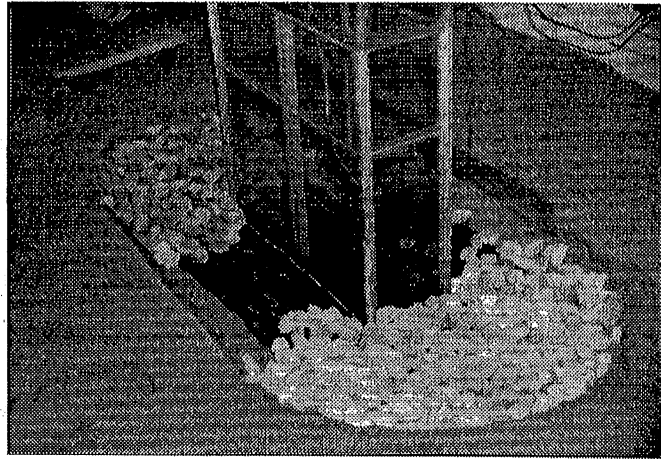
**Table 3.17.** Characteristics of the geotextile

Specifications	Units	Specifications	Units
Unit weight	3 oz/yd <sup>2</sup>	Equivalent pore size	0.2 mm
Tensile strength	130 lbs	Flux	100 gal/ft <sup>2</sup> /min
Puncture strength	35 lbs	Permeability coefficient	4x10 <sup>-2</sup> cm/sec
Trap tear	40 lbs	Permeability	1.3 sec <sup>-1</sup>
Elongation at break	70 %	Manufacturer	Fabriscap, Inc.
Equivalent sieve (AOS)	60/70		

Installation of the geotextile and riprap in the Main Channel is shown in Figure 3.17.



(a)



(b)

**Figure 3.17.** a) View of geotextile and riprap placement around the cylindrical pier for series MC-RPG, b) View of geotextile and riprap placement around the rectangular pier for series MC-RPG.

The performance of this countermeasure is documented in Tables 3.18a and 3.18b in the case of the Main Channel and Tables 3.19a and 3.19b in the case of the Tilting Flume. The results are documented graphically in Figure 3.18.

**Table 3.18a.** Results of series MC-RPG for the circular pier

<i>Riprap partial geotextile</i>				
<b>Flume:</b>	<i>Main channel</i>			
<b>Data set:</b>	<i>MC-RPG</i>			
<b>Pier type:</b>	<i>Circular</i>			
Run	$U/U_c$	$d_s/D$	$d_s/d_{s0}$	$r_s$
1	1.383	-0.232	n/a	n/a
2	2.663	-0.150	-0.235	100%
3	4.215	-0.107	-0.116	100%
4	5.488	0.631	0.515	48%

**Table 3.18b.** Results of series MC-RPG for the rectangular pier

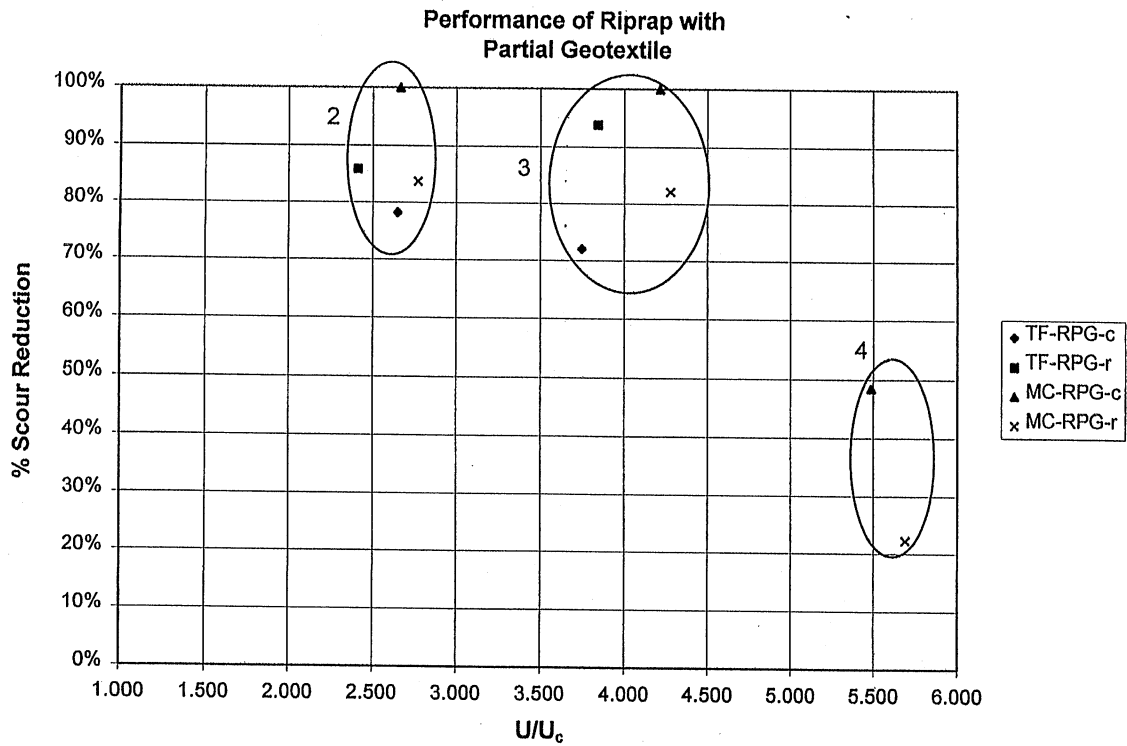
<i>Riprap partial geotextile</i>				
<b>Flume:</b> <i>Main channel</i>				
<b>Data set:</b> <i>MC-RPG</i>				
<b>Pier type:</b> <i>Rectangular</i>				
Run	$U/U_c$	$d_s/D$	$d_s/d_{s0}$	$r_s$
1	1.573	0.189	n/a	n/a
2	2.768	0.181	0.163	84%
3	4.278	0.244	0.179	82%
4	5.689	1.376	0.777	22%

**Table 3.19a.** Results of series TC-RPG for the circular pier

<i>Riprap partial geotextile</i>				
<b>Flume:</b> <i>Tilting flume</i>				
<b>Data set:</b> <i>TF-RPG</i>				
<b>Pier type:</b> <i>Circular</i>				
Run	$U/U_c$	$d_s/D$	$d_s/d_{s0}$	$r_s$
2	2.647	0.218	0.218	78%
3b	3.747	0.309	0.280	72%

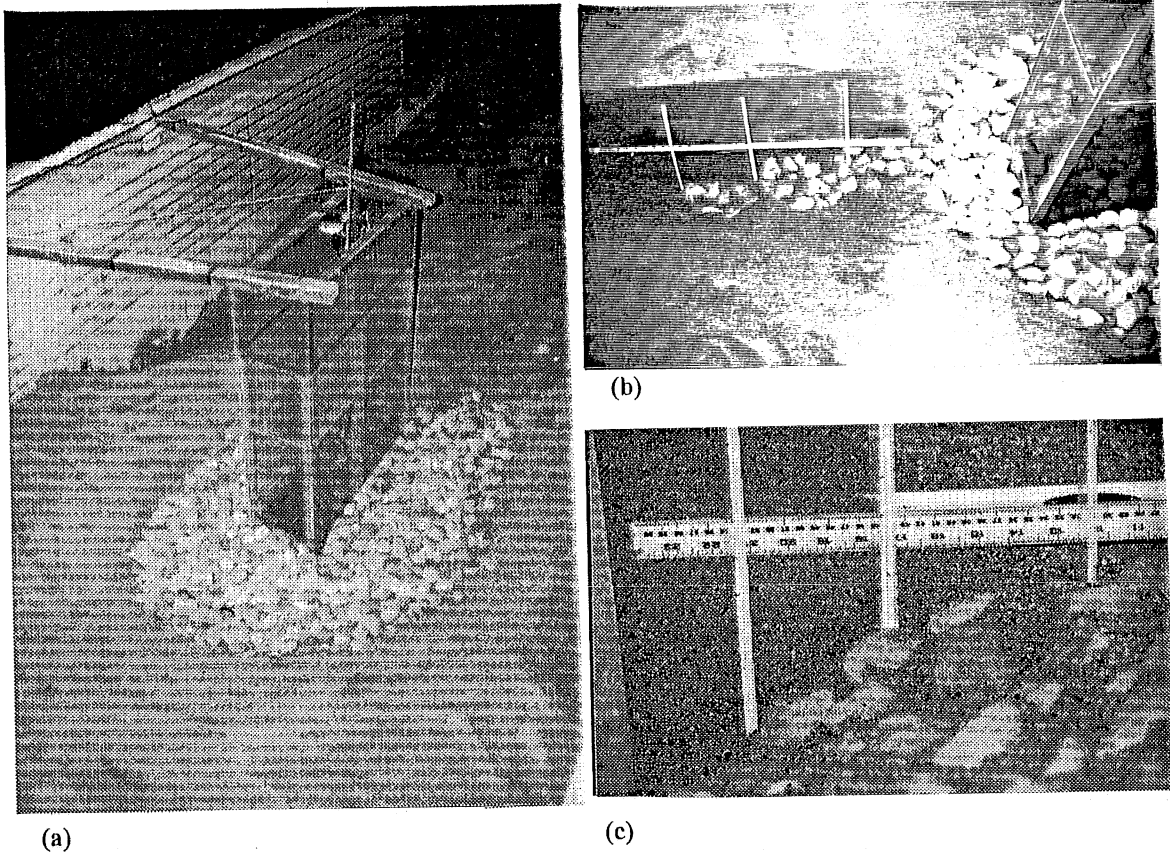
**Table 3.19b.** Results of series TC-RPG for the rectangular pier

<i>Riprap partial geotextile</i>				
<b>Flume:</b> <i>Tilting flume</i>				
<b>Data set:</b> <i>TF-RPG</i>				
<b>Pier type:</b> <i>Rectangular</i>				
Run	$U/U_c$	$d_s/D$	$d_s/d_{s0}$	$r_s$
2	2.412	0.207	0.141	86%
3b	3.844	0.108	0.063	94%



**Figure 3.18.** Performance of the riprap with partial geotextile for series MC-RPG and TC-RPG.

The improvement in performance as compared to the corresponding runs without a partial geotextile, i.e. series MC-RNG and TF-RNG is dramatic. Performance is in the acceptable range for all experiments at the conditions of Run 2 and Run 3. The failure of the countermeasure at Run 4 was caused by the expected mobilization of the riprap at that flow. The good performance is further documented in Figures 3.19a – 3.19c, which show the rectangular pier in the Main Channel at the end of Run 3. The layer of riprap around the pier is seen to be essentially intact. Excavation into the sand on the upstream face and one lateral face of the pier reveals how edge failure of the riprap has securely anchored the geotextile in place. In Figure 3.19c the placement of the three vertical rulers serves to illustrate this. The vertical ruler nearest the pier denotes the lateral position of the outer edge of the geotextile. The vertical ruler in the middle denotes the outer position of the riprap as placed. The outer vertical ruler denotes the outer edge of the riprap after settling.

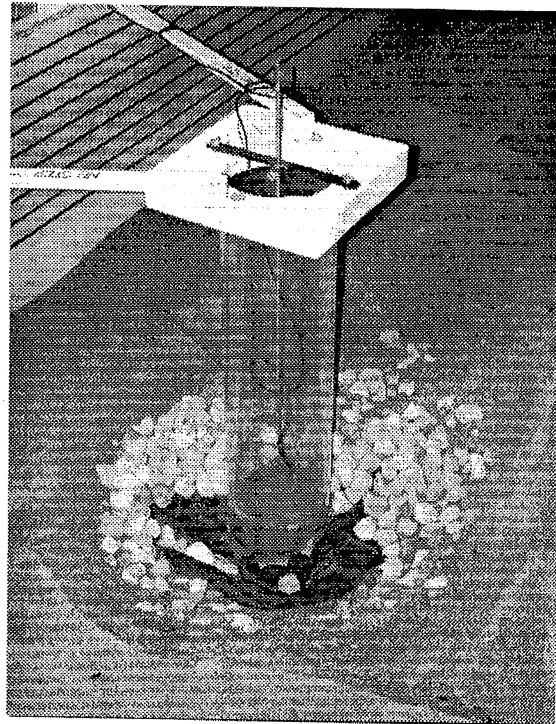
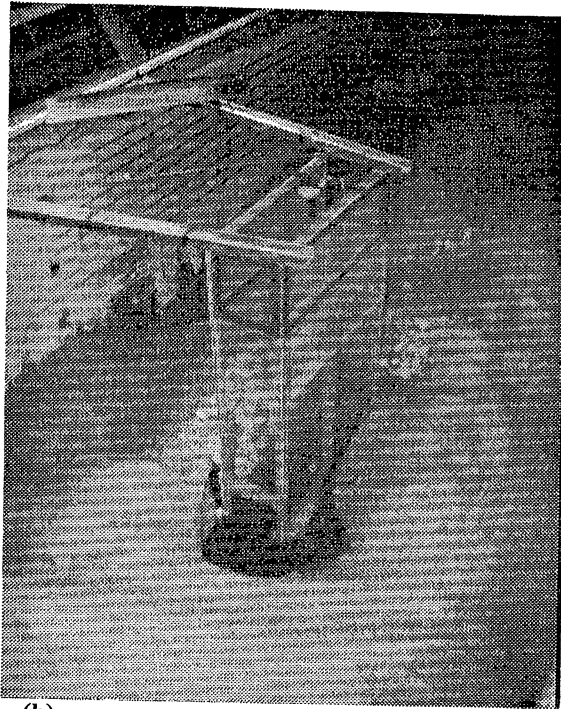
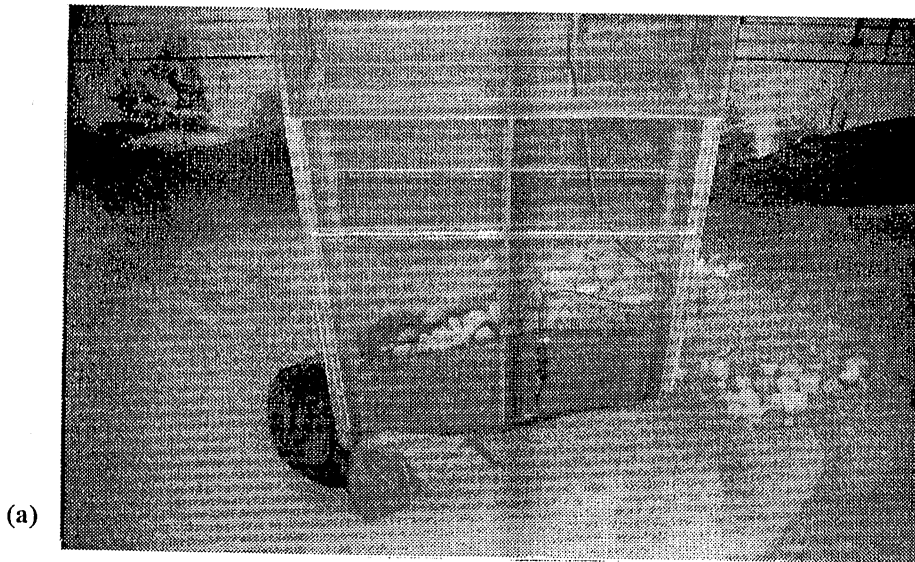


**Figure 3.19.** a) View of the rectangular pier at the end of Run 3 of series MC-RPG, showing the excellent performance of the riprap in anchoring the geotextile. b) View of the excavated sand bed in front of the rectangular pier at the end of Run 3 of series MC-RPG, showing how riprap settling anchors the geotextile. c) View of the excavated sand bed to the side of the rectangular pier at the end of Run 3 of series MC-RPG, again illustrating edge settling of riprap and geotextile anchoring.

The riprap failed due to entrainment during Run 4 of series MC-RPG, as expected. The failed riprap and exposed geotextile are dramatically illustrated in Figures 3.20a and 3.20b for the rectangular flume. Failure also occurred at the cylindrical pier, although not quite so dramatically, as shown in Figure 3.20c.

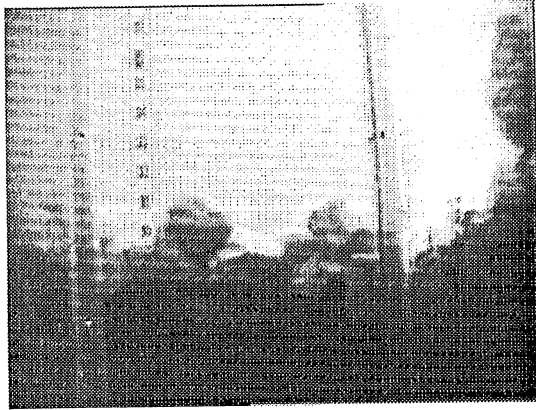
This failure occurred within minutes of the commencement of Run R-M4. It was documented vividly on videotape taken from inside the piers. Figures 3.21a-e, which were extracted from videotape, show the time sequence of failure for the rectangular pier. All the views are looking upstream from inside the pier. Figure 3.21a shows the riprap and geotextile at the beginning of the run. Figure 3.21b shows the riprap being eroded away from the geotextile a few minutes later. A cavity is apparent beneath the geotextile as sand is leached out. Figure 3.21c shows the leading edge of the geotextile beginning to lift up. Figure 3.21d shows the leading edge of the filter layer flipped up against the bridge pier, and deep scour below. Figure 3.21e shows an even deeper hole, with some riprap falling in to rearmor the scour hole.



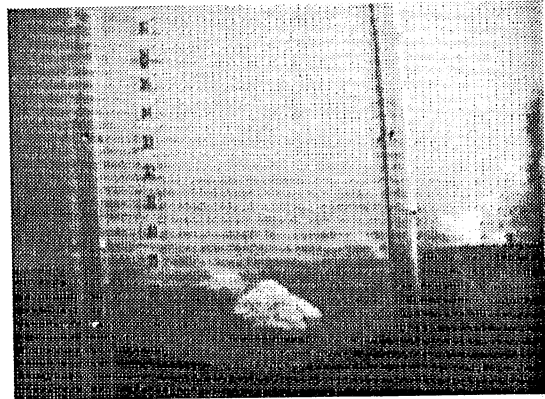


**Figure 3.20.** a) Side view of the riprap failure near the rectangular pier of Run 4 of series MC-RPG. b) Downstream view of the riprap failure near the rectangular pier (Run 4 of series MC-RPG). c) Downstream view of the riprap failure near the cylindrical pier (Run 4 of series MC-RPG).

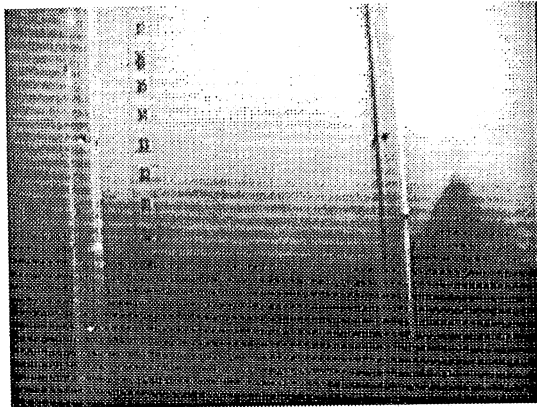




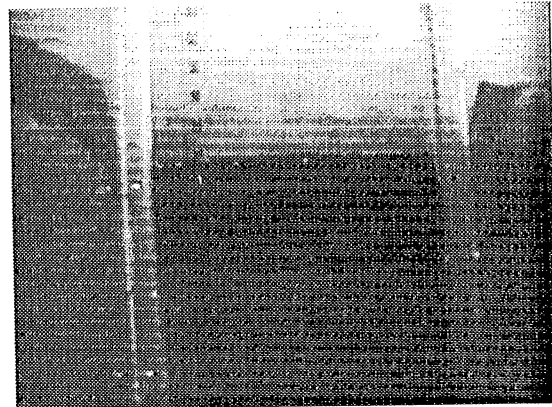
(a)



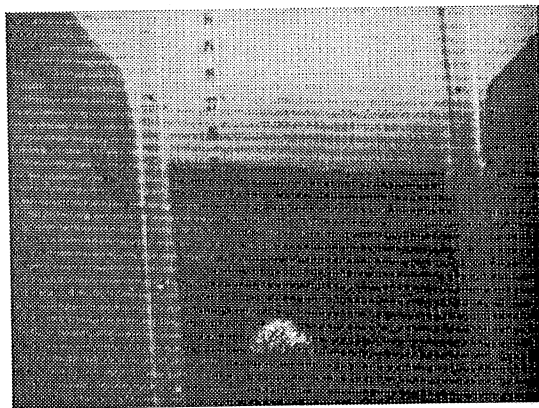
(b)



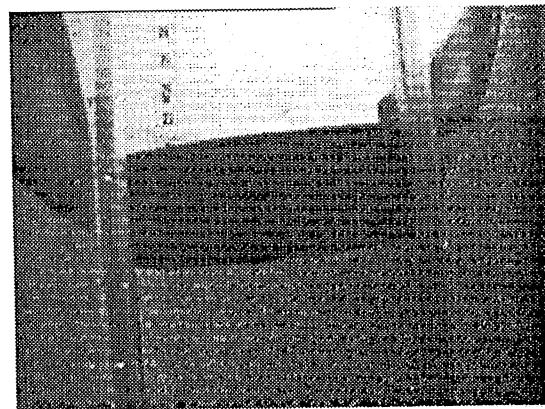
(c)



(d)



(e)



(f)

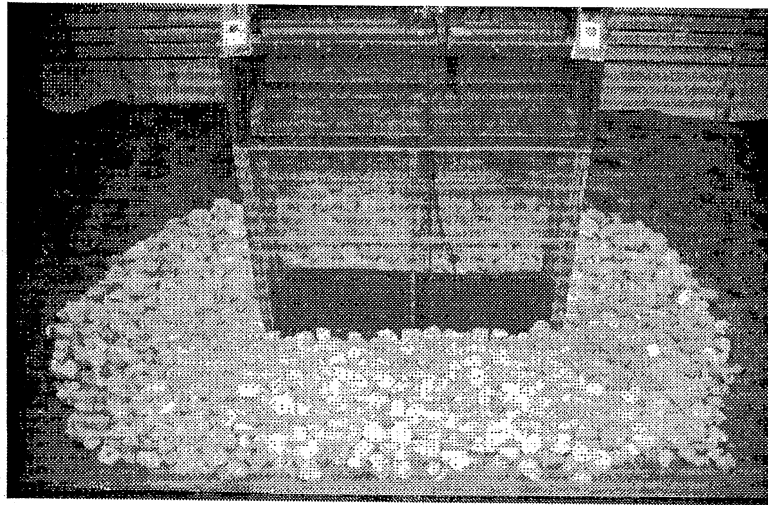
**Figure 3.21.** a) View of the riprap and geotextile upstream of the rectangular pier at the beginning of Run 4 of series MC-RPG. This and the subsequent views of the same pier for the same run were taken from videotape. The view is upstream from inside the pier. b) View a few minutes later, showing exposure of the geotextile as riprap is eroded away. c) Subsequent view showing the beginning of uplift of the geotextile. A scour hole is apparent below the geotextile. d) Subsequent view showing a deeper scour hole below the geotextile, with the leading edge of the geotextile flipped up against the pier. e) Frontal view showing some rearmoring of the scour hole by riprap from upstream. f) Final view showing riprap falling into the deep scour hole.

In summary, the riprap with a partial geotextile showed dramatically improved performance as compared with riprap alone. This countermeasure provides a promising alternative to riprap alone. It should be noted that the geotextile was not sealed to the pier in these experiments.

### **3.6.6 Runs with Dumped Riprap**

While prior excavation of the bed is recommended before installing riprap (see e.g. HEC-18, Richardson et al. 1992), such excavation is not always feasible. With this in mind tests were performed in the Main Channel using precisely the configuration of series MC-RPG except for the fact that the geotextile was placed on a bed that was not excavated in advance, and the riprap dumped on top. These runs constitute series MC-RNX.

Installation of the geotextile was performed after continuing flow for several hours at the condition of Run 1. The flow was then stopped, the bed was flattened and smoothed around the piers, and the geotextile and riprap were placed over the bed. The final placement at the rectangular pier is shown in Figure 3.22.



**Figure 3.22.** Placement of dumped riprap over a geotextile.

The results of the experiments are shown in Tables 3-20a and 3-20b. The percent scour reduction is compared with the results of series MC-RPG, i.e. the corresponding series in the Main Channel with excavation before installation, in Figure 3.23. In the case of Runs 2 and 3 the performance is seen to be quite acceptable, and almost as good as that of excavated riprap. The riprap fails due to entrainment at Run 4, as expected.

Table 3.20a. Results of series MC-RNX for the circular pier

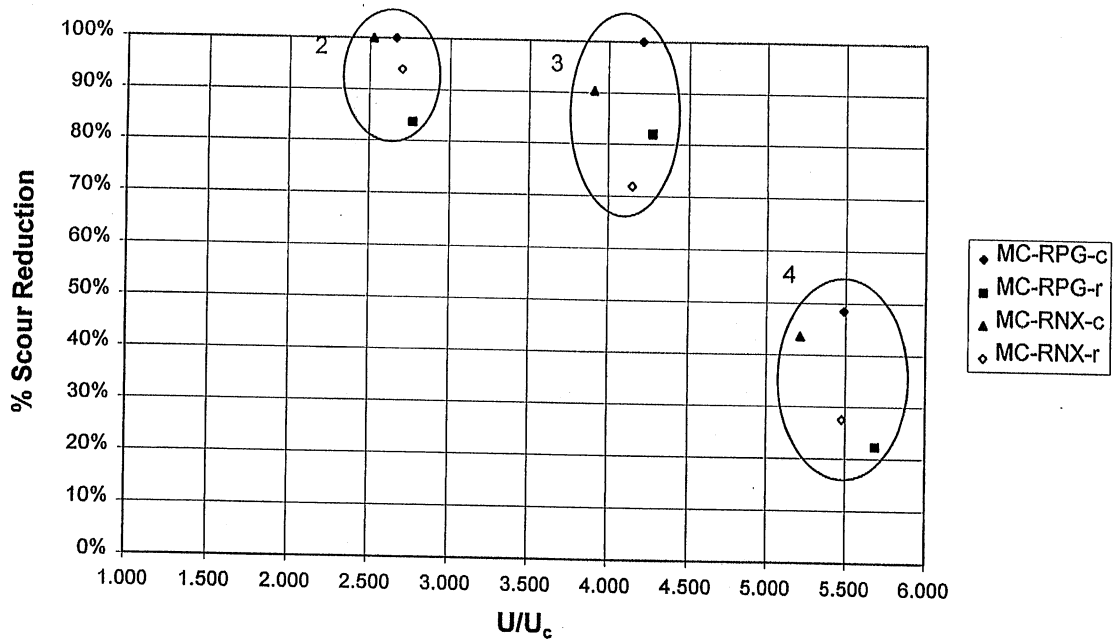
Riprap no excavation				
Flume: Main channel				
Data set: MC-RNX				
Pier type: Circular				
Run	$U/U_c$	$d_s/D$	$d_s/d_{s0}$	% Red
2	1.497	-0.222	-0.348	100%
3	2.230	0.089	0.096	90%
4	2.869	0.690	0.564	44%

Table 3.20b. Results of series MC-RNX for the rectangular pier

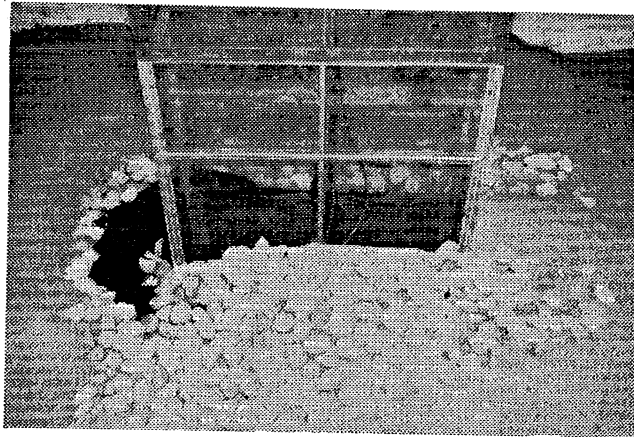
Riprap no excavation				
Flume: Main channel				
Data set: MC-RNX				
Pier type: Rectangular				
Run	$U/U_c$	$d_s/D$	$d_s/d_{s0}$	% Red
2	1.617	0.067	0.061	94%
3	2.384	0.383	0.281	72%
4	3.033	1.283	0.725	27%

A cautionary note is in order, however, concerning dumped riprap. Figure 3.24 shows the state of the riprap around the rectangular pier at the end of Run 3 of MC-RNX. It is seen there that a portion of the geotextile at the upstream face of the pier is exposed. The geotextile is in no obvious danger of failing, as it is anchored on all sides by riprap. Exposure of the geotextile is, however undesirable. It was likely caused by the initial protrusion of the riprap into the main flow, so that the effects of reworking by bedforms were accentuated. It is thus recommended that the thickness of the riprap layer be increased from  $t = 2 D_{r50}$  to  $t = 3 D_{r50}$  in the case of dumped riprap with a geotextile. This thickness is in agreement with the recommendations of HEC-18 (Richardson et al., 1992).

### Performance of Dumped Riprap Compared to Prior Excavation



**Figure 3.23.** Performance of the dumped riprap with partial geotextile for series MC-RNX as compared to the case with prior excavation, series MC-RPG.



**Figure 3.24.** Riprap layer at the rectangular pier at the end of Run 3 of series MC-RNX.

In summary, riprap dumped over a geotextile placed on an unexcavated bed performed almost as well as placement with prior excavation. The experiments suggest, however, that the riprap placement should be thicker in the case of dumping without excavation.

### 3.6.7 Runs to Test Geotextile Placement

These runs, i.e. series MC-RPL were performed in the Main Channel using only the rectangular pier. The runs are a repeat of series MC-RNX, i.e. riprap dumped over a geotextile, except for the fact that both the geotextile and the riprap were placed under flowing water. This was done to test the feasibility of field installation at low flow.

The flow conditions of Run 1 were continued for several hours before commencing installation. The flow depth  $y_0$  and velocity  $U$  at the time of installation were near 0.15 m and 0.45 m/s, respectively. A carriage riding over the Main Channel was used as a bridge deck.

Initially riprap was dumped from the bridge deck to fill the scour hole on the front and sides of the pier. This scour hole was not particularly large, in that it corresponded to the condition of Run 1. A relatively smooth surface was created on which to rest the geotextile. The outer perimeter of the geotextile was outfitted with a flexible steel cable of sufficient weight to ensure that it would sink in the ambient flow. The inner perimeter of the geotextile was sealed to a flexible plastic tube with a cable inside. This tube was used to seal the geotextile to the pier.

The geotextile was gradually extended out into the flow using a crane attached to the cable along the outer perimeter, and filled from behind with dumped riprap. Once the geotextile had been spread smoothly and covered with riprap, the inner cable around the bridge pier was placed in tension by means of a chain clamp positioned on the downstream side of the pier.

The installation process can be seen in Figures 3.25 and 3.26. Figure 3.25a in particular illustrates the arrangement of the cables for optimal installation. Maintaining tension on the cables while dumping riprap on top prevented the geotextile from wrinkling or flipping over. Once the riprap was sufficiently covered with riprap, the tension could be released and the rest of the riprap could be installed. In Figure 3.26 the water has been temporarily drained in order to better illustrate the technique. Note the tension in the geotextile and the way the riprap sits on top of it.

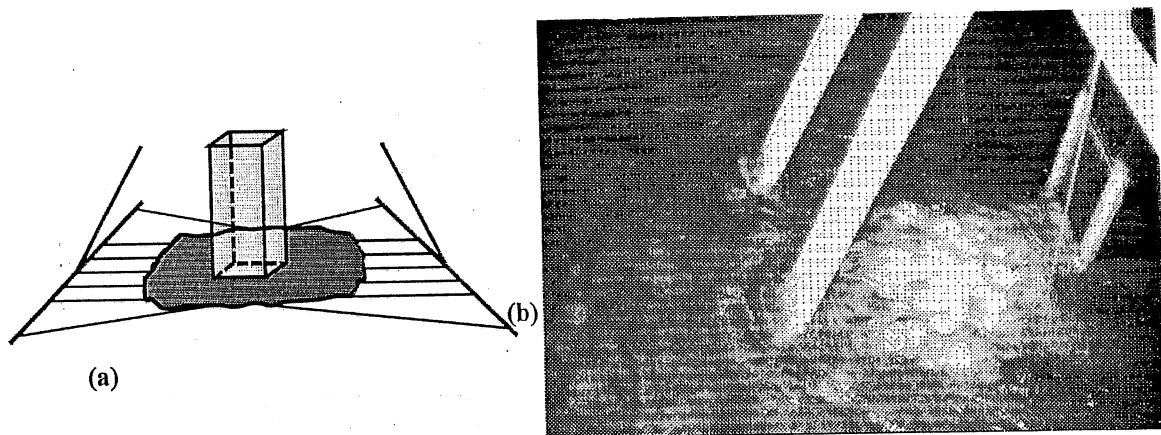
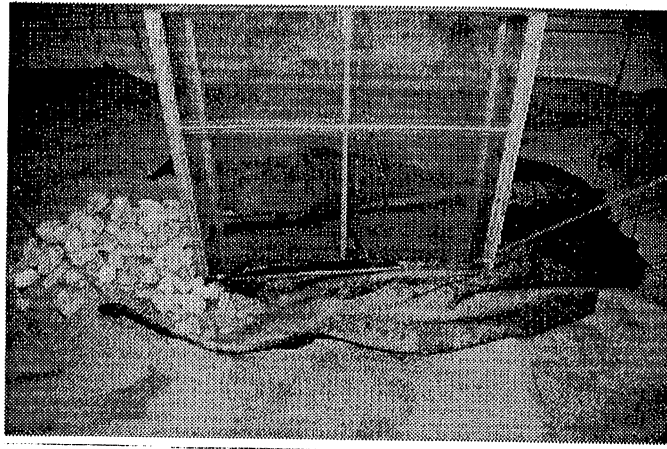


Figure 3.25. a) Schematization of the geotextile installation under water.  
b) View of actual installation of the geotextile underwater.



**Figure 3.26.** Illustration of the low-water installation technique for geotextile and riprap. The flow has been temporarily halted to improve visibility.

Once the geotextile and riprap were installed in this way, the experiments of series MC-RPL were commenced. The results are shown in Table 3.21. Only Runs 2 and 3 were performed, failure at Run 4 being a foregone conclusion. As can be seen from the table, the performance of the riprap with partial geotextile installed underwater was as good as or better than the cases of series MC-RNX without excavation but not installed underwater, and series MC-RPG with excavation but not installed underwater.

**Table 3.21.** Results of series MC-RPL for the rectangular pier

<i>Riprap placement</i>				
<b>Flume:</b>	<i>Main channel</i>			
<b>Data set:</b>	<i>MC-RPL</i>			
<b>Pier type:</b>	<i>Rectangular</i>			
Run	$U/U_c$	$d_s/D$	$d_s/d_{s0}$	$r_s$
2	2.620	0.112	0.101	90%
3	4.163	0.195	0.144	86%

In summary, the experiments illustrate that the geotextile and riprap can be successfully installed underwater at low flow conditions. In order to do this the outer perimeter of the geotextile must be weighted, and supplied with a circumferential cable that allows for manipulation from a crane. The riprap should be dumped so as to weigh down the geotextile as it is spread out. In this case a cable inside flexible tubing was used with a clamp to seal the geotextile to the pier. This sealing probably accounts for part of the excellent performance observed.

### 3.6.8 Runs with Cable Tied Blocks

Cable tied blocks for erosion control are manufactured commercially, and thus offer a viable alternative to riprap. They offer the following potential advantages.

- The tying of individual units into a mattress should allow for units that are less massive than riprap stones.
- The same tying should inhibit the dispersion under the influence of bedforms that is characteristic of riprap.
- The flexibility of the mattress should allow it to self-anchor its edges.
- The mattress can be prefabricated with the geotextile already installed.

Cable tied blocks are subject to failure by uplift. The design criterion for the size of the individual units must then reflect the potential for uplift rather than the potential for entrainment of the individual unit. The former condition is much less stringent than the latter, allowing for smaller units. Here the following relation was used as a basis for sizing the individual units. In order to avoid failure by uplift, the weight per unit area  $\zeta$  of the block mattress as a whole should be greater than the value given by the equation below;

$$\zeta = a_{cb} \frac{\rho_{cb}}{\rho_{cb} - \rho} \rho U^2 \quad a_{cb} = 0.10 \quad (3.10a,b)$$

where  $\rho_{cb}$  denotes the density of the blocks in the mattress. This relation was based on the experimental tests reported in McCorquodale et al. (1988), as well as literature obtained from commercial manufacturers (*International Erosion Control Systems Manual Technical Data* (undated); McCorquodale et al. 1993). The testing did not specifically pertain to the intensified flow field around bridge piers. The relation can be equivalently expressed in a form very similar to the criterion for riprap, Eq. (3.8); where  $U_{cb}$  denotes the critical flow velocity for incipient uplift,  $H_{cb}$  denotes the height of the individual units and  $p$  denotes the volume fraction pore space within the mattress, the criterion for incipient stability becomes

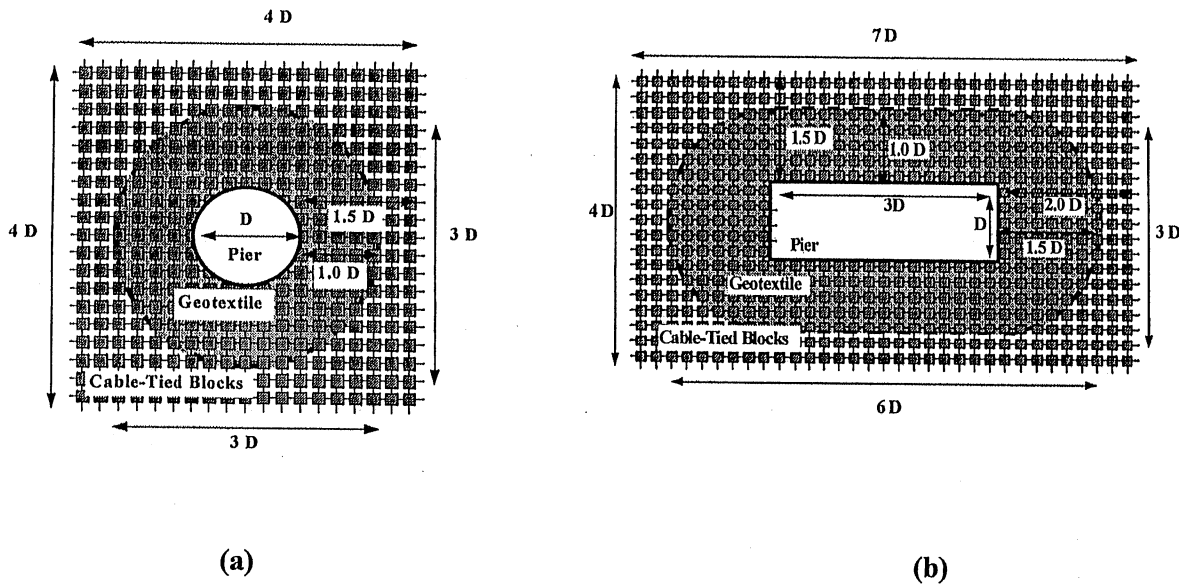
$$N_{cb} \equiv \frac{U_{cb}^2}{\left(\frac{\rho_{cb}}{\rho} - 1\right) g H_{cb}} = \frac{(1-p)}{a_{cb}} \quad (3.11)$$

Eq. (3.11) is obtained from Eq. (3.10) by noting that

$$\zeta = \rho_{cb} g H_{cb} (1-p) \quad (3.12)$$

It is useful to perform a simple calculation comparing riprap with cable tied blocks before proceeding. Consider a flow with a velocity of 3 m/s. Assuming that the riprap density  $\rho_r = 2650 \text{ kg/m}^3$  (specific gravity = 2.65), the minimum size of riprap  $D_{r50}$  needed for a round pier according to Eq. (3.7b) is 432 mm, or 1.42 ft. Consider, on the other hand, a cable tied block mattress with a block density  $\rho_{cb}$  of  $2400 \text{ kg/m}^3$  (specific gravity = 2.4, reflecting construction from concrete) and a fraction pore space  $p$  of 0.3. According to Eq. (3.11), the minimum block height  $H_{cb}$  needed is 94 mm or 0.31 ft. On the one hand, the advantage in regard to unit size would seem to be readily apparent. On the other hand, a larger block height may be necessary for the case of the intensified flow field around a bridge pier.

Tests on cable tied blocks were performed without an underlying geotextile in the Tilting Flume (series TF-TB) and in the Main Channel with a partial geotextile (series MC-CB1, MC-CB2 and MC-CB3). The areal placement of the block mattresses were chosen to be very similar to that of riprap (Figures 3.8 a and 3-8b), with the one exception that the outer edges of the mats were not rounded. This difference was a concession to the inherent rectangularity of cable tied blocks. The placement is schematized in Figures 3.27a and 3.27b.



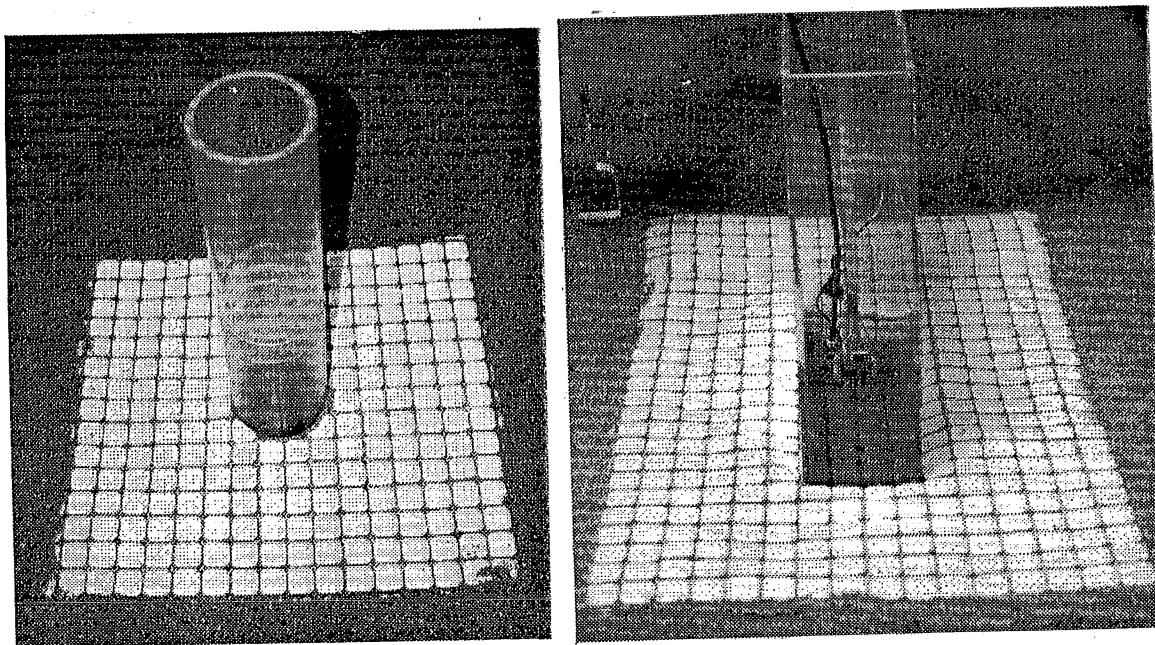
**Figure 3.27.** a) Sketch of placement of cable tied blocks around a circular pier.  
 b) Sketch of placement of cable tied blocks around a rectangular pier.

The cable tied blocks used in the Tilting Flume consisted of commercially available tile mats. These were cut to the dimensions of Figures 3.27a and 3.27b. The bed was smoothed but not excavated prior to installation. The two outermost lines of blocks were buried in sand to help anchor the mattress, with the outermost line of blocks buried  $90^\circ$  to the horizontal, and the line behind that buried  $45^\circ$  to the horizontal. The installed mattresses are shown in Figures 3.28a and 3.28b.

The individual blocks in the mattress had a height  $H_{cb}$  of 5 mm and a square cross-section 25 mm on a side. The bulk density of the blocks  $\rho_{cb}$  was  $1870 \text{ kg/m}^3$  (specific gravity = 1.87). The equivalent sphere diameter  $D_{r50}$  of riprap with a density  $\rho_r$  of  $2650 \text{ kg/m}^3$  (specific gravity = 2.65) is 16.1 mm. The fraction pore space in the mat  $p$  was 0.12. The blocks were initially sized so as not to fail by uplift under conditions of Run 3 of Table 3.5b (which would have required a minimum value of  $H_{cb}$  of 3.4 mm for stability), but fail by uplift under conditions of Run 4 of the same table (which would have required a minimum value of  $H_{cb}$  of 5.83 mm for stability). Unfortunately these calculations were based on a specific gravity of the blocks of 2.4. Using the actual value of 1.87, the minimum block size  $H_{cb}$  required for stability at Run 3 of Table 3.5b was found to be 5.46 mm, or slightly more than the actual value of 5 mm. In the event, the mattress did not fail at Run 3 due to uplift because of the anchoring of the edges by burial.

The results on scour depth for cable tied blocks in the Tilting Flume are summarized in Tables 3.22a and 3.22b. They are not encouraging. The scour protection offered is only barely acceptable in the case of the circular pier at Run 2, and is unacceptable at the rectangular pier at Run 3 and both piers at Run 3. Practically no protection is offered at Run 4, where failure was anticipated.





(a)

(b)

**Figure 3.28.** a) View of placement of cable tied blocks around the circular pier in the Tilting Flume. b) View of placement of cable tied blocks around the rectangular pier in the Tilting Flume.

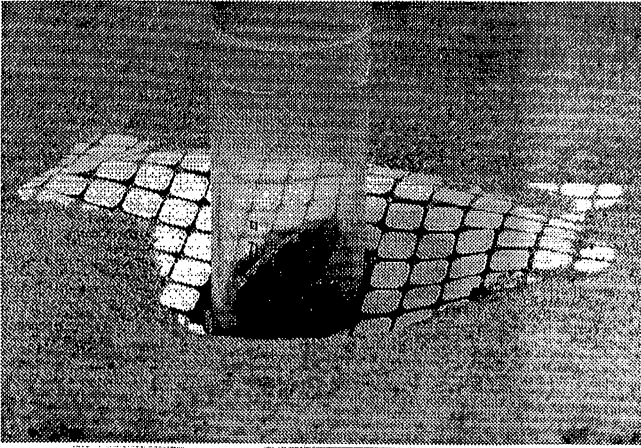
**Table 3.22a.** Results of series TF-CB for the circular pier

<i>Cable-tied blocks no geotextile</i>				
<b>Flume:</b>	<i>Tilting flume</i>			
<b>Data set:</b>	<i>TF-CB</i>			
<b>Pier type:</b>	<i>Circular</i>			
Run	$U/U_c$	$d_s/D$	$d_s/d_{s0}$	$r_s$
2	3.365	0.301	0.302	70%
3	3.885	0.628	0.568	43%
4	5.377	1.083	0.778	22%

In the absence of a geotextile, the block mattress tended to settle with the passage of dunes in a manner reminiscent of riprap without a geotextile. The primary cause of the settling appeared to be the leaching of sand from the pores of the mattress. Edge scour, on the other hand, often had the beneficial effect of helping to further bury and anchor the mattress. Views of the performance of the cable tied blocks at the end of the conditions of Run 3 are provided in Figure 3.29.

**Table 3.22b.** Results of series TF-CB for the rectangular pier

<i>Cable-tied blocks no geotextile</i>				
<b>Flume:</b>	<i>Tilting flume</i>			
<b>Data set:</b>	<i>TF-CB</i>			
<b>Pier type:</b>	<i>Rectangular</i>			
Run	$U/U_c$	$d_s/D$	$d_s/d_{s0}$	$r_s$
2	3.211	0.768	0.526	47%
3	4.152	0.999	0.578	42%
4	5.326	1.686	0.846	15%



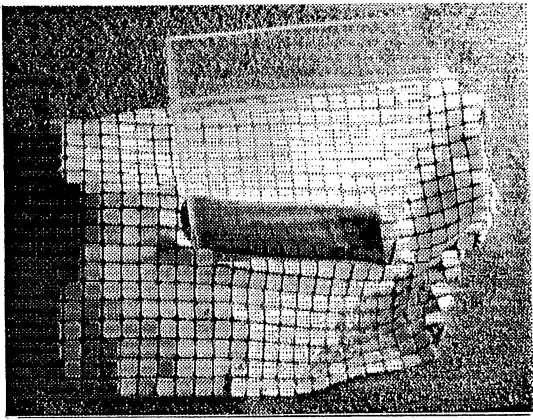
(a)



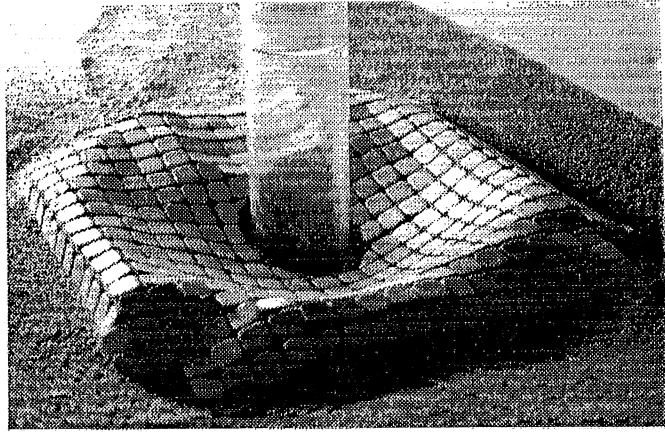
(b)

**Figure 3.29.** a) Close-up view of the cylindrical pier at the end of Run 3 of series TF-CB. The mattress of cable-tied blocks has settled, and the leading edge of a dune is passing over it. b) View of the rectangular pier at the end of Run 3 of series TF-CB.

The cable-tied blocks at the rectangular pier failed dramatically during Run 4. At one point the mattress uplifted and flipped against the pier before falling back down in a deformed state. Views of the two piers at the end of Run 4 are given in Figure 3.30.



(a)



(b)

**Figure 3.30.** a) View of the rectangular pier showing edge failure at the end of Run 4 of series TF-CB. b) View of the cylindrical pier showing the deformation of the mattress at the end of Run 4 of series TF-CB.

Based on the observed poor performance of the cable tied blocks in the absence of a geotextile, similar experiments were performed in the Main Channel with a partial geotextile. The partial geotextile conformed to the design used for riprap and shown in Figure 3.16. The block mattresses were fabricated at SAFL. The individual blocks had a height  $H_{cb}$  of 25 mm (1 in). They were square in the horizontal, with a side length at the base of 38 mm (1.5 in), tapering to 32 mm (1.24 in) at the top. The blocks were constructed of concrete and had a density  $\rho_{cb}$  of 2400 kg/m<sup>3</sup> (specific gravity of 2.4). The equivalent sphere diameter of riprap  $D_{r50}$  with a density  $\rho_r$  of 2650 kg/m<sup>3</sup> (specific gravity of 2.65) was 37.7 mm.

The runs of series MC-CB1 were performed with a fraction pore space  $p = 0.15$ . Since the mattress did not fail at Run 4 in these experiments, a second series MC-CB2 was conducted so as to reduce the weight of the mattress to 80% of its original value. This was done by removing blocks so as to thin the mattress to yield a value of  $p$  of 0.32. Again failure was not achieved at Run 4. A third series MC-CB3 was conducted by reducing the weight of the mattress to 50% of its original value, yielding a value of  $p$  of 0.575. The mattress did then fail under the conditions of Run 4.

This behavior is in general agreement with that with that predicted by Eq. (3.11) applied to the conditions of Tables 3.23b, 3.23d and 3.23f for the rectangular pier (in conjunction with Table 3.4). At  $p = 0.15$ , the minimum value for  $H_{cb}$  to prevent failure is predicted to be 7.1 mm at Run 3 and 11.8 mm at Run 4. At  $p = 0.32$  these values respectively increase to 9.8 mm and 18.4 mm. At  $p = 0.575$  they increase to the respective values 13.8 and 23.4 mm. In light of the fact that the actual value of  $H_{cb}$  was 25.4 mm, however, Eq. (3.11) is not sufficiently conservative. That is, uplift failure was observed during Run 4 of series MC-CB3 for a block height that should have just barely prevented failure.

A schematic view of the block mattress used in the Main Channel is given in Figure 3.31; placement is schematized in Fig. 3.32. The initial placement of the mattress is shown in Figure 3.33

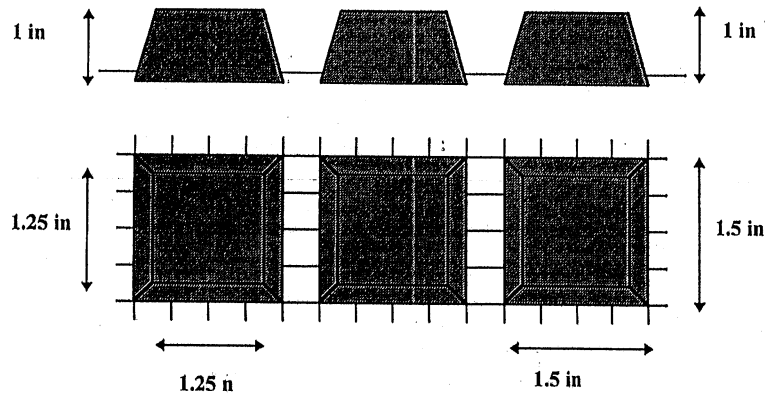


Figure 3.31. Cable-tied blocks used for the Main Channel experiments.

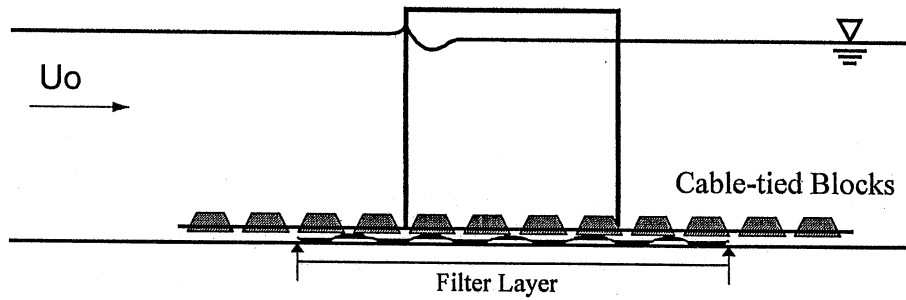
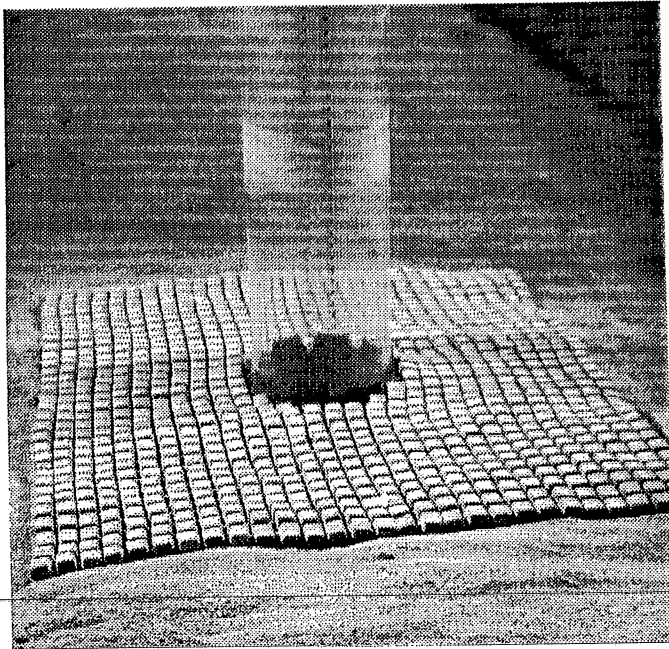


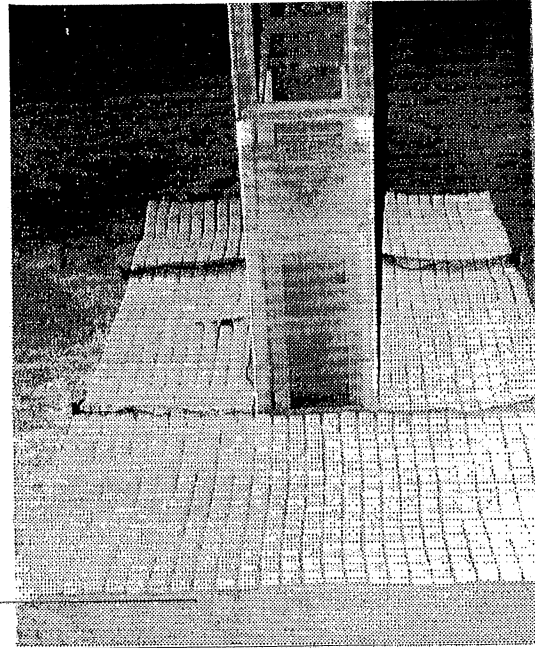
Figure 3.32. Schematic placement of cable-tied blocks and geotextile around a bridge pier.

The results for scour depth are presented in Tables 3.23a – 3.23f and Figures 3.34 and 3.35. In the case of the circular pier the performance of the cable tied blocks with partial geotextile was essentially flawless even under conditions of Run 4 of series MC-CB1. In the case of the rectangular pier for the same series, the performance appears as marginal in terms of  $r_s$ , with reductions in maximum scour of 66% for Run 2, 61% for Run 3 and 65% for Run 4. It can be seen, however, from Figure 3.34 that the performance of the cable tied blocks in series MC-CB1 was much better than that of TF-CB, implying that the addition of a geotextile results in a major improvement.

The values of  $r_s$  in Table 3.23b for the case of the rectangular pier tend to mask what was otherwise quite acceptable performance. The maximum scour depth was often not realized in the immediate vicinity of the pier. When it was near a pier, the zone of scour tended to be quite localized, and apparently associated with the leaching of sand from between the mattress and the pier. Based on an overall evaluation of the performance of the cable tied blocks of series MC-CB1, they were judged to be a viable and useful alternative to riprap with a geotextile. Later experiments conducted with the geotextile sealed to the pier (series MC-CMB) showed excellent performance.



(a)



(b)

**Figure 3.33.** a) View of placement of the cable-tied blocks around the cylinder pier in the Main Channel. b) View of placement of the cable-tied blocks around the rectangular pier in Main Channel.

**Table 3.23a.** Results of series MC-CB1 for the circular pier

<i>Cable-tied blocks with geotextile</i>				
<b>Flume:</b>	Main channel			
<b>Data set:</b>	MC-CB1			
<b>Pier type:</b>	Circular			
Run	$U/U_c$	$d_s/D$	$d_s/d_{s0}$	$r_s$
1	1.468	-0.186	n/a	n/a
2	2.635	-0.164	-0.257	100%
3	4.058	0.033	0.036	96%
4	5.384	0.000	0.000	100%

**Table 3.23b.** Results of series MC-CB1 for the rectangular pier

<i>Cable-tied blocks with geotextile</i>				
<b>Flume:</b>	Main channel			
<b>Data set:</b>	MC-CB1			
<b>Pier type:</b>	Rectangular			
Run	$U/U_c$	$d_s/D$	$d_s/d_{s0}$	$r_s$
1	1.465	0.137	n/a	n/a
2	2.825	0.373	0.336	66%
3	4.386	0.537	0.395	61%
4	5.653	0.611	0.345	65%

Table 3.23c. Results of series MC-CB2 for the circular pier

<i>Cable-tied blocks with geotextile</i>				
<b>Flume:</b> <i>Main channel</i>				
<b>Data set:</b> <i>MC-CB2</i>				
<b>Pier type:</b> <i>Circular</i>				
Run	$U/U_c$	$d_s/D$	$d_s/d_{s0}$	$r_s$
3	4.072	-0.044	-0.048	100%
4	5.808	0.267	0.218	78%

Table 3.23d. Results of series MC-CB2 for the rectangular pier

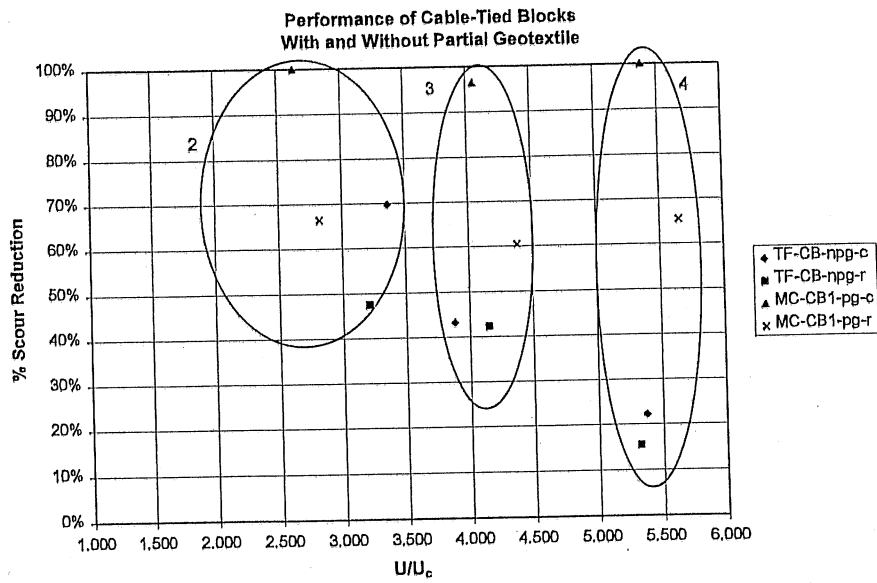
<i>Cable-tied blocks with geotextile</i>				
<b>Flume:</b> <i>Main channel</i>				
<b>Data set:</b> <i>MC-CB2</i>				
<b>Pier type:</b> <i>Rectangular</i>				
Run	$U/U_c$	$d_s/D$	$d_s/d_{s0}$	$r_s$
3	4.606	0.951	0.700	30%
4	6.295	0.939	0.530	47%

Table 3.23e. Results of series MC-CB3 for the circular pier

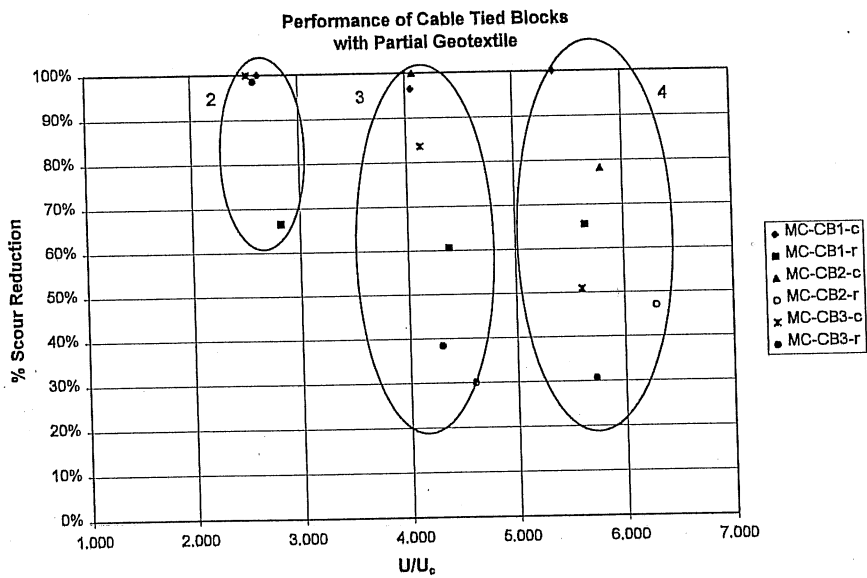
<i>Cable-tied blocks with geotextile</i>				
<b>Flume:</b> <i>Main channel</i>				
<b>Data set:</b> <i>MC-CB3</i>				
<b>Pier type:</b> <i>Circular</i>				
Run	$U/U_c$	$d_s/D$	$d_s/d_{s0}$	$r_s$
2	2.527	-0.052	-0.081	100%
3	4.137	0.151	0.164	84%
4b	5.611	0.602	0.492	51%

Table 3.23f. Results of series MC-CB3 for the rectangular pier

<i>Cable-tied blocks with geotextile</i>				
<b>Flume:</b> <i>Main channel</i>				
<b>Data set:</b> <i>MC-CB3</i>				
<b>Pier type:</b> <i>Rectangular</i>				
Run	$U/U_c$	$d_s/D$	$d_s/d_{s0}$	$r_s$
2	2.595	0.016	0.015	99%
3	4.308	0.839	0.617	38%
4b	5.732	1.227	0.694	31%



**Figure 3.34.** Performance of the cable tied blocks with partial geotextile of series MC-CB1 as compared to the cable tied blocks without geotextile of series TF-CB.



**Figure 3.35.** Comparison of the performance of cable tied blocks in the runs of series MC-CB1, MC-CB2 and MC-CB3.

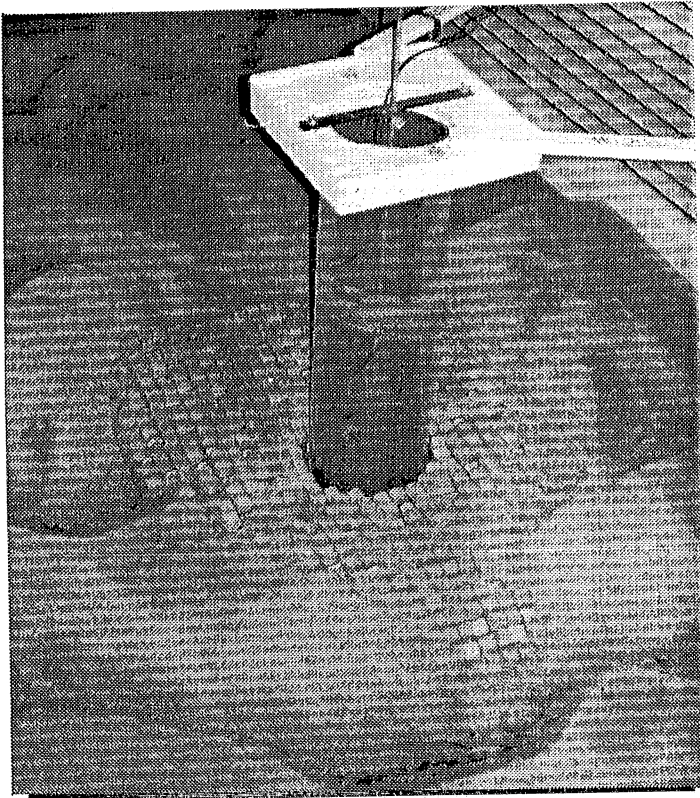
Both the tables and the figures document a gradual degradation of performance as the mattress is made lighter. In the case of the circular pier, the performance is always acceptable at Runs 2 and 3. In the case of the rectangular pier the performance is always unacceptable at Run 3. Under the conditions of Run 4 of series MC-CB3, incipient uplift failure was observed at the circular pier and actual uplift was observed at the rectangular pier.

Photographic documentation of the performance of the cable tied blocks is provided in Figures 3.36, 3.37 and 3.38. The first of these, taken at the end of Run 2 of series MC-CB2, documents the ability of the block mattress to anchor the geotextile. Note, however, the scour at the upstream end of the rectangular pier. This was caused by the leaching of sand from the gap between the geotextile and the pier. The second of these figures documents the state of the mattresses at the end of Run 4 of series MC-CB3. A better view of the uplift failure at the rectangular pier at the end of Run 4 of series MC-CB3 is given in the last of these figures.

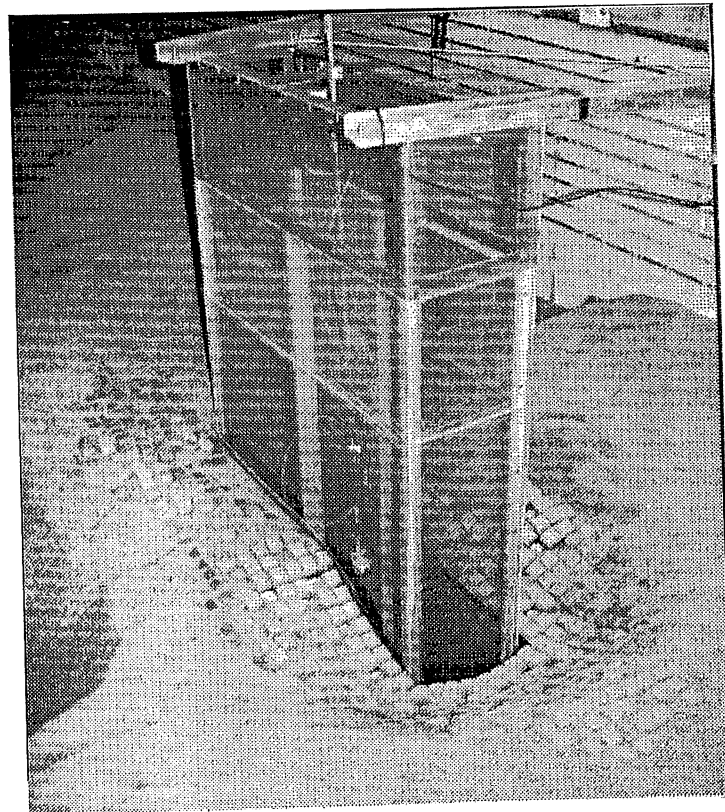
In summary, cable tied blocks with a partial geotextile appear to offer a viable alternative to riprap with a geotextile. The experiments do not directly support the use of cable tied blocks with the mattress weight determined by means of Eqs. (3.10a) and (3.10b), as they are not sufficiently conservative. A comparison of Eqs. (2.4) and (2.5) indicates that to obtain stability near a bridge pier riprap size must be doubled as compared to the stable value on a bed away from a bridge pier. Applying a similar reasoning to Eqs. (3.10a) and (3.10b), which were developed based on data not pertaining to bridge piers, the following revised value of  $a_{cb}$  is proposed for cable tied block mattresses installed near round bridge piers.

$$a_{cb} = 0.20 \quad (3.13)$$



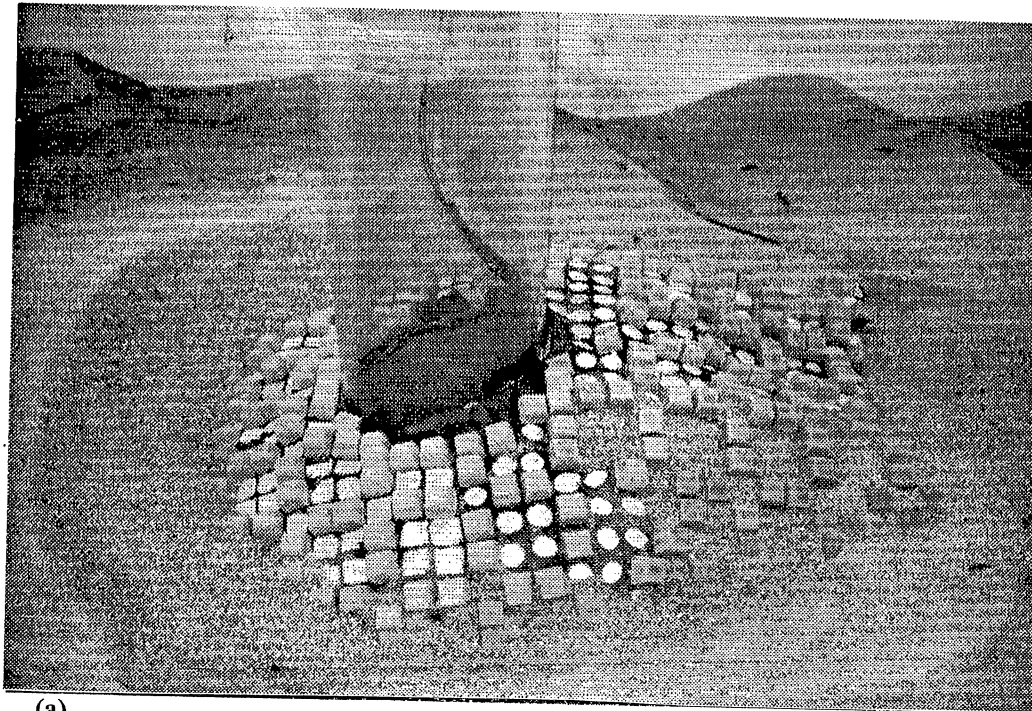


(a)

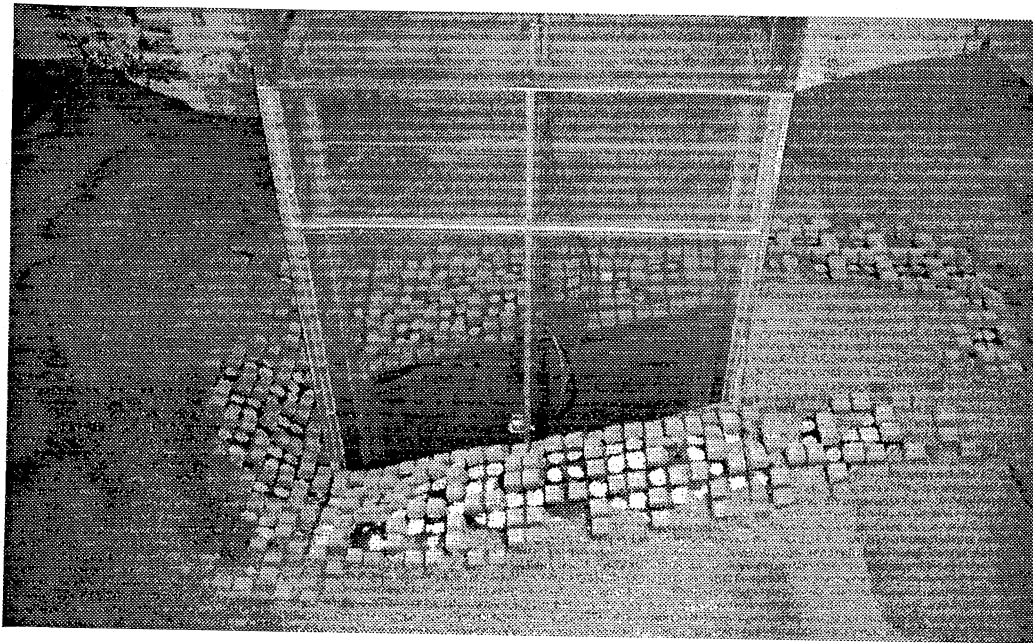


(b)

**Figure 3.36.** a) View of the circular pier at the end of Run 4 of series MC-CB2, showing the excellent performance of the cable-tied blocks in anchoring the geotextile. b) View of the rectangular pier at the end of Run 4 of series MC-CB2, showing the excellent performance of the cable-tied blocks in anchoring the geotextile.

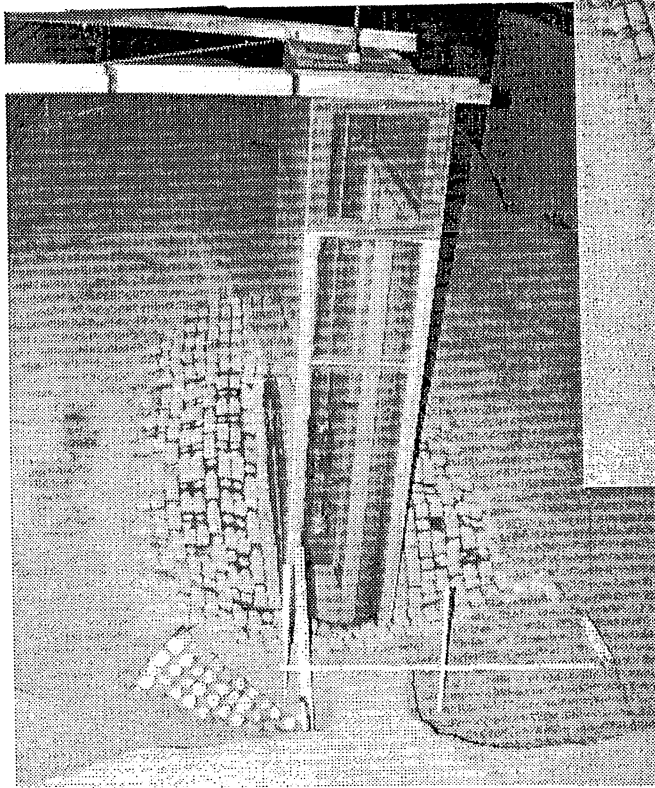


(a)



(b)

**Figure 3.37.** a) Top view of the cable-tied block incipient failure near the circular pier at the end of Run 4 of series MC-CB3. b) Top view of the cable-tied block failure near the rectangular pier at the end of Run 4 of series MC-CB3.



(a)



(b)

**Figure 3.38.** a) View of uplift failure at the rectangular pier at the end of Run 4 of series MC-CB3. b) Another view of the uplift failure.

### 3.6.9 Runs with Grout Filled Bags

Grout or concrete filled bags are an appealing option to riprap when the latter is either unavailable or expensive, or when environmental restrictions prevent its installation. In addition, concrete is a substance with which bridge engineers are quite familiar. The experimental results reported below, however, are not overly encouraging.

Six run series were performed with grout filled bags, all in the Main Channel. They are series MC-GB1, MC-GB2, MC-GB3, MC-GB4, MC-GB5 and MC-GB6. A partial geotextile was always placed below the grout filled bags. In the final two series the bags were stitched to the geotextile, and in the final series the geotextile was sealed to the pier. The rectangular pier was studied in all series; the circular pier was studied only in the first of these.

The grout was a mortar with 1 part cement to 5 parts sand by volume. The material had a density of  $2000 \text{ kg/m}^3$  (specific gravity of 2.0) upon curing. In series MC-GB1, MC-GB2 and MC-GB3 plastic bags with dimensions of (12 in) by (3 in) by (1 in) were used to create units with a weight of 1.18 kg. The equivalent spherical diameter  $D_{r50}$  of riprap with a density of  $2650 \text{ kg/m}^3$  (specific gravity of 2.65) is 95 mm, i.e. well in excess of the value of 53.8 mm used for the standard riprap in the Main Channel. Of note is that even with this large equivalent size, the grout filled bags tended to perform rather poorly when compared to riprap. In series MC-GB4, MC-GB5 and MC-GB6 even longer bags were used, as described in the figures below.

The placement configurations of the grout filled bags are schematized for the first four of the six series in Figures 3.39a to 3.39d. In series MC-GB5 the configuration was the same as series MC-GB4 except that the transverse bags on the bottom were stitched to the geotextile. In series MC-GB6 the configuration was the same as series MC-GB5 except that the geotextile was sealed to the pier with duct tape. The setting of the geotextile underneath was identical to that used for the riprap studies described previously. Its areal extend is shown in the figures. Note that the bags were imbricated against each other in an attempt to increase stability.

In the configuration of Figure 3.39a (series MC-GB1) the grout bags were placed parallel to the flow so as to approximate the same aerial cover obtained using riprap in previous experiments. The arrangement was adopted based on studies by Fotherby (1992, 1993), Bertoldi et al. (1994) and Jones (1995a,b). Each bag was molded so as to naturally imbricate against each other for one-third of its length.

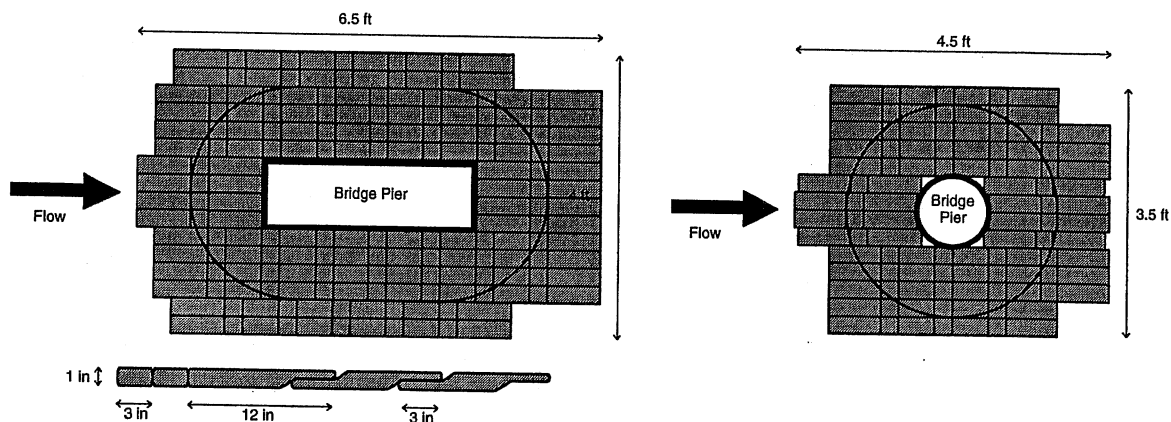
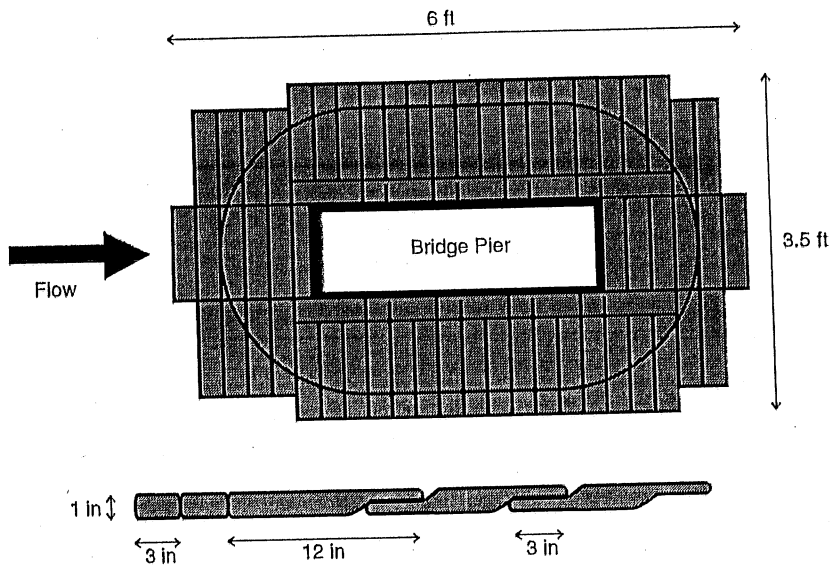


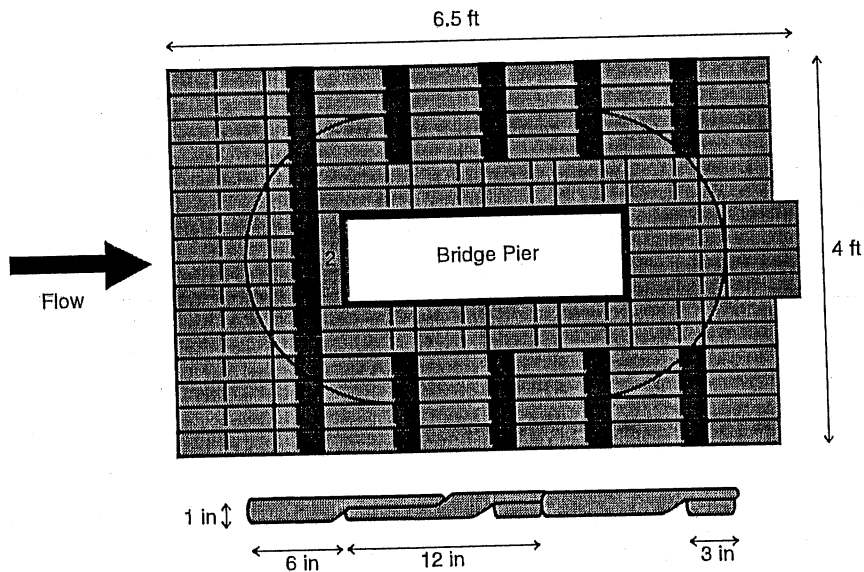
Figure 3.39a. Placement of grout filled bags around the rectangular and circular piers for series MC-GB1.



**Figure 3.39b.** Placement of grout filled bags around the rectangular pier for series MC-GB2.

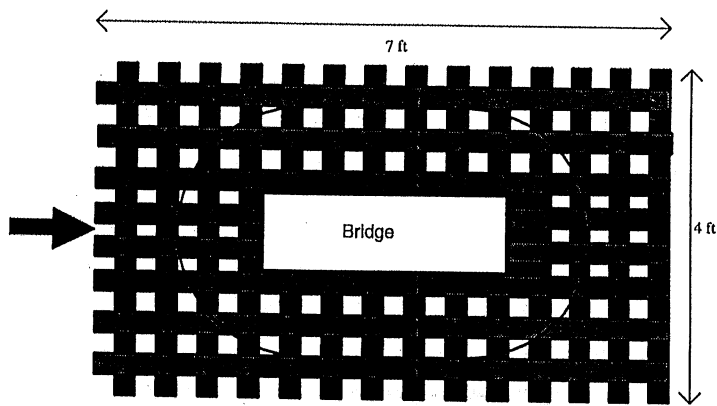
Figure 3.39b describes the configuration of series MC-GB2. Here the bags are placed perpendicular to the flow, with a single row of bags parallel to the flow along each side of the pier. It was adopted after the poor performance of the previous configuration.

Figure 3.39c describes the configuration of series MC-GB3. A combination of parallel and perpendicular grout bags were provided for better interlocking. The bags perpendicular to the flow were placed immediately above the geotextile in rows separated by less than a bag length. The parallel bags were then placed on top of these so as to form a mesh covering the area. The shape of every bag was molded to lock into adjacent bags for better interlocking.



**Figure 3.39c.** Placement of grout filled bags around the rectangular pier for series MC-GB3.





**Figure 3.39d.** Placement of grout filled bags around the rectangular pier for series MC-GB4, MC-GB5 and MC-GB6.

Figure 3.39d shows the configuration of series MC-GB4, MC-GB5 and MC-GB6. Here long grout bags were placed perpendicular to the flow in the bottom layer (just above the geotextile) and parallel to the flow on top. The long bags were adopted due to the tendency of shorter bags to disperse easily under the influence of bedforms. In particular it was hoped that the bags would be sufficiently long compared to dune wavelength to resist spreading. As noted above, in series MC-GB5 and MC-GB6 the bottom layer of bags was stitched to the geotextile, and in series MC-GB6 the geotextile was sealed to the pier using duct tape.

The results concerning scour depth are given in Tables 3.24a – 3.24g. In Figure 3.40 the performance of grout filled bags in the configuration of series MC-GB1 is compared for the rectangular and circular pier. In Figure 3.41 the performance of all configurations is compared for the case of the rectangular pier.

**Table 3.24a.** Results of series MC-GB1 for the circular pier

Grout filled bags 1				
<b>Flume:</b>	Main channel			
<b>Data set:</b>	MC-GB1			
<b>Pier type:</b>	Circular			
Run	$U/U_c$	$d_s/D$	$d_s/d_{so}$	$r_s$
1	1.316	-0.188	n/a	n/a
2	2.569	-0.113	-0.178	100%
3	4.063	0.368	0.400	60%
4	5.410	0.678	0.554	45%

Table 3.24b. Results of series MC-GB1 for the rectangular pier

Grout filled bags 1				
Flume: Main channel				
Data set: MC-GB1				
Pier type: Rectangular				
Run	$U/U_c$	$d_s/D$	$d_s/d_{s0}$	$r_s$
1	1.346	-0.012	n/a	n/a
2	2.753	0.091	0.082	92%
3	4.386	0.912	0.671	33%

Table 3.24c. Results of series MC-GB2 for the rectangular pier

Grout filled bags 2				
Flume: Main channel				
Data set: MC-GB2				
Pier type: Rectangular				
Run	$U/U_c$	$d_s/D$	$d_s/d_{s0}$	$r_s$
3	4.210	0.799	0.588	41%

Table 3.24d. Results of series MC-GB3 for the rectangular pier

Grout filled bags 3				
Flume: Main channel				
Data set: MC-GB3				
Pier type: Rectangular				
Run	$U/U_c$	$d_s/D$	$d_s/d_{s0}$	$r_s$
3	4.249	0.399	0.293	71%

Table 3.24e. Results of series MC-GB4 for the rectangular pier

Grout filled bags 4				
Flume: Main channel				
Data set: MC-GB4				
Pier type: Rectangular				
Run	$U/U_c$	$d_s/D$	$d_s/d_{s0}$	$r_s$
3	4.245	0.647	0.476	52%
4	5.856	1.069	0.604	40%

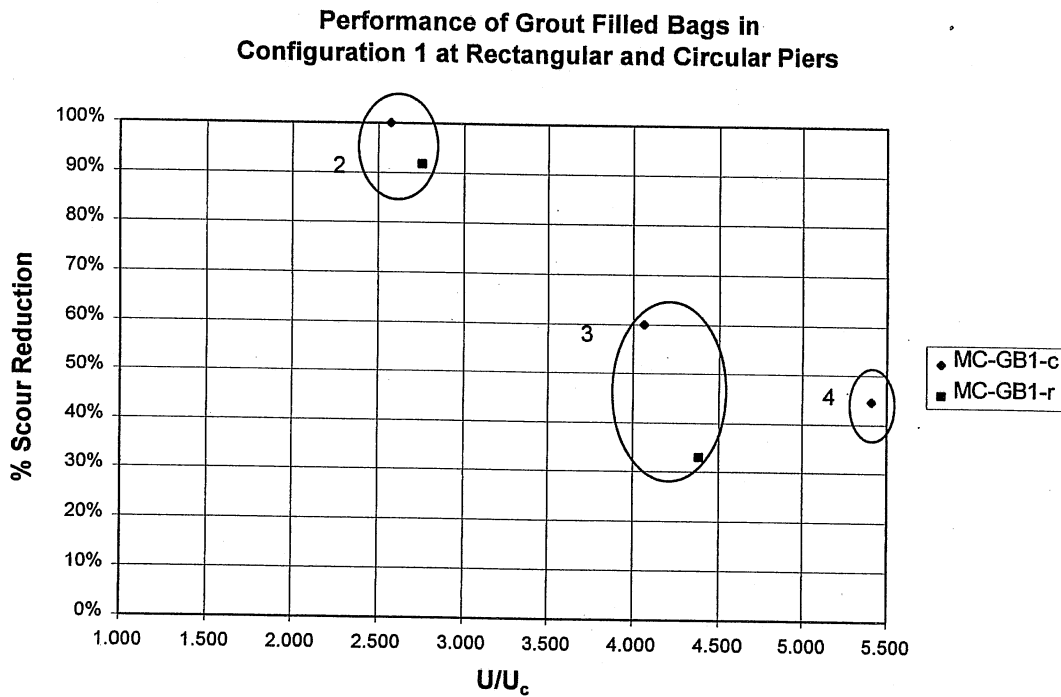
Table 3.24f. Results of series MC-GB5 for the rectangular pier

Grout filled bags 5				
Flume: Main channel				
Data set: MC-GB5				
Pier type: Rectangular				
Run	$U/U_c$	$d_s/D$	$d_s/d_{s0}$	$r_s$
3	3.952	0.433	0.318	68%
4	5.627	1.183	0.668	33%

**Table 3.24g.** Results of series MC-GB6 for the rectangular pier

Grout filled bags 6				
<b>Flume:</b>	Main channel			
<b>Data set:</b>	MC-GB6			
<b>Pier type:</b>	Rectangular			
Run	$U/U_c$	$d_s/D$	$d_s/d_{s0}$	$r_s$
2	2.379	-0.019	-0.017	100%
3	3.879	-0.019	-0.014	100%
4	5.545	1.272	0.719	28%

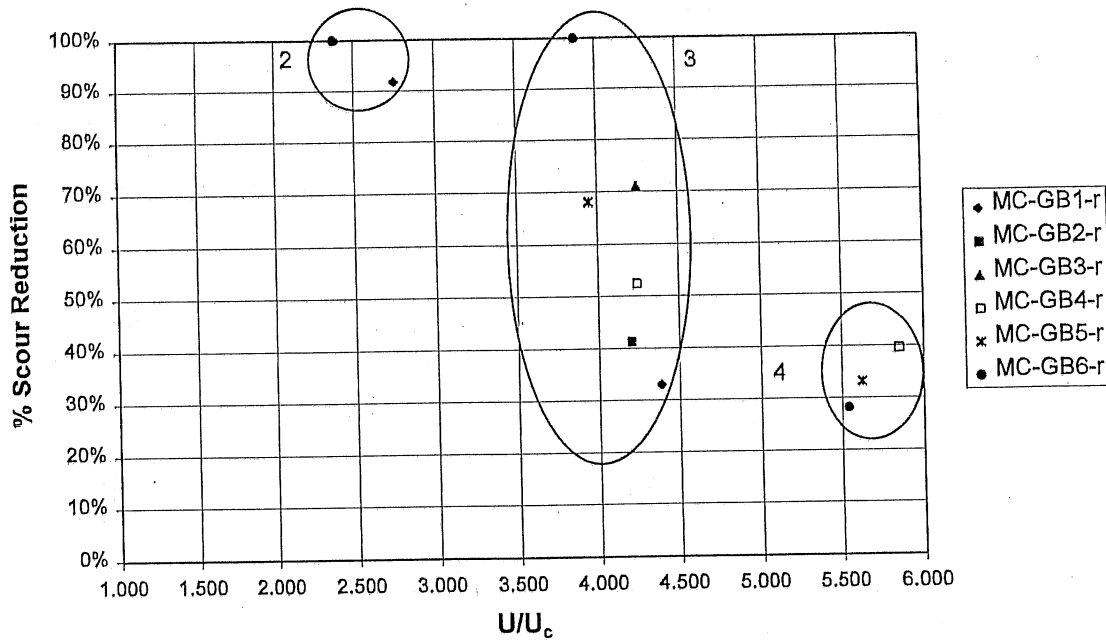
In the case of the circular pier, the performance of the configuration for series MC-GB1 is seen to have been marginal at Run 3 and unacceptable at Run 4. The grout bags tended to disperse, but not catastrophically as in the case of the rectangular pier. In the latter case the bags slid off the geotextile and dispersed during Run 3 and failed catastrophically during Run 4. Performance was already inadequate at the rectangular pier by Run 3.



**Figure 3.40.** Comparison of performance of grout filled bags for the rectangular circular piers in series MC-GB1.

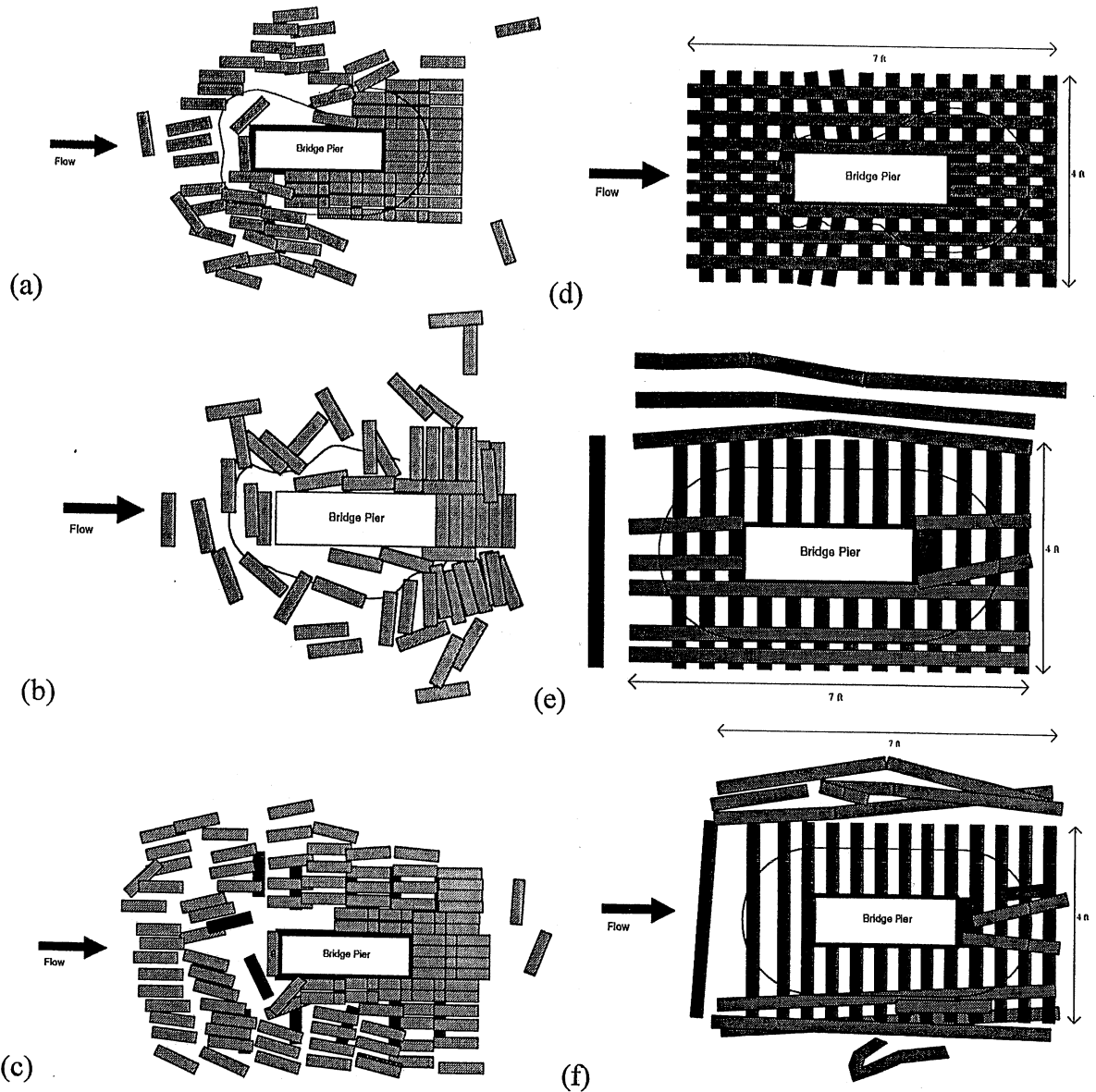


**Performance of Grout Filled Bags in  
Configurations 1 to 6 at Rectangular Piers**



**Figure 3.41.** Performance of the grout filled bags at the rectangular pier for all the runs.

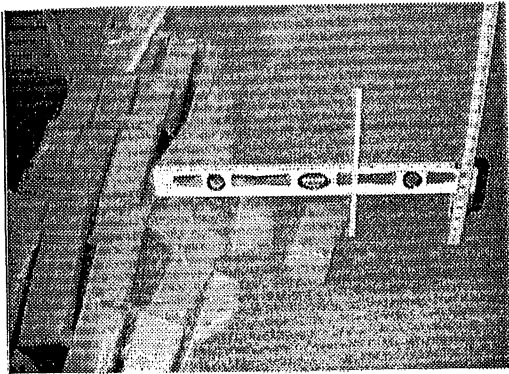
The results for the other runs all pertain to the rectangular pier. The configuration of series MC-GB2 provided inadequate protection at Run 3. In the case of Run 3 of series MC-GB3 the protection was barely adequate, and in the corresponding case of series MC-GB4 it was barely marginal. Performance improved to marginal bordering on adequate for the corresponding run of series MC-GB5, and finally became acceptable (in fact nearly perfect) for Run 3 of series MC-GB6. This good performance in the last series was obtained at the expense of a) stitching the bags to the geotextile and b) sealing the geotextile to the pier. The same can be done, however, with cable-tied blocks using units with a much smaller individual weight. Grout filled bags were thus judged to be relatively poor performers in regard to scour protection at bridge piers.



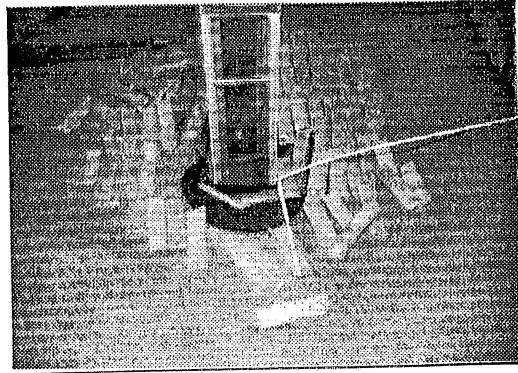
**Figure 3.42.** Pattern of bag dispersal observed at the end of the last run of each series. a) Series MC-GB1. b) Series MC-GB2. c) Series MC-GB3. d) Series MC-GB4. e) Series MC-GB5. f) Series MC-GB6.

The main reason for this poor performance appears to be the fact that grout-filled bags offer a surface that is much smoother than riprap. They are thus prone to sliding and interlock poorly. A dune field promotes this sliding tendency, to the extent that the bags show a tendency to disperse broadly. This is summarized in the sketch of Figure 3.42, which was prepared from photographs.

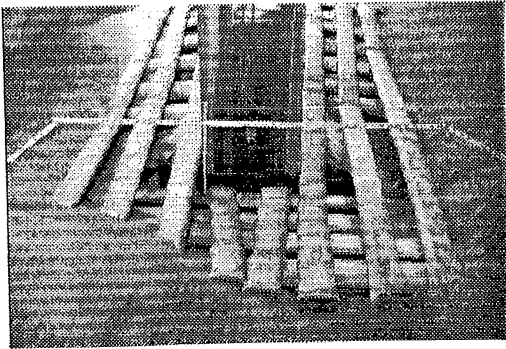
Both the geometry of the bags and their equivalent diameter as riprap of 95 mm (larger for the long bags) should have precluded direct entrainment by the flow. The tendency to slide against each other and over a sand bed, however, caused some of the bags to be dispersed far downstream of the pier. Figure 3.43 provides photographic evidence of various problems observed with grout filled bags.



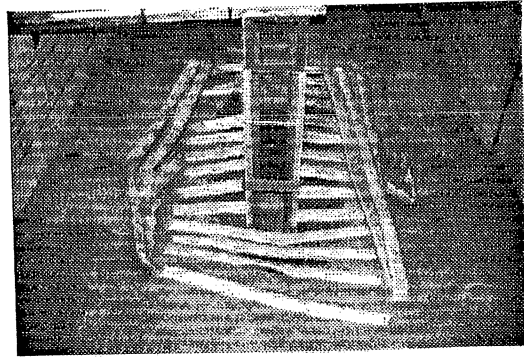
(a)



(b)



(c)



(d)

**Figure 3.43.** a) Sinking of the grout bags. b) Dispersion of the grout bags. c) Undermining of the grout bags. d) Failure of the grout bags.

Anchoring of the geotextile did not occur in these experiments. Either a bag sat on top of the geotextile or slid away from it. The longer bags of the last three series tended to move less and initially provided better protection against scour. This arrangement, however, lacks flexibility to the point that groups of bags could be left undermined and hanging. This is shown in Figure 3.43c. This undermining resulted in a failure of the geotextile in the case of Series MC-GB4, even though the lattice of bags held up relatively well against the flow. The outline of the deformed geotextile is shown in Figure 3.42d; it was evidently providing no protection on the upstream side of the pier by the end of the series.

In conclusion, grout filled bags were found to be inadequate as a means of pier scour protection under mobile-bed conditions. The poor performance is related to the relatively smooth surface and regular shapes of the bags. They do not provide good interlocking, do not act to anchor the geotextile and easily slide and disperse in a dune field.

### 3.6.10 Runs with Permeable Sheet Piles

Permeable sheet piles are based on the principle of permeable dikes in rivers and snow fences. Permeable dikes have often been used successfully along the banks of rivers in order to induce bank deposition. Snow fences are likewise proven means of inducing deposition. It was hoped that a similar beneficial effect at bridge piers could be induced by placing submerged permeable sheet piles in front of them.

All tests of this countermeasure were performed in the Tilting Flume. A substantial series of pilot tests were performed in order to optimize the design of the permeable sheet piles. Since performance was relatively poor under mobile-bed conditions even with optimal design, the pilot tests are not discussed in detail here. Three configurations were selected for detailed testing, one in series TF-SP1, one in series TF-SP2 and one in series TF-SP3; these are described in Figure 3.44.

Figure 3.44a describes the basic configuration used in series TF-SP1, of which the succeeding two are variants. The sheet piles were designed with two panels forming an arrow shape pointing upstream. The panels were placed at an angle of  $90^\circ$  to each other in order to render them functional even when the approach flow is somewhat skewed relative to the pier. The apex of the arrow was placed a distance  $4 D$  upstream of the upstream face of the pier. Each panel had a length of  $3 D$ . The top of the sheet piles protruded  $1 D$  above the mean elevation of the bed. The sheet piles were thus completely submerged under the conditions of Runs 3 and 4, and barely emergent under the conditions of Run 2.

Each panel was constructed of wood slats with a length of  $3 D$  and a width of  $0.25 D$ . The slats were spaced evenly so as to produce a surface 50% of the area of which is open to the flow. Enough slats were provided so as to bury a substantial number of them below the bed at low flow. This was done so as to maintain performance even when subject to local scour around the sheet piles themselves. The panels were attached to three vertical piles, one at the apex and one on each side, which were buried deeply in order to anchor the configuration.

The configuration of Figure 3.44b for series TF-SP2 is identical to the previous one except for the installation of two horizontal panels within the slats to prevent downwelling of the flow toward the pier. Each horizontal panel has a triangular shape and extends a distance  $1 D$  downstream of the apex. One slat was positioned to rest on top of the second slat from the top, and the other was positioned two slats down.

In the configuration of Figure 3.44c (series TF-SP3) the horizontal panels have been moved to the first and third slats from the top and extended for the full length of the arrow. In addition, the slats have been angled  $10^\circ$  upward, in an attempt to further suppress flow downwelling near the pier.

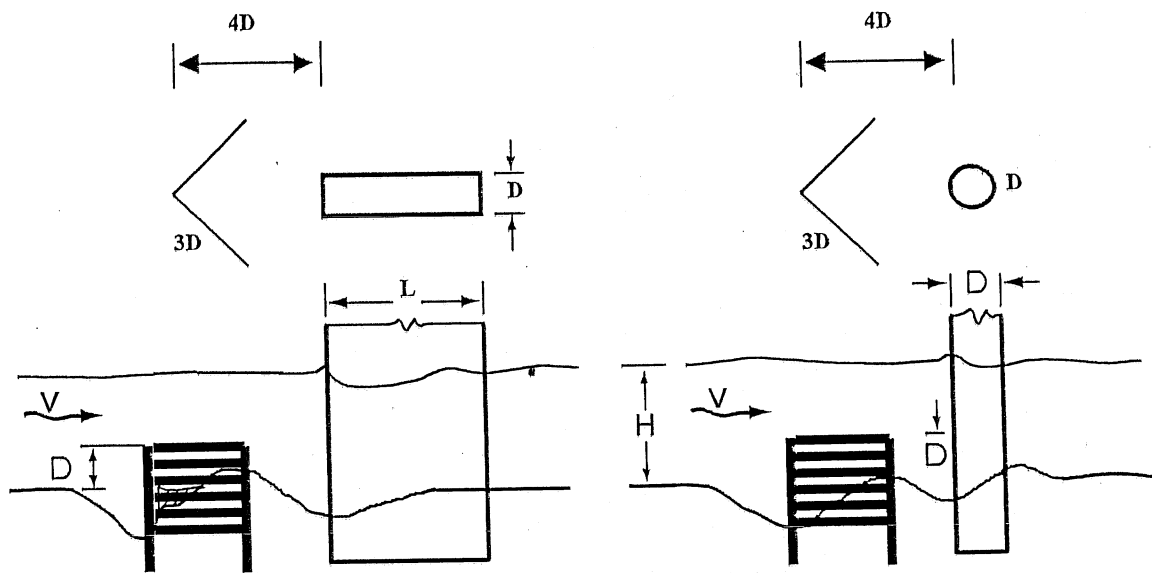


Figure 3.44a. Sheet pile configuration for series TF-SP1.

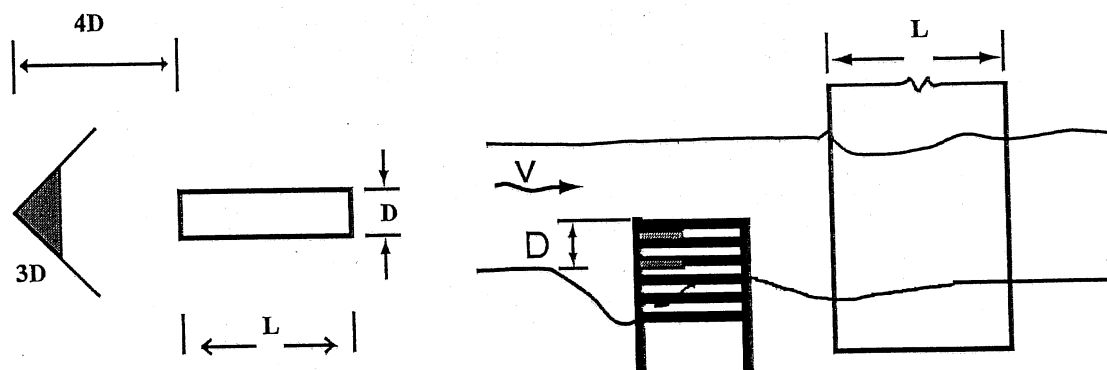


Figure 3.44b. Sheet pile configuration for series TF-SP2.

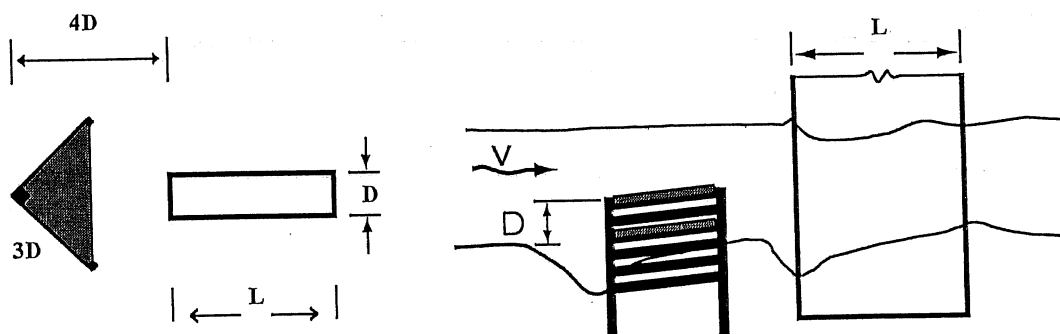
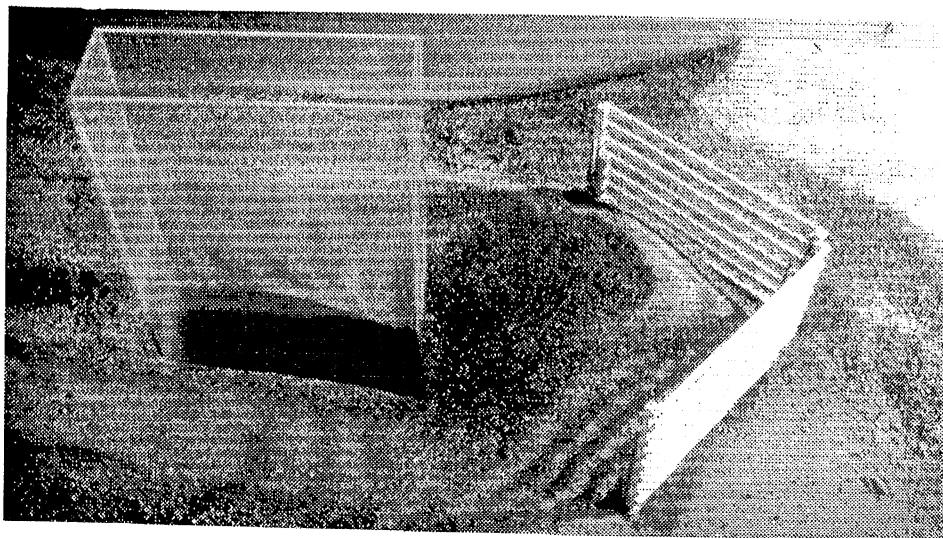
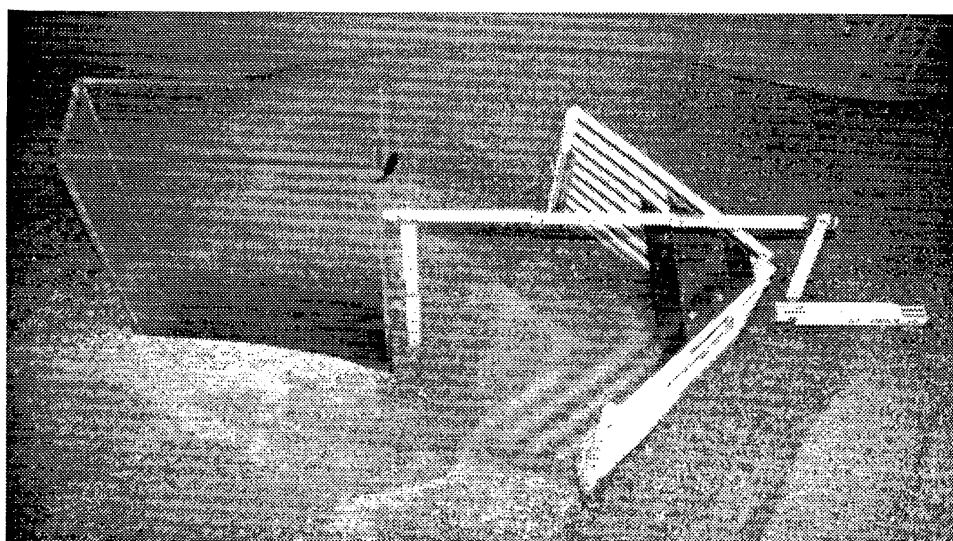


Figure 3.44c. Sheet pile configuration for series TF-SP3.

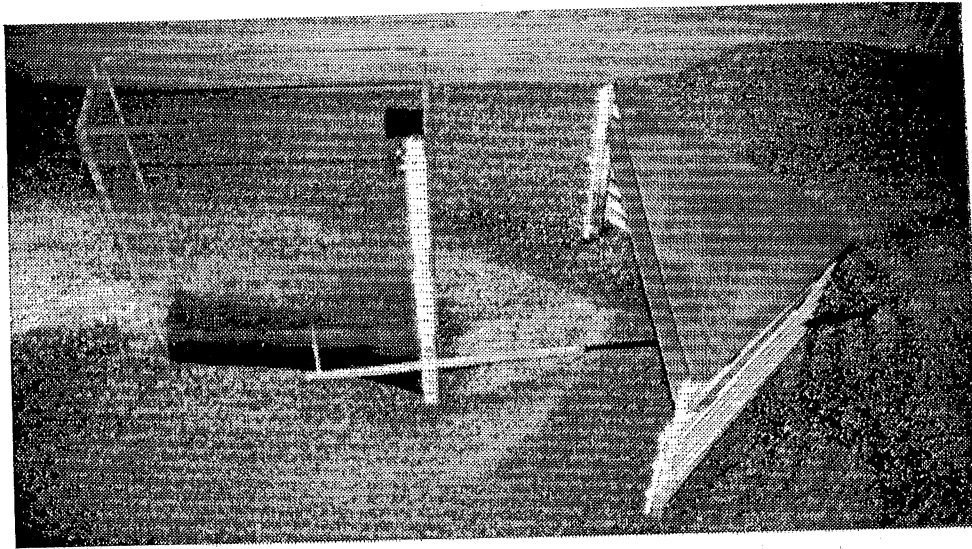
All three configurations are shown photographically in Figure 3.45; the images pertain to the end of the final run for each series.



**Figure 3.45a.** View of the rectangular pier at the end of series TF-SP1.



**Figure 3.45b.** View of the rectangular pier at the end of series TF-SP2.



**Figure 3.45c.** View of the rectangular pier at the end of series TF-SP3.

The results in regard to scour protection are presented in Tables 3.25a – 3.25f and Figure 3.46. The results are entirely unimpressive, with the scour protection provided in the unacceptable range for every case, including Run 2. Evidently the flow during a flood against a bridge pier in the center of a channel is too intense for permeable dikes to have a significant beneficial effect against scour.

**Table 3.25a.** Results of series TC-SP1 for the circular pier

<i>Sheet piles 1</i>				
<b>Flume:</b>	<i>Tilting flume</i>			
<b>Data set:</b>	<i>TF-SP1</i>			
<b>Pier type:</b>	<i>Circular</i>			
Run	$U/U_c$	$d_s/D$	$d_s/d_{s0}$	$r_s$
2	2.747	0.684	0.687	31%
3	3.852	0.737	0.667	33%
4	5.081	1.137	0.817	18%

**Table 3.25b.** Results of series TF-SP1 for the rectangular pier

<i>Sheet piles 1</i>				
<b>Flume:</b>	<i>Tilting flume</i>			
<b>Data set:</b>	<i>TF-SP1</i>			
<b>Pier type:</b>	<i>Rectangular</i>			
Run	$U/U_c$	$d_s/D$	$d_s/d_{s0}$	$r_s$
2	2.619	0.931	0.637	36%
3	3.874	1.248	0.722	28%
4	5.175	1.744	0.875	13%

**Table 3.25c.** Results of series TF-SP2 for the circular pier

<i>Sheet piles 2</i>				
<b>Flume:</b>	<i>Tilting flume</i>			
<b>Data set:</b>	<i>TF-SP2</i>			
<b>Pier type:</b>	<i>Circular</i>			
Run	$U/U_c$	$d_s/D$	$d_s/d_{s0}$	$r_s$
3	4.027	0.819	0.741	26%

**Table 3.25d.** Results of series TC-SP2 for the rectangular pier

<i>Sheet piles 2</i>				
<b>Flume:</b>	<i>Tilting flume</i>			
<b>Data set:</b>	<i>TF-SP2</i>			
<b>Pier type:</b>	<i>Rectangular</i>			
Run	$U/U_c$	$d_s/D$	$d_s/d_{s0}$	$r_s$
3	4.014	1.438	0.832	17%

**Table 3.25e.** Results of series TF-SP3 for the circular pier

<i>Sheet piles 3</i>				
<b>Flume:</b>	<i>Tilting flume</i>			
<b>Data set:</b>	<i>TF-SP3</i>			
<b>Pier type:</b>	<i>Circular</i>			
Run	$U/U_c$	$d_s/D$	$d_s/d_{s0}$	$r_s$
2	2.964	2.964	0.592	41%
3	3.805	3.805	0.533	47%
4	5.203	5.203	0.543	46%

**Table 3.25f.** Results of series TF-SP3 for the rectangular pier

<i>Sheet piles 3</i>				
<b>Flume:</b>	<i>Tilting flume</i>			
<b>Data set:</b>	<i>TF-SP3</i>			
<b>Pier type:</b>	<i>Rectangular</i>			
Run	$U/U_c$	$d_s/D$	$d_s/d_{s0}$	$r_s$
2	2.806	1.007	0.690	31%
3	3.797	1.010	0.584	42%
4	5.199	1.555	0.1780	22%



### Performance of Sheet Piles

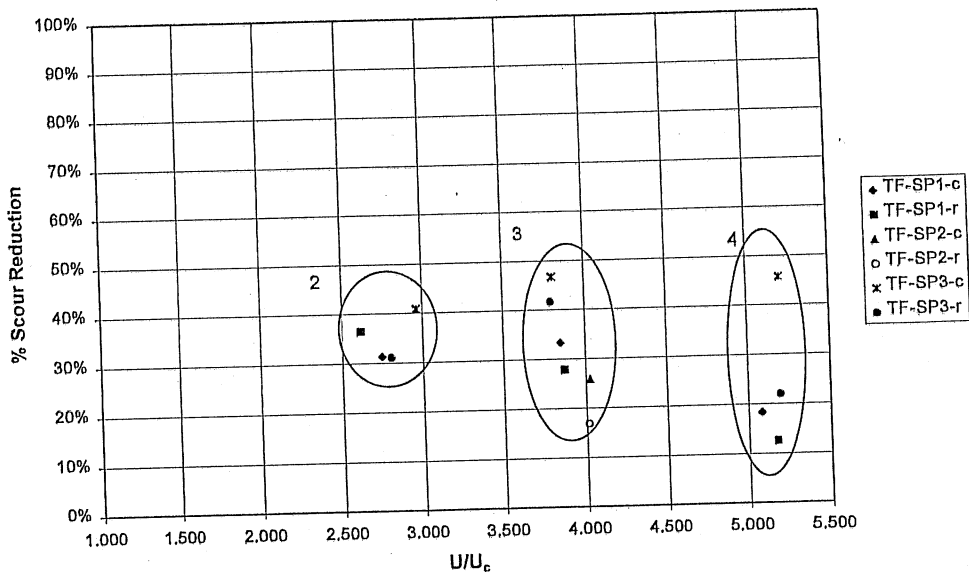


Figure 3.46. Performance of permeable sheet piles.

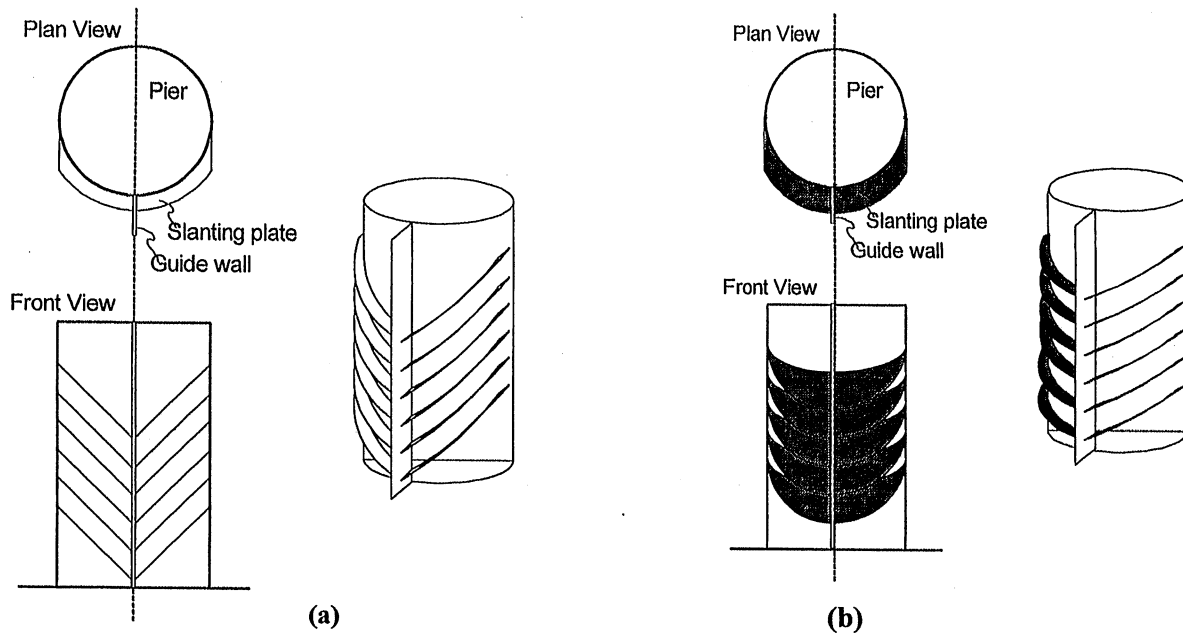
In summary, permeable sheet piles show minimal scour protection under mobile bed conditions typical of field floods. Only the case of the configuration of Figure 3.44c showed some promise, but even in this case the scour reduction  $r_s$  was always less than 50%. These values are much less than the 70% reduction reported by Maza (1967) for clear water conditions.

#### 3.6.11 Runs with Pier Attached Vanes

These runs were performed in the Tilting Flume as series TF-PV1 and TF-PV2. The goal was to obtain scour prevention by attaching vanes to the pier to as to suppress the horseshoe vortex responsible for scour.

The configuration of Figure 3.47a was tested in series TF-PV1 and that of Figure 3.47b was tested in series TF-PV2. The first of these was duplicated from the previous work by Daido and Yano (1995). Here a vertical splitter wall (guide wall) is placed so that it extends vertically along the center upstream face of the pier. On either side of the guidewall is a series of vanes attached to the surface of the pier, stacked vertically and angled 45° upward from the horizontal. The distance between plates was 0.5 D, and they were placed evenly so as to cover the upstream half of the pier. Several of the vanes were buried so that some scour protection would be provided even in the event of scour.

The configuration of Figure 3.47b is similar to the previous one, except that the vanes are angled downward at 45° in the streamwise-vertical plane. Both configurations were designed so as to withstand some skewing of the approach flow relative to the pier.



**Figure 3.47.** a) Schematic of the pier-attached vanes in series TF-PV1. b) Schematic of the pier-attached vanes in series TF-PV2.

Neither arrangement of pier-attached vanes proved to be very effective, as documented in Tables 3.26a – 3.26d and Figure 3.48. One feature was notable. Whenever the scour progressed below the lowest vane, the resulting scour hole was larger than in the absence of vanes. That is, the vanes simply rendered the pier effectively larger, producing a commensurately larger scour hole.

**Table 3.26a.** Results of series TF-PV1 for the circular pier

<i>Pier-attached vanes 1</i>				
<b>Flume:</b>	<i>Tilting flume</i>			
<b>Data set:</b>	<i>TF-PV1</i>			
<b>Pier type:</b>	<i>Circular</i>			
Run	$U/U_c$	$d_s/D$	$d_s/d_{s0}$	$r_s$
2b	2.908	0.820	0.823	18%
3	3.967	1.042	0.942	6%
4	5.115	0.841	0.604	40%

**Table 3.26b.** Results of series TF-PV1 for the rectangular pier

<i>Pier-attached vanes 1</i>				
<b>Flume:</b>	<i>Tilting flume</i>			
<b>Data set:</b>	<i>TF-PV1</i>			
<b>Pier type:</b>	<i>Rectangular</i>			
Run	$U/U_c$	$d_s/D$	$d_s/d_{s0}$	$r_s$
2b	2.833	0.893	0.611	39%
3	3.886	1.504	0.870	13%
4	5.262	1.533	0.769	23%

Table 3.26c. Results of series TF-PV2 for the circular pier

Pier-attached vanes 2				
Flume:		Tilting flume		
Data set:		TF-PV2		
Pier type:		Circular		
Run	$U/U_c$	$d_s/D$	$d_s/d_{s0}$	$r_s$
2	2.729	0.502	0.504	50%
3	4.159	0.752	0.680	32%
4	5.171	0.992	0.712	29%

Table 3.26d. Results of series TF-PV2 for the rectangular pier

Pier-attached vanes 2				
Flume:		Tilting flume		
Data set:		TF-PV2		
Pier type:		Rectangular		
Run	$U/U_c$	$d_s/D$	$d_s/d_{s0}$	$r_s$
2	2.578	0.787	0.539	46%
3	4.245	1.537	0.889	11%
4	4.969	1.520	0.762	24%

Performance of Pier-Attached Vanes

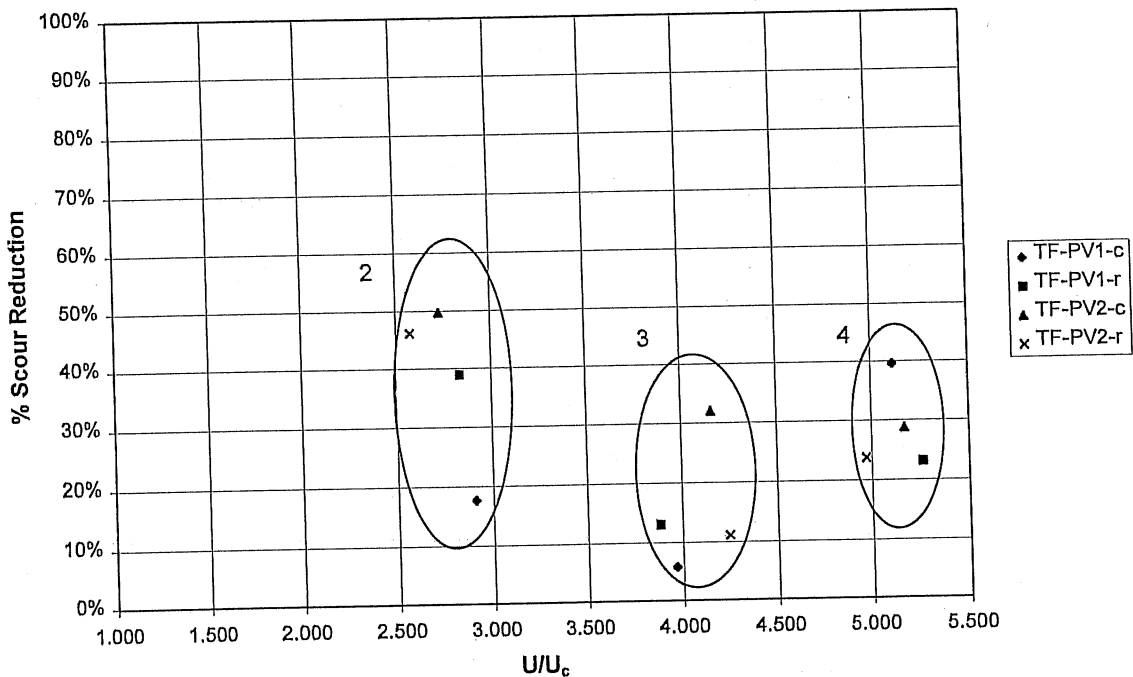


Figure 3.48. Performance of pier-attached vanes.

In summary, pier-attached vanes appear to be an ineffective means of suppressing pier scour under mobile-bed conditions. While Daido and Yano (1995) document as much as 90% scour protection under clear-water conditions, this promise is not borne out under conditions similar to natural rivers in flood. The amount of scour protection afforded was found to be unacceptable in all cases studied here.

### 3.6.12 Combination Runs with Cable Tied Blocks and Riprap

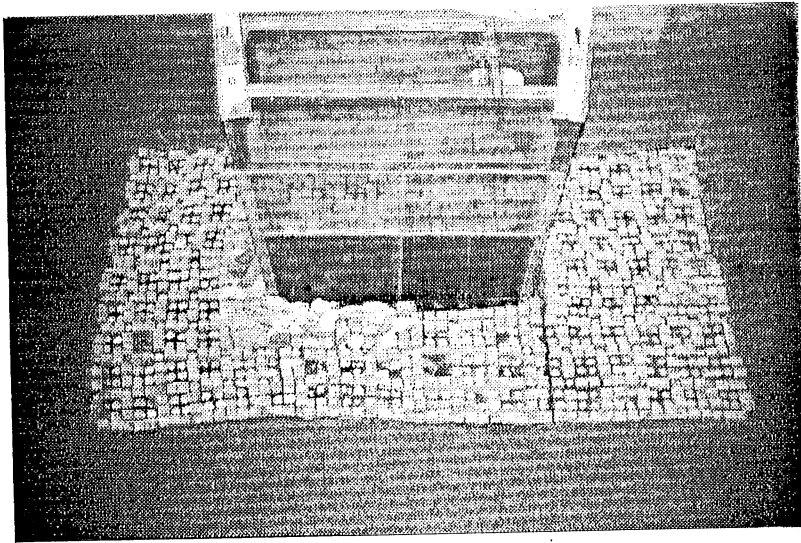
The goal of these runs was the testing of cable tied block mattresses in tandem with riprap. The tests were performed in the Main Channel as series MC-CMB. Only the rectangular pier was used, as this pier has proved more difficult to protect than the circular pier. The cable tied block configuration was identical to that of series MC-CB3, and included the same partial geotextile underneath. A supply of riprap was placed over the mattress in a U-configuration about the leading edge of the pier, as illustrated in Figures 3.49a and 3.49b.

The goal of the riprap placement was to stabilize the leading edge of the pier and help prevent the leaching of sand from the gap between the geotextile and the pier. Far more important to the success of the experiment, however, was the sealing of the geotextile to the pier using the same technique used in series MC-RPL: i.e. a cable inside a flexible tube that was tightened by means of a chain clamp.

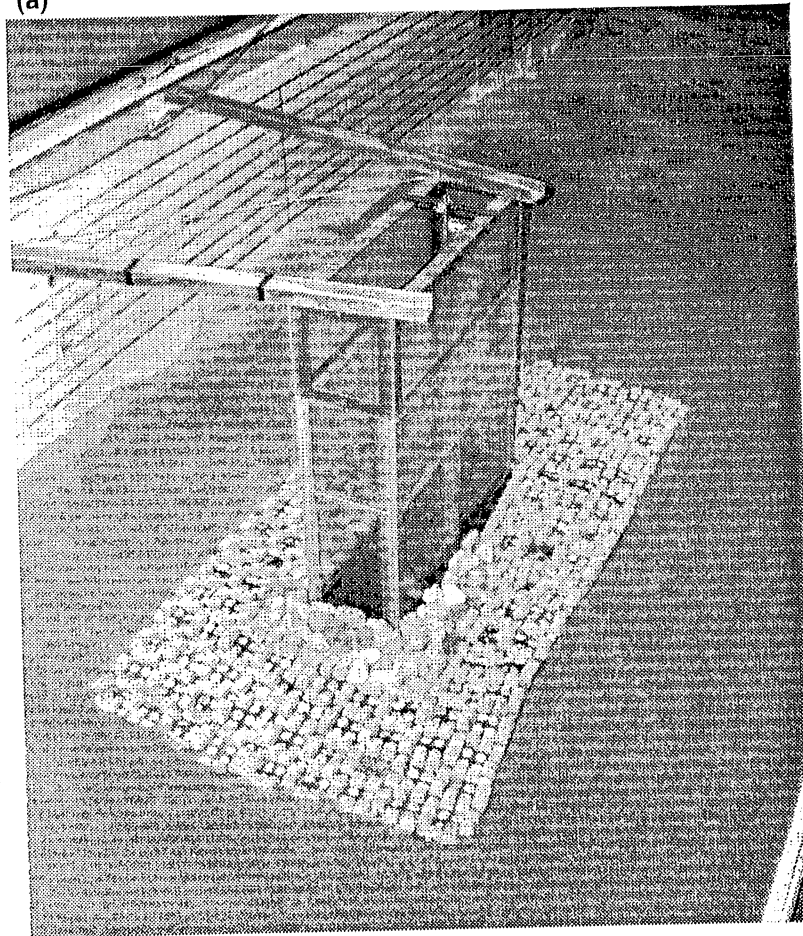
**Table 3.27.** Results of series MC-CMB for the rectangular pier

<i>Cable-tied blocks and riprap</i>				
<b>Flume:</b>	<i>Main channel</i>			
<b>Data set:</b>	<i>MC-CMB</i>			
<b>Pier type:</b>	<i>Rectangular</i>			
Run	$U/U_c$	$d_s/D$	$d_s/d_{s0}$	$r_s$
2	2.398	-0.008	-0.007	100%
3	4.108	0.338	0.249	75%
4	5.298	0.116	0.066	93%

The performance of this combination countermeasure is documented in Table 3.27. In Figure 3.50 the scour protection provided in this series (MC-CMB) is compared against that offered by riprap with a partial geotextile (MC-RPG) and the corresponding case of cable tied blocks with a geotextile but no riprap (MC-CB3). It can be seen that the performance of the present countermeasure is excellent, with substantial protection provided even for the severe conditions of Run 4.

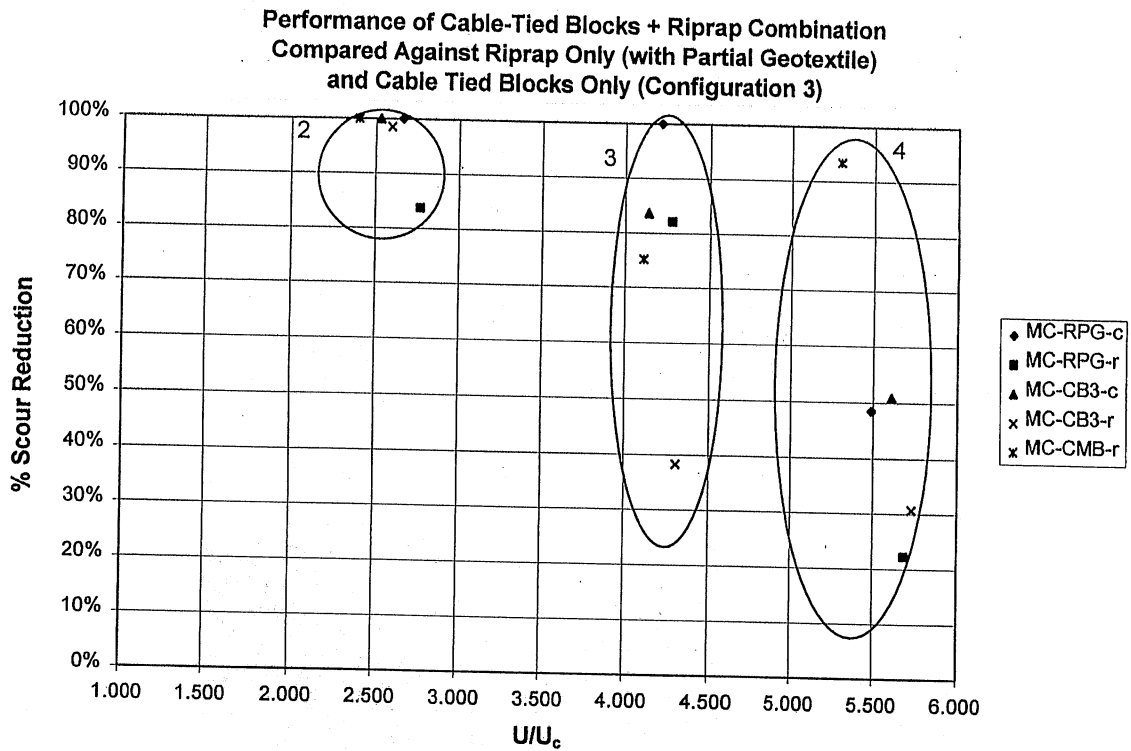


(a)



(b)

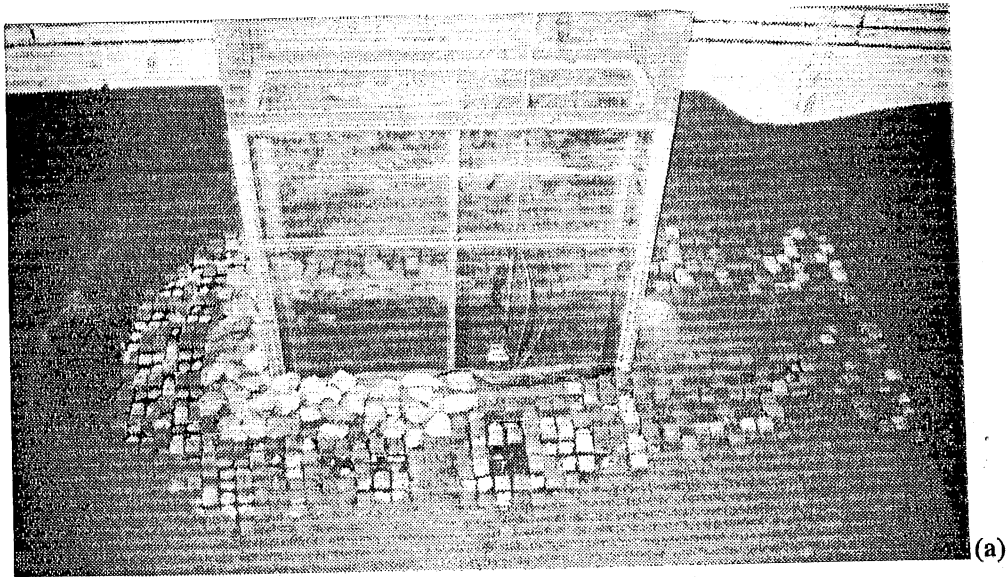
**Figure 3.49.** a) Top view of setup at the rectangular pier for series MC-CMB. b) Side view of setup at the rectangular pier for series MC-CMB



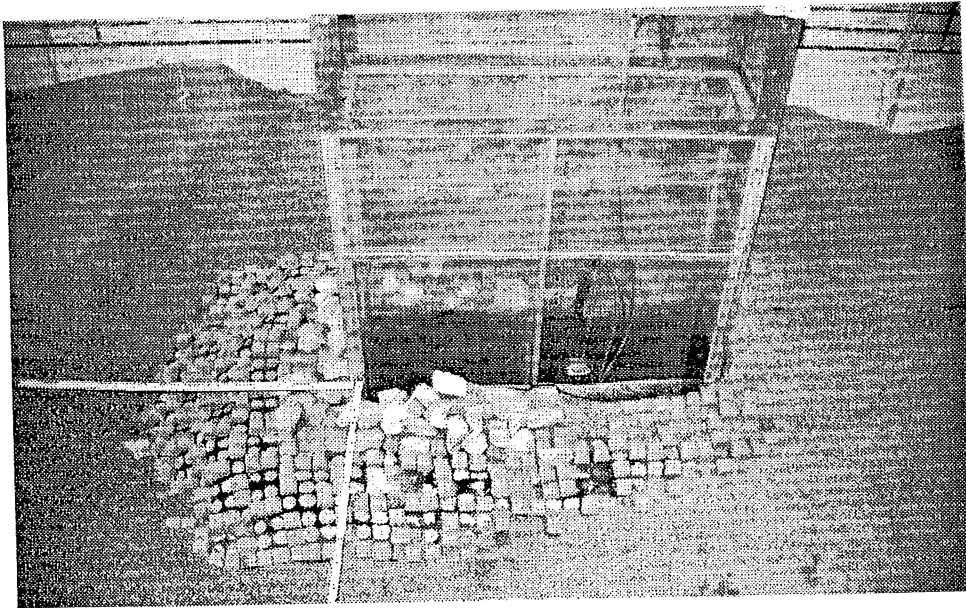
**Figure 3.50.** Comparison of the performance of cable-tied blocks + riprap (series MC-CMB) against riprap alone (series MC-RPG) and cable tied blocks alone (series MC-CB3).

The rectangular pier is shown at the end of Run 2 of series MC-CMB in Figure 3.51a and the end of Run 3 of the same series in Figure 3.51b. In the former figure the riprap is seen to be intact, but in the latter picture much of it is seen to have washed away. The key to the excellent performance is the sealing of the geotextile to the pier, not the riprap.

The importance of this sealing can be seen from Figure 3.50. In series MC-CB3, for which the cable tied block mattress was not sealed to the bridge pier, the performance at the end of Run 3 was unacceptable. With the addition of sealing to the same configuration, the performance at the end of Run 4 corresponds to a 93% reduction in maximum scour depth.



(a)



(b)

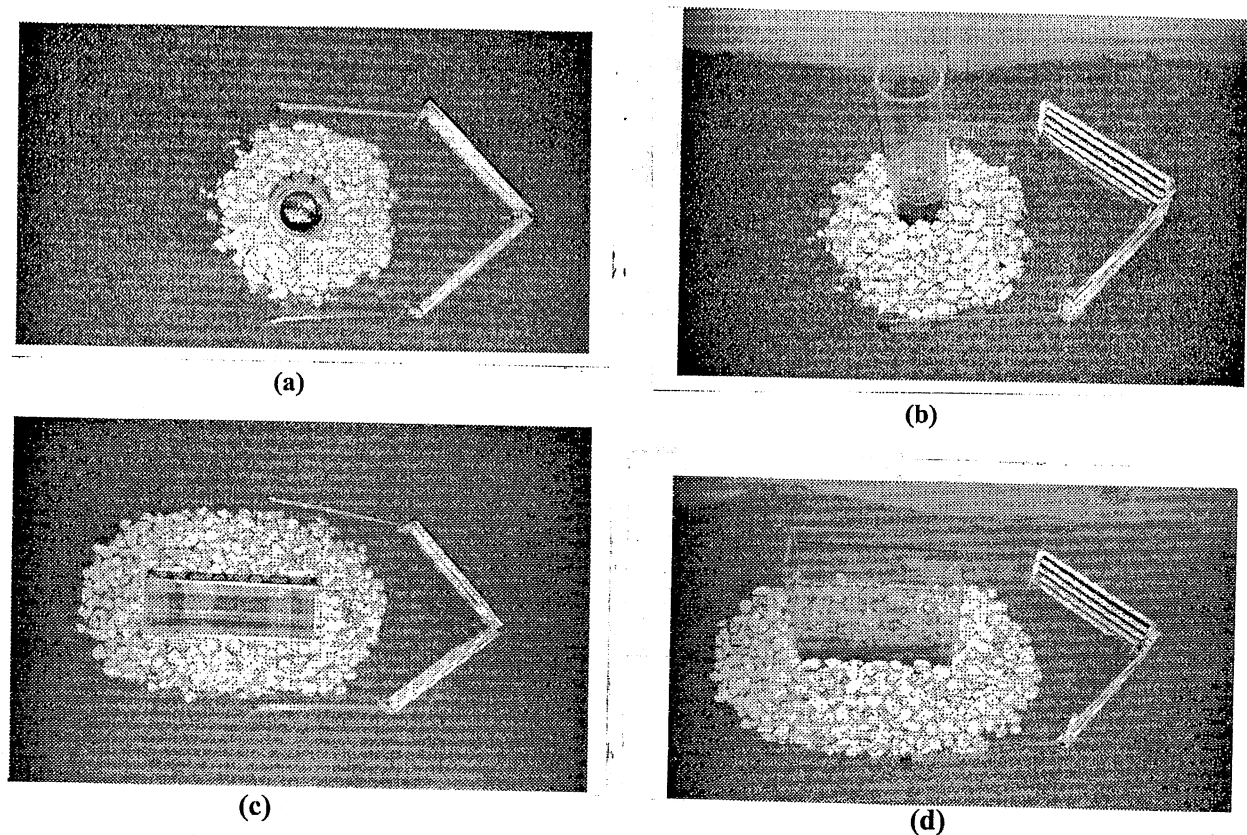
**Figure 3.51.** a) View of the rectangular pier at the end of Run 2 of series MC-CMB. b) View of the rectangular pier at the end of Run 3 of series MC-CMB.

In summary, this series demonstrates the excellent performance of cable tied blocks when provided with a geotextile that is sealed to the pier. Note that the blocks of the mattress used in this series, which were sized using Eqs. (3.10a) and (3.10b), did not fail by uplift at Run 3 but failed by uplift at Run 4. No such failure was observed at Run 4, indicating the importance of sealing the geotextile to the pier to prevent overall destabilization by leaching of sand from below. The additional riprap at the base of the pier evidently played little role in regard to scour protection, and can be omitted as long as sealing is implemented.



### 3.6.13 Combination Runs with Permeable Sheet Piles and Riprap

These runs were conducted in the Tilting Flume using both the circular and rectangular pier; they constitute series TF-CMB. In order to perform them the riprap with a partial geotextile of series TF-RNG was combined with the permeable sheet piles in the configuration of series TF-SP1. The goal was to add to the stability of the riprap by means of the less stringent flow environment created by the sheet piles. The permeable sheet piles were augmented by short fences extending downstream from the downstream end of the panels.



**Figure 3.52.** a) Top view of the configuration at the circular pier for series TF-CMB. b) Side view of the configuration at the circular pier for series TF-CMB. c) Top view of the configuration at the rectangular pier for series TF-CMB. d) Side view of the configuration at the rectangular pier for series TF-CMB.

The performance is documented in Tables 3.28a and 3.28b. As can be seen therein, the performance is not only acceptable but excellent for both bridge piers. The performance is very acceptable even under the conditions of Run 4 where the riprap might be expected to fail.

That the performance of the combination is better than each countermeasure used singly is documented in Figure 3.53. The combination is far better than the unacceptable performance of the permeable sheet piles of series TF-SP1. In light of the excellent performance under the conditions of Run 4, the combination is superior to the riprap plus partial geotextile of series TF-RNG. While the sheet piles appear to be ineffective in reducing scour at an otherwise unprotected pier under mobile-bed conditions, they appear to be effective as a means of augmenting riprap stability. There is a likely reason for this. The sheet piles probably do not reduce the flow velocity near the pier sufficiently to modify the sediment



transport field associated with the ambient bed sediment. The reduction is sufficient, however, to stabilize riprap that would otherwise move. The covering of the riprap on the upstream face of the pier by sand due to the sheet pile also helps prevent reworking by dune.

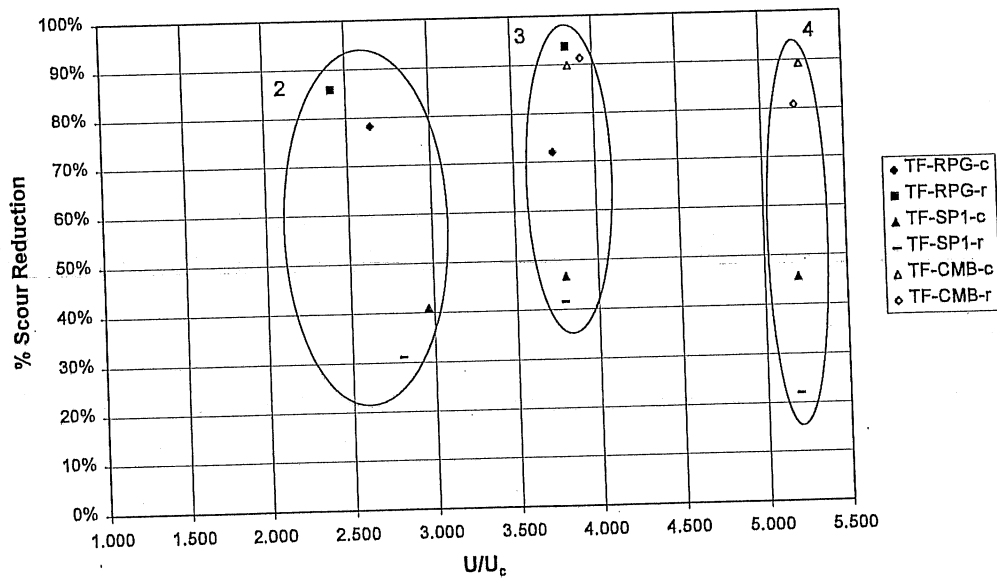
**Table 3.28a.** Results of series TF-CMB for the circular pier

Riprap and sheet piles				
Flume:	Tilting flume			
Data set:	TF-CMB			
Pier type:	Circular			
Run	$U/U_c$	$d_s/D$	$d_s/d_{s0}$	$r_s$
3b	3.852	0.112	0.102	90%
4	5.242	0.149	0.107	89%

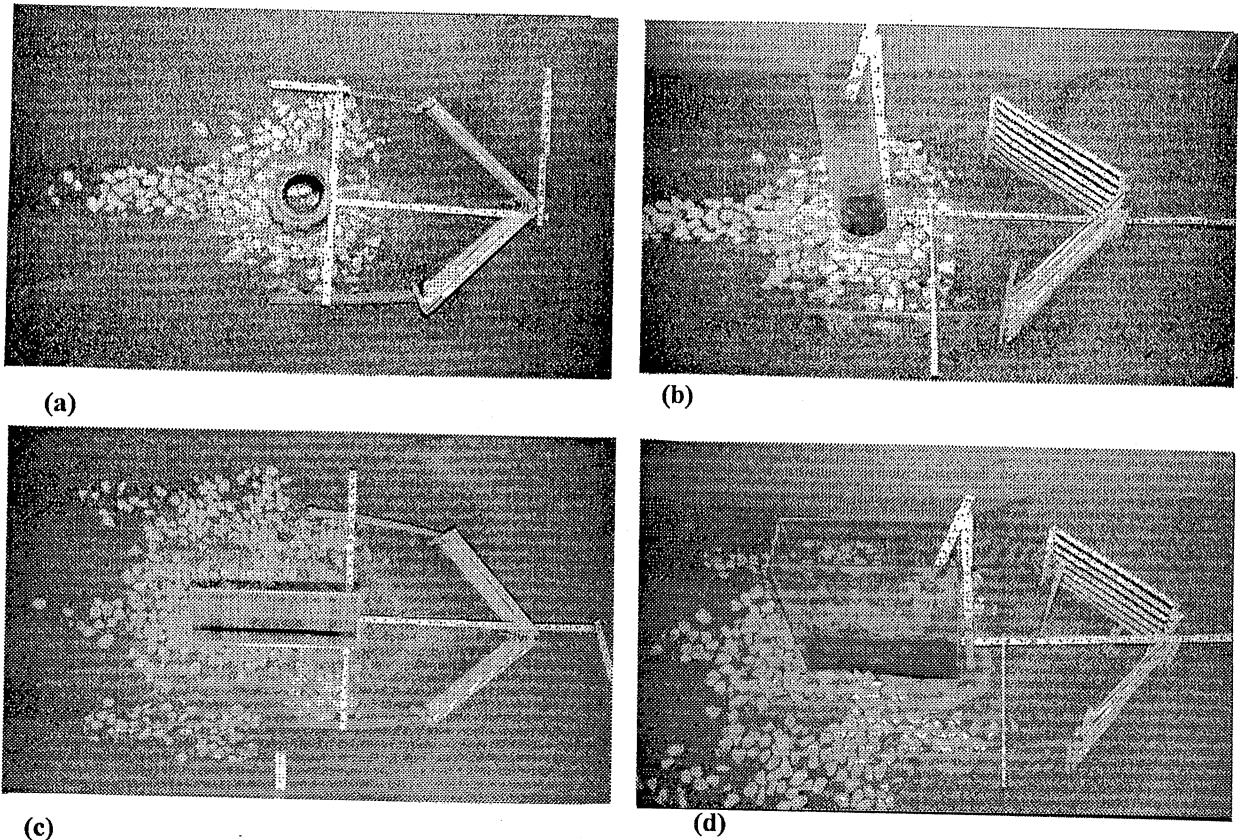
**Table 3.28b.** Results of series TF-CMB for the rectangular pier

Riprap and sheet piles				
Flume:	Tilting flume			
Data set:	TF-CMB			
Pier type:	Rectangular			
Run	$U/U_c$	$d_s/D$	$d_s/d_{s0}$	$r_s$
3b	3.932	0.151	0.087	91%
4	5.208	0.384	0.192	81%

**Performance of Sheet Piles + Riprap Combination Compared to Sheet Piles Only (Configuration 3) and Riprap Only (with Geotextile)**



**Figure 3.53.** Performance of the combination countermeasure (series TF-CMB) as compared with riprap alone (series (TF-RPG) and permeable sheet piles alone (series (TF-SP1).



**Figure 3.54.** a) Top view of the circular pier at the end of Run 4 of series TF-CMB. b) Side view of the circular pier at the end of Run 4 of series TF-CMB. c) Top view of the rectangular pier at the end of Run 4 of series TF-CMB. d) Side view of the rectangular pier at the end of Run 4 of series TF-CMB.

The performance of this countermeasure at the end of Run 4 is illustrated in Figure 3.54. It can be seen therein that much of the riprap upstream of the piers is covered with sand. The riprap is completely intact under conditions that would have mobilized it without the permeable sheet piles.

In summary, the combination of riprap with a partial geotextile and permeable sheet piles provides an effective mechanism for extending the performance of riprap to conditions for which it was not designed. The technology for the construction of permeable dikes is mature. As a result, permeable sheet piles should be relatively easy to retrofit to piers. They can be used to increase the effective size of the riprap. The sheet piles may, however, be subject to debris problems that would limit their use.

## 4. EXPERIMENTAL INVESTIGATIONS AT THE UNIVERSITY OF AUCKLAND

### 4.1 EXPERIMENTAL FACILITIES AND SETUP

Four flumes were used for the experimental studies at the University of Auckland. The widest of these is a sediment-transporting flume with a width of 2.4 m, a depth of 0.35 m and a length of 15.1 m. This flume has a sediment recess with a depth of 0.45 m that proved useful for experiments on clear water scour. The next widest flume, with a width of 1.52 m, was also the longest, with a length of 45 m and a depth of 1.22 m. This sediment-recirculating flume has glass walls, allowing for good flow visualization. The next widest flume had a width of 0.46 m, a length of 25 m and a depth of 0.40 m; this flume does not recirculate sediment. The narrowest flume used is a sediment-recirculating flume with a width of 0.44 m, a depth of 0.38 m and a length of 11.8 m. This flume has a sediment recess with a depth of 0.25 m. All four flumes have been used extensively for scour studies in the past, and were fully equipped for the present studies.

The sediment used for most of the studies at the University of Auckland was a uniform, coarse sand with a value of median size  $d_{50}$  near 0.95 mm and a value of geometric standard deviation  $\sigma_g$  of 1.1. In some of the experiments on the effect of degradation on riprap stability a poorly sorted sand with  $d_{50} = 1.0$  mm and  $\sigma_g = 3.0$  was employed. The model riprap employed was of three grades, with values of  $D_{r50}$  of 7.8, 16 and 22 mm. In several of the figures these grades are referred to as S1, S2 and S3 respectively. In large scale tests of geotextile performance values of  $D_{r50}$  of 50 and 66 mm were used. Most of the studies were performed with circular piers, but some were performed with rectangular piers. Pier width  $D$  took values of 70 mm, 150 mm and 200 mm depending upon the experiments in question.

The experimental setup in the University of Auckland studies varied considerably from case to case. As a result, more details pertaining to the setup for each set of experiments outlined below are discussed in the relevant section. Of note is the use of a jack in the recess of one of the flumes to study the effects of channel degradation.

In the calculations reported in this chapter, the critical velocity for the entrainment of riprap  $U_{rc}$  is computed from the formula

$$\frac{U_{rc}}{u_{*rc}} = 2.5 \ln\left(11 \frac{y_o}{2D_{r50}}\right) \quad (4.1)$$

as opposed to Eqs. (3.7a) and (3.7b) of Chapter 3. The above equation pertains to the threshold of motion for riprap resting in a layer on the ambient bed, not in the vicinity of a bridge pier. In the above relation  $u_{*rc}$  denotes the critical shear velocity necessary to mobilize the riprap. Eq. (4.1) can be transformed into following form;

$$N_{sc} = 2.5 (\tau_{rc}^*)^{1/2} \ln\left(11 \frac{y_o}{2D_{r50}}\right) \quad (4.2)$$

which facilitates comparison to Eqs. (3.7a) and (3.7b). In the above relation  $\tau_{rc}^*$  denotes the critical Shields stress for mobilizing the riprap. According to the relation of Melville (1997) for critical conditions for the mobilization of sediment, all three grades of riprap in the Auckland study have a value of  $\tau_{rc}^*$  close to 0.057. Considering a value of  $y_o/D_{r50}$  of 15, for example, the values of the dimensionless number  $N_{sc}$  characterizing the critical velocity for the mobilization of riprap is 1.96 from Eq. (3.7a), 1.28 from Eq. (3.7b) for the case of a round nosed pier and 2.63 from Eq. (4.2). The relatively high value of  $N_{sc}$  predicted by Eq. (4.2) implies that a riprap stone sitting on a flat ambient bed is harder to mobilize than one placed in

the accelerated flow region near a bridge pier, in consonance with expectations. The difference in method of computation must, however, be borne in mind when considering the interpretation of the data.

A summary of the basic data collected in the experiments is provided in table form in Appendix A. More details of the research can be found in Hadfield (1997) and Lauchlan (1998).

#### **4.2 SUMMARY OF RUNS PERFORMED AT THE UNIVERSITY OF AUCKLAND**

**Runs with riprap and no geotextile** The extensive runs performed at the University of Auckland vividly illustrate the tendency for riprap to undergo destabilization and sinking in response to the passage of bedforms. Deeper placement levels reduce the ability of bedforms to destabilize the riprap, resulting in improved performance. With a riprap thickness  $t = 2D_{r50}$  and a cover  $c$  of  $4D$ , i.e. the standard values used by all three experimental groups, the loss of protection was almost total when the top of the riprap was flush with the bed ( $Y/D = 0$ ) and the flow velocity was below but close to the value  $U_{rc}$  for the mobilization of the riprap. With the same flow velocity (i. e. just below that required for riprap mobilization) but with the top of the riprap buried such that  $Y/D = 0.857$ , riprap performance remained in the acceptable range. Increasing the riprap thickness to  $3D_{r50}$  resulted in noticeably better performance.

It was verified that both the unprotected scour depth and the tendency for the riprap to settle were reduced when the value of the ratio of flow depth to pier width  $y_p/D$  dropped below 2. Experiments in this range may thus underestimate scour depth and overestimate the protection offered by riprap when applied to the field.

**Runs with riprap and geotextile** When the riprap was underlain by a geotextile with the same areal cover as the riprap relatively poor performance resulted. The riprap tended to be plucked off the geotextile, resulting in exposure of the geotextile and eventual failure. Part of the poor performance appears to be associated with the fact that the geotextile was of insufficient permeability, resulting in the buildup of uplift forces. Considerable leaching of sediment at the interface between the pier and the geotextile was observed. These experiments provided the motivation for tests at St. Anthony Falls Laboratory. These tests demonstrate that the tendency for the riprap to settle under the influence of bedforms can be essentially arrested when a) the geotextile has  $2/3$  the areal cover of the riprap, b) the geotextile is sufficiently permeable and c) the geotextile is sealed to the pier.

**Runs on the ability of riprap to withstand degradation** The experiments demonstrate that riprap can provide a degree of protection of bridge piers against even a relatively high rate of degradation, as long as it is not sustained over time. Riprap can thus withstand a certain degree of short term degradation associated with e.g. scour at a contraction during floods or scour associated with a short-term deficiency in sediment supply. Riprap will always fail if the degradation is sustained for a sufficiently long amount of time.

**Runs with sacrificial piles** When the flow is aligned with the pier, a wedge-shaped arrangement of 5 sacrificial piles placed upstream of a bridge can provide adequate protection against scour under clear water conditions. With sufficient skewing, however, the presence of the piles can increase scour at the pier as compared with no protection at all. Under mobile bed conditions any advantage of sacrificial piles in preventing pier scour effectively vanishes.

**Runs with submerged vanes (Iowa Vanes)** Submerged vanes, which have been quite successful in other contexts, show some potential to reduce scour at bridge piers. The best configuration tested, however, produced a scour reduction of only 50%. This notwithstanding, Iowa vanes appear to be the most effective of the flow-altering scour measures tested in this study.

## 4.3 EXPERIMENTS ON RIPRAP PERFORMANCE

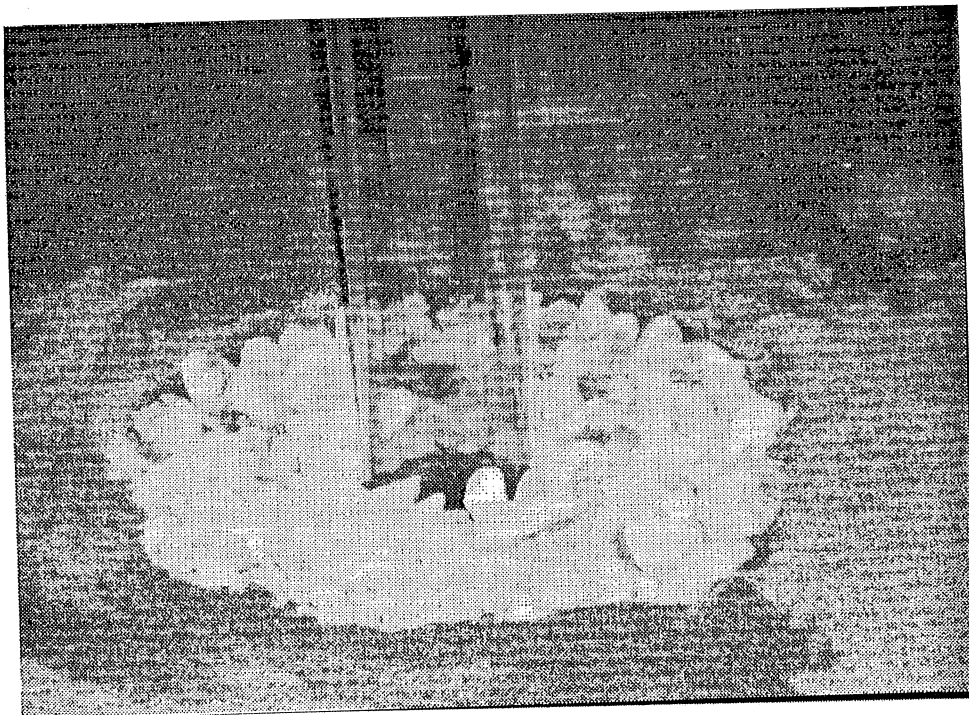
### 4.3.1 Introduction

Riprap materials are widely used for the protection of bridge piers from local scour. Experiments by Chiew (1995) detailed the responses of these materials under clear water conditions. This was later expanded by Lim and Chiew (1996) and Chapter 3 of this report to cover the live bed regime. The following report details the results of live bed and degradation experiments on riprap protection at bridge piers. The purpose of the study was to identify design parameters, their importance on riprap layer stability, and the usefulness of riprap as protection over a wide range of flow conditions. The basic data pertaining to the experiments can be found in Appendix A. A summary of the salient results is provided here. The experimental setup is illustrated in Figure 4.1, which shows riprap stones placed at a cylindrical pier.

### **Symbols**

In addition to the previously introduced symbols, the following symbols are used in this section.

Y	depth of placement of riprap layer below original bed level
$\sigma_B$	geometric standard deviation of sediment or riprap size
DG	degradation level



**Figure 4.1.** Placement of riprap at a cylindrical pier.

### 4.3.2 General Failure Mechanisms and Placement Effects

#### *Introduction*

In the series of experiments detailed below, performed in the flume with a width of 0.44 m, the results of the aforementioned authors are expanded upon under live bed conditions. In addition to shear failure, leaching failure and edge failure, a fourth failure mechanism due to the added presence of bedforms is confirmed. Many authors have also suggested that because of the presence of an undulating bed level riprap layers should be placed at some depth within the sediment bed. Results in the following section detail experiments on the effects of bedforms on riprap, and delineates the protection deriving from placement of the riprap at varying depths below the bed surface.

#### *Experimental Setup*

diameter $D$	70 mm
coverage $c$	$4D$
thickness $t$	$2D_{r50}$
$U/U_c$	1.84 to 3.10
$D_{r50}$	7.8, 16, 22 mm
$d_{50}$	0.95 mm

#### *Results and Discussion*

##### Failure Mechanisms

The three riprap failure modes observed by Chiew (1995) under clear water conditions, namely shear failure, leaching failure and edge failure, were also perceived to be present under live bed conditions. An additional mode of failure was identified to be bedform destabilization due to the passage of bedforms through the layer. This is in agreement with the findings of Lim and Chiew (1996). The fluctuating bed level brought about by the passage of bed features past the pier causes the riprap stones to lose support and therefore stability. If the trough of the bedform is deeper than the riprap layer, riprap stones are undercut and slide into the lower trough region. As the bedform approaches the pier, high levels of turbulence and correspondingly high shear stresses are induced for short periods. Riprap stones can be plucked from the layer and transported to the lee of the pier and beyond.

Once the stones are removed, the layer in that area is thinner which induces increased leaching. Other riprap stones are exposed and can also be removed. The smaller 7.8 mm stones were most susceptible to this mechanism; they failed at relatively low values of  $U/U_c$ . Failure was rapid where the turbulence associated with the bedforms was sufficiently high to entrain the riprap material in clusters, resulting in swift disintegration of the layer.

Placement depth was found to affect the dominant failure mode of the riprap layer. For riprap layers placed flush with the bed surface the passage of bedforms causes undercutting, resulting in edge failure, as shown in Figure 4.2. Stones move forward into the approaching bedform trough and also spread out laterally. This causes a thinning of the layer, allowing leaching to occur. The riprap settles into the bed material and spreads out forming an armor layer around the pier. At this stage the layer is stable and no further lateral movement of individual riprap stones is observed with continued bedform migration through the layer. If a deeper trough passes the pier, however, significant additional settlement can occur. At the nose of the pier the strong horseshoe vortex structure is capable of plucking riprap stones from the layer, allowing leaching to occur and the riprap layer near the pier to subside into the scour region. At higher flows, a different mechanism is observed. The edge stones are unable to embed in the surrounding bed and are often transported into the scour region in front of the pier. The scour hole is filled, thickening the riprap layer near the pier and therefore reducing the effects of leaching.

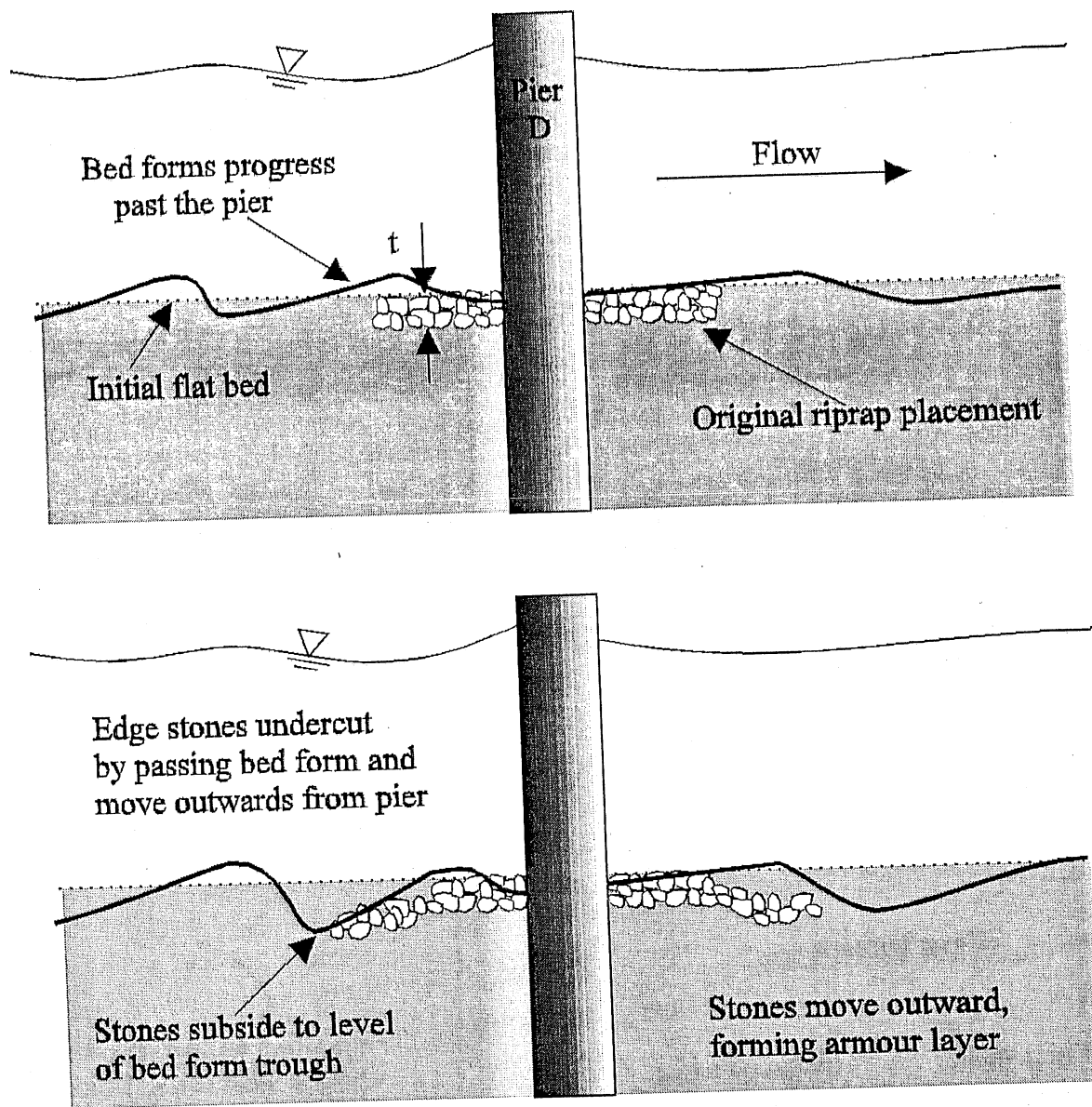


Figure 4.2. Illustration of the effect of bedforms on riprap layers.

With deeper placement levels, the ability of the bedforms to undercut the riprap layer is reduced. As a consequence, leaching against the pier face becomes the dominant mode of failure. In some cases the original riprap formation is scarcely disturbed except for a slight depression forming against the upstream pier face. Placement below the original bed level also reduces the depth of subsidence of the riprap into the bed material. The effect of placement level on the ultimate disposition of the riprap is illustrated in Figure 4.3.

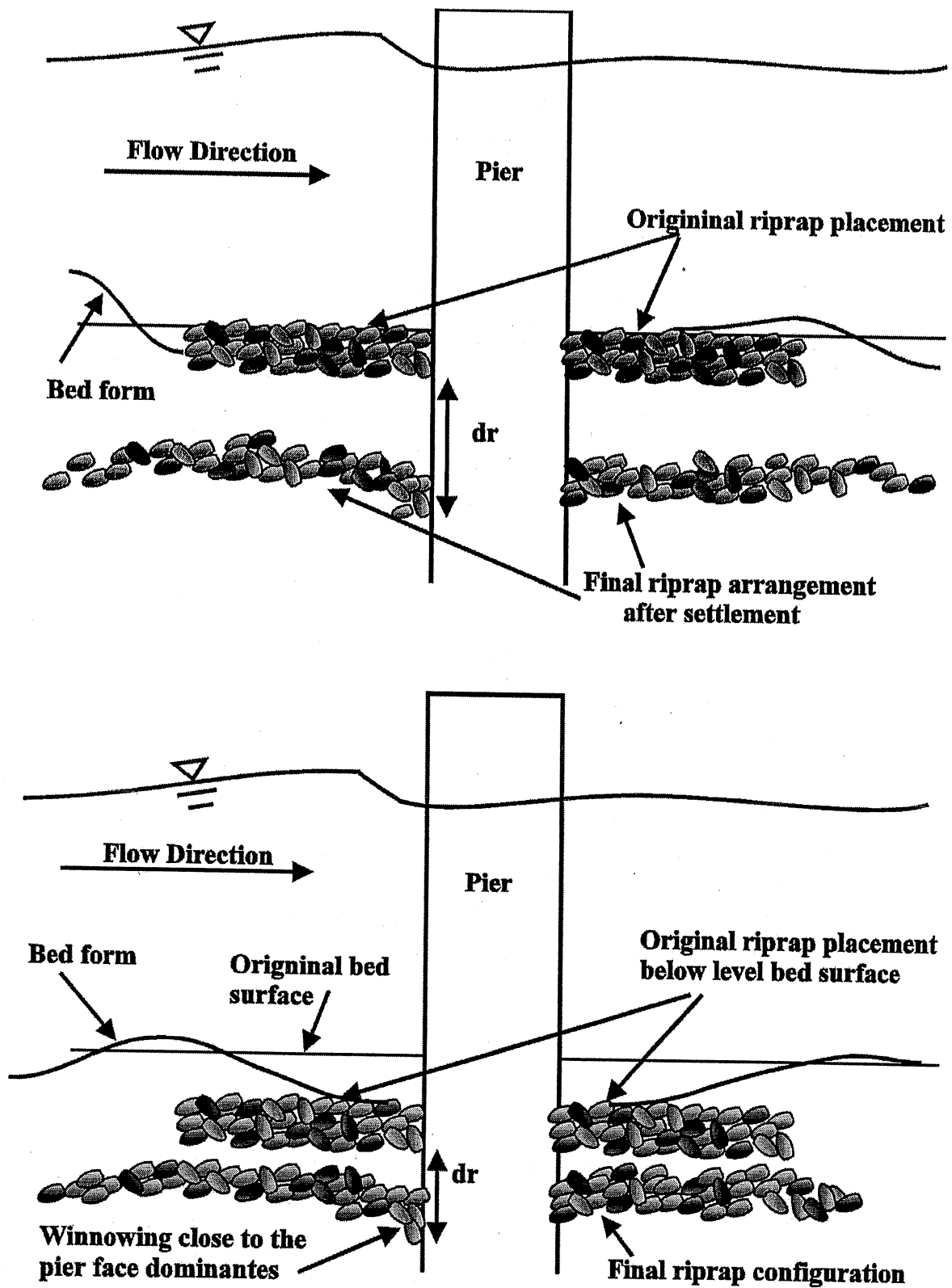
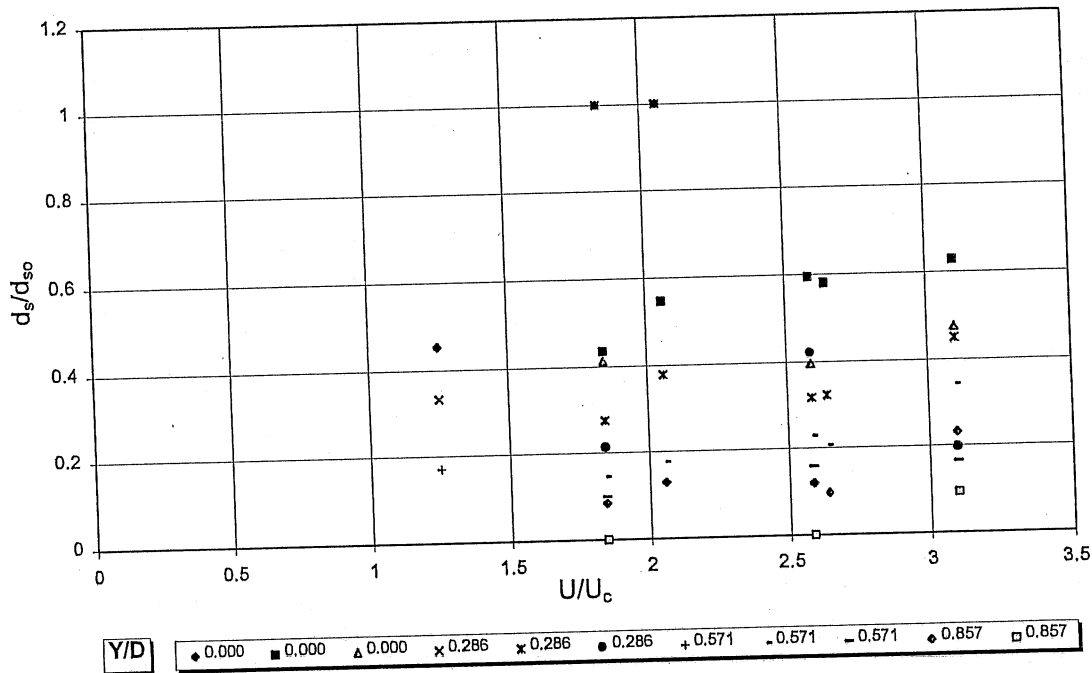


Figure 4.3. Effect of riprap placement on ultimate disposition.



Placement Level Effects

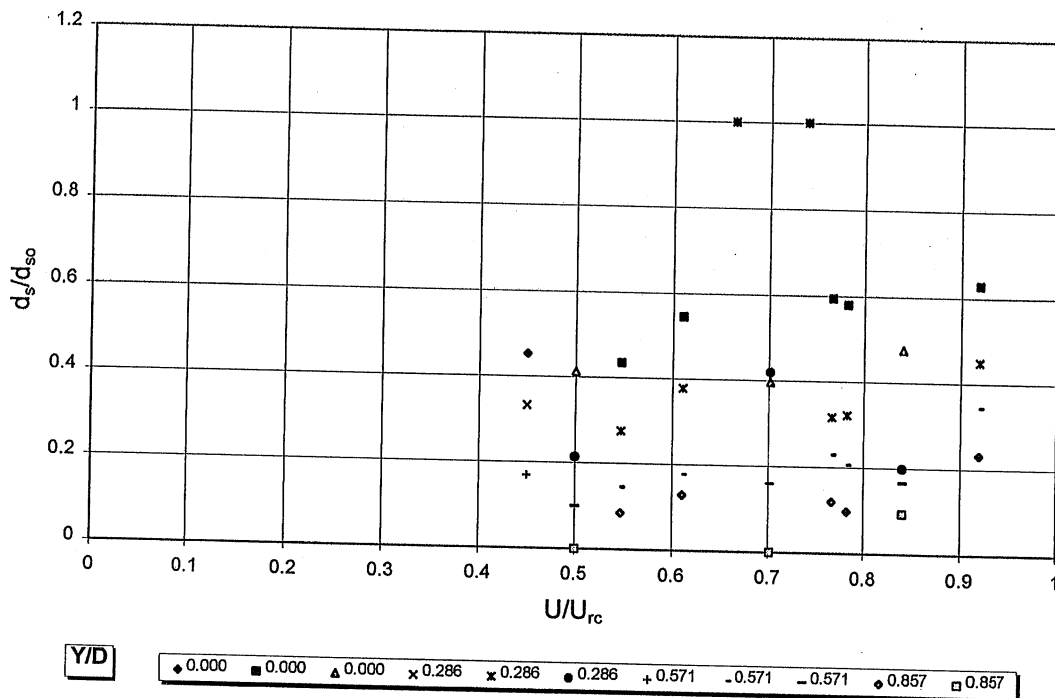
The depth of initial placement of riprap may affect its long term stability. Here the standard initial placement is taken to be such that the top of the riprap layer is flush with the bed, so that where  $Y$  denotes the distance of the top of the riprap below the bed,  $Y = 0$ . Four levels, from the case with  $Y/D = 0$  to  $Y/D = 0.857$ , were chosen for riprap placement over a range of flow rates. If the stone surface was below the original bed level the area above was filled in with bed material to produce a flat surface. Before an experiment was commenced a reading was taken of the position in the bed of the base riprap stones. This was monitored throughout the runs and a final reading taken at the experiment end. The resulting scour has been normalized against the maximum scour observed in an unprotected situation for the same flow velocities. Figures 4.4 and 4.5 are plots of  $d_s/d_{s0}$  versus  $U/U_c$  and  $U/U_{rc}$ . The range of conditions tested is between 1.8 and 3.1 times the critical velocity of the bed material and up to 0.9 times the critical velocity of the riprap stones. The data demonstrates that riprap settlement increases asymptotically with flow velocity towards the unprotected scour depth and that the deeper the initial placement of the layer, the lesser the scour experienced by the riprap at a particular flow velocity. As the flow rate increases the measured scour reduction is reduced, but the advantage of deeper placement remains. A series of curves can be fitted to the data for each placement level and stone size. Each curve tends towards failure. As the stone size increases, however, the flow velocity required for failure also increases.



**Figure 4.4.** Scour reduction achieved as a function of  $U/U_c$  for various initial placement levels. The first, fourth and seventh values of  $Y/D$  correspond to the 7.8 mm riprap; the second, fifth, eighth and tenth values correspond to the 16 mm riprap; the third, sixth, ninth and eleventh points correspond to the 22 mm riprap.

The data are plotted in Figure 4.6 to show the scour depth in the riprap measured from the undisturbed bed surface ( $d_s + Y$ ), as a function of  $U/U_c$ .  $Y/D$  values of 0.00 can be compared to data collected by Lim and Chiew (1996), who placed the riprap at the bed surface for all their experiments, and experienced a similar asymptotic trend towards a  $d_s/d_{s0}$  of 1.0 in the upper dune regime. They concluded

that surface-placed riprap layers may be incapable of affording protection against scour at bridge piers where deep bedforms occur, and this is supported by the new results, both at the University of Auckland and St. Anthony Falls Laboratory. However when placement  $Y/D > 0$  the range of flows for which protection is provided is extended.



**Figure 4.5.** Scour reduction achieved as a function of  $U/U_{rc}$  for various initial placement levels. The first, fourth and seventh values of  $Y/D$  correspond to the 7.8 mm riprap; the second, fifth, eighth and tenth values correspond to the 16 mm riprap; the third, sixth, ninth and eleventh points correspond to the 22 mm riprap.

In Figure 4.7, the data are plotted in three groups for each of the three riprap stone sizes. All values of  $Y/D$  studied are included in the data for each riprap size. It is apparent that larger riprap affords better protection at a given flow velocity. The inability of the 7.8 mm stones to sustain flows greater than around  $0.65 U/U_c$  indicates that perhaps a minimum size relationship exists between the riprap stone size and the bed material size. The larger stone sizes, 16 mm and 22 mm, provided greater scour reduction and achieved this over a wider range of flow conditions

The riprap layers were not placed at the maximum trough level as suggested by various authors on live bed conditions. This was due to the fact that the deepest trough levels were similar to the maximum live bed scour depths and so no protection could be experienced. It was also difficult to determine what the maximum trough level was for each flow, so it was decided to investigate a series of placement depths at regular intervals instead.

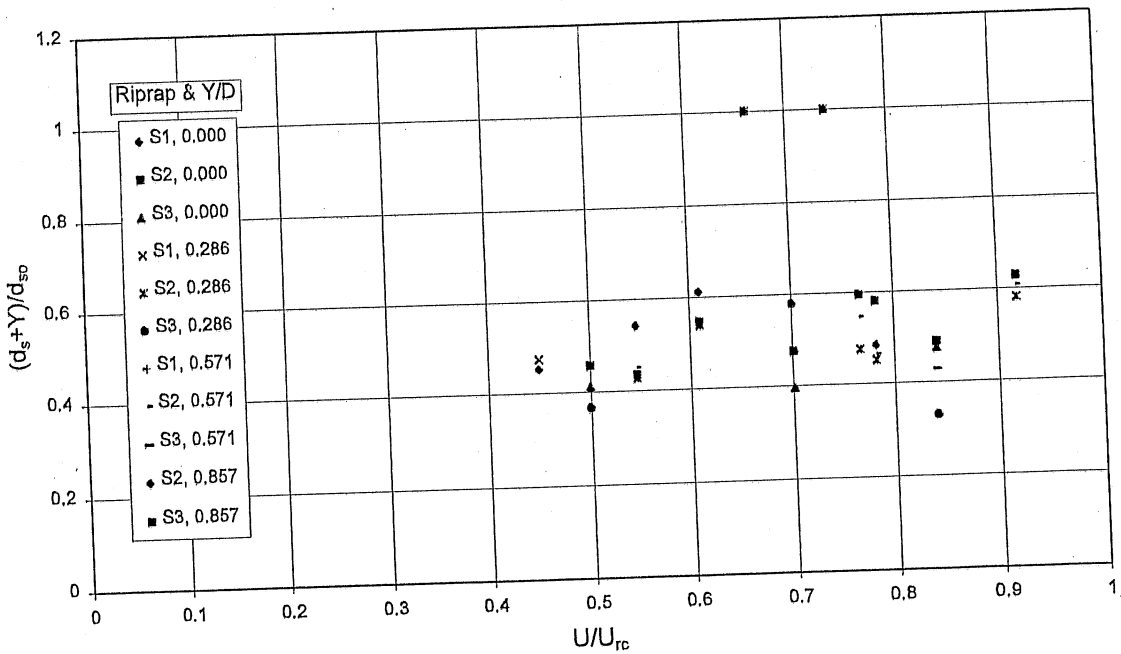


Figure 4.6. Depth of scour measured from the original bed surface versus  $U/U_{rc}$ . In the legend, S1 denotes the 7.8 mm riprap, S2 denotes the 16 mm riprap and S3 denotes the 22 mm riprap.

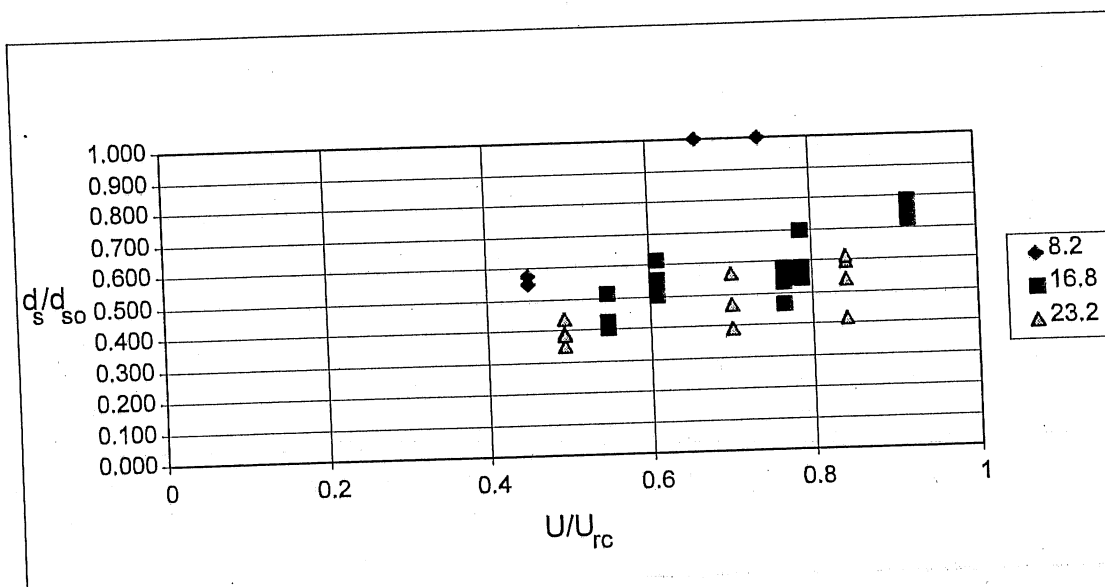


Figure 4.7. Effect of ratio of riprap size to ambient sediment size on scour. The numbers in the legend indicate values of  $D_{150}/d_{50}$ .

## ***Conclusion***

The dominant trend detailed by the experimental results shows that the deeper the riprap layer is placed initially in the bed around the bridge pier the greater the protection afforded by the stones against local scouring. In the live bed situation dune destabilization exacerbates shear, leaching and edge failure experienced under clear water conditions (Chiew 1995). Deep placements allow the bedforms less chance to undercut the riprap layer and reduces the shear stresses experienced by the stones. The dominant failure mechanism then becomes leaching at the pier face.

### **4.3.3 Thickness Effects**

#### ***Introduction***

Previous experiments have been conducted with riprap layer thicknesses of  $2D_{r50}$ , which was adopted after study of the relevant literature. The purpose of this investigation was to challenge this initial assumption by utilizing layers  $1D_{r50}$  and  $3D_{r50}$  thick, allowing determination of the importance of this particular riprap parameter. These experiments were also performed in the flume with a width of 0.44 m.

#### ***Experimental Setup***

Pier diameter D (mm)	70
$U/U_c$	1.84 to 3.10
Y/D	0 and 0.286
C	4D

## ***Results and Discussion***

### **Failure Mechanisms**

Layer thickness affects the failure mechanisms of the riprap layer predominantly because of the increase in the number of stones available for protection. Increasing layer thickness automatically makes undercutting by bedforms and edge failure more difficult as the stones extend to deeper depths within the bed. Only the deepest bedforms impact upon the layer, especially at the lower flow rates.

Leaching is reduced in thicker layers as the number of voids is decreased. In many of the runs the front section would experience subsidence from bedform passage before any local scouring was visible at the pier face.

The layer failure appears to take on three stages depending on the flow velocity. Initially, at low flows, the passage of a deep bedform causes the front region to subside as a whole. This combines with edge failure to spread out the side and front stones, forming an armor layer. Usually this remains at least  $2D_{r50}$  thick. The rear regions continue in their original positions. Increasing the flow rate results in further subsidence of the rear section and the layer takes on pyramid shaped dimensions. Finally, at high flow velocities leaching effects become apparent at the pier face and the inner region around the pier subsides, changing the pyramid to a doughnut like shape.

### **Thickness**

Thicker riprap layers ( $3D_{r50}$ ) resulted in less scour at the pier face under the same flow conditions as previous  $t = 2D_{r50}$  runs. A comparison of results is plotted in Figures 4.9a for  $Y/D = 0$  and 4.9b for  $Y/D = 0.286$ . The same asymptotic trend towards  $d_s/d_{s0} = 1.0$  is shown. It appears that overall the scour reduction experienced in the  $3D_{r50}$  layers is similar for all flow conditions tested and the result of this is that the range of flow conditions suitable for each particular stones size is extended. Figures 4.8a and 4.8b illustrate schematically the failure of  $3 D_{r50}$  and  $1 D_{r50}$  thick riprap layers, respectively.

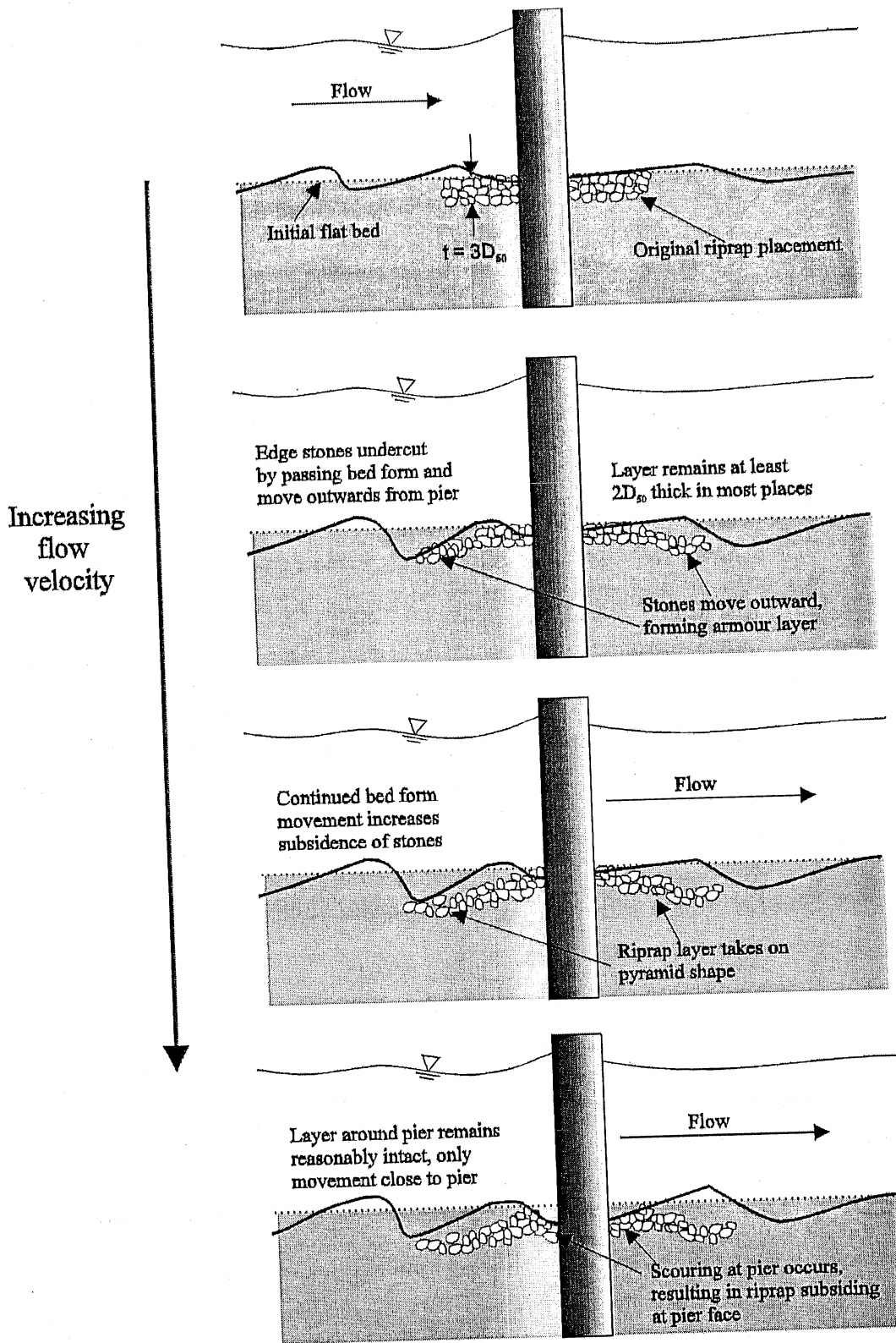


Figure 4.8a. Illustration of the failure of a riprap layer for  $t=3 D_{150}$ .

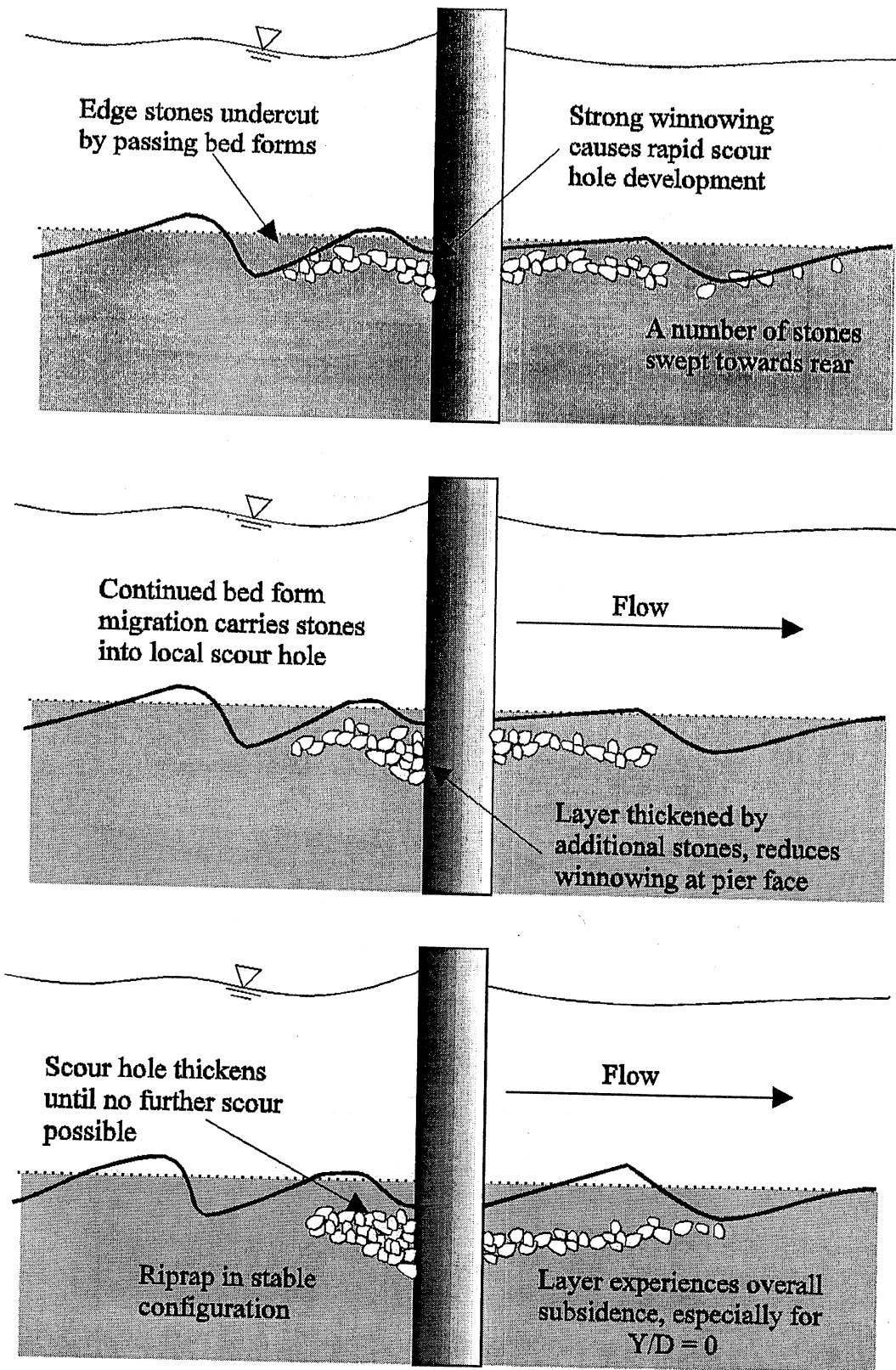
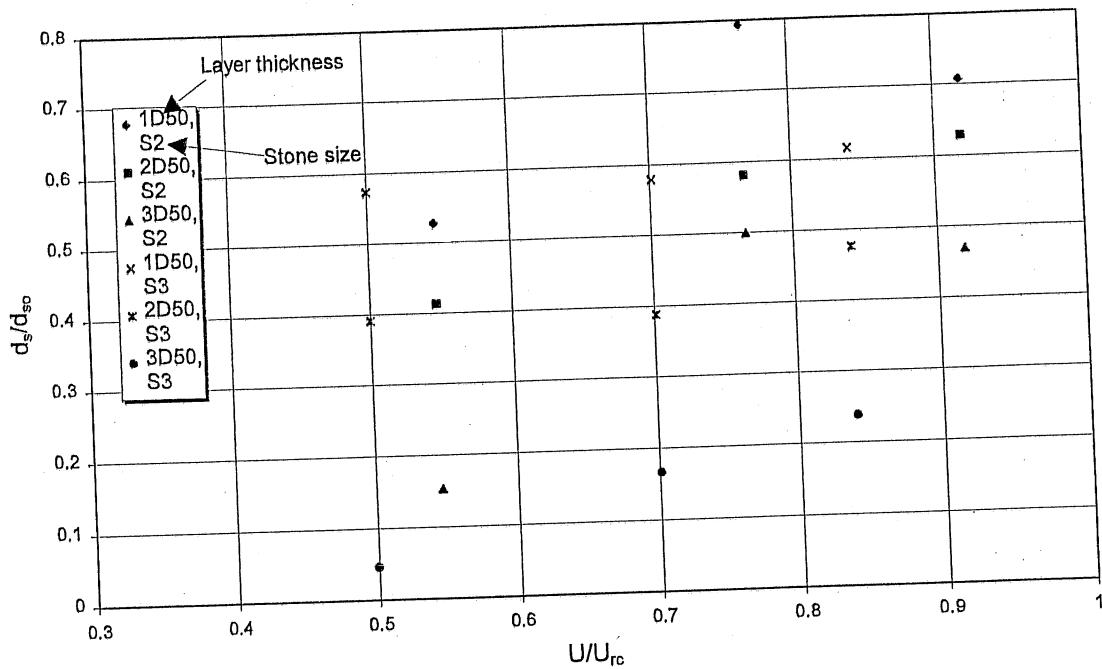
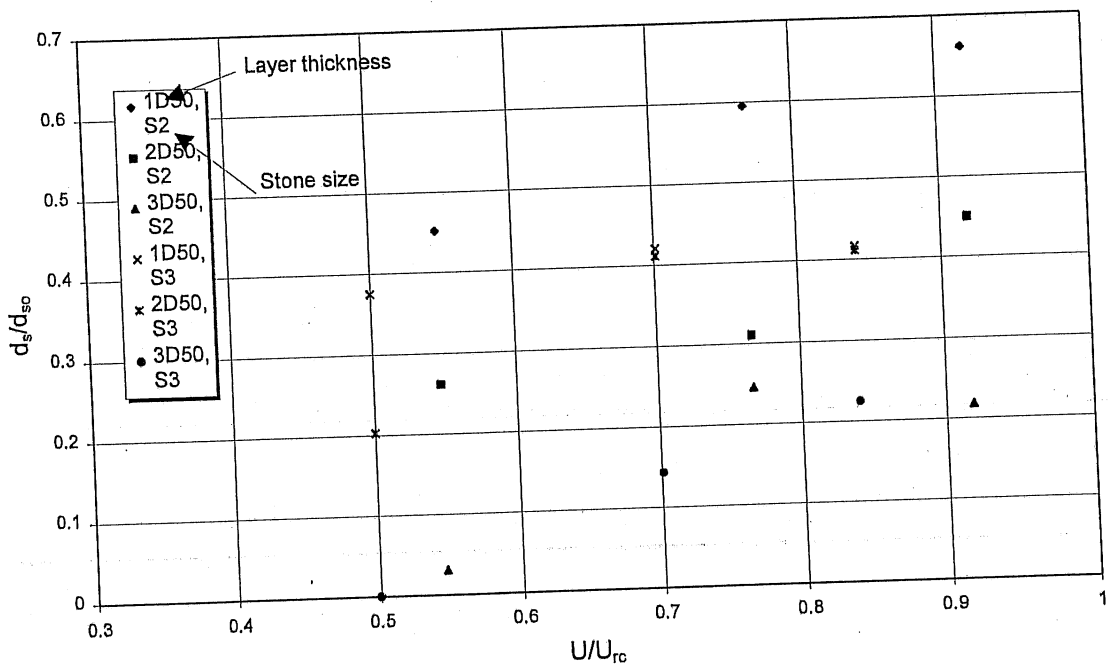


Figure 4.8b. Illustration of the failure of a riprap layer for  $t=1 D_{150}$ .



**Figure 4.9a.** Riprap protection for differing thicknesses with  $Y/D = 0$ . In the legend the notation 1D50 denotes the value  $t = 1 D_{r50}$  etc., S2 denotes 16 mm riprap and S3 denotes 22 mm riprap.



**Figure 4.9b.** Riprap protection for differing thicknesses with  $Y/D = 0.286$ . In the legend the notation 1D50 denotes the value  $t = 1 D_{r50}$  etc., S2 denotes 16 mm riprap and S3 denotes 22 mm riprap.

Reductions in scour depths when compared to the thinner  $2D_{r50}$  layers vary between 20 to 100 % with values decreasing as the flow rate increases. The 22 mm riprap stones always experienced a greater reduction in scour than the 16 mm stones, and deeper placement provided improvement in all but one run.

### ***Summary and Conclusion***

Increasing the thickness of riprap layers reduces the ability of passing bedforms to undercut the layer and cause edge failure. The thick layers still experience subsidence and local scouring but results can be improved considerably depending on flow rate. Larger stone sizes and deeper placement levels all combine to improve results. It appears that providing a layer between 2 and 3  $D_{r50}$  thick placed at some level in the sediment bed would be an effective design approach.

### **4.3.4 Flow Depth**

#### ***Introduction***

Previous pier scour studies have found that flow depth plays a part in local scour mechanisms and that below a certain depth threshold the scouring potential at the nose of piers is reduced. How this may then affect riprap layer performance around piers is not known. To investigate this a series of experiments was conducted in the 0.44 m wide flume for a flow depth below the threshold value ( $y_0/D = 2$ ) and the results compared to previous runs conducted at a deeper flow depth ( $y_0/D = 3$ ).

#### ***Experimental Setup***

Pier diameter D (mm)	70
$U/U_c$	1.84 to 3.10
$Y/D$	0.0
coverage c	4D
thickness t	$2D_{r50}$

As shallow flow depths  $y_0$  have been found to reduce scour depths, baseline scour depth data were remeasured for all flow velocities used.

#### ***Results and Discussion***

From the shallower flow depth experiments (see Figure 4.10) it can be seen that for the shallower flows scour experienced in the riprap layer was reduced from the previous deeper flow runs. This was most noticeable at lower values of  $U/U_c$  where the difference was a scour reduction by as much as 17 %. At higher values of  $U/U_c$  the effect was less apparent. These results can be attributed to the following:

##### **1. Bedform size characteristics related to flow depth**

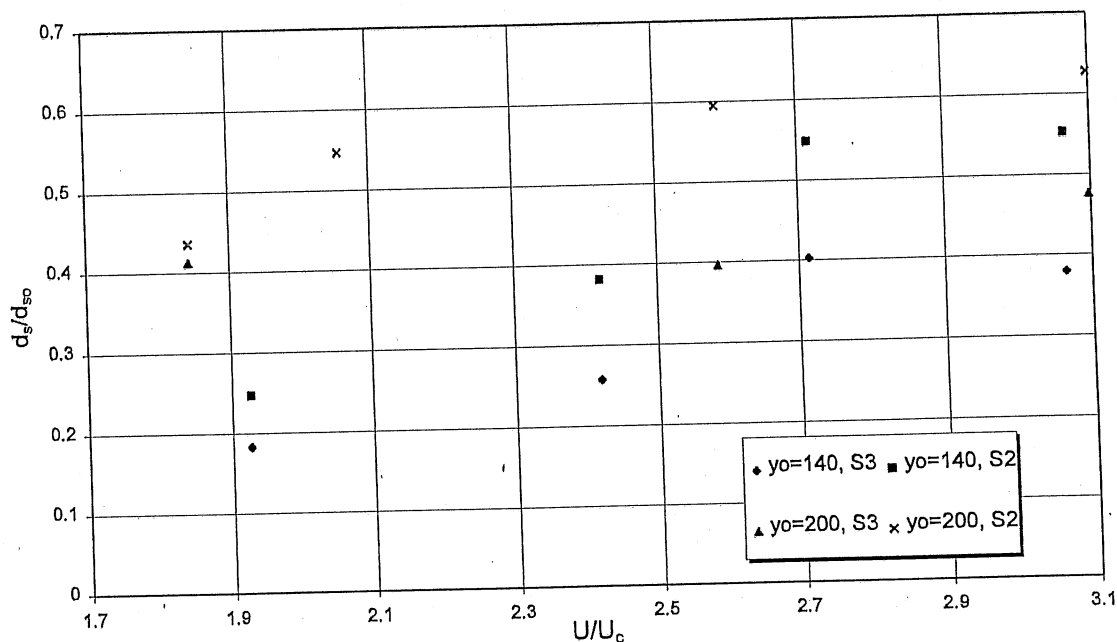
In the dune regime the size of the bedforms is dependent on the flow depth; a deeper flow produces larger dunes. Destabilization of the riprap layer is influenced by the ability of passing bedforms to undercut the layer, so any reduction in bedform height will reduce the effectiveness of this failure mechanism. In these shallow depth experiments the bedform troughs were shallower than their deeper flow counterparts and could not undercut and destabilize the riprap as easily.

##### **2. Flow depth influences on scour depths at piers below a $y_0/D$ ratio of 2.**

Details of flow depth influences on scour depths at bridge piers can be found in research conducted by Ettema (1980) and Chiew (1984). They showed that the depth of scour experienced at bridge piers is affected by flow depth. Once the  $y_0/D$  ratio reaches a value between 2 and 3 the scour depth becomes independent of water depth. However, below this value the scour decreases from the maximum



expected value. This is due to a reduction in the approach flow available to be diverted into the scour hole, and the surface roller (formed at the free surface around the pier) also interferes with the formation of the horseshoe vortex and the downflow into the scour hole. Without riprap the scour depths at the pier were less in the shallower cases. With riprap this trend is also experienced. The flow system is weaker and cannot pluck riprap stones as easily from the upstream face of the pier. The reduced downflow and horseshoe vortex systems also result in reduced leaching ability. Both shear and leaching failure mechanisms are therefore impaired by a  $y_o/D$  ratio  $< 2$ .



**Figure 4.10.** Effect of flow depth variation on scour reduction. In the legend " $y_o$ " denotes ambient depth  $y_o$ , S2 denotes 16 mm riprap and S3 denotes 22 mm riprap.

### Summary and Conclusion

From these results it is apparent for  $y_o/D < 2 - 3$  riprap failure mechanisms are inhibited and maximum scour depths may not be experienced. It would seem appropriate to ensure that all experiments with piers and riprap layers are conducted at  $y_o/D > 2$ , or if this cannot be accomplished then compensation made in the results for the lesser scour depths. The results in Figure 4.10 indicate the trend and could provide a guide for adjusting any shallower depth results.

### 4.3.5 Geotextiles

#### 4.3.5a Experiments in the 0.44 m Wide Flume

Leaching effects experienced by riprap layers are due to the removal of fine material from between the voids in the riprap stones. At deep placement depths within the bed, the dominant failure mode for the riprap layer becomes leaching. To prevent this loss of material, it has been proposed that the presence of some form of filter beneath the stone layer would be of benefit. To test this theory a series of experiments were conducted in the 0.44 m wide flume with a synthetic filter material placed underneath a

pier riprap layer. Results showed unexpectedly few benefits for this arrangement. The reason for this appears to rest in the fact that the geotextile had the same areal cover as the riprap. Based on the relatively discouraging results from the University of Auckland, the St. Anthony Falls Laboratory group studied riprap with a partial geotextile cover. Results were far more encouraging.

### *Experimental Setup*

A non woven synthetic filter layer was installed beneath the layer of riprap stones around the cylindrical pier. The filter extended to the same coverage dimensions ( $c = 4D$ ) as the riprap material. The filter was tightly fitted around the pier to ensure the downflow of water would not pass between the pier and the filter, resulting in leaching at the pier face and possible uplift of the material. Subsequently, experiments with coverage  $c = 3D$  were also undertaken at the University of Auckland, the results similarly showing improved performance. Figure 4.11 shows the method of placement of synthetic filter materials for such experiments. Also shown is the metal ring used for riprap stone placement.

Pier diameter D (mm)	70
$U/U_c$	1.84 to 3.10
$U/U_{rc}$	0.5 to 0.84
Y/D	0, 0.286, 0.571, 0.857
c	4D

### *Results and Discussion*

Synthetic filters were trialed beneath riprap layers for a wide range of flows under live bed conditions. It was decided to also vary placement depths of the riprap to determine if this parameter was influential for the filter layer. After observing initial runs it was decided to define failure as having occurred if the filter material was exposed such that no riprap stones were present at the nose of the pier. Therefore partial failure conditions meant that in particular areas filter material could be observed but at least one stone thickness of riprap was present over the majority of the filter fabric.

Table 4.1 summarizes the results of the runs with a geotextile. The  $d_s/d_{s0}$  column contains the results of previous riprap runs under the same conditions but without a filter layer installed. When the filter was considered to have failed, scouring was able to occur at the pier face and in time this would likely have reach the unprotected (no riprap) depth of scour. When there was partial failure of the filter leaching or scouring was beginning to be observed at the pier face but was not developed enough to give a  $d_s/d_{s0}$  value greater than approximately zero. If the riprap layer was not reinstated it was thought the layer would continue to degrade until the failure stage was reached. For the no failure case no scouring was observed at the pier face resulting in a value of  $d_s/d_{s0}$  of zero.

Filter layers beneath riprap in live bed conditions provide a clear separation between the underlying material and the stones themselves. This prevents leaching of the finer bed material from occurring. As a result the layer does not easily settle down into the bed with the passage of successive bedforms.

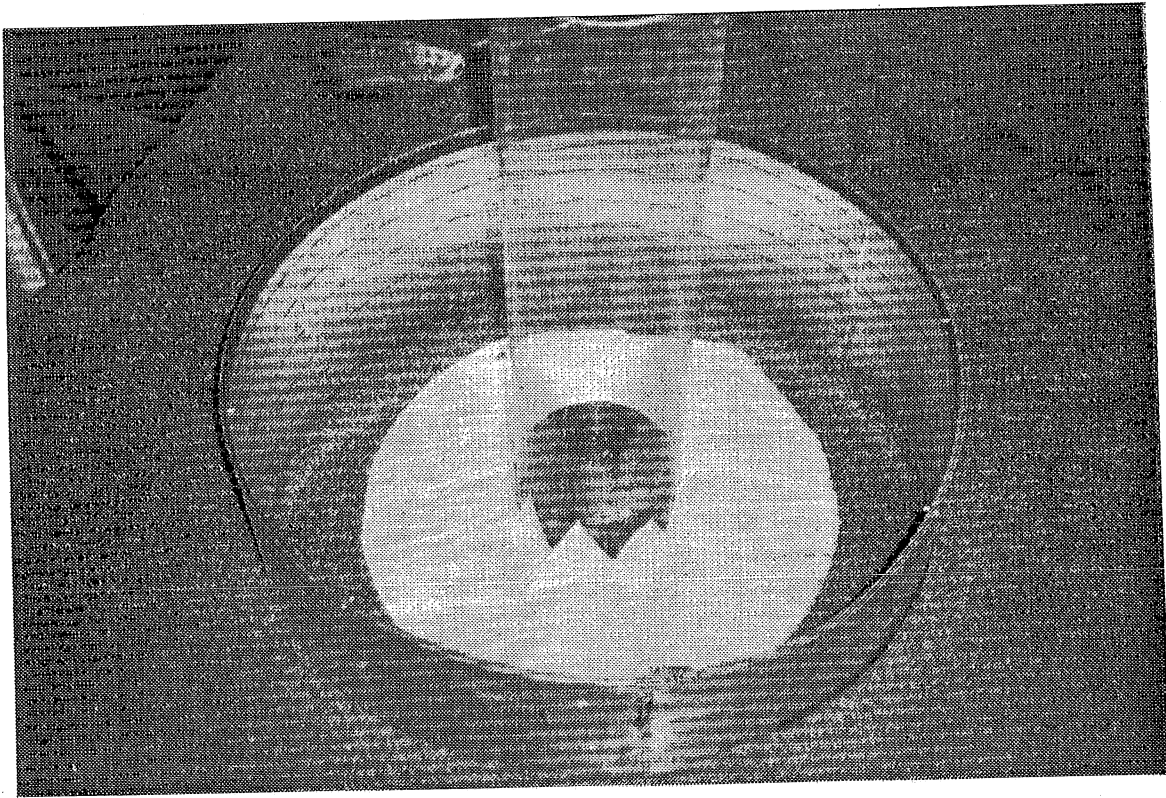


Figure 4.11. Illustration of the placement of the geotextile.

When the riprap layer is placed level with the original flat bed or close to the surface complete failure of the riprap protection occurs. With the passage of bedforms the stones at the edge fail and fall into the scour region at the sides and front. The filter does appear to strengthen the edge regions so that edge failure is slower in propagating. However, as the layer does not subside down into the bed it remains perched around the pier when deep troughs pass by. With the passage of successive dunes more front stones move forward to fill in the scour zone until gradually the filter is exposed. Eventually the entire frontal region becomes devoid of stones except at the edges. The filter layer bends down at the edge to conform to the bed and is prevented from rolling up by riprap stones that have moved to the front edge and effectively pin it down. Uplift pressures beneath the layer can be high due to low permeability of the filter fabric, and without riprap stones to weigh it down the fabric bulges. At higher flow velocities the riprap stones were moved well forward of the filter, leaving it exposed. This allowed the filter to be folded back upon itself, further reducing any protection ability.

Synthetic filters did not prevent leaching against the pier face, with a scour hole forming or beginning to form at the pier nose, as in all but the deepest placement case the front section was devoid of riprap stones. Leaching was also observed if the filter was not tightly held against the pier.

Figure 4.12 and 4.13 detail these responses of filter layers to the movement of bedforms past the pier. In Figure 4.12 the filter layer is gradually exposed as edge stones move out from the pier and the filter close to the pier becomes visible. The layer then develops a pressure bulge. The second alternative, shown in Figure 4.13, is where the edge stones move completely away from the filter, allowing it to fold back upon itself.

**Table 4.1.** Summary of Experimental Results for Riprap with Geotextile. Note that "RF" in the first column is an abbreviation for "riprap with filter."

Exp. Number	Time (hrs)	U/U <sub>rc</sub>	Y/D	d <sub>s</sub> /d <sub>so</sub> (no filter)	Comments
RF1a	20	0.5	0.000	0.391	Complete failure - filter exposed, no stones remain on the filter layer except at the edge.
RF1b	24	0.5	0.286	0.203	Partial failure - no scour at pier face, filter exposed at front and side regions, no layer subsidence
RF1c	19.5	0.5	0.571	0.094	Partial failure - no scour at pier face, filter exposed at front and side regions, no layer subsidence
RF2a	3.5	0.701	0.000	0.388	Complete failure - front riprap stones removed causing front region of filter to be exposed, riprap stones at edge held filter against flapping, uplift pressures beneath cause bulging of material.
RF2b	23.5	0.701	0.286	0.411	Complete failure - all stones removed from the front and side regions. Strong uplift pressures on filter but held down at edges.
RF2c	24	0.701	0.571	0.155	Partial failure - extensive edge failure, front region thinned to 1 D <sub>50</sub> thick. Filter visible beneath stones. Rear intact.
RF2d	24	0.701	0.857	0.000	Isolated edge failure is the only stone movement observed. No leaching adjacent to pier face.
RF3a	0.083	0.841	0.000	0.595	Complete failure - with the passage of dunes strong turbulence plucks stones from the layer. Stones could not move forward, so layer disintegrated from the front.
RF3b	1.5	0.841	0.286	0.248	Complete failure - stones removed from the front, side and rear. Filter bulged, held down at edges by stones. Leaching and scour occurring at pier face.
RF3c	24	0.841	0.571	0.207	Complete failure - stones removed from majority of areas at the sides and the front. Layer not held down at front, resulting in filter lifting and being folded upon itself.
RF3d		0.841	0.857	0.116	No leaching or scouring at upstream nose of pier. Layer thinned in most areas. Front section folded down to conform with bed.

All of the results mentioned in this section indicate that the presence of a filter material beneath the riprap layers does not improve overall layer stability. These results appear contrary to previous experimental tests (Posey, 1974) involving granular filter layers. It was therefore decided to conduct a further series of experiments at a larger size scale. The filter material could not be scaled accurately to the model size used in the 0.44 m wide flume and hence the results could be affected by a scale effect between the riprap size and geotextile properties, such as pore size and tear strength. In a prototype situation it is thought that the down flow and horseshoe vortex systems would be unable to sweep the riprap off the filter except under extreme flood conditions or for undersized riprap materials.

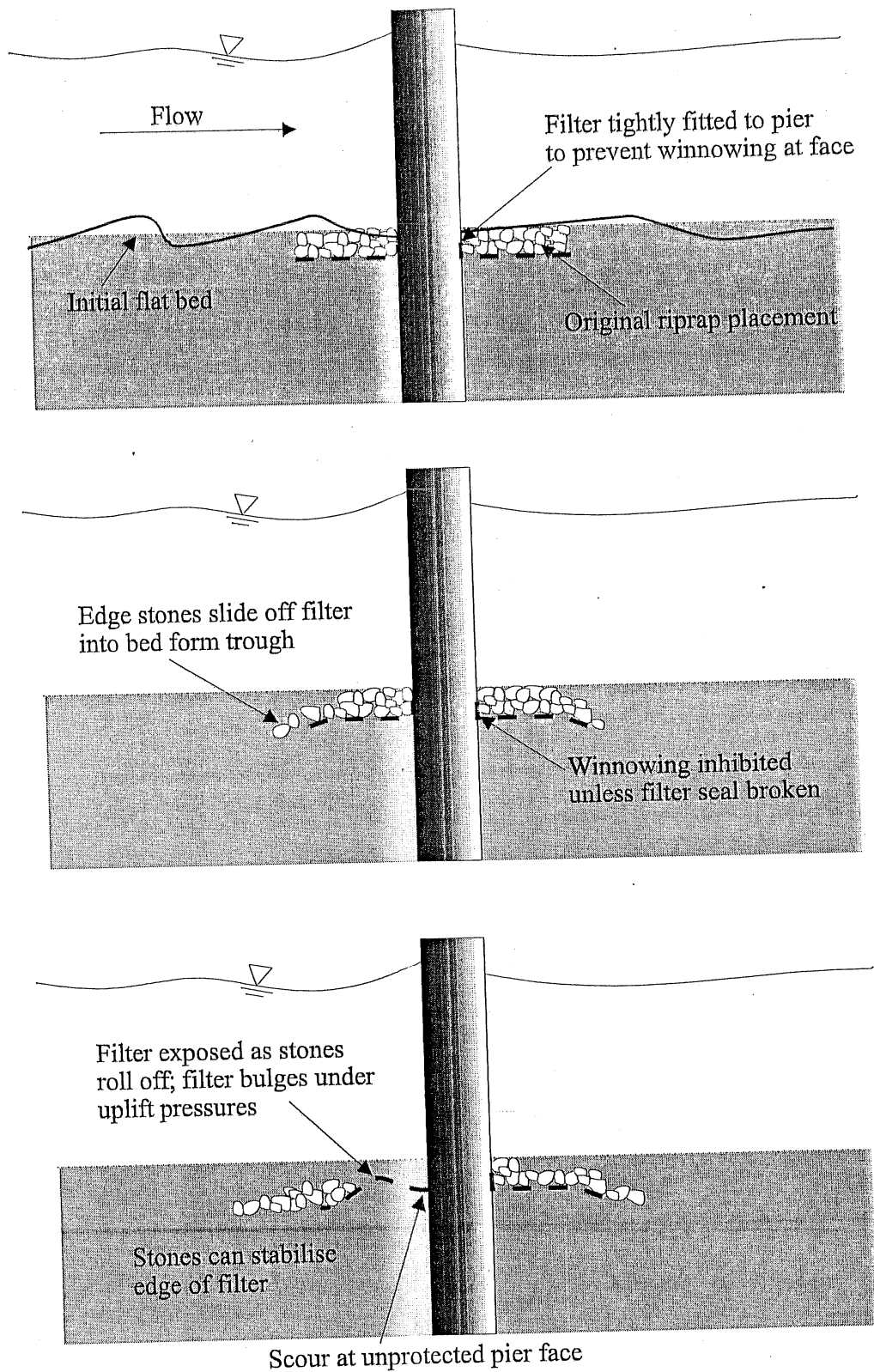
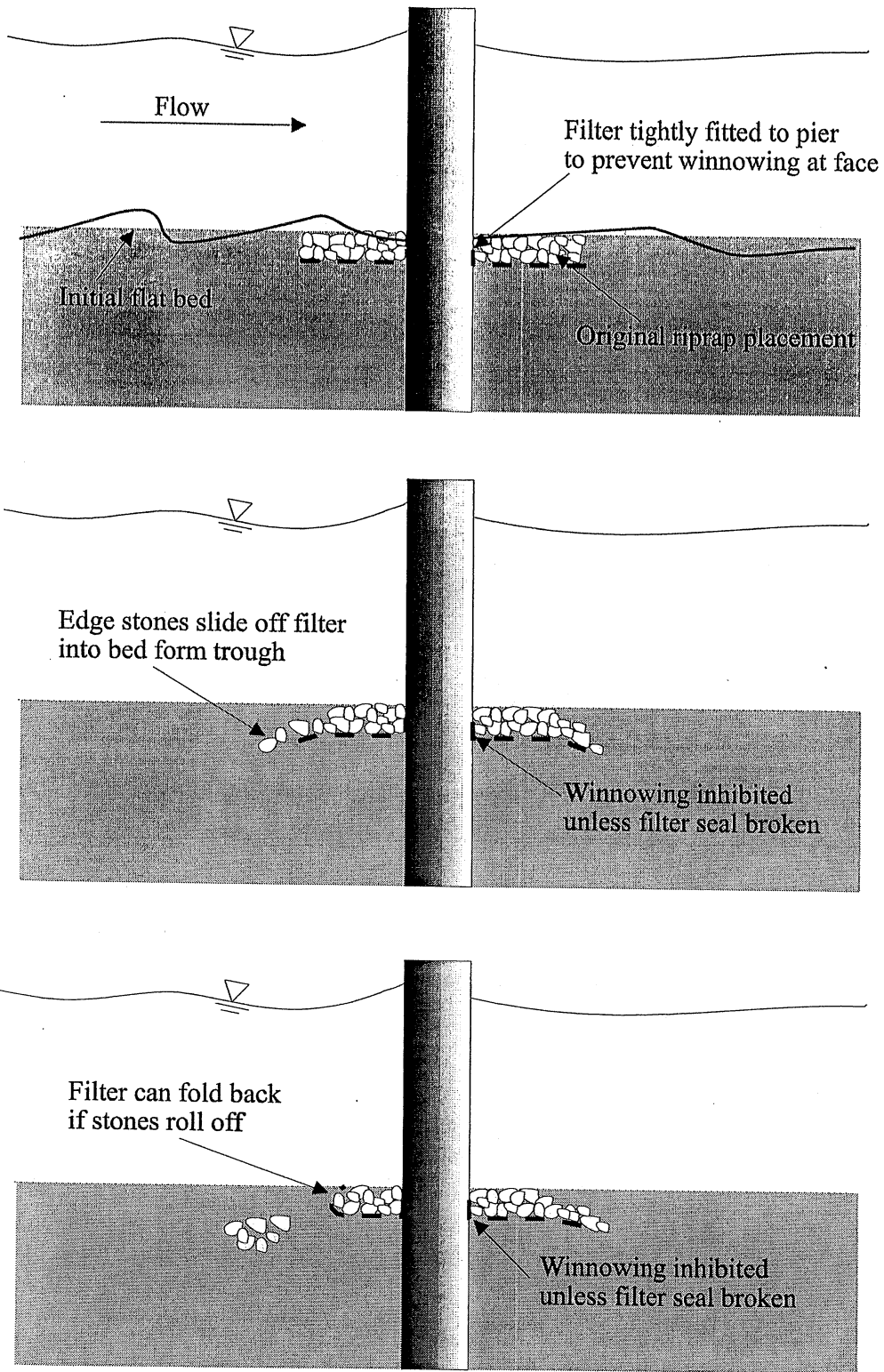


Figure 4.12. Failure sequence of filter layer resulting in uplift pressure bulge in filter material.



**Figure 4.13.** Failure sequence of filter layers resulting in rollup failure.

#### 4.3.5b Experiments in the 1.52 m Wide Flume

To ascertain if the results of previous filter tests in the 0.44 m flume were applicable on a larger scale a second series of experiments was performed in the 1.52 m flume using three different filter fabrics, denoted as Filters 1, 2 and 3. It was also hoped that these experiments would indicate any scale effects from the previous series. The three different filter materials were tested at three separate flow velocities. The results were compared to assess if all the materials performed in the same manner.

An aspect of this second series that differed from the first was the lateral extent of the filter. From the first series it was noted that the filter was exposed initially by the movement of edge stones due to dune destabilization. If the geotextile cover were reduced from 4D to 3D it would be possible for the edge stones to subside. Instead of moving off the layer completely the stones would sink into the surrounding bed and in the process the filter material would be folded down. The advantage of this would be reduced exposure of the filter and a reduction in susceptibility to roll up failure. Allowing the edge stones to move down into the trough would also provide an armoring layer upstream of the general riprap layer.

**Table 4.2.** Results of Synthetic Filter Experiments Performed in the 1.52 m Wide Flume.

Exp. No.	D <sub>50</sub> (mm)	v <sub>0</sub>	V/D	time (hrs)	d <sub>r</sub> (mm)	d <sub>r</sub> /d <sub>0</sub>	U/D <sub>50</sub>	U/D <sub>50</sub> <sub>r</sub>	Comments
R1F1a	50	0.6	0	24	0	0.000	1.48	0.29	Only edge stone movement visible
R2F1a	66	0.6	0	24	0	0.000	1.48	0.27	Outward movement of stones around edges, no thinning
R1F1b	50	0.6	0	24	15	0.048	1.84	0.35	General settling of front regions with thinning at pier face and outward movement of edge stones
R1F2b	50	0.6	0	24	25	0.081	1.84	0.35	Layer clearly thinned at pier face with some filter material visible
R1F3b	50	0.6	0	24	0	0.000	1.84	0.35	Layer intact, only limited outward stone movement
R2F1b	66	0.6	0	24	0	0.000	1.84	0.35	Only slight movement of edge stones
R2F2b	66	0.6	0	24	0	0.000	1.84	0.35	No stone movement close to the pier
R2F3b	66	0.6	0	24	0	0.000	1.84	0.35	-
R1F3c	50	0.5	0	24	25	0.081	2.26	0.44	Little change in layer with only outward movement of edge stone occurring
R1F2c	50	0.5	0	24	0	0.000	2.26	0.44	u/s section subsided with layer thinned at pier face, intact in other areas
R2F3c	66	0.5	0	24	5	0.016	2.26	0.41	Outward movement of edge stones, u/s of the pier the layer has thinned
R2F2c	66	0.5	0	24	10	0.032	2.26	0.41	u/s section subsided forward but layer thickness intact



The results of the large scale experiments are given in Table 4.2. It can be seen that only negligible scour was recorded at the pier face with any of the filter fabrics over the range of flows tested. In some cases thinning of the layer was observed upstream of the pier. Not enough stones were removed, however, to expose the filter fabric beneath. A comparison with the experiments without a geotextile shows a marked improvement in riprap layer performance with the filters in place.

The presence of the geotextile was observed to prevent finer material from being winnowed through the voids at the pier face and therefore eliminating local scouring. The passage of bedforms caused the upstream and side stones to move outward and subside into the surrounding bed material. In some cases this movement resulted in the filter material upstream of the pier deforming as it was undercut, allowing more stones to move forward. This movement was a predicted result of reducing the filter cover. It can perhaps be ameliorated, however, by using a more permeable geotextile.

In these larger scale experiments the layer on the filter did not thin significantly, as the outward stone movement was not as extensive as in the previous experimental series. In a limited number of cases the riprap layer became thinner during the course of the experiment, with a final thickness of  $1D_{r50}$  over the upstream section of the layer. The thinner layer allowed the filter material to be visible beneath the riprap stones, but at no time was the filter completely exposed. One layer of stones still provided total coverage of the filter and in no area was the filter able to be uplifted or rolled up. It appears that the presence of the filter concentrates the vortices in front of the pier, so that they are able to move stones rather more readily than when the stones can embed into the bed sediment.

### ***Conclusion***

The results of these studies suggest that when the geotextile cover is the same as that of riprap, geotextiles can easily be exposed as the fluctuating mobile bed dislodges stones from the riprap layer. This can encourage failure before that expected with riprap alone. When the initial placement level was deep within the bed, the geotextile did provide potential benefits. In these situations the filter fabric prevented leaching at the pier face. As the riprap layer was not significantly undercut, the majority of front, side and rear stones remained in place.

Experiments at both the University of Auckland and St. Anthony Falls Laboratory indicate, however that the plucking of riprap stones from a geotextile can be greatly suppressed, and performance consistency improved, if the geotextile cover  $c$  is  $2/3$  of that of the riprap. Edge failure of the riprap anchors the geotextile in place, leading to much improved performance. In addition, the relatively porous geotextile used at St. Anthony Falls Laboratory prevented the buildup of uplift forces. Finally, sealing the geotextile to the pier greatly reduced leaching.

### **4.3.6 Degradation**

#### ***Introduction***

Degradation occurs in rivers when the outflow of material exceeds the inflow, resulting in a net loss of sediment. In the case of bridge piers degradation of river bed level is identified as general scour. This can occur by itself or in conjunction with local scour around the pier. How degradation of the river bed affects riprap protective layers around piers is not known, so two series of experimental runs were undertaken to investigate this potential problem. The first series utilized a uniform bed material  $d_{50}$  of 0.95 mm. Parameters such as layer thickness and coverage area were altered over a wide range of flows from  $U/U_c = 1.5$  to 2.2. The second series involved a non uniform sediment,  $d_{50} = 1.0$  mm and  $\sigma_g = 3$ . The range of flows tested covered  $U/U_c = 1.25$  and 1.85 as at any higher flows the rate of removal of the finer materials was too great. Due to the overlap in flows tested the uniform and non uniform results can be compared for  $U/U_c = 1.5$  and 1.85.



### Experimental Setup

Experiments were conducted in the 0.46 m wide non recirculating flume. A false floor was installed along the length of the flume except for a 1 m section. This recess contained a jacking table, used to simulate a degrading bed, and was filled with bed material. Degradation (DG) rates were controlled by a simply computer program. Riprap layers were installed in a circular array around the pier and placed with the surface stones level with the undisturbed bed.

Pier diameter $D$ (mm)	70
$U/U_c$ (uniform)	1.5 to 2.2
$U/U_c$ (non uniform)	1.25 to 1.85
$y_0$ (mm)	200
$d_{50}$ (uniform) mm	0.95
$\sigma_g$ (uniform)	1.1
$d_{50}$ (non uniform) mm	1.0
$\sigma_g$ (nonuniform)	3
$C$	4D

The rate of degradation of the sediment bed was controlled by the rate of vertical movement (uplift) of the table in the sediment recess. Uplift was directed so that as the bed degraded with flow movement, the surface of the sediment remained at the same level as the false floor sections. Trial and error were used to determine the rate of uplift required. The experimental setup is illustrated in Figure 4.14.

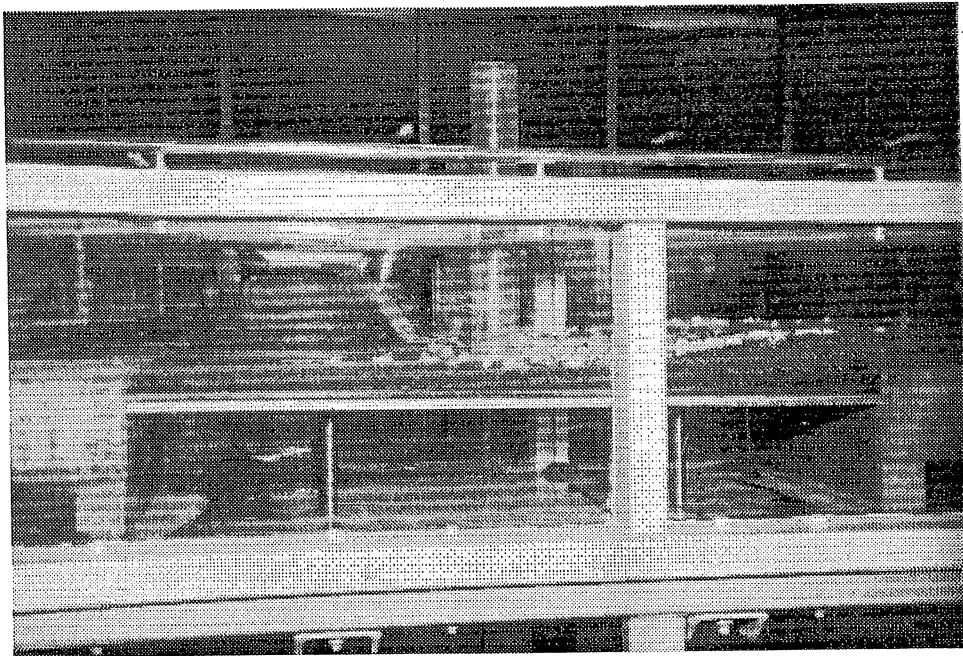


Figure 4.14. Experimental setup for the degradation runs.

## ***Results and Discussion***

### ***Failure Mechanisms***

Observations show that failure under degrading bed conditions occurs as a result of a number of mechanisms. Initially the lack of sediment input induces scouring at the side regions of the riprap layer. As these progress deeper they are able to undercut edge stones, causing them to subside into the scour region. This edge failure gradually progresses around the outer rim until all points are under collapse. With the edge stones removed the inner riprap is exposed, gradually subsiding as sand is winnowed from beneath, until all the layer is at or slightly above the level of the degrading bed.

Using a  $3D_{r50}$  thick layer edge failure occurs but does not initially continue back to the pier, resulting in a inverted cone shaped array. However, as the protrusion of the stones close to the pier increases leaching occurs and the layer eventually subsides to be almost level with the flat bed.

Alternatively, where runs were made with thin ( $1D_{r50}$ ) riprap layers a local scour region developed at the upstream pier face. Then as the edge stones failed they were entrained and moved to fill in the scoured region. This thickened the layer at the nose of the pier, reducing the rate of scour. Stones from the edge and front regions that are not entrained spread out around the sides and downstream areas forming an armoring cover. This cover subsides with the degrading bed.

As parameters such as thickness and coverage of the riprap layer are reduced failure mechanisms like edge failure and subsidence still occur. The rate of failure, however, rapidly increases.

Nonuniformity of the underlying bed material can also affect how the riprap layer fails. A series of runs undertaken with a nonuniform bed sediment ( $\sigma_g = 3$ ) indicate changes occur with the failure mechanisms. Initially, a large amount of scouring occurs at the side edges of the layer with fines being rapidly removed from the bed. This progresses and undercuts the stones, resulting in edge failure. In the front regions fine sediment is removed leaving coarser material which begins to form an armor layer, especially at the lower  $U/U_c$  values of 1.25 and 1.5. Armoring prevents the front stones from exposure until the side scour has progressed to the front and slows its failure. No initial local scouring was noticed in any of the nonuniform bed runs. This is possibly due to the presence of coarser material acting as a filter beneath the stones.

In contrast to the usually gradual scour development and subsidence of the riprap layer in a uniform bed the layers in the nonuniform cases experienced a rapid scour hole development, with the exception of run 4 at  $U/U_c = 1.5$ . This happens as the side failure progresses and removes virtually all side stones. The front stones are then undermined from the side rather than the front and swept to the lee of the pier. Often, merely a handful of stones are left to protect the pier face allowing scouring to progress rapidly. Settling of stones into the bed at the front and sides of the layer does not appear to occur in the nonuniform material.

### ***Thickness***

#### **Thickness (t)   Effects**

$1D_{r50}$	Initially a large number of front riprap stones moves to the upstream face and proceed to fill in any local scour hole that forms. This in turn thickens the layer, reducing the rate of leaching and scour. In all but one run the layer at the upstream face remained $1.5 \leq t/D_{r50} \leq 3$ .
$2D_{r50}$	Initially the layer at the pier face thickens, a tendency more obviously observed with the 16 mm stones. Over time the layers tended to remain $2 \leq t/D_{r50} \leq 3$ .
$3D_{r50}$	Only limited initial thickening visible. Most layers had a thickness of $2.5 \leq t/D_{r50} \leq 3$ .

With the smaller 16 mm stones it appears that in almost all cases an initial thickening of the layer occurs due to frontal stones moving into scour regions at the upstream pier face. From this point the layer remains at this new thickness until substantial bed degradation occurs and further thinning begins. The layer thicknesses ranged between  $1.75 \leq t/D_{r50} \leq 4$ . Alternatively, the larger 22 mm riprap stones do not experience as pronounced initial thickening, as local scour does not rapidly occur. The  $1D_{r50}$  layer experienced the most change, oscillating between 1 and  $2.5 D_{r50}$ . However, for the 2 and 3  $D_{r50}$  cases the layers remains almost steady over time as the bed degrades around them.

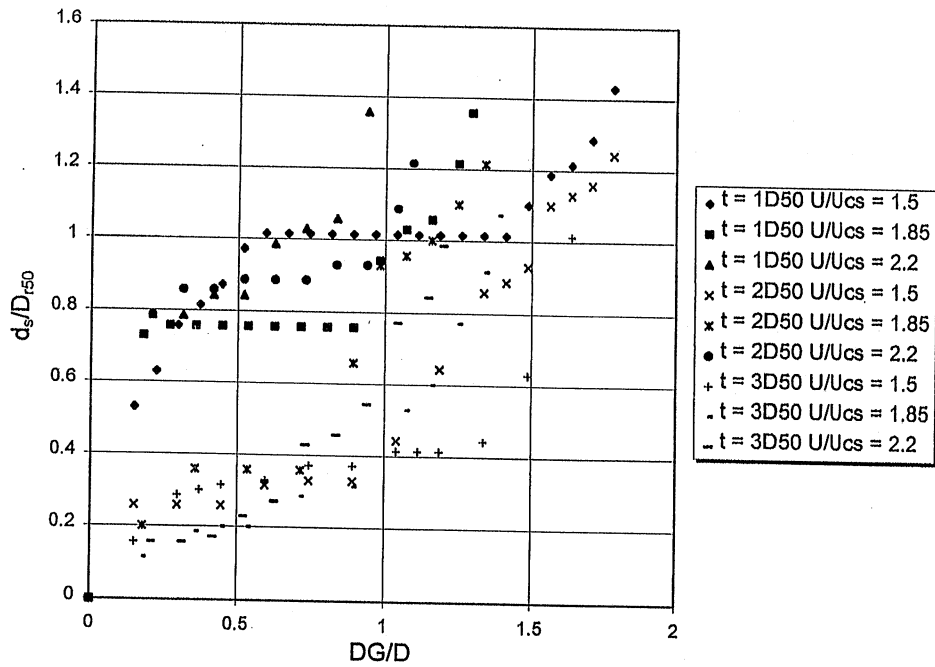
Thickness changes as the bed degraded produced interesting results in the non uniform bed situations. In these runs the layer thickness remained steady at the original level until the degradation level (DG/D) reached between 1.0 to 1.5. From this point the layers thinned rapidly, with the final thickness as low as  $1D_{r50}$  in some cases. When compared to uniform runs for the same initial coverage area and layer thickness these differences in layer responses are evident. The layers in uniform material thickened initially and only thinned to around the original level after extensive degradation.

#### *Local Scour $d_s$*

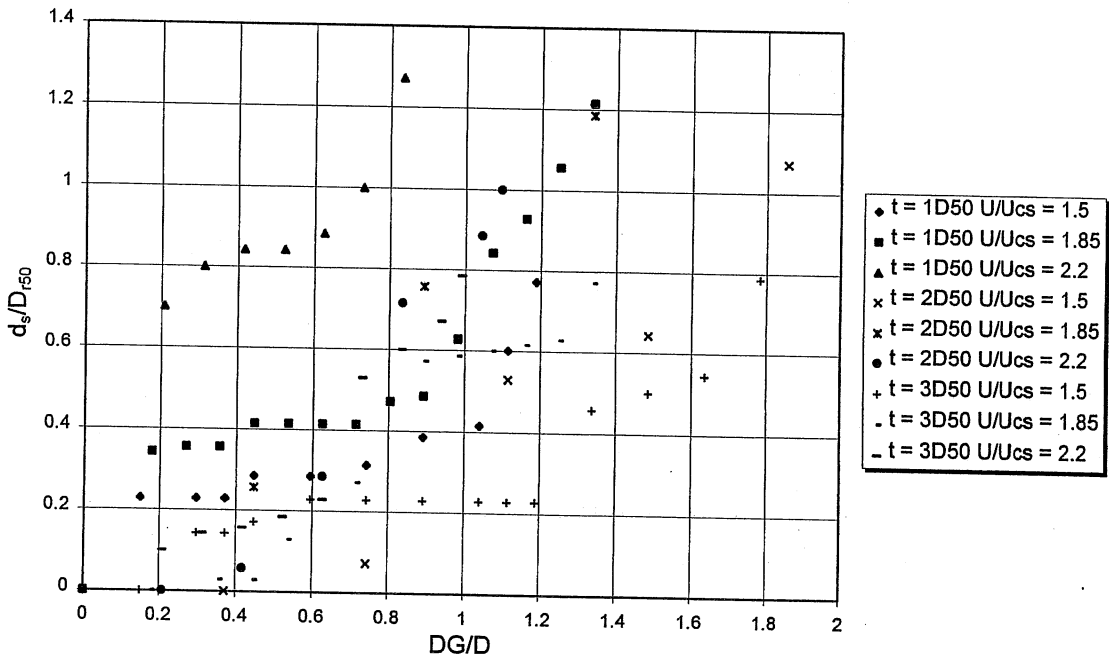
##### Parameter    Effects

- |                               |   |
|-------------------------------|---|
| $t = 1D_{r50}$                | Local scour occurs rapidly especially for the 16 mm stones. The layers then remain at a steady level, with frontal stones moving in, thickening the layer and reducing the rates of leaching and scour. Towards the end of the runs scouring increases again at a steady rate. The 22 mm stones clearly demonstrate that scour depths increase as the flow rate increases, as would be expected.  |
| $t = 2 \text{ to } 3 D_{r50}$ | Initial scouring is noticeable for the 16 mm stones only, especially at $U/U_c = 2.2$ . Once scouring is initiated it continues at a gradual rate.  |
| $c = 3 \text{ \& } 4 D$       | The $c = 3D$ layer (lesser coverage area) enhanced scouring with $d_s/D$ increasing faster than for a degrading bed alone. With the 16 mm stones results lie in two bands with $c = 4D$ layer providing obviously better results and an increased ability to withstand greater bed degradation. For the 22 mm stones the results were intermixed. The lowest flow cases provide the greatest protection, in all other cases no difference between results for either coverage areas is discernible. |

From Figures 4.15 and 4.16, it appears that the rate of scouring increases after the degrading bed reaches a level of  $DG/D \geq 0.8$ . Layer thickness influences on scour depths were more pronounced with the smaller 16 mm stones. In these cases it was an obvious advantage to use 2 or 3  $D_{r50}$  thick layers as failure occurs more gradually. Larger 22 mm stones showed little difference between layer thicknesses although thicker layers could withstand slightly greater degradation of the surrounding bed.

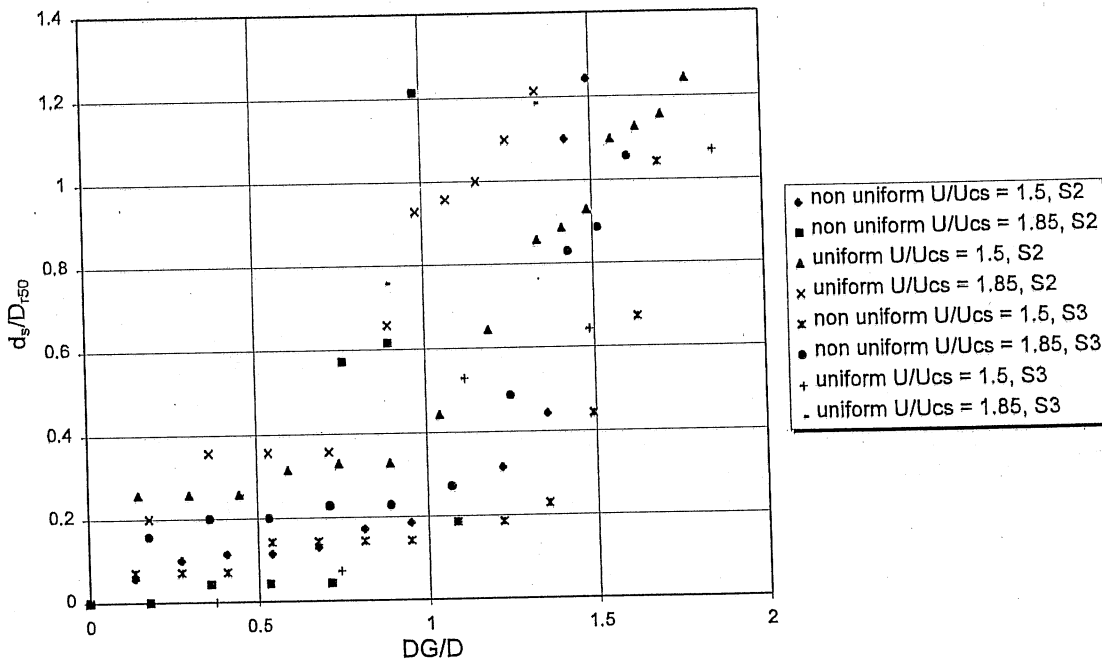


**Figure 4.15.** Comparison of thickness effects for a degrading bed for the case  $c = 4D$ ,  $D_{150} = 16$  mm. In the legend, “D50” indicates the notation  $D_{150}$  in the text, and “U/Ucs” indicates the notation  $U/U_c$  in the text.



**Figure 4.16** Comparison of thickness effects for a degrading bed for the case  $c = 4D$ ,  $D_{150} = 22$  mm. In the legend, “D50” indicates the notation  $D_{150}$  in the text, and “U/Ucs” indicates the notation  $U/U_c$  in the text.

Scouring at the pier face developed very slowly in the nonuniform bed with  $d_p/D < 0.2$  for most cases below  $DG/D = 1.0$ . After this point scouring evolves rapidly with many runs displaying an obvious jump in scour depths. When compared with the uniform results (Figure 4.17) differences are incidental, the only minor variations being the more gradual scouring in the uniform material. In three of the four comparisons the riprap in the nonuniform material reaches the maximum depth between 0.2 to 0.4  $DG/D$  less than the uniform cases. In the fourth case the opposite happens, with no clear reason attributable



**Figure 4.17.** Comparison of local scour levels in uniform and non uniform sediments for  $c = 4D$  and  $t = 2D_{150}$ . In the legend "U/Ucs" indicates the notation  $U/U_c$  in the text, S2 denotes the riprap with  $D_{150} = 16$  mm and S3 denotes the riprap with  $D_{150} = 22$  mm.

The sudden increase in scour depths coincides with a rapid change in riprap layer thickness as noted previously. In Run 4 the initial scour development and gradual increase could be due to the presence of an increased amount of finer material beneath the layer, especially against the pier. Figure 4.18 shows the sediment bed following a typical degradation experiment.

### Conclusion

Degradation experiments have shown that riprap protective layers can provide a reasonably high degree of protection for bridge piers for high rates of degradation and high flow rates. What can be assumed is that in all cases failure would have eventually occurred, the timing of which was dependent on the rate the bed degraded. In a river, if the bed is continually degrading riprap layer protection would eventually fail. However if lack of sediment input is merely a short term problem the layer is likely to be able to withstand the attack. The presence of a nonuniform bed material does not appear to affect the overall results, but can influence the suddenness of riprap scouring and subsidence.



**Figure 4.18.** View of the sediment bed following a typical degradation experiment.

## 4.4 EXPERIMENTS ON SACRIFICIAL PILES

### 4.4.1 Introduction

Alternative pier scour countermeasures come in varying forms. They have been broadly categorized by their approach to reducing scour levels around the pier; either armoring the surrounding sediment bed or deflecting the oncoming flow and thereby reducing the scour potential of the flow. The previous sections have discussed the use of riprap, an armoring countermeasure, for scour reduction at piers. This form of countermeasure has been found to be highly successful if certain conditions are met. As a contrast the present and succeeding sections of this chapter are devoted to investigations of a flow deflecting countermeasures.

The aim of the experiments described in this section was to investigate the use of sacrificial piles as a bridge pier scour countermeasure. Sacrificial piles installed upstream of a bridge pier may divert oncoming flow smoothly around the pier, resulting in a reduction of scour. The effectiveness of this type of protection measure is dependent on the following variables:

- the size, number and arrangement of piles;
- the displacement of the piles from the bridge pier;
- deviations in the direction of flow and skewed piles;
- protrusion of the piles.

The sacrificial piles are small in diameter relative to the bridge pier and circular such that each individual pile is not affected by any change in the angle of attack of the flow. Thus scour depths at the piles themselves will remain constant even if the flow direction changes.

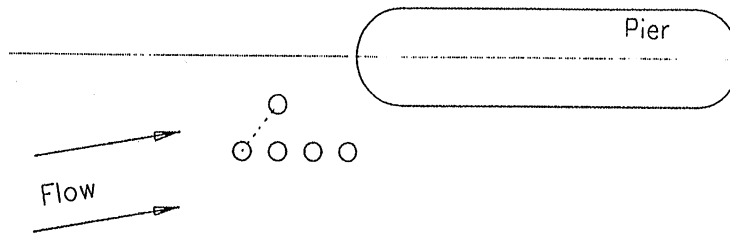
The principle of sacrificial piles as a scour countermeasure is based on two main facts;

1. The bed material eroded from an upstream obstacle will be deposited in the downstream zone (so supplying material to the scour hole);
2. The scour mechanism at the face of a bridge pier will be disrupted if the oncoming flow is diverted around the pier by means of an obstruction in the flow.

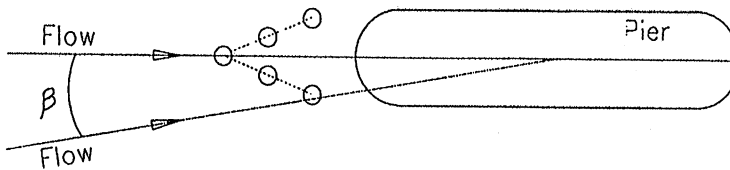
The piles act to increase the curvature of the main flow lines, diverting the high-velocity flow around the bridge pier. Thus the strength of the horseshoe vortex and the erosive action of the flow at the nose of the pier become weaker.

Sacrificial piles as a pier protection measure have been the subject of very limited experimental testing. Chang and Karim (1972) and Chabert and Engeldinger (1956) investigated the effect of sacrificial piles under clear water conditions. Chang and Karim (1972) recorded a maximum reduction in the depth of scour of 62% when the direction of flow was aligned with the axis of the pier.

When deviations in the direction of flow occur fundamental differences exist in the conclusions of the research performed. Chang and Karim (1972) investigated the effect of a long-term deviation in the direction of flow such that the pier was permanently skewed to the flow, as illustrated in Figure 4.19. Sacrificial piles were placed so as to best protect the pier once this deviation in the flow had occurred. Consequently, it was possible to effectively protect the pier and reduce scour depths by 27% to 47%. The study reported here deals with the effect of short-term variations in the direction of flow, similar to the study performed by Chabert and Engeldinger (1956). Sacrificial piles are placed so as to protect the pier when it was aligned with the flow and for skewed flow at angles of 20 and 30 degrees from the centerline of the pier.



Sacrificial piles placed once deviation in flow had occurred (Chang and Karim, 1972)



Sacrificial piles placed to protect the pier from flow at angles between zero and  $\beta$  degrees (University of Auckland, 1997)

**Figure 4.19.** Differences in research performed when there are deviations in the direction of flow.

The initial series of experiments were conducted under clear water conditions, that is below the threshold velocity of the bed material. A series of sacrificial pile configurations were tested to determine the most effective arrangement. Secondly, the same arrangement of sacrificial piles was tested under mobile bed conditions.

### Symbols

The following notations are introduced in this section

$n$	number of piles
$\alpha$	wedge angle defined by the pile array
$\beta$	angle of skew or attack
$d_p$	pile diameter
$e$	longitudinal spacing between the piles
$X$	displacement of the most upstream pile from the pier.

These notations are defined in Figure 4.20.



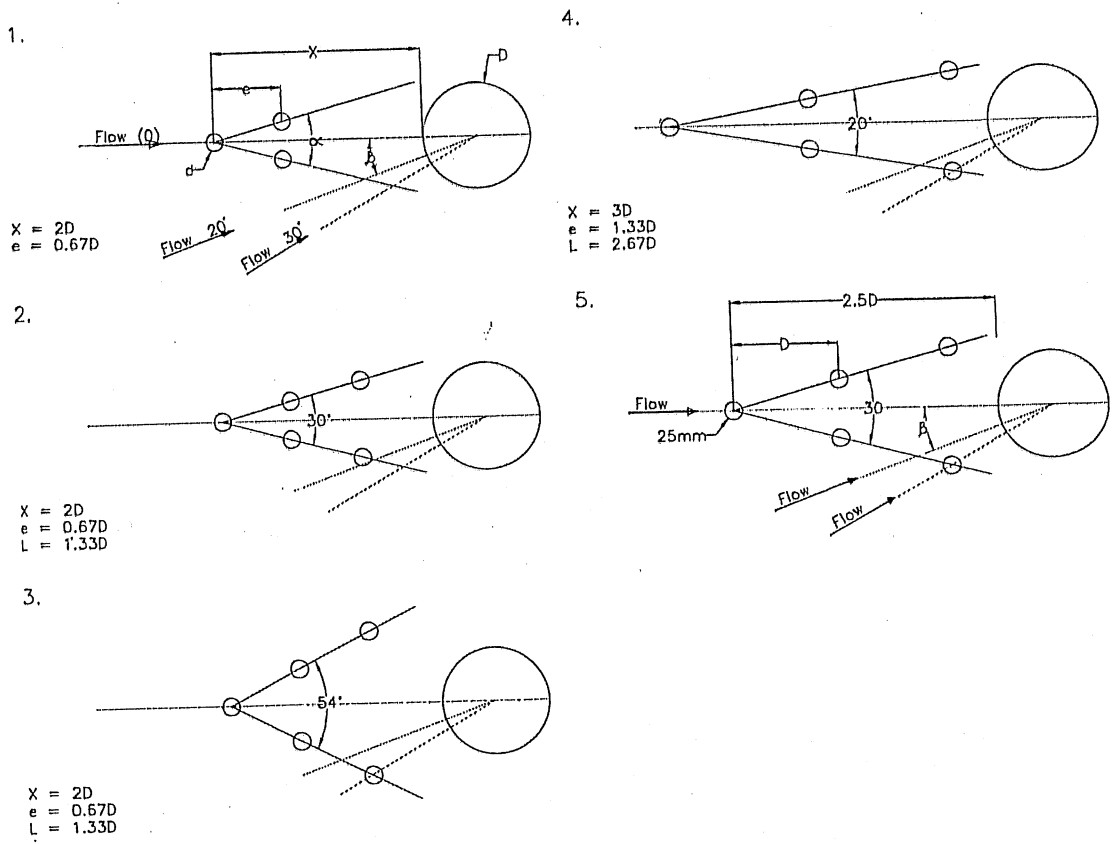


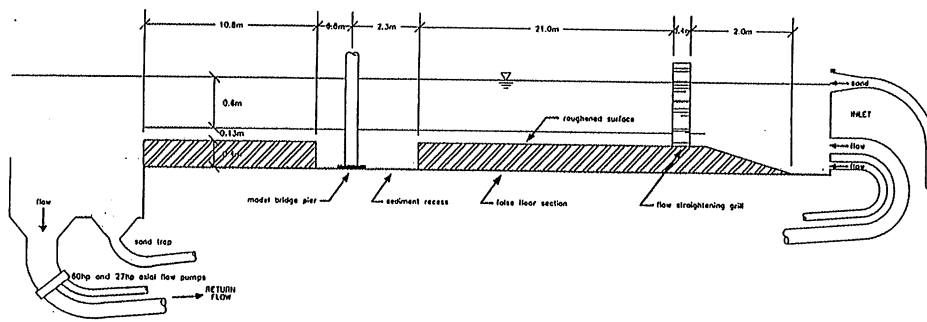
Figure 4.20. Definition of parameters for sacrificial piles

4.4.2 Experimental Apparatus

The sacrificial pile experiments were conducted in a 1.52 m wide, 1.22 m deep, 45 m long, glass sided recirculating flume. The discharge through the flume was controlled by two pumps of 44.8 kW and 20.1 kW. It was possible to tilt the flume electrically through a central pivot to achieve the required slope. The slopes were measured with a dumpy level. A false floor of height 400 mm was constructed over the entire length of flume. A sediment recess of length 3.1 m was situated 26.6 m down the flume. A cross-section of the 1.52 m wide flume is shown in Figure 4.21.

A pier of 150 mm diameter, constructed of clear Plexiglas was positioned in the sediment recess section of the flume. The sacrificial pile arrangement was constructed of 25 mm diameter steel rods mounted top and bottom on steel plates. A base plate was positioned in front of the pier and 150 mm above the bottom of the sediment recess section of the flume. The sacrificial piles were attached to the base plate by three screw holes to allow for easy maneuvering of the pile arrangement.

Bed sediment with a mean diameter ( $d_{50}$ ) of 0.95 mm was used for all experiments in the 1.52 m wide flume. The standard deviation ( $\sigma_p$ ) of the particle size distribution was calculated as 1.23 mm.



**Figure 4.21.** Cross section of the 1.52 m wide, flow recirculating flume.

The critical shear velocity  $u_{*c}$  and critical velocity  $U_c$  of the flow were calculated from Eqs. (3.3) - (3.5). Velocity measurements were made with a standard pitot tube coupled with a Van Essen manometer. The pitot tube was mounted on a vernier scale and positioned on the center-line of the approach flow. Measurements were taken 4.3 m upstream from the model bridge pier. The depth of local scour was measured at the face of the pier using a periscope.

#### **4.4.3 Experimental Technique**

##### ***Clear Water Experiments***

The first series of experiments was conducted under clear water conditions in the 1.52 m wide flume. Clear water conditions exist when the shear velocity of the flow is less than the critical shear velocity of the bed sediment and general movement of the bed material is not occurring. In the 1.52 m wide flume the sediment recess was filled with 0.95 mm ( $d_{50}$ ) sediment. The flume was partially filled with water and the moistened sediment was compacted around the model bridge pier and leveled with respect to the surface of the false floor. The flume was filled with water to a depth ( $y_0$ ) of 600 mm from the surface of the sediment bed.

Velocity measurements were taken in the center of the flume, at ten levels over the water depth. Initially the velocity profile showed high velocities at the base of the flume indicating that a fully developed turbulent boundary layer had not formed. In order to model river conditions, the base of the flume was artificially roughened by placing sheets of sand-coated metal over the entire length of flume up to the sediment recess section. At the inlet to the flume flow straighteners, consisting of a 0.4 m thick honeycomb grill, were covered over their lower section with 200 mm high wire mesh. One fence formed of a double row of dowel pegs 0.30 m in height was placed approximately 10 m down the flume.

The pump(s) were gradually increased to predetermined settings such that the shear velocity ratio ( $u_* / u_{*cs}$ ) of the bed sediment was either 0.9 or 0.6. The flume slope was adjusted to ensure that the depth of flow was constant over the full length of the flume. Scour depths at the upstream face of the pier were recorded over a 24-hour period. At the completion of each experiment the flume was drained and photographs were taken to record the shape of the scour hole.

##### ***Mobile Bed Experiments***

The second of the two series of experiments was conducted under mobile bed conditions in the 1.52 m wide flume. The shear velocity of the flow was increased past the critical shear velocity of the bed sediment such that movement of the sediment was associated with the formation and progression of dunes along the sediment bed.

In the 1.52 m wide flume additional bed sediment ( $d_{50} = 0.95$  mm) was added to an average depth of 130 mm above the surface of the false floor. The flume was filled with water to a depth of 600 mm above the average sediment level.

Velocity measurements were taken in the center of the flume at ten levels over the water depth. The water velocity was set such that the ratio of mean velocity to critical velocity ( $U/U_c$ ) was either 1.48 or 1.84.

Each experiment was run for 24 hours to ensure that live bed scour depths had reached an equilibrium stage and bedforms were fully developed. Scour depths at the upstream face of the pier were recorded every minute for one hundred minutes, so that the average scour depth as well as the maximum and minimum could be determined. Figure 4.22 illustrates a typical sacrificial pile experiment under mobile bed conditions.

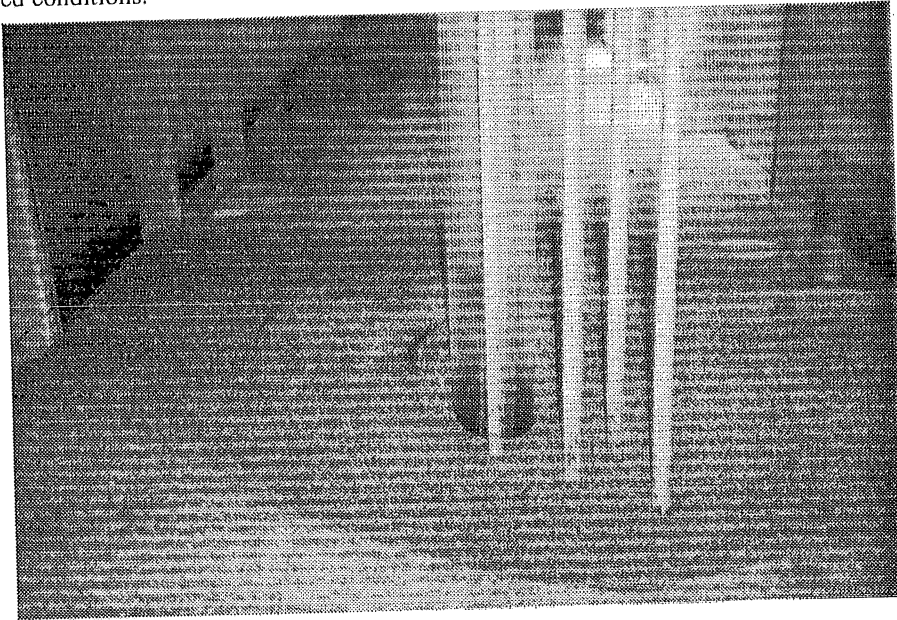


Figure 4.22. Illustration of a typical experiment on sacrificial piles under mobile bed conditions.

#### 4.4.4 Summary of Results

##### *Clear Water Experiments*

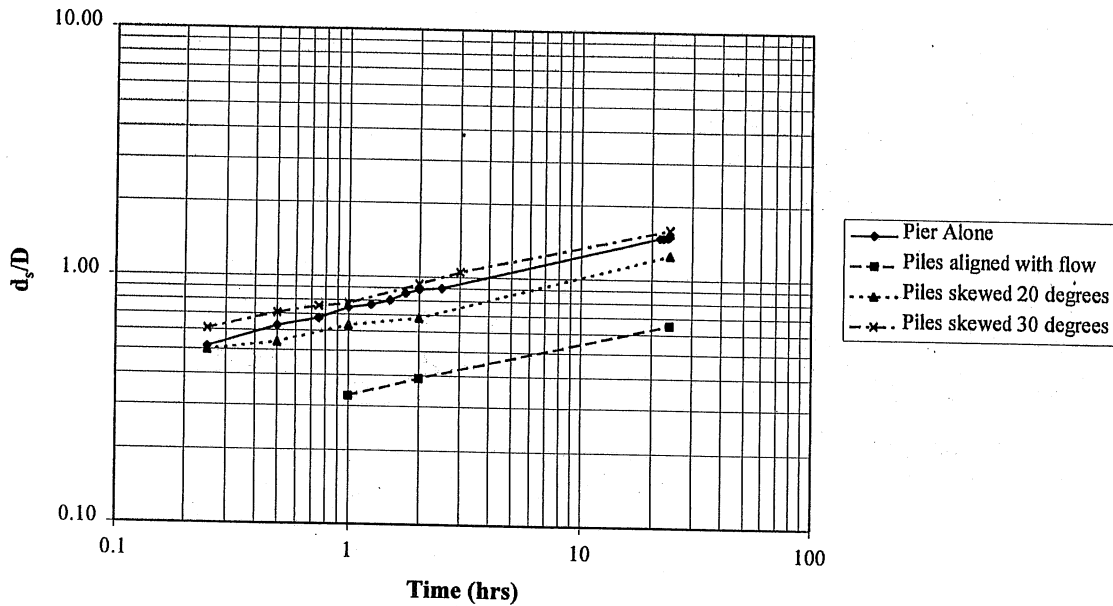
Five different arrangements of sacrificial piles were tested under clear water conditions in the 1.52 m wide flume. The diameter of the bridge pier ( $D$ ) and the diameter of the sacrificial piles ( $d_p = 1/6D$ ) were kept constant while the following parameters were varied systematically:

- number of piles ( $n$ ): 3 or 5;
- wedge angle ( $\alpha$ ):  $20^\circ$ ,  $30^\circ$  or  $53.6^\circ$ ;
- skew angle ( $\beta$ ):  $0^\circ$ ,  $20^\circ$  or  $30^\circ$ ;
- displacement from upstream face of pier ( $X$ ):  $2D$ ,  $2.5D$  or  $3D$ ;
- spacing between piles ( $e$ ):  $0.67D$ ,  $D$ , or  $1.33D$ .

The five sacrificial piles arrangements tested are shown in Fig. 4.13. The results obtained are summarized in Table 4.3.

When aligned with the flow the first arrangement, consisting of three circular piles, achieved a reduction in scour of 48%. When the flow was skewed by 30 degrees however, the scour depth recorded with the piles was deeper than that for the pier alone, giving a scour depth increase of 11%. The reason for

the increase is that this arrangement of piles, when skewed, gave no protection to the pier. Instead, the piles appeared to divert the oncoming flow directly onto the centerline of the pier, thereby increasing the depth of scour at this point. In addition, the sacrificial piles acted to increase the effective width of the pier, which also contributed to an increase in local scour at the face of the pier. For the second test run the percentage scour reduction improved as five piles were used to protect the pier. Figure 4.23 shows the scour depths recorded at the face of the pier for the series of experiments conducted using sacrificial pile arrangement number two.



**Figure 4.23.** Clear-water scour depths for sacrificial pile arrangement no. 2 ( $u./u_{*c} = 0.9$ ).

In subsequent test runs the piles were arranged so that one pile remained on the centerline of the pier when the flow was skewed by 30 degrees. A minimum of five sacrificial piles were required to effectively protect the pier. At near threshold conditions ( $u./u_{*c} = 0.90$ ) using sacrificial pile arrangement number five (refer to Figure 4.13) with the flow skewed by 30 degrees the maximum scour reduction achieved was 26%. The results for this arrangement are given in Table 4.3. For piles aligned with the flow, the effect of increasing either  $\alpha$  or  $X$  is an increase in the depth of scour.

**Table 4.3.** Scour reduction achieved by sacrificial piles (clear water conditions)

Constant Parameters:  $D$  = diameter of bridge pier = 150 mm  
 $d_p$  = diameter of sacrificial piles = 0.167D

Test No.	Sacrificial Pile Arrangement:					Scour Reduction % (after 24 hrs)	
	$n$	$\alpha$ (°)	$\beta$ (°)	$X$	$e$	$u_* / u_{*c} = 0.9$	$u_* / u_{*c} = 0.6$
1	3	30	0	2D	0.67D	48%	48%
	3	30	30	2D	0.67D	-11%	
2	5	30	0	2D	0.67D	56%	
	5	30	20	2D	0.67D	16%	-8%
	5	30	30	2D	0.67D	-6%	
3	5	53.6	0	2D	0.67D	35%	36%
	5	53.6	20	2D	0.67D	22%	22%
	5	53.6	30	2D	0.67D	20%	
4	5	20	0	3D	1.33D	47%	
	5	20	20	3D	1.33D	21%	
	5	20	30	3D	1.33D	20%	
5	5	30	0	2.5D	D	41%	
	5	30	20	2.5D	D	23%	
	5	30	30	2.5D	D	26%	

**Mobile Bed Experiments**

The optimum sacrificial pile arrangement identified under clear water conditions (as depicted in Table 4.4) was tested under mobile bed conditions in the 1.52 m wide flume. The pile arrangement was tested while aligned with the direction of flow and for skewed flow at angles  $\beta$  of 20° and 30°.

**Table 4.4.** Scour reduction achieved by optimum sacrificial pile arrangement (mobile bed scour).

Sacrificial Pile Arrangement  Skew Angle, $\beta$ ( $^{\circ}$ )	Scour Reduction $r_s$ % (after 24 hours)*		
	clear water conditions	mobile bed conditions	
	$u_* / u_{*c} = 0.9$	$U/U_c = 1.48$	$U/U_c = 1.84$
0	41%	18%	15%
20	23%	5%	1%
30	26%	-4%	-6%

\*The results compare the maximum scour recorded for the pier alone to the maximum scour recorded with the sacrificial piles.

Constant Parameters:	D	= diameter of bridge pier	= 150 mm
	$d_p$	= diameter of sacrificial piles	= 0.167D
	$\alpha$	= wedge angle	= 30 $^{\circ}$
	X	= distance from upstream face of pier	= 2.5D
	e	= spacing between piles	= D
	n	= number of piles	= 5

From Table 4.4, it is apparent that at high flow rates the effectiveness of sacrificial piles is reduced significantly. For piles aligned with the direction of flow the scour reduction is only 15% of the maximum scour recorded with the pier alone. As the maximum scour for the pier alone was 228 mm this reduction is approximately 34 mm in depth. For flow skewed at an angle of 30 degrees the sacrificial piles act to increase the depth of scour at the pier by as much as 6%, thus heightening the risk of bridge pier failure.

The method of presenting the results may affect the interpretation of the data recorded. The percentage scour reduction compares the maximum scour recorded for the pier alone to the maximum scour recorded with the sacrificial piles. Although measurements were taken over a 100 minute time period it is possible that a larger dune or trough passed the pier during successive experiments so that different results were recorded for two identical experiments. Consequently it may be appropriate to compare both maximum and average scour depths recorded. The maximum scour depths are tabulated here, as these are the critical values which should be considered. Figure 4.24 shows the variation in scour depths over the 100 minute time period, where the maximum points show the maximum scour depth recorded.

### Live bed scour with sacrificial piles

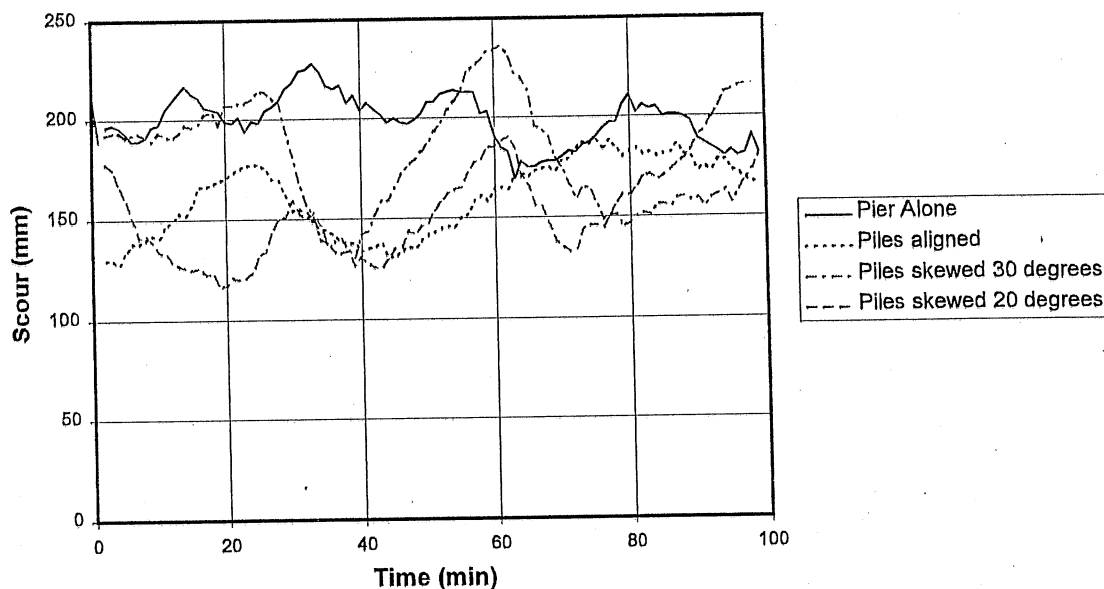


Figure 4.24. Mobile-bed scour depths for sacrificial pile arrangement no. 5 ( $U/U_{cs}=1.48$ ).

As sacrificial piles are placed in front of the bridge pier, and are specifically designed to best protect the pier when aligned with the direction of flow, any deviations in the flow can produce adverse scour effects. The sacrificial piles may no longer completely protect the pier and may increase the depth of scour by diverting the flow onto the face of the pier or by increasing the effective width of the pier. The experimental results verify that as sediment movement and flow velocities increase, turbulence and local flow variations act to decrease the effectiveness of sacrificial piles.

#### Conclusions

The results of this study suggest that sacrificial piles provide little protection against scour at bridge piers under mobile bed conditions. When the angle of attack  $\beta$  is sufficiently large, the sacrificial piles can worsen the scour problem.

## 4.5 EXPERIMENTS ON SUBMERGED VANES (IOWA VANES)

### 4.5.1 Introduction

In addition to sacrificial piles, submerged vanes were also chosen as a flow altering countermeasure worth testing, as they have proved effective at sediment redistribution in river channels. Only very limited information exists as to their potential as a pier scour countermeasure, however (Odgaard and Wang, 1987).

It has been suggested that submerged vanes offer a potential pier scour countermeasure because of their ability to disrupt the horseshoe vortex mechanism and redistribute sediment within the channel. They are thought to operate in three ways:

- The scour mechanism at the face of a bridge pier will be decreased if the oncoming flow can be disrupted, giving a reduction in the strength of the downflow at the pier face.
- Bed material is eroded from around the upstream vanes and deposited in the scour hole, downstream.
- The sediment that is being transported by the flow will be directed towards the scour hole by the presence of the vanes. The resulting sediment bar should deposit material into the scour region.

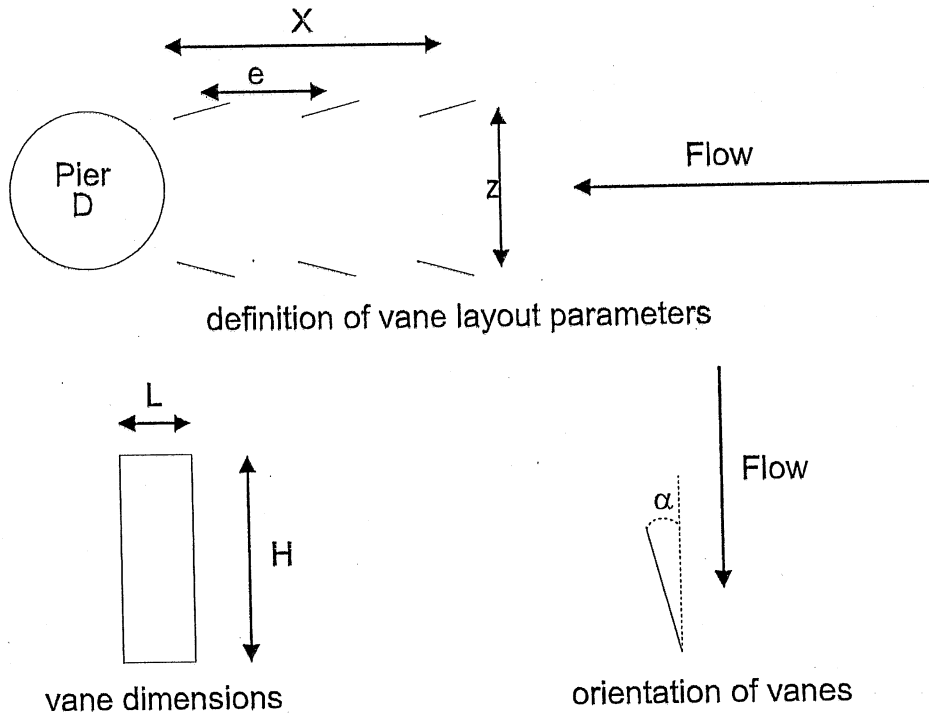
Whether submerged vanes do effect these three methods of reducing local scour levels at bridge piers is not known. The experiments described in the following sections purport to answer this question. They assess the scour reduction potential of two different submerged vane designs and the importance of parameters such as submergence, lateral and horizontal spacing, as well as the effects of vane angle to the approach flow. The small number of experiments detailed represents a preliminary investigation of design parameters for using submerged vanes at bridge piers.

The following notations are introduced in this section.

$e_v$	transverse spacing between vanes
$n_v$	number of vanes
$d_{save}$	average scour depth
$\alpha_v$	angle of orientation of each vane to the flow
$L_v$	vane length
$H_v$	vane height
$z_v$	lateral spacing between vanes
$T_v$	depth of submergence of the vanes below the water surface
$X_v$	displacement of the mode upstream vane from the pier.

These notations are defined in Figure 4.25

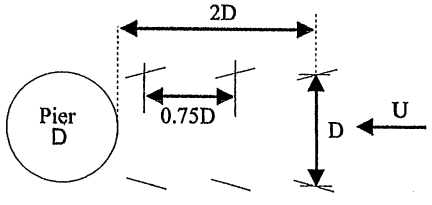
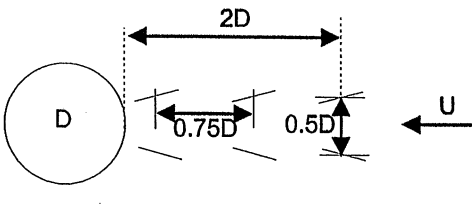
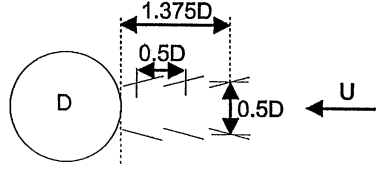
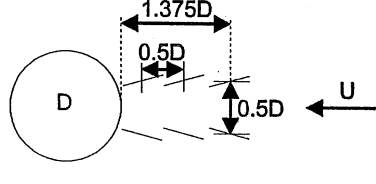
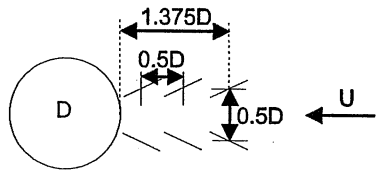
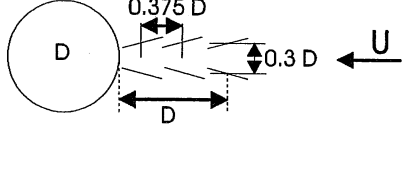


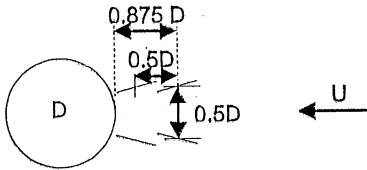
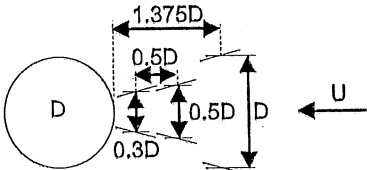
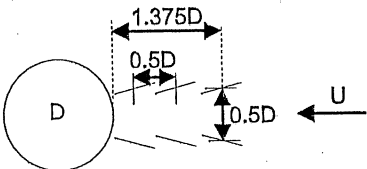
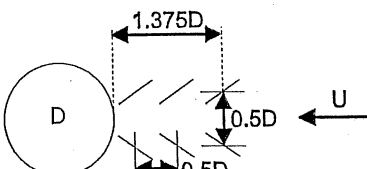
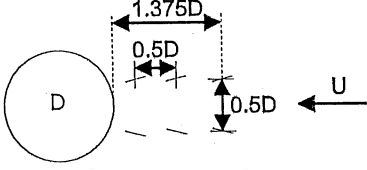
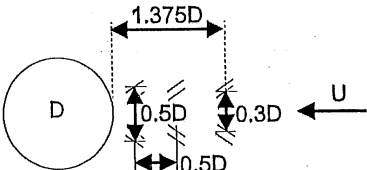


**Figure 4.25.** Definitions of parameters for submerged vanes.

Experiments on submerged vanes were performed in the 2.4 m wide nonrecirculating flume and the 1.52 m wide recirculating flume. Two types of submerged vanes were tested in the present experiments: Type I vanes and Type II vanes. The Type I vanes were tested in the 2.4 m and 1.52 m wide flumes, while the Type II vanes were tested in the 1.52 m flume only. These two types of vanes are discriminated from each other by the values of  $L_v/H_v$ , which were less than unity (i.e. 0.175 to 0.7) in the case of Type I and greater than unity (i.e. 1.5 and 3) in the case of Type II. Iowa vanes are of Type II. The configurations tested are summarized in Tables 4.5 and 4.6.

**Table 4.5.** Submerged vane layouts for Type I vanes used during the present study.

Experimental Number	Vane Layout	Additional Parameters
Array 1		$L_v = 70 \text{ mm}$ $H_v = 200 \text{ mm}$ $\alpha_w = 15^\circ$ $T_v = 90 \text{ mm}$
Array 2		$L_v = 70 \text{ mm}$ $H_v = 200 \text{ mm}$ $\alpha_w = 15^\circ$ $T_v = 90 \text{ mm}$
Array 3		$L_v = 70 \text{ mm}$ $H_v = 200 \text{ mm}$ $\alpha_w = 15^\circ$ $T_v = 90 \text{ mm}$
Array 4		$L_v = 70 \text{ mm}$ $H_v = 125 \text{ mm}$ $\alpha_w = 15^\circ$ $T_v = 165 \text{ mm}$
Array 5		$L_v = 70 \text{ mm}$ $H_v = 200 \text{ mm}$ $\alpha_w = 25^\circ$ $T_v = 90 \text{ mm}$
Array 6		$L_v = 70 \text{ mm}$ $H_v = 200 \text{ mm}$ $\alpha_w = 15^\circ$ $T_v = 90 \text{ mm}$

Experimental Number	Vane Layout	Additional Parameters
Array 7		$L_v = 70 \text{ mm}$ $H_v = 200 \text{ mm}$ $\alpha_m = 15^\circ$ $T_v = 90 \text{ mm}$
Array 8		$L_v = 70 \text{ mm}$ $H_v = 200 \text{ mm}$ $\alpha_m = 15^\circ$ $T_v = 90 \text{ mm}$
Array 9		$L_v = 70 \text{ mm}$ $H_v = 100 \text{ mm}$ $\alpha_m = 15^\circ$ $T_v = 190 \text{ mm}$
Array 10		$L_v = 70 \text{ mm}$ $H_v = 200 \text{ mm}$ $\alpha_m = 35^\circ$ $T_v = 90 \text{ mm}$
Array 11		$L_v = 35 \text{ mm}$ $H_v = 200 \text{ mm}$ $\alpha_m = 15^\circ$ $T_v = 90 \text{ mm}$
Array 12		$L_v = 35 \text{ mm}$ $H_v = 200 \text{ mm}$ $\alpha_m = 35^\circ$ $T_v = 90 \text{ mm}$

Experimental Number	Vane Layout	Additional Parameters
Array 13		$L_v = 35 \text{ mm}$ $H_v = 200 \text{ mm}$ $\alpha_w = 35^\circ$ $T_v = 90 \text{ mm}$
Array 14		$L_v = 35 \text{ mm}$ $H_v = 200 \text{ mm}$ $\alpha_w = 35^\circ$ $T_v = 90 \text{ mm}$
LV1		$L_v = 70 \text{ mm}$ $H_v = 400 \text{ mm}$ $\alpha_w = 15^\circ$ $T_v = 200 \text{ mm}$
LV2		$L_v = 70 \text{ mm}$ $H_v = 400 \text{ mm}$ $\alpha_w = 35^\circ$ $T_v = 200 \text{ mm}$
LV3		$L_v = 70 \text{ mm}$ $H_v = 400 \text{ mm}$ $\alpha_w = 15^\circ$ $T_v = 200 \text{ mm}$
LV4		$L_v = 70 \text{ mm}$ $H_v = 400 \text{ mm}$ $\alpha_w = 35^\circ$ $T_v = 200 \text{ mm}$

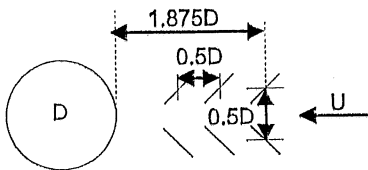
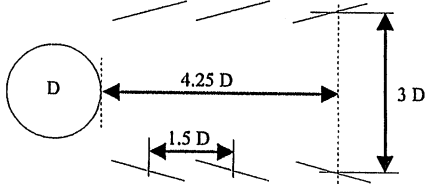
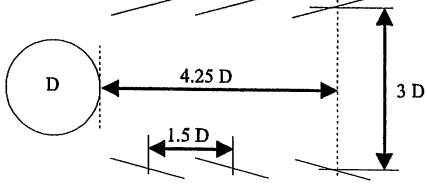
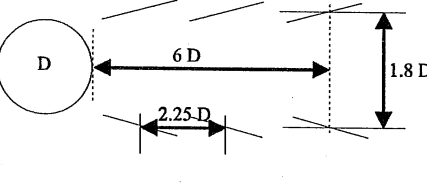
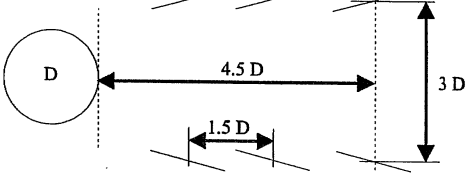
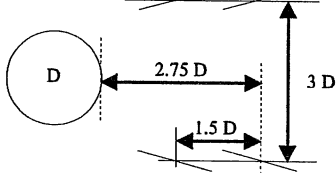
Experimental Number	Vane Layout	Additional Parameters
LV5		$L_v = 70 \text{ mm}$ $H_v = 400 \text{ mm}$ $\alpha_m = 35^\circ$ $T_v = 200 \text{ mm}$

Table 4.6. Submerged vane layouts for Type II vanes used during the present study.

Experimental Number	Vane Layout	Additional Parameters
LV6a and LV6b		$L_v = 300 \text{ mm}$ $H_v = 100 \text{ mm}$ $\alpha_w = 15^\circ$ $T_v = 500 \text{ mm}$
LV7		$L_v = 300 \text{ mm}$ $H_v = 200 \text{ mm}$ $\alpha_w = 15^\circ$ $T_v = 400 \text{ mm}$
LV8		$L_v = 300 \text{ mm}$ $H_v = 100 \text{ mm}$ $\alpha_w = 15^\circ$ $T_v = 500 \text{ mm}$
LV9		$L_v = 300 \text{ mm}$ $H_v = 200 \text{ mm}$ $\alpha_w = 15^\circ$ $T_v = 400 \text{ mm}$
LV10		$L_v = 300 \text{ mm}$ $H_v = 100 \text{ mm}$ $\alpha_w = 15^\circ$ $T_v = 500 \text{ mm}$

Experimental Number	Vane Layout	Additional Parameters
LV11a and LV11b		$L_v = 300 \text{ mm}$ $H_v = 100 \text{ mm}$ $\alpha_m = 30^\circ$ $T_v = 500 \text{ mm}$
LV12a and LV12b		$L_v = 300 \text{ mm}$ $H_v = 100 \text{ mm}$ $\alpha_m = 20^\circ$ $T_v = 500 \text{ mm}$
LV13		$L_v = 300 \text{ mm}$ $H_v = 100 \text{ mm}$ $\alpha_m = 15^\circ$ $T_v = 500 \text{ mm}$
LV14		$L_v = 300 \text{ mm}$ $H_v = 100 \text{ mm}$ $\alpha_m = 15^\circ$ $T_v = 500 \text{ mm}$

#### 4.5.2 Clear Water Experiments - Type I Vanes

##### Introduction

Clear water conditions were used to assess Type I vanes. The 2.4 m wide flume was employed for these experiments. A flow depth,  $y_0$ , was kept constant at a level of 0.29 m. The flow velocity near the threshold of motion for the bed sediment was used, with a shear velocity ratio of  $u_* / u_{*c} = 0.96$ . This corresponds to a velocity ratio of  $U / U_c = 0.85$ . The Type I vanes used for these clear water experiments had a length to height ratio,  $L_v / H_v$ , of 0.18 to 0.7. Here  $L_v$  denotes the length of the vanes in the horizontal direction and  $H_v$  denotes the vertical vane height measured from the average bed level. These parameters are defined in Figure 4.25.

In total fourteen clear water experiments were undertaken. The tests used vane arrangements based on the proposed design guidelines for Iowa vanes of Odgaard and Spoljaric (1986), Odgaard and

Wang (1987), Fukuoka (1989), and Odgaard and Wang (1991a, 1991b). The vane dimensions differed from these previous studies. The ratio of  $L_v/H_v$  was instead similar to that used by Hadfield (1997) in a study of sacrificial piles as a pier scour countermeasure.

The purpose of these experiments was to assess the importance of various vane parameters and to alter the arrangement to provide the optimum level of protection. Table 4.7 gives the arrangement parameters used in each experiment along with the scour reduction achieved after a 24 hour period. The experiments were performed for a standard 24 hours. It was shown through an initial unprotected pier experiment that 90 % of the equilibrium scour depth was achieved after 24 hours.

Measurements of scour depths were taken throughout the experiments. From this information it was possible to plot the time dependent evolution of the scour hole for the various vane arrangements and compare them to the unprotected pier scour development. A comparison of the scour depths over the first three hours is provided for experiments A1 to A10 in Figure 4.26. It can be seen in Figure 4.26 that the presence of vanes upstream of the pier in many cases slowed the rate of scouring at the pier face.

**Table 4.7:** Experimental setup and scour reduction achieved using submerged vanes under clear water conditions.

UNIVERSITY OF AUCKLAND												
Basic Data for low Vanes (Clear Water)												
Run	D (mm)	n <sub>s</sub>	T <sub>v</sub> (mm)	e <sub>v</sub> (mm)	X <sub>v</sub> (mm)	Z <sub>v</sub> (mm)	L <sub>v</sub> (mm)	H <sub>v</sub> (mm)	α <sub>v</sub> (deg)	α <sub>p</sub> (mm)	r <sub>s</sub> %	
No Vanes	-	-	-	-	-	-	-	-	-	-	239	-
Array 1	200	6	90	150	400	200	70	200	15	235	1.7	
Array 2	200	6	90	150	400	100	70	200	15	208	13.0	
Array 3	200	6	90	100	275	100	70	200	15	190	20.5	
Array 4	200	6	165	100	275	100	70	125	15	193	19.2	
Array 5	200	6	90	100	275	100	70	200	25	200	16.3	
Array 6	200	6	90	75	200	100	70	200	15	196	18.0	
Array 7	200	4	90	100	175	100	70	200	15	208	13.0	
Array 8	200	6	90	100	275	200/100/60	70	200	15	206	13.8	
Array 9	200	6	190	100	275	100	70	100	15	210	12.1	
Array 10	200	6	90	100	275	100	70	200	35	195	22.6	
Array 11	200	6	90	100	275	100	35	200	15	213	10.9	
Array 12	200	12	90	100	275	100/60	35	200	35	206	13.8	
Array 13	200	6	90	100	275	100	35	200	35	190	20.5	
Array 14	200	8	90	100	275	100	35	200	35	190	20.5	



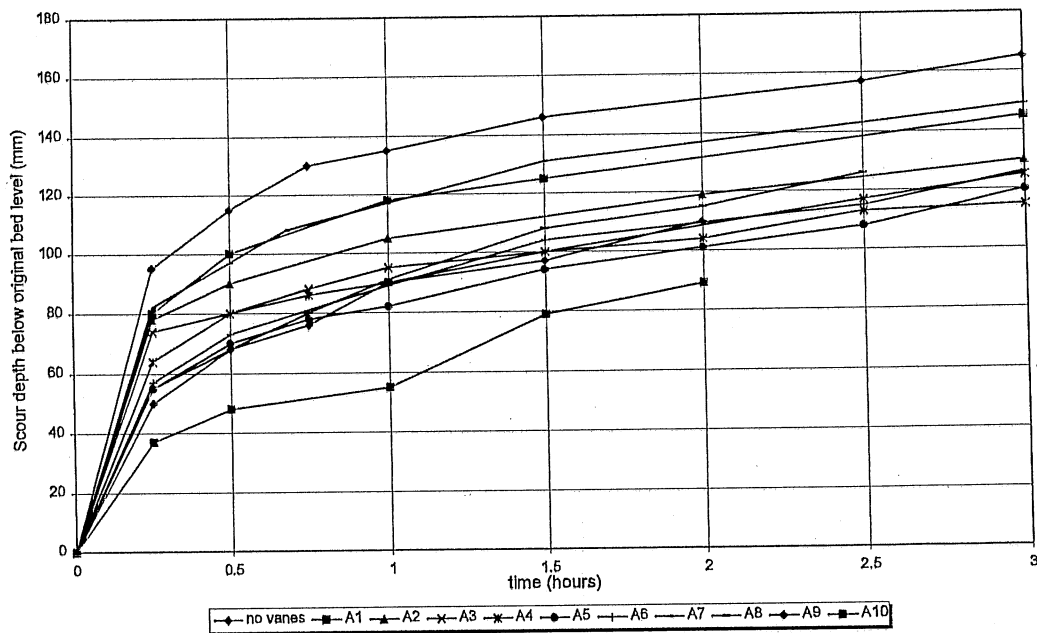


Figure 4.26. Progression of scour depth over time.

The slower evolution of the scour hole is due to the flow encountering the vanes before impinging on the pier itself. Some of the scour potential is used by the vanes as shallow scour regions develop around them. This reduces the flow energy at the pier and slows the rate of scouring. Despite the slower scour development, the scour depths after 24 hours were found to be nearly at equilibrium conditions, with depth increases of less than 1 to 2 mm over the final 3 to 4 hours of the test.

#### 4.5.2a Observations and the Effects of Vane and Layout Parameters

Vanes are placed in front of the pier to disrupt the vortex systems ahead of the pier and therefore reduce the scour depths experienced at the pier face. As the water encounters the vanes it is deflected inward. This spiraling action is opposite to the unprotected pier flow pattern, so that the two flow actions work against one another. This is also mirrored by the action of the sediment. Normally at an unprotected pier the sediment is removed from around the pier, but with the vanes placed upstream of the pier some material is moved into the scour region so as to form a bar down the center of the vane arrangement. As clear water conditions were employed in these tests, there was a net overall scour. Some material was moved downstream of the pier and not replaced. Around the vanes small scour holes formed, especially along the outside face. The presence of the vanes also elongates and widens the pier scour hole.

The vanes furthest from the pier experience the least local scouring; the scour hole is longer than that which would be formed by the pier alone. The net effect of these changes to the scour hole in most cases was a reduction in the depth of the scour hole at the upstream pier face.

#### Vane Spacing and Layout

The most important parameters were found to be the vane spacing across the flume combined with spacing upstream of the pier. It can be seen from Table 4.7 that when  $e_v = 0.5 D$  and  $z_v = 0.5 D$ , negligible scour reduction is observed. Then as both parameters are reduced protection increases. The effects of both  $e_v$  and  $z_v$  should, however, be considered together. When both are reduced too far, such as when the outlying vane lies less than  $1D$  from the pier face, protection ability begins to decrease. The most

successful combination was found to be  $e_v = 0.5 D$  and  $z_v = 0.5D$ , resulting in a scour reduction of 20.5 % to 22.6%.

Initially an arrangement using 6 vanes, three either side of the pier centerline, was chosen. This is similar to that used by Odgaard and Wang (1987) for Iowa vanes, except for the actual vanes spacing dimensions. Additional tests were done using 4, 8 and 12 vanes, corresponding to Arrays 7, 12 and 14 in Table 4.5, and for all these cases the scour reduction potential was reduced. From these results six vanes was determined to be the optimum array.

### ***Submergence Level of Vanes***

It is interesting to note that increasing the submergence of the vanes worked against their performance. When used in channel bends the vanes are recommended to be placed with a submergence (depth from the water surface to the top of the vane) of around  $0.6 y_0$ . However when used here the greater the submergence the less scour reduction effect was produced. This is most likely because the downflow starts near the surface and moves down the face of the pier from the water surface. In order to disrupt this pattern the vanes must be close enough to the surface to interact with the oncoming flow. It was decided that a submergence of around  $0.3 y_0$  is sufficient for the vanes to remain submerged and allow adequate flow interaction.

### ***Angle of Vanes to Approach Flow***

Altering the angle of the vanes to the approach flow was found have an impact scour reduction. The majority of tests were undertaken using  $\alpha_v = 15^\circ$ , as this was the optimum value recommended by Odgaard and Spoljaric (1986) for a situation similar to these experiments. Two other angles of  $25^\circ$  and  $35^\circ$  were also tested. The  $35^\circ$  angle decreased the scour depth by 2.1 % compared to the  $15^\circ$  arrangement using the  $L_v = 70$  mm vanes. For the smaller  $L_v = 35$  mm vanes the scour decreased by 9.6 % when the vane angle to the approach flow was increased from  $15^\circ$  to  $35^\circ$ . The greater the vane angle, the better was the ability of the vanes to interact with the oncoming flow. Increasing this angle, however, exposes the vanes to increased scouring themselves.

### ***Vane Length, $L_v$***

The final parameter tested was the length of the vanes. Initially the vanes had an  $L_v/H_v$  ratio of 0.35, and these dimensions were used for the majority of experiments. A number of tests were also performed for vanes with an  $L_v/H_v$  ratio of 0.18. Under the same flow conditions and arranged in the same layout and spacing, the vanes with the smaller ratio were not as effective in reducing local scour depths. This can be seen in Table 4.7 by comparing Array 3 and Array 11, where scour reductions of 20.5 % and 10.9 % were experienced respectively. When the vane angle to the flow was increased for the vanes with a smaller ratio  $L_v/H_v$ , Array 13, a scour reduction of 20.5 % was measured. From the vane angle experiments reported earlier in this section it was found that the greater the angle the better the vane performance, as this increased the effective width of the vanes. The advantage of increasing the effective width of the vane is clearly illustrated by these results.

### **4.5.3 Mobile Bed Experiments - Type I Vanes**

It was decided to retest some of the previous vane arrangements under live bed conditions in the 1.5 m wide flume to determine if any further scour reduction potential exist and confirm the scour reduction previously experienced. The pier used had a diameter of 200 mm. Vane dimensions were  $H_v = 400$  mm,  $L_v = 70$  mm. Table 4.6 outlines the various vane parameters; the scour reduction observed at the pier face is given in Table 4.8. Type I vanes were used in experiments LV1 to LV5. Experiments LV6 to LV14 were performed using the Type II vanes. As with the previous clear water condition experiments, the live bed experiments were performed over a 24 hour period. The scour depth at the pier face was continuously recorded and from the results the maximum and average scour levels calculated.

Observations indicated that the short length of the vanes made them ineffective in redistributing flow and sediment. They were unable to direct sufficient sediment towards the pier to reduce the scour depths significantly. In some cases they exacerbated the scour depth. When the maximum scour depths with and without the vanes are compared only LV3 and LV5 reduced the scour level. Scour reductions of 8.9 % and 6.8 % were achieved respectively. The results appear more promising when average scour depths are compared. Using these data all the Type I vane arrangements reduced the local scour level between 10% to 28 %.

Improvements in the performance of the vanes were noted when the horizontal vane spacing,  $z_v$ , was reduced from 200 mm to 100 mm, and also by increasing the spacing between the pier and the closest of the vanes. The vane angle of attack to the approach flow  $\alpha_v$  was varied between 15° and 35°, but very little difference in scour levels was seen.

In general the Type I vanes did not provide scour protection. They were unable to divert large quantities of sediment into the scour region in order to reduce the local scour levels. Any scour reduction that was achieved was due to the vanes disrupting the flow system ahead of the pier. As with sacrificial piles, this disruption reduced the strength of the downflow at the pier face.

**Table 4.8.** Vane Parameters and Scour Reduction Achieved Under Mobile Bed Conditions Using Type I and II vanes.

UNIVERSITY OF AUCKLAND													
Basic Data for Iowa Vanes (Live Bed)													
Run	D (mm)	$n_v$	$T_v$ (mm)	$a_v$ (mm)	$X_v$ (mm)	$z_v$ (mm)	$L_v$ (mm)	H <sub>v</sub> (mm)	$\alpha_v$ (deg)	$d_s$ (mm)	r, %	$d_{s,ave}$ (mm)	Scour %
NR2	200	-	-	-	-	-	-	-	-	273	-	-	-
NR3	200	-	-	-	-	-	-	-	-	309	-	-	-
LV1	200	6	200	100	275	200	70	400	15	293	-7.1	209	23.4
LV2	200	6	200	100	275	200	70	400	35	293	-7.0	246	10.1
LV3	200	6	200	100	275	100	70	400	15	249	8.9	216	20.9
LV4	200	6	200	100	275	100	70	400	35	284	-3.8	239	12.5
LV5	200	6	200	100	375	100	70	400	35	255	6.8	196	28.2
LV6a	200	6	500	300	850	600	300	100	15	236	13.8	177	35.4
LV6b	200	6	400	300	850	600	300	100	15	304	1.7	209	32.5
LV7	200	6	400	300	850	600	300	200	15	243	11.2	180	34.3
LV8	200	6	500	450	1200	360	300	100	15	240	12.3	169	38.2
LV9	200	6	400	300	900	600	300	200	15	247	9.8	178	34.7
LV10	200	4	500	300	550	600	300	100	15	258	5.7	181	33.6
LV11a	200	6	500	300	850	600	300	100	30	179	34.4	136	50.4
LV11b	200	6	500	300	850	600	300	100	30	294	4.9	195	36.9
LV12a	200	6	500	300	850	600	300	100	20	222	18.7	155	43.2
LV12b	200	6	500	300	850	600	300	100	20	293	5.3	216	30.2
LV13	200	6	500	400	1050	600	300	100	15	207	24.3	140	48.7
LV14	200	6	500	300	850	800	300	100	15	229	16.2	187	31.5

#### **4.5.4 Mobile Bed Experiments - Type II Vanes**

##### ***Introduction***

Submerged vanes such as those detailed by Odgaard and Wang (1987 and 1991a) generally have length to height ratios  $L_v/H_v$  greater than 1 and are often referred to as Iowa vanes. With this in mind, the Type II vanes of this study had a  $L_v/H_v$  ratio of 1.5 and 3. A value of this ratio  $L_v/H_v$  of 3 was used in the majority of experiments in the study of Type II vanes, as seen in Table 4.8. The experiments were conducted in the 1.52 m wide flume.

The Type II vanes differ from the Type I vanes in their  $L_v/H_v$  ratio. With the Type II vanes it was found that the increased streamwise dimension significantly altered the interaction of the vanes with the flow and the sediment bed. These vanes were able to redistribute sediment into the center of the channel and to some degree "fill in" the local scour hole. The vertical height did not allow the vanes to interact with the scouring mechanism and they did not disrupt the downflow or horseshoe vortex system.

The scour reduction achieved by the various Type II vane arrangements are given in Table 4.8 as experiments LV6a to LV14.

##### ***Scour Reduction***

Local scour levels were recorded continuously over a 24 hour period at the upstream pier face. The scour was measured as the depth of the sediment hole from the average bed level. This was compared to the values obtained for the same pier without any protection measure installed. Experiments LV6a to LV10 were performed initially to assess if any scour reduction may be achieved using Type II submerged vanes. From the results, experiment LV6a was found to provide the most scour reduction, at 13.8 %. It was then retested at a higher velocity, experiment LV6b, where the maximum scour depth protection achieved at the lower flow velocity was found to be negated. Only 1.7 % scour reduction was achieved for  $U/U_c = 1.84$ . Comparison of the average scour reduction provides a different picture with 35.3 % and 32.5 % scour reduction achieved for  $U/U_c = 1.48$  and 1.84 respectively.

Experiments LV11 to LV14 used variations of arrangement LV6 to assess the importance of vane angle and spacing parameters based on the basic LV6a layout. The maximum scour reduction was achieved in experiment LV11a, where the maximum scour was reduced by 34.4 % and the average scour by 50.4 % at  $U/U_c = 1.48$ . This result is better than that shown by Odgaard and Wang (1987) whose vane arrangement produced a reduction in maximum scour levels of 36 %.

Observation of the bedform migration past the pier during the tests showed that as the bed forms encountered the vanes they developed a lag. Sand was held up between the vanes while the rest of the bedform continued to migrate past the pier. Some of the bed material held up between the vanes formed a bar-like region; most of the sediment, however, continued to move downstream but at a slower rate than the rest of the dune.

##### ***Parameter Influences***

The purpose of the experiments detailed in this section was to assess the effectiveness of Type II submerged vanes to protect against local scour. Various parameters such as vane submergence, layout, vane spacing and angle to the approach flow were investigated. From the results it is possible to determine the relative importance of these parameters. Only a small number of experiments was performed for each vane arrangement. Further testing would be required to ascertain the optimum vane arrangement and dimensions.

##### ***Vane Submergence***

Vane submergence,  $T_v$ , is the distance from the top surface of the vane to the average water surface level. The vanes of Type I were positioned close to the water surface. However in the Type II experiments the vanes were positioned close to the sediment bed. Vanes that are submerged at deeper

levels have advantages in prototype situations because the probability of debris rafting and navigational hazards are reduced.

Experiments LV6a and LV7 can be used to illustrate the effect of altering the level of submergence. In Table 4.8 it can be seen that LV6a has a submergence of 500 mm, while LV7 has a submergence level of 400 mm. Comparing maximum scour reduction for the two experiments, values of 13.8 % and 11.2 % were achieved respectively. This indicates that the shorter the vanes the more effective they are in reducing local scour depths. This result is opposite to that achieved using Type I vanes, and supports the idea that the two vane types involve different mechanisms to reduce scour depths. It was decided that the LV6a submergence level of 500 mm would be used for further experiments where possible.

#### *Arrangement and Number of Vanes*

A previous study by Odgaard and Wang (1987) was used as the basis of the vane layouts tested in this present study. LV6a is considered the basic layout.

In LV10 the number of vanes was reduced from 6 to 4 with all other vane and layout dimensions remaining the same as LV6a. The result of reducing the number of vanes was a decrease in maximum scour protection from 13.8 % with 6 vanes to 5.7 % with 4 vanes. The average scour reduction values were approximately the same for both of these arrangements. Due to limitations in the size of the sediment recess it was not possible to utilize more than 6 vanes. Therefore 6 was considered the minimum number to provide adequate scour protection.

Experiments LV8 and LV9 were variations of LV6a. The performance of the vanes was not improved by these two layouts.

#### *Vane Angle to the Approach Flow*

In the present study, angles  $\alpha_v$  of 15°, 20°, and 30° were tested at both  $U/U_c = 1.48$  and 1.84. A summary of the resulting scour reduction is provided in Table 4.9. For all the experiments listed in Table 4.9 layout parameters remained the same;  $T_v = 500$  mm,  $e_v = 300$  mm,  $X_v = 850$  mm,  $z_v = 600$  mm,  $L_v = 300$  mm,  $H_v = 100$  mm. Previous submerged vane experiments have recommended the following range of vane angles.

- Odgaard and Wang (1987) 15° - 20°
- Fukuoka (1989) 20°
- Odgaard and Wang (1991a) 15° - 25°

It is from these recommended values that the test angles used in the present study were chosen.

Table 4.9 shows that as the vane angle increases so too does the scour reduction achieved. At an angle of 30° the maximum scour reduction is 34.3 % and the average scour reduction increases to 50.4 %. This indicates a significant improvement in scour protection ability.

**Table 4.9.** Summary of Scour Reduction Achieved Using Different Vane Angles.

Exp. No.	Vane angle to approach flow, $\alpha_v$	$D/H_v$	Maximum scour reduction $r_s$ (%)	Average scour reduction $r_{ave}$ (%)
LV6a	15	1.48	13.8	35.4
LV6b	15	1.84	1.7	32.5
LV11a	30	1.48	34.4	50.4
LV11b	30	1.84	4.9	36.9
LV12a	20	1.48	18.7	43.2
LV12b	20	1.84	5.7	30.2

**Vane Spacing -  $e_v$ , and  $z_v$ ,**

Experiments LV13 and LV14 were undertaken using variations of LV6a in order to determine the individual importance of the parameters  $e_v$  and  $z_v$ . Table 4.8 summarizes the resulting scour reduction. It can be seen that increasing the streamwise spacing,  $e_v$ , significantly improves vane performance. The maximum scour depth was reduced by twice as much as for the LV6a arrangement, giving an average scour reduction of 48.7%, almost the same as that achieved using vanes angled at 30°. Increasing the lateral dimension only increases the maximum scour reduction by 3 % and the average scour reduction was actually decreased from that achieved in LV6a. From this information it would appear that the streamwise dimension,  $e_v$ , is the more significant parameter.

**Table 4.10.** Relative Importance of Vane Arrangement Parameters.

Parameter	Parameter Value (mm)	% Maximum Scour Reduction $r_s$	% Average Scour Reduction $r_{ave}$
$e_v$	300	13.8	35.4
	400	24.3	48.7
$z_v$	300	13.8	35.4
	400	16.2	31.5

**4.5.5 Conclusions**

Experiments to protect bridge piers against local scouring using submerged vanes have previously been undertaken only by Odgaard and Wang (1987), who conducted a small number of experiments only. This present study was undertaken to expand on this idea and assess the possible usefulness of submerged vanes as a scour countermeasure at bridge piers. Both clear water and mobile bed conditions were used to test two different types of vanes. Type I vanes were characterized by an  $L_v/H_v$  ratio of less than 1 whereas Type II vanes (similar to Iowa vanes) used a  $L_v/H_v$  ratio of greater than 1.

It was found that the two vane types acted in different ways to reduce local scouring. Type I vanes performed similar to sacrificial piles (Hadfield, 1997) whereby they act to disrupt the flow system ahead of the pier and reduce the strength of the downflow and horseshoe vortex systems at and around the pier. Under clear water conditions the Type I vanes proved modestly effective in reducing the scouring potential of the flow with to 22.6 % scour reduction achieved by various arrangements of vanes. When these vanes were introduced to a mobile bed environment, different results were observed. In only two tests was any reduction of the maximum scour depth achieved. In the other experiments the maximum scour depths were actually increased by the presence of the vanes. However when the average scour depth was used for comparison, the Type I vanes reduced average scour depths by between 10.1 % to 28.2 %.

The second type of submerged vanes tested, Type II vanes, interacted with the sediment bed rather than the approach flow to reduce local scour depths. These vanes were only tested under live bed conditions. The arrangement used in LV11a was most successful, with a maximum scour reduction of 34.4

% and an average scour reduction of 50.4 %. The most important parameters affecting vane performance were determined to be the vane angle to the approach flow  $\alpha_v$  and the streamwise spacing between the vanes  $e_v$ . Increasing the vane angle from 15° to 30° increased the effective width of the vane. Increasing the spacing allowed a greater funneling effect of the sediment.

The results presented in the present study indicate that there is some scour protection potential for submerged vanes placed near bridge piers. The Type II vanes tested are similar in dimension to the Iowa vanes used in channel protection today; they offer greater potential for scour protection than the Type I vanes. The effect of changes in the angle of attack of the flow has not been address here. This notwithstanding, in no circumstances do submerged vanes appear to provide more than 50% of scour protection. In the context of this study, this performance is at most marginal, and generally unacceptable. Vanes are, however, the only flow altering countermeasure to show enough promise to warrant further study.

## 5. EXPERIMENTAL INVESTIGATIONS AT NANYANG TECHNOLOGICAL UNIVERSITY

### 5.1 INTRODUCTION

The work described in this chapter was neither funded by nor conducted under the auspices of NCHRP Project 24-7. It constitutes research conducted by a graduate student at Nanyang Technological University, Singapore under the supervision of an individual who also happens to be a principal investigator of NCHRP Project 24,7, Yee-Meng Chiew. The research, however, is of such direct relevance to NCHRP Project 24-7 that a short chapter is devoted to a description of the salient results.

The experiments focus on the stability of riprap placed around a bridge pier under mobile-bed conditions with a bed covered by prominent dunes. No geotextile was used, nor was any other means used to add stability to the riprap. The central conclusion of the study is as follows. A fairly standard placement of riprap around a bridge pier can nevertheless settle due to the passage of bedforms. The maximum depth of settling of the riprap in the vicinity of the bridge pier can be as much as the depth of the scour hole that would have formed in the absence of protection. The implication is as follows. In sand-bed streams at flood conditions the passage of bedforms can over time embed the riprap so deeply that it provides considerably reduced or no protection against the scour that would have occurred in its absence.

It is of value to note that among the three university experimental groups involved with NCHRP 24-7, Nanyang Technological University (although in a capacity that was independent of 24-7) was first to experimentally demonstrate the tendency for riprap to settle in response to the passage of dunes. This result was later confirmed by tests at the University of Auckland and St. Anthony Falls Laboratory, as outlined in previous chapters. This result proved influential to the design of experiments at other facilities, with the University of Auckland exploring varied riprap thickness and depth of burial as a means of increasing riprap stability, and St. Anthony Falls Laboratory exploring the use of geotextiles to suppress the leaching effect that plays an integral role in riprap settling.

The research summarized here is described in more detail in the manuscript by Lim and Chiew (1998a). More details can also be found in Lim and Chiew (1996, 1997, 1998b). In his capacity as a principal investigator on NCHRP 24-7, Yee-Meng Chiew served as an advisor to the experiments conducted at the University of Auckland and St. Anthony Falls Laboratory, a role that allowed for efficient exchange of ideas and development of research plans.

### 5.2 EXPERIMENTAL FACILITIES AND SETUP

The experiments were conducted in a glass-sided sediment recirculating flume with a length of 14 m, a width of 0.6 m and a depth of 0.6 m. Experiments were performed with two relatively uniform bed sediments, one with the value  $d_{50} = 0.26$  mm and the other with a value  $d_{50} = 1.01$  mm. The critical shear velocity  $u_{*c}$  for the bed sediment and  $u_{*rc}$  for the riprap, as well as the critical flow velocity  $U_c$  for the bed sediments were computed using the same relations as those employed in the experiments at the University of Auckland and St. Anthony Falls Laboratory, i.e. Eqs. (3.4) and (3.5). Three essentially uniform sediments were used as riprap, with median size  $D_{r50}$  taking the values 5.80, 9.12 and 71.6 mm. The size distributions of the bed sediment and riprap are shown in Figure 5.1, and are given in tabular form in Tables 5.1a and 5.1b.



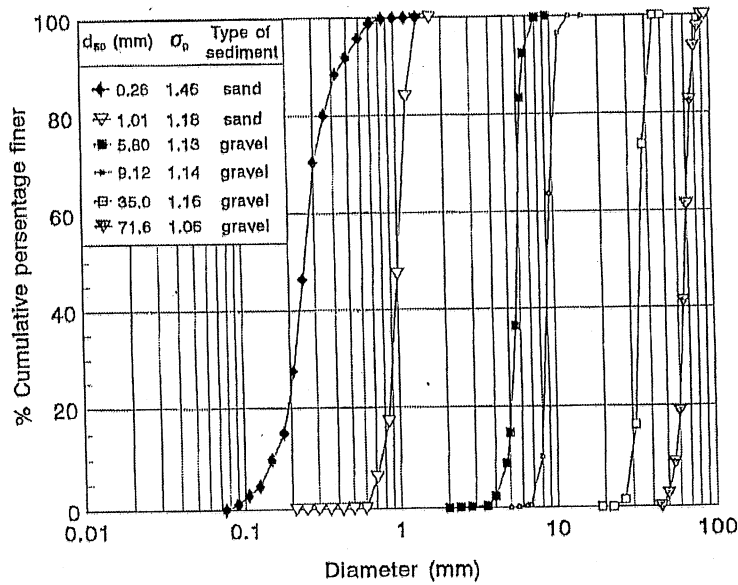


Figure 5.1. Size distributions of the sediment and riprap used in the experiments.

Table 5.1a. Characteristics of the bed sediment

$d_{50}$ (mm)	$\rho_s$ (kg/m <sup>3</sup> )	$\sigma_g$	$u_{*c}$ (m/s)
0.26	2650	1.46	0.0127
1.01	2650	1.18	0.0239

Table 5.1b. Characteristics of the riprap

$d_{r50}$ (mm)	$\rho_r$ (kg/m <sup>3</sup> )	$\sigma_g$	$u_{*rc}$ (m/s)
5.80	2650	1.13	0.0705
9.12	2650	1.14	0.0901
71.6	2670	1.06	0.254

The bridge piers used in the experiments were constructed from clear Perspex tubing and had diameters  $D$  equal to 25, 38 and 70 mm. The initial installation of the riprap was as follows. The riprap cover  $c$  was  $4D$ , so that the riprap extended a distance of  $1.5 D$  out from the face of the pier. The thickness  $t$  of the riprap took the values  $2 D_{r50}$ ,  $4 D_{r50}$  and  $12 D_{r50}$ . The riprap was always installed after excavation so that the top of the riprap was flush with the bed. In comparing with the experiments of St. Anthony Falls Laboratory, this configuration corresponds closely to those of series TF-RR1, TF-RR2, MC-RNG and TF-RNG. In comparing to the experiments at the University of Auckland, the experiments correspond to the condition  $Y = 0$  (top of riprap flush with the bed).

Four mean depths of approach flow were studied;  $y_0 = 70, 80, 210$  and  $250$  mm. Values of velocity  $U_{rc}$  at which the riprap is expected to fail were computed using Eqs. (3.7a) and (3.7b); in the latter case  $K$  was set equal to 1.5 to reflect the fact that the piers were circular.

A total of 69 experiments were conducted in 10 series. Series A1 – A7 were performed using the 0.26 mm sand as bed sediment, and series B1 – B3 were performed using the 1.01 mm sand as bed sediment. The complete set of data is given in **Appendix A**. Each experiment had a duration  $T_d$  of 12 to 36 hours.

The experimental setup of each series is summarized in Table 5.2 below. The cover parameter  $c/D$  is equal to 4 in all the experiments except one; this corresponds to the most commonly used value in the experiments at the University of Auckland and the University of Minnesota. The riprap thickness parameter  $t/D_{r50}$  is equal to 2 in all cases but one, again in agreement with the most commonly used value at the other two institutions. In two cases, however,  $t/D_{r50}$  is set equal to 12, corresponding to an exceptionally thick layer of riprap. Also listed in the table are the scour depths  $d_{s0}$  measured in the absence of any countermeasure. Values of  $u_{*c}$  and  $U_c$  are listed for each series in Table 5.3.

**Table 5.2.** Summary of data pertaining to experimental setup

Summary of Data							
Series	$d_{50}$ (mm)	$D_{r50}$ (mm)	$D$ (mm)	$c/D$	$t/D_{r50}$	$y_o$ (m)	$d_{s0}$ (m)
A1	0.26	9.12	70	4	2	250	0.188
A2	0.26	5.80	25	4	2	250	0.097
A3	0.26	9.12	70	4	12	250	0.187
A4	0.26	9.12	25	4	2	250	0.097
A5	0.26	9.12	70	4	2	80	0.115
A6	0.26	9.12	70	4	12	70	0.108
A7	0.26	9.12	70	4	4	210	0.180
B1	1.01	71.60	70	4	2	210	0.181
B2	1.01	71.60	38	7	2	210	0.115
B3	1.01	71.60	38	4	2	210	0.182

Of particular relevance to these experiments are the predicted velocities of failure of the riprap  $U_{rc}$  by direct entrainment into the flow. These are given in Table 5.4

**Table 5.3.** Values of  $u_{*c}$  and  $U_c$  for the experiments

Critical parameters for sediment motion				
$D_{50}$ (mm)	$u_{*c}$ (m/s)	$y_o$ (m)	$U_c$ (m/s)	Series
0.26	0.0127	0.25	0.272	A1, A2, A3, A4
0.26	0.0127	0.08	0.236	A5
0.26	0.0127	0.07	0.232	A6
0.26	0.0127	0.21	0.267	A7
1.01	0.0239	0.21	0.421	B1,B2,B3

Table 5.4. Values of  $U_{rc}$  for the experiments.

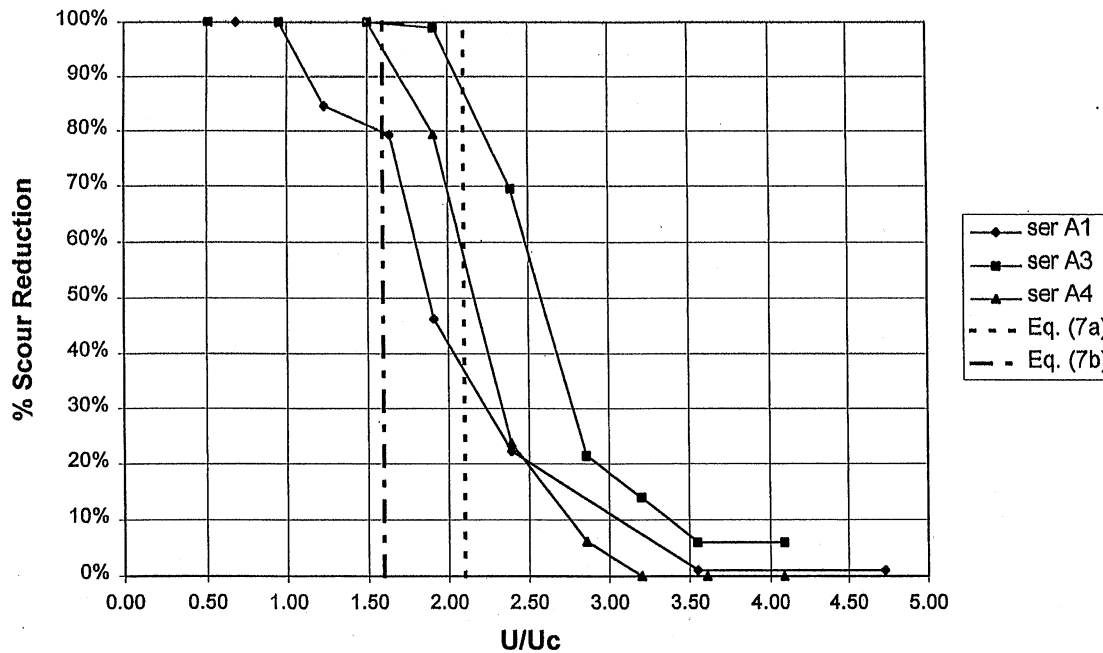
Velocities for Riprap Failure							
$D_{r50}$ (mm)	$y_o$ (m)	$\rho_r$ (kg/m <sup>3</sup> )	$U_{rc}$ (m/s)	$U_{rc}$ (m/s)	$U_{rc}/U_o$	$U_{rc}/U_o$	Series
			Eq. (3.7a)	Eq. (3.7b)	Eq. (3.7a)	Eq. (3.7b)	
9.12	0.25	2650	0.571	0.434	2.099	1.594	A1, A3, A4
5.8	0.25	2650	0.477	0.346	1.751	1.271	A2
9.12	0.08	2650	0.510	0.434	2.160	1.839	A5
9.12	0.07	2650	0.503	0.434	2.170	1.872	A6
9.12	0.21	2650	0.561	0.434	2.105	1.627	A7
71.6	0.21	2670	1.288	1.223	3.061	2.907	B1, B2, B3

### 5.3 EXPERIMENTS ON RIPRAP

The experiments were performed by gradually increasing the flow velocity step by step from clear water conditions to strongly mobile bed conditions and observing the performance of the riprap layer. All the experiments were characterized by a progression of bedform development, with a flat bed under clear water conditions, then ripples, dunes and transition to upper regime flat bed as flow velocity increased. Well developed dunes with dune heights  $\Delta$  on the order of 30 – 40% of the depth of flow were typically observed within the range of velocities for dune formation.

Results concerning scour depths are best presented in the groups of Table 5.4, as the experiments within each grouping have common values of  $U_{rc}/U_o$ . These are presented in Figures 5.2 – 5.7 below, in which the percent scour reduction  $r_s$  is given as a function of  $U/U_o$ . Also given in each of these figures is the value of  $U_{rc}/U_o$  associated with riprap failure from Eqs. (3.7a) and (3.7b).

### Riprap Performance, Series A1, A2, A4



**Figure 5.2.** Riprap performance for series A1, A3 and A4. The vertical lines denote values of  $U_{cr}/U_c$  from Eqs. (3.7a) and (3.7b).

It can be seen from Figure 5.2 that in every case the riprap settles to a point at which it offers virtually no scour protection at sufficiently high values of  $U/U_c$ . It is of value to compare the results for series A1 and A3. These two series differ only in that  $t/D_{r50}$  takes the value 2 in the former case and 12 in the latter case. Evidently even an extremely thick layer of riprap is subject to settling. The thicker layer is, however, somewhat less prone to settling than the layer of standard thickness.

Figure 5.2 indicates that the riprap settles to a point where it offers virtually no protection at all only after the critical condition for entrainment of the riprap is well exceeded. It should be pointed out, however, that in the presence of prominent dunes the riprap did not disintegrate catastrophically by flow entrainment, but instead settled and dispersed. Using Eq. (3.7b) as a criterion, however, the riprap of series A1 and A4, which was placed at the standard thickness  $t/D_{r50} = 2$ , was already offering only marginal or unacceptable protection at the point where the riprap was mobilized. This result is in agreement with the conclusions of St. Anthony Falls Laboratory and the University of Auckland; in the absence of a geotextile, riprap of thickness  $t/D_{r50} = 2$  can settle significantly, without losing complete protection, even if the riprap is never mobilized by the flow. The result that the settling is substantially arrested by a thick layer of riprap under conditions for which the riprap is never entrained also agrees with the results of the University of Auckland. Similar results are shown for series A2, A5, A6 and A7 in Figures 5.3, 5.4, 5.5 and 5.6, respectively. The results for series A6 are of interest because they pertain to a value of  $t/D_{r50}$  of 12. In this case virtually no settling is observed until the velocity is high enough to entrain the riprap.

Riprap Performance, Series A2

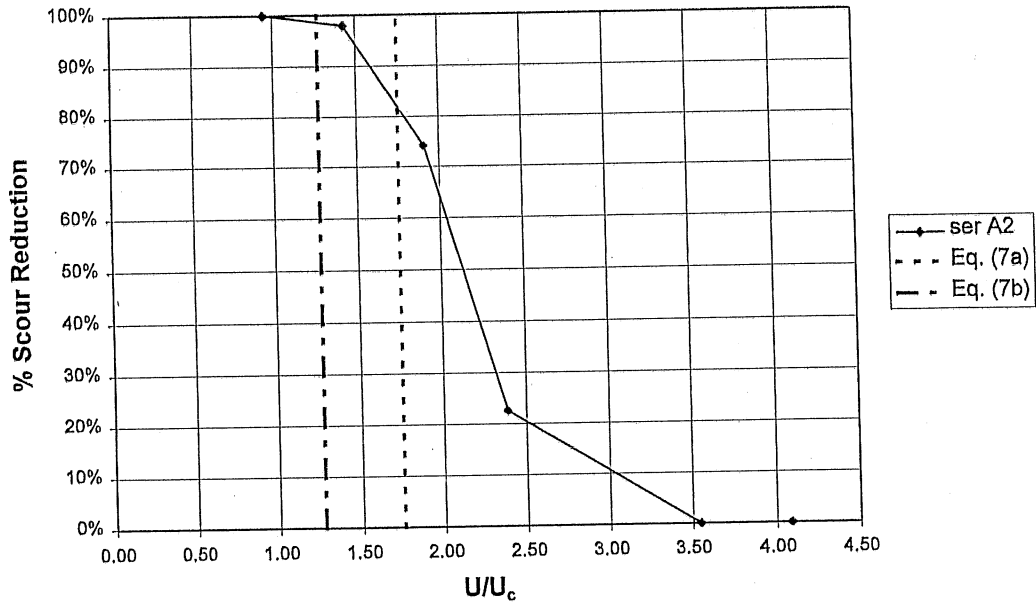


Figure 5.3. Riprap performance for series A2. The vertical lines denote values of  $U_{rc}/U_c$  from Eqs. (3.7a) and (3.7b).

Riprap Performance, Series A5

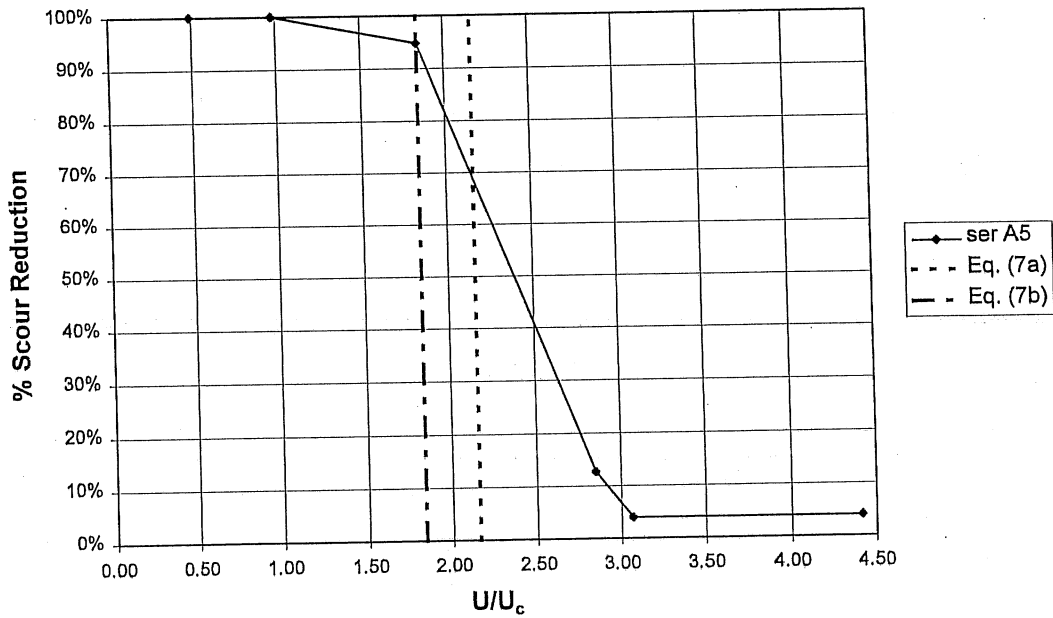
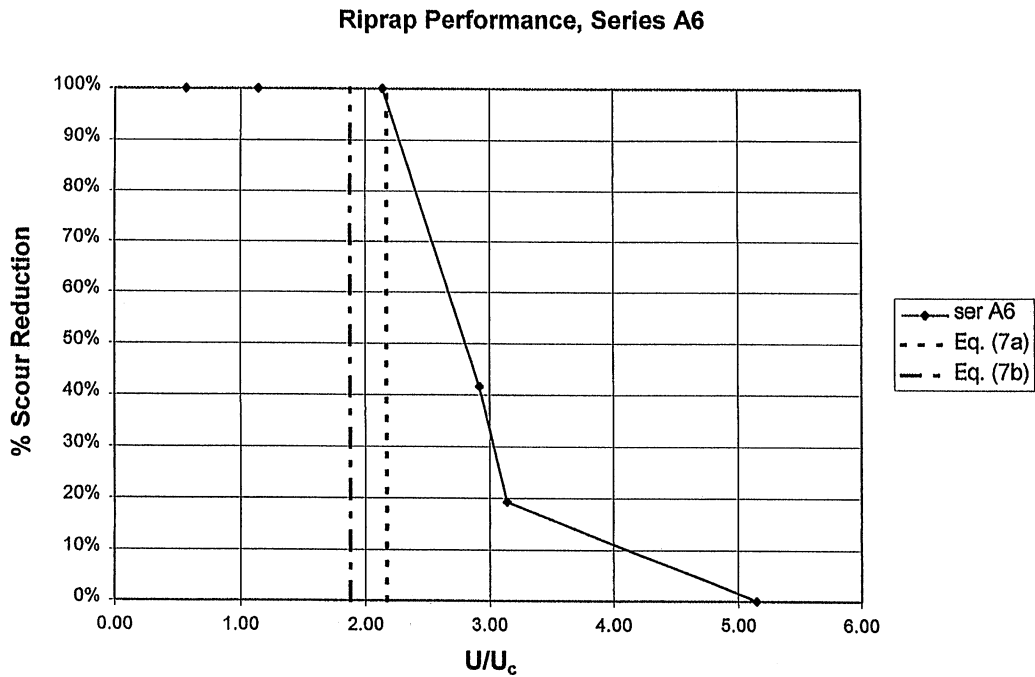
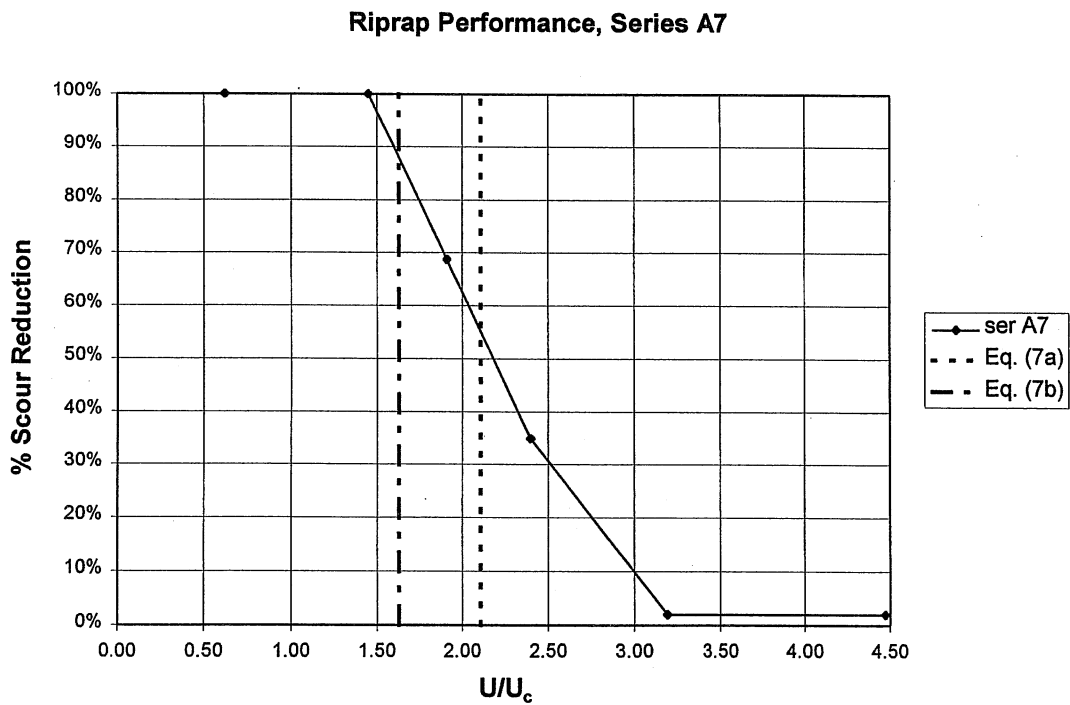


Figure 5.4. Riprap performance for series A5. The vertical lines denote values of  $U_{rc}/U_c$  from Eqs. (3.7a) and (3.7b).

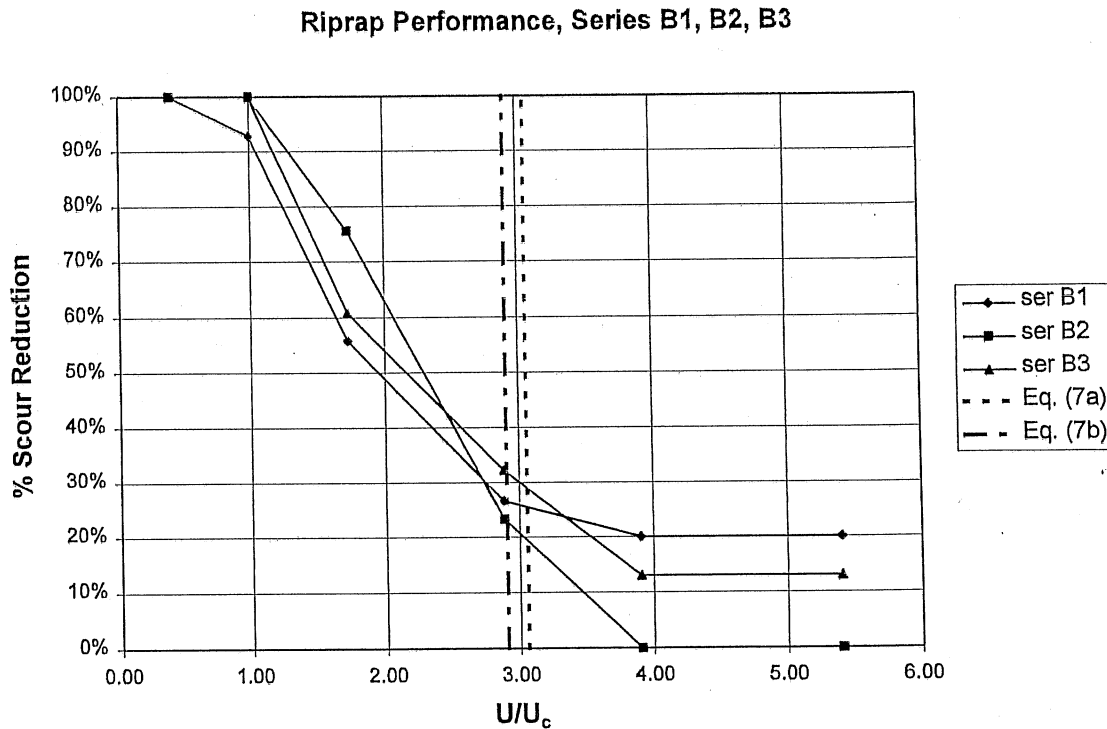


**Figure 5.5.** Riprap performance for series A6. The vertical lines denote values of  $U_r/U_c$  from Eqs. (3.7a) and (3.7b).



**Figure 5.6.** Riprap performance for series A7. The vertical lines denote values of  $U_r/U_c$  from Eqs. (3.7a) and (3.7b).

Figure 5.7 shows the results for series B1, B2 and B3, which correspond to the coarsest grade of riprap tested. In series B1 and B3 the cover ratio  $c/D$  is 4; in series B2 the pier size has been reduced and the cover ratio increased to 7. Increased cover is seen to affect the settling process very little. At the highest values of  $U/U_c$  the riprap offered virtually no scour protection. In all three cases the scour protection was well into the unacceptable range, i.e. near 20% to 30% by the time the critical condition for the entrainment of the riprap was reached.



**Figure 5.7.** Riprap performance for series B1, B2 and B3. The vertical lines denote values of  $U_{tr}/U_c$  from Eqs. (3.7a) and (3.7b).

In summary, the experiments of Lim and Chiew (1998a) offer a vivid and convincing illustration of the tendency of riprap to settle and disperse under mobile bed conditions and in the presence of well developed bedforms. The experiments show that significant settling can occur even when the riprap is never directly entrained by the flow. Settling can, however be arrested by using an extremely thick layer of riprap under such conditions. At velocities high enough to entrain the riprap, it eventually settles to the point at which it offers no protection at all regardless of thickness of placement. In the presence of bedforms, however, the riprap does not ravel catastrophically at flow velocities high enough to mobilize it, but simply migrates more efficiently to the troughs of dunes and settles more rapidly. The research outlines the consequences of failure to use a geotextile or a granular filter in conjunction with riprap in order to prevent settling.

## 6. SUMMARY OF THE EXPERIMENTAL RESULTS

### 6.1 OVERVIEW OF CHAPTER

The text below summarizes the most important findings of the experimental studies. The importance of a geotextile filter or a granular filter layer is stressed for the implementation of armoring countermeasures on sand bed streams. A summary of results of the experiments is provided for each countermeasure tested.

### 6.2 NOTES CONCERNING THE USE OF A GEOTEXTILE FILTER OR GRANULAR FILTER LAYER

The most effective countermeasures enumerated below were found to function best when underlain by a geotextile filter. In order to understand the role of the geotextile filter, it is necessary to consider river type.

Alluvial rivers with beds that are free to scour and fill during floods can broadly be divided into two types: sand bed streams and gravel bed streams. Sand bed streams typically have values of median bed sediment  $d_{50}$  varying between 0.1 mm and 1 mm. The sediment tends to be relatively well sorted, with values of geometric standard deviation of the bed sediment  $\sigma_g$  varying from 1.1 to 1.5. Sand bed streams usually contain only relatively small amounts of gravel, except where an essentially immobile gravel lag has accumulated. Gravel bed streams typically have values of median size of the bed sediment exposed on the surface  $d_{50}$  of 15 mm to 200 mm or larger; the substrate is typically finer by a factor of 1.5 to 3. The geometric standard deviation of the substrate  $\sigma_g$  is usually quite large, with values in excess of 3 being common. Although gravel and coarser material constitute the dominant sizes, there is usually a substantial amount of sand (10% to 30% of sediment by weight) stored in the interstices of the gravel substrate.

Two dimensionless parameters provide an effective delineator of rivers into the above two types. The first of these is the Shields stress  $\tau^*$  defined in Eq. (3.2a); in that relation  $d_{50}$  should be interpreted as a median size of the bed material exposed on the surface in the case of gravel bed streams. The second of these is a particle Reynolds number  $Re_p$  defined in Eq. (3.5b), which can be considered to be a dimensionless surrogate for grain size.

Figure 6.1 shows a plot of the values of  $\tau^*$  evaluated at bankfull flow versus  $Re_p$  for five sets of field rivers: a) gravel bed rivers in Wales, U. K. (Wales); b) gravel bed rivers in Alberta, Canada (Alberta); c) gravel bed rivers from the Pacific Northwest, U.S.A. (Pacific NW); d) single-thread sand bed streams (Sand sing); and e) multiple-thread sand-bed streams (Sand mult). Bankfull discharge is chosen as typical of flood flows; in many streams it corresponds to a flood with a return frequency of 1 to 6 years. Also shown in the diagram are lines corresponding to f) the threshold condition for the onset of motion of the median size  $d_{50}$  of the bed material, g) the threshold condition for significant suspension of the median size  $d_{50}$  of the bed material and h) the borderline between the region for ripple formation and the region in which only dunes and antidunes form.

It can be seen from Figure 6.1 that sand bed rivers plot in a very different place from gravel bed rivers. In the case of gravel bed rivers Shields stress  $\tau^*$  at bankfull conditions tends to be low, with typical values that are less than twice the Shields stress for the onset of motion of the  $d_{50}$  size of the surface material. Dunes are often (but not always) poorly developed even at flood flows, with the dominant bedform being bars. Sand bed streams tend to be quite different. Shields stresses at bankfull conditions are typically 20 to 60 times the Shields stress at the onset of motion, so that a) dunes develop prominently for a considerable part of every flood hydrograph and b) sediment transport is intense at flood flows, with a considerable portion of the bed material load in suspension.



### Shields Regime Diagram Including SAFL Bridge Data

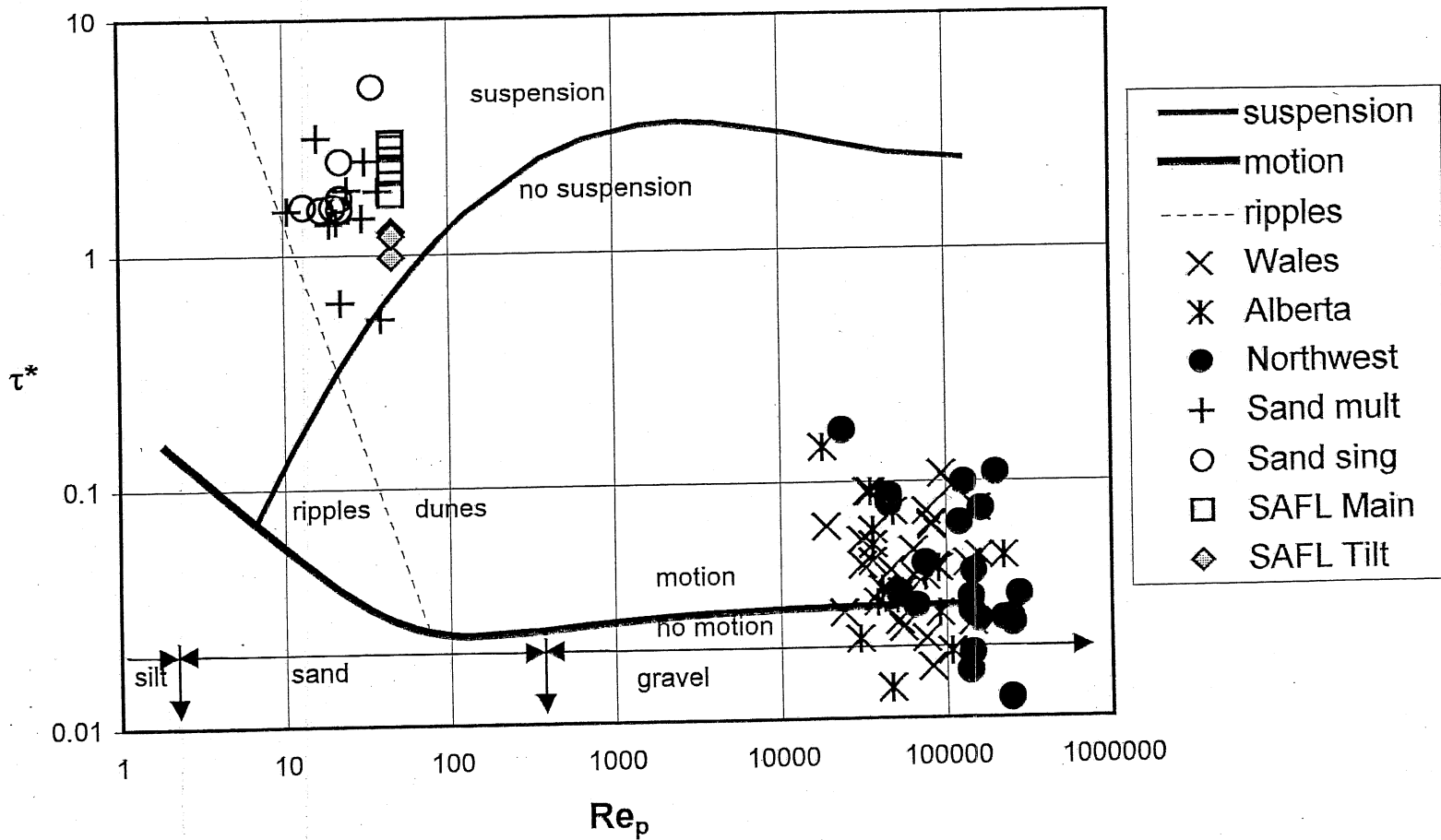


Figure 6.1. Regime diagram for rivers.

Also plotted in Figure 6.1 are the Shields stresses for the highest flows (conditions of Run 4) studied in the Main Channel (SAFL Main) and the Tilting Flume (SAFL Tilt) in the present study. The data pertain to series MC-NP0, MC-NP1, MC-NP2, TF-NP1 and TF-NP2. It is readily seen from the diagram that the experimental conditions of the SAFL experiments include the range corresponding to severe flood flows in sand-bed streams.

The high Shields stresses, importance of suspension and the prominent role of dunes in such rivers at flood flows create long-term conditions near bridge piers and transient conditions associated with bedform migration which act to leach sand out from underneath any armoring countermeasure that might be placed in the river. This is the reason that the use of a geotextile filter is essential for good performance of armoring countermeasures in sand bed streams. A geotextile filter should thus be considered an essential part of scour countermeasures for such streams. The areal cover of the geotextile filter should be less than that of the armoring countermeasure to allow for good self-anchoring and to resist uplift tendencies. Permeability should be sufficient to suppress uplift forces. The experimental results of this study indicate that wherever possible the geotextile filter should be sealed to the pier. A standard filter layer may be used in lieu of a geotextile filter, but in such a case some leaching of sand may be expected between the countermeasure and the pier in the absence of a good seal. If the geotextile filter is not sufficiently permeable, however, it can cause the buildup of excess pore pressure and consequent uplift failure.

Gravel bed streams are also prone to the leaching of sand near bridge piers at flood flows. Shields stresses are sufficiently low and self-armoring tendencies sufficiently high so that the gravel itself should not leach to any substantial degree. A geotextile filter thus is not required for such streams. The steeper slopes of gravel bed streams also imply a harsher environment for geotextile filters. A geotextile filter is not recommended in conjunction with armoring countermeasures in gravel bed streams.

The experiments allowed for the development of a tentative technology for the underwater placement of a geotextile filter around a bridge pier at low flow. The technology uses a geotextile filter that has been weighted around its outer perimeter, and employs cables and a crane to lay the geotextile filter. The geotextile filter is sealed to the bridge pier by means of a clamped cable inside a flexible tubing.

### **6.2.1 Riprap**

The experiments yielded the somewhat unexpected result that riprap is probably not as effective as previously thought in the case of sand bed streams. In such streams the action of bedforms causes riprap to be gradually buried in time. This gradual settling occurs even at flow velocities that are below the values necessary to mobilize the riprap directly. The amount of settling is in many cases large enough to eliminate most of the effectiveness of riprap. The process requires time, and may take the passage of several flood hydrographs before becoming evident.

Thicker layers of riprap and deeper placement tend to reduce the settling. The settling can be greatly inhibited, and the performance of the riprap greatly increased by placing a geotextile filter below the riprap. The geotextile filter should be sufficiently permeable, and not extend out as far as the riprap in order to avoid uplift failure. Best performance is obtained if it is sealed to the bridge pier. A standard filter layer can be used in lieu of a geotextile filter. Performance can be further improved by excavating a hole such that the top of the riprap is placed no higher than the average height of the bed. A technique was developed for installing the geotextile *in situ*.

In the case of sand bed streams, the addition of a geotextile filter sealed to the pier and pre-excavation of the placement zone renders riprap a highly effective scour countermeasure. In the case of gravel bed streams, the geotextile filter is neither necessary nor desirable. Pre-excavation may, however, be highly desirable, especially when riprap size is a significant factor of bankfull depth. The recommendations of HEC-18 (Richardson et al., 1993) call for riprap layers extending out at least 2 pier widths from every face. In addition, the riprap thickness is specified to be  $3 D_{150}$ , where  $D_{150}$  denotes the median size of the riprap. The present study indicated that in case that prior excavation is combined with a

geotextile filter or granular filter layer, the riprap need only extend out 1.5 pier widths from each face, and have a thickness of only  $2 D_{r50}$ .

The experiments demonstrated that appropriately placed riprap has the capacity to withstand bed degradation to a surprising degree.

### **6.2.2 Cable Tied Blocks**

The experiments demonstrate that cable tied blocks can be designed to be a highly effective countermeasure against pier scour. The mattress of blocks must be designed with a weight per unit area  $\zeta$  sufficient to withstand fluid forces. A design relation is verified for this purpose. The effective size of the individual blocks can be smaller than riprap. In sand bed streams leaching of sand from the interstices of the mattress can cause failure of a mattress of cable tied blocks even when designed to resist fluid flows. In such streams the mattress should be underlain by a geotextile filter or a filter layer. A geotextile filter is preferable, especially if it can be sealed to the bridge pier. It should not extend as far out as the mattress itself. A geotextile filter is not recommended for gravel bed streams. Performance of cable tied blocks in sand bed streams which are partially covered by cobble and boulder-sized material may be ineffective due to unbalanced settling of the mattress. In such cases the large material should be moved before installation.

### **6.2.3 Grout Filled Bags**

Grout filled bags did not perform as well as riprap or cable tied blocks in the experiments. Their lack of angularity resulted in poor interlocking, and their relatively smooth surfaces resulted in failure by sliding at relatively low flow velocities. The experiments do not suggest that they are an optimal countermeasure. In the event that they must be used, they should be sized and placed in a manner similar to riprap, and underlain by a geotextile filter with a partial cover or filter layer. Any means to render the surface of the bags rough and angular will aid performance. Long grout filled sausages are not only prone to sliding but also can be undermined from below due to the leaching of sand. Thus the countermeasure may not settle, but a significant scour hole can develop beneath it. Flexible bags of sand may be preferable to grout-filled bags.

### **6.2.4 Sacrificial Piles**

Sacrificial piles performed poorly under mobile-bed conditions characteristic of floods. They can worsen the scour problem when the angle of attack is poor.

### **6.2.5 Iowa Vanes**

Iowa vanes have proven successful in many applications in river engineering. They did not perform adequately as a countermeasure against bridge scour under mobile-bed conditions characteristic of floods, although they proved to be the best of the flow-altering countermeasures. In the case of bridge piers, their role is to direct sediment against the pier as a means of countering scour. At flood flows characteristic of sand-bed streams, however, scour depth is essentially independent of either flow velocity or sediment transport. This is one likely reason why they do not function well as a scour countermeasure.

### **6.2.6 Permeable Sheet Piles**

Submerged permeable sheet piles placed in front of a bridge pier performed poorly under mobile bed conditions, providing little or no scour protection at bridge piers.

### **6.2.7 Combination: Riprap and Permeable Sheet Piles**

Submerged permeable sheet piles in of themselves offer little scour protection. They can, however, extend the range of performance of riprap placed around a bridge pier. They may be appropriate as a retrofitting for piers with undersized riprap that cannot be easily augmented or replaced. They are likely subject to debris problems.

### **6.2.8 Combination: Cable Tied Blocks and Riprap**

The results of experiments on cable tied blocks augmented with riprap indicate that the riprap is not necessary for good performance if the block mattress is properly designed and underlain by a geotextile filter with partial cover sealed to the pier. A technique was developed for sealing the geotextile filter to the pier *in situ*.

### **6.2.9 High Density Riprap**

An angular riprap with a density near 5.0 was prepared for use in the experiments at St. Anthony Falls Laboratory. The results concerning settling of riprap of standard density due to the passage of bedforms suggested that smaller, heavier grains would settle even more easily. As a result, the experiments on high density riprap were omitted in favor of other more promising avenues of research.

### **6.2.10 Notes on Gravel Bed Streams**

In closing this chapter, a few remarks about gravel bed streams are in order. These streams typically have relatively steep slopes (e.g. in excess of 0.001), coarse bed material (e.g. in excess of 20 mm) and shallow flood flows (e.g. below 1.5 m). Some gravel bed streams are essentially bedrock streams for which the gravel rarely moves. In alluvial gravel bed streams, however, any device placed in the river is likely to be subject to severe abrasion during floods. Permeable sheet piles, Iowa vanes and grout filled bags may perform poorly in gravel bed streams. Leaching of sand, however, is usually not a severe problem. With this in mind, properly sized riprap and cable tied block mattresses can perform well even in the absence of a geotextile filter or granular filter layer. Care must be exercised, however, to insure that the individual units (i.e. riprap stones) do not protrude too far up into the flow during flood stage. Blockage of the entire water column by a unit can destabilize it.

## 7. FIELD SURVEY

### 7.1 INTRODUCTION

This chapter summarizes the findings of the field survey undertaken in 1996. In the following portions of the chapter an individual summary of nearly all bridges examined is provided. The introductory portion provides a quasi-executive summary of the field survey highlighting the issues of particular importance to the practitioner.

The extensive survey of field sites conducted during the spring, summer and fall of 1996 provided a wealth of useful information. The survey was especially helpful by enabling the team to ascertain first hand knowledge of personnel faced with installation and inspection of bridge scour countermeasures. This information was essential in focusing the development of the design guidelines to meet the requirements of the end user. As expected, in addition to reviewing the effectiveness of existing placement techniques for riprap, it also provided necessary information on the performance of several types of alternative countermeasures. Whenever possible the team identified the actual mode(s) of failure for existing installations. Of paramount importance was the identification of the controlling hydraulic, geomorphic, geotechnical, aesthetic, and environmental parameters that can affect constructability, reliability, maintainability, and cost.

Field trips were selected based upon the need to effectively review the performance of alternative countermeasures under as large a variation of the many controlling parameters as possible. Trips covered all four corners of the contiguous United States including the following states.

- North Carolina
- Arizona
- Maine
- Connecticut
- Pennsylvania
- Mississippi
- Oregon
- Minnesota
- Tennessee
- South Carolina
- California
- Massachusetts
- Maryland
- Florida
- Washington
- New York
- Kentucky
- Alabama

Survey summaries are presented here for all states except Minnesota and Kentucky.

These states provided good diversity and blended well with the team's extensive knowledge of the mid-western US gained from the 1993 flood. The trips were scheduled to provide good viewing conditions, i.e. minimal vegetation or leaf cover and low water conditions. An exception to this were trips to the states of Massachusetts and Maryland when the timing of the site visits to the former coincided with the runoff following hurricane Bertha, and the latter with a generally rainy weather pattern. The remainder of the trips coincided with excellent weather allowing the team members to visit field sites from dawn to dusk. Engineering staffs from the various states were very cooperative in working with the extended hours of the team.

The team typically reviewed five to ten bridges in each state. As expected, with the nature of field installations being what they are, the team found the face to face interaction with field personnel to be extremely helpful in selecting the most appropriate bridges to inspect. These conversations and the first inspection or two often led to the suggestion of other problematic bridges. While some states were immediately open to showing their less successful attempts at bridge pier countermeasure installation, the team found that some personnel opened up only after getting to know the team members following a day or

two in the field. Inspections focused on bridge pier scour countermeasures but also included other installations, such as abutments, from which valuable performance information could be gleaned. Typically a countermeasure is not limited to the pier but is also placed near the abutments. This provided team members multiple opportunities to review the performance of a countermeasure at a single bridge crossing. Furthermore, it allowed the team better access to the countermeasure. This was especially important when assessing parameters such as material performance and durability.

While the field application of alternative scour countermeasures is generally limited, the team was able to review field installations of gabions and similar style rock baskets, cable tied blocks, grout bags, permeable dike diversion structures, grouted riprap, soil cement, and a multitude of placement techniques for standard riprap.

The vast majority of riprap field installations were of the dumped variety. Riprap performance was effective in many situations but varied significantly depending on placement technique. The method of placement ranged from simply dumping from a truck to hand placement of each stone. Geotextiles were used in many newer installations with mixed success. Geotextile performance was highly dependent upon the materials ability to resist rupture, as tearing of the fabric reduces its effectiveness greatly. Similarly, the installation of the geotextile edge is critical to its effectiveness. Numerous installations were observed where the edge of the fabric had peeled back and was flapping in the flow. Two examples of very different riprap performance were observed on two rivers in North and South Carolina. The first involved placement of large riprap (2 feet or more in diameter) in a mounded fashion around the bridge piers, while the second involved placement of undersize riprap (the contractor substituted a smaller size rock) in a matted fashion from one abutment to the other (essentially like pavers). Both rivers experienced large floods (approaching the 100-yr. event) within approximately one year of installation of the countermeasure. The bridge with the relatively conventional mounded riprap experienced significant riprap movement while at the second bridge the team found excellent performance with just a limited number of stones in front and on the sides of the piers turned on end.

Gabion performance generally was successful except for the tearing of baskets from river borne debris. Durability of the basket material is also of concern. Review of field installations indicated numerous tears in the woven baskets. Tears in the baskets are most typically associated with debris catching on the basket and ultimately ripping or fracturing the mesh containing the rocks. Some instances of basket mesh deterioration were noted. This was especially true for standard carbon steel baskets that had been in place for at least several years.

Figure 7.1 underscores the importance for baskets to deform without rupturing.

For example:

Fox Creek (a cobble bed stream) which impinges on the highway embankment of New York 443 near Zimmer Road and flow parallel to the embankment for approximately 200 m. A section of a vertical concrete retaining wall supports the embankment at the impingement point. Approximately 20 meters downstream from the impingement point, a section of gabions retains and protects the embankment. Undermining of a portion of the gabion wall caused sagging. Lack of access to the gabions precluded detailed examination; however, review of inspection photographs revealed no obvious breaks in the gabion wire.

Two items of significant importance were noted during review of a U.S. Army Corps of Engineers' designed cable tied block installation at the I-880 crossing over the Guadalupe river in San Jose, California. As seen in Figure 7.2 cable tied blocks were placed throughout the primary and overflow channels underneath a large multilane bridge. On inspection, it was noted that in spite of detailed design specifications, portions of the galvanized cable were beginning to rust between the inner strands. The cables had been only occasionally immersed in water since construction. It appeared the galvanizing process effectively covered the cable exterior but did not prevent the inner strands from rusting. The second was not specific to cable tied blocks but pertained to undermining of the blocks related to the geotextile matting immediately downstream of a small (nominally 2 foot high) grade control structure as can be seen in Figure 7.3. It appeared that the matting had pulled away at the edge closest to the structure

allowing undermining of the soil which was a fine silty material. At the present time the undermining was only about a foot in depth but the countermeasure had been in place for only a short period and had experienced only a single significant flood event.

A number of grout bag installations were evaluated at generally small bridges in Maryland. These appeared to be relatively successful as shown in Figure 7.4 of a typical installation. The primary problems noted concern the bag's size and its rigid nature vs. its ability to resist scour. As seen in Figure 7.5, some undercutting effects were noted at the sides and ends of bags when the bag was unable to settle effectively. The worst case noted was an installation where the contractor had, in an effort to make the finished product look good and use up available concrete, placed a thin coating of concrete on top of the bags and along the joints. Unfortunately, this layer effectively grouted the bags in place. At the time of the team's inspection, the grouted mass had been undercut by approximately 3 feet and was cantilevered from the adjacent abutment Figure 7.6.

Permeable dike structures were effective in shifting the channel alignment by allowing sediment to settle out downstream of the structure. At the present time, permeable dike construction is typically limited to channel training in larger rivers with unstable channels.

A few grouted riprap installations were encountered. However their effectiveness as a bridge pier countermeasure is questioned because it may simply increase the effective pier size, thereby exasperating the scour conditions.

Soil cement has proven effective near Tucson, Arizona where the typical soil conditions have a grain size distribution which, when mixed with cement, naturally forms a stable soil-concrete mixture. Figure 7.7 shows a new soil cement structure under construction, while Figure 7.8 shows an embankment which sustained damage but did not fail during a flood. Soil conditions in the Phoenix area are not as well suited to making soil cement. Some erosion to the soil cement was noted. However, the ephemeral nature of the rivers on which it has been installed to allow for relatively inexpensive repair. The opinion of the team is that it may have promise in similar areas such as Southern California, provided the soil conditions are favorable. It is doubtful that soil cement will be effective in regions where any soil moisture exists as even minor levels of moisture will affect performance.

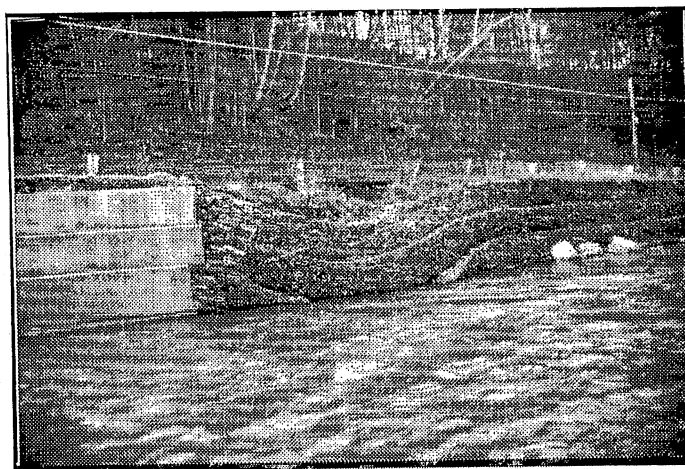
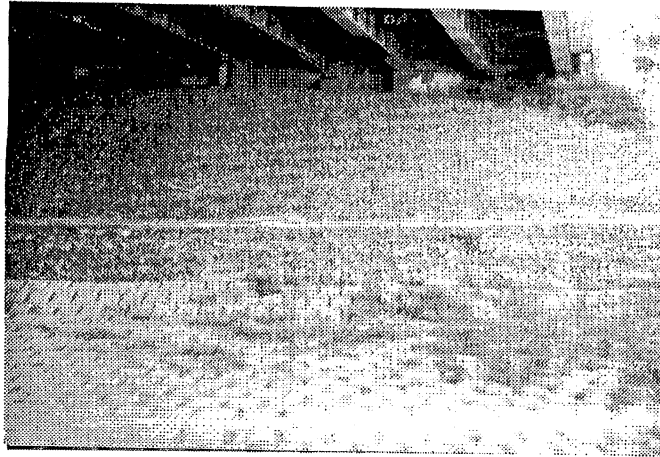
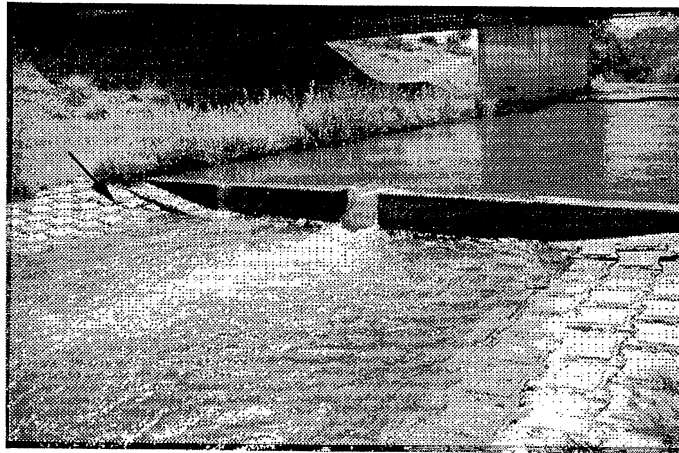


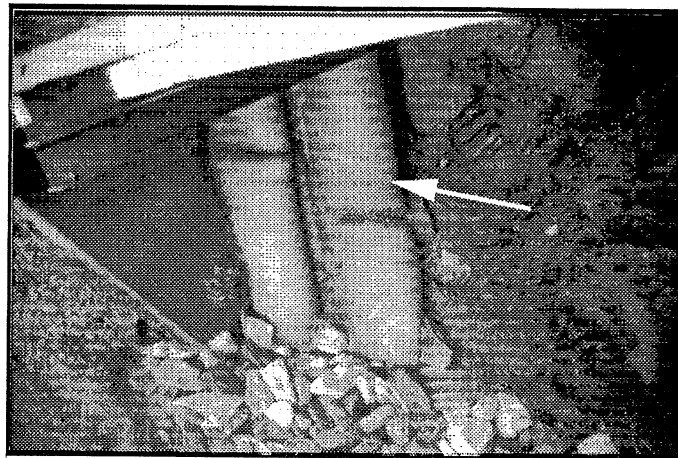
Figure 7.1. Shows baskets that have deformed and ruptured.



**Figure 7.2.** Shows cable tied blocks placed in channels underneath a multilane bridge.

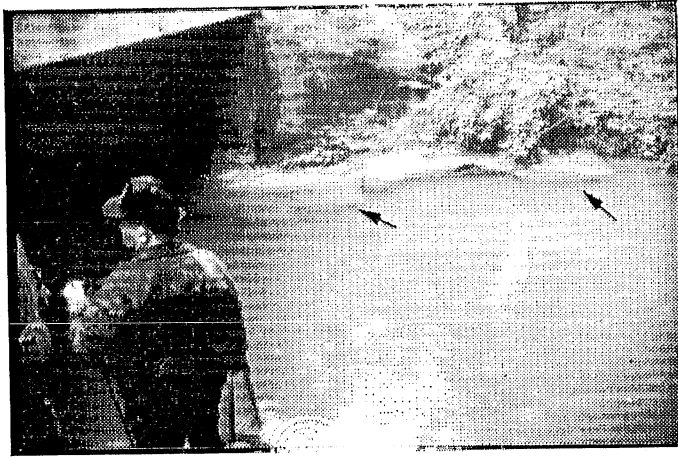


**Figure 7.3.** Shows undermining of the blocks related to the geotextile matting immediately downstream of a small grade control structure.



**Figure 7.4.** Grout bags installed at a small bridge.

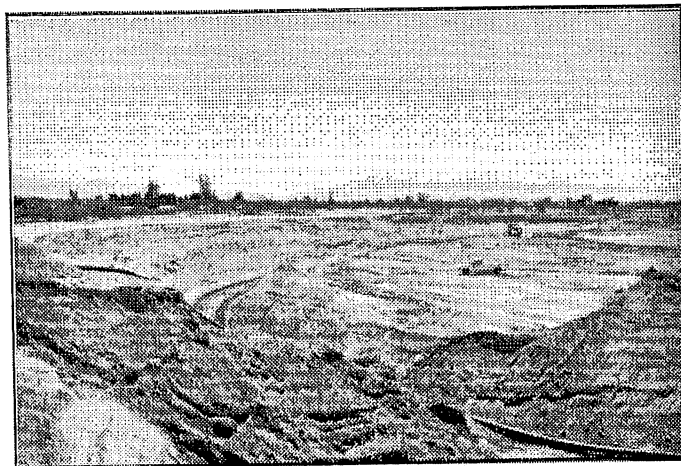




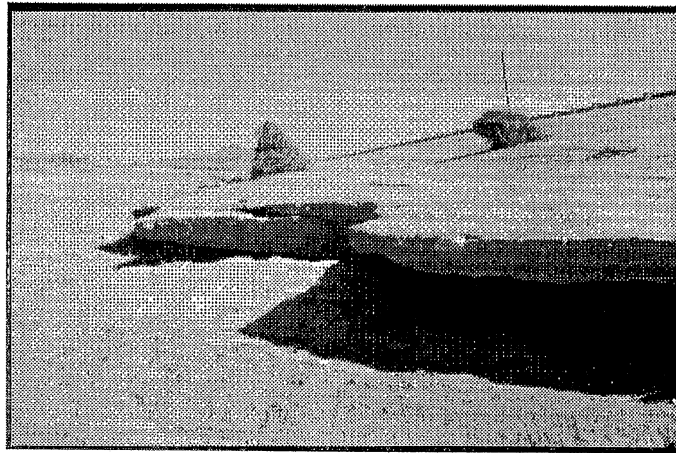
**Figure 7.5.** Shows some undercutting of grout bags at ends and sides.



**Figure 7.6.** Shows grout mass undercut and cantilevered from the adjacent abutment.



**Figure 7.7.** Shows a new soil-cement structure under construction.



**Figure 7.8.** Shows an embankment which sustained damage but did not fail during a flood.

## **7.2 KEY FINDINGS**

The survey was extremely beneficial to the team's overall goal of providing the most cost-effective use of project funds. A brief description of the general recommended do's and don'ts for riprap and alternative countermeasures are provided below. Also provided is a summary of the other issues directly relevant (but perhaps not obvious) to the engineer designing/installing scour countermeasures. This includes applicability, maintainability, and constructability.

- Two primary methods of failure were noted for properly sized riprap.
  - 1) Instability of the river bed.
  - 2) Failure caused by an inadequate filter.
- Countermeasure failure due to stream instability was consistently reported by the host engineers in most states. Many designers and nearly all maintenance personnel simply do not have the tools to effectively address stream stability issues.
- When placing dumped riprap, caution must be emphasized to assure that segregation of the riprap does not occur and areal coverage is sufficient.
- The effect of localized drainage on countermeasure performance must be considered. Roadway ditches often discharge at 90 degrees to the river channel and can subtly undercut scour protection rendering the countermeasure less effective when a large flood arrives. Mitigation requires that drainage and bridge engineers work together to ensure that designs integrate well and are mutually effective.
- Geotextile must be placed so that no gaps are present, or can form, between the geotextile and any structure it is protecting.
- Wire and cabling selection for gabions, Reno mattresses and cable tied blocks should be limited to non-corrosive materials. Field experience indicated that even well specified galvanized, coated wire was subject to internal corrosion.
- Gabions should be inspected for basket tearing caused by riverborne debris following floods that exceed bankfull.
- Grout bags were effective for small bridges but undercutting was observed at the sides and end of bags when bags were too large to settle effectively.

- Soil cement is effective when little or no soil moisture exists in surrounding soil. For optimum effectiveness, the local soil should have a grain size distribution which, when mixed with cement, naturally forms a stable soil-cement mixture.

Stream stability is an issue facing many practitioners. The level of reliable countermeasure performance is much higher for well-behaved streams than for those subject to channel shift. Comments related to this were consistently heard from the host individuals in most states. Not only can stream instability shift channel position directly affecting piers and abutments, it can radically alter the angle of attack from which the flow approaches such structures. Many designers and nearly all maintenance personnel simply do not have the tools available to them to effectively address stream stability issues.

Local drainage flows affect general instability. Typically extensive efforts are undertaken to protect a bridge from scour due to riverine flows only to overlook the significance of localized drainage on the performance of scour countermeasures. Very often at 90 degrees to the river channel, these localized discharges can subtly undercut scour protection rendering the countermeasure less effective and subject to failure when a large flood arrives.

Another drainage issue evident at a number of sites pertained to the containment or lack of containment of drainage of the roadbed. Seepage from such sources can occur adjacent to the bridge abutment causing slip type failure in the soil under the countermeasure. A classic example is described below.

The principal difficulties at this site, according to CalTrans engineers, were scour of the stream bed around piers founded on piles with less than 5 m of embedment, removal of soil and lateral support for piers on the banks under the bridge, and excessive length/diameter conditions for the pier columns (with resultant excessive vibration). At this site, in winter 1995-6, a check dam had been built with steel sheetpiles downstream from the east-bound (downstream) bridge, to retard or prevent channel degradation where the bearing piles under the piers had been driven to shallow depths below the stream bed. When the original structure was widened, additional piles had been driven at each pier. Each pier originally had consisted of a four-pile bent; to supplement the original piles, one new pile was driven on the median side of each bent and four new piles were driven on the shoulder side of each bent. Because of concern about possible removal of support around the piles in the stream channel, the new piles were driven to greater depths than the founding depths of the original piles. The bearing piles under the piers were Raymond step-taper piles consisting of light gauge telescoping sections of casing. The step-taper piles are driven with an inner mandrel, the mandrel is removed when the pile has reached the appropriate depth/resistance, and the casing is filled with concrete. Steel reinforcing bars are inserted from the surmounting columns into the concrete-filled casing for twelve feet or to a depth equal to the length of the pile divided by four, whichever is greater. The piles are surmounted by cylindrical concrete columns that are joined under the bridge superstructure by cap beams to form piers. Rock-filled gabions had been placed in two stepped tiers on the lower part of the southwest (right descending) bank, with a rock-wire mattress over the middle height of the bank, and sandbags above the mattress to hold down the upper edges of the wire fabric. The gabion/mattress treatment was considered to be an emergency measure likely to last no longer than the winter months. Plans were being formulated to build a concrete retaining wall to protect both bridges. A secondary pile-crossbeam structure had been built at midheight of the bank as part of an old bridge.

The surficial soils at the I-80 bridge over Ulatis Creek consisted of layered alluvial soils with a relatively high fine particle content and high dry strength. The lower portion of the left descending bank had been eroded to very steep inclinations. It was observed that the soils of the lower part of the left descending bank between the twin bridges and under the eastbound bridge had numerous vertical tension cracks in the bank soils. Cavities in the bank faces indicated the effects of emergent seepage. Seepage emerging from the more pervious alluvial layers in the banks apparently had removed soil, exposing the lower parts of the bridge pier columns and portions of the Raymond step-taper bearing piles. Near the lower edge of the abutment pile cap beam of the westbound bridge, on the left descending bank; flow out of the bank soils had eroded

cavity exposing the bearing piles under the abutment. Similar erosion channels and cavities had been cut under the abutment of the eastbound bridge, on the right descending bank. Examination of the banks upstream and downstream from the bridge indicated that the flow section was much wider at the bridge. Retreat of the banks caused by emergent seepage erosion appeared to be a major factor in widening of the stream at the bridge. The irregular planform and topography of the bank would not have been caused by flow deflected from the piers or constricted at the bridge opening. Water apparently had entered the banks at the bridge abutments and had seeped vertically until changes in hydraulic conductivity between soil layers had caused the water to migrate laterally and out of the bank faces under the bridges. No such gulying, cavities or distress was detected on the banks upstream and downstream from the bridges, and the area between the bridges did not show nearly as much bank retreat as the banks under the bridge decks. The approach slabs adjacent to the abutment over the left descending bank for the west-bound bridge showed some subsidence relative to the bridge, indicating possible loss of soil under the slabs at that location. Such soil loss would have been consistent with the evidence of water leaking downward under the abutments and emerging from the banks under the bridges. Lack of bank retreat on the lower portions of the banks between the bridges was an indication that the removal of soil from the banks was not caused mainly by local scour or contraction scour effects.

Both of the drainage issues highlight a need for better coordination between design and field maintenance personnel. Each state DOT has its own structure and unique operational requirements; however, in most states visited the maintenance division was responsible for scour countermeasure efforts. Only when a countermeasure is being installed at a new bridge or is of significantly large magnitude do most state DOT's design divisions get involved. Increased coordination between these groups at the time of scour countermeasure installation would be beneficial to enhancing scour measure performance.

**Riprap:** Two primary methods of failure were noted for riprap (aside from direct entrainment by the flow, avoidance criteria for which exists in most design manuals) these are failures caused by 1) instability of the river bed and 2) failure caused by an inadequate filter. As mentioned above, stream instability affects countermeasure performance by altering the hydrodynamic conditions the countermeasure experiences. Other types of instability can occur when a bridge opening either significantly increases or decreases the conveyance capacity of the river. Typically, bridge openings are, of necessity, designed to not restrict flow past the bridge under flood conditions. During typical river discharges however, this design practice may lead to sediment deposition effecting countermeasure performance by locally altering flow patterns. Periodic monitoring programs should review installations potentially subject to such conditions to ascertain whether or not any remedial measures need to be taken.

Adequate filtering should be placed under countermeasures to prevent subsidence related failures of the countermeasures. Riprap in particular can sink well below the bed surface (note: this only becomes a serious problem if it sinks to a level below which it provides adequate protection, however it becomes a maintenance problem as soon as it sinks to a level preventing routine detection during inspection.) Winnowing of fines for other countermeasures can lead to voids underneath the countermeasure and general undercutting of the countermeasure if the countermeasure is too stiff.

Selection of rust resistant materials is important for any countermeasures requiring some form of cabling. All components for these types of countermeasures should be of stainless steel or single strand galvanized wire or resistant plastic. Review of well-designed sites such as the I-880 bypass over the Guadalupe River in San Jose showed the importance of not overlooking the smallest detail. For example, the uncoated inner stands of a well galvanized high quality multistranded cabling interconnecting a normally dry portion of the cable tied block system installation was experiencing corrosion after a single flood. Similarly, standard cable ties should be of stainless steel to prevent corrosion to this small everyday but critical component.

Another issue faced by some states is the installation of countermeasures in cold water. Discussions with personnel from the Maine DOT indicated the need to work in water temperatures in the mid-50 degree Fahrenheit range. Installation techniques that work well at warmer water temperatures may become cumbersome if not impossible undertakings at these temperatures. Wire gets much less pliable and

more difficult to work with, divers get cold, etc. All this leads to installations that require more time and financial resources to install and perhaps a lower quality end product.

The following summaries highlight key observations made for nearly all bridges inspected. To the extent practical, the summaries are provided in the chronological order in which the site visits were made.

### **7.3 NORTH CAROLINA**

#### **7.3.1 US 13 Tar River Bridge in Pitt County**

The first bridge visited was the US 13 Tar River bridge in Pitt County, North Carolina, May 1996. The problem at this site was bank erosion on the right descending bank of the stream; scour threatened to undermine the abutment and the support for the pile bent closest to the right descending bank. Mr. Ronald Bennett, in charge of maintenance for Pitt County bridges, stated that trees and other debris accumulate on the upstream sides of the pile bents. Soil cement sack "riprap" had been placed on the face of the abutment fill on the upper part of the right descending bank. Additional countermeasures at this site included the placement of riprap around pile bents and driving of additional piles to form what were termed "crutch" bents. The bank soils were layered and the erosion processes included scour associated with flow around the bend in the stream, scour near the toe of the right descending bank, and piping/sapping to a minor degree. Soil cement sack riprap had been placed in 1967 on the right descending bank. Approximately two to three feet of bank soil had been lost behind the sack riprap, at the downstream face of the bridge. No filter materials, either mineral or geosynthetic, were visible under the riprap, and none appeared to have been placed under the soil cement sack riprap. The right descending bank immediately upstream from the bridge had been protected with dumped riprap consisting of large pieces of rock, in about 1982. No filter layers could be detected under the layer of large riprap. Water flow down the apron of the abutment and water flow out of the soil under the soil cement sack riprap appeared to have been a significant factor in the failure of the sack riprap, although it would be difficult to assess the relative importance of toe erosion, overland flow and seepage erosion to the failure of the soil cement sack treatment. The principal problems were lateral migration of the stream, cutting into the right descending bank and removing support under the right (southwest) abutment of the bridge and around the piles of the bent nearest the right descending bank, and scour of the right bank caused by debris accumulation around the pile bents. The surficial soils on the banks of the stream consisted of fine silty sands and sandy silts, with intermediate layers of leaf debris, dead vegetation and other organics.

#### **7.3.2 Highway 11 Contentnea Creek Bridge in Lenoir County**

North Carolina Highway 11 over Contentnea Creek in Lenoir County, North Carolina, is almost on the boundary between Lenoir County and Pitt County. At this structure, riprap had been placed around two of the pile bents as a countermeasure against scour. The water level was at the top of the protected bank zone, and the riprap that had been placed around the pile bents was not visible.

The right descending bank of the stream had been eroded just downstream of the bridge, but large trees on the banks farther away from the bridge indicated that the stream was relatively stable. Local channel widening at the bridge site was associated most probably with debris accumulations on the piers and with severe contraction of floodplain flow. The stream channel upstream and downstream from the bridge did not appear to have widened or migrated significantly in the time since the bridge had been built. Recorded scour at this site was concentrated near the middle of the stream section, near the thalweg. Plan views of the site show that contraction effects are severe at this bridge. Very large trees on the right descending bank indicated relative stability of the stream; the stream showed no evidence of significant lateral shift. Riprap visible on the right descending bank at the structure appeared to be sedimentary rock, a limestone containing numerous shell fragments cemented by a calcareous binder. The configuration of the stream at the site and the unusual erosional features under the north-bound lanes indicated the probability that debris had accumulated on the upstream faces of the pile bents and caused the current to be

deflected toward the right descending bank. Surficial bank soils at the site consisted of clean uniform fine sands and silty fine sands.

### **7.3.3 US 421 Muddy Creek Bridge in Forsyth County**

US 421 north bridge over Muddy Creek in western Forsyth County, west of Winston-Salem, North Carolina. At this site, riprap had been placed on the left descending bank, and around the bases of piers in the middle of the stream and on the right descending bank. The right descending bank consisted of two levels; the western pier of the main bridge structure was located on the lower portion of the bank, below a nearly horizontal midheight zone. Two piers support the main section of each span; pile bents supported the shorter spans to the east and west of the main spans. Debris had accumulated upstream from the upstream leg of the east pier under the west-bound span. Sediment had accumulated downstream from both legs of that pier, over and around the riprap that had been placed around the base of that pier. The riprap around the east pier of the downstream span was free of sediment and debris on the upstream leg of the pier, but a limited amount of sediment had accumulated around the riprap, and some debris was present, around the downstream leg of that pier, under the eastbound, downstream bridge. The riprap used at this site consisted of hard, strong, intact metamorphic rock, including slightly metamorphosed syenite, granite, phyllite, and schist. The rock showed no signs of weathering or surface deterioration. The local bridge maintenance supervisor, Mr. Ronald Joyce, stated that over 1,920 tons of riprap had been placed on the bottom and banks of the stream, and mounded around the piers in the stream to a height of about 1.5 m above the stream bottom. Before the channel bottom had been lined with riprap, a grade-control check dam had been made just downstream from the bridge by dumping riprap across the width of the stream. The check dam also served as an access road for equipment used in placing the riprap on the banks, on the bottom, and around the piers. No filter material, either mineral or geosynthetic, was placed on the exposed surfaces before riprap was dumped. Riprap had been placed on the left descending bank to the base of the pile bent there, and on both levels of the right descending bank. Class B riprap had been used on the upper bank levels and class II riprap had been used on the lower banks and channel, and around the piers. Riprap had been removed from small areas under debris around pier bases, and those areas were measured. A small accumulation of debris was present on the upstream face of the upstream pier leg in the channel. Eight cross-sections were measured, as were areas of the streambed where riprap had been removed. Rods were driven to locate the top of footing of the most upstream pier in the channel, and the top of the rods was used as a temporary benchmark for the cross-sections. Plans for the structure, compared to conditions observed, indicated that the stream had widened at the bridge. The bed of the channel was composed of clean fine to coarse sand and fine gravel; observations of bed samples indicated that about one-fourth of the bed materials were fine gravel (2 to 10 mm) and three-fourths were sand (0.1 to 2 mm). A layer of weakly cemented gravel was exposed where large riprap had been removed from the stream bed. The sediments on the banks consisted primarily of fine to medium silty sand.

### **7.3.4 Highway 8 Town Creek Bridge in Stokes County**

North Carolina highway 8 over Town Creek (Bridge No. 4) in Stokes County, North Carolina; the site is virtually adjacent to the boundary between Stokes County and Forsyth County. The main problem at this site was degradation of rock under pier footings for the center span, with projected loss of stability of the bridge. Because of the anticipated scour in the degraded rock, and because of limited observed scour of rock under pier footings, riprap was placed on the banks, around pile bents, and on the stream bed, and was mounded around the bridge pier footings. The side spans of the bridge are supported on timber pile bents. Class II riprap, with a median rock size of 30 cm was used on the streambed, lower banks and pier mounds; class B riprap was used on the upper parts of the stream banks. Before any riprap was placed or any bank shaping was done, a check dam of rock was placed in the stream downstream from the bridge. No mineral or geosynthetic filter was used at this site. The stream banks and channel were shaped and smoothed, and then riprap was dumped. Crews worked off the south, downstream side of the bridge, and proceeded north under the structure. The class II riprap was extended about 2 m up the banks to protect the pile bents of the bridge.

Bedrock outcrops in the stream bed upstream and downstream from the bridge, as well as under the bridge. A scour investigation had been conducted, and the consultant who conducted that investigation reported accumulation of debris on the upstream sides of the piers in the channel. The banks of the stream upstream and downstream from the bridge appeared to be stable; local widening of the stream at the bridge probably was associated with accumulation of debris on the bridge piers. Piers founded on footings resting on rock supported the center span of the bridge, and two timber pile bents, and the abutments, supported the side spans. The stream flows approximately from south to north, so that the right descending bank is the east bank. The bed material in the bottom of the stream consisted of micaceous silty sand mixed with fine to coarse gravel and cobbles, over bedrock.

A very wide floodplain was present to the west of the bridge, and a relief bridge had been built to the west of the bridge over Town Creek. Examination of the vegetation on the banks of the stream indicated that little active erosion had occurred since the bridge was built. Mature trees as much as 0.5 m in diameter were located on the banks very close to the water surface on June 5, 1996; much of the bed of the stream was exposed, and flow was only about 8 to 10 cm deep over much of the area examined. Downstream from the bridge, sediments had been deposited on the lower left descending bank, and both banks supported large mature trees. The principal difficulty at this location was local widening caused by debris accumulation on piers, and scour in degrading rock under the pier footings. Bedrock had been scoured from beneath the footings and from the bed around the footings. Debris was present on the left descending bank just downstream from the bridge. The lack of instability in the banks upstream and downstream from the bridge, the widened section right at the bridge, and the loss of foundation material (bedrock) around the pier footings indicated the probability that debris accumulation was significant in causing local scour.

Sediments had accumulated in a bar formation downstream from the bridge, near the debris accumulation on the left descending bank; the sediments ranged in size from coarse sand to cobbles. The rock on the bed of the stream was a metamorphosed igneous rock, occurring in dipping beds. The strike of the beds was oriented at a high angle to the flow direction of the stream, extending generally northwest to southeast, making an angle of about 45 degrees with the left descending bank upstream from the bridge. The beds dipped at an angle of about 40 degrees to the southwest. The bedrock was separated into blocks 10 to 30 cm on a side by very tight joints perpendicular to the bedding planes. The rock was a strong, hard crystalline rock with no pronounced cleavage, but the outer surfaces of the rock layers exposed in the stream had weathered (turning dark brown from medium to dark gray) to depths of 5 to 10 mm. The weathered "skin" around the blocks of rock in the stream could be scraped and dislodged with a thumbnail. Alternate layers of rock apparently are weaker and are eroded more deeply, leaving a very irregular series of ridges extending as much as 1 meter from adjacent beds. During periods of high flow the sand and gravel between the more resistant rock layers would be removed, leaving sharp ridges which would deflect the flow and lead to intense local energy dissipation and turbulence. Bed load in the stream would be moved against the exposed rock ridges in a very aggressive abrasion of the weathered outer surfaces of the rock layers.

## **7.4 SOUTH CAROLINA**

### **7.4.1 Smith Branch Bridge in Columbia**

A visit was made to Columbia, South Carolina, at Clement Road over Smith Branch, a tributary of the Broad River. Geometric constraints included an intersection between Clement Road and Westwood Avenue approximately 10 m beyond the right descending bank of the stream and a large sewer line aligned parallel to the bridge and just upstream from the structure. The bridge was supported on timber pile bents. Riprap 0.3 to 0.6 m thick had been placed on the right descending bank, and the left descending bank had been paved with bituminous concrete. The abutments were founded on timber piles, and horizontal lagging boards had been inserted between the bearing piles to form vertical faces for the abutments. A considerable amount of scour and erosion had occurred under the bridge and against the abutments where all of the spill fill had been removed, exposing the bearing piles under the abutments. Debris accumulation



on the timber pile bents apparently deflected flow during flood events causing scour of the gravel of the stream bed and loss of soil in front of the abutments. Local widening of the channel appeared to have been caused most probably by flow deflected by debris accumulated on the timber pile bents of the bridge. Gabions and Reno mattresses are to be used at this site as countermeasures against the scour anticipated because of the geometric constraints imposed on flow at the site, when the existing structure is replaced by two 30-m spans. The lower sections of the stream banks will be made vertical with gabions, with an upper section of gabions sloped at 2 vertical on 1 horizontal up to riprap protection in the top section of the banks near the abutments. The stream is sinuous near the bridge, with two bends immediately upstream from the bridge site. The right descending bank of the stream had been eroded to close proximity to Westwood Avenue, about 25 m upstream from the bridge. The bed of the stream was covered with granular sediments varying from sand to coarse gravel and sparse cobbles. Riprap had been placed along the bed of the stream and had been displaced downstream through the bridge opening by flow. The bank soils at this site appeared to include lensed alluvial sedimentary deposits that had been distorted by slumping and failure as a result of toe erosion. Iron staining marked the lenses of sediments, and indicated persistent flow of groundwater through more relatively pervious layers and lenses. Silty sands and sandy silts with little clay-size particles present appeared to be the predominant textures in the banks. On the right descending bank, all of the spill fill had been removed; riprap had been placed below the timber lagging between piles. Some of the soil layers in the upper bank appeared to be residual soil with as much as 15 to 20 percent clay-size particles. The lateral migration of the stream upstream from the bridge had necessitated bank protection; the bank had been protected with cemented riprap on the outside of the bend just upstream from the bridge. The Smith Branch site was of interest because of the anticipated countermeasures: use of gabions to form vertical banks and to prevent widening and scour of abutment areas. Gabions have not been used to any significant degree as a countermeasure against scour at bridges in South Carolina. During large floods, the opening of the Smith Branch bridge had been blocked almost completely with debris accumulated on the upstream faces of the timber piles. The flow was deflected vertically downward against the stream bed and laterally against the spill-fill slopes of the abutments.

#### **7.4.2 I-26 South Tyger River Bridge in Spartanburg County**

I-26 bridge over the south Tyger River in Spartanburg County, South Carolina. Riprap had been placed on the banks and stream bed, and around the bases of the piers for the center span of the bridge. Subsequently in 1995, the 100-year storm and flood had occurred. Concern had arisen because scour equations had been used to arrive at a mean size for the riprap and the stone used at the site contained many pieces smaller than that median size. A geosynthetic filter had been placed under the riprap on the banks but no filter had been used under the riprap around the piers. Examination indicated that the riprap was knitted tightly together and little evidence was seen to suggest any displacement of the exposed riprap from its original configuration. Probing of the stream bed and around the piers indicated some slight movement of riprap around the upstream noses of piers along the pier bases. A layer of sand was found over the riprap, for most of the stream bed area under the bridge. Sand was not present over the stone around the upstream sides of the pier bases, nor along the sides of the piers. The nominal and maximum dimensions of the riprap that appeared to have been displaced around the piers were measured; the maximum dimension was about 20 cm and the nominal dimension was about 10 cm. The riprap was a slightly metamorphosed granitic rock, with occasional large feldspar crystals; it was very hard and showed very little weathering. Both banks of the stream upstream from the bridge appeared to have been relatively stable for a long time, as indicated by the vegetation on the banks. The banks downstream from the bridge showed trees 20 to 30 cm in diameter on the lower banks near the water surface; very little evidence of stream widening or bank erosion was found. The principal problem at the site appeared to be local scour and widening at the bridge piers. A section of geosynthetic filter fabric on the right descending bank was examined near the edge of the riprap; the material consisted of flat film woven to form the fabric. The edges of the fabric were exposed near the upper limits and edges of the riprap. The configuration and orientation of the riprap on both banks appeared to indicate very little displacement from the as-built condition. A minor accumulation of riprap was noted along the toe of the right descending bank under the north-bound (downstream) spans. Sand and fine gravel had accumulated on the toe of the right descending bank just downstream from the south piers. A small excavation in the riprap on the right descending bank



showed the geosynthetic filter to be intact and in good condition at the appropriate depth below the surface of the riprap. The bridge had been widened in 1994-5 by the addition of two piers on each side of the existing four piers under each set of lanes. The lower segments of the original piers of the bridge were rectangular in section, whereas the added piers were circular.

#### 7.4.3 Enoree River Deyoung Bridge

Deyoung Bridge, Enoree River, on the boundary between Spartanburg County and Laurens County; this bridge was supported on hammerhead piers with cylindrical lower sections. The bedrock at this site consisted of igneous rocks with varying degrees of metamorphism; thin layers of mixed-grain micaceous clayey silty sand to sandy silt residual soil over the rock contained numerous rock fragments. Closer to the Enoree River, the soil consisted of alluvial lenses and layers of sands and silts. Riprap had been placed on the right descending bank around the pier closest to the west abutment; little of that riprap appeared to have been displaced. Prior to the August 1995 flood, the left descending bank was located at the pier on that bank; retreat of the left bank was attributed to local scour around the cylindrical pier, which was founded on a spread footing over bedrock. Debris was found resting on the cap beam under the bridge; the water surface during the flood had risen over the lower edge of the bridge girders over the hammerhead piers. Streambanks upstream and downstream from the bridge showed very dense vegetation, including large trees, down to the water surface.

### 7.5 ARIZONA AND CALIFORNIA

Visits were made between June 17-21, 1996 to Arizona, Nevada, and California.

In Arizona, assistance was provided on behalf of the state of Arizona by Mr. George A. Lopez-Cepero, Chief Drainage Design Engineer; Mr. Dennis Crandall, Bridge Drainage Team Leader; and Mr. Raymond C. Jordan, Drainage Supervisor. All three of these individuals were employees of the Arizona Department of Transportation, 205 S. 17th Avenue, Phoenix, AZ 85007-3212; (602-255-7481). In Tucson, assistance was provided by Mr. Zbig Osmolski, Flood Control Engineering Manager, and Mr. Fazle Karim, Chief Hydrologist, Department of Transportation and Flood Control District, Public Works Building, 201 North Stone Avenue, Tucson, AZ 85701-1207 (520-740-6372).

### 7.6 ARIZONA

In conversations with Messrs. Lopez-Cepero, Crandall and Jordan, it was stated that about 880 highway bridges are located over water in Arizona. As of June, 1996 almost 810 of those bridges had been assessed with regard to scour susceptibility. The state of Arizona owns the bridges on state highways, and ADOT personnel supervise consultant assessment of bridges owned by local governments. In a compendium of data on scour countermeasures that have been taken at bridges in Arizona, the following methods were listed (with the number of bridges protected):

• concrete floor on channel under bridge	97
• channel check structures	14
• bank protection	14
• dumped riprap floors	8
• soil cement channel floors	7
• monitoring required	5
• pier pads	4
• spur dikes	3
• bridge replacement	2
• outlet drop structure	1

At three sites, foundation investigations were recommended, and at three other sites, the low priority of the bridge indicated that future study would be an adequate measure against scour. One bridge was designated to be closed during floods.

A very common countermeasure for bank protection in Arizona was to drive short lengths of railroad rails about one meter into the soil to retain welded wire fabric, which in turn retained large pieces of riprap. The railroad rails commonly were driven about 1.5 meters apart. A second very common treatment of banks and abutments was to place soil cement in wide layers with a steep face inclination along the zones to be protected. Use of soil cement was not considered to be cost effective unless the volume of soil cement approached 8,000 cubic meters on a site. At some sites (e.g., along the Salt River), soil cement had been placed to form steps or berms along protected reaches. At new bridges, and at some sites where older bridges have been renovated, drilled shaft foundations have been used as scour countermeasures; at some sites, such shafts have been extended to depths of 45 m or more. Gabions have been used on a limited number of sites, as have Reno mattresses. On the Verde River, very large gabions more than 3 meters long have been used; vinyl coatings have been applied to the wire baskets to prevent/retard corrosion and abrasion. At many of the sites where bridge retrofits or countermeasures have been used, the bridge foundations consisted of spread footings founded at shallow depths (about one-third of which had been built on bedrock) and piles with less than 5 meters of **embedment**. In addition to the countermeasures listed previously, timber pile flow retarders and fields of jacks have been used in Arizona, but to no significant extent. In the 1950's, sacked soil cement "riprap" was tried but (for unknown reasons) soon fell into disuse. Speculatively, it is possible that a lack of adequate moisture for effective hydration of the sacks may have been a problem.

A very common problem in Arizona, according to ADOT engineers, is gravel mining and consequent channel degradation. Scour at piers where streams flow at large skew angles to rectangular pier axes has been a serious problem. For example, in 1993, severe scour had occurred in Yuma at a bridge over the Gila River as a result of flow at a large skew angle, with accumulation of debris and resultant scour around piers. Stream meandering and lateral shifting also was said to be a serious problem at bridge sites in Arizona. Scour and erosion in rock was not a common problem at bridges in Arizona, but a few instances of rock delamination and exfoliation had been noted (for example, in the Moenkopi sandstone). Several previous scour assessment reports were provided by ADOT engineers.

### **7.6.1 Pima County Bridges**

Conversations with engineers from the Pima County Department of Transportation and Flood Control District indicated that scour countermeasures had become a focus of attention after a flood in September and October 1983, in which banks on some streams had shifted 60 to 120 meters and 14 bridges had collapsed. The Santa Cruz River had discharged more than 53,000 cfs during that event, in contrast to a design discharge on the order of 30,000 cfs. Many of the older bridges in the county had been founded on spread footings located 4 to 5 meters below the stream bed; currently used scour evaluation equations would have predicted as much as 6 meters of scour at those sites as a result of the 1983 event. As much as 120 meters of lateral shifting and bank erosion had occurred at the west bank of the Santa Cruz River at the Ina Road bridge. A pier had been lost at the Avra Valley Road bridge over the Santa Cruz River downstream from the Ina Road bridge. The bridge had sagged but not collapsed, and a "needle-beam" pier supported on drilled shafts had been constructed to restore support for the bridge at the location of the lost pier.

In the 1983 flood in Pima County, common bank and abutment treatments had failed, including "rail and rock" (railroad rails driven to support welded wire fabric enclosing dumped riprap), rock-filled gabions, and dumped riprap. However, soil cement treatments survived even when flow had entered around the edges of the treatments and had eroded cavities behind the sloping soil cement wedges. Typically, soil cement treatment are built in layers about 3 meters wide, with a steep slope on the protected bank/abutment and a steep face on the treatment.

A flood in 1993 had caused the second highest flow rate on record; the 1993 flood lasted longer than the 1983 flood and volume of flow was higher than in 1983. In contrast to the damages of more than \$ 100 million in 1983, the 1993 flood caused only \$ 13.9 million in damages. The reduction in damage was attributable to the use of soil cement on the stream banks in Pima County; on Rillito Creek in particular, unprotected reaches of stream bank retreated tens of meters between protected sections. Bridges

built since the 1983 flood performed well in the 1993 flood; most of the newer bridges in Pima County had been founded on drilled shafts embedded 18 to 25 meters below stream bed level. Soil cement had been used for floors under bridges, rather than concrete. Pima County engineers emphasized the importance of "toe-downs" at the ends of soil cement floors and grade control structures; the soil cement was extended down about 3 m at the ends of treatments in straight reaches, and about 5 m at the ends of treatments on the outsides of bends. The design and construction of bank protection/scour countermeasures has been described in a paper "Recent Flood Damages and Bank/Scour Protection Measures at Bridge Crossings in Southeast Arizona," by Osmolski and Karim. Soil cement treatment designs had been based on a physical model study done for Pima County by Simons & Li in a large flume facility at Colorado State University. That study had shown that end or edge effects were important to the success of soil cement treatments, as were the design discharge and energy line gradient through the protected reach.

Additional scour and bank erosion countermeasures under consideration by the Pima County engineers included the use of permeable jetties consisting of polyester strap webbing supported by piles extending about 3.5 m above the stream bed or bank; the support piles are to be driven 7 to 8 m below the surface and to be about 6 m apart. The polyester straps would be spaced about 35 cm apart vertically and horizontally. Three to five piles would be driven for each jetty, and as many as 30 or more jetties would be installed along the outsides of long bends in local streams such as the Santa Cruz River, in control reaches as much as 450 meters long. The jetties would be oriented at 45 to 60 degrees to flow direction.

The success of soil cement treatments in the Pima County area could be due in part to the very silty surficial soils in that area; when dry, those soils show very high shear strength. Flood events on area streams tend to be of rather short durations so that stream banks seldom become saturated during floods; when the silty soils become saturated, they show severe loss of strength and erode badly if subjected to significant scour stresses or seepage outflow.

A major problem in the Tucson/Pima County area has been sand and gravel mining on area streams, and consequent stream degradation. The City of Tucson has purchased mineral rights to much of the stream bed areas within city limits on streams that have shown high propensity to degrade/scour.

#### **7.6.2 I-10 Gila River Bridge Southeast of Phoenix**

On 17 June 1996, the I-10 bridge over the Gila River, at about mile 170 southeast of Phoenix, Arizona, was examined. At this site, scour countermeasures included the use of soil cement, groins and spur dikes. The bridge had been equipped with a spur dike on the south side of the channel, on the floodplain, protected by soil cement. The approach spans of the structure consisted of piers with solid rectangular supports with about 1.5 meters of clearance between the bottom of the bridge girders and the floodplain surface, south of the main structure. The surface of the floodplain was covered with deposits of fine silty sand and silt. Thin layers of silty sediments had accumulated over the sand in the stream bed.

#### **7.6.3 Highway 587 Gila River Bridge**

The bridge that carries Arizona highway 587 over the Gila River was examined on 17 June 1996. This structure, about three kilometers to the east of the I-10 bridge over the Gila River, consisted of two parts: a two-span bridge that resembled a box culvert, located several hundred meters south of the main span; and the main structure. The arrangement appeared to cause flow at low discharge to occur through the small two-span bridge and through the low-flow channel of the main bridge. The main thread of the Gila River flows under the larger bridge. The surficial soils at the site consisted of fine sands with a slight amount of silt and possibly a trace of clay-size particles. The sidewalls of the stream channel were virtually vertical, and exhibited very thin layering, with occasional layers of coarse sand. The dry strength of the layer that appeared to contain the highest percentage of fine particles was only moderate. The AZ 587 bridge over the main channel of the Gila River was a multiple-span structure. A bituminous binder had been applied to the soil on the shoulders of the abutments of the small two-span bridge, apparently to retain the soil particles.

#### **7.6.4 Highway 87 Gila River Bridge near Olberg**

On 17 June 1996, the bridge for Arizona highway 87 over the Gila River near Olberg, Arizona, was examined; this site was about 12 kilometers to the southeast of the I-10 bridge over the Gila River. At this bridge, the left descending bank of the stream under the left (southwest) abutment had been covered with large rounded boulder-size riprap, and the riprap had been secured with heavy gauge welded wire fabric. This application appeared to be typical of riprap retained by welded wire fabric as a bank protection measure/scour countermeasure in Arizona. The riprap at this bridge consisted of large rounded boulders and cobbles of igneous rock. Undercutting of the soil cement at this site is typical of situations where the edges of a treatment are the most vulnerable parts of the protection. In other words, at sites where flow can enter a bank behind or beneath a soil cement layer, scour can be concentrated and occur in conjunction with seepage outflow to cause undermining or outflanking.

The surficial soils on the bed of the stream at this site consisted of coarse sand and small gravel while most of the soil on the banks consisted of fine silty sand in very thin layers, laminated between thin layers of sandy silt. The soils in the bank had sufficient dry strength to stand on almost vertical slopes throughout much of the length of the channel at the bridge site. Flow apparently deflected around the pier closest to the northeast abutment removing 4 to 5 meters of soil laterally and had left a deposit of very coarse sand and gravel near the pier.

#### **7.6.5 Gila River Indian Reservation Bridge**

On 17 June 1996, a small bridge over a branch of the Gila River was examined; this bridge carried a tribal roadway on the Gila River Indian Reservation, just to the west of the bridge for AZ 87, over the Gila River. A spur dike had been constructed on the right descending bank just upstream of the bridge of pieces of basic igneous rocks of various sizes and shapes. The rock apparently had been dumped to form the spur dike. Railroad rails had been driven into the stream bed just downstream from the bridge. The rails had been driven to retain a welded wire fabric which was intended to retain the rounded igneous riprap. The riprap was present upstream from the structure and under the upstream half of the abutment, but downstream from the centerline of the bridge, the riprap was not visible. The missing riprap most probably had settled down through the sandy bank soil during flood events because no filter or geosynthetic separator had been provided under the rock. No evidence was found to indicate that the rock had been scoured and transported downstream. The steel H-pile bearing piles under the south abutment were exposed under the downstream half of that abutment by removal of embankment fill and bank soil. At the structure, the piers of the bridge were aligned at a high skew angle to the direction of flow indicated by the channel shape and sediment deposits on the bottom of the stream. Almost half of the flow cross-section would have been ineffective because of the high angle of attack of the flow on the long, solid wall piers.

#### **7.6.6 Santa Cruz River Bridges South of Tucson**

On 17 June 1996, the team reviewed two bridges across the Santa Cruz River south of Tucson, Arizona. One of the bridges carried an access road westerly to San Xavier Del Bac Mission and the other bridge (a twin bridge) carried I-19 southeast from Tucson to Nogales, Mexico. The soil in this bank possessed sufficient dry strength to stand on nearly vertical faces, approximately 3 to 4 meters high. The soil was very silty and superficially resembled a midwestern loess. The upper portion of this bank showed some stratification, suggesting that the fines content was higher in the upper meter of the deposit. The nearly vertical banks of the Santa Cruz River extended for kilometers upstream from the bridge site. The left descending bank had shifted laterally at the access road bridge to the southwest of the I-19 bridges. The access road bridge originally had been carried on four solid rectangular piers between the northeast abutment and the left descending bank. Four cylindrical hammerhead piers had been constructed to carry additional spans of the bridge to the southwest of the original structure.

The left descending bank at the bridge had been treated by building a soil cement face at the abutment. A culvert had been built through the soil cement to carry runoff from the area to the southwest

of the access road into the channel on the left descending bank just downstream from the access road bridge. Soil cement had been applied to the left descending bank at the access road bridge, between that bridge and the I-19 bridges, and at those bridges. Very minor indications of local scour were present around the cylindrical piers on the overflow area between the original bridge and the left descending bank. A scour hole was apparent around the pier closest to the left descending bank near the southwest abutment of the access road bridge.

The right descending bank of the stream at the right (northeast) abutment of the access road bridge had been treated with soil cement, as had the left descending bank. The soil cement extended up over about one-half the height of the abutment fill slope. No distress was noted in the bank above the soil cement treatment, or in the soil cement itself. Minor accumulations of debris were observed on the upstream faces of the I-19 bridge piers closest to the right descending bank. None of the other piers of the bridges showed any significant accumulations of debris and the scour holes around the piers (on 17 June 1996) were only about 0.5 m deep.

On the right descending bank at the upstream end of the soil cement treatment upstream from the I-19 bridges, the soil cement had deteriorated and had been eroded slightly. No such deterioration was noted on the left descending bank. Most of the lower banks and bed of the stream were covered with fine to coarse sand with occasional lenses of gravel as much as 6 cm in dimension. The rock in the hillside above the right descending bank appeared to be extrusive igneous rocks. The upstream I-19 bridge pier closest to the right descending bank had been furnished with a soil cement apron above the foundation top; the apron extended 1 to 2 meters out from the circumference of the pier. At no other pier was a soil cement apron detected.

At the access road bridge, the upstream side of the right (northeast) abutment on the right descending bank had been treated with railroad rails driven to retain welded wire fabric over riprap. The treatment extended along the base of the abutment fill. The base of the right abutment fill under the access road bridge had been retained with a steel sheetpile wall. Apparently, the sheetpiles had been driven to act as a cantilever wall to retain the fill.

#### **7.6.7 Rillito Creek Bridges Northwest of Tucson**

On 18 June 1996, three bridges over Rillito Creek northwest of Tucson, Arizona, were examined; these bridges carried (listed from east to west) a railroad, an access road, and I-10. The creek enters the Santa Cruz River a short distance downstream (northwest) of these bridges. A number of bank protection/scour countermeasures had been or were being constructed at these bridges. Welded wire fabric and riprap treatment was used on the right descending bank of the creek between the railroad bridge and the access road bridge with steel H-piles used at vertical cantilevers. The lower portions of the bank below the H-pile lines were covered with riprap that was retained with welded wire fabric.

Additional foundation elements were being constructed at the right abutment of the railroad bridge, under the wingwalls of the abutment, on the right descending bank. New supplemental foundation elements were under construction just downstream from the right abutment of the access road bridge. Sheetpile encasements had been built around the two southernmost piers of the railroad bridge. A soil cement treatment was apparent on the right descending bank of the creek upstream from the railroad bridge. Very large extents of bank retreat had occurred at this site in the 1983 flood; upstream from this site, an area of almost 20 acres had been lost from a bank that had not been treated with soil cement, in the 1993 flood.

New foundation footings were being constructed adjacent to the existing footings of the access road bridge in June 1996. A supplemental foundation was being built to the east of the southernmost pier.

Water flow from the area upstream from the south abutment of the access road bridge had formed a gully just upstream of that abutment. The lack of flow features on the soil surface indicated that subsurface flow and emergent seepage had formed that gully. Gully formation in Arizona occurs very frequently by subsurface water emerging from the downstream face of an incipient gully; a headcut forms

and migrates upgradient as a result of the action of the emerging seepage. Arroyo formation is an important component in shaping the Arizona landscape.

Soil cement had been applied to portions of the right descending bank near the abutment of the I-10 bridge over Rillito Creek and to the left descending bank between the access road bridge and the I-10 bridge. The bridges at this site were slated for additional bank protection and scour countermeasures.

#### **7.6.8 Ina Road Bridge over Santa Cruz River**

On 18 June 1996, the Ina Road bridge over the Santa Cruz River northwest from Tucson, Arizona was examined. The Ina Road bridge, west of I-10, had been about 105 m long before the flood in autumn 1983 when the west or left descending bank had shifted laterally almost 120 m. The Ina Road bridge was reconstructed to a total length twice its original length in 1984 by building a new section of bridge on deep foundations to the west of the original structure. Funding limitations then had precluded comprehensive bank protection at this site. Some scour and erosion had occurred on the left descending bank in a flood in 1990, prompting placement of rubble for erosion protection just upstream from the left abutment. The left (west) abutment of the bridge was eroded in a major flood in 1993. A sand and gravel extraction operation about 400 meters downstream and northeast of the bridge had caused channel degradation; a headcut had migrated upstream and had impinged on the left descending bank just downstream from the bridge during the 1993 flood. To counteract scour of the left descending bank and left abutment, soil cement treatment was applied there in 1995-6. A soil cement floor was built under the bridge at that time to protect against local scour around piers and to serve as a grade control structure to retard degradation attributed to the sand and gravel mining downstream.

The right and left banks both had been subjected to impingement of sustained flows from the wastewater treatment plant during the construction of the soil cement floor and other countermeasures at this site. A soil cement floor had been built adjacent to the left abutment and around the first pier east of that abutment; the downstream edge of the soil cement floor had been undercut to a depth of about 0.6 m, between the left descending bank and a longitudinal dike that had restricted flow temporarily to the area near the left bank. The right descending bank also had been undercut by the sustained flow from the wastewater treatment plant.

#### **7.6.9 Santa Cruz River Avra Valley Road Bridge Northwest of Tucson**

On 18 June 1996, the Avra Valley Road bridge over the Santa Cruz River northwest from Tucson, Arizona was examined; this bridge is only a short distance west from I-10. In 1983, the westernmost pier of this bridge had been washed away and the bridge superstructure had sagged but not collapsed over the location of the lost pier. To provide support for the damaged bridge, two shafts were drilled on the lateral centerline of the lost pier, outside the edges of the existing bridge, and a precast, prestressed concrete I-beam had been installed over those shafts to lift and support the sagging superstructure. Soil cement treatments were built on both banks and large riprap was placed upstream from the left abutment to prevent scour there. Flow is constricted at this site by a large hill on the west (left descending bank) and by the I-10 embankment to the east of the right descending bank. A soil cement levee is to be built over the right descending bank to provide further protection for I-10. The bridge crossing at this site is only about 100 m wide.

The bed of the stream at this site was covered with extremely fine micaceous silty sand and sandy silt. A debris accumulation and volunteer trees and brush were evident against the shaft under the upstream end of the I-beam of the replacement structure. Very little debris had accumulated around the downstream shaft of the replacement structure, and local scour at that shaft appeared to have been only about 30 to 40 cm. The scour hole at the upstream shaft was 60 to 70 cm deep. Debris and growing trees were also evident at the upstream end of the second pier. The right descending bank had a soil cement treatment. The edges of the soil cement layers had been exposed and eroded just upstream from the bridge.

A hill of extrusive igneous rock and detritus was just to the southwest of and upstream from the Avra Valley Road bridge. This hill caused serious flow constriction at the bridge. Large riprap were

placed on the left descending bank just upstream of the bridge. The appearance of the riprap indicated that some riprap had been removed right at the corner of the abutment. No riprap was present along the upstream third of the length of the vertical wall of the west abutment; farther downstream, small riprap was noted in place along the abutment wall, and large riprap was in place on the bank downstream from the abutment.

To the northwest and downstream from the Avra Valley Road bridge over the Santa Cruz River, a small bridge (No. 240) carried Trico-Marana County Road over the Santa Cruz River just to the west of I-10. In a major flood in 1983, the river had migrated laterally into the right descending (northeast) bank just upstream from the bridge. To counteract this demonstrated tendency to migrate, the right descending bank was protected with soil cement and other measures. The bridge piers and abutments were founded on pile caps, but the bearing piles penetrated to only shallow depths. In a second major flood in 1993, sediments from upstream areas (particularly from along Rillito Creek) were deposited in the bridge opening as the stream avulsed and cut a new channel to the northeast of the bridge through the approach embankment east of the structure. The bridge opening subsequently was cleared to restore flow to the original channel, and soil cement was applied to the right descending bank and right abutment to prevent scour there. A quarter-ellipse spur dike was built on the left descending bank just upstream from the bridge.

#### **7.6.10 Arizona 95 Colorado River Bridge at Parker**

On 18 June 1996, the Arizona 95 bridge over the Colorado River at Parker, Arizona was examined. The roadway continued into California as California State highway 62. The Arizona 95 bridge is just downstream from a railroad bridge which is considerably older than the highway bridge. Riprap had been placed around the piers closest to the Arizona (left descending) bank, and on both banks; additional drilled shafts had been built upstream and downstream at the three piers closest to the Arizona bank to augment the original piers that had been affected by scour. Steel H-piles had been driven to provide a vertical face under the west (California) abutment. Below the steel H-piles, very large angular riprap was present on the right descending bank. On some of the original columns of the three piers nearest the Arizona side, concrete had deteriorated and spalled to expose steel bearing members in the centers of the columns. At the deteriorated columns steel cables were fastened diagonally across the column group apparently to provide tension bracing to the group. Some of the deteriorated columns had been fitted with steel casings, as had some of the columns on other piers.

The water level in the river on 18 June 1996 appeared to be slightly higher than usual, as indicated by slightly submerged vegetation and appurtenant structures.

### **7.7 CALIFORNIA**

In California, assistance was provided by Mr. Bill Lindsey, Ms. Julie Austin, Mr. Paul Davies, Mr. Steve Ng, Mr. John Rizzardo and Mr. Kevin Flora, of the Bridge Hydraulics section, California Department of Transportation, P. O. Box 942874, Sacramento, CA 94274-0001.(916-227-8041)

Conversation with Mr. Lindsey and Mr. Ng indicated that sand and gravel mining for aggregate production is a major cause of stream degradation and consequent problems at bridges. Riprap is the most frequently used scour countermeasure; a filter layer commonly consisting of a geosynthetic filter is required under any riprap treatment as a standard item in bridge construction specifications. New bridges and foundation renovations for older bridges often include large diameter drilled shafts that obtain support well below predicted scour depths. At some sites, sheetpiles have been driven around groups of foundation bearing piles to provide protection against scour. Debris accumulations at piers have not been noted as causes of significant scour except in forested areas and on large rivers that have migrated laterally along long reaches of bank. Limited use has been made of innovative bank protection/scour countermeasure treatments such as gabions, Reno mattresses and articulated concrete mattresses. Many designers prefer structural modification/design against scour, so that no reliance must be placed on scour countermeasures. More than 15,000 bridges have been built over water in California for highways, and expenditures of about

\$ 40 million per year have been indicated over a ten-year period to correct scour-related problems at some of those bridges.

#### **7.7.1 I-5 Sacramento River Bridge and I-880 Guadalupe River Bridge near San Jose**

Two of the most interesting examples of scour countermeasures or related situations given by CalTrans engineers were the I-5 bridge over the Sacramento River, and the I-880 bridge over the Guadalupe River near San Jose, California. At the Sacramento River site, floating fenders had been installed on bridge piers and had functioned satisfactorily for years without any problems. Three-pile dolphins had been driven into the river bed upstream from the bridge piers. When one of those pile dolphins had failed, debris accumulated in large quantities on the fender and pier immediately downstream and had interfered with the vertical movement of the fender, as well as causing problems of possible bed scour around the pier. When the dolphin was replaced, the fender remained clear of debris; apparently, debris is deflected or split by the dolphin so that it does not accumulate on the fender and pier. At the Guadalupe River site, gabions, riprap and Reno mattresses have been used to provide bank protection and an articulated concrete mattress has been installed across the channel width and around bridge piers. In 1995, a flood of approximately 25 years recurrence interval had occurred at the site. Some slight deformation of the articulated concrete mattress had occurred as well as some slight distress in the gabions on the banks.

#### **7.7.2 I-80 Ulatis Creek Bridge in Solano County**

On 19 June 1996, the I-80 bridge over Ulatis Creek near Vacaville in Solano County, California was examined. The principal difficulties at this site, according to CalTrans engineers, were scour of the stream bed around piers founded on piles with less than 5 m of embedment, removal of soil and lateral support for piers on the banks under the bridge, and excessive length/diameter conditions for the pier columns (with resultant excessive vibration). At this site, in winter 1995-6, a check dam had been built with steel sheetpiles downstream from the east-bound (downstream) bridge, to retard or prevent channel degradation where the bearing piles under the piers had been driven to shallow depths below the stream bed. When the original structure was widened, additional piles had been driven at each pier. Each pier originally had consisted of a four-pile bent; to supplement the original piles, one new pile was driven on the median side of each bent and four new piles were driven on the shoulder side of each bent. Because of concern about possible removal of support around the piles in the stream channel, the new piles were driven to greater depths than the founding depths of the original piles. The bearing piles under the piers were Raymond step-taper piles consisting of light gauge telescoping sections of casing. The step-taper piles are driven with an inner mandrel, the mandrel is removed when the pile has reached the appropriate depth/resistance, and the casing is filled with concrete. Steel reinforcing bars are inserted from the surmounting columns into the concrete-filled casing for twelve feet or to a depth equal to the length of the pile divided by four, whichever is greater. The piles are surrounded by cylindrical concrete columns that are joined under the bridge superstructure by cap beams to form piers. Rock-filled gabions had been placed in two stepped tiers on the lower part of the southwest (right descending) bank, with a rock-wire mattress over the middle height of the bank, and sandbags above the mattress to hold down the upper edges of the wire fabric. The gabion/mattress treatment was considered to be an emergency measure likely to last no longer than the winter months. Plans were being formulated to build a concrete retaining wall to protect both bridges. A secondary pile-crossbeam structure had been built at midheight of the bank as part of an old bridge.

The surficial soils at the I-80 bridge over Ulatis Creek consisted of layered alluvial soils with a relatively high fine particle content and high dry strength. The lower portion of the left descending bank had been eroded to very steep inclinations. It was observed that the soils of the lower part of the left descending bank between the twin bridges and under the eastbound bridge had numerous vertical tension cracks in the bank soils. Cavities in the bank faces indicated the effects of emergent seepage. Seepage emerging from the more pervious alluvial layers in the banks apparently had removed soil, exposing the lower parts of the bridge pier columns and portions of the Raymond step-taper bearing piles. Near the



lower edge of the abutment pile cap beam of the westbound bridge, on the left descending bank; flow out of the bank soils had eroded a cavity exposing the bearing piles under the abutment. Similar erosion channels and cavities had been cut under the abutment of the eastbound bridge, on the right descending bank. Examination of the banks upstream and downstream from the bridge indicated that the flow section was much wider at the bridge. Retreat of the banks caused by emergent seepage erosion appeared to be a major factor in widening of the stream at the bridge. The irregular planform and topography of the bank would not have been caused by flow deflected from the piers or constricted at the bridge opening. Water apparently had entered the banks at the bridge abutments and had seeped vertically until changes in hydraulic conductivity between soil layers had caused the water to migrate laterally and out of the bank faces under the bridges. No such gulying, cavities or distress was detected on the banks upstream and downstream from the bridges, and the area between the bridges did not show nearly as much bank retreat as the banks under the bridge decks. The approach slabs adjacent to the abutment over the left descending bank for the west-bound bridge showed some subsidence relative to the bridge, indicating possible loss of soil under the slabs at that location. Such soil loss would have been consistent with the evidence of water leaking downward under the abutments and emerging from the banks under the bridges. Lack of bank retreat on the lower portions of the banks between the bridges was an indication that the removal of soil from the banks was not caused mainly by local scour or contraction scour effects.

### **7.7.3 I-80 Sweeney Creek Bridge in Solano County**

On 19 June 1996, the bridge for I-80 over Sweeney Creek in Solano County, California was examined; this bridge is approximately 9.5 km east of the Ulatis Creek bridge, near Vacaville. Riprap had been placed on the banks and bed of Sweeney Creek. Riprap had been placed on the right descending bank up to the bridge seat at the abutment and around the piers at this site. Some of the columns of the bridge piers obviously had been repaired by covering the lower parts of the columns with mortar, apparently due to deterioration or spalling of the concrete of the columns. Additional columns and supporting piles had been built at this bridge when the highway was widened; the original columns of the bridge piers apparently were repaired and joined by lateral beams near the tops of the riprap pieces on the channel bed. Concrete had spilled onto the tops of some of the pieces of riprap at the sides of the lateral beams installed near the bases of the columns. At the pile cap beams under the bridge abutments, corrugated metal sheeting had been erected vertically to cover the exposed tops of Raymond step-taper bearing piles under the abutments. The riprap appeared to be a dark igneous (or slightly metamorphosed) rock, and the gradation of the rock included pieces from 20 cm in dimension to pieces 1 meter in dimension. The individual pieces of rock were very angular and blocky, and were black to very dark brown. Some of the pieces of rock showed pronounced banding, suggesting metamorphism or deposition of secondary minerals in fissures in the original rock fabric. The riprap had been concreted near the upstream end of the lateral beam/pile cap around the original piles under the eastbound lanes.

Lateral beams connected the piles/columns of the original piers; piers on both sides of the channel had been connected with cap beams. The absence of soil around the bearing piles under the abutment seat beams suggested that soil had been eroded by seepage emerging from under the abutment beams, and/or scour during high water events. Examination of the terrain around the bridge suggested little potential for contraction scour; the floodplain elevation was virtually equal to the elevation of the bridge deck so floodplain flow would have overtopped the structure. The piers under the bridge would not likely deflect flow sufficiently to cause erosion and scour at the tops of the abutment fills, but scour at the toes of the abutment fills could have caused shallow slides in the fills, and expose the tops of the piles under the abutments.

### **7.7.4 CA 128 Apricot Draw Bridge near Winters**

On 19 June 1996, the bridge that carries CA 128 (Grant Avenue) over Apricot Draw just west of the city limits of Winters, California was examined. Very large riprap as much as 1 meter in dimension had been used upstream of this bridge to protect the stream channel and banks. The abutments of the bridge were supported on vertical concrete walls and the channel bottom through the walled section under

the bridge was protected with grouted riprap. Grouted riprap had been placed on the bed of the draw just downstream from the bridge. Standard riprap was placed on the north (left descending) bank of the stream, immediately upstream from the bridge. Flow occurred at a severe skew angle to the bridge opening. A check dam had been built to retard channel degradation at this site; the dam was built between the downstream wingwalls of the bridge. No piers were present. The riprap at this site included rock of igneous origin; pieces varied in size from about 10 cm in dimension to over 1 meter in dimension.

Upstream from the bridge, the bed of the stream was covered with sediment; the gradation of the sediment became progressively finer with proximity to the bridge, suggesting that backwater effects reduced the transport capacity of the stream there. At a point approximately 8 to 10 meters upstream from the bridge, the sizes of the bed particles changed drastically; from that point into the bridge opening, only very large pieces of rock were present on the bed. The flow apparently accelerated into the constricted section, and all particles smaller than cobbles appeared to have been transported through the bridge opening.

Cavities and undercut zones suggested that emergent seepage had contributed to the bank erosion there, although the dominant mechanism appeared to be scour on the outside of the bend downstream from the bridge. The banks appeared to consist of mixed alluvial soil strata including some zones rich in fines (clay and silt particles). The bed of the stream was covered with coarse soil including medium to coarse sand, gravel, cobbles and boulders.

#### **7.7.5 I-505 Cache Creek Bridge in Yolo County**

On 19 June 1996, the I-505 bridge over Cache Creek about 16 km west of the city of Woodland, in Yolo County, California (about 45 km west of Sacramento) was examined. The right descending bank downstream from the north-bound bridge (built in 1956) had been protected with large riprap. Under the south abutment of the north-bound bridge, the upper part of the abutment fill had been protected with a sackrete layer. Riprap had been placed under the upper part of the south abutment fill at the newer (1977) south-bound bridge, to the west of the original bridge. The right descending bank at this site consisted of two levels, an upper slope and a lower slope separated by a horizontal berm about 8 m wide near the midheight of the fill. The piers of this bridge consisted of solid rectangular sections with rounded ends, that extended for the entire width of the roadway under each bridge. The piers under the original bridge were not oriented at the same angle to the roadway as were the piers under the newer bridge on the west. Apparently, an effort had been made to align the newer piers with the flow in Cache Creek. Accumulations of debris were present at the upstream ends of the piers of the newer bridge to the west (upstream) of the original bridge. Concrete diaphragm walls had been built to connect the piers of the newer and original bridges. The connecting diaphragm walls apparently were intended to cause a transition in flow to bring floodwaters under the original bridge at a reduced skew to the bridge piers.

Wideflange needle beams had been inserted through the piers of the original bridge (northbound lanes), parallel to the flow of traffic and perpendicular to the axes of the pile bents. The needle beams extended laterally from the faces of the piers about 2 meters; additional bearing piles had been driven outside the areas of the original pile bents to furnish supplemental support to the piers, and those piles supported the needle beams. The additional piles had been driven more deeply than had been the original piles. The tops of the needle beams and new piles had been concreted to form a thick apron around the base of each of the piers of the northbound bridge. Accumulations of debris were noted on the faces of the new bridge for the southbound lanes; however, scour holes around the new piers were generally less than 1 meter deep. The northern half of the stream channel was the low-flow section. The bed of the stream was covered with cobbles and gravel with a slight amount of coarse sand; the gravel had been deposited in bars between the three southernmost piers in the channel. Between the two northernmost piers of the bridge, the low-flow channel was deeper and the channel bottom could not be examined. At the third pier from the north abutment of the original bridge, concrete waste had been piled adjacent to the south side of the needle beam structure that had been built around the base of the pier. Large and deep scour holes had formed around the needle-beam aprons around the bases of the original piers apparently as a result of the obstruction of flow locally around the bases of those piers. These scour holes were widest and deepest

around the three northernmost piers of the original bridge. Scour holes were present around the upstream ends of the second and third piers from the north end of the newer 1977 bridge for the south-bound lanes. Piles under an abutment are considered the number 1 pile bent, according to California numbering convention. The channel at this site was located primarily between piers three and four from the north end of the bridge. The bed of the stream had been about 4 meters higher in 1956 than it was in June 1996 when the site was examined; degradation had been caused by adjacent gravel mining upstream and downstream from the bridge.

#### **7.7.6 I-880 Guadalupe River Bridge in North of San Jose**

On 20 June 1996, the I-880 bridge over the Guadalupe River north of San Jose, California was examined; this bridge is just south of the San Jose International Airport. Construction of bank protection and channel scour countermeasures had been done at this site as part of the Guadalupe River project managed by the U. S. Army Corps of Engineers. Several kilometers of stream bank and channel were included in this project under three contracts for bank and channel work. As part of the first contract, work had been done at the I-880 bridge, including extension of the substructure for scour protection in the event that scour damaged an articulated mat that was to be the primary scour countermeasure.

The bridge site is located in the Santa Clara Valley, a broad alluvial basin underlain by rock strata that have been folded and faulted extensively and eroded after regional uplift. Sandstones, shales and mudstones were deposited in Cenozoic times, but were eroded during the Pliocene and Pleistocene, and covered with gravel, sand and finer sediments. Surficial deposits and valley fill cover the bridge site to depths in excess of 300 meters. The top 45 to 50 meters of the alluvium is an unconfined aquifer; water flows primarily in sand/gravel layers and lenses, and locally is perched on fine-grained silty clay and clayey silt layers. A fine-grained aquitard is located below the unconfined aquifer. The near-surface deposits include fluvial sands, sand/gravel lenses, and clayey/silty sands and gravels, as well as the younger Bay Mud. The younger Bay Mud is a normally consolidated clay to sandy clay containing sand lenses; the upper exposed zones of the Mud have been desiccated and have high dry strength. Alluvial sand and gravel layers are present in stream channels; clay layers are present within the coarse alluvium. At the bridge, gabions, Reno mattresses, an articulated concrete mattress and three grade control structures have been built; in 1995, a flood with discharge between 9,000 and 10,000 cfs (approximately 25-year recurrence interval) occurred. The 100-year flood at the site has a discharge of about 18,000 cfs.

The articulated concrete mattress was installed at this site on the lower bank and channel bed, with a gabion mattress on the bank above the concrete mattress. Coarse sediments had deposited over the articulated concrete mattress on the right side of the channel. Debris had accumulated against the upstream nose of the single long central pier. The left descending bank had been covered with a gabion mattress on the lower bank below an access road at about midheight of the bank under the bridge; gabions formed a low vertical face above the road, and the upper part of the bank (the abutment fill) was covered with a gabion mattress. Three grade control structures consisting of vertical concrete weirs, each cut with a rectangular notch to pass low flow, had been built at this bridge. The middle structure had been built about 3 m upstream from the downstream end of the single pier. The downstream grade control weir was about 15 m downstream from the downstream edge of the bridge structure.

The articulated concrete mattress appeared to have subsided locally just downstream from the weir, on both sides of the low-flow channel. The downstream end of the articulated concrete mattress had been placed on a plunging slope to provide a transition to the unprotected channel bed. The articulated concrete mattress showed little distress. Downstream from the bridge, young trees as much as 1 m high and seasonal vegetation had rooted and grown through the cavities between blocks of the mattress. Sediments had accumulated over the mattress and vegetation had rooted in the interstices of the mattress from the toe of the right descending bank to the edge of the low-flow channel and the end of the grade control weir.

The low-flow channel between the left descending bank and the center pier of the bridge is aligned with rectangular notches cut in the grade control weirs. Measurement of the depth to the mattress just downstream from the edge of the cut in the middle grade control weir showed that about 0.73 m (2.4

ft) of water covered the mattress at the point of measurement. A shallow vee-shaped depression was found in the mattress just downstream from the rectangular cut in the weir.

Grout had been applied over a joint between panels of the articulated concrete mattress; the seam was oriented perpendicular to the bridge and parallel to flow. The grout covered the cables that tied the mattress panels. On the right descending bank, approximately 10 m upstream from the edge of the bridge, just below the gabion mattress; one of the cables joining the blocks of the mattress was exposed.

The sediments on the bed of the channel and on the articulated concrete mattress consisted of subangular pieces of gravel from 2 cm to 8 cm in dimension, approximately, with occasional larger cobbles, and some sand. Most of the sediment was relatively clean, with little sand in the deposit. An accumulation of debris was noted at the upstream end of the bridge pier. The banks upstream from the bridge appeared to consist of stiff gray fine-grained soil, apparently the desiccated top zones of the younger Bay Mud. The dry strength of the bank soil was high. Lenses of small to medium gravel were noted in the clay on the bank.

Two cables from adjacent panels of the articulated concrete mattress were joined with a clip. Some rusting and corrosion of the exposed cable had occurred. The cables appeared to have been galvanized on their outer surfaces, and some corrosion was apparent on the exposed metal.

At the upstream edge of the articulated concrete mattress on the left descending bank subsidence appeared to have occurred below the mattress. Small areas of subsidence had been noted just downstream from the downstream grade control weir. Just downstream from the upstream and middle grade control weirs, the surfaces of the mattress at those locations showed shallow depressions, especially downstream from the rectangular notches in the weirs, but the mattress could not be inspected because it was inundated. The mattress was 0.76 m (2.5 ft) below the water surface just downstream from the downstream weir, in the deepest part of the subsided area. On the left descending bank downstream from the bridge but upstream from the grade control weir, effluent was discharging into the stream through an outlet structure. Growth of algae on the outlet apron suggested that the flow contained wastewaters. On the left descending bank of the low-flow channel just downstream from the downstream grade control weir; examination of an exposed threaded anchor indicated that the surface of the mattress had subsided about 15 cm, indicating loss of soil below the mattress. On the right descending bank of the low-flow channel just downstream from the downstream grade control weir, a cavity was found below the blocks of the articulated concrete mattress; i.e., the soil below the geosynthetic filter had subsided, the filter had moved down with the soil, and the cables were holding blocks in air above the geosynthetic filter. The filter cloth, resting on the subgrade, was approximately 40 cm below the top of the blocks and small gravel had fallen through the gaps between blocks to cover the filter in a pile about 7 cm high. A gap was present between the bottoms of the blocks and the top of the gravel. A number of the blocks were suspended over this void. A similar void was noted on the left descending bank under the articulated concrete mattress just downstream from the grade control weir. The geosynthetic filter had subsided 8 to 10 cm below the bottoms of the blocks, and gravel had fallen through the interstices to rest on the surface of the filter. It was impossible to estimate the total amount of subsidence of the soil under the articulated concrete mattress. Fall of gravel through the interstices could lead to deterioration of the geosynthetic filter if further subsidence or other processes caused the mattress to rest on the gravel over the filter. Point loading transmitted to the gravel could cause pieces of gravel to penetrate and tear the geosynthetic filter. The geosynthetic filter was exposed near the edge of the mattress on the left descending bank just downstream from the grade control structure; the fabric was folded and apparently had been dislodged from its original position and configuration on the bed of the channel. The apparent distress in the articulated concrete mattress at this site indicated that use of this countermeasure may be imprudent if the geosynthetic or mineral filter below the mattress is not in intimate contact with the subgrade under the treatment, if the edges of the filter are not secured properly so that no loss of subgrade soil can occur from under the filter. Application of an articulated concrete mattress may be most easily accomplished where the subgrade to be protected is regular in elevation or at least planar, and where treatment edges may be secured easily. Placing and securing such a treatment around a bridge pier may not be feasible for existing piers constantly inundated, or at sites where the subgrade around a pier is extremely variable in topography or soil/rock conditions.

The gabions and gabion mattress slope protection at this bridge appeared to be in good condition when examined in June 1996. No apparent degradation in the treatment was detected. The wire of the baskets did not show corrosion or abrasion, and none of the containment had been lost in the area examined. No significant depressions were detected in the upper planes of the bank protection.

#### **7.7.7 Conn Creek Silverado Trail Bridge in Napa County**

On 20 June 1996, the bridge that carries Silverado Trail over Conn Creek in Napa County, California was examined. One pier had been built on the left descending bank and the second pier was located in the right half of the channel; the existing bridge had been built to replace an earlier structure at this site. Very large riprap as much as 1 m in dimension had been placed along the sides of the west pier in the stream channel and on the bed of the channel between the banks to form a grade control structure just downstream from the bridge. A pier of the demolished bridge that was replaced was located between the two piers of the existing replacement bridge. A deep scour hole had formed around that old pier. A large pipe outlet pierced the abutment wall on the right descending bank, at about the upstream quarter-point of the wall.

A green-yellow mat of dried algae and biological matter covered much of the stream channel at this site. Beneath the biological mat, the bed of the stream was covered with gravel, cobbles and occasional boulders, with little exposed sand; the rock was of igneous origin. Sand and gravel soils were evident in the right descending bank approximately 200 m downstream from the bridge. Lenses of sand-rich sediments were noted in the banks, and the upper parts of the banks contained significant amounts of fine-grained soils.

A number of large corrugated metal pipe culverts were located upstream and downstream from the bridge.

#### **7.7.8 Highway 160 American River Bridge**

On 21 June 1996, the California Highway 160 bridge over the American River was examined. The investigators stopped only briefly to determine if the scour metering board could be used at this site. The bridge was so high that without a boat it was not possible to make scour measurements.

#### **7.7.9 Highway 32 Stony Creek Bridge**

On 21 June 1996, the California Highway 32 bridge over Stony Creek was examined. Gravel mining upstream and downstream from this site had affected the bridge. Several of the pier walls under the bridge had been protected with riprap, and a riprap check dam was in place over the central part of the channel; the check dam/rock weir originally had been constructed for the entire length of the bridge. Training dikes had been built to extend upstream from the bridge, on the east side of the bridge, and downstream of the bridge on the west side of the bridge. The training dikes had been constructed of rails and wire mesh filled with rock. The riprap on the bridge abutments had been grouted above the level of the floodplain; the riprap extended from the grouted abutment slope to the first pier on the left (east) bank. Vertical marks on the piers indicated concrete repair with epoxy along reinforcing bars within piers, for the first four piers on and adjacent to the left (east) bank; the epoxy repair work was the first part of a contract that was not completed.

Areas in the channel were dedicated to gravel mining pits surrounded by berms, about 100 meters upstream from the bridge. A low-flow channel extends from the west to the east immediately upstream of the bridge. In a distance equivalent to the channel length under the bridge, the low flow channel invert drops on the order of 3 m. It appears that at least three active nick points are migrating upstream from where the stream flows under the bridge near the left bank (east) to the right bank (west). The riprap included vesicular igneous rock and other black and gray, blocky igneous rocks.

The incised, well-defined low-flow channel is essentially perpendicular to the bridge. An active gravel mining operation was located in the area immediately downstream of the bridge. Soil stains on the

piers indicated previous streambed and bank elevations. Approximately 2 to 4 meters of degradation is apparent from the reddish colored soil stains, assumed to be oxidized iron deposits. Sand and gravel was weakly cemented to the pier and indicated previous sediment layers. Riprap was placed around all the piers; however, the sill (complete coverage of riprap around and between piers) was located approximately between the third pier from the right bank to the second pier from the left bank. A scour hole had formed around a pier that had been protected by riprap.

A rail-and-wire dike extended from the downstream edge of the abutment for approximately 50 m downstream. The right abutment protection was similar to that of the left abutment.

#### **7.7.10 Yolo County Road 99W Buckeye Creek Bridge near Dunigan**

Buckeye Creek bridge, Number 22C-50, that carries Yolo County Road 99W, near Dunigan, California was examined. This bridge is parallel to I-5 north of Sacramento, California. A parallel railroad bridge had been built in 1934, approximately 20 m downstream. The county bridge was constructed in 1918 and widened in 1949. The original foundations of the bridge were spread footings, but scour problems had developed around and under those footings, so supplemental piles had been driven in the 1960s as a scour mitigation measure. The stream channel was skewed severely to the bridge (approximately 30 degrees). Debris had accumulated between pier columns. The stream was aggrading, as indicated by the gravel deposition pattern near the vertical banks of the stream. Sackcrete walls protect the banks upstream of the highway bridge. The sackcrete wall is undercut on left bank.

The stream bed was composed of small to large gravel. The soils in the banks varied from mixed sand and gravel, to sandy silt on the upper portions of the bank.

### **7.8 MAINE**

Discussions were held with Maine DOT personnel on July 1996 at the DOT offices in Augusta. Maine DOT personnel indicated that riprap is commonly used as part of an original design. Typically a combination of riprap and/or grout bags are used for repairs. One problem faced by maintenance personnel is the installation of countermeasures in cold water. Most of the scour problems in Maine occur at single span bridges with undersized openings or alignment problems.

#### **7.8.1 I-295 Tukeys Bridge in Portland**

An evaluation of Tukeys Bridge on interstate 295 in Portland was conducted on the same afternoon. Tukeys bridge experiences large tidal fluctuations and has a depth of water of 25 feet+-. Plans for placing a grout bag and cable tied block countermeasure were reviewed. The plan was to place grout bags around the outside edge of each concrete seal. Pipes would be placed between bags to the areas under the seals. Grout would then be pumped through the pipes until grout starts to come out of the pipes, indicating that the cavity is full. A concrete block mat/ geotextile mat would then be placed around the center row of piers for an outside dimension of approximately 68 ft. by 185 ft. This option was selected on the basis of potentially lower cost, easier placement of the geotextile, greater placement control and less thickness than riprap. This bridge is a good site for continued monitoring. Due to the tidal nature of the channel, countermeasures will experience continual flooding cycles. Such conditions provide for excellent cyclical testing of the countermeasures.

### **7.9 MASSACHUSETTS**

Assistance was provided in Massachusetts by Mr. Richard G. Murphy (617-973-7558) and Mr. James Sullivan of the Massachusetts Department of Transportation, Room 7341, Massachusetts Transportation Building, 10 Park Plaza, Boston, MA, 02116-3973.

On 15 July 1996, Joe Hagerty met with Mr. Richard Murphy and Mr. Jim Sullivan in Room 7341 of the Massachusetts Transportation Building in Boston. Richard Murphy knew nothing about any

questionnaire or about bridges on Route 63 on Miller's River where concrete filled mats and rock gabions supposedly had been employed. Bridge E-10-2 is the same as Bridge M-28-4 on Route 63 between Erving and Montague. That bridge had been subject to severe degradation when a dam downstream failed some years ago, and sediment upstream from the bridge site was moved down to the site at the same time the channel degraded. Debris and sediments had blocked one of the openings of the two-span bridge, and scour had been concentrated under the other span. The concrete of the pier had deteriorated, and that deterioration was the major problem at the site; hence the plan to replace the bridge rather than to use any countermeasure. Mr. Murphy thought it was possible that an emergency repair had been done using polyethylene bags filled with concrete/grout to make a retaining structure around the pier, with grout injected between the bags and riprap placed in front of and over the bags. He had checked with others in the department, however, and found that the underwater construction manager, the manager of bridge inspections and the bridge maintenance engineer said that the bridge had been earmarked for replacement, and monitoring. Some sheeting had been driven, but no other measures had been taken.

In Massachusetts, whenever riprap is not used, scour repairs typically are made using grout-filled bags with grout between bags. Mr. Murphy stated that no gabions had been used around piers, to his knowledge. Mr. Murphy provided information from divers' inspection activity reports and reports on repairs that had been done at three small bridges in Massachusetts. The bags used in Massachusetts were standard size sakrete bags, much smaller than the nylon bags used in Maine. Mr. Murphy indicated that bags had been used around the pier of a bridge over the North Nashua River where Route 13 crosses the river in Leominster. Undermining of the central single pier of that bridge caused the pier to settle and the bridge to distort. Mr. Murphy said the base of the pier could be reached by wading. The protection is likely to be covered by riprap that was placed over the grout-filled bags. Mr. Murphy stated that no gabion mattress had been used at Leominster; the two-span old stone arch bridge had been repaired because the central pier was being undermined and cantilevered out on rock ledge.

#### **7.9.1 Route 13 North Nashua River Bridge in Leominster**

On 16 July 1996, the Route 13 bridge built in 1872 over the North Nashua River in Leominster was examined. The bridge is a double arch masonry structure with a single central pier. Large rocks were visible on the stream bed, as well as a large sand-gravel bar which had accumulated downstream from the central pier of the bridge. A wide and deep scour hole was discovered in the channel between the pier and the west (right) abutment, between the areas of stream bed that had been protected. An inspection by divers on 9 December 1993 had indicated that the stream bed around the pier and adjacent to the west abutment had been scoured, and a treatment had been constructed. A double row of bags of grout (sakrete bags) had been placed to form a large rectangular enclosure on the bed of the stream, extending approximately twelve feet upstream from the nose of the pier and about forty feet downstream along the sides of the pier. The rectangular enclosure extended about ten feet out from the sides of the pier, which was six feet wide. The bags had been stacked two to three high as needed to form a level top to the enclosure, and then tremie concrete had been placed inside the rectangular enclosure and against the sides of the pier. Bags also had been placed in four rows, three high, on the stream bed adjacent to the right abutment. The bags extended from the right descending bank about five feet upstream from the bridge for a distance of about eighteen feet downstream, to enclose the area of scour under the right abutment, and then concrete had been tremied into the scour hole there.

Just downstream from the bridge, a considerable amount of rock was visible on the stream bed. Approximately 100 yards downstream, the stream narrowed through a slight chute and debris had accumulated on what appeared to be a rock ledge or a grade control structure at that location. Debris had accumulated on the upstream face of the pier, but the accumulation was slight. The bags were visible on the bed of the stream, but the tremie concrete had been covered with riprap, and sand and gravel sediments. The visible bed sediments consisted of sand and rounded gravel, with occasional large rocks. A bar had formed extending out from the right descending bank at a point about 100 yards upstream from the bridge, toward the upstream nose of the pier. The flow was rapid at the time of the examination, as a result of the passage of a tropical storm (the remnant of Hurricane Bertha) on 13-14 July, which had dropped as much as 7 inches of rain in the Nashua River watershed, and local thunderstorms on 15 July. Soundings were



taken along the upstream parapet of the bridge. The treatment appeared to be in satisfactory condition in the as-built configuration.

### **7.9.2 Blackstone River Depot Street Bridge in Grafton**

On 16 July 1996, the Depot Street (MA 140) bridge over the Blackstone River in Grafton, Massachusetts, was examined. The bridge, built in 1925, is a single span structure; the stream bed had been scoured and gabions had been placed over the entire width of the stream between the bridge abutments. Constraints other than scour considerations had precluded any excavation at the site. A small dam was located approximately 100 yards upstream from the bridge and overflow from a pond passes into the stream over a wier about 20 yards upstream from the bridge on the right descending bank. A gabion basket on the bottom of the stream had been dislodged from its as-built position, and one corner of the basket was protruding upward above the water surface, at a point about one-third of the stream width from the right descending bank. Some debris had snagged on the wire basket. Most of the riprap placed along the right descending bank upstream from the right abutment consisted of large, angular pieces of granitic and slightly metamorphosed igneous rocks; a limited amount of rounded pieces of rock also were included in the riprap. All of the rock appeared to be sound and durable.

Review of a gabion that had been distorted and displaced from its original configuration under the downstream edge of the bridge about ten feet from the left abutment indicated that some debris had snagged on the wire basket. It was not possible to wade into the stream to inspect the gabions because of the depth and velocity of flow on 16 July 1996; rainfall from the aftermath of Hurricane Bertha on 13-14 July and from local thunderstorms on 15 July had caused flow to increase in the Blackstone River. A number of the gabion baskets had been distorted and displaced, as could be seen from the bridge. Several of the baskets appeared to have ruptured, and debris had snagged on the wire edges of the baskets. The gabions had been placed over an area approximately fifty feet long (upstream and downstream ten feet from the edges of the bridge), over the entire width of the stream. The gabions were three feet wide and twelve feet long. An undermined zone under the left abutment had been proposed for filling with grout, when the bridge was inspected in 1992, but that area could not be inspected in 1996. When the bridge had been inspected in 1995, soundings were taken under the bridge to determine the elevations of the tops of the gabions, and comparison of those soundings with soundings done in 1992 after the gabions were installed showed little or no settlement of the gabions.

### **7.9.3 Neponset River Dedham Street Bridge in Canton**

The Dedham Street bridge, built in 1936 over the Neponset River in Canton, Massachusetts, was examined on 16 July 1996. This bridge is a seven-span structure supported on six timber pile bents each containing nine piles. When serious deterioration of the timber piles had been recognized, steel columns had been inserted to support the bents. Debris had accumulated to block a significant portion of the channel, when the bridge was inspected in February 1991, but divers removed much of that debris in 1991 and during a second inspection in February 1992. The bridge had been inspected again in February 1993 and January 1994. Scour had been noted around the concrete caps around the piles near the toes of the abutment fills and at the stream bed. Gaps as large as 10 inches were found between the bottoms of the pile caps and the stream bed at the upstream ends of the pile bents. Riprap had been displaced at the toes of the east and west abutments, and erosion had been noted on the fill of the east abutment. Small (3 inches or less in diameter) rounded rock had been placed in light-gauge wire enclosures to cover the lower portions of the abutment slopes and the stream bed between the pile bents. The wire-retained rock extended approximately ten feet upstream and ten feet downstream from the ends of the bridge.

The wire panels were held together with wire spirals and bent wires to form enclosures around and over the rock. Wire spirals were used at the corners of the treatment apparently to anchor the wire enclosures to the slopes and stream bed. The treatment extended about six feet (slant distance) up each fill slope from the concrete caps around the timber pile bents. The timber pile bents located up on the fill slopes close to the bridge seats had not been surrounded by wire-retained rock. Examination of the stream bed showed that the small rock had shifted away from the concrete cap around the pile bent near the toe of



the right abutment fill, and the wire enclosure had been displaced toward the center of the stream as much as six inches, at the top of the enclosure. The wire enclosures had been pulled down and toward the stream all along the edge of the concrete pile cap, and the top wire was missing over the rock at the upstream end of pile bent 5. A small amount of debris had lodged on the wire there. The bed of the stream appeared to have been scoured under the wire-retained rock at the upstream end of the right abutment. Some of the rock appeared to be missing from the toe of the right abutment just upstream from the bridge.

Some of the wire enclosures were very irregular in shape, reflecting their flexible character and the fact that they were assembled in the field. In contrast, regular gabions have essentially fixed dimensions, and are prefabricated before they are filled in the field.

The water level was high at the time of the examination because of the passage of the remnants of Hurricane Bertha on 13-14 July, with 6 to 7 inches of rainfall, and local thunderstorms on 15 July.

No other site in Massachusetts offered a chance to look at anything other than riprap, according to Mr. Murphy.

## **7.10 CONNECTICUT**

Assistance was provided in Connecticut by Mr. Daniel Bukavich (860-594-3234) and Mr. Jim Loursh (860-594-3156) of the Connecticut Department of Transportation. Mr. Bukavich stated that bags had been filled with concrete grout to form scour protection in Connecticut and he said that is what was meant in the NCHRP 24-7 questionnaire reply, by "concrete-grouted riprap." Typically, when a spread footing or pile cap is undermined by scour, polyethylene bags are placed in the cavity and filled with grout. When the grout sets, more bags are placed over the first bags, and so forth, until the cavity is filled. Then grout is injected between the bags through a two-inch pipe left between the bags, until all the undermined void is filled and the footing or pile cap is stabilized. Bukavich said that divers had noted scour at a pier of the State Route 853 bridge in Ansonia, over the Naugatuck River, and grouted bags had been used as an emergency repair. He suggested that a call be made to Jim Loursh (860-594-3156) of the bridge safety section to get more information on countermeasures in Connecticut.

Mr. Loursh stated that sheeting had been driven around the problem pier during initial construction of the Ansonia bridge, and that the tops of the sheeting had extended above the top of the pile cap. When the bags were placed around the sides of the pier outside the sheetpiles, the tops of the piles were cut down to the top of the pile cap, because hydraulic engineers thought the sheetpiles had aggravated scour. Loursh said that plans had been made to use tetrapods on one site, but the problem at that site was not at a pier, but on the bottom of a culvert. He stated that no other site in Connecticut offered any opportunity to see anything other than riprap.

### **7.10.1 Naugatuck River Division Street Bridge in Ansonia**

On 16 July 1996, the Division Street Bridge over the Naugatuck River in Ansonia, Connecticut, was examined; this bridge carries CT 853 over the river. The 139 m (460 ft) long bridge was built in 1958, and includes six spans. The Naugatuck River is a relatively small stream in Ansonia, with a drainage area upstream of the bridge of about 309 square miles; a major stream, the Housatonic River, is located to the west of the Naugatuck. However, the presence of riprap over the entire height of an earth flood protection levee to the west of the river suggested that large floods have occurred at this site. Seven flood control dams have been built upstream from Ansonia, since two large floods occurred in 1955; the August 1955 flood was caused by the effects of two hurricanes passing through the area within 16 days. The stream flows through several bends in the vicinity of Ansonia, and stream migration may have been a problem in the past. Flow patterns in the stream indicated many rocks only slightly submerged, and shallow water, within 100 yards upstream from the bridge. Dikes and floodwalls have been built on both sides of the stream through most of the city of Ansonia, and hydraulic analyses indicate that both the 100-year (36,000 cfs) and 500-year (81,900 cfs) floods would be confined within those dikes.

Upstream from the bridge piers, breaks in the water surface showed where obstacles were submerged only slightly. The Division Street bridge had been recommended for replacement by a wider bridge scheduled for completion in 1999 when emergency repairs were deemed necessary in 1994-5. The repair consisted of placing and filling polyester bags 3 to 4 feet wide and 24 to 26 feet long with small aggregate concrete to a thickness of about 1 foot, in scour holes as much as five feet deep around the bridge piers. The concrete had a compressive strength of 5,000 psi and the coarse aggregate was 0.75 inches in maximum dimension. The bags were pinned together with No. 6 rebars about 18 inches long. The piers are designated in order from west to east. Approximately 107 cu yd of concrete were pumped into bags at pier 1, 31 cu yd were injected into bags at pier 2 and 48 cu yd were pumped into bags at pier 3. On piers 1 and 2, the steel sheetpiles that had been left in place around the original piers were cut off at the footing elevation, but the sheetpiles around pier 3 had been left in place. The nylon bags had been placed around each of the piers and filled until the tops of the bags were within three inches of the footing elevation. The bags extended between ten and sixteen feet upstream from pier 1 and from four to ten feet out from the other sides of that pier. At pier 2, the bags were placed from the upstream end of the footing downstream along the two sides twenty-three and twenty-five feet, respectively, leaving the downstream third of the pier untreated. A similar repair was made at pier 3.

Sheetpiles had been left in place around the circumference of pier 3 closest to the left (east) abutment. Five piers support the bridge spans; three piers are in the stream, but two piers are located on the left descending bank. An obstacle visible in the water appeared to be the top of a sheetpile that had been driven at the upstream end of the pier. Debris had accumulated around vegetation growing in sediments accumulated inside the sheetpiles around the pier base; eddies were obvious in the flow around the downstream end of the pier. The sheetpile enclosure effectively enlarged the base of the bridge pier. Pieces of rock were visible just downstream from pier 2, with the tops of the rocks just breaking the water surface. Approximately 100 yards downstream from the bridge, a riffle in the stream indicated rock present on the stream bed. The right descending (west) bank of the river had been covered with large pieces of riprap, and large rectangular slabs of granite had been placed on the left descending (east) bank. Large rock had been piled over the sheetpile enclosure at the downstream end of pier 1, near the west abutment, and vegetation was growing just downstream from the pier.

Bank materials at this site included a mixture of sizes ranging from silts to cobbles. Most of the bank material was rounded gravel-sized pieces of igneous and metamorphic rock, mixed with micaceous sand. It was not possible to examine the bed of the stream because the water level and flow velocities had been increased by rain that accompanied the remnants of Hurricane Bertha through the area on 13-14 July and that fell in thunderstorms on 15 July.

## **7.11 MARYLAND**

In Maryland, assistance was provided by Mr. Stanley R. Davis (410-545-8362), Mr. Rod Thornton (410-545-8388) and Mr. Lynn Popel (410-545-8363) of the State Highway Administration, Hydraulics Section, 707 N. Calvert Street, Baltimore, Maryland 21202.

Problems had occurred with scour at bridges in Maryland after intense and prolonged rains in January 1996, in June 1996, and again in July 1996 (the last event as a consequence of the passage of Hurricane Bertha on 13 July 1996). Emergency repairs had been done at a number of bridges by placing bags in scour features and filling the bags with grout. In Maryland, bags are used to form a boundary behind which grout is injected between bags, and to fill voids behind bags. The most serious problems in Maryland with regard to scour at bridges include bridges supported on spread footings founded on soil; for many bridges built in the 1920's and 1930's, the project engineer (who had authority over construction) chose to found the bridge on erodible soil. A second factor that contributes to scour problems in Maryland is contraction of flow at older bridges that were made as short as possible to achieve economies in material and time of construction. More than 1,000 bridges cross water in Maryland, in the state system; scour evaluations have been completed for all state bridges and for over ninety percent of the off-system bridges. Mr. Davis provided a paper of observations on the use and their recommended method of construction of grout bags as scour countermeasures.

### **7.11.1 Dickerson Run Bridge 6007 in Carroll County**

On 18 July 1996, bridge 6007, built in 1924, that carries MD highway 31 over Dickerson Run in Carroll County, just south of New Windsor, Maryland, was examined. Previous inspections had shown this bridge to be undermined and one of the wingwalls was broken. Riprap had been placed on the right descending bank, just upstream from the bridge. The stream planform is somewhat sinuous upstream from the bridge; two sharp bends are located just upstream from the bridge. When the stream passes through the bridge, contraction of floodplain flow occurs. Contraction scour is the most serious problem at this site. Geosynthetic filter cloth had been placed on the bank under the large pieces of riprap on the right descending bank just upstream from the right abutment. The riprap appeared to be banded metamorphic and igneous rocks. Grout bags had been placed against the undermined left abutment. The left abutment was undermined and the wingwall had tilted out away from the abutment wall; the separation between the walls had been sealed with grout. The grout bags against the abutment had been undercut slightly at the downstream end of the abutment. Two bags had been stacked against the abutment, and a series of bags had been placed against the wingwall downstream. At this site, the edge of the filter fabric that had been placed under the bags had loosened and folded; securing the edges of geosynthetic filters presents problems for field crews in Maryland.

### **7.11.2 Little Pipe Creek Bridge 6006 in Carroll County**

Bridge 6006, that carries MD 852 over Little Pipe Creek, was examined. Riprap had been placed around the upstream nose of the central pier, over filter cloth. No bags were used at that site.

Very large pieces of rock had been used, even though the stream was only about twenty feet wide; pieces as much as 18 to 20 inches in dimension had been placed. Gradation of the riprap was wide. A significant percentage of the flow cross-section was blocked by the riprap. Mr. Davis referred to problems cited by field crews who said that friction between geosynthetics and riprap is low, with resultant slippage of rock on steep slopes during placement and in service.

### **7.11.3 Copps Creek Bridge 6055 in Carroll County**

Bridge 6055, that carries MD 852 over Copps Creek in Carroll County, Maryland, was examined on 18 July 1996. Grout bags had been placed against both undermined abutments of this single span bridge. The space between the top of the bags and the abutment wall had been filled with grout, at both abutments, and apparent settlement and tilting of the bags toward the stream had caused a separation between the edges of the bags and the abutment walls. However, the bags were intact and appeared to be functioning to buttress the abutments. The stream did not appear to have scoured substantially below the bottoms of the bags, at the downstream edge of the bridge. At the upstream edge of the bridge and under the bridge centerline, the scour hole appeared to be substantially below the bottoms of the bags.

### **7.11.4 Big Pipe Creek Bridge 6025 near Taneytown**

On 18 July 1996, bridge 6025 that carries MD 832 over Big Pipe Creek near Taneytown, in Carroll County, Maryland, was examined; the bridge was built in 1929. The creek was migrating at the bridge site, and contraction scour was moderate to severe; Maryland SHA engineers had estimated a maximum velocity of 8 to 10 feet per second through the bridge for an event with a 100-year recurrence interval. The right abutment had been scoured and undermined, as had the pier. The foundations for the bridge were not known. Grout bags had been placed at the east (right) abutment and around the pier in 1994, and new scuppers were installed, at a total cost of \$ 37,419.87. The roadway is oriented approximately southeast-northwest, and the stream is oriented north-south. The bridge abutments and pier are aligned parallel to the flow. A significant accumulation of debris was noted at the upstream end of the pier. The outline of the grout bags on the stream bed was visible from the bridge deck. The configuration of the bags showed very sharp, right-angle corners, and the bags did not appear to have been displaced from their original positions and conditions around the pier.

The grout bags that had been placed against the east abutment had grout slushed onto the tops of the bags. Placing grout over the bags was not a standard practice, because of the reduction in flexibility of the treatment caused by the grout cover. A rod was used to probe under the edges of the bags. The bags appeared to have been undercut for a distance of about 18 to 20 inches laterally. The undercut bag was twenty feet in length, and the bag immediately downstream from that bag was twenty-five feet long. A four feet-wide bag had been placed against the abutment wall, with a bag two feet wide placed on the stream side of the first bag. The outer bag had been overfilled to make it cylindrical; that bag had been undercut, but had been prevented from moving down into the stream by the grout on the upper surface of the bags. Scour of the stream bed was obvious just upstream from the bridge, and under the bridge, but the abutment appeared to have been buttressed by the bags which had not moved away from the abutment wall. The bags along the pier appeared to have been displaced downward and away from the pier at a point about fifteen feet downstream from the upstream end of the pier; the bridge flow section was about 45 feet long. A bar deposit linked the left descending bank downstream from the bridge to the downstream end of the pier, and a larger bar was evident along the bank that supported trees.

#### **7.11.5 Beaver Branch Bridge 10054 in Frederick County**

On 18 July 1996, bridge 10054 that carries MD 77 over Beaver Branch near Rocky Ridge in Frederick County, Maryland, was examined. This bridge was built in 1928. A large railroad trestle was located very near the highway bridge, but was oriented at an angle to the bridge. The right abutment and pier of the bridge were found to be undermined when the bridge had been inspected. However, undermining of the railroad structure pier was more serious than undermining of the bridge pier. Grout bags were to be placed around the pier and the right abutment, and riprap was to be placed against the downstream wingwall and on the bank between the bridge and the railroad pier. No bags had been placed by 18 July 1996. A serious alignment problem existed at this bridge, where the stream bends sharply to the left just before entering the bridge and scouring the right abutment. Some debris seems to accumulate on the pier, exacerbating the problem. A scour hole was present between the left descending bank and the pier. The major portion of the flow passes through the right half of the bridge opening, and scour has been more serious against the right abutment. Rock was encountered on the bottom of the stream under much of the bridge area.

#### **7.11.6 Israel Creek Bridge 10094 in Frederick County**

On 18 July 1996, bridge 10094 that carries MD 550 over Israel Creek near Woodsboro in Frederick County, Maryland, was examined. This is a three-span bridge, with two piers. Flow from several drainage ditches complicate conditions on the upstream and downstream sides of this bridge. Debris had accumulated around the upstream nose of the piers. A bar blocked much of the left channel. The left descending bank extended downstream to a point just upstream from the southeast pier (pier 2) of the bridge. Debris on the spit of bank obstructed flow significantly. Riprap had been placed at the upstream nose of pier 2, and along the sides of that pier. Grout bags had been placed at pier 2 and along the east abutment. Water depth was too great to allow ready inspection of the bags.

#### **7.11.7 Montgomery County Bridge**

A small bridge in Montgomery County, Maryland, was examined on 18 July 1996. Serious bank erosion had occurred on the left descending bank downstream from the bridge. Apparently, gravel and cobbles had been moved through the bridge opening and had been deposited just downstream from the bridge, where it filled the channel and impeded flow. The deflected flow then had eroded the left descending bank. The highway embankment obstructs flow across the floodplain of this stream and contracts that flow through the bridge opening.

#### **7.11.8 Little Monocacy River Bridge 15070 in Montgomery County**

On 18 July 1996, bridge 15070 that carries MD 109 over a branch of the Little Monocacy River in Montgomery County, Maryland, was examined. Repairs at this site included placing grout bags along the abutment walls and wingwalls. The bags on the right abutment had been undercut and the top layer of bags had been cantilevered out from the abutment walls. The stream had degraded 3 to 4 feet after the bags had been placed. The top layer of bags appeared to be relatively close to their as-built positions, but the lower layer of bags had moved toward the stream. This site illustrates the problem with grouted bags at a site where the stream degrades. A significant overhang had developed on the left bank just upstream from the bridge. Several bags had been dislodged and were resting on the stream bed along the right descending bank about five yards downstream from the bridge. The degradation at the bridge appears to have been caused by contraction scour. Natural levees of gravel were present on both banks downstream from the bridge.

#### **7.11.9 Peggy's Run Bridge 3080 in Baltimore County**

On 19 July 1996, bridge 3080 that carries MD 137 over Peggy's Run in Baltimore County was examined. Grout bags had been placed along both abutments, and the south abutment had been underpinned. The banks and channel upstream had been protected with riprap. Gunitite repairs to the superstructure had been accomplished. The total cost for the repairs, completed in August 1994 had been \$25,981.80. A barrier had been built upstream from the bridge apparently to prevent the passage of cattle. The grout bags had been placed with two bags side-by-side along each abutment; the bags were about 3 feet wide by 8 feet long. Consisting of large pieces of metamorphosed banded rock, the riprap showed a good gradation with a mixture of sizes of very angular rock pieces. The riprap was thick on the left abutment downstream, but only a slight amount of riprap was observed on the right abutment downstream. The grout bags were slightly undercut, but they appeared to be functioning to buttress the abutment walls. Rock (most probably riprap) was present on the bed of the stream. Two layers of grout bags had been installed, two bags wide. The riprap on the right abutment, and the appearance of the stream bed, suggested that scour had removed some of the rock on the channel bed and on the right bank downstream from the bridge.

#### **7.11.10 James Run Bridge 12009 in Harford County**

On 19 July 1996, bridge 12009 that carries MD 7 over James Run in Harford County, Maryland, was examined. Bridge 12009 was built in 1925. James Run empties into Bush River, within one mile of the bridge site, and Bush River empties into Chesapeake Bay a short distance downstream from this site. The roadway is oriented essentially southwest-northeast, and flow occurs from northwest to southeast. Repairs at this bridge had been completed in early June, 1996, and consisted of underpinning the pier with grout after placing grout bags along the north (left) side of the pier and along the north (left) abutment. Total cost for the repair work was \$ 1,596.01. Bedload at this site consisted of large coarse sediments ranging in size from sand to pea gravel to cobbles. The banks downstream from the bridge were wooded and vegetated and appeared to be stable, although on the left descending bank the trees had been undermined and their roots were exposed. A large gravel bar was present adjacent to the left descending bank about 75 m downstream. A gravel bar adjacent to the right descending bank and in the middle of the stream was almost continuous from a point approximately twenty m downstream to a point about 100 m downstream. Debris was present just downstream from the bridge, on the bar just downstream from the central pier. Debris was present also upstream from the bridge, against the upstream face of the bridge over the right half of the flow opening. The configuration of the bridge and stream bed, the arrangements of sediments, and the evidence of debris suggested that debris had blocked the right half of the flow opening, deflecting current toward and around the upstream nose of the pier during a flood, but that the debris had been carried through the right half of the opening when floodwaters receded slightly and had been deposited on the bar downstream from the pier. A drainage ditch on the upstream side of the right abutment of the bridge had scoured its channel and had carried debris toward the bridge; the bank at the upstream end of the right abutment had been protected with riprap in the bed of the drainage ditch. Debris

had collected at the upstream nose of the pier. The scour around the nose of the pier had occurred as a result of deflection of flow from the right half of the flow opening by accumulated debris. The large bar upstream from the bridge contained sand, gravel and cobbles. The stream approaches the bridge at a significant angle at low flow, and had scoured the right abutment. The stream flow occurred principally in two channels on either side of a large center bar. Trees and brush were present on the upstream bar. Riprap placed at the site consisted of dark metamorphosed, platy and angular pieces of rock and had been placed on the right descending bank and on the right abutment just upstream from the bridge. Geosynthetic filter fabric had been placed on the bank under the riprap. The banks of the stream upstream from the bridge showed no signs of instability or stream widening. The grout bags said to have been placed at this bridge were not visible at the time of the examination because of the high turbidity and high stage of the run.

#### **7.11.11 Summary on Bridge Scour in Maryland**

Summary comments on bridge scour countermeasures in Maryland: the grout bags used in Maryland can be sewn to make various sizes and the size could be altered in the field. If requested, the bag manufacturers can make the bags so that they have a tapered final shape. The bags can be inserted under the edges of undermined bridge elements and filled in place to provide underpinning support. The rigidity of the bag after the grout hardens may be a disadvantage if scour can occur under an edge of the bag. Bags twenty to twenty-five feet long were observed to have been undermined when they were placed in layers and the upper surfaces of the bags were covered with grout. Very large rigid bags may bridge over small scour features and allow development of undermining; a series of small bags, perhaps connected by flexible cables or fabric, might conform more closely with the stream bed and be more effective in protecting piers and abutments. Questions were raised about how to use filter fabric: How are the edges of the fabric to be secured? What is the main function of the fabric? Does the fabric function primarily as a filter to retain bed soils, or does the geosynthetic provide added scour protection, or does the geosynthetic enhance the foundation stability between the bags? Securing the ends or edges of the geosynthetic is a serious concern. If the bags are fastened or bonded to the sides of a pier or the walls of an abutment, and the adjacent stream bed is scoured, how will the bags deflect and continue to function? Use of small bags or bags sewn with a center seam could provide more flexibility, but the seams should be formed by drawing the top layer of fabric down to the lower layer, to prevent the formation of a gap between the stream bed and the underside of the seam. The use of grout bags appeared to be more advantageous than mounding of riprap at small bridges because the bags were placed to fill the scour features and bring the bed back to its original configuration rather than raise the bed; mounded riprap would obstruct a significant portion of the flow cross-section at some of the bridges examined in Maryland. The State Highway Administration is stressing the need to prepare the stream bed for the bags. If an analysis indicates that contraction scour is likely to be a serious problem, an excavation is made and bags are placed below the existing stream bed so that they will not be undermined by future scour. For very shallow foundations, bags have an advantage over riprap in 1) causing less obstruction to flow, and 2) excavation may not be required below the bottoms of spread footings. If no excavation is required for placement of the bags, no disturbance of the stream bed and impact on the local ecosystem occurs as a result of excavation. In Maine, bags are placed only on the bottoms of scour features and the bed level is not restored, and grout is injected behind and between the grouted bags. In any event, grouted bags should not be filled so that they have a cylindrical shape; the cylindrical shape allows scour attack at the sides and edges of the bag. Bags with aspect ratio of 1 V to 4W to 4-8L appear to be very effective.

The stream configurations and sediment deposits observed on small streams in Maryland were somewhat different from those noted of the same streams during inspections by Maryland SHA engineers, and may reflect the impacts of heavy rains and floods in January and June 1996, and possibly the aftermath of precipitation from Hurricane Bertha on 13 July 1996. At the 12009 site, the creek was almost braided and the channel had moved from one bank where it was scouring the left abutment, to the opposite bank where erosion was occurring just upstream from the bridge in late July 1996.

## 7.12 PENNSYLVANIA

In Pennsylvania, assistance was provided by Glen D. Vasquez, Alan E. Jackson and David J. Shipton of Pickering, Corts & Summerson, Inc., 126 S. State Street, Newtown, PA 18940 (215-968-9300, fax 215-968-3649), regarding the Vine Street bridge in Philadelphia, by Sandra Tosca, Bridge Safety Program Engineer, Department of Transportation, Commonwealth of Pennsylvania, Engineering District 3-0, 715 Jordan Avenue, Montoursville, PA 17754-0218 (717-368-4309 fax 717-368-4321) regarding bridges in District 3, and Robert Heath, Jr., owner of the P&A Restaurant, RD1 Box 138, Towanda, PA 18848, regarding collapse of the Route 6 bridge over Sugar Creek.

### 7.12.1 Schuylkill River Vine Street Bridge in Philadelphia

On 24 July 1996, the Vine Street Bridge over the Schuylkill River in Philadelphia was examined. The two piers of the bridge had been supported on monotube piles that plans indicated were twenty-eight feet long; research by Monotube of Ohio showed, however, that the piles actually were about twenty-two feet long. When the bridge was inspected in 1988, divers discovered that the stream bed below pier two had been scoured to a depth of 12 to 18 feet below the bottom of the pile cap, leaving the piles embedded only 4 to 8 feet. Concrete underpinning was proposed as a scour countermeasure, but engineers had felt that such underpinning would cause a surcharge load on the piles if the piles were not equipped with sleeves. Nondestructive tests done on the piles in August 1989 showed that the piles were in satisfactory condition. Two alternative schemes for countermeasures were proposed: to enclose the areas under the pile caps with grouted bags, and to place small stone inside the enclosure made by the bags, covering the outer edges and adjacent stream bed with a geosynthetic filter fabric and riprap; or to fill the zones under the piers with small (no. 3) stone and cover the outer slopes of the stone with gabions. The gabions were installed. The scour of the stream bed under the pile caps was felt to be general scour caused by the presence of an overflow wier dam a short distance upstream from the bridge and dredging downstream from the bridge to facilitate navigation of the river. The bridge was built in 1959 but was reconstructed extensively in 1989. The piers were repaired in 1989 by removing all debris from beneath the pile caps and surrounding stream bed area, using a small front end loader to dump small stone under the pile caps from a barge, smoothing the rock slopes with a bar sweep, and placing the gabions. The gabions were constructed on shore, lifted onto a barge, and then placed by means of a special cradle onto the stone or stream bed. The areas around the piers had been inspected periodically since the repair in 1989, and no undermining or displacement of the gabions had been detected.

The right descending bank of the stream was supported by a vertical masonry wall, and artificial structures supported short reaches of the left descending bank upstream and downstream from the bridge. A dam just upstream was considered an efficient sediment trap. The left descending bank of the river upstream from the bridge appeared to be stable, but much of the bank area had been protected with stone or retaining structures. The Philadelphia Museum of Art was located on the left descending bank close to the dam. The piers are skewed to the flow by an angle between fifteen and twenty degrees. The right abutment of the bridge is seated at the top of the vertical masonry wall along the right bank.

Mortar was missing between the stones of the piers in the zone down to about one meter below the water surface. The river bends to the right, from upstream to downstream, in the reach containing the bridge structure. The low flow current would affect the left descending bank at pier 1, most probably, but the flood flow would tend to be straighter than the low flow.

On 24 July 1996, a surveyor's rod was used to probe the areas around the piers, to find the tops of the pier pile caps and the tops of the gabion baskets around the pile caps. The Coast Guard had been concerned that placing the gabions would reduce the navigable channel, so the gabions were to be one foot or more below the tops of the pile caps, and were to be sloped at 1V: 2 or more H, over the small stone. Probing of the area around pier 2 showed that the gabions were located in approximately the same positions in which they had been placed. Sand and gravel sediments were present atop the pile cap and gabions around the downstream end of pier 2; at the downstream end of the pier, almost one foot of sediment was present over the top of the pile cap and over the gabions. The downstream third of the east side of pier 2 was covered more thickly with sediments than was the west side of the pier, closer to the

center of the river; the west side of pier 2 was clear of sediments except near the downstream end of the pier. Probing around pier 3 showed that the top of the pile cap there was higher than the pile cap at pier 2. At about the downstream quarter point of the east side of pier 3, one gabion appeared to have sagged about six inches next to the pile cap and in the center of the gabion, relative to the east edge of the gabion. All other gabions around pier 3 appeared to be in their original positions and conditions. The gabions had been placed only around the upstream three-fourths of the circumference of pier 3. The stream bed had been eroded about 90 cm to 1.3 m below the top of the pile cap at the downstream end of pier 3.

#### **7.12.2 PA 36 Bear Run Bridge in Clearfield County**

On 24 July 1996, a small bridge on PA 36 over Bear Run in Clearfield County, just west of the junction of PA 36 and US 219, southwest of Clearfield, Pennsylvania was examined. The bridge consisted of two simple spans of reinforced concrete T-beams supported on a central pier. The two abutments and the central pier had been supported on spread footings on soil.

Inspections by a PaDOT inspector and a crew provided by Pickering, Corts & Summerson, Inc., on July 23, 1996 revealed that the right abutment rested on a footing 2.8 feet thick, and that the footing had been undermined along the entire length of the breastwall and upstream (left) wing wall; the breastwall was 47 feet long, the right wing wall was 18 feet long and the left wing wall was 8 feet long. Soundings were taken in five foot increments for a distance of 25 feet from the foundation elements of the bridge, and stream cross-sections were taken along each bridge fascia and at distances of 100 feet and 200 feet upstream and downstream from the bridge. At the upstream end of the breastwall, the stream bed had been scoured to a depth of 3.5 feet below the bottom of the spread footing for a distance of about four feet perpendicular to the long dimension of the footing. The upstream wing wall also was undermined seriously. Very little sand or other soil was found over the cobbles and boulders on the bottom of the stream under the bridge.

The pier footing was 49 feet long, five feet wide and two feet thick, and was founded on soil. Scour had undermined the pier footing for nearly 50 percent of the bearing area, according to the underwater inspection team; the upstream half of the footing was undermined to a depth of 2.8 feet below the bottom of the footing. A large amount of timber debris had collected on the upstream end of the pier footing, and a wide vertical crack was found on the right face of the footing below the third and fourth beams of the bridge, below a vertical construction joint in the pier stem. The left abutment, a mirror image of the right abutment, had been undermined along the upstream three-fourths of the length of the breastwall; the maximum depth of undermining under the bottom of the footing was 1.6 feet and the undermining extended back under the edge of the footing for a distance of about 6 inches. The underwater inspection team recommended that the abutments and pier be repaired by removing all loose and unstable streambed material below the footings, removing the debris from the upstream nose of the pier, and installing grout-filled bags under the footings to restore bearing support.

Debris had collected on the concrete parapet on the downstream edge of the bridge, indicating that flooding on 19 July 1996 had overtopped the bridge. On the downstream side of the bridge, very large rock was present on the bed of the stream. Fresh breaks were evident on the edges of the large pieces of rock in the stream and recent erosion was apparent on the left descending bank, where small trees had been uprooted and toppled. Fresh fractures on the large pieces of rock downstream from the bridge suggested that large pieces of rock had been moved through the bridge opening during the recent flood. The banks of the stream were composed of alluvium derived from colluvium, or from modified colluvium; semiangular pieces of rock were embedded densely in a sandy silt matrix. Several deep pools were present in the stream just under the bridge on both sides of the central pier, and downstream a short distance. Much of the right flow opening was blocked by debris, and the flow there had been deflected. Large trees had toppled on both banks upstream from the bridge, indicating recent erosion and undermining of those banks. Abrasion marks were visible on large pieces of rock on the stream bed upstream of the bridge. Twigs, brush and tree limbs had lodged in the vegetation on the banks of the stream upstream from the bridge, up to a level that indicated the bridge had been overtopped.



The river had flowed over and eroded the shoulders on both sides of the roadway on both sides of the bridge; the shoulders had been filled and repaired by 24 July 1996. Water had flowed down off the left descending bank into the stream just upstream from the bridge, and had been deflected by the debris on the upstream end of the pier. The stream had overflowed the right bank near the bridge, where the blockage of flow by the debris on the nose of the pier had caused an eddy to form behind and above the wingwall upstream from the right abutment. The bank upstream from the right abutment had been eroded and the right abutment had been scoured and undermined. The fill behind the right wingwall upstream had been eroded for a distance of about 4 m along the roadway, and that area had been filled with rock in the repair. The upstream wingwall on the right bank had tilted toward the stream and had been undermined by scour. A cavity about 50 cm high was present under the end of the wingwall.

Flow had plunged over the right descending bank into the bridge opening, as indicated by debris and vegetation on that bank. The debris wrapped around the upstream nose of the bridge pier, and deflected flow, especially toward the right abutment. The debris at the nose of the pier included five large trees from 25 to 30 cm in diameter and as much as 9 m long. Numerous smaller branches had been broken, bent and/or wrapped around the nose of the pier. Several other trees lay at angles between the right descending bank and the upstream nose of the pier, tangled with the debris on the pier; those trees were about 20 cm in diameter at their bases and were about 7 to 8 m long. On the left side of the pier, the debris accumulation was thicker, apparently because of the way flow had plunged over the left bank and at the pier. Branches 5 to 8 cm in diameter were wedged tightly against the left side of the pier nose, and several larger branches had been trapped in the accumulation. Soundings were made along the upstream and downstream edges of the bridge, and the dimensions of the bridge were measured.

### 7.12.3 US 219 Bear Run in Clearfield County

On 24 July 1996, a small bridge for US 219 over Bear Run just north of the intersection of US 219 and PA 36, in Bell Township, Clearfield County, southwest of Clearfield, Pennsylvania was examined. Reinforced concrete T-beams had been used in this single span bridge, and the abutments had been founded on spread footings on soil. On July 23, 1996, the left abutment had been inspected by an underwater inspection team consisting of a PaDOT inspector, a professional engineer, a commercial diver and a tender, supplied by Pickering, Corts & Summerson, Inc. Soundings were taken in five-foot increments for a distance of 25 feet from the abutment, and stream cross-sections were taken along each bridge fascia and at distances of 100 feet and 200 feet upstream and downstream from the bridge. The breastwall of the abutment was 46 feet long, with flared wing walls 11.5 feet long at both ends of the breastwall. The underwater inspection revealed that the abutment footing had been undermined for about 75 percent of the bearing area under the breastwall and wing walls. At the upstream end of the abutment, the entire 4.3 foot width of the footing was undermined. The stream bed had been scoured to a maximum depth of 3.7 feet below the bottom of the footing and as far as 5.5 feet laterally from the face of the footing. The foundation material under the abutment was compacted clay, sand and cobbles. The abutment showed no visible signs of distress such as rotation or cracks. The stream flow was directed at the left abutment at an angle of about thirty degrees. The underwater inspection team recommended that the abutment be repaired by removing all loose and unstable streambed material below the footing, and installing grout-filled bags under the footing to restore positive bearing support.

When the bridge was examined on 24 July 1996, the bedload in the stream included platy, angular pieces of rock from cobble to boulder size, mixed with angular gravel and sand. The left abutment had been scoured and eroded, especially where a corrugated metal pipe was placed behind the upstream wingwall, and large pieces of rock had been deposited over the right half of the flow opening. Flow approached the bridge at a significant skew, even at high flow conditions. The sediments near the upstream end of the abutment had been scoured lower than the general level of the deposit. About 14 cm of rain had fallen during a period of 7 to 8 hours, to cause the flood event. Much of the town of Punxsutawney had been evacuated as a result of flooding. Large rocks deposited in the center of the stream by the two vortices formed along the abutments of the bridge. The river had overtopped the PA 36 bridge upstream and water had flowed down the highway and into the floodplain to the right of the US 219 bridge, entering the stream again downstream from that bridge and causing scour and erosion on the right

descending bank. On the upstream side of the bridge, the right descending bank had been eroded severely, the corner of a storage shed had been undermined and distorted apparently by debris impact during the flood. Erosion had been minimal on the left descending bank upstream from the bridge, except right at the upstream wingwall. The stream bends to the right but approaches the bridge at a considerable skew, so that the principal thrust of the stream is at the left abutment; during the high flow event, however, the stream had tended to straighten and had eroded the right bank, plunging over that bank into the bridge opening. Flow had scoured the base of the left upstream wingwall. Along the right (east) side of US 219, rock had been filled in the shoulder area to repair the effects of flood overflow, but the yard adjacent to the house nearby had been scoured severely.

#### **7.12.4 PA 4010 Sugar Creek in Bradford County**

On 25 July 1996, the PA 4010 bridge over Sugar Creek in Bradford County, Pennsylvania was examined. Inspections had indicated that the right abutment had been undermined, with the abutment footing exposed in 1995 (not in 1994); the increase in scour was about one meter at the near abutment, between 1994 and 1995. Sediment including gravel was present along the far abutment when it was inspected in June, 1996, by state inspectors. Riprap had been placed on the right abutment and right descending bank. The riprap obstructed a significant part of the flow opening under the simple span bridge. The riprap consisted of rocks from gravel size to blocks 1.3 m in largest dimension; most of the rock was laminated, shaley limestone. Some of the pieces of riprap had deteriorated apparently as a result of weathering (freeze-thaw and slaking effects). The right abutment was on the outside of a slight bend or change in flow direction; a scour hole thirty feet long and fifteen feet wide had formed along the right abutment by July 1993. The stream approached the bridge at a skew of from thirty to forty degrees; upstream from the bridge, a gravel bar was present on the left bank of the stream, and an abandoned channel was located on the side of the bar opposite from the existing channel. The stream was wider at the bridge than upstream or downstream from the bridge. The large riprap used at this site, although it blocked a significant part of the flow opening, would have the advantage that it would fall into and armor a scour hole if such a hole formed adjacent to the mound of riprap. A grouted bag, on the other hand, may not block the flow opening but might not be as effective in armoring any future scour holes, if the bag were large and rigid.

#### **7.12.5 PA 4014 Leonard's Creek Bridge in Bradford County**

On 25 July 1996, the PA 4014 structure over Leonard's Creek in Bradford County, Pennsylvania, was examined. At this site, a concrete arch bottomless culvert had been undermined along the left abutment. Inspections in 1994 had indicated this undermining, and 1996 inspections showed that the undermining had extended along the entire lengths of both abutment walls. A gap of at least 60 cm had been generated under the edge of the left abutment wall, and the scour cavity extended perpendicularly to the stream for a distance of about 3m and along the stream for at least 5 m. Sediments had accumulated over the grouted bag along the left abutment, with scour occurring under the upstream end of the bag. The roadway embankment at this site constricted floodplain flow severely, with resultant contraction scour at the structure. As water is ponded upstream of the culvert, sediments are deposited. Where the flow accelerates into the opening, scour occurs. The sediments deposited upstream from this culvert appeared to have deflected flow toward the left abutment, with resultant scour there.

#### **7.12.6 PA 4027 Buck's Creek Bridge in Bradford County**

On 25 July 1996, the PA 4027 bridge over Buck's Creek, near Bentley Creek, in Bradford County, Pennsylvania, was examined. At this site, sediments apparently had been excavated and moved to redirect the flow in the stream away from the right abutment, and the redirected flow had scoured the left abutment. The left abutment had been protected with riprap, but had been scoured in flood events in 1994 and 1996. The left descending bank downstream from the bridge had been eroded for a distance of approximately 120 m; the appearance of the banks suggested that soil had fallen from the top layers of the bank recently. Fence posts and lengths of fence had fallen adjacent to a residence located just downstream from the

bridge. Almost 85 percent of the total width of the flow area was filled with coarse sediments. The sediments included sand, gravel and cobbles; many of the pieces of rock were platy and angular. The low-flow channel was located against the left abutment and the bank erosion had occurred primarily on the left bank downstream from the bridge. However, some erosion had occurred on the right descending bank about 60 to 70 m downstream from the structure, in what looked to be recent failures in a flood event. The stream appears to be migrating in its own sediments, and an effort had been made to direct the flow away from the right abutment. The banks consisted of rock fragments embedded in clayey silt soils, in evident layers; the banks appeared to be alluvium derived from valley wall colluvium located not very far from the bridge site. The upper parts of the banks contained fine-grained soil layers and the lower banks contained gravel and cobble layers. Riprap had been placed on the left abutment in 1996. The riprap consisted primarily of large angular fragments of sedimentary rocks, mixed with gravel derived mainly from sedimentary rock, but also containing some rounded pieces of metamorphosed granite and other igneous rocks. Test borings made at the site showed brown sand, silt and gravel to a depth of about 45 feet, where gray shale was found.

The size of the bed materials seemed to increase upstream from the bridge, but that appearance most probably was due to the accumulation of smaller rock at the bridge site. The right descending bank had been eroded for about 100 m upstream from the bridge and large trees on that bank had been undermined. The stream approached the bridge along the right bank, and shifted toward the left abutment, in the low-flow channel, about 40 m upstream from the bridge. The channel appeared to have been altered in an effort to train the creek. The original bridge at this site had been washed out in June 1972, and the stream bed had been "greatly disturbed" then, according to inspection reports. The drainage area for the creek above this bridge is 33.8 square miles; the design velocity for the bridge was 11.1 fps. Approximately 6 feet of scour had occurred over the footing of the left abutment by 1990. Inspections by state personnel in January 1996 indicated that the stream had shifted drastically toward the right descending bank upstream from the bridge, after a very large flood event in January. Extensive deposits of large sediments had clogged the channel so that flow was deflected toward the left abutment. When the bridge was inspected in January, the main thread of flow was directed into the left abutment "at almost 90 degrees." Severe erosion had occurred on both banks upstream from the bridge. The footing under the left abutment was exposed for a vertical distance of two feet, but no undermining had occurred.

The pier at this bridge showed local scour effects, but the left abutment showed the effects of flow redirection. The right abutment was covered in coarse sediments and cobbles. The major problem at this site was the redirection of the channel against the left abutment. A straight trench had been excavated in the bed sediments to divert the stream away from the right abutment. Bed material had been excavated and mounded against the right descending bank just upstream from the right abutment. The diversion efforts appeared to have been directed toward stopping scour at the right abutment.

#### **7.12.7 PA 3019 Sugar Creek Bridge in Bradford County**

On 25 July 1996, the bridge for PA 3019 over Sugar Creek in Bradford County, Pennsylvania, was examined; this bridge was built in 1969. The bridge deck was somewhat higher than the roadway beyond the right abutment. When this bridge was inspected in late January 1996, the footing under the right abutment was exposed and had been undermined to a vertical distance of about four feet under the base of the footing, near the upstream fascia of the bridge; no such scour was detected at the downstream fascia of the bridge. A profile sketch of the right abutment showed a water depth of less than one foot at the downstream end of the downstream wingwall, a depth of about eight feet along the downstream half of the abutment wall, and undermining of as much as four feet under the upstream section of abutment wall and left (upstream) wingwall. Penetration probing of the scour hole under the upstream wingwall suggested that scour had extended at least three feet deeper than the apparent bottom of the scour hole (the hole was filled with soft sediments). Scour that occurred during a January 1996 flood was ascribed to contraction effects at the bridge, by bridge inspectors. The approach embankment had been scoured and had failed upstream from and behind the right abutment upstream wingwall, and the failure had encroached on the pavement and roadway. About 6.5 feet of scour had occurred between the January 1996 inspection and the previous inspection. When probing had disclosed as much as five feet of undermining of the

abutment, the bridge was closed because the abutment was founded on a spread footing on erodible soil. A subsequent diving inspection revealed that undermining extended back under the abutment footing 1.5 to 2 feet, along most of the abutment wall. Large riprap had been placed on the right descending bank, particularly behind the upstream wingwall. Under the bridge and under the toe of each abutment, the lower subaqueous slopes had been covered with riprap. The stream appeared to have been widened at the time of bridge construction; the width of the stream was virtually constant for a distance of about 100 m downstream, to a point where the width decreased abruptly. Upstream from the bridge, the width decreased gradually. Downstream from the bridge, much of the coarse sediments that apparently had been transported through and out of the bridge opening, had been deposited where the stream width abruptly decreased. Some very large pieces of riprap were visible on the stream banks below the water surface, on the left descending bank in front of the downstream wingwall. Very large rock had been placed on the left descending bank downstream from the bridge. Fill behind the right upstream wingwall had been lost as a result of scour under the right abutment, and rock had been filled behind the wall.

#### **7.12.8 PA Route 3035 Sugar Creek Bridge in Bradford County**

On 25 July 1996, the bridge over Sugar Creek at segment 10 of PA route 3035 in Bradford County, Pennsylvania, at the intersection of Hanks Road and Carmens Road, was examined. This bridge was located near the end of the route. At this site, the bridge deck was very close to the level of the adjacent floodplain. No scour or any other sign of instability was detected under the bridge or at either abutment. Sediments had been deposited against the left abutment and on the left bank downstream from the bridge. When a flood event occurred, water would overflow on the floodplain behind the left abutment and re-enter the stream downstream from the bridge without any concentration of flow. Debris in the trees just downstream from the bridge on the left descending bank indicated the level of flow in that reach. Upstream from the bridge, the stream passed through two bends, approaching the bridge at an oblique angle of about forty-five degrees with the right bank, and then bending back to approach at about forty-five degrees and passing through the structure at a very slight skew. The banks downstream from the bridge appeared to be stable, with little indication of scour or erosion. A deposit of sediments was evident just downstream from the left abutment of the bridge, in front of the left descending bank. Riprap had been placed on the left descending bank apparently when the bridge was built at the left abutment and just upstream from the bridge. Bank erosion had occurred upstream from the bridge and had removed some of the riprap, but the riprap had delayed the erosion and no scour had occurred at the bridge itself. The contrast in behavior between the lack of scour at this bridge and the scour at bridge 3019 just upstream on the same stream apparently reflects the importance of the difference in elevation between the bridge deck and the surrounding floodplain. At the 3035 bridge, the January 1996 flood had crested at a stage about 0.5 m above the bridge deck.

#### **7.12.9 Route 6 Sugar Creek Bridge in Bradford County**

On 25 July 1996, the site of the Route 6 bridge over Sugar Creek in Bradford County, Pennsylvania, was visited; this bridge, built in 1947, had collapsed. The west abutment of this bridge had been undermined in the January flood event. The abutment had been founded on a footing about 6m (20 ft) wide by 11 m (35 ft) long. When the bridge was inspected in May 1993, scour had been noted along the entire length of the west side of the pier, and along the upstream third of the east side of the pier. When the bridge had been inspected during a very dry weather period in August 1991, the footing under the east abutment had been exposed for about eight inches vertically down from the top of the footing. A prior inspection in August 1990 had shown the west abutment exposed from two feet to two feet-three inches vertically, along the entire length of the abutment footing. A scour hole 120 feet long by fifty feet wide by about five feet deep had been noted near the west abutment. Test borings showed the site to be underlain by gray silty sand and gravel extending to a depth of about 45 feet where hard gray shale was found.

In January 1996, after a severe flood, a PennDOT employee passing over the structure noted unusual flow conditions and asked for an underwater inspection. When a diver inspected the five foot-thick abutment footing, he found it undermined for a distance of almost 5 m (16 ft) perpendicular to the

stream, leaving a gap of 3.3 m (11 ft) between the bottom of the footing and the stream bed, at the center of the breast wall of the abutment. A cavity at least 3 m (10 ft) deep existed along three-fourths of the length of the footing. The footing tilted toward the stream, causing compression in the main members of the deck; those members prevented further tilting. Eventually, however, the footing tilted backward in a bearing failure, the vertical abutment wall toppled, and the west end of the west span of the bridge fell. The central pier of the bridge also had been scoured. Flow from the floodplain beyond the east abutment had been deflected around the end of the east approach embankment, to impinge on the pier and the west abutment. The east span did not fall. To alleviate problems at the site, both abutments were moved up on the banks to east and west, leaving the pier location unaltered. Both abutments had been founded at an elevation of 705 ft MSL, very close to the stream bed level; the new west abutment was moved up to elevation 740 ft MSL, and the east abutment was moved up to elevation 730 ft MSL. The new abutments were founded on steel H-piles. A new pier and new abutments were under construction when the site was visited on 25 July 1996. Large mature trees were present on the right and left descending banks upstream from the bridge. Large cobbles and platy pieces of rock were present on the bottom of the stream and the stream was very shallow at the time of the site visit. The original west abutment slope had been covered with fill to advance the west abutment toward the center of the stream when the bridge was built, but the lower bank appeared to show the original layered alluvial banks where fill had been removed in reconstruction. Layers of gravel and cobbles were present between layers of clayey and sandy silts, in the left abutment slope. Rounded granite gravel and cobbles were mixed with the platy pieces of rock on the stream bed. The coarse sediments and alluvial deposits on the west bank appeared to be glacial valley train deposits. The valley wall was adjacent to the west abutment, but the valley to the east of the bridge formed a wide floodplain. Mr. and Mrs. Robert Heath, Jr., were eye witnesses to the bridge scour and reported that the approach embankment contracted flow and deflected it toward the central pier and west abutment, so that the east abutment was not scoured.

#### **7.12.10 Towanda Creek Bridge 3008 in Bradford County**

On 25 July 1996, bridge 3008 over Towanda Creek in Bradford County, Pennsylvania was examined; this bridge was built in 1964. The bridge is about 400 m from the intersection of route 3008 and PA 414. The right descending bank consisted of a nearly vertical rock cliff atop which was the right abutment or seat of the bridge. A deposit of angular platy pieces of rock as large as boulders was present extending from the right descending bank at a point about 30 m upstream from the bridge across the channel to the middle of the stream under the center pier of the bridge. A considerable amount of debris had collected against the upstream nose of the center pier. In the left span of the bridge, the stream bed consisted of red arenaceous slate bedrock showing ripple marks. The bedrock strata dipped gently (ten to fifteen degrees) toward the right descending bank, and the strike of the beds was parallel to the stream flow. The nearly vertical cliffs on the right abutment were defined by joints perpendicular to the strata. Inspections in 1994 showed that the footing under the left abutment was exposed for a vertical distance of about seven inches for a length of about fifty feet along the abutment wall. A large accumulation of timber debris was noted at the upstream nose of the pier, and severe spalling of concrete was noted on the pier near the stream bed and ordinary waterline. The left upstream wingwall footing had been undermined slightly. Some of the fill behind the upstream wingwall had been lost due to scour. Dark red rocks on the bottom of the stream consisted of sandstones and shales that had been lithified strongly. This site is a good illustration of the relative erodibility of rock units. Even though some of the strata consist of small pieces defined by closely spaced joints, very little rock has been eroded during the lifetime of the bridge.

#### **7.12.11 Highway Segments along PA 414**

On PA 414, at the boundary between segments 410 and 420, the highway fill was bordered by a bend in a stream, and migration of that bend had moved engineers to construct a gabion protection treatment along the outside of that bend. No distress or failures were detected in the treatment.

Farther downstream along the same stream, along segment 460 of PA 414, a bridge for PA 3006 was examined. The bridge, an old steel truss structure, was closed. The fill slope for PA 414 had been

protected with concrete slabs on the slope, and some of those slabs had failed and been displaced from their original positions.

#### **7.12.12 Route 0220 South Towanda Creek Bridge**

On 25 July 1996, the bridge for route 0220 over South Towanda Creek was examined. This bridge was built in 1925. Inspections had shown that the stream was shifting laterally at the bridge site; the stream approached the bridge at a significant skew angle, and the pier and right abutment had been undermined. The two sections of parapet have been displaced relative to their original positions. The right half of the parapet has been moved toward the stream, away from the bridge centerline, while the left half of the parapet has been deflected inward. The bridge had been built as two simple spans, but the pier and abutments had been aligned at a large angle to the roadway. The construction joint over the center pier had been compressed as a result of scour and settlement of the pier, and the thrust in the angled joint had caused the displacements. Very large pieces of riprap had been placed against the right abutment and around the pier. Flow returning into the stream to enter the bridge opening from the floodplain to the left of the bridge had eroded the left descending bank upstream from the left abutment, and riprap had been placed on the left descending bank upstream and downstream from the left abutment. A pool formed in the right half of the bridge opening where a concrete encasement surrounds a utility pipe on the bed of the stream parallel to the downstream edge of the bridge. Riprap had been placed along the left descending bank at a distance about 30m upstream to prevent further erosion, and fill had been placed behind the riprap. Grass seed had germinated on the fill. Much fine-grained soil had been eroded out of the left bank and deposited in the stream. Trees distorted and/or toppled toward the stream and debris plastered against trees on the left bank indicated a strong flow from the floodplain into the stream over that bank just upstream from the bridge. Apparently water had overtopped the roadway and flowed over the bridge and spilled back into the stream over the left descending bank downstream from the bridge, causing severe erosion of that reach of bank. Water had flowed over a low spot in the roadway and spilled over the left bank and eroded that bank (riprap and backfill had been placed where the bank had been eroded). Cracking in the upper part of the downstream end of the pier suggested that the upstream end of the pier had been scoured and had settled, causing the top of the downstream end of the pier to push against the bridge deck. A crack was noted along the top of the pier extending from the upstream end to the downstream end, suggesting that the settlement of the upstream end of the pier had caused shear stresses in the pier when the two deck slabs had been stressed in compression along the diagonal joint over the pier.

#### **7.12.13 Route 2014 Loyalsock Creek Bridge in Montoursville**

On 26 July 1996, the route 2014 bridge over Loyalsock Creek in Montoursville, Pennsylvania was examined. This large steel truss bridge had been inspected and scour had been noted around the bridge piers; riprap then had been placed around the piers. The bed of the stream had been reshaped by excavation and grading. Riprap had been placed around pier 1 closest to the right abutment, and cobbles from the stream bed had been mounded over riprap around pier 2. A large scour hole had formed in the stream bed around the riprap and some of the riprap had fallen into the scour feature near the upstream end of the pier. Bed sediments at this site included a wide range in particles from sand to gravel to rounded cobbles and boulders. The bed sediments had been derived from sedimentary rocks; many of the pieces of rock were rounded by water transport. Almost all of the sediment pieces on the stream bed were rounded. A twin bridge structure carried I-180 over the creek just upstream from the 2014 bridge. Riprap had been mounded around the bases of the piers of that bridge.

#### **7.12.14 Route 15 Lycoming Creek Bridge in Lycoming County**

On 26 July 1996, the bridge for segment 280 of route 15 over Lycoming Creek in Lycoming County, Pennsylvania, was examined. The bridge consisted of twin spans. Piers are numbered from south to north; piers 2 under both northbound lanes and southbound lanes had been undermined. Piers 3 northbound and southbound also had been undermined as seen in a 1994 inspection. A grouted bag had been placed around the nose of upstream pier 3 and had been exposed after flooding in January 1996. The

left descending bank had been eroded in August 1994, riprap had been placed in 1995, and riprap had been scoured in 1996 around the base of the pier. Riprap had been placed around pier 2 under the southbound lanes when the left bank and an access road to the water company well field had been eroded in 1994, but that riprap had been moved and further erosion had occurred in 1996. In the January 1996 event, the water level had been about 4 m above the water level on 26 July 1996. Water had flowed over the floodplain to the left of the left abutment, and had moved the rock that had been placed around pier 2; eye witness evidence indicated that about 1.2 m of riprap had been scoured around pier 2 under the southbound lanes. Flow had impinged on the long solid pier 2 at an angle, scouring riprap from around the upstream end but depositing sediments in the "shadow" on the left downstream side of the pier. Most of the riprap was hard gray shale, but some of the shale was very fissile and had split along laminae. The long-term durability of this rock would be suspect. The stream approached the bridge at an angle of 70 to 75 degrees to the right descending bank. A surface erosion control treatment, i.e. a geoweb cellular confinement system, was used on the right descending bank (which is a flood protection levee).

#### **7.12.15 Route 4003 Fishing Creek Bridge near Bloomsburg**

On 26 July 1996, the bridge for route 4003 over Fishing Creek, just south of I-80 and off route 42, near Bloomsburg, in Columbia County, Pennsylvania was examined. When this bridge was built in 1923, it was designated bridge 66. Debris including large trees had accumulated around the upstream noses of the piers of this bridge. Both piers at this bridge had been repaired with grouted bags. The bags placed at the bridge appeared to be in good condition in their original positions, but it was impossible to determine if the bags had been undermined. The bridge piers had been founded on bedrock, and the use of bags at this location would appear to be an effective treatment of the rock under the piers, particularly with grout injected behind the bags into interstices between bags and in the rock strata.

### **7.13 WASHINGTON**

In Washington, assistance was provided by Mr. Martin K. Fisher, PE, Hydraulic Engineer, Washington State Department of Transportation, Transportation Building, Rm 2A7, P.O. Box 47329, Olympia, WA 98504-7329 (360-705-7260; fax 360-705-6832).

Mr. Fisher indicated that many problems have developed at bridges where efforts to construct scour countermeasures have been considered detrimental to fish habitat or fish passage. Excavation for toe trenches for scour countermeasures have been cited as a source of turbidity and sediment in streams, and environmentalists and fisheries biologists have objected to such excavation.

#### **7.13.1 US 12 Rainey Creek Bridge near Randle**

On 19 August 1996, the US 12 bridge over Rainey Creek near Randle, Washington, at mile 107.8, was examined. Scour under the left (east) abutment of the bridge had prompted the use of gabions to protect the spill-fill abutments of a simple-span bridge that had been built to replace an earlier, shorter bridge. The abutments of the shorter bridge had been left in place just upstream from the bridge now in use, and a controversy had arisen with the local landowner about removal of those abutments; the Department of Transportation engineers wanted to leave the abutments in place to direct and control the flow toward the new bridge, but the landowner wanted the abutments removed. The abutments had been left in place. In 1993, gabions had been installed to protect the abutments of the new bridge; gabions had been chosen because the bridge opening was considered to be too low for placement of riprap. When a major flood event (nearly the 100-year event) occurred in February 1996, sediments were deposited in the bridge opening to within 30 cm of the bottom of the bridge deck beams.

The channel downstream from the bridge was choked with gravel, large cobbles and boulders. The stream was examined upstream from the bridge site; logging operations on adjacent hillsides appeared to have caused unprecedented discharges and flow of sediments into the bridge opening. The terrain suggested that cobbles and boulders had been moved in debris flows from the steep adjacent hillsides. A small channel only about 40 cm deep had been cut in the surface of the accumulated mass of coarse



sediments, and recent flows had left water marks within the banks of that small channel. The bridge is located where the channel grade changes from very steep to moderately flat. A local resident who stated he had lived for forty years adjacent to the bridge site claimed that the opening had filled with sediments six times since logging operations had begun on the upstream hillsides. Each time the stream had filled the bridge opening, the coarse sediments had been pushed out of the channel, but the excavation was carried only a short distance (20 m or so) downstream from the bridge, and the excavations had shifted the channel gradually toward the left descending bank. Most recently, large riprap had been placed around the abutments of the old bridge and around a portion of the abutments of the replacement bridge, but the riprap had been displaced from over the gabions when the sediments were removed. Some of the gabions that had been installed on the stream banks just downstream from the right abutment of the bridge had been damaged during operations to remove sediments from the bridge opening. The wire baskets were distorted and torn.

In August 1996, the center of the stream channel just downstream from the bridge had been excavated to a depth of about 5 m below the level of the surrounding floodplain. The excavation had damaged the gabions, restored the apparent scoured condition of the channel between the abutments, and formed a catchment for sediments in future floods. At a point about 60 m downstream from the bridge, the sediments mounded on the sides of the stream were higher than the level of the adjacent floodplain. The very heavy load of sediments in Rainey Creek included sand, and rounded gravel, cobbles and boulders. The sediments appeared to be derived primarily from basaltic igneous rocks. The cobbles and boulders were very hard and strong, and appeared to have weathered chemically only slightly in comparison to the mechanical wear and abrasion that had rounded them.

As result of logging operations several zones of slope instability could be seen in the hillside adjacent to the US 12 bridge at mile 107.8. The situation at this site shows the influence of geometric constraints on flow in that the old bridge abutments had directed flow through the centerline of the replacement bridge, but, more importantly, the contraction at the bridge had collected the mass flow of coarse sediments from the hillsides upstream. The excavation of collected sediments and placement of those sediments on the edges of the stream downstream from the bridge had formed an artificial ponding effect that caused the sediments moving downslope from the hillside to accumulate just downstream from the bridge, and then to fill both bridge openings. In order to forestall such accumulations of sediment, the excavation could have been extended downstream to the Cowlitz River, but even such a measure may not have prevented the flow of the coarse sediments from the steep adjacent slopes into the bridge opening and the accumulation of sediments there. Because of the abrupt change in the channel slope at the bridge site, it is highly probable that a cleared channel would fill repeatedly with sediments, but perhaps not as quickly as with the current maintenance practices.

#### **7.13.2 US 12 Cowlitz River Bridge East of Randle**

On 19 August 1996, the bridge at mile 122.7 on US 12 that carries that route over the Cowlitz River east of Randle, Washington was examined. The bridge had been built in 1947. Large masses of timber debris move through the Cowlitz River system, and debris accumulations at this bridge had caused problems, particularly at the west pier closest to the right abutment. The main span of the bridge was supported on intermediate piers at both ends, with one approach span adjacent to the east end of the main span; at the west end of the main span, three piers supported short approach spans between the west abutment and the main truss structure. A log boom had been built over 20 years ago to deflect debris from the west pier of the main truss span; steel H-piles had been driven into the river bed to form vertical supports for the boom. Vertical timber piles had been placed on both sides (channel and bank) of the steel piles, and the logs had been cabled to the upright piles in such a way that the boom could rise and fall with the stream. Mr. Fisher reported that the channel form and position in 1996 was essentially the same as when the bridge was constructed, and that the log boom had performed well in keeping debris off the pier, and in changing the scour around the pier. Only some minor local scour and deposition had occurred around the west-end main pier and around the adjacent pier for the west approach spans.



Riprap had been placed on the right descending bank upstream from the bridge, and larger riprap had been placed around the pier that had been scoured. The right descending bank of the stream had been eroded around the pier at the west end of the main span. The flow in the stream impinges on rock in the valley wall about 200 m upstream from the bridge site and is redirected slightly toward the bridge. The stream banks immediately upstream and downstream from the bridge consist of soil and sediments. Flow strikes the pier at the west end of the main span at an appreciable skew angle (30 to 40 degrees) and has scoured a hole downstream and to the west of the pier, and deposited sediments downstream from the pier. The right descending bank to the west of the pier has been scoured by the flow deflected around the pier. Flow at low discharges appears to be deflected by the valley wall upstream, and deposits sediments around the pier, whereas flow at high discharges appears to have scoured the bed and bank around the pier and rearranged the sediments. The scour problem at this site appears to be primarily a local scour effect of flow around the pier, with scour at the pier and deposition downstream caused by the wake vortex downstream from the pier. A large scour hole had formed downstream and to the west of the pier, with the bank scoured adjacent to the pier, and a wake deposit downstream from the middle of the pier.

Riprap had been placed on the right descending bank behind the log boom. The right descending bank had been eroded; bare banks areas and fallen trees indicated that erosion had occurred recently. About 100 m downstream, a bar of cobbles and boulders had formed in the stream, extending diagonally from the right descending bank toward the left bank. Silt and very fine sand sediments (rock flour) in the stream appeared to have given a milky green color to the water.

A review of the hillsides to the east of the bridge site indicated swathes cut into the timber cover on the hillsides apparently by torrents flowing down depressions and moving rock and debris down those slopes. The log boom has been successful in preventing accumulation of timber debris on the west pier of the bridge, but some scour has occurred around that pier.

### **7.13.3 US 12 Naches River Bridge West of Naches**

On 19 August 1996, the bridge that carries US 12 over the Naches River just west of WA 410 west of Naches, Washington was examined. Scour evaluations for this site had indicated that the bridge was scour-critical, and in 1993, riprap had been placed around the piers and abutments that had been founded on spread footings; the mean size of the riprap had been between 30 cm and 45 cm. Much of that riprap had been removed by a flood event. Before that riprap could be replaced, a flood occurred in February 1996 and caused scour at the east pier of the bridge. The 1996 event was close to a 100-year flood; flow velocity in the center of the channel had been estimated at about 3.5 m/s (12 fps) and the depth of scour had been predicted at 2.7 m (9 ft), or about 1.8 m (6 ft) below the bottom of the pier footings. The long dimensions of the piers was normal to the roadway centerline, but skewed to the apparent low flow channel alignment at about thirty degrees. Flow impinges on the east pier at an angle of at least thirty degrees. That pier had tipped back and downstream into the scour hole that formed downstream from the pier, and the superstructure of the bridge had twisted and cracked; the pier at the opposite (west) side of the channel had been damaged when the deck twisted. Failure on the downstream side of the pier should not be considered unexpected given the alignment of the main channel with the pier, the location of the pier near the east embankment, and the plate-like character of the pier wall. A Bailey bridge had been installed over the damaged bridge while a new bridge was being built upstream from the damaged structure.

The riprap used around the pier had been inadequate in mean size and/or gradation and/or the geometry of the treatment had been inadequate (the mounding and/or extent of the riprap had been inadequate). Prompt replacement and enhancement of the riprap when much of it was removed shortly after initial placement may well have prevented the subsequent failure.

The bedload in the stream consisted of sand and rounded gravel, cobbles and boulders of igneous rock. Riprap had been placed around the damaged piers after the February 1996 flood. Timber sheeting had been driven into the stream bed around the base of pier 3 when it was built. A scour hole had developed around pier 3, but the scour had been deeper around pier 4 that had tipped. Distress was noticed in pier 3 where the twisting of the deck had caused buckling failure on the west side of the downstream end and diagonal tension failure at the top of pier 3.

The replacement bridge is being constructed on a foundation of drilled piers about 3 m in diameter, and the temporary casing for one pier was in place in the stream channel when the site was examined.

#### **7.13.4 WA 24 Yakima River Bridge at Yakima**

On 19 August 1996, the bridge that carries WA 24 over the Yakima River at Yakima, Washington was examined. At this site, impinging flow had scoured and eroded the left descending bank upstream from the bridge and attacked a levee in that reach. Release of irrigation water from upstream reservoirs had augmented flow at the bridge when the structure was examined. Flow separates at the impingement point on the left descending bank, about 75 m upstream from the bridge, and near the right descending bank just upstream from the bridge on the inside of the bend in the channel. The rock levee on the left descending bank had been installed to protect a recreational vehicle park. Scour in the river channel had gone undetected when inspectors had made soundings along the upstream rail of the bridge, but comprehensive soundings and topographic surveys in 1994 revealed a scour hole to elevation 970 ft just downstream from the bridge. The general elevation of the stream bed upstream from the bridge site is about 985 feet. The bridge piers were supported on spread footings founded at elevation 974 ft. The stream had migrated laterally upstream from the bridge, as shown by aerial photographs taken at different times. Large bars had formed and some of those bars supported vegetation. To prevent further scour near the bridge piers, three bendway weirs or "barbs" were installed along the base of the levee along the left descending bank of the stream upstream from the bridge. WSDOT uses the term "barb" to refer to dikes that are overtopped at discharges less than bank-full flow, while "spur dikes" are constructed to be higher than the stage for the 100-year flood. The barbs were built of igneous rock from 30 cm to 60 cm in dimension, in angular pieces of wide gradation. Installation of the barbs in 1994 was facilitated when the landowner was persuaded that the barbs would help to prevent scour of the toe of the levee adjacent to the recreational vehicle park. The three barbs had been built for a total cost of less than \$ 35,000. The barbs were designed to be submerged in the 100-year flood event for which velocities of about 4.5 m/s (15 fps) had been estimated. Floods in 1995-6 had corresponded to discharges between the 25-year event and the 50-year event. Comparative topographic surveys and soundings showed as much as 3.5 m of deposition in the downstream scour hole between December 1993 and December 1994, and data from April 1995 showed that the downstream scour hole had filled completely, while scour holes had formed at the outer ends of each of the barbs. The second or middle barb appeared to be most effective in deflecting flow; the bottom had been scoured to about elevation 976 ft near the middle dike while the bottom elevation was about 981 ft near the first and third barbs. Mr. Fisher stated that the barb closest to the bridge had filled the channel (between the barb and the bridge) with sediment and did not appear as effective as the second barb in August 1996 as it had been when it was installed. In other words, the barb had functioned well, as intended. Furthermore, he felt that the two upstream barbs are less effective than they had been when first installed, because of a shift in the channel upstream from the barbs; that shift had occurred during the early 1996 flooding, and was not part of the planned stream changes.

The barbs had been placed to stop lateral migration of the stream by deflecting the current away from the levee, and reduce scour by training the flow through the center of the bridge opening. Bare areas and distressed vegetation indicated recent erosion of that bank. The bed material in the stream consisted of rounded gravel and cobbles of igneous rock. The riprap, in contrast, was very large, angular pieces of igneous rock including vesicular basalt.

#### **7.13.5 US 97 Toppenish Creek Bridge South of Toppenish**

On 20 August 1996, the US 97 bridge over Toppenish Creek just south of Toppenish, Washington was examined. The total length of this bridge, built in 1931, was about 24 m (81 ft), but the floodplain at this location was about 1.6 km (1 mi) wide. Scour from the severe contraction in flow at the bridge had removed sand and silt from around the three pile bents that support this very low bridge, and a countermeasure was needed. No significant local scour had occurred at the heads of pile bents, but the channel was uniformly degraded. The most likely cause of the degradation was contraction scour,

according to Mr. Fisher. A gabion mattress about 30 cm (12 in) thick around the pile bents and abutments was chosen in lieu of riprap or other measures because of the very low clearance under the bridge; the original bridge opening was too small for the flow, and gabions would not cause a further restriction of flow, as would placement of riprap.

The tops of the gabions baskets were not level, and they appeared to have settled or moved down with the stream bed, or to have been installed over an eroded bed. A flood in February 1996 had overtopped this bridge and the approach embankment beyond the left abutment, as indicated by debris in the trees and brush upstream and downstream from the bridge, and by large accumulations of sediments on the downstream side of the north approach embankment. A considerable stretch of the left approach embankment had been damaged and the pavement there had been replaced. The stream channel had widened downstream from the bridge, but little scour had occurred upstream from the bridge. Sediment had accumulated in bars and islands in the stream, about 5m wide upstream from the bridge, and vegetation was present on much of the upstream banks, bars and islands. Mr. Fisher reported that the gabions had performed excellently during and after the February 1996 flood event. Soundings taken by maintenance crews indicated that no changes had occurred in the channel cross-section since the gabions had been installed.

#### 7.13.6 WA 240 Yakima River Bridge near Richland

On 20 August 1996, the bridge that carries WA 240 over the Yakima River near Richland, Washington was examined. The river bank consisted of conglomerate materials. The rounded gravel and cobbles of the conglomerate were densely packed; a matrix of silt and sand filled the voids between the gravel and cobbles. The conglomerate banks contained steep, nearly vertical slopes at the upper parts of some of the banks. The stream bed was covered with sediments essentially identical in size and gradation to the conglomerate in the banks. The pier in the center of the river had been protected in 1992 by the placement of a countermeasure consisting of small grout-filled sacks, but the depth of the water in the river on 20 August 1996 prevented any view of those sacks. The depth of the Yakima River at this site is controlled by backwater from the Columbia River and is not representative of yield from the Yakima River watershed.

#### 7.14 OREGON

Assistance was provided in Oregon by Mr. David W. Bryson, PE, Hydraulics Engineer, Oregon Department of Transportation, 329 Transportation Building, Salem, OR 97310 (503-986-3363; fax 503-986-3407). Mr. Bryson offered some general comments on the difficulties in designing and constructing scour countermeasures in Oregon because of the sensitivity of the local environment to disturbance if toe trenches or other excavations are made in stream banks. Sensitivity is high particularly at sites where it is proposed to list the fish (e.g., coho salmon, cutthroat trout) as threatened or endangered. Environmentalists have opposed use of riprap whenever such use required excavation of banks or stream beds, and were critical of the esthetics of riprap as a scour countermeasure. To improve the appearance of riprap mounds and treatments, some efforts have been made to spread coarse bed sediments over the surface of the riprap. The finer sediment fractions undoubtedly would fill some of the voids between the larger pieces of riprap and improve its performance under scour but to what degree the scour resistance would be improved is uncertain. Also, use of coarse sediments over riprap would have the effect of smoothing the riprap surface and reducing shear interaction with impinging flows.

A second item of concern in Oregon is construction of bridges and countermeasures to avoid any interference with fish passage, especially passage of salmon. Research is being pursued to develop designs that will facilitate fish passage. Riprap is considered by some persons to be detrimental because it affords harborage for species that will prey on salmon fry. In some instances, riprap has been designed to incorporate welded wire fabric tensile reinforcement and to be grouted after placement.

In passing, Mr. Bryson noted that the February 1996 flooding in Oregon was most severe in the Willamette Valley and that the most serious problems associated with flooding had occurred near Portland.

Numerous slope failures had caused landslides and rock debris flows that disrupted and/or blocked roadways for weeks. Blockage of flow sections by timber debris had not been particularly serious in the February 1996 floods, but accumulation of woody debris at bridges in Oregon has been a perennial problem on some streams. Gravel mining has been a problem in past years, but gravel miners now usually are permitted only to scalp the surface layers of coarse sediments above preset elevations on bars in the streams. One location where gravel mining is suspected to have contributed to channel degradation was the McKenzie River where scour had occurred at structures for I-5.

#### **7.14.1 Willamette River Banks in Salem**

On 21 August 1996, the banks of the Willamette River in Minto Brown Island Park in Salem, Oregon were examined. Igneous rock riprap that had been installed at this site. The Corps of Engineers had compacted the riprap surface by impacts from large steel plates, and that "plating" had broken some of the rocks and aligned most of the rock pieces to produce a smoother final surface on the treated banks. The riprap had been in place since the early 1980's and appeared to have performed well.

#### **7.14.2 OR 22 Gooseneck Creek Bridge near Buell**

On 21 August 1996, the bridge that carries OR 22 over Gooseneck Creek at mile 4 near Buell, Oregon was examined. In 1965, the channel under the bridge had been paved because of degradation in the shaley bedrock under the footings of the bridge piers. More than 2 m (6 to 8 ft) of degradation had occurred in the bedrock below a conglomerate layer. Approximately 3 m (10 ft) of degradation had occurred at this site since 1934 when the bridge was constructed. Gabions were used to construct a drop structure and to protect the footings of the interior of the bridge in October 1990. The downstream apron of gabion baskets abraded and failed within two years, and the channel continued to incise below the downstream edge of the concrete paving. The shaley bedrock appears to degrade most severely in cycles of wetting and drying. The center gabions were scoured out, and more than 60 cm (2 ft) of channel degradation occurred during the February 1996 flood. [The damaged treatment was repaired in October 1996, subsequent to this examination, using riprap reinforced with horizontal layers of welded wire fabric, and surface grouted.] Long-range plans for the site include a fish ladder.

A small check dam had been built from bed sediments near the right descending bank; the check dam had not been built by the Oregon Department of Transportation, but apparently by local property owners to deepen the stream for recreation. The stream banks consist of surface layers of silty sand alluvium grading downward into very coarse sediments. At a depth of 1 m to 1.5 m, a layer of conglomerate was visible in the stream banks; the conglomerate consisted of a silty sand matrix among rounded gravel and cobbles, and the orange color of the conglomerate indicated deposition of iron oxides by groundwater. At a depth of about 3 m below the surface, the conglomerate was underlain by gray shaley bedrock. The bedrock appeared to slake and degrade readily when it was exposed to wetting/drying.

The gabions that had been placed as a wingwall downstream from the left abutment of the bridge had been distorted near the edge of the channel, apparently by impacts from large coarse sediments and timber debris, and rock was missing from some of the baskets. The channel pavement had been undermined at the downstream edge of the pavement, because the gabion drop structure had washed out.

Sand, gravel and cobbles were typical of the bedload observed upstream and downstream from the structure. Grouted bags had been placed at the top of the bank slope under the right abutment above the channel pavement. The banks of the channel upstream from the bridge appeared to be very stable, with large trees growing at the edges of the cobble-bed channel. The problem at this bridge was caused by the channel degradation in the bedrock, that had extended progressively upstream into the bridge opening. Channel degradation is expected to continue at this site.

### 7.14.3 OR 58 Salmon Creek Bridge at Oakridge

The OR 58 (Willamette Highway) bridge over Salmon Creek at Oakridge, Oregon was examined on 21 August 1996; the bridge is located at mile 35.98. Salmon Creek had been a braided stream with bank erosion on both banks when the stream channel was straightened in 1959 by the Corps of Engineers. The stream was given a trapezoidal cross-section, about 56 m (185 ft) wide at bottom, with side slopes of vertical on 2 horizontal. The right descending bank of the stream had been eroding and property in Oakridge had been in danger of flood damage before the channel was modified. After the modification, the channel degraded to the point where the stream no longer posed a flood threat to the town, and the maintenance of the channel could not be justified under funding for flood control activities. Channel maintenance was abandoned in 1987. Since channel maintenance stopped, large gravel bars have formed in the channel, which direct the flow into the banks. As a consequence of that flow deflection, the banks have eroded in some areas. The 100-year flood event would be contained wholly within the trapezoidal section.

When the Salmon Creek bridge was built in 1990, scour was anticipated around the bridge piers; the bridge consists of a center span 42 m (140 ft) long, with short side spans about 12 m (39 ft) long on each end. The end abutments and the two bridge piers are supported on spread footings. An articulated block mat was installed on each bank, apparently from the centerline of the interior pier bents down the bank slopes to the channel sides. Plans had called for the bank treatment to be secured to anchors in the faces of the concrete bent walls, according to details on the plan sheets. However, the final treatment consisted of fabric-formed bags filled with concrete and tied with polyester cables 6 mm (0.25 in) in diameter, in panels approximately 16 m (53 ft) long, extending up the bank from a toe trench 1.8 m (6 ft) deep to an anchor trench 40 cm (1 ft 4 in) deep upslope from the bent centerline (the clear slope distance between the trenches was about 13.5 m or 45 ft). Filter fabric was installed below the articulated block mat, but no fabric was visible at the site. The upstream and downstream ends of the mattress were to be installed in anchor trenches (perpendicular to the stream flow) about 1.2 m (4 ft) deep. Similar anchor trenches were to be used where panels were overlapped up the bank slopes, to form expansion joints perpendicular to the stream flow. Plans had called for the ends of the mattress to be curved (arc segments between the toe trench line and the end slopelines of the mattress) so that the planform of the mattress would include an upslope edge parallel to the abutment, and a toe edge parallel to the abutment, with rectangular upslope corners and rounded downslope corners. However, the "Armorform" articulating block mat, manufactured by Nicolon Corporation, that was installed could not be shaped to provide rounded corners, so the constructed treatment had a rectangular planform on each bank. The panels placed down the slopes were joined in places with zipper connections. No drains had been constructed in the mattress, but the coarse gradation of the bank material suggested that it would drain freely.

The upstream edge of the mattress protecting the right descending bank had been flanked by the river. The problem at this site was not caused by contraction of flow but by lateral migration of the stream into the right descending bank. The countermeasure used to protect the bridge piers was not totally successful; in February 1996, a flood corresponding to about a 17-year event had caused some of the grouted bags to be torn from the mattress. The use of the mattress had been documented by the Research Unit of the Oregon Department of Transportation in several reports. The mattress had been selected for use because historically, riprap had not been effective in protecting the banks. Since construction of the mattress, maintenance forces have dumped loose riprap around the upstream edge of the mattress protecting the right bank, on two occasions.

The upstream edge of the articulated block mat had been torn and several bags or blocks had been ripped from the mattress near a large corrugated metal drainage pipe in the stream bank. The failed area had been scoured and eroded, and the eroded cavities had been repaired after the February 1996 floods by filling the cavities with large angular pieces of riprap. Some of the individual blocks had been torn from the mat, while other blocks or bags had been split.

The bed sediments in the stream included boulders as large as 30 cm (1 ft) in diameter, rounded cobbles, rounded gravel and sand. Almost all of the bed sediments, as well as the riprap, consisted of

pieces of igneous rock. Many of the rounded cobbles and boulders were pieces of basalt that contained numerous gas bubbles and cavities.

Undermining of the toe edge of the mat, with consequent tension in the fabric between the bags or blocks, had caused the fabric to rip.

Below the vertical right abutment wall, a standard ODOT pavement of concrete blocks had been constructed, but that pavement was different from the articulated block mat. The mat on the easterly bank was secured to the bent wall with eye bolts, in a connection similar to that shown on the construction plans. With this connection system, it was difficult to maintain a straight horizontal seam on the mattress. The mat on the westerly bank was not secured to the bent wall, but was secured to a rebar driven into the ground at the toe of the wall. Apparently, with the rebar anchoring system, better horizontal control of the mattress was possible. The alignment was controlled by loosening or tightening the rope which connected the rebar to the mat, as shown in construction photographs.

Downstream of the bridge the stream contained numerous bars separated by braided sub-channels.

All of the panels were zippered together at construction but some sections or panels of the mat were joined in what appeared to be welded seams. Use of the zipper connections eliminated the need for an overlap joint between panels, as had been shown on the original plans. The mat had been installed without edge trenches and did not appear to be even marginally flexible, as indicated by the tearing of the mat around the drain pipe in the bank upstream from the right abutment. Tapping on the blocks and grouted seams around the pipe indicated that soil had been removed from under the mat around the pipe and that the mat was bridging over voids.

The situation at this site is symptomatic of problems that occur with planar treatments like mats or mattresses when the edges of the treatments do not provide gradual transitions in flow interaction and/or scour resistance, or where abrupt transitions are not sufficiently robust to resist scour and erosion forces at the edges of the treatment. Very turbulent, nonuniform flow could impinge anywhere on this treatment because of the character of the braided stream reworking its channel.

#### **7.14.4 Coquille River State Highway Bridge in Coos County**

On 22 August 1996, the state highway bridge over the South Fork of the Coquille River at Powers in Coos County, Oregon was examined. The pier on the north or left bank of the stream in front of the left abutment of the bridge had been protected with small grouted bags placed at very steep slopes around the pier base, in 1985. Between the left abutment and the protected pier, the slope had been eroded around several of the piles in bents under approach spans. The 77-m (256-ft) center section of the bridge consisted of two identical steel trusses supported on three piers, but six short approach spans connected the north abutment with the trusses, and seven short approach spans connected the trusses with the south abutment. The short approach spans were supported on timber beams and timber pile bents, and were 6 m to 7 m (20 ft 8 in to 23 ft 2 in) long. Groundwater flowing out of the north (left descending) bank had produced several large cavities around timber piles. These cavities were as much as 1.3 m deep and 1 m in diameter, and the gully that extended from the cavities down the bank.

Grouted bags had been placed around the base of pier 1. The bed sediments included sand, and rounded and subrounded gravel, cobbles and boulders. Most of the bedload appeared to be hard and competent rocks of igneous origin, but some cobbles appeared to be composed of a cemented fine-grained substance that might have been volcanic ash; those cobbles broke into small sharply angular fragments on impact with other rocks.

Some of the Sakrete sacks were deteriorating. The massive pile of sacks appeared to be very rigid and apparently had settled and tilted away from the face of pier 1. The treatment had been undermined by scour at the downstream toe of the mass of sacks. It is questionable how well this rigid mass of hardened sacks would function if the toe of the treatment were severely undermined; in comparison to mounded riprap, this mass could not fall into and armor a scour hole.

## 7.15 TENNESSEE

### 7.15.1 Hatchie River Bridge in Jackson

An inquiry was made on 24 June 1996 to Mr. Ed Wasserman (615-741-3351) of the Tennessee Department of Transportation in Nashville concerning the situation at the Hatchie River bridge that had been proposed for examination for countermeasures against local scour at piers. Mr. Wasserman is one of the engineers performing bridge scour assessments for Tennessee.

After the failure of the older section of the Hatchie River bridge, countermeasures were used to try to prevent lateral migration of the stream with consequent removal of support from piers that were supported on short piles and shallow foundations. The bridge built in the 1960's included a pier on the north bank of the river that had a very shallow foundation. Large heavy riprap was placed on the channel and banks of the stream as a scour/erosion countermeasure. To provide protection for the bridge built to replace the fallen structure, deep foundations were carried down to below scour depths predicted by currently used equations. The principal problem at the Hatchie River site was lateral shifting and migration of the stream, not local scour, according to Mr. Wasserman.

After riprap had been placed in 1991, additional studies were done to investigate means to arrest the northward shifting of the stream. Attention was directed to the use of groins (training dikes) to be built along the outside of the bend upstream from the bridge; the groins were to be built with stone. The tentative construction schedule calls for groin construction in 1996-7, but only design sketches (not plans) had been prepared by June 1996.

Mr. Wasserman indicated that water levels on the Hatchie River in June would preclude any visual inspection of the riprap around the piers and in the channel; not only would the water be over the riprap, but the water would be very turbid. Riprap on the upper portions of the banks could be examined. With the decrease in discharge typical of late autumn in western Tennessee, the Hatchie River should be sufficiently low and clear to allow limited viewing of the riprap around piers. If an examination was to be made, Mr. Wasserman would assist in coordinating the visit with regional bridge inspectors located in Jackson, Tennessee.

With regard to innovative scour countermeasures, Mr. Wasserman stated that riprap is used almost exclusively in Tennessee to prevent local scour at bridge piers. Gabion mattresses have been proposed for bank treatments at some bridges, but local contractors have experienced difficulty in trying to place gabion mattresses, so that current practice is directed exclusively to dumped riprap. Mr. Wasserman expressed misgivings about the feasibility of articulated concrete mattresses for use around piers in Tennessee streams because of the difficulty in constructing filter layers or placing geosynthetic filters below such mattresses.

A subsequent inquiry was made to Mr. Wayne Seger of TennDOT (615-741-4044) in Nashville. Seger said that the Hatchie River spur dike field was being planned but had not been constructed yet. In response to questions about countermeasures other than riprap, Seger said that spur dikes had been used at the abutments of the I-40 bridge over the Wolf River in Shelby County near Memphis, that the dikes had been in place for more than 20 years, and that they had been successful. In addition, on State Route 50 at the bridge over the Buffalo River between Nashville and Memphis, spur dikes had been used successfully, but the dikes are difficult to see because they are overgrown with vegetation. In Memphis itself, on the Wolf River, the Corps of Engineers has a river training project where spur dikes and groins were used on the outside of a large (180 degree) bend in the river, to prevent further lateral migration of the stream; the river makes a 90-degree bend just downstream from the armored reach, to enter a bridge. The contact for more information about the Corps work is David Wolfe (901-544-3968), who replaced Dewey Powell who is no longer with the Corps. The Corps has done much work on Nonconnah Creek, to prevent erosion and scour. The creek has been channelized and the area around the headwaters of the creek has been developed rapidly with much paving of surface and acceleration of runoff. In 1980, a partial collapse occurred at a bridge that carries Perkins Road over this creek. Gabions and riprap have been used in the headwaters area south of the city to prevent or delay erosion of the sandy silt soil of the creek banks. At another site in

Memphis, the city used gabion baskets to protect a bridge against scour. The three-span structure was supported on pile bents, but scour of the stream bed had occurred. The banks at the bridge were so steep that riprap would not stay in place at those slopes, so gabions were laid along the bottom of the channel, covered with slush concrete, and used to support more gabions on the steep slopes adjacent to the channel. The gabions on the slopes were arranged in tiers, stepped back into the sandy soil of the banks. TennDOT has been cautious in use of gabions in western Tennessee because of problems with abrasion of wire by sandy bed loads. At Reelfoot Lake, at a spillway, gabions about nine inches thick had been used but had deteriorated severely when sandy sediments had abraded the wire baskets. Use of PVC coating on the wire had slowed the abrasion, but loss of metal was still serious. When riprap is used around piers in Tennessee, no attempt is made to place a mineral filter (small gravel) or a geosynthetic filter below the riprap, because prior experience has shown that the thickness of a mineral filter layer is difficult to control, and because dumping riprap punctures fabric filters. To prevent loss of soil through the riprap, specifications for the stone have been written to govern the layer thickness and the gradation of the rock to achieve a "self-filtering" blanket.

Mr. Seger spoke further about scour countermeasures when he was interviewed in his office on 15 October 1996; he stated that debris accumulations around piers is a serious problem in central Tennessee. Debris accumulations had been one of the suspected causes of the partial collapse of the Perkins Road bridge over Nonconnah Creek, near Memphis. In answer to a question about scour and erosion in rock, Mr. Seger indicated that he had not heard any discussion of scour in rock exposed when overlying soil is removed and piles driven to rock are exposed. Two problems can be caused by such removal: lack of lateral support for piles resting on a smooth rock surface may lead to sliding failures; and removal of overburden may lead to scour of the exposed rock if that rock was broken into small fragments when efforts were made to drive piles into the rock. Mr. Seger mentioned that pile bents have been supplemented by grade beams installed at ground level, when there has been a serious concern for pile buckling if overburden soil was removed from around the piles. Piles are not used in Tennessee unless the depth to rock is 3 m (10 ft) or more.

#### **7.15.2 Bridges near Memphis, Hardin County, and Humphreys County**

In addition to the sites in Shelby County, Mr. Seger discussed problems at a bridge for Route 19 over a drainway in the floodplain of the Mississippi River in Lauderdale County, north of Memphis, problems with local widening of Turkey Creek at a bridge for state route 15 in Hardin County, channel migration of Sugar Creek at bridges in Humphreys County, as well as other problems with scour at piers of other bridges.

Two bridges carry state route 175 (Shelby Drive) over Nonconnah Creek in Shelby County, southeast of Memphis; both bridges were examined on 16 October 1996. At the bridge east of Reynolds Road, downcutting of the east fork of the creek had extended upstream toward the bridge and the City of Memphis had placed riprap over the bed of the creek under the bridge, and then had covered the riprap with slush concrete. The concrete had been extended up the slopes of the creek banks around the two bridge piers and over grouted bags on the fill slopes of the two abutments. The downstream edge of the slush concrete had been undermined and had broken. Riprap had been placed on the stream bed and had been undermined, and large cavities formed in the soil strata below the riprap. Layers of stained, partially cemented medium gravel, interbedded with layers of clean fine to medium brown sand were apparent. Immediately under the riprap, the soil was very silty and possessed significant apparent cohesion. Water apparently had seeped under the concrete bed treatment, through the riprap and through the underlying layers of sand and gravel; emergent seepage had produced large cavities in the faces of the sand-gravel layers under the riprap. The bank strata consisted of silty sands over the clean brown sand, and upper zones of very silty, apparently loessial, soil. The top 1.5 m of bank appeared to be loess, and was standing at vertical slopes. Below the loess, emergent seepage had produced lenticular cavities in the face of a sand stratum, and had undermined the loess layer. Below the cavities in the sand layer, a nearly vertical face exposed silty sand layers, stained and partially cemented by iron compounds, with a total thickness of



about 2 m to 2.2 m. Moss growing on the vertical faces of those layers indicated that those faces remained stable for considerable periods of time. Root systems were present throughout the upper silty layers; the roots were oriented nearly vertically.

A very large erosion hole was located just downstream from the edge of the slush concrete. The stream had migrated to the west around a large accumulation of riprap, large blocks of limestone, pieces of cemented natural conglomerate, and very large slabs of waste concrete, that had been deposited along the original course of the stream downstream from the bridge. All of the limestone had been imported to the site, since such rock is not available in Shelby County. The stream bed had been eroded and scoured over an area approximately 45 m in diameter. The banks of the stream were essentially vertical, and the stream had widened the erosion hole after rock was placed on the stream bed. This feature cannot be termed a scour hole because the soil has been removed by a combination of plunge-pool action at the edge of the concrete channel cover, headcutting by the creek, and erosion by seepage emerging from the downstream end of the treatment. Most of the rock riprap consisted of subangular gray fossiliferous limestone. The lateral migration of the stream had caused relatively recent erosion and bank sloughing, as indicated by the fact that trees fallen from the tops of the banks were still in leaf in mid-October. Numerous trees near the tops of the banks had been undermined severely, but were still green with leaves.

Very large rock had been placed on the stream bed downstream from the bridge in an effort to counteract the headcutting tendency of the stream. Downstream from the large erosion feature where the stream had migrated around the accumulation of rock downstream from the bridge, the width of the stream decreased to approximately the same width as was observed upstream from the bridge, but the heights of the banks on both sides of the stream were about twice the heights of the banks closer to the erosion hole.

The center of the erosion feature was approximately 40 m downstream from the centerline of the bridge. Downstream from the bridge, the bed of the creek had been protected with riprap with a median size of about 25 cm and a maximum size of about 50 cm. The riprap consisted of very angular pieces of limestone. The right descending bank of the stream had been cut upstream from the bridge where a drainage ditch parallel to Shelby Drive entered the stream about 12 m to 15 m upstream from the bridge. The size and locations of the trees in that ditch indicated that any erosion along the ditch had occurred fifteen to twenty years before the 1996 examination. Very large trees were observed growing at the water's edge along the stream upstream from the bridge, and the banks there appeared to be stable.

The slush concrete had been extended up the abutment fill slopes around the bases of the piles in the bents for the piers. At the upstream edge of the concrete bed treatment, near the right (northeast) abutment fill slope, the concrete treatment had been undermined. The riprap on the stream bed had been supplemented by a concrete barrier about one meter deep, along the upstream edge of the concrete bed treatment, about 5 m upstream from the upstream fascia of the bridge. Several of the grouted bags on the fill slope had been undermined and displaced. Sparse remnants of burlap bags were found at the upper parts of the abutment fill slopes, but on the lower slopes, the burlap had worn away from the cemented sand that had been used to fill the bags. The bags appeared to have been tamped after placement so that the bags deformed, fitted together in a rather tight cover over the slope, and presented a relatively smooth surface on the fill slope. Soundings around the bases of the piles indicated (by a hollow drumming sound) that the concrete around the east (right) bank piles had been undermined along the entire length of the pier, and that the concrete around the two most upstream piles of the west pier also had been undermined.

### **7.15.3 Nonconnah Creek Route 175 Bridge**

The state route 175 bridge over the west fork of Nonconnah Creek, west of Reynolds Road, also was examined on 16 October 1996. The stream was virtually stagnant at the time of the examination. The mature, large trees on both banks of the stream at the water's edge indicated apparently stable conditions. A large erosion feature was evident just downstream from the edge of the concrete treatment on the bed of this stream. The center of the erosion feature was about 75 m downstream from the bridge. The stream bed under the bridge had been covered with concrete over riprap, and the concrete had been extended up around the bases of the piles in the piers on both sides of the stream.

The northwest pier at the toe of the spill fill slope apparently had consisted of five vertical concrete piles, as did the southeast pier, but four vertical replacement piles had been driven between the five original piles, and a batter pile had been driven at each end of the bent. A new cap beam had been cast around the original cap beam at the top of the northwest bent. The fill slopes of both abutments had been protected with burlap bags filled with sand and cement; the bags had been tamped to provide a relatively tight, smooth treatment. Slush concrete had been extended up around the bases of the piles and over the bottom portions of the grouted bag treatments on the spill fill slopes.

The stream channel upstream from the bridge appeared to be stable, as did the banks upstream from the bridge; the stream upstream from the bridge was about 6 m to 7 m wide. Downstream from the bridge, the stream had eroded a very large hole. The elevation of the concrete bed treatment at the bridge was about 2 m higher than the elevation at the downstream edge of the treatment, about 30 m downstream from the bridge.

The banks of the stream were essentially vertical, with very extensive undercutting into sandy layers and undermining of overlying loessial strata. The upper layers of bank soils consisted of loess, with intervening sand lenses, over silty sand layers about 2 m thick, over clean sand and partially cemented gravel beds near the elevation of the riprap around the pile bents. A sand and gravel bar was present to the northwest of the hole and to the southeast of the laterally shifted stream. The stream had migrated to the west and north around the large rock that had been placed on the stream bed to counteract the tendency for headcutting. The erosion cavity had been formed as a result of water plunging off the downstream edge of the concrete bed treatment, emerging from under that same edge and causing erosion of the soils under the treatment, and migration of the stream around the large rock placed downstream from the bridge. A broken segment of reinforced concrete pipe was visible under the center of the channel, at the downstream edge of the bed treatment. Seepage emerging from the faces of the relatively porous zones under the concrete bed treatment had eroded those faces, undermining the edge of the treatment, and large pieces of the concrete had broken off the edge of the treatment.

About 100 m downstream from the bridge, the stream alignment was almost due east, at the downstream limit of the lateral shift or bend around the mass of large rock downstream from the bridge. The stream was aligned approximately northeast-southwest at the bridge. About 100 m downstream from the bridge, the width of the stream downstream from that point was virtually the same as the width of the stream upstream from the bridge. A large sand and gravel bar in the stream was obvious. The stream had migrated around the large rock placed on the bed, in a comma-shaped curve that subtended an angle of at least 200 degrees. The elevation of the water in the erosion hole was about 3 m or more lower than the water elevation immediately upstream from the bridge, so that a persistent significant hydraulic gradient would have existed to drive seepage under and around the concrete bed treatment, and out of the pervious bank soils into the erosion hole. The stream had degraded its bed for more than a meter relatively recently, as indicated by a stump with vertical roots in the stream downstream from the bridge.

The rock that had been dumped downstream from the bridge consisted of shaley limestone and shale, with some waste concrete. The shaley fragments of rock had degraded and fractured from exposure to wet-dry cycles and freeze-thaw cycles. Sand and gravel had been moved along the bed of the stream and deposited with the rock, and some silty sediments had been deposited over the sand between the rock fragments.

The contrast between the conditions upstream from the bridge and conditions downstream from the bridge was a dramatic testament to the power of the combined effects of headcutting, emergent seepage, plunging flow, and contraction scour effects at this bridge over Nonconnah Creek.

#### **7.15.4 Nonconnah Creek Quince Road Bridge near Memphis**

The bridge that carries Quince Road over a tributary of Nonconnah Creek southwest of Memphis, Tennessee, was examined on 16 October 1996. Mr. Seger stated that gabions had been placed in stair-step configuration to stabilize the very steep abutment slopes at this bridge, and that the bed of the stream between pile bents had been covered with concrete. Grouted burlap bags had been placed on the abutment

slopes also. No transition had been constructed at the downstream edges of the bank and bed treatments. Debris had accumulated around the upstream noses of the piles. Grouted bags had been displaced on the slope, and local scour had occurred around the bases of two downstream piles. The grouted bags had been undermined and the bed had been scoured around the bases of two piles; apparently, the concrete bed treatment had been undermined and had fractured, and the fragments had been displaced to expose the pile bases. At the upstream edges of the grouted bags treatment on the left descending bank, the grouted bags had been undermined, and some bags were missing. The bags had been undermined at this point, and several bags had been moved from their original locations. The undermining of the bags and concrete bed treatment shows the importance of gradual and/or robust transitions between unprotected banks/bed and bank and bed reaches treated to prevent erosion and scour.

#### **7.15.5 Nonconnah Creek Perkins Road Bridge in Shelby County**

On 16 October 1996, the Perkins Road bridge over Nonconnah Creek in Shelby County, southeast of Memphis, was examined. The bridge was supported on two piers on the south (left) abutment slope, three piers in the channel, and two piers on the north (right) abutment slope. In 1980, the upstream half of the piers at the toe of the south abutment slope failed, the supported span dropped, and one individual was killed in an ensuing accident. At the location where the piers were scoured and undermined, only a small pile bent was installed after the accident, to support a large pipe aligned parallel to the upstream fascia of the bridge and under the edge of the northbound lanes. Debris had collected around the upstream side of the two-pile bent, and the flanges of the steel H-piles had been bent by objects striking the upstream sides of the piles. The undermined concrete piers were not replaced, but the bridge was repaired using deeper steel beams fitted with additional plates along the bottom flanges of the rolled sections used for the beams:

The piers under the downstream half of the bridge, for the southbound lanes, appeared to be original construction; under the upstream half of the bridge, piers consisted of square column elements with concrete webs constructed between the columns. The solid-web piers had been placed under the northbound lanes and under what would have been an open median between the northbound and southbound lanes; the bridge apparently had been widened. The bottom flanges of the original beams had been left longer than the webs of those beams, and had been fitted into slits in the webs of the replacement beams, with fillet welding between the two adjacent sections of steel.

The stream bed under the bridge had been paved with reinforced concrete over riprap to prevent further scour of the bridge piers. The full width of the stream between abutment fill slopes was covered with concrete. Rock had been placed upstream and downstream from the bridge, and some of that rock appeared to have been displaced downstream. The large subangular pieces of rock on the stream bed consisted principally of shaley limestone. Several large bars of sand and gravel had formed in the stream downstream from the bridge, mainly along the right descending bank.

The concrete pavement had been undermined slightly, under the downstream edge where a gap existed between the bottom of the pavement and the tops of steel sheetpiles that had been driven into the bed at the edge of the pavement.

#### **7.15.6 I-40 Wolf River Bridge in Shelby County**

The bridge for I-40 over the Wolf River north of Memphis, in Shelby County was examined on 16 October 1996. At this location, the river bends from an essentially north-south course and turns almost due west to flow under the bridge. A large tributary stream flows into the river from the south, at an angle of at least 40 degrees. Bars deposited in the stream under the bridge showed ripple marks and other features that indicated the bars had been formed by flow from the Wolf River moving sandy sediments toward the bridge. At the time of the examination, however, significant flow was entering the river from the tributary stream and the southern edges of the bars had been eroded by the tributary flow. A circular sheetpile structure had been erected on a bar at the confluence of the river and tributary, but the structure had been damaged and the piles had pulled out of interlock so that the north half of the circle was displaced to the west and bent out of a vertical alignment.

Spur dikes had been installed along the left descending bank of the Wolf River upstream from the I-40 bridge, but sediments had deposited over and around the dikes so thoroughly that they could not be seen readily; deep shadows from the trees along the left descending bank precluded taking photographs of the spur dikes and the protected bank.

To the west of the I-40 bridge, Wolf River is crossed by an older bridge for U.S. 51; the highway is aligned essentially north-south, and the river flows almost parallel to the highway before bending approximately 90 degrees to flow due west under the bridge. A local route intersects U.S. 51 just south of the bridge, and erosion of the left bank of the river had endangered that route and a large industrial facility to the south of the river along the east side of U.S. 51. The Corps of Engineers had installed riprap along the left bank, and, in a project sponsored jointly with TennDOT, had built spur dikes upstream from the bridge in 1993. The bridge piers adjacent to the south (left) abutment of the bridge had been founded at higher elevations than the piers in the central channel of the river, and concern had been felt for continued erosion of the left bank.

#### **7.15.7 US 51 Wolf River Bridge**

The U.S. 51 bridge over the Wolf River was examined on 16 October 1996. Four piers adjacent to the left abutment supported approach spans, and those piers had been founded at elevations higher than the founding elevations of the main channel piers. Debris had accumulated around the bases of the piers in the main channel of the river, and on the tops of the spur dikes. The upstream right bank appeared to have been eroded recently as indicated by trees fallen from the top of that bank. The riprap consisted of subrounded pieces of shaley limestone with numerous inclusions of shale and fossils with a median size of about 30 cm.

Deposition between the spur dikes since their installation in 1993 was obvious. In addition to the spur dikes, rock had been installed on the bed of the stream under the bridge. Sand and gravel bars had been deposited on the bed of the river, and the width of the river at the railroad bridge was approximately equal to the width of the stream upstream from the U.S. 51 bridge. The major problem at this site was the migration of the river into the left descending bank, with potential scour and undermining of the bridge piers adjacent to the left abutment of the bridge, and the bank treatment and spur dikes appeared to be effective in retarding such migration.

#### **7.15.8 US 51 Hatchie River Bridge in Tipton County**

On 16 October 1996, the U.S. 51 bridge over the Hatchie River at the boundary between Tipton County and Lauderdale County, Tennessee was examined. Piers at this site had been undermined and when a span of the bridge collapsed, eight lives were lost in ensuing accidents. The original bridge piers, supported on short piles, had been replaced. Plans had been developed to build a series of spur dikes along the river upstream from the bridge to deflect the erosive action of the stream away from the area of previous undermining. The river approaches the bridge at a significant angle so that the thalweg of the river approaches the northeast (right descending) bank. Deposition was evident over the rock riprap on the left bank

#### **7.15.9 Route 19 Relief Bridge at Shoaf's Island in Lauderdale County**

On 16 October 1996, a relief bridge for state route 19 at Shoaf's Island road, about 19 km west of U.S. 51 in Lauderdale County, Tennessee was examined. At this point in the floodplain of the Mississippi River, flood flows inundate an area about 16 km wide between the main channel of the river and the bluffs that border the floodplain to the east. Numerous small relief bridges have been built to pass water under state route 19 which is aligned essentially east-west across the floodplain; the overflow from the floodplain is considered part of the drainage into the lower Forked Deer River that enters the Mississippi River about 10 km northeast of the bridge. The Mississippi River is aligned southwest-northeast close to state route 19, and the terrain northeast of the relief bridge is very low and supports widespread swamps. At this site, two small bridges had been supported on timber piles, but those structures had been scoured and undermined,

and had been replaced in 1988 by a larger bridge approximately 41 m long, and a pipe installed to the west of the bridge. The replacement bridge was founded on concrete piles about 7 m long; two piers were spaced at the third points of the bridge length, and abutments and piers were supported on piles. In April 1994, the replacement bridge failed when one of the piers was scoured and failed; the continuous steel bridge sagged over the location of the failed pier, and eventually failed. The scour hole under the bridge included the entire width of the channel between abutments and extended upstream about 16 m and downstream about 17 m. The flood event had a recurrence interval of less than ten years. A third bridge was built in 1994, to the same plan dimensions as the second bridge, but the new bridge was supported on steel pipe piles; the piles under east abutment were 7.5 m to 11m long, but the piles under the piers and west abutment were as much as 39 m long. The scour hole, approximately 6.5 m deep under the center of the bridge, was filled with No. 57 stone and capped with a layer of riprap 75 cm thick, and the riprap was extended over the channel under the bridge and up the fill slopes of the abutments. The riprap was Tennessee Class B stone. The riprap on the abutments was extended upstream in guide banks; the guide bank on the right (west) abutment was about 22 m long, but the guide bank on the east abutment was more than 30 m long. In spring 1996, a scour hole had formed adjacent to the right bank guide bank near the location of a 60-cm pipe through that bank; that scour hole was about 17 m in diameter and was about 5.5 m deep. When the bridge was examined on October 16, the scour hole was being filled with riprap.

Contractor personnel had sounded the water under the bridge and found it to be about 1.7 m deep on 16 October 1996. In contrast, the scour hole had been sounded at 7.5 m deep before filling began. It appeared that the larger guide bank on the left abutment had deflected flow and caused the formation of the scour hole. Contractor personnel and TennDOT maintenance supervisors stated that more than 450 tons of rock had been placed in the hole at the time of the site visit. The elevation of the floodplain upstream from the bridge was almost equal to the elevation of the lower chord of the bridge beams; scour at this site would not decrease the head across the opening materially because the increase in conveyance caused by the scour would not affect significantly the water surface elevations upstream and downstream from the bridge.

#### 7.16 FLORIDA

The problems encountered with the installation of scour countermeasures for the Acosta bridge in Jacksonville Florida was discussed with Ken Hill (Ph# 1-904-356-9696) on August 19, 1996. Of primary concern was the deep water placement of scour countermeasures. Inspection by divers had indicated large subterranean cavities under the river bed. At the time of discussion the long-term effect these cavities may have on the scour countermeasures installed was not apparent. The deep water conditions at the bridge prevented any inspection by the team.

Following the discussion a visit was made to Dr. Max Sheppard of the University of Florida in Gainesville. Dr. Sheppard has conducted numerous studies for the Florida DOT to assess the scour potential of pier designs. Many of the designs he has evaluated involve the effects of site specific complicated multiple support pile piers. As mentioned by Mr. Hill and others he also stated that Florida is faced with very fine sand of approximately 0.2 mm in diameter.

#### 7.17 MISSISSIPPI

Discussions were held with Mr. Warren Bailey and others at the offices of the Mississippi DOT on August 28th, 1998. Following the discussion, a site visit was undertaken to evaluate a river training structure located just upstream of the Lakeland Drive crossing over the Pearl river in Jackson. The site is located in an area of ongoing urban development which has substantially encroached upon the flood plain. This encroachment has directly affected the river reach by confining flood flows, which had previously been allowed to expand over the flood plain, to the river channel. The structure which consists of a permeable dike extending at a flat angle into the river was placed to redirect river flows and promote long term sediment deposition downstream from the structure. At the time of the visit a significant quantity of fine grained sediment had deposited downstream of the structure under the bridge.

## **7.18 ALABAMA**

### **7.18.1 I-65 Bridge South of Huntsville**

An inquiry was made to the office of Mr. Leon Pinkston of the Alabama Highway Department in Montgomery (334-242-6624) concerning the possibility that scour holes had been formed on the floodplain of the Tennessee River under the north end of the I-65 bridge south of Huntsville, Alabama. Mr. David Mezick of that office replied that no difficulties had been experienced with scour at that site, to his knowledge. Controversy had occurred when that bridge was built because the floodplain at the bridge crossing is a wetlands area and wildlife habitat. Environmentalists had been concerned about the height of the superstructure because of possible interference with the flight of Canadian geese and other migratory fowl that transverse the area during annual migrations. Further inquiries would be made to verify that no scour had occurred on the Tennessee River floodplain there.

In answer to questions about scour countermeasures, the following comments were made: dumped riprap is used almost exclusively because of the availability of suitable rock and the ease of construction; many citizens and even engineers do not believe that scour is a problem at bridges in Alabama; and filters are specified under riprap treatments at bridges but it is not always feasible to build a mineral filter or place a geosynthetic filter in flowing streams even though it is possible to dump riprap.

## **7.19 NEW YORK**

Site examinations were conducted on October 24 and 25, 1996 by Steve Georgopoulos, P.E. (State Hydraulic Engineer), Mike Farrell, P.E. (Region 9 Hydraulic Engineer), Rick Voigt (University of Minnesota) and Art Parola (University of Louisville).

### **7.19.1 NY 17 Susquehanna River Bridge (Bin 1054831/2)**

New York bridge NY17 over the Susquehanna River (Bin 1054831/2) was examined on October 24th. The bridge is located downstream from a low-radius (relative to channel width) 70 to 80 degree (arc angle) bend and upstream from a large-radius (relative to channel width) 60 to 70 degree bend. Although the bend indicated by the main channel banks is approximately 200 m upstream from the bridge, the velocity distribution at the time of examination indicated that the thread of high velocity flow was between the south bank and the second pier. Flow velocities at the time of inspection were noticeably higher between the edge of the bank and pier 1 and pier 2. Steep, vertical upper main channel banks indicated recent bank erosion on the southwest bank. Bed forms (gravel bars) and the meandering of the thalweg within the main channel banks probably have an important impact on the cross-stream velocity distribution and its variability at this site. A levee to prevent urban flooding on the south floodplain and the Route 17 highway embankment confine floodplain flow upstream from the bridge.

The discoloration of water and an apparent increased water surface elevation due to locally heavy recent rains prevented detailed inspection of the countermeasure. The countermeasure at this site was an Articulated Block Mattress (ABM). Grout-filled bags were used to construct a wall around and beneath the pile cap for pier 2. Gravel was pumped into the void under the pile cap to reestablish lateral support to the pile foundation. Gravel was used because of the possible damage to fish associated with the placement of concrete into the river

### **7.19.2 NY 26 Susquehanna River Bridge (Bin 10118431/2)**

On October 24th the NY 26 bridge over the Susquehanna River (Bin 10118431/2) was evaluated. An articulated block mattress at this site was extended around the pier and over the adjacent north streambank. The streambank appeared to have been shaped to provide a gradually changing slope to which the mattress conformed. To fill the void under the pile cap, gravel was pumped into the cavity under the pile cap within a wall formed from grout-filled bags. This method of restoring lateral support and placing the articulated block was similar to that used at the Route 17 bridge. Although this bridge is located on a relatively

straight section of main channel, the effect of the non-uniformity of flow caused by an upstream bend appeared to extend downstream through the bridge. The tangent point indicated by the main channel banks is located approximately 500 m upstream of the bridge. The size of bedforms and the precise location of the thalweg were not determined. The articulated block was visible along the north bank. Deposits of silt were found on the submerged portion of the mattress near the bank. Evidence of edge undermining was not present along the bank.

The countermeasure was installed in 1989. Inspection after the January 1995 flooding indicated that no maintenance was required at that time.

#### **7.19.3 Route 23 Otselic River Bridge (Bin 3312170)**

At the time of examination of route 23 over the Otselic River (Bin 3312170) on October 24th, divers were placing a temporary coffer dam to allow access beneath the pier pile cap and to allow the controlled placement of riprap. The bridge was located on a relatively small-radius, approximately 90 degree (arc angle) bend. The skew of the approach channel to the bridge embankments caused impinging flow on the east (left descending) abutment and the formation of a large secondary cell (upstream flow on the outside of the bend) and erosion of the east (left descending) bank upstream of the bridge. A point bar was present upstream from and through the bridge along the west (right) bank. A short straight guidebank (approximately 5 m length) projected upstream from and normal to the east abutment fill. The scour hole formed at the pier was attributed to a combination of flow skew and flow curvature. The length of the pier wall, approximately 10 m, was large compared to the small radius of the bend (approximately 80 m). The long pier was necessary to provide lateral stability against ice forces at this site. The stream channel pavement was composed primarily of gravel although the subsurface contained a substantial component of silty sand. Banks were composed of gravel, sands and silts, with sandy gravel layers at the elevation of the streambed and sandy silt near the floodplain surface elevation. Piles supported the pier and abutment. Large woody debris accumulations frequently had formed on the pier at this site and may have contributed to scour there. Past inspections indicated that the scour at this site is dynamic, with the depth and location of scouring shifting with time. Upstream bank erosion was indicative of the stream tendency to shift.

The countermeasure under construction at this site was a combination of underpinning beneath the pile cap (filling voids with approximately 60 cubic yards of concrete) to restore lateral pile support, and riprap armoring to protect the streambed surrounding the pier.

#### **7.19.4 Route 25 Otselic River Bridge (Bin 1018700)**

Route 25 over the Otselic river (Bin 1018700) was inspected on October 24th. The pier of the two-span arch bridge and the approach embankments were protected by riprap. The scour that occurred at the pier was attributed to a combination of contraction effects and high angle of flow attack associated with channel shift. Countermeasures were constructed similar to those used at the Route 23 bridge downstream. The tendency for channel shift was evident from the bank erosion upstream from the bridge. The streambed was composed of material similar to that at the Route 23 bridge.

#### **7.19.5 Susquehanna River Main Street Bridge in Oneonta (Bin 1095269)**

The Main street bridge over the Susquehanna river in Oneonta was reviewed on October 24th. The river floodplain is confined at this site by the Interstate 88 embankment and the south valley wall. The main channel appears channelized. Bedforms, including large diagonal bars present in the main channel, are indications of a high degree of variability in the flow velocity distributions and directions in addition to cross-stream variations in bedload sediments (pavement composed of large gravel). A large double barrel culvert discharges the flow of Oneonta Creek approximately 50 m upstream from the bridge on the north bank. Flow and sediments from the Creek appear to contribute to the formation of bedforms. A large deposit downstream from the affected pier indicates the magnitude of the bedload transport as well as the potential effect of the bedforms in causing a wide variety of flow skew angles at the pier. Downstream

fining in the deposit downstream from the pier is indicative of the wide variability of the bed materials transported. Vegetation on the downstream side of the bar is indicative of materials smaller than gravel.

The pier pile cap at this site was undermined. Grout bags were used to underpin the pile cap and to protect the surrounding streambed. The scour holes at this site appear to have refilled. The shifting tendency of bedforms within the channelized section of the stream contribute to the magnitude and the variation of skew angle to the pier at this site. The size and location of the downstream deposit indicates the magnitude of the skew angle of flow to the pier. Erosion of the downstream deposit indicates the change in flow distribution under low flow conditions. A diagonal bar extending through the upstream nose of the pier has temporarily refilled scour features.

#### **7.19.6 Route 23 Bridge in Oneonta (Bin 1095269)**

The route 23 bridge (Bin 1095269) is approximately 1000 m upstream from the Main Street Bridge. The river floodplain is confined at this site by the Interstate 88 embankment and the south valley wall. The river appears channelized. Bedforms, including large bars present in the main channel, affect flow velocity distributions and directions and cross-stream variations in bedload sediments (large gravel pavement). Erosion of the north (right descending) channel bank upstream from the bridge, and scour within the channel, contributed to the formation of a large diagonal gravel bar across the channel. This bedform was affecting the low-flow velocity distribution across the channel. The existing low-flow velocity distribution appeared to be causing deposition rather than scour at the protected pier. A second inlet for Oneonta Creek enters the river approximately 500 m upstream from the bridge on the north (right) bank. The significance of the stream entrance is not apparent. A large deposit downstream of the affected pier indicates the size distribution of the gravel and sands transported (small cobbles, gravel, and sand). The deposit also indicates the existence of a high skew angle under higher flow conditions. Current non-symmetric erosion of the deposit indicates a substantial change in flow patterns from higher flow conditions to those at the time of examination.

The pier pile cap at this site was undermined. Grout bags were used to underpin the pile cap and to protect the surrounding streambed. The scour holes at this site appears to have refilled.

Stapods, riprap, and PVC-coated gabions had been used as countermeasures to prevent erosion of the Route 30 highway embankment (RM 95021114). The embankment was located between Schoharie Creek and a vertical rock valley wall. Recent rains caused high flow at the site preventing examination of the stapods. The Schoharie Creek impinges on the highway embankment causing erosion at the toe of the embankment. A deposit of large angular rock, considered to be riprap eroded from the embankment protection, formed the surface of a diagonal bar downstream from the site. The large angular material on the surface of the bar appeared, at least in part, to be material eroded from the streambed and embankment near the upstream point of flow impingement. Photographs from previous state site inspections showed the stapods placed in a line at the base of the slope protection. The interlocking stapod legs and the broad base formed by the legs prevent sliding and provide a stable platform over the lower bank on which the slope rock protection can be supported. The stapods were installed in 1985 and have provided protection of the embankment during the April 1987 flood and the December 1995 flood. Both floods were approximately 100-year events. Rock riprap around the stapods was displaced during both floods; however, the embankment was not damaged.

PVC coated gabions were placed on the upper portion of the embankment protection. The PVC coating was damaged where the wire was twisted and at other locations where the wire was bent sharply. Although the PVC coating was removed over small sections of wire, corrosion of the wire was not evident.

#### **7.19.7 NY 443 Embankment along Fox Creek (Near Zimmer Road)**

Fox Creek (a cobble bed stream) impinges on the highway embankment of New York 443 near Zimmer road and flows parallel to the embankment for approximately 200 m. A section of vertical concrete retaining wall supports the embankment at the impingement point. Approximately 20 meters downstream from the impingement point, a section of gabions retains and protects the embankment.



Undermining of a portion of the gabion wall caused sagging. Lack of access to the gabions precluded detailed examination; however, review of inspection photographs revealed no obvious breaks in the gabion wire.

#### **7.19.8 Route 30 Bridge at Sacandaga Reservoir (Bin 1031170)**

The Sacandaga River enters the backwater of the Sacandaga Reservoir at approximately the location of the Route 30 bridge (Bin 1021170). The transition of the steeply sloping Sacandaga River into the backwater of the reservoir creates conditions favorable for frazzle ice accumulation. Ice buildup has been reported by regional engineers to block nearly the entire opening and cause flow over the bridge and roadway. Flow around the ice scoured the streambed and endangered the structure. Grout filled bags were placed around the piles to restore lateral stability of the piles and riprap has been placed around the bags and streambed to prevent further streambed degradation. Scour caused by contraction of flow area around the ice has created scour holes that undermined the pile caps of the pier foundations and exposed several meters of piling.

#### **7.19.9 Stony Clove Creek Silver Hollow Road Bridge**

Stapods were used to support the toes of the abutment embankments for the Silver Hollow Road bridge over Stony Clove Creek and the toe of the New York State 214 embankment. The stapods provided a stable toe for steep riprap-protected slopes. Stony Clove Creek is a steep-gradient boulder/cobble stream set in a narrow floodplain. Streambanks are composed primarily of boulders and cobbles. Bank erosion upstream and downstream from the bridge indicated the potential for stream shift at this location. Bank protection measures were under construction upstream from the bridge. This protection did not appear to include the bridge abutment.

Part of the stapod protection appeared to have moved as a result of undermining by scour in the streambed. The movement did not appear to have reduced the inherent effectiveness of the stapods in supporting the embankment or the effectiveness of the supported riprap to provide protection of the slope. Bank erosion occurred upstream from the south abutment embankment stapods. The curvature of the stapod alignment at the edge of the treatment appeared to protect them from minor bank erosion at the upstream edge.

## 8. INTERPRETATION, APPRAISAL, APPLICATIONS

### 8.1 CHAPTER SUMMARY

This chapter consists of two parts. The first part is devoted to an analysis of durability and specifications for the wire mesh used for gabions and Reno mattresses. The second part consists of the main body of design recommendations and user guidelines for the implementation of the most promising of the countermeasures identified in the course of the study. The second part also forms the body of Volume I of this report, which is the user's guide.

### 8.2 GABIONS AND RENO MATTRESSES

The research team was directed by the panel to perform an evaluation of gabion and Reno mattress specifications and wire mesh durability in lieu of experiments. The results of this investigation are reported below.

#### 8.2.1 Durability: Gabions and Reno Mattresses

Gabions and Reno mattresses are the two most common types of rock filled wire basket countermeasures; however this design guide is intended to address all similar types of scour countermeasure systems. Throughout this design guide the term gabion is used with the intent to imply all similar systems unless specifically noted otherwise.

During review of a number of both successful and unsuccessful installations of gabion-type systems, several parameters critical to successful performance were noted.

Critical to the long-term reliability of gabions is the use of design procedures and materials conducive to successful performance. While such a statement may seem overly obvious, nearly all of the observed installations experiencing some level of failure were subject to one or more of the following design oversights.

- a) Failure to interface between the gabion and the river bed with an appropriate filter.
- b) Gabions being undercut by flows along the edge of the basket caused by too stiff a basket.
- c) Basket rupture allowing rocks to be removed, caused by too light basket wiring. This was most typically caused by failure of the wiring used to stitch or lace the edges of the basket together.
- d) Failure to periodically monitor the countermeasure.

Most often, any of the above design oversights were typically found in small installations which had been quickly installed by highway maintenance crews or private contractors with little if any engineering guidance. The individuals faced with these tasks were normally on very limited budgets and a tight timeline. Their procedure consisted of buying some fencing and wire at a local farm or landscape supplier, finding some rock, stitching a basket together on site and filling it with rock. Attention was focused on getting the job done (which is directly in-line with the responsibility of such individuals) with little understanding of how an appropriately designed gabion functioned. Lack of a filter or a poorly attached geotextile filter typically led to the winnowing of bed material through the rocks in the basket. In some installations, farm fencing available in sheets was used but proved too stiff to deform as needed. In addition, the type of fencing normally available for low cost is typically not of the highest quality galvanizing. Debris snagging on the basket also led to holes being torn in the basket. However, the most typical cause of basket rupture was related to failure of the wire lacing holding the basket edges or sides together. The wire lacing was typically the weakest link with little attention being paid to either the level of strength required or to long-term durability.

Installations using good basket design procedures performed well. As can be seen in Figure 7.1 of the field survey portion of the report, even though the gabion revetment system shown in the photo sagged noticeably due to undercutting caused by a very sharp angle of attack at the bank the gabions were protecting, the baskets successfully deformed without catastrophically rupturing. This allowed continued protection, providing time to evaluate whether mitigation measures were necessary. If complete failure had occurred, the roadway embankment could have been eroded rapidly.

Upon review of the available specifications for gabions, the Maccaferri Company was found to have developed a quality set of specifications, which we recommend for general use. We cannot promote the purchase of any specific manufacturer's products, but strongly recommend the use of the following standard for all gabion-type installations, which was developed by Maccaferri. Only single stand galvanized or PVC coated wire is recommended for use in any gabion components.

### **8.2.2 Specifications: Gabions and Reno Mattress, Zinc Coated**

The following specifications were issued by Maccaferri Gabions, Inc., January 1993 and apply to standard gabion and Reno mattresses made of zinc coated double twist, 8x10 type mesh for gabions and 6x8 type mesh for Reno mattresses, fitted with diaphragms.

Gabions and Reno mattresses with the additional PVC coated sleeve can be used in a polluted environment, where soils or water are acidic, in salt or fresh water or wherever the risk of corrosion is present. Installation should be in accordance with the manufacturer's instructions. Only hard, durable stone should be used as fill.

The standard type gabion should be a flexible zinc coated gabion of the type and sizes specified below. It is made of wire mesh of the type and size and selvages as specified in the following paragraphs. Each gabion may be divided by diaphragms into cells whose length should not be greater than one and a half times the width of the gabion.

Standard gabions should be fabricated so as to be of a single unit construction base, lids and sides should be woven into a single unit, and the ends connected to the base section in such a manner that strength and flexibility of the point of connection is at least equal to that of the mesh.

The base, sides and two ends of the Reno mattress are made of a single sheet of wire mesh (main sheet). Partition panels, made of the same type of wire mesh, are attached to the base of the main sheet to form pockets of length approximately 3 feet into which the mattress is divided. The lid is formed by a single sheet.

#### ***Mesh***

The mesh should be hexagonal woven mesh with the joints formed by twisting each pair of wires through three half turns. Because of their appearance, the joints are often termed triple twisted. For gabions, the size of the mesh conforms to the specifications issued by the plant and should be of 8 x 10 type mesh; nominal mesh size is 3-1/4 x 4-1/2 inches. Reno mattresses should be of 6 x 8 type mesh; nominal size is 2-1/2 x 3-1/4 inches. Note the term "mesh type" describes the approximate mesh size in centimeters.

#### ***Wire***

All wire used in the fabrication of the gabions and in the wiring operations during construction for the zinc coating and tensile strength should be in accordance with the requirements of ASTM A 641-89, Standard Specification for Zinc-Coated (Galvanized) Carbon Steel Wire, for galvanized wire, class 3, soft temper, as measured before fabrication of the netting. The nominal diameter of the wire used in the fabrication of the Gabion netting should be 0.120 inches. The nominal diameter of the wire used in the fabrication of mattress netting should be 0.0866 inches.

### *Elongation of wire*

Tests should be made on the wire before fabrication of the gabions on a sample twelve inches long. Elongation should not be less than 12%, in accordance with the requirements of ASTM A 370-92, *Standard Test Methods and Definitions for Mechanical Testing of Steel Products*.

### *Zinc coating (galvanizing)*

All wire used in the fabrication of the gabions and in the wiring operations during construction should be coated to ASTM A 641-89 for zinc coated (galvanized) carbon steel wire. The minimum weight of the zinc coating should be according to the figures shown in Table 8.1 when tested in accordance with ASTM A 90-81.

**Table 8.1** Wire specifications.

Wire Type	Nominal Diameter of Wire (inches)	Minimum weight of coating (ozs./sq.ft.)
Lacing wire, Mattress mesh (6x8)	0.0866	0.70
Mattress (6x8) selvedge	0.1063	0.80
Gabion mesh (8x10)	0.120	0.85
Gabion selvedge (8x10 mesh)	0.1535	0.90

The adhesion of the zinc coating to the wire should be such that, when wrapped around a mandrel in accordance with ASTM A 641-89, the zinc coating will not crack or flake to such an extent that any zinc can be removed by rubbing with the bare fingers.

### *Selvedges*

All edges of standard gabions and Reno mattresses, including end-panels and the diaphragms, if any, should be mechanically selvedged in such a way as to prevent unraveling of the mesh and to develop the full strength of the mesh. The wire used for the selvedge should have a diameter greater than that of the wire used to form the mesh, namely:

- For the 8 x 10 type mesh made of wire having a nominal diameter of 0.120 inches the selvedge should be of wire having a nominal diameter of 0.1535 inches or greater.
- For the 6 x 8 type mesh made of wire having a nominal diameter of 0.0866 inches, the selvedge should be of wire with a nominal diameter of 0.1063 inches or greater.

### *Dimensions of zinc-coated gabions*

Standard zinc-coated gabions should have the following dimensions:

- Nominal length = 6 feet, 9 feet or 12 feet
- Nominal width = 3 feet
- Nominal height = 1 foot, 1 foot 6 inches or 3 feet

Standard zinc-coated Reno mattresses should have the following dimensions:

- Nominal width = 6 feet
- Nominal length = 9 feet or 12 feet
- Nominal thickness = 6 inches, 9 inches

### *Lacing wire*

Sufficient lacing and connecting wire should be supplied with the gabions or mattresses for all wiring operations carried out in the construction of the gabion work. The lacing wire procedure consists of cutting a length of lacing wire approximately 1-1/2 times the distance to be laced (not to exceed 5 feet), securing one wire at the corner by looping and twisting, alternately lacing with single and double loops

every other mesh opening at intervals of not more than six (6) inches (150 mm), and securing the other end of the wire to selvages by looping and twisting.

The nominal diameter of lacing wire should be 0.0866 inches.

#### ***Fasteners***

Rings can be used in lieu of lacing wire for assembly and installation operations of gabions. Rings should be supplied with the same zinc coating as the mesh and the wire diameter of the rings should be the same as the mesh. The wire used for the rings supplied by Maccaferri Gabions, (Reference No. 11G40) should be coated in accordance with ASTM A 641-89; coating weight per ASTM A 90-81, also ASTM A 764, Class II, Type III; and tensile strength to be determined as per ASTM E 8/MTP 2004. Spacing of the fasteners must not exceed six (6) inches.

#### ***Diaphragms***

According to engineering requirements the gabions incorporate diaphragms to form cells having a length not greater than one and a half the width of the gabion. Reno mattresses incorporate diaphragms to cells having a nominal length of 3 ft.

#### ***Tolerances***

- **Wire** - Tolerances on the diameter of all wire in the above clauses should be permitted in accordance with ASTM A 641-89 Table 3.
- **Gabions** - Tolerances of  $\pm 5\%$  on the width, height and length of the gabions should be permitted.
- **Reno Mattresses** - A tolerance of  $\pm 5\%$  on the width and the length of the Reno mattress and a tolerance of  $\pm 10\%$  on the height should be permitted.

#### **8.2.3 Specifications: Gabions, Galvanized and PVC Coated**

The following specifications apply to standard gabions (8x10 type mesh) and standard Reno mattresses (6 x 8 type mesh) made of galvanized and PVC coated double twisted, fitted with diaphragms.

The PVC (polyvinyl chloride) coated gabion should be a flexible zinc coated gabion of the type and sizes specified below. It is made of wire mesh of the type and size and selvages as specified in the following paragraphs. Each gabion may be divided by diaphragms into cells whose length should not be greater than one and a half times the width of the gabion.

Standard gabions should be fabricated so as to be of a single unit construction base, lids and sides should be woven into a single unit and the ends connected to the base section in such a manner that strength and flexibility of the point of connection is at least equal to that of the mesh.

The PVC coated Reno mattress should be a flexible zinc coated (galvanized) mattress of the type and sizes stated below. It is made of wire mesh of the type, size and selvages as specified in the following paragraphs. The base, sides and two ends of the Reno mattress are made of a single sheet of wire mesh (main sheet). Partition panels made of the same type of wire mesh are attached to the base of the main sheet to form pockets of length approximately 3 feet into which the mattress is divided. The lid is formed by a single sheet.

#### ***Mesh***

The mesh should be hexagonal woven mesh with the joints formed by twisting each pair of wires through three half turns. Because of their appearance, the joints are often termed triple twisted. The size of the mesh conforms to the specifications issued by the plant and for gabions should be of 8 x 10 type mesh; nominal mesh size is 3-1/4 by 4-1/2 inches. For Reno mattresses, the size of the mesh should be of 6 x 8 type mesh; nominal mesh size is 2-1/2 x 3-1/4 inches.

### **Wire**

All wire used in the fabrication of the gabions and in the wiring operations during construction for the zinc coating and tensile strength, should be in accordance with the requirements of ASTM A 641-89, Standard Specification for zinc-coated (galvanized) carbon steel wire, for galvanized wire, class 3, soft temper, as measured before extrusion of the PVC coating and fabrication of the netting. The nominal diameter of the wire used in the fabrication of the gabion netting should be 0.1063 inches. The nominal diameter of the wire used in the fabrication of the Reno mattress netting should be 0.0866 inches.

The nominal diameter of the steel wire core, used in the fabrication of the netting, should be 0.1063 inches with a PVC coating, for gabions (0.0866 for Reno mattresses) extruded onto the wire core, having a nominal thickness of 0.02165 inches, with an minimum thickness of 0.015 inches. An overall nominal diameter of 0.1496 inches is obtained for gabions; 0.1299 inches for Reno mattresses.

### **Elongation of wire**

Tests should be made on the wire before coating with PVC and fabrication of the gabions on a sample ten inches long. Elongation should not be less than 12%, in accordance with the requirements of ASTM A 370-92.

### **Zinc coating (galvanizing)**

All wire used in the fabrication on the gabions and in the wiring operations during construction should be coated to ASTM A 641-89 for zinc coated (galvanized) carbon steel wire. The minimum weight of the zinc coating should be according to the figures shown in Table 8.2 when tested in accordance with ASTM A 90-81.

**Table 8.2** Further specifications for gabions and Reno mattresses.

<b>Gabion or Mattress Type</b>	<b>Nominal Diameter of Wire (inches)</b>	<b>Minimum weight of coating (ozs./sq.ft.)</b>
Gabion lacing wire	0.0866	0.70
Gabion mesh	0.1063	0.80
Gabion selvedge	0.1338	0.85
Reno mattress mesh/lacing	0.0866	0.70
Mattress selvedge	0.1063	0.80

The adhesion of the zinc coating to the wire should be such that, when wrapped around a mandrel in accordance with ASTM A 641-89, the zinc coating will not crack or flake to such an extent that any zinc can be removed by rubbing with the bare fingers.

### **Selvedges**

The edges of the PVC-coated gabions and Reno mattresses, including end-panels and the diaphragms, if any, should be mechanically selvedged in such a way as to prevent unraveling of the mesh and to develop the full strength of the mesh. The wire used for the selvedge should have a diameter greater than that of the wire used to form the mesh, namely:

- For the 8 x 10 type mesh, made of wire having a nominal core diameter of 0.1063 inches, the selvedge should be of wire having a nominal diameter of 0.1338 inches or greater.
- For the 6 x 8 type mesh, made of wire having a nominal core diameter of 0.0866 inches, the selvedge should be of wire having a nominal diameter of 0.1063 inches or greater.

### **Dimensions of PVC coated gabions and Reno mattresses**

Standard PVC coated gabions should have the following dimensions:

- Nominal length = 6 feet, 9 feet or 12 feet
- Nominal width = 3 feet
- Nominal height = 1 foot, 1 foot 6 inches or 3 feet

Standard PVC coated Reno mattresses have the following dimensions:

- Nominal width = 6 feet
- Nominal length = 9 feet or 12 feet
- Nominal thickness = 6 inches, 9 inches

#### ***Lacing wire***

Sufficient lacing and connecting PVC coated wire should be supplied with the gabions or Reno mattress for all wiring operations carried out in the construction of the gabion work. The lacing wire procedure consists of cutting a length of lacing wire approximately 1-1/2 times the distance to be laced (not to exceed 5 feet), securing one end of the wire at the corner by looping and twisting, alternately lacing with single and double loops every other mesh opening at intervals of not more than six (6) inches (150 mm) and securing the other end of the wire to selvages by looping and twisting.

The nominal diameter of lacing wire should be 0.0866 inches and should comply to the same specification as the wire used in the mesh.

#### ***Fasteners***

Rings can be used in lieu of lacing wire for assembly and installation operations of the gabions. Rings supplied should be stainless steel. The wire diameter of the rings should be the same as the mesh. The wire used for the rings supplied by Maccaferri Gabions, (Reference No. 11SS40) should be in accordance with ASTM A 313 type 302, class I. Load tests should conform to ASTM A 370-92. Tensile strength to be determined as per ASTM E 8/MTP 2004. Spacing of the fasteners must not exceed six (6) inches.

#### ***PVC coating***

All wire used in the fabrication of the gabions and in the wiring operations during construction should, after zinc coating, have extruded onto it a coating of polyvinyl chloride, otherwise referred to as "PVC". The coating should be gray in color and of nominal thickness 0.02165 inches and nowhere be less than 0.015 inches in thickness. It should be capable of resisting deleterious effects of natural weather exposure, immersion in salt water and not show any material difference in its initial characteristics which are:

#### ***Initial properties of PVC used in coating***

##### ***1. Specific gravity***

Should be 1.30 to 1.35 kg/Dm<sup>3</sup>, in accordance with ASTM D 2287-92, Table 1 therein when tested as specified in ASTM D 792-91.

##### ***2. Durometer hardness***

Should be 50 to 60 Shore D, in accordance with ASTM D 2287-92, Table 1 therein when tested as specified in ASTM D 2240-91 (ISO 868 1985).

##### ***3. Volatile loss***

At 105 degree C for 24 hours = should not be higher than 2%

At 105 degree C for 240 hours = should not be higher than 6% in accordance with ASTM D 2287-92 when tested as specified in ASTM D 1203-89 (ISO 176-1976).

4. *Tensile strength*

Should not be less than 210 Kg/cm<sup>2</sup> in accordance with ASTM D 412-92.

5. *Elongation*

Should not be less than 200% nor higher than 280% in accordance with ASTM D 2287-92, when tested as specified in ASTM D 412-92.

6. *Modulus of elasticity at 100% of elongation*

Should not be less than 190 Kg/cm<sup>2</sup> when tested as specified in ASTM D 412-92.

7. *Resistance to abrasion*

The loss of weight should not be more than 0.19 g in accordance with ASTM D 1242-92.

8. *Brittleness temperature*

Cold bend temperature = should not be higher than -30 degrees C in accordance with BSS 2782-151A (84).

Cold flex temperature = should not be higher than +15 degree C in accordance with BSS 2782-153A.

9. *Creeping corrosion*

Maximum penetration of corrosion of the wire core from a square cut end should be 25 mm when the specimen has been immersed for 2000 hours in a 50% SOLUTION HC1 (hydrochloric acid 12 Be).

***Variation of the initial properties***

Variation of the initial properties will be allowed, as specified thereunder, when the specimen is submitted to the following accelerated aging tests:

1. *Salt spray test*

According to ASTM B 117-90.

Period of test - 3000 hours.

2. *Exposure to ultraviolet rays*

According to ASTM D 1499-92a and ASTM G 23-93 using apparatus type E or as otherwise approved.

Period of test: 3000 hrs. at 63 degrees C or as otherwise agreed.

3. *Exposure at high temperature*

According to ASTM D 1203-89, (ISO 176-1976), and ASTM D 2287-92.

Period of test = 240 hours at 105 degree C

After the above tests have been performed the PVC compound should show the following properties:

***Properties after aging tests***

1. *Appearance of coated mesh*

The vinyl coating should not crack, blister or split and should not show any remarkable change in color.



2. *Specific gravity*

Should not show change higher than 6% of its initial value.

3. *Durometer hardness*

Should not show change higher than 10% of its initial value.

4. *Tensile strength*

Should not show change than 25% of its initial value.

5. *Elongation*

Should not show change higher than 25% of its initial value.

6. *Modulus of elasticity*

Should not show change higher than 25% of its initial value.

7. *Resistance to abrasion*

Should not show change of more than 10% of its initial value.

8. *Brittleness temperature*

Cold bend temperature = should not be higher than -20 degree C.

Cold flex temperature = should not be higher than + 18 degree C.

9. *Diaphragms*

According to engineering requirements the gabions incorporate diaphragms to form cells having a length not greater than one and a half the width of the gabion. According to engineering requirements the Reno mattresses incorporate diaphragms to form cells having a nominal length of three feet.

10. *Tolerances*

- Wire - Tolerances on the diameter of all wire in the above clauses should be permitted in accordance with ASTM A641-89 Table 3 therein.
- Gabions - Tolerances of  $\pm 5\%$  on the width, height and length of the gabions should be permitted. A tolerance of  $\pm 5\%$  on the width and on the length of the Reno mattress and a tolerance of  $\pm 10\%$  on the height should be permitted.
- Reno mattress - A tolerance of  $\pm 5\%$  on the width and on the length of the Reno mattress and a tolerance of  $\pm 10\%$  on the height should be permitted.

### 8.3. DESIGN RECOMMENDATIONS FOR SELECTED COUNTERMEASURES

The material presented below represents the essential conclusions of the NCHRP 24-7 research effort in regard to application of the research results pertaining to countermeasures to protect bridge piers from scour. Only a select few of the countermeasures investigated in this study were selected for this user's manual. They are enumerated below:

- Riprap with prior excavation and with geotextile or granular filter;
- Riprap without prior excavation and with geotextile or granular filter;
- Riprap without prior excavation, without geotextile or granular filter;
- Cable tied blocks;
- Grout filled bags; and
- Gabions.

For design criteria for toskanes and related devices such as tetrapods, the reader is referred to Fotherby and Ruff (1995). The following countermeasures were either not deemed of sufficient value or not yet sufficiently documented for the specification of implementation recommendations.

- Pier attached vanes;
- Sacrificial piles;
- Pier suction;
- Permeable sheet piles;
- Slot in pier;
- Collars and horizontal plates;
- Pavement;
- Riprap augmented by submerged permeable sheet piles;
- High density riprap; and
- Iowa Vanes.

In fact, all but the last three of the above countermeasures were deemed to have limited potential by the 24-7 team.

The following caveats apply in general to all the implementation recommendations given below. They are directed toward the protection of *existing bridge piers* against local scour in streams that are otherwise *stable*. This is in accordance with the language of the initial Project Statement for NCHRP Project 24-7, "Countermeasures to Protect Bridge Piers from Scour." Local protection of piers against scour may be ineffective in cases involving severe channel degradation, channel migration, debris problems, ice jams etc. The type of river considered here is an alluvial sand bed or gravel bed river. These notes are not applicable to piers with footings on bedrock, nor are they applicable to piers on floodplains.

The material is presented as follows. Implementation notes are provided in regard to geotextile filters and granular filter layers. Guidelines are then provided for each of the countermeasures selected above. Design recommendations are presented for each countermeasure. These are followed by a list of notes in bullet form on implementation of the countermeasure, and in particular pertaining to feasibility, effectiveness, constructability, durability, maintainability, and cost. Each of these terms is defined below for the purpose of this report.

Feasibility. For a given situation is the method or technique applicable?

Effectiveness. When is the method technically effective? Under how wide a range is the method effective?

Constructability. - Does the method require specialized labor, supplies or placement equipment or can it be done using standard equipment and readily available materials? This obviously must allow for some regional variation and environmental constraints.

Durability. Is the method capable of working for a period of several flood seasons without requiring replacement or repair?

Maintainability. Is the method easily maintained or does it require specialized equipment and supplies?

Cost. Original construction cost on a unit cost basis and for a hypothetical installation.

For the purpose of this user's manual, a gravel bed stream is one with a surface median bed material size  $d_{50}$  in excess of 2 mm, and a sand bed stream is one for which  $0.06 \text{ mm} < d_{50} < 2 \text{ mm}$ . Streams with values of  $d_{50}$  between 2 and 8 mm are, however, relatively uncommon.

### **8.3.1 Implementation Notes For Geotextile Filters and Granular Filter Layers**

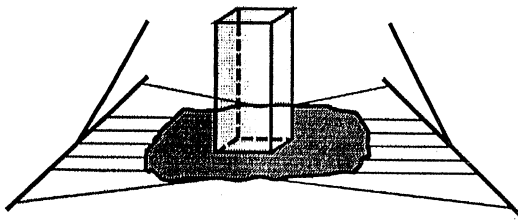
The research conducted in the course of this project indicates that under flood conditions in sand bed streams with developed bedforms the leaching of sand from the interstices of any armoring countermeasure may ultimately result in failure of the countermeasure. With this in mind, and in light of the positive results of experimental testing, it is recommended here that such an armoring countermeasure in a sand bed stream be underlain by an appropriately selected geotextile filter. The following further recommendations are made.

- It is recommended that the areal cover of the geotextile filter be less than that of the armoring countermeasure in order to allow for anchoring of the edges of the geotextile filter. More specific recommendations are made below for several selected armoring countermeasures.
- It is recommended that the porosity of the geotextile filter be sufficient to allow release of pore pressures without causing uplift of the fabric under flood conditions. The selection of a relatively open fabric, i.e. one which retains all sizes finer than one modestly finer than the median size  $d_{50}$  of the bed material may be advantageous. Such a selection may encourage the formation of a natural granular filter layer below the geotextile filter. Failure to properly release the buildup of pore pressure may lead to uplift and catastrophic failure of the geotextile filter and armoring countermeasure above.
- It is recommended that the geotextile filter be resistant to tearing or puncturing during countermeasure placement or settling. Testing indicates that even gaps as small as 0.25 in can allow the leaching of a significant quantity of bed material.
- It is recommended that the geotextile filter have a lifetime of at least 20 years without decay when placed on the bed of a natural river in the vicinity of a bridge pier.
- It is recommended that the geotextile filter be fabricated from ultraviolet light resistant materials.
- In a reach subject to periodic scour and fill, it is recommended that both the geotextile filter and countermeasure above be placed at a level characteristic of ambient bed level near the pier at time of maximum scour. If this is not done the scour may leave the geotextile filter and armoring countermeasure perched during floods, possibly leading to the loss of both.

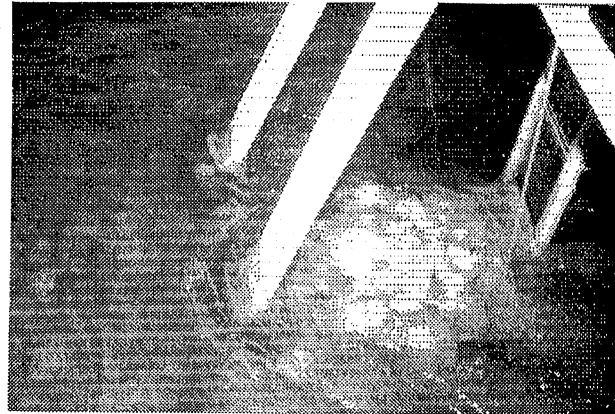
Geotextile filters are not recommended for gravel bed streams both due to the abrasive nature of gravel and its low potential for leaching.

The technology for the use of geotextile filters in tandem with armoring countermeasures at bridges remains insufficiently developed. The following ideas pertaining to field installation of geotextile filters are offered with the recommendation that they be pursued by bridge engineers working together with geotextile filter manufacturers.

The geotextile filter is provided with two sleeves, one around the outer circumference and one around the inner circumference to be placed in contact with the bridge pier. The outer sleeve contains a cable attached to several hooks projecting from the outer edge. In addition, it is filled with a quantity of ballast (in the form of fine riprap, for example). The ballast helps weigh the outer edge of the geotextile filter down as it is spread underwater at low flow. The hooks are attached to external cables manipulated from a crane on the bridge deck. The external cables and crane are used to spread the geotextile filter underwater. It is weighed down from behind by properly sized riprap, taking care not to rip the geotextile. The hooks are released upon successful installation. The procedure is illustrated in Figures 8.1 and 8.2.

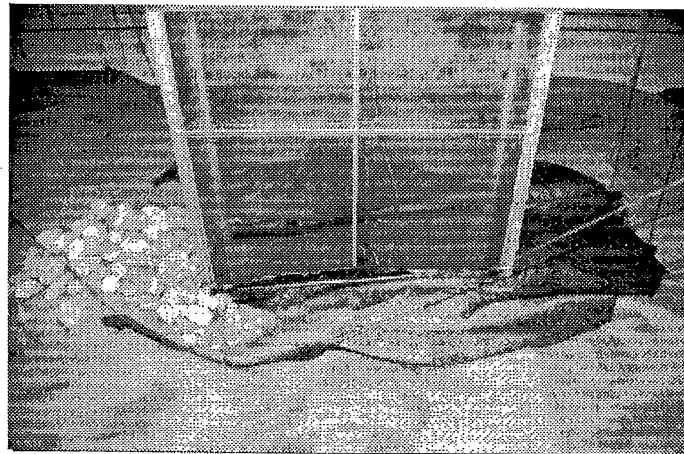


(a)



(b)

**Figure 8.1.** a) Schematization of the geotextile installation under water. b) View of actual installation of the geotextile underwater.



**Figure 8.2.** Illustration of the low-water installation technique for geotextile and riprap. The flow has been temporarily halted to improve visibility.

The inner sleeve is fitted with a durable but flexible tubing, inside of which is placed a cable of durable material. The cable is then tightened around and clamped to the circumference of the pier, so sealing the geotextile filter to it. Experiments indicate that such sealing can considerably enhance the performance of an armoring countermeasure.

Granular filter layers were not tested experimentally in this study. Information collected in the course of the field site visits and in consultation with other engineers indicates that the underwater installation of granular filter layers can be difficult, and is often omitted even though recommended by e.g. Neill (1973). In addition, granular filter layers may be subject to reworking by river bedforms such as dunes, and thus may fail where a geotextile filter would not. This notwithstanding, the overall accumulation of experience with granular filter layers indicates that they are recommended for use in place of a geotextile filter in the event that a geotextile filter cannot be installed.

The guidelines due to Richardson et al. (1990) in the document "Highways in the River Environment" are recommended for the design of filter layers. These call for satisfying three criteria involving the sizes  $d_{15}$  (such that 15 % by weight is finer),  $d_{50}$  (such that 50 % is finer) and  $d_{85}$  (such that 85 % is finer) of the granular filter material and the base material, or ambient bed sediment below the filter layer.

$$\frac{d_{50}(\text{filter})}{d_{50}(\text{base})} < 40 \quad 5 < \frac{d_{15}(\text{filter})}{d_{15}(\text{base})} < 40 \quad \frac{d_{15}(\text{filter})}{d_{85}(\text{base})} < 5 \quad (8.1a,b,c)$$

In the case for which the riprap itself satisfies these criteria no granular filter layer is required. This may often be the case for gravel bed streams. In other cases multiple filter layers may be required to meet the criteria.

Neither a geotextile nor a filter layer is normally necessary or desirable in the case of a gravel bed stream.

### **8.3.2 Design Recommendations for Riprap with Prior Excavation and with Geotextile or Granular Filter**

#### ***Required information***

- Pier width  $D$
- Pier shape: round nosed or square nosed
- Approach flow velocity  $U$  at design flow conditions
- Angle of attack  $\beta$  of flow at bridge pier at design flow conditions
- Density  $\rho_r$  of the riprap to be used

The design flow conditions might correspond to anything from a 10 year flood to a standard project flood, depending upon the economic and social importance of the bridge. Standard software such as WSPRO, HEC-RAS, RMA-2 and FESWMS is available to help the user predict  $U$  and  $\beta$  at design conditions.

#### ***Riprap sizing***

It is recommended that the median size of the riprap be determined using the following relation due to Parola and Jones (1991), which also appears in the HEC-18 manual (Richardson et al., 1992).

$$D_{r50} = \frac{U^2}{\frac{2.89}{K^2} \left( \frac{\rho_r}{\rho} - 1 \right) g} \quad (8.2)$$

where  $g$  is the acceleration of gravity,  $\rho_r/\rho$  is the specific gravity of the riprap and  $K = 1.5$  for round nosed piers and 1.7 for square-nosed piers. If  $U$  is input in m/s,  $g = 9.81 \text{ m/s}^2$  and  $D_{r50}$  is specified in meters. If  $U$  is input in ft/s,  $g = 32.2 \text{ ft/s}^2$  and  $D_{r50}$  is specified in ft.

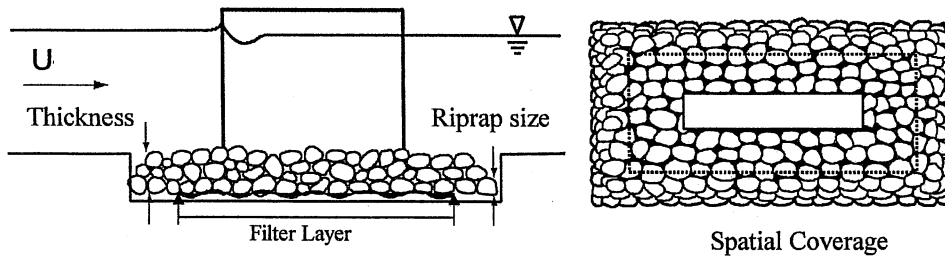
#### ***Riprap size distribution***

It is recommended that riprap be durable, angular rock with a wide range of size distributions. The following size distribution, modeled after Neill (1973) is recommended.

100% finer than	$1.5 D_{r50}$
80% finer than	$1.25 D_{r50}$
50% finer than	$1 D_{r50}$
20% finer than	$0.6 D_{r50}$

### ***Riprap installation***

Recommended riprap installation for the case of prior excavation is outlined in Figures 8.3 and 8.4. The placement technique shown in the figures is predicated on the recommended use of a geotextile, as outlined below. The riprap cover  $c$  (i.e. the transverse extent from edge to edge of the riprap layer) is equal to  $4 D$ . That is, the riprap extends outward at least a distance  $1.5 D$  from every face, so that the total lateral distance from one edge of the riprap to the other is at least  $4 D$ , as illustrated in Figure 8.4. In the event that the angle of attack  $\beta$  exceeds  $15^\circ$ , the cover is taken to be at least  $4 D/\cos(\beta)$ , and distributed spatially as shown in the Figure 8.4. The bed is excavated to a depth  $t$  of at least  $2 D_{r50}$  before placing the riprap. The riprap is placed in the excavation in a layer with a thickness of at least  $2 D_{r50}$ , such that the top of the riprap layer is flush with the bed at low flow. The depth of excavation might best be increased to the level of deepest expected scour if significant scour and fill associated with e.g. a contraction or a bend is expected at the site. Such a deep placement may inhibit future inspection, but may provide more reliable protection in the long run.



**Figure 8.3.** Riprap installation with prior excavation.

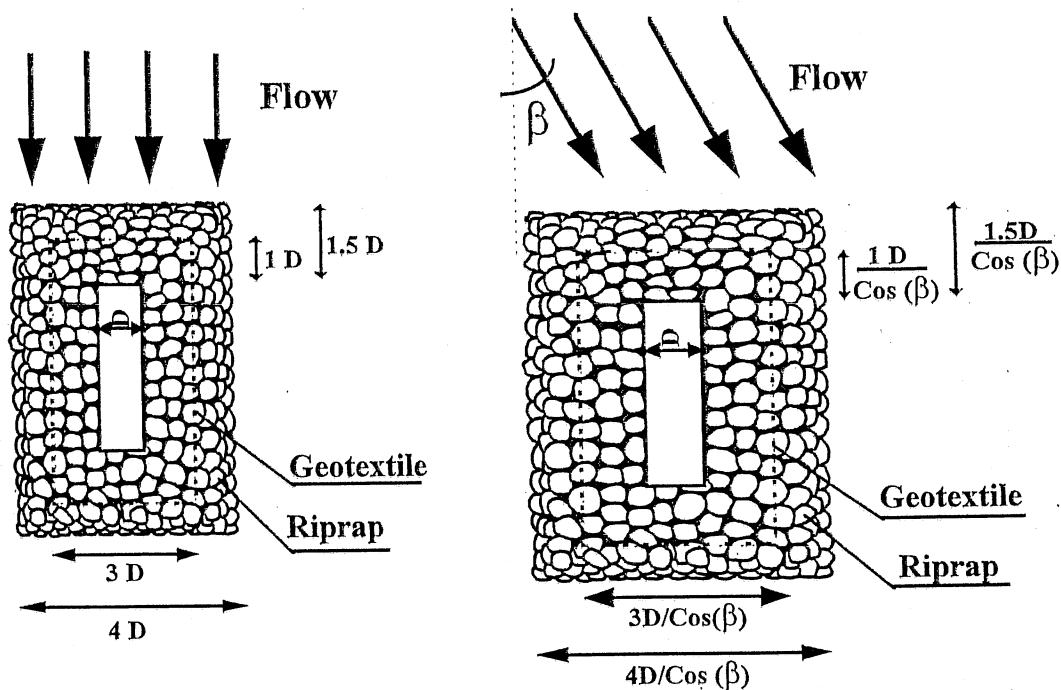


Figure 8.4. Riprap and geotextile cover with prior excavation.

#### *Geotextile filter or granular filter layer*

In the case of a gravel bed river it is recommended that a geotextile filter not be used. In the case of a sand bed river, it is recommended that a geotextile filter be placed underneath the riprap. It is recommended that the cover of the geotextile filter be  $3D$  as shown in Figure 8.4. Thus if the riprap extends  $1.5D$  outward from every face, the geotextile filter should extend  $1D$  out from every face. It is recommended that the geotextile filter never extend out as far as the riprap. Best performance can be obtained by sealing the geotextile filter to the pier. Sealing can be implemented by means of a flexible tube containing a cable that can be tightened around the pier. The flexible tube must be attached to the geotextile. Alternately, sealing can be implemented by installing a granular filter layer around any gap between the geotextile filter and the pier itself.

In the event that the use of a geotextile filter is not possible, a standard granular filter layer may be used in place of a geotextile filter. In such case it is recommended that special care be given to installation of both the filter layer and the riprap around the edges of the pier. The granular filter layer should have the same cover as the riprap itself.

It is recommended that riprap not be installed in a sand bed stream without a geotextile filter, or at least a granular filter layer. In the event that the means for such installation are unavailable, however, experiments suggest that at least some degree of protection is provided by a riprap layer with a thickness of at least  $4D_{150}$  and a cover of  $5D$ , i.e. extending out  $2D$  from every pier face. Prior excavation may be essential for such a case to realize any long term protection at all. Monitoring of such installations should be made frequently as riprap settling into the bed may necessitate replenishment.

## *Implementation notes*

### *Feasibility*

- Sand bed or gravel bed streams.
- Not necessary to apply the geotextile or granular filter on gravel streams.
- With no blockage of flow area, it is advantageous at sites with limited bridge conveyance area.
- Some resource agencies object to excavation in streams.
- Granular filters are a potential substitution for the geotextile, but will increase the degree of blockage due to filter layer thickness.
- Geotextile not easily sealed to pile bents.

### *Effectiveness*

- Good filter seal around pier is critical.
- Offers reduced tendency for rock dispersal.
- Areal footprint of countermeasure is smaller than that for riprap placed on grade. Thickness of the countermeasure is also less, and decrease in rock volume is 50 percent or more.
- Consider granular filter as an alternate to geotextile filter; granular filter may be subject to degradation due to passage of dunes during floods.
- Increased effectiveness if tied into abutment countermeasure when pier is located within 3 pier diameters of abutment footings.

### *Constructability*

- Decrease riprap volume from  $[5D \times (4D + L)] \times 3D_{50}$  to  $[4D \times (3D + L)] \times 2D_{50}$  as compared to installation without excavation.
- Pier footing and/or pile geometry may limit ability to pre-excavate.
- Specialized construction techniques are needed for geotextile placement. Recommendations in regard to their development are contained in this report.
- Gravel cushion placed on geotextile is recommended to avoid rupturing.
- Construction sequence is important for good performance; however, specifications generally dictate final placement, not construction sequence.

### *Durability*

- Generally provides a broad band of failure threshold.
- Catastrophic failure potential if the geotextile is exposed; this possibility can be minimized by designing the geotextile with a cover area that is less than that of the riprap.
- Prior excavation reduces exposure of rock to flow and increases durability.

### *Maintainability*

- University of Minnesota tests indicate decreased rock dispersal with this method (as compared to the case of no prior excavation), thus lowering maintenance requirements.
- Difficult to repair if the geotextile rips; riprap must be removed before repair.



- Difficult to identify exact location of geotextile failure.
- Rebuilding/repairing gravel filters is easier than geotextile repair.
- Geotextile fails abruptly.
- Clean up is difficult after a failure.

Cost

- Cost for hypothetical 4 ft x 20 ft rectangular pier is \$5,000/pier (as of 1998) when placed over a granular filter and about \$15,000 (as of 1998) when placed over a geotextile. Of this \$15,000, the cost for the installation of the submerged geotextile filter is about \$10,000. This cost includes a 4-person setup crew for 2 days per pier, a 6 person 1-day installation crew, plus one diver per day. The cost may come down with the development of specialized installation technology.
- Pre-excavation costs are about \$25/yd<sup>3</sup> with on-site disposal as of 1998.
- Disposal costs for excavated material may add to the cost.
- Lower rock requirements than without prior excavation due to smaller thickness and footprint. Approximately 50% less rock than without excavation.
- Traffic disruption should be considered.

**8.3.3 Design Recommendations for Riprap Without Prior Excavation but with Geotextile or Granular Filter**

***Required information***

- Pier width  $D$
- Pier shape: round nosed or square nosed
- Approach flow velocity  $U$  and approach flow depth  $y_0$  at design flow conditions
- Angle of attack  $\beta$  of flow at bridge pier at design flow conditions
- Density  $\rho_r$  of the riprap to be used

The design flow conditions might correspond to anything from a 10 year flood to a standard project flood, depending upon the economic and social importance of the bridge. Standard software such as WSPRO, HEC-RAS, RMA-2 or FESWMS is available to help the user predict  $U$ ,  $y_0$  and  $\beta$  at design conditions.

***Riprap sizing***

It is recommended that the median size of the riprap be determined using Eq. (8.2) due to Parola and Jones (1991), which also appears in the HEC-18 manual (Richardson et al., 1992).

***Riprap size distribution***

It is recommended that riprap be durable, angular rock with a wide range of size distributions. The following size distribution, modeled after Neill (1973) is recommended.

100% finer than	$1.5 D_{r50}$
80% finer than	$1.25 D_{r50}$
50% finer than	$1 D_{r50}$
20% finer than	$0.6 D_{r50}$

### Riprap installation

The recommended placement is outlined in Figures 8.5 and 8.6. In the case for which the bed is not excavated in advance it is recommended that riprap cover  $c$  should be increased to  $5 D$ . That is, the riprap extends outward at least a distance  $2 D$  from every face, so that the total lateral distance from one edge of the riprap to the other is at least  $5 D$ , as illustrated in Figure 8.6. In the event that the angle of attack  $\beta$  exceeds  $15^\circ$ , the cover is taken to be at least  $5 D/\cos(\beta)$ , and distributed spatially as shown in Figure 8.6. It is recommended that the river bed be smoothed, and any existing scour hole filled with finer riprap before the installation of the riprap sized by the method recommended above. The riprap is placed over the smoothed bed with a thickness of at least  $3 D_{150}$ . If this thickness is in excess of  $0.25 y_0$  at design flood, a condition that may prevail particularly in shallow gravel bed streams, it is recommended that this method of installation be abandoned and the bed be excavated before installation. If significant scour and fill associated with e.g. a contraction or a bend is expected at the site then riprap should not be installed without prior excavation.

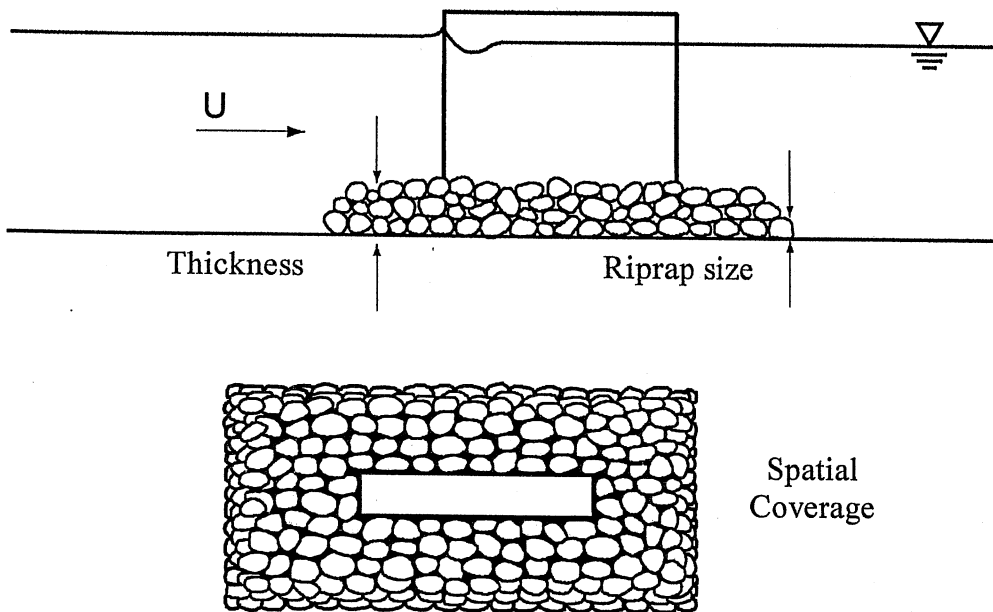


Figure 8.5. Riprap installation without prior excavation.

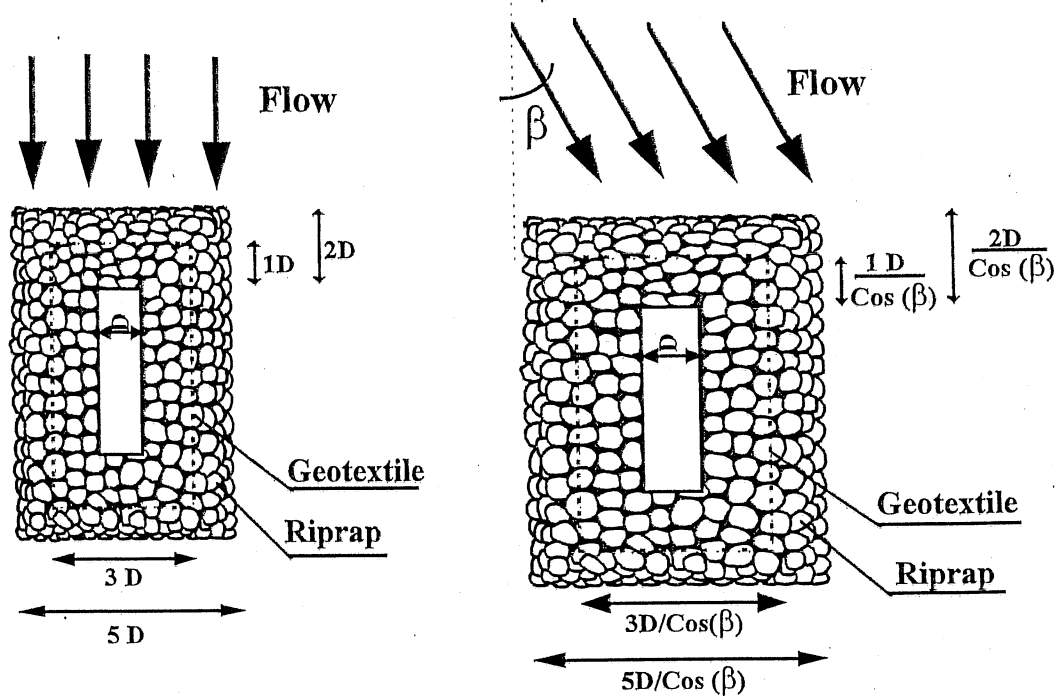


Figure 8.6. Riprap and geotextile cover without prior excavation.

#### *Geotextile filter or granular filter layer.*

It is recommended that in the case of a gravel bed river a geotextile filter not be used. In the case of a sand bed river, it is recommended that a geotextile filter be placed underneath the riprap. The cover of the geotextile filter is  $3D$ , so that the geotextile filter extends out  $1D$  from every face. It is recommended that the geotextile filter never extend out as far as the riprap. Best performance is obtained by sealing the geotextile filter to the pier. Sealing can be implemented by means of a flexible tube containing a cable that can be tightened around the pier. The flexible tube must be attached to the geotextile. Alternately, sealing can be implemented by installing a granular filter layer around any gap between the geotextile filter and the pier itself.

In the event that the use of a geotextile filter is not possible, a standard granular filter layer may be used in place of a geotextile filter. In such case it is recommended that special care be given to installation of both the filter layer and the riprap around the edges of the pier. The granular filter layer should have the same cover as the riprap itself.

#### *Implementation notes*

##### Feasibility

- Use geotextile filter or granular filter on sand bed streams (bed material  $d_{50} < 2 \text{ mm}$ ).
- Not necessary to apply the geotextile or granular filter on gravel streams.
- Method may reduce conveyance of bridge opening to an unacceptable level; it is recommended that blockages be less than 10% flow area, or 25% flow depth at pier.

- Granular filters are a potential substitution for the geotextile, but will increase the degree of blockage due to filter layer thickness.
- Geotextile not easily sealed to pile bents.

#### Effectiveness

- Good filter seal around pier is critical.
- Adequate rock coverage is needed so that fabric is not exposed upon settling of riprap around perimeter.
- Consider granular filter as an alternate to geotextile filter; granular filter may be subject to degradation due to passage of dunes during floods.
- Increased effectiveness if tied into abutment countermeasure when pier is located within 3 pier diameters of abutment footings.

#### Constructability

- Specialized construction techniques are needed for geotextile placement. Recommendations in regard to their development are contained in this report.
- Gravel cushion placed on geotextile is recommended to avoid rupturing.
- Construction sequence is important for good performance; however, specifications generally dictate final placement, not construction sequence.

#### Durability

- Generally provides a broad band of failure threshold.
- Catastrophic failure potential if the geotextile is exposed; this possibility can be minimized by designing the geotextile with a cover area that is less than that of the riprap.

#### Maintainability

- Difficult to repair if the geotextile rips; riprap must be removed before repair.
- Difficult to identify exact location of geotextile failure.
- Rebuilding/repairing gravel filters is easier than geotextile repair.
- Geotextile fails abruptly.
- Clean-up is difficult after a failure.

#### Cost

- Cost for a hypothetical 4 ft x 20 ft pier is \$14,500, as of 1998.
- Submerged geotextile installation cost is about \$10,000 for a single pier, as of 1998. This cost includes a 4 person setup crew for 2 days per pier, a 6 person 1-day installation crew, plus 1 diver for a day. The cost may come down with the development of specialized installation technology.
- Traffic disruption should be considered.

### 8.3.4 Design Recommendations for Riprap Without Prior Excavation, Without Geotextile or Granular Filter

#### *Required information*

- Pier width  $D$
- Pier shape: round nosed or square nosed
- Approach flow velocity  $U$  and approach flow depth  $y_0$  at design flow conditions
- Angle of attack  $\beta$  of flow at bridge pier at design flow conditions
- Density  $\rho_r$  of the riprap to be used

The design flow conditions might correspond to anything from a 10 year flood to a standard project flood, depending upon the economic and social importance of the bridge. Standard software such as WSPRO, HEC-RAS, RMA-2 or FESWMS is available to help the user predict  $U$ ,  $y_0$  and  $\beta$  at design conditions.

#### *Riprap sizing*

It is recommended that the median size of the riprap be determined using Eq. (8.2) due to Parola and Jones (1991), which also appears in the HEC-18 manual (Richardson et al., 1992).

#### *Riprap size distribution*

It is recommended that riprap be durable, angular rock with a wide range of size distributions. The following size distribution, modeled after Neill (1973) is recommended.

100% finer than	$1.5 D_{r50}$
80% finer than	$1.25 D_{r50}$
50% finer than	$1 D_{r50}$
20% finer than	$0.6 D_{r50}$

#### *Riprap installation*

An installation without prior excavation and without either a geotextile filter or a granular filter layer is recommended only in the case of gravel bed streams of sufficient depth to allow good submergence of the riprap layer at flood flow. It is not recommended for either a sand bed stream or a shallow gravel bed stream.

In the event that such an installation can be justified, the recommended placement is as outlined in Figures 8.5 and 8.6 (but without the geotextile or granular filter layer). Since the bed is not excavated in advance it is recommended that riprap cover  $c$  be  $5 D$ . That is, the riprap extends outward at least a distance  $2 D$  from every face, so that the total lateral distance from one edge of the riprap to the other is at least  $5 D$ , as illustrated in Figure 8.5. In the event that the angle of attack  $\beta$  exceeds  $15^\circ$ , the cover is taken to be at least  $5 D/\cos(\beta)$ , and distributed spatially as shown in Figure 8.6. It is recommended that the river bed be smoothed, and any existing scour hole filled with finer riprap before the installation of the riprap sized by the method recommended above. The riprap is placed over the smoothed bed with a thickness of at least  $3 D_{r50}$ . If this thickness is in excess of  $0.25 y_0$  at design flood, a condition that may prevail particularly in shallow gravel bed streams, it is recommended that this method of installation be abandoned and the bed be excavated before installation. If significant scour and fill associated with e.g. a contraction or a bend is expected at the site then riprap should not be installed without prior excavation.

## *Implementation notes*

### *Feasibility*

- For use in gravel bed streams only (bed material  $d_{50} > 2\text{mm}$ ).
- Not suitable for sand bed streams.
- Gradation is important for effective performance.
- Must have good interlocking between stones.
- Quarry run stone with wide gradation may work (supplies its own filter).
- Blocking of bridge opening may inhibit use; it is recommended that blockages be less than 10% flow area, or 25 % flow depth at pier.
- End dumping is not recommended as it can cause segregation of rock sizes.
- If placed on a sand bed stream, frequent retrofitting and adding of stones are required.

### *Effectiveness*

- Effective if bed material is sufficiently coarse so as not to winnow through the riprap.
- Gradation must be checked.
- Construction observation and communication of design requirements to the contractors are very important.
- Good quality control on riprap and installation is essential.
- Good for multiple events if rock size is adequate and rocks are not dispersed.
- Broad band of failure threshold exists (no catastrophic threshold).
- Increased effectiveness if tied into abutment countermeasure when pier is located within 3 pier diameters of abutment footing.

### *Constructability*

- Standard construction techniques: dumped rock (limit drop to less than 4 feet to avoid segregation); front end loader will result in poor placement if simply dumped from bucket; a back-hoe or clam shell is recommended.
- Equipment access considerations: right of way, incised stream access, and low bridge clearance.
- Good quality control is essential.
- Areal extent of coverage must be verified.
- Seasonal constraints exist on installation.

### *Durability*

- If properly designed, very durable; broad existing experience among practitioners.
- Rock can be expected to stay in place for events less than or equal to the design event.
- Broad band of failure threshold is provided; catastrophic failure of countermeasure is not typical.
- Self healing.

- Monitoring critical.

#### Maintainability

- Scour monitoring is critical for areal extent and depth of rock. Measurements taken during or immediately after events are best. Identify necessary maintenance before the protection becomes ineffective.
- Use common mapping techniques for which practitioners have wide experience (lead line, fathometer).
- Replacement rocks can usually be easily obtained.
- When displacement occurs, reuse of rocks is sometimes practical.

#### Cost

- For bridges of 3 or more spans, the typical unit prices as of 1998 for average wet placement conditions are about \$35 - 45/ton when rock is available within a 25 mile radius of the site.
- Additional transportation costs will be \$0.15 - 0.20/ton mile as of 1998.
- 50 to 100 yds<sup>3</sup> or riprap per pier is typical.
- Cost for a hypothetical 4 ft x 20 ft rectangular pier is estimated at \$4500/pier as of 1998.
- Lack of local availability of suitable rock will raise cost.
- Access and equipment considerations are important cost factors.
- Mobilization costs (economies of scale).
- Seasonal constraints (environmental windows, flow conditions) contribute additional expenses.
- A silt curtain may be required by regulatory agencies.
- Unit price (i.e. engineers thinking) vs. construction sequence costs (i.e. contractors' estimate): conversion from tons to yds<sup>3</sup> is  $1.4 \pm 0.1 \text{ T/yd}^3$ .
- Verify how quantity of rock measured. Volume vs. tonnage.
- Traffic disruption should be considered.

### 8.3.5 Design Recommendations for Cable Tied Blocks

#### *Required information*

- Pier width  $D$
- Pier shape: round nosed or square nosed
- Approach flow velocity  $U$  and approach flow depth  $y_o$  at design flow conditions
- Angle of attack  $\beta$  of flow at bridge pier at design flow conditions
- Density  $\rho_{cb}$  of the material of the blocks in the mattress
- Median size  $d_{50}$  of the bed material

The design flow conditions might correspond to anything from a 10 year flood to a standard project flood, depending upon the economic and social importance of the bridge. Standard software such as WSPRO, HEC-RAS, RMA-2 and FESWMS is available to help the user predict  $U$ ,  $y_o$  and  $\beta$  at design conditions.

### ***Weight per unit area of the cable tied block mattress***

The weight per unit area of the mattress  $\zeta$  may be sized as

$$\zeta = a_{cb} \frac{\rho_{cb}}{\rho_{cb} - \rho} \rho U^2 \quad a_{cb} = 0.20 \quad (8.3a,b)$$

where  $\rho$  denotes the density of water. If  $U$  is input in m/s and  $\rho_{cb}$  in  $\text{kg/m}^3$  then  $\rho$  is  $1000 \text{ kg/m}^3$  and  $\zeta$  is specified in  $\text{N/m}^2$ . If  $U$  is input in ft/s then  $\rho$  is  $1.94 \text{ slugs/ft}^3$ ,  $\rho_{cb} = (\text{s.g.}) \times 1.94 \text{ slugs/ft}^3$  where s.g. = specific gravity of the block material, and  $\zeta$  is specified in  $\text{lbs/ft}^2$ . The height of the blocks  $H_{cb}$  and the volume fraction pore space  $p$  in the mattress are related to  $\zeta$  by the relation

$$\zeta = \rho_{cb} g H_{cb} (1 - p) \quad (8.3c)$$

It is recommended that the spacing between cable tied block units be enough to allow the mattress a sufficient degree of flexibility.

### ***Cable quality***

The vicinities of bridge piers at the bottom of rivers are abrasive environments. It is recommended that the cable connecting the blocks be sufficiently flexible so as to allow the mattress to deform, but sufficiently durable to last at least 20 years in a fast-water river environment. Review of field installations has shown that even well specified galvanized cabling experiences internal interstrand corrosion. Stainless steel cables are advised for harsh environments. It is recommended that cable tied blocks not be used for even moderately saline environments such as estuaries.

### ***Mattress installation***

Installation recommendations are summarized in Figure 8.7. Prior excavation is not needed in the case of cable tied block mattresses. An exception to this might be a case for which block height  $H_{cb}$  exceeds  $0.25 y_o$ , where  $y_o$  denotes the flow depth under design conditions. The mattress cover  $c$  is equal to  $4 D$ . That is, the mattress extends outward at least a distance  $1.5 D$  from every face, so that the total lateral distance from one edge of the mattress to the other is at least  $4 D$ , as illustrated in Figure 8.7. In the event that the angle of attack  $\beta$  exceeds  $15^\circ$ , the cover is taken to be at least  $4 D/\cos(\beta)$ , and distributed spatially as shown in Figure 8.7.



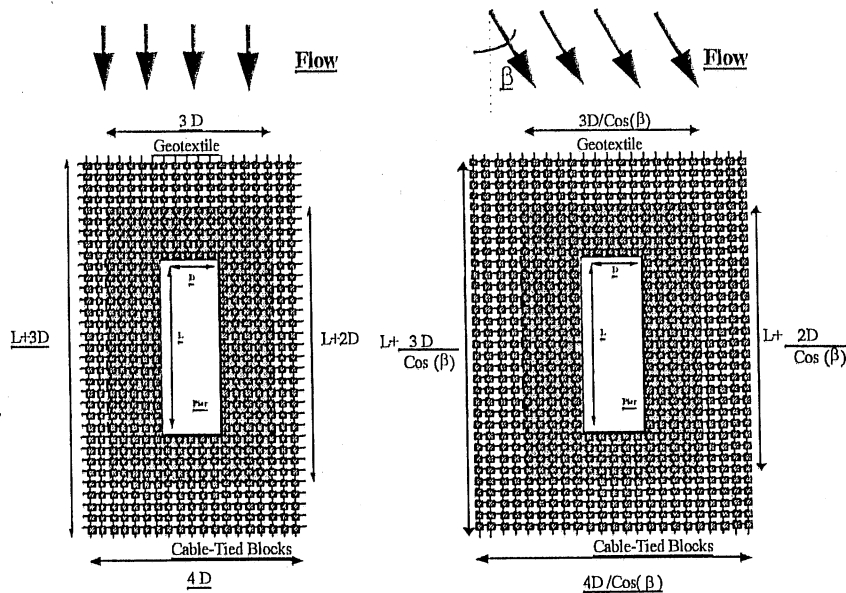


Figure 8.7. Installation of cable tied block mattress and geotextile.

### Geotextile filter

It is recommended that in the case of a gravel bed river a geotextile filter not be used. In the case of a sand bed river, it is recommended that a geotextile filter be placed underneath the mattress. It is recommended that the manufacturer fasten the geotextile filter firmly to the base of the block mattress. The cover of the geotextile filter extends  $2/3$  of the distance from the pier face to the edge of the mat. Thus if the mattress extends  $1.5 D$  outward from every face, the geotextile filter extends  $1 D$  out from every face. It is recommended that the geotextile filter never extend out as far as the mattress. It is recommended that a granular filter layer not be substituted for a geotextile filter in the case of cable tied blocks, due to the relative ease of fastening the geotextile filter to the mattress prior to installation. A granular filter may be used to help seal the mattress and geotextile filter to the pier, as outlined below.

The cable-tied block mattress can be constructed so that they can be fastened and sealed to the pier in the same way as outlined for the case of a geotextile under riprap. That is, the geotextile fastened below the block mattress extends beyond the inside edge a distance of 2 to 3 times the mat thickness and is attached to a flexible tube spanning the circumference of the pier. Inside the flexible tube is a cable. Upon installation, the additional geotextile is folded up, and the cable is tightened around the pier, thus fastening the mattress. Alternatively, a granular filter can be used to fill in the gap between the mattress-geotextile and the pier.

## *Implementation notes*

### *Feasibility*

- Sand bed and gravel bed rivers.
- Not suitable for pile bents or complex pier shapes.
- Not suitable for rivers with large cobbles or rock.
- Water quality must be noncorrosive, and thus is not appropriate for e.g. saline or acidic environments.
- Filter or geotextile required for sand bed river (bed material  $d_{50} < 2$  mm).

### *Effectiveness*

- Requires good seal at seams and around piers.
- Adequate mat flexibility is needed to allow settlement around margin. This allows for self-anchoring in sand bed streams.
- Cable location should be very near the center of each unit to allow maximum flexibility.
- Block shape should not inhibit flexibility.
- Communication of details to the contractor is essential to good performance.
- Method is not self-healing and catastrophic failure can occur.
- Effective over a wide range of conditions. Method can sustain several flow events with minimal maintenance.

### *Constructability*

- Site access for construction, cranes and equipment is needed.
- To allow the mat to settle properly, fabric must be cut away from blocks along the outer edge of the mat.
- A granular filter around the pier can be used to provide a seal at the pier.
- Allow no vertical discontinuity at junctions.
- Divers will potentially be required to tie mats together.
- On gravel streams, edges must be anchored (pre-excavation).
- Pre-excavation of upstream edge of the mat is required.

### *Durability*

- Cable durability is critical, corrosive activity (salinity and/or acidity) of water is a factor.
- The issue of concrete durability should be considered; it is less severe than that of cable durability.

### *Maintainability*

- Difficult to patch.
- Not self healing.

### Cost

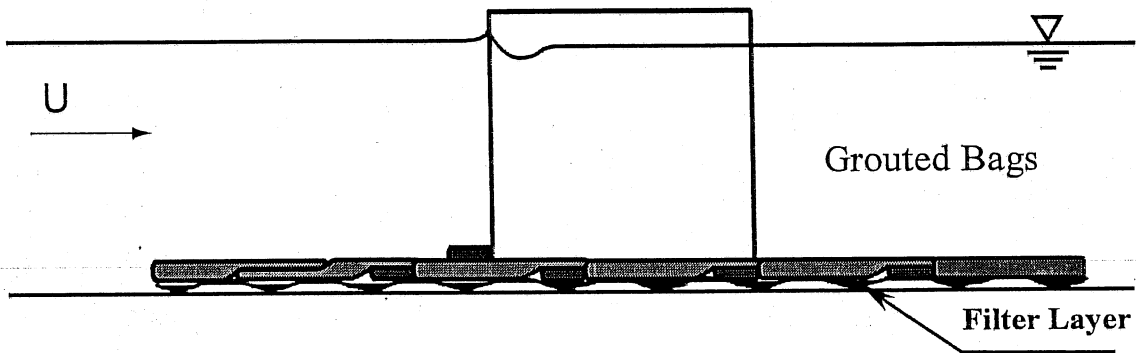
- Typically laid-in-place wet placement cost of approximately \$15 - 16/ft<sup>2</sup> as of 1998.
- Seal construction approximately \$2000 for a typical pier as of 1998.
- Cost to place cable tied blocks around a 4 ft x 20 ft rectangular pier is about \$9,000 as of 1998.
- Traffic disruption should be considered.

### 8.3.6 Design Recommendations for Grout Filled Bags

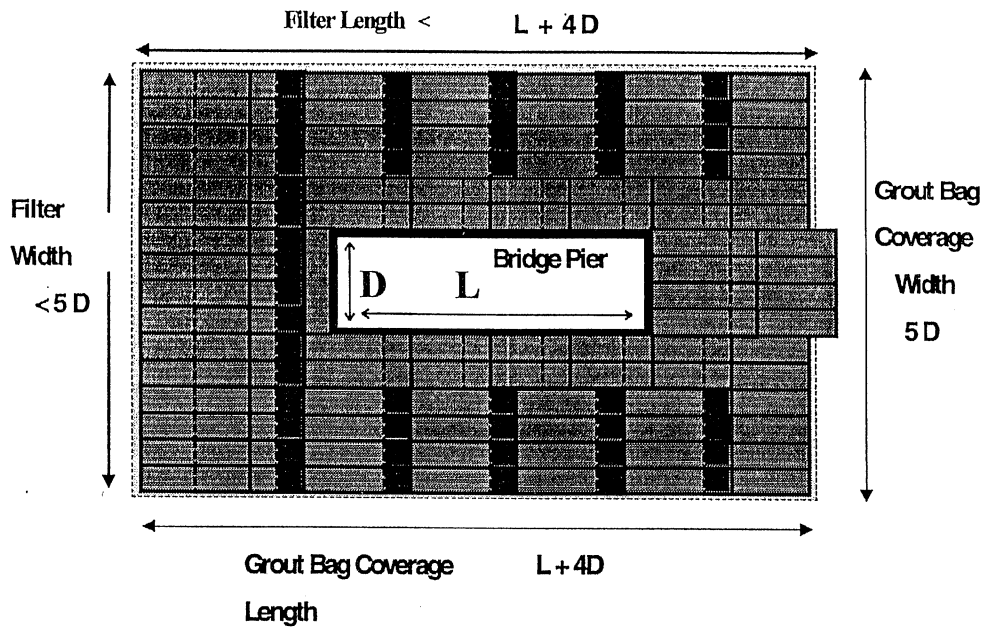
The authors of this report recommend avoiding grout filled bags. This is because their lack of angularity, relatively smooth surface and lack of flexibility make them more easily prone to failure than either properly designed riprap or cable tied block mattresses. It is suggested that grout filled bags not be installed in gravel bed streams. Circumstances that may warrant installation, however, include the following: a) riprap is not easily available; b) regulations do not permit the use of riprap or other alternatives; and c) the bridge is too small to allow the equipment needed to install riprap or other countermeasures.

In the event that a decision is made to install them, the guidelines are the same as those for riprap installation with prior excavation, but with cover width increased from 4D to 5D (Figure 8.8b). The calculation of bag size is done with the same relations as for riprap, but it is recommended that the user take account of the fact that grout is usually lighter than natural riprap by using the density  $\rho_r$  pertaining to the grout. In addition, it may be advisable to oversize the bag size ( $D_{r,50}$ ) by a factor of 1.2 to add some stability. If possible the surface of the bags should be rendered angular and rough. In the event that the angle of attack  $\beta$  exceeds 15 degrees, the cover area should be increased in accordance with Figure 8.6.

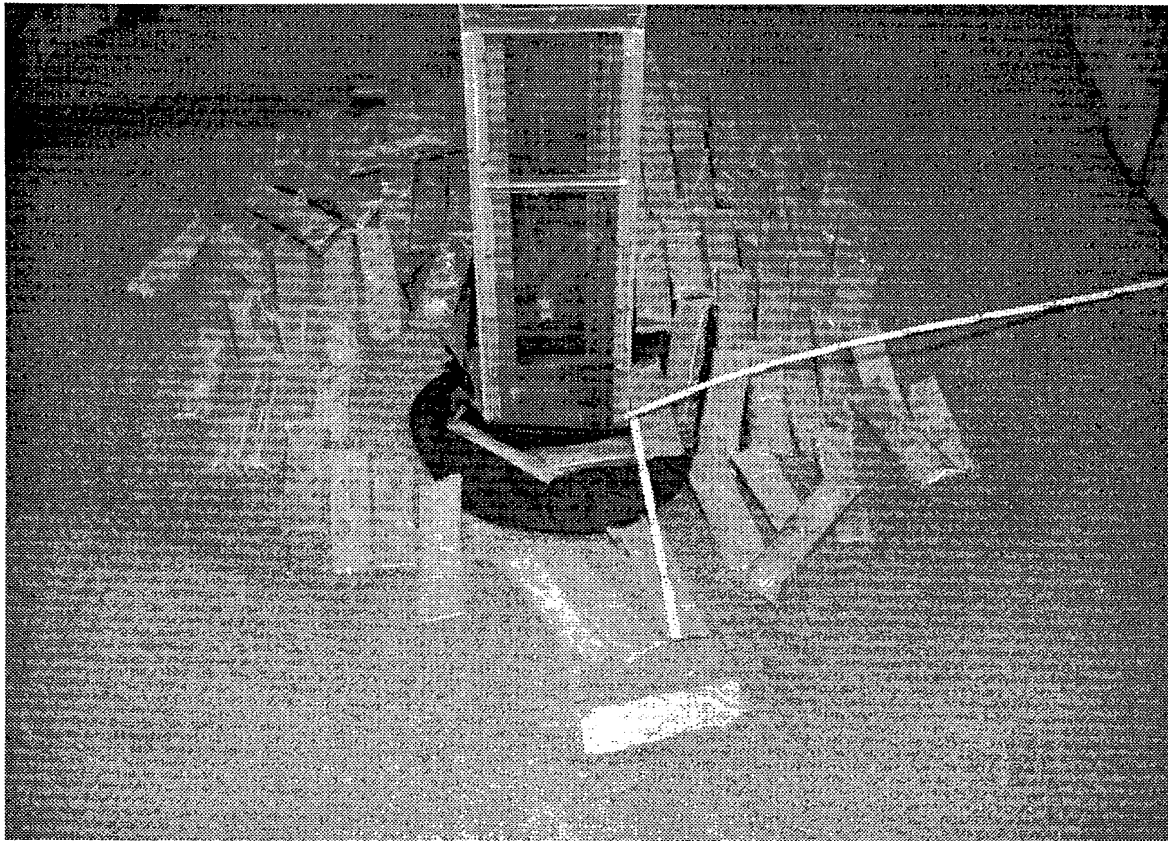
One possible installation of grout filled bags is presented in Figures 8.8a and 8.8b. The potential problems with grout filled bags are illustrated in Figure 8.8c.



**Figure 8.8a.** Installation of grout filled bags.



**Figure 8.8b.** Grout filled bag and geotextile cover. In the event that the attack angle  $\beta$  exceeds  $15^\circ$  the installation follows the guidelines of Figure 8.6.



**Figure 8.8c.** Illustration of the dispersive sliding of grout filled bags under conditions for which the equivalent riprap did not fail.

Poor quality grout may degrade and break or crumble. Long grout filled sausages are not recommended unless they consist of multiple connected units, so as to possess some degree of flexibility.

### ***Geotextile filter or granular filter layer***

It is recommended that in the case of a gravel bed river a geotextile filter not be used. In the case of a sand bed river, it is recommended that a geotextile filter be placed underneath the grout filled bags. The cover of the geotextile filter should be less than that of the grout filled bags. Best performance is obtained by sealing the geotextile filter to the pier. Sealing can be implemented by means of a flexible tube containing a cable that can be tightened around the pier. The flexible tube must be attached to the geotextile. Alternately, sealing can be implemented by installing a granular filter layer around any gap between the geotextile filter and the pier itself.

In the event that the use of a geotextile filter is not possible, a standard granular filter layer may be used in place of a geotextile filter. In such case it is recommended that special care be given to installation of both the filter layer and the grout filled bags around the edges of the pier. The granular filter layer may have the same cover as the riprap itself. Care must be given to the grain size distribution of the granular filter in light of the uniformity of bag size.

### ***Implementation notes***

Testing conducted at the University of Minnesota indicated that grout bags did not perform well during floods in sand bed streams with developed dunes. However, field observations of installations in Maryland have shown effective performance when located in streams with the following characteristics:

1. Minimal bedforms.
2. Small streams.
3. Bags large relative to scour hole size.

### **Feasibility**

- Potentially applicable only to small streams or cases where pier width does not exceed the bag width (typically 3 to 4 ft).
- Useful in areas with no rock.
- Reduces amount of blockage compared to riprap without pre-excavation.
- Shallow water placement can be performed quickly.

### **Effectiveness**

- Bags do not interlock well and are not flexible.
- Bag diameter adjustment is needed because of lower material density.

### **Constructability**

- Bag size 10 ft x 3 ft x 1 ft.
- Easily constructable with use of concrete pump, bags, and diver.
- Requires less access for equipment and construction than other countermeasures.
- Use geotextile to seal the connection between the pier and the bags.

### **Durability**

- Not as self healing as riprap.

- Limited tensile strength.

#### Maintainability

- Catastrophic failure potential (cantilever failure of bag).

#### Cost

- Typical cost \$600/bag for a 10 ft x 3 ft x 1 ft bag as of 1998.
- Typical installation of this countermeasure requiring six 10 ft x 3 ft x 1 ft bags is about \$3500 as of 1998.
- Traffic disruption should be considered.

#### Special

- Investigate sand filled bags as an alternative as these offer greater flexibility.
- Compartmentalized bags may limit catastrophic failure of sand filled bags if bag rips.

### 8.3.7 Design Recommendations for Gabions

#### *Caveat*

It is recommended that gabions not be used for gravel bed streams due to the effect of abrasion on the wiring of the cages. The long-term durability of the wiring under the intense flow conditions associated with bridge piers in floods has not been demonstrated even in sand bed streams. The use of gabions for bridge pier protection thus has an element of uncertainty. The guidelines presented at the beginning of Chapter 8 of Volume II of this report should be considered in the selection of gabion casings.

#### *Required information*

- Pier width D
- Pier shape: round nosed or square nosed
- River type: sand bed or gravel
- Approach flow velocity U at design flow conditions
- Angle of attack  $\beta$  of flow at bridge pier at design flow conditions
- Density  $\rho_r$  of the rock to be used in the gabions

The design flow conditions might correspond to anything from a 10 year flood to a standard project flood, depending upon the economic and social importance of the bridge. Standard software such as WSPRO, HEC-RAS, RMA-2 and FESWMS is available to help the user predict U and  $\beta$  at design conditions.

#### *Gabion and Reno mattress sizing*

It is recommended that the minimum allowable basket volume V for individual unconnected baskets be estimated from the following relation;

$$V = 0.069 \frac{U^6 K^6}{\left(\frac{\rho_r}{\rho} - 1\right)^3 g^3} \quad (8.4)$$

In the above relation  $g$  denotes the acceleration of gravity,  $\rho_r$  denotes the density of the rocks in the basket,  $\rho$  denotes the density of water so that  $\rho_r/\rho$  denotes the specific gravity of the rocks and  $K = 1.5$  for round nosed piers and  $1.7$  for square nosed piers. If  $U$  is input in m/s,  $g = 9.81 \text{ m/s}^2$  and  $V$  is specified in  $\text{m}^3$ . If  $U$  is given in ft/s,  $g = 32.2 \text{ ft/s}^2$  and  $V$  is specified in  $\text{ft}^3$ . The above relation was adapted from the relation of Parola and Jones (1991) for riprap, Eq. (8.2), but with a bulk rock density of  $100 \text{ lbs/ft}^3$ .

It may be appropriate to choose gabions with a volume that is larger than the size indicated from the above relation. To reduce cross-sectional blockage and resist uplift the baskets should be kept relatively low in height. It is recommended, however, that the minimum height be  $0.15 \text{ m}$  ( $6 \text{ in}$ ). It is recommended that minimum rock size be at least  $25\%$  larger than the minimum spacing between the basket wiring. A maximum size not to exceed  $2/3$  of the minimum basket size (normally the height) is recommended.

### ***Basket materials***

Basket flexibility combined with durability are paramount to the effective performance of gabions. Baskets should be made of single strand galvanized or PVC coated wiring in order to protect against corrosion. It is recommended that wire be like that of a chain link fence, i.e. formed with a double twist to help prevent unraveling. The basket sidewalls are reinforced with wires of a diameter that is larger than that used for the basket mesh in order to provide sidewall stiffness.

### ***Gabion installation***

A recommended gabion installation is shown in Figures 8.9a and 8.9b. It is recommended that the gabion coverage  $c$  be equal to  $5 D$ . That is, the gabions extend outward at least a distance  $2 D$  from every face, so that the total lateral distance from one edge of the gabions to the other is at least  $5 D$ , as illustrated in Figure 8.10b. In the event that the angle of attack  $\beta$  exceeds  $15^\circ$ , the cover is taken to be at least  $5 D/\cos(\beta)$ , and distributed spatially as indicated in the case for riprap without prior excavation (Figure 8.6). It is recommended that the river bed should be smoothed, and any existing scour hole filled with stones before the installation of the gabions. Adjacent baskets are joined together using the same wire as used for lacing the baskets. It is recommended that empty baskets be attached to gabions already in position, stretched, and the correct alignment obtained prior to filling the basket. Hand work is typically necessary to minimize the percentage of voids.

### ***Geotextile filter***

In the case of interconnected gabions on a sand bed river, a geotextile filter placed underneath the baskets should be used to prevent sand leaching. It is recommended that the cover of the geotextile filter be somewhat less than the cover of the baskets. Best performance may be obtained by sealing the geotextile filter to the pier. Sealing can be implemented by means of a flexible tube containing a cable that can be tightened around the pier. The flexible tube must be attached to the geotextile. Alternately, sealing can be implemented by installing a granular filter layer around any gap between the geotextile filter and the pier itself.

A filter layer may be used in place of a geotextile filter, but in such case special care should be given to installation of both the filter layer and the gabion placement around the edges of the pier. The granular filter layer may have the same cover as the baskets.

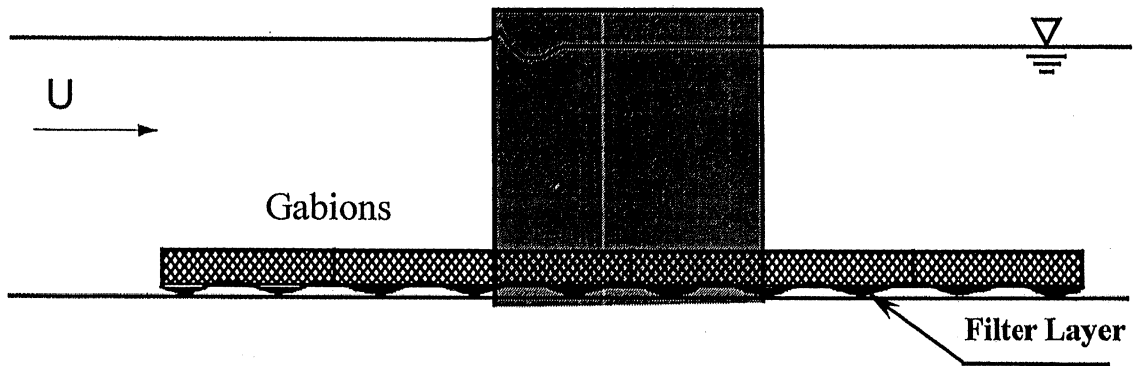


Figure 8.9a. Gabion installation.

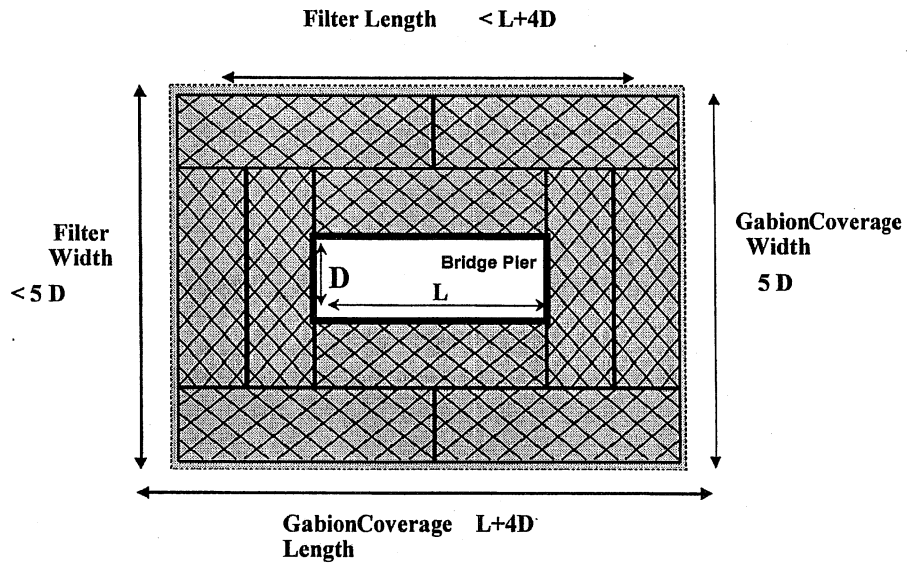


Figure 8.9b. Gabion and geotextile cover.



## *Implementation notes*

### Feasibility

- Appropriate for use in sand bed streams only (bed material  $d_{50} < 2$  mm) due to wire abrasion by coarse bed load.
- Not suitable for gravel bed streams. Bedload abrasion can wear out the wire mesh causing gabion rupture.
- Makes use of smaller rocks. Applicable where big rocks are not easily found or are very expensive.
- Difficult method to use for non-uniform geometry.
- Water quality must be non-corrosive.

### Effectiveness

- After installation, geotextile must be able to deform without failure to be effective.
- Junction discontinuities create weak points.

### Constructability

- Constructed on site and lifted into place or filled and assembled in place. The latter method requires minimal equipment and can be completed by hand if necessary.
- Pre-excavation to make top of gabion installation flush with bed is advantageous.

### Durability

- Limited wire durability. Not recommended in highly abrasive (e.g. gravel bed streams) or corrosive (e.g. saline or acidic water) settings.

### Maintainability

- Some opportunity may exist to repair in place.
- Relatively easy to maintain by using custom fit baskets, wire mesh, and rock.

### Cost

- Cost for hypothetical 4 ft x 20 ft rectangular pier is \$5,000 as of 1998.

## 9. REFERENCES

1. Abam, T. K. S. and Okagbue, C. O., "Construction and Performance of River Bank Erosion Protection Structure in the Niger Delta." *Bulletin - Association of Engineering Geologists*, Vol. 23, No. 4 (1986), pp. 499-506.
2. Abed, L. M., "Local Scour Around Bridge Piers in Pressure Flow." *Ph.D. Thesis*, Colorado State University (1991), 304 p.
3. Abt, S. R., Wittler, R. J., et al., "Development of Riprap Design Criteria by Riprap Testing in Flumes: Phase II." U.S. Nuclear Regulatory Commission, *Report NUREG/CR-4651 ORNL/TM-10100/V2 Vol.2* (1988).
4. Ahmed, F., "Flow and Erosion Around Bridge Piers." *PhD Thesis*, University of Alberta (1995).
5. Ahmed, F. and Rajaratnam, N., "Observations on Flow Around Bridge Piers." *Hydraulic Engineering*, Baltimore, Maryland, *Proc. Vol. 1* (1992), pp. 835-839.
6. Anderson, A. G., "Scour at Bridge Waterways." Federal Highway Administration, *Report FHWA-RD-75-89* (1974).
7. Anderson, A. G. and Davenport, J. T., "Tentative Design Procedure for Riprap-Lined Channels." National Cooperative Highway Research Program, *Report NCHRP-108* (1970).
8. Andres, D., "Pier Scour in Cohesive Materials." Workshop on Bridge Hydraulics and other aspects of stream crossing design, Banff, Alberta, Canada, *Proc.* (1983), pp. 386-418.
9. Andrianov, G. A., "Andrianov's Anti-Scour Compositions (AASC)." Bridge Dept., Moscow Automobile and Highway Engineering University, *Report* (Undated).
10. Apelt, C. J. and Isaacs, L. T., "Bridge Piers-Hydrodynamic Force Coefficients." *Journal of the Hydraulics Division, ASCE*, Vol. 94, HY1 (1968), pp. 17-30.
11. Atayee, A. T., "The Numerical and Experimental Study of Riprap as Scour Protection for Spill-Through Abutments." *M.S. Thesis*, George Washington University (1993a),
12. Atayee, A. T., "Study of Riprap as Scour Protection for Spill-Through Abutments." *Transportation Research Record*, (1993b), pp. 40-48.
13. Atayee, A. T., Pagan-Ortiz, J. E., et al., "Study of Riprap as Scour Protection for Bridge Abutments." *Hydraulic Engineering '93*, San Francisco, CA, *Proc. Vol. 1* (1993), pp. 973-978.
14. Baker, C. J., "Theoretical Approach to Prediction of Local Scour around Bridge Piers." *Journal of Hydraulic Research*, Vol. 18, 1 (1980), pp. 1-12.
15. Baker, C. J., "New Design Equations for Scour Around Bridge Piers." *Journal of the Hydraulics Division, ASCE*, Vol. 107, No. HY4 (1981), pp. 507-511.
16. Baker, R. E., "Local Scour at Bridge Piers in Non-Uniform Sediment." University of Auckland, *Report No.402* (1986).
17. Barbe, D. E., Cruise, J. F., et al., "Probabilistic Approach to Local Bridge Pier Scour." *Transportation Research Record*, Vol. 1350, (1992), pp. 28-33.
18. Bedingfield, L. and Hourani, N. M., "Scour Surveying and Countermeasures in Massachusetts." Federal Highway Administration, *Report FHWA-RD-90-035* (1989).
19. Bedingfield, L. and Murphy, V., "Surveying for Scour." *Civil Engineering*, November (1987), pp. 67-69.

20. Belik, L., "The Secondary Flow About Circular Cylinders Mounted Normal to a Flat Plate." *Aeronautical Quarterly*, February (1973), pp. 47-54.
21. Berlamont, J. and Schiara, M., "Local Channel Stabilization of Reach-Type Rivers." *Agricultural Engineering*, Vol. 69, 4 (1988), pp. 27.
22. Bertoldi, D. and Kilgore, R., "Tetrapods as a Scour Countermeasure." Hydraulic Engineering '93, San Francisco, CA., *Proc.* Vol. 2 (1993), pp. 1385-1390.
23. Bertoldi, D. A., Jones, J. S., et al., "An Experimental Study of Scour Protection Alternatives at Bridge Piers." Federal Highway Administration, Turner-Fairbank Laboratory, *Report* (1994).
24. Blaisdell, F. W., Anderson, C. L., et al., "Ultimate Dimensions of Local Scour." *Journal of the Hydraulics Division, ASCE*, Vol. 107, HY3 (1981), pp. 327-337.
25. Blodgett, J. C., "Effect of Bridge Piers on Streamflow and Channel Geometry." Committee on Hydrology, Hydraulics and Water Quality, *Proc.* (1984), pp. 172-183.
26. Bonasoundas, M., "Flow Structure and Problems at Circular Bridge Piers." Oscar V. Miller Institute, Munich Technical University, Munich, West Germany, *Report 28* (1973).
27. Bradley, J. N., "Hydraulics of Bridge Waterways." U.S. Department of Transportation, Federal Highway Administration, Hydraulic Design Series No. 1, *Report* (1973).
28. Breusers, H. N. C., "Time Scale of Two-Dimensional Local Scour." 12th. Congress on the International Association for Hydraulic Research, Fort Collins, *Proc.* Vol. 3 (1967), pp. 275-282.
29. Breusers, H. N. C., Nicollet, G., et al., "Local Scour Around Cylindrical Piers." *Journal of Hydraulic Research*, Vol. 15, 3 (1977), pp. 211-252.
30. (Breusers, H. N. C. and Raudkivi, A. J.), *Scouring*. A.A. Balkema (1991) 143 p.
31. Brice, J. C., "Stability of Relocated Stream Channels." U.S. Geological Survey, *Report FHWA/RD-80/158* (1981).
32. Brice, J. C. and Blodgett, J. C., "Countermeasures for Hydraulic Problems at Bridges, Volume I: Analysis and Assessment." Federal Highway Administration, *Report FHWA-RD-78-162* (1978a).
33. Brice, J. C. and Blodgett, J. C., "Countermeasures for Hydraulic Problems at Bridges, Volume II: Case Histories for Sites 1-238." Federal Highway Administration, *Report FHWA-RD-78-163* (1978b).
34. Brown, S. A., "Streambank Stabilization Measures for Highway Stream Crossings-Executive Summary." Federal Highway Administration, *Report FHWA/RD-84-099* (1985a).
35. Brown, S. A., "Streambank Stabilization Measures for Highway Engineers." Federal Highway Administration, *Report FHWA/RD-84-100* (1985b).
36. Brown, S. A. and Clyde, E. S., "Design of Riprap Revetment." Federal Highway Administration, U.S. Department of Transportation, Washington, D.C., *Report FHWA-IP-89-016; HEC-11* (1989).
37. Brown, S. A., McQuivey, R. S., et al., "Flow Control Structures for Highways in River Environments." The Sutron Corporation, *Report SCR-371-81-051* (1981).
38. Brown, T. C., "Gabion Report on Some Factors Affecting the Use of Maccaferri Gabions and Reno-Mattresses for Coastal Revetments." Manly Vale, NSW, Univ. NSW, Water Resources Lab., *Report No. 156* (1979).
39. Butch, G. K., "Measurement of Bridge Scour at Selected Sites in New York, Excluding Long Island." U.S. Geological Survey, *Report USGS/91-4083* (1991).
40. California Division of Highways, "Bank and Shore Protection in California Highway Practice." State of California, Sacramento, *Report* (1970).

41. Carstens, M. R., "Similarity Laws for Localized Scour." *Journal of the Hydraulics Division, ASCE*, Vol. 92, No. HY3 (1966), pp. 13-36.
42. Chabert, J. and Engeldinger, P., "Etude des afouillements autour des piles des ponts." Laboratoire National d'Hydraulique, Chatou, France, *Report* (1956).
43. Chang, F. F. M., "A Statistical Summary of the Cause and Cost of Bridge Failures." Federal Highway Administration, *Report FHWA-RD-75-87* (1973).
44. Chang, F. F. M., "Restoration of Degraded Streambed by Reducing Flow Velocity." Federal Highway Administration, *Report* (1994).
45. Chang, F. F. M. and Karim, M., "An Experimental Study of Reducing Scour Around Bridge Piers Using Piles." South Dakota Department of Highways, *Report* (1972).
46. Chang, H. H., "Local Scour Around Bridge Piers". *Fluvial Processes in River Engineering*, (1988) pp. 96-103.
47. (Chang, H. H.), *Fluvial Processes in River Engineering*. Krieger Publishing Co. (1992) 432 p.
48. Chee, R. K. W., "Live-Bed Scour at Bridge Piers." University of Auckland, *Report No.290* (1982).
49. Chiew, Y. M., "Local Scour at Bridge Piers." University of Auckland, New Zealand *Report No.355* (1984).
50. Chiew, Y. M., "Influence of Sediment Gradation on Scour at Bridge Piers." 23rd Congress IAHR, Ottawa, Canada, *Proc.* (1989).
51. Chiew, Y. M., "Mechanics of Local Scour Around Submarine Pipelines." *Journal of Hydraulic Engineering, ASCE*, Vol. 116, 4 (1990), pp. 515-529.
52. Chiew, Y. M., "Prediction of Maximum Scour Depth at submarine Pipelines." *Journal of Hydraulic Engineering, ASCE*, Vol. 117, 4 (1991), pp. 452-466.
53. Chiew, Y. M., "Scour Protection at Bridge Piers." *Journal of Hydraulic Engineering, ASCE*, Vol. 118, 9 (1992a), pp. 1260-9.
54. Chiew, Y. M., "Effect of Dune Migration on Scour at Bridge Piers." *International Journal of Sediment Research*, Vol. 7, 1 (1992b), pp. 77-92.
55. Chiew, Y. M., "Effect of Spoilers on Scour at Submarine Pipelines." *Journal of Hydraulic Engineering, ASCE*, Vol. 118, 9 (1992c), pp. 1311-1317.
56. Chiew, Y. M., "Riprap Protection Around a Bridge Pier." Proceedings 9th Congress of the APD of the IAHR, Singapore, *Proc.* Vol. 2 (1994), pp. 11-17.
57. Chiew, Y. M., "Mechanics of Riprap Failure at Bridge Piers." *Journal of Hydraulic Engineering, ASCE*, Vol. 121, 9 (1995), pp. 635-643.
58. Chiew, Y. M. and Melville, B. M., "Local Scour Around Bridge Piers." *Journal of Hydraulic Research*, Vol. 25, No.1 (1987), pp. 15-26.
59. Chiew, Y. M. and Melville, B. W., "Local Scour at Bridge Piers with Non-uniform Sediments." *Proc. Instn Civ. Engrs.*, Vol. 87, Part 2 (1989), pp. 215-224.
60. Chin, C. O. and Chiew, Y. M., "Effect of Spoilers on Wave-Induced Scour at Submarine Pipelines." *Journal of Waterway, Port, Coastal and Ocean Engineering*, Vol. 119, 4 (1993), pp. 417-428.
61. Chitale, S. V., "Estimation of Scour at Bridge Piers." *Irrigation & Power*, Vol. 45, 1 (1993a), pp. 57-68.
62. Chitale, S. V., "Indian Practice of Pier Scour Estimation - Limitations." *Irrigation & Power*, Vol. 50, 2 (1993b), pp. 7-14.

63. Chitale, S. V., "Scour for Bridge Foundations - Indian Scenario." *Irrigation & Power*, Vol. 51, 1 (1993c), pp. 127-132.
64. Collins, S. H. and Moon, G. C., "Stereometric Measurement of Stream Erosion." *Photogrammetric Engineering and Remote Sensing*, Vol. 42, No. 2 (1979), pp. 183-190.
65. Cozzens, H. F., "Steel Rails for Bank Protection on Salinas River, California." *Civil Engineering*, Vol. 16, 3 (1946), pp. 113-115.
66. Croad, R. N., "Effect of Riprap on Pier Scour." Central Laboratories, New Zealand, *Report No.90-23201* (1990).
67. Daido, A. and Yano, S., "Local Scour Around Bridge Piers and Its Protection with Guide Wall and Slanting Plate and Piers Surface." 6th International Symposium on River Sedimentation, *Proc.* (1995).
68. Danzig, C. K., "The Flow Around Piers of Different Shapes and Its Effect on the River Bed." U.S. Department of the Interior, *Report* (1991).
69. Dargahi, B., "Local Scour at Bridge Piers - A Review of Theory and Practice." Royal Institute of Technology, Hydraulics Laboratory, Stockholm, Sweden, *Report Bulletin No. TRITA-VBI-114* (1982).
70. Dargahi, B., "Flow Field and Local Scouring Around a Cylinder." Royal Institute of Technology, Stockholm, Sweden, *Report TRITA-VBI-137* (1987).
71. Dargahi, B., "Controlling Mechanism of Local Scouring." *Journal of Hydraulic Engineering, ASCE*, Vol. 116, 10 (1990), pp. 1197-1214.
72. Davis, S. R., "Case Histories of Scour Problems at Bridges." *Transportation Research Record, Report No.950* (1984).
73. Davis, J. E. and Landin, M. C., Proceedings of the National Workshop on Geotextile Tube Applications, Technical Report WRP-RE-17, U.S. Army Engineer Waterways Experiment Station, Vicksburg, MS (1997).
74. Davoren, A., "Local Scour Around a Cylindrical Bridge Pier." Hydrology Centre, Christchurch, *Report Publication No. 3* (1985).
75. de Groot, M. B., Blik, A. J., et al., "Critical Scour: New Bed Protection Design Method." *Journal of Hydraulic Engineering, ASCE*, Vol. 114, No. 10 (1988), pp. 1227-1239.
76. Delft Geotechnics, "Reprints of the International Riprap Workshop." Fort Collins, *Proc.* Vol. 1 (1993).
77. Dey, S., Singh, A. K., et al., "Spacing of Bridge Piers without Choke." *Indian Highways*, Vol. 19, 8 (1991), pp. 17-25.
78. Dinehart, R. L., "Evolution of Coarse Gravel Bed Forms: Field Measurements at Flood Stage." *Water Resources Research*, Vol. 28, No. 10 (1992), pp. 2667-2689.
79. Dongol, D. M., "Effect of Debris Rafting on Local Scour at Bridge Piers." University of Auckland, *Report 473* (1989).
80. Dongol, D. M. S., "Local Scour at Bridge Abutments." School of Engineering, University of Auckland, *Report No. 544* (1994).
81. Elliott, K. R. and Baker, C. J., "Effect of Pier Spacing on Scour Around Bridge Piers." *Journal of Hydraulic Engineering, ASCE*, Vol. 111, No. 7 (1985), pp. 1105-1109.
82. Engels, "Experiments Pertaining to the Protection of Bridge Piers Against Undermining". *Hydraulic Laboratory Practice*, New York, ASME. (1929).
83. Engelund, F. and Hansen, E., A Monograph on Sediment Transport. Technisk Vorlag, Copenhagen (1972) 66 p.

84. Ettema, R., "Influence of Bed Material Gradation on Local Scour." School of Engineering, University of Auckland, New Zealand, *Report No. 124* (1976).
85. Ettema, R., "Scour at Bridge Piers." School of Engineering, University of Auckland, *Report 216* (1980).
86. Ettema, R., Discussion of "Design Method for Local Scour at Bridge Piers." by B. W. Melville and A. J. Sutherland, *Journal of Hydraulic Engineering*, ASCE, Vol. 116, 10 (1990), p. 1290.
87. Fenner, T. J., "Scoping Out Scour. (New Underwater Bridge Inspection Methods)." *Civil Engineering*, Vol. 63, 3 (1993), pp. 75.
88. FHWA, D. o. T., "Design of Riprap Revetment." Federal Highway Administration, *Report FHWA-IT-89-016* (1989).
89. FHWA/USGS, "Proceedings of the Bridge Scour Symposium." *Proc.* (1989),
90. Fiorotto, V., Discussion of "Local Scour at Bridge Abutments." by B. W. Melville, *Journal of Hydraulic Engineering*, ASCE, Vol. 119, No. 9 (1993), p. 1064.
91. Fischer, E. and Jain, S. C., Discussion of "Live-Bed Scour at Bridge Piers." by Bruce W. Melville, *Journal of Hydraulics Engineering*, ASCE, Vol. 113, No. 3 (1987), p. 403.
92. Fotherby, L. M., "Footings, Mats, Grout Bags, and Tetrapods Protection Methods against Local Scour at Bridge Piers." *M. S. Thesis*, Colorado State University (1992).
93. Fotherby, L. M., "Alternatives to Riprap for Protection Against Local Scour at Bridge Piers." *Transportation Research Record*, Vol. 1420, (1993), pp. 32-39.
94. Fotherby, L. M. and Jones, J. S., "The Influence of Exposed Footings on Pier Scour Depths." Hydraulic Engineering Conference, San Francisco, California, *Proc.* Vol. 2 (1993), pp. 922-927.
95. Fotherby, L. M. and Ruff, J. F., "Bridge Scour Protection System Using Toskanes-Phase I." Pennsylvania DOT, *Report 91-02* (1995).
96. Froehlich, D. C., "Analysis of Onsite Measurements of Scour at Piers." *Journal of Hydraulic Engineering*, ASCE, Vol. 114, (1988), pp. 534-539.
97. Froehlich, D. C., "Local Scour at Bridge Abutments." National Hydraulic Conference, Colorado Springs, CO, *Proc.* (1989), pp. 13-18.
98. Froehlich, D. C., "Local Scour at Bridge Piers Based on Field Measurements." U.S. Geological Survey, *Report USGS* (Undated).
99. Froehlich, D. C. and Benson, C. A., "Sizing Dumped Rock Riprap." University of Kentucky, *Report* (Undated).
100. Fukuoka, S., "Groins and Vanes Developed Based upon a New Concept of Bank Protection." Proc. National Conference on Hydraulic Engineering, ASCE, New Orleans (1989), 224-229.
101. Fukuoka, S., Tomita, K., et al., "Practical Numerical Simulation of Local Scour Around a Bridge." *Journal of Structural Mechanics and Earthquake Engineering*, Vol. 497, (1994), pp. 71-79.
102. Galay, V. J., "Causes of River Bed Degradation." *Water Resources Research*, Vol. 19, 5 (1983), pp. 1057-1090.
103. Galay, V. J., Yaremko, E. K., et al., "River Bed Scour and Construction of Stone Riprap Protection." *Sediment Transport Gravel-Bed Rivers*, John Wiley & Sons Ltd. (1987) pp. 353-383.
104. Gill, M. A., "Bed Erosion Around Obstructions in Rivers." *Ph.D. Thesis*, University of London, Imperial College of Science and Technology (1970), 192 p.
105. Gill, M. A., "Erosion of Sand Beds Around Spur Dikes." *Journal of the Hydraulics Division*, ASCE, Vol. 98, HY9 (1972), pp. 1587-1602.

106. Godbole, M. L. and Mehendale, P. B., "Scour Estimation and Protection for Roas Bridge Across Tapi River." *Alluvial River Problems, TIWAR89, Roojkee, India*, (1989), pp. 27-38.
107. Gomez, R. P., "Controlling Bridge Pier Scour by Rip-Rapping." *M.S. Thesis*, The University of Arizona (1987), 73 p.
108. Gorin, S. R. and Haeni, F. P., "Use of Surface-Geophysical Methods to Assess Riverbed Scour at Bridge Piers." U.S. Geological Survey, *Report USGS/88-4212* (1989).
109. Gosselin, M. S. and Sheppard, D. M., "Time Rate of Local Scour." ASCE Conference on Water Resources Engineering, San Antonio, Texas, *Proc.* (1995), pp. 5.
110. Gotz, A., "Protection contre les crues des cours d'eau." Department federal des transports, des communications et de l'energie, *Report* (1982).
111. Graziano, F., Jones, J. S., et al., "Design of riprap to protect bridge piers from local scour." *Public Roads*, Vol. 54, Sept. '90 (1990), pp. 193-9.
112. Guang, G. D., G., P. L., et al., "Pier Scour Equations Used in the People's Republic of China." Colorado State University, *Report* (1992).
113. Guniyakti, A., "Scour at Cylindrical Bridge Piers in Armored Beds." *Journal of the Hydraulics Division, ASCE*, Vol. 113, (1987), pp. 419-420.
114. Gupta, A. K. and Gangadharaiyah, T., "Local Scour Reduction by a Delta-Wing-Like Passive Device." VIII APD-IAHR Congress, Pune, India, *Proc.* (1992), pp. B471-B481.
115. Hadfield, A. C., "Sacrificial Piles as a Bridge Pier Scour Countermeasure." M.E. Thesis, University of Auckland, Auckland (1997).
116. Haeni, F. P. and Gorin, S. R., "Post-Flood Measurement of a Refilled Scour Hole at the Bulkeley Bridge in Hartford, Connecticut." U.S. Geological Survey, *Report USGS* (1989).
117. Hancu, S., "Sur le Calcul des Affouillements Locaux Dans la Zones Piles du Ponts." 14th IAHR Congress, Paris, France, *Proc.* Vol. 3 (1971).
118. Harwood, N. J., "Local Scour at a Bridge Pier Caused by Flood Waves." University of Canterbury, *Report 77-1* (1977).
119. Hayes, D. C. and Drummond, F. E., "Use of Fathometers and Electrical-Conductivity Probes to Monitor Riverbed Scour at Bridge Piers." U.S. Geological Survey, *Report USGS/94-4164* (1995).
120. Henderson, J. E. and Jr., S. F. D., "Environmental Features for Streambank Protection Projects." U. S. Army Corps of Engineers, *Report E-84-11* (1984).
121. Herbertson, J. G. and Ibrahim, A. A., "Interaction between Bridge Piers and Scour Protection Devices." International Conference on Protection and Development of the Nile and other Major Rivers, Cairo, Egypt, *Proc.* (1992).
122. Hertzberg, R., "Foreshore Protection, Lower Mississippi River." *Journal of the Waterways and Harbors Division*, Vol. 91, WW2 (1965), pp. 1-16.
123. Higuera, C. H. and Perez, G., "Bridge Scour: Analysis, Prevention and Rehabilitation." *Masters Thesis*, Universidad del Cauca (1989).
124. Hjorth, P., "Studies on the Nature of Local Scour." *Sweden Bulletin*, Lund Institute of Technology, Series A, No. 46 (1975), pp. 191.
125. Hoffmans, G. and Pilarczyk, K. W., "Local Scour Downstream of Hydraulic Structures." *Journal of Hydraulic Engineering, ASCE*, Vol. 121, 4 (1995), pp. 326-340.
126. Hooke, R. LeB., "Laboratory Study of the Influence of Granules on the Flow over a Sand Bed." Geological Society of America Bulletin, Vol. 79 (1968) pp. 495-500.

127. Hopkins, G. R., Vance, R. W., et al., "Scour around Bridge Piers." U.S. Department of Transportation, Federal Highway Administration, Offices of Research and Development, *Report FHWA-RD-79-103* (1980).
128. Hsieh, T., "Resistance of Cylindrical Piers in Open-Channel Flow." *Journal of the Hydraulics Division, ASCE*, Vol. 90, HY1 (1964), pp. 161-173.
129. Hudson, H. R., "A Field Technique to Directly Measure River Bank Erosion." *National Research Council of Canada*, (1982), pp. 381-383.
130. Imamoto, H. and K., O., "Local Scour around a Non-uniform Circular Cylinder." 22nd IAHR Congress, Lausanne, *Proc.* (1987), pp. 304-309.
131. (Indian Institution of Bridge Engineers), *National Round Table Conference on Design & Scour Depth for Foundation of Bridges.* (1993) 111 p.
132. Inglis, S. C., "Maximum Depth of Scour at Heads of Guide Banks and Groynes, Pier Noses, and Downstream of Bridges". *The Behavior and Control of Rivers and Canals*, (1949) pp. 327-348.
133. International Organization for Standardization, "Liquid Flow Measurement in Open Channels-Sampling and Analysis of Gravel-Bed Material." International Standard, *Report ISO 9195:1992(E)* (1992).
134. Isbash, S. V., "Construction of Dams by Dumping Stones in Flowing Water." (Translated by A. Dorijikow), US Army Engineer District, Eastport, ME., *Report* (1935).
135. Isbash, S. V., "Construction of Dams by Depositing Rock in Running Water." Transactions Second Congress on Large Dams, Washington D.C., *Proc.* Vol. U.S. Gov't Report No. 3 (1936).
136. Ishino, K., Fujita, I., et al., "The Surface Flow Structure of Large Scale Vortices at the rear of a Cylindrical Pier for the Flow of Transcritical Reynolds Number." *Journal of Hydraulic Engineering, JSCE*, (1995), pp. 785-792.
137. Jain, S. C., "Maximum Clear-Water Scour around Circular Piers." *Journal of Hydraulic Engineering, ASCE*, Vol. 107, 5 (1981), pp. 611-626.
138. Jain, S. C. and Fisher, E. E., "Scour around Circular Bridge Piers at High Froude Numbers." Iowa Institute of Hydraulic Research, The University of Iowa, *Report IIHR No.220* (1979).
139. Jia, Y. and Wang, S. S. Y., "3-D Numerical Simulation of Flow near a Spur Dike." First International Conference on Hydro-Science and Engineering, Washington D.C., *Proc.* Vol. 1 (1993), pp. 2150-2156.
140. Joglekar, D. V., "Manual on River Behaviour Control and Training." Central Board of Irrigation and Power, *Report 60* (1971).
141. Johnson, P. A., "Reliability-based Pier Scour Engineering." *Journal of Hydraulic Engineering, ASCE*, Vol. 118, 10 (1992), pp. 1344-1358.
142. Johnson, P. A., "Quantification of Bridge Pier Scour Uncertainty." *Machine Intelligence and Pattern Recognition*, Vol. 17, (1994), pp. 407.
143. Johnson, P. A. and Ayyub, B. M., "Assessing Time-Variant Bridge Reliability Due to Pier Scour." *Journal of Hydraulic Engineering, ASCE*, Vol. 118, 6 (1992), pp. 887-903.
144. Johnson, P. A. and Jones, J. S., "Shear Stress at Base of Bridge Pier". *Transportation Research Record No. 1350*, Washington, DC, Transportation Research Board. (1992) pp. 14-18.
145. Johnson, P. A. and Jones, J. S., "Merging Laboratory and Field Data in Bridge Scour." *Journal of Hydraulic Engineering, ASCE*, Vol. 119, 10 (1993), pp. 1176.
146. Johnson, P. A. and McCuen, R. H., "A Temporal, Spatial Pier Scour Model." *Transportation Research Record, Report 1319* (1991).



147. Johnson, P. A. and Simon, A., "Reliability of Bridge Foundations in Unstable Alluvial Channels." *Not yet published*, (1995).
148. Jones, J. S., "Comparison of Prediction Equations for Bridge Pier and Abutment Scour." Transportation Research Record 950: 2nd Bridge Engrg. Conf., Transportation Research Board, Washington D.C., *Proc.* Vol. 2 (1984).
149. Jones, J. S., Bertoldi, D. A., et al., "Alternative Scour Countermeasures." Hydraulic Engineering '95, San Antonio, TX, *Proc.* (1995a), p. 6.
150. Jones, J. S., Bertoldi, D. A., et al., "Alternatives to Riprap as a Scour Countermeasure." Fourth TRB Bridge Conference, San Francisco, CA, *Proc.* (1995b).
151. Jones, J. S., Kilgore, R. T., et al., "Effects of Footing Location on Bridge Pier Scour." *Journal of Hydraulic Engineering, ASCE*, Vol. 118, 2 (1992), pp. 280-290.
152. Kan, W. C., "Numerical Simulation of Water Flow around Bridge Piers." *Master Thesis*, National University of Taiwan (1987).
153. Kandasamy, J. K., "Local Scour at Skewed Abutments." School of Engineering, University of Auckland, New Zealand, *Report No. 375* (1985).
154. Karaki, S., "Laboratory Study of Spur Dikes for Highway Bridge Protection." Highway Research Board, *Report 286* (1961).
155. Karim, M., "Concrete Fabric Mat." *Highway Focus*, Vol. 7, (1975), pp. 16-23.
156. Keown, P. M., "Streambank Protection Guidelines." U.S. Army Engineer Waterways Experiment Station, Vicksburg, Mississippi, *Report* (1983).
157. Keutner, C., "The Flow Around Piers of Different Shapes and Its Effect on the River Bed." *Die Bautechnik*, Vol. 10, Hyd-19 (1932), pp. 161.
158. Khatsuria, R. M., "State of the Art on Computation, Prediction and Analysis of Scour in Rock Beds Downstream of Ski-Jump Spillways." Government of India, Ministry of Water Resources, *Report* (1992).
159. Kilgore, R. T., Bertoldi, D. A., et al., "An Experimental Study of Scour Protection Alternatives At Bridge Piers." Federal Highway Administration, Turner-Fairbank Laboratory, *Report* (1994).
160. Kirkby, M. J., "Measurement and Theory of Soil Creep." *Journal of Geology*, Vol. 75, (1967), pp. 359-378.
161. Klingeman, P. C., "Prediction of Pier Scour in Western Oregon." Federal Highway Administration, Region 8, Denver, Colorado, *Report* (1971).
162. Klingeman, P. C., "Hydrologic Evaluations in Bridge Pier Scour Design." *Journal of the Hydraulics Division, ASCE*, Vol. 99, HY12 (1973), pp. 2175-2184.
163. Koloseus, H. J., "Scour Due to Riprap and Improper Filters." *Journal of Hydraulic Engineering, ASCE*, Vol. 110, No. 10 (1984), pp. 1315-1324.
164. Korves, A. A. J., "Three Dimensional Flow Field Around Bridge Piers." *Master of Engineering Thesis*, University of Louisville (1994), 121 p.
165. Kothiyari, U. C., Garde, R. J., et al., "Temporal Variation of Scour Around Circular Bridge Piers." *Journal of Hydraulic Engineering, ASCE*, Vol. 118, 8 (1992), pp. 1091-1106.
166. Kothiyari, U. C., Garde, R. J., et al., "Maximum Scour Depth at Circular Bridge Piers in Clear-Water Flows." 6th Congress Asian and Pacific Regional Division, IAHR, Kyoto, Japan, *Proc.* (1988), pp. 39-45.

167. Kothyari, U. C., Garde, R. J., et al., "Estimation of Equilibrium Scour Depth Around Circular Bridge Pier." Third International Workshop on Alluvial River Problems, Roorkee, India, *Proc.* (1989), pp. 39-45.
168. Kron, W. and Plate, E., "Probability of Bridge Failure Due to Scouring." *Hydraulic Engineering '93, Proc.* (1993), pp. 2081-2086.
169. Krumdieck, A., "Flash Floods on Bridge Piers." International Association for Bridge and Structural Engineering, *Report P-106/87* (1987).
170. Lagasse, P. F., Schall, J. D., et al., "Stream Stability at Highway Structures." Federal Highway Administration (FHWA), *Report FHWA-IP-90-014 HEC 20* (1991).
171. Lauchlan, C. S., "Pier Scour Countermeasures." Ph.D. thesis, Dept. of Civil and Environmental Engineering, University of Auckland, New Zealand (1998).
172. Laursen, E. M., "Progress Report of Model Studies of Scour Around Bridge Piers and Abutments." Highway Research Board, *Report No. 13-B* (1951).
173. Laursen, E. M., "Scour at Bridge Crossings." Iowa Highway Research Board, Ames, IA., *Report 8* (1958).
174. Laursen, E. M., "Advancing Bridge Pier Scour Engineering. (comment on Peggy A. Johnson, Journal of Professional Issues in Engineering Education and Practice, vol. 117, January 1991)." *Journal of Professional Issues in Engineering Education and Practice*, Vol. 118, 2 (1992), pp. 216.
175. Laursen, E. M. and Toch, A., "Scour Around Bridge Piers and Abutments." Highway Research Board, *Report 4* (1956).
176. Lavagnino, S., "Gabions Guard River Banks Against 50,000 cfs Flow." *ASCE, Civil Engineering*, Vol. 44, 5 (1974), pp. 88-89.
177. Lee, L. H. Y. and Clark, J. A., "Flow Visualization in Complex Turbulent Flows." *Journal of the Hydraulics Division, ASCE*, Vol. 106, No. HY2 (1980), pp. 247-268.
178. Levi, E. and Luna, H., "Dispositifs pour Reduire l'affouillement au Pied des Piles de Pont." 9th IAHR Congress, Dubrovnik, *Proc.* (1961), pp. 1061-1069.
179. Lewis, G. L., "Riprap Protection of Bridge Footings." *Ph.D. Thesis*, Colorado State University, Fort Collins, Colorado (1972), 294 p.
180. Li, R. M., MacArthur, R., et al., "Sizing Riprap for the Protection of Approach Embankments & Spur Dikes and Limiting the Depth of Scour at Bridge Piers & Abutments." Arizona Department of Transportation, *Report FHWA-AZ89-260* (1989).
181. Lim, F.H., Chiew, Y.M., "Stability of Riprap Layers Under Live Bed Conditions." Proc. 1st International Conference on New/Emerging Concepts for Rivers. Rivertech '96, Chicago, Sept 22-26, (1996), pp 830-837
182. Lim, Foo Hoat and Chiew, Yee Meng, "Failure Behavior of a Riprap Layer around a Bridge Pier." Proceedings, Rivertech '96, First International Conference on New and Emerging Concepts for Rivers, September 22-26, Chicago (1996), pp. 830-837.
183. Lim, Foo Hoat and Chiew, Yee Meng, "Stability of Riprap Layer under Live Bed Conditions." Proceedings, 27th Congress, IAHR, Theme A, San Francisco (1997), San Francisco pp. 184-189.
184. Lim, Foo Hoat and Chiew, Yee Meng, "Degradation of Riprap Layer around Bridge Piers under Live-Bed Conditions." *Journal of Hydraulic Engineering, ASCE* (1998a) submitted.
185. Lim, Foo Hoat and Chiew, Yee Meng, "Failure Behavior of Riprap around Bridge Piers." *Journal of Hydraulic Engineering, ASCE* (1998b) submitted.

186. Limerinos, J. T., "Determination of the Manning Coefficient From Measured Bed Roughness in Natural Channels." U.S. Geological Survey, *Report USGS/Water-Supply Paper 1898-B* (1970).
187. Maccaferri Gabions, Inc., "Gabion and Reno Mattress Specifications," Maccaferri Gabions report, 10303 Governor Lane Blvd., Williamsport, MD 21795, USA, Jan. (1993).
188. Macky, G. H., "Model Testing of Bridge Abutment Scour Protection." Ministry of Works and Development, Central Laboratories, Lower Hutt, NZ, *Report No. 3-86/12* (1986).
189. Mahavadi, S. K., C., P. A., et al., "Pier Plates and Control of Local Scour." *Journal of Hydraulic Engineering, ASCE*, Vol. To be published, (1996).
190. Makowski, P. B., Thompson, P. L., et al., "Scour Assessment at Bridges." ASCE National Conference on Hydraulic Engineering, New Orleans, *Proc.* (1989).
191. Maynard, S. T., "Stable Riprap Size for Open Channel Flows." *Ph.D. Thesis*, Department of Civil Engineering, Colorado State University (1987), 115 p.
192. Maynard, S. T., "Toe Scour Protection Methods." *Hydraulic Engineering*, Buffalo, New York, *Proc.* Vol. 2 (1994), pp. 1035-1039.
193. Maynard, S. T., "Gabion-Mattress Channel-Protection Design." *Journal of Hydraulic Engineering, ASCE*, Vol. 121, 7 (1995), pp. 519-522.
194. Maza, J. A., "Scour in Natural Channels." University of Auckland, School of Engineering, *Report 114* (1967).
195. McClellan, A. K., "Process of Debris Accumulation on Bridge Piers." *M.Eng. Thesis*, University of Louisville (1994), 74 p.
196. McCorquodale, J. A., "Guide for Design and Placement of Cable Concrete Mats." The Manufacturers of Cable Concrete, *Report* (1994).
197. McCorquodale, J. A., Moawad, A., et al., "Cable-tied Concrete Block Erosion Protection." *Hydraulic Engineering '93*, San Francisco, CA., *Proc.* (1993), pp. 1367-1362.
198. Melville, B. W., "Local Scour at Bridge Sites." School of Engineering, University of Auckland, NZ, *Report No. 117* (1975).
199. Melville, B. W., "Live-bed Scour at Bridge Piers." *Journal of Hydraulic Engineering, ASCE*, Vol. 110, 09 (1984), pp. 1234-1247.
200. Melville, B. W., "Local Scour at Bridge Abutments." *Journal of Hydraulic Engineering, ASCE*, Vol. 118, 4 (1992), pp. 615-631.
201. Melville, B. W., Discussion of "Study of Time-dependent Local Scour Around Bridge Piers." by A. M. Yanmaz and H. D. Altinbilek, *Journal of Hydraulic Engineering, ASCE*, Vol. 118, 11 (1992), p. 1593.
202. Melville, B. W., Discussion of "Effects of Footing Location on Bridge Pier Scour." by J. Sterling Jones et al., *Journal of Hydraulic Engineering, ASCE*, Vol. 119, 2 (1993), p. 296.
203. Melville, B. W., "Pier and Abutment Scour: Integrated Approach." *Journal of Hydraulic Engineering, ASCE*, Vol. 123, No. 2 (1997) pp. 125-136.
204. Melville, B. W. and Dongol, D. M., "Bridge Pier Scour with Debris Accumulation." *Journal of Hydraulic Engineering, ASCE*, Vol. 118, 9 (1992), pp. 1306.
205. Melville, B. W. and Sutherland, A. J., "Design Method for Local Scour at Bridge Piers." *Journal of Hydraulic Engineering, ASCE*, Vol. 114, 10 (1988), pp. 1210-1226.
206. Miles, M., "Restoration Difficulties for Fishery Mitigation High-Energy Gravel-Bed Rivers Along Highway Corridors." *Gravel-Bed Rivers IV, Gravel-Bed Rivers in the Environment*, Gold Bar, Washington, *Proc.* Vol. August 20-26 (1995).

207. Meng, C. K., "Confluence and Pier Scour." University of Canterbury, NZ, *Report 86-16* (1986).
208. Moore, W. L. and Masch, F. D., "Influence of Secondary Flow on Local Scour at Obstructions in a Channel." Proceedings of the Federal Inter-Agency Sedimentation Conference, Washington, DC, *Proc. Vol. Paper No.36* (1963), pp. 314-319.
209. Mostafa, E. A., Yassir, A. A., et al., "Local Scour at Skewed Piers." 1993 Hydraulic Engineering Conference, ASCE, San Francisco, CA, *Proc. Vol. 121* (1993), pp. 1037-1042.
210. Mueller, D. S., Landers, M. N., et al., "Scour Measurements at Bridge Sites During the 1993 Upper Mississippi River Basin Flood." U.S. Geological Survey, *Report 950976* (1995).
211. Mueller, D. S., Miller, R. L., et al., "Historical and Potential Scour Around Bridge Piers and Abutments of Selected Stream Crossings in Indiana." U.S. Geological Survey, Water-Resources Investigations, *Report USGS-WRI/93-4066* (1994).
212. Neill, C. R., "Measurements of Bridge Scour and Bed Changes in a Flooding Sand-Bed River." Inst. of Civil Engineers, United Kingdom, *Proc. Vol. 30* (1965), pp. 415-436.
213. Neill, C. R., "Mean Velocity Criterion for Scour of Coarse Uniform Bed Material." 12th IAHR Congress, Ft. Collins, CO., *Proc. Vol. 3* (1967), pp. C6.1 - C6.9.
214. Neill, C. R., "Local Scour Around Bridge Piers." *Journal of the Hydraulics Division, ASCE*, Vol. 96, No. HY4 (1970a), pp. 1224-1227.
215. Neill, C. R., "River-Bed Scour. A Review for Bridge Engineers." Canadian Good Roads Association, Ottawa, *Report 23* (1970b).
216. Neill, C. R., *Guide to Bridge Hydraulics*. University of Toronto Press (1973) 191 p.
217. Neill, C. R., "Local Scour Around Piers." *Journal of Hydraulic Research*, Vol. 16, No.3 (1978), pp. 259-262.
218. Neill, C. R. and Morris, L. R., Scour Problems at Railway Bridges on the Thompson River, B.C., *Canadian Journal of Civil Engineering*, Vol. 7 (1980), pp. 357-372.
219. Neill, C. R., "Research vs Practice in Bridge Hydraulics." Workshop on Bridge Hydraulics and other aspects of stream crossing design, Banff, Alberta, Canada, *Proc.* (1983), pp. 419-431.
220. Neill, C. R., "Bridge Hydraulics: An Update Report." Northwest Hydraulics Consultants Limited, *Report* (1987).
221. Neill, C. R., "Controlling Mechanism of Local Scouring." The Royal Institute of Technology, *Report 10* (1990).
222. Neill, C. R. and Johnson, J. P., Discussion of "Assessing Time-variant Bridge Reliability due to Pier Scour." by P. A. Johnson and B. Ayyub, *Journal of Hydraulic Engineering, ASCE*, Vol 119, 7 (1993), p. 872.
223. Neill, C. R. and Morris, L. R., "Scour Problems at Railway Bridges on the Thompson River, B.C." *Canadian Journal of Civil Engineering*, Vol. 7, 2 (1980), pp. 357-372.
224. Nezu, I. and Rodi, W., Discussion of "Open-Channel Flow Measurements with a Laser Doppler Anemometer." by *Journal of Hydraulic Engineering, ASCE*, Vol. 112, 5 (1986), p. 335-355.
225. Nicollet, G. and Ramette, M., "Affouillements au Voisinage de Piles de Ponts Cylindriques Circulaires." 14th IAHR Congress, Paris, France, *Proc. Vol. 3* (1971), pp. 315-322.
226. Normann, J. M., "Design of Stable Channels with Flexible Linings." Federal Highway Administration, *Report HEC-15* (1975).
227. Novak, T. J., "Performance of Gabion Installations." New York State Department of Transportation, State Campus, Albany, New York, *Report* (1988) 100 pp.

228. Oberg, K. A. and Schmidt, A. R., "Measurements of Leakage from Lake Michigan Through Three Control Structures Near Chicago, Illinois, April-October 1993." U.S. Geological Survey, *Report USGS/94-4112* (1994).
229. Odgaard, A. J. and Kennedy, J. F., "River Bend Bank Protection by Submerged Vanes." *Journal of Hydraulic Engineering, ASCE*, Vol. 109, 8 (1983), pp. 1161-1173.
230. Odgaard, A.J., Lee, H.E. "Submerged Vanes for Flow Control and Bank Protection in Streams." IIHR Report No. 279, July (1984).
231. Odgaard, A. J. and Mosconi, C. E., "Streambank Protection by Submerged Vanes." *Journal of Hydraulic Engineering, ASCE*, Vol. 113, 4 (1987), pp. 520-536.
232. Odgaard, A. J. and Spoljaric, A., "Sediment Control by Submerged Vanes." *Journal of Hydraulic Engineering, ASCE*, Vol. 112, No. 12 (1986), pp. 1164-1181.
233. Odgaard, A. J. and Wang, Y., "Scour Prevention at Bridge Piers." *Proceedings Hydraulic Engineering, Proc.* (1987), pp. 523-527.
234. Odgaard, A.J., Wang, Y. "Sediment Control In Bridge Waterways." IIHR Report No.336, February (1990).
235. Odgaard, A. J. and Wang, Y., "Sediment Management with Submerged Vanes. I. Theory." *Journal of Hydraulic Engineering, ASCE*, Vol. 117, 3 (1991a), pp. 267-283.
236. Odgaard, A. J. and Wang, Y., "Sediment Management with Submerged Vanes. II. Applications." *Journal of Hydraulic Engineering, ASCE*, Vol. 117, 3 (1991b), pp. 284-302.
237. Oehler, W. G., "Keyed Riprap." Oregon Department of Transportation, *Report 31* (Undated).
238. Olpinski, K. and Christensen, C. J., "Slope Protection Along St. Lawrence Seaway Canals." *Canadian Geotechnical Journal*, Vol. 18, (1981), pp. 402-419.
239. Olsen, N. R. B. and Melaaen, M. C., "Three-dimensional calculation of scour around cylinders." *Journal of Hydraulic Engineering, ASCE*, Vol. 119, 9 (1993), pp. 1048-1054.
240. Pacific Southwest Inter-Agency Committee (PSIAC), "Selection and Evaluation of Measures for Reduction of Erosion and Sediment Yield." PSIAC, Water Management Subcommittee, *Report* (1968).
241. Pagan, J., "Stability of Rock Riprap for Protection at the Toe Abutments Located at the Floodplain." *M.S. Thesis*, The George Washington University (1990), 117 p.
242. Pagan-Ortiz, J. E., "Rock Riprap for Protection of Bridge Abutments Located at the Floodplain." Federal Highway Administration, *Report FHWA-RD-91-057* (1991).
243. Pagan-Ortiz, J. E., "Rock Riprap for Protection of Bridge Abutments Located at the Floodplain." *Public Roads*, Vol. 56, 1 (1992), pp. 23.
244. Paice and Hey, "The Control and Monitoring of Local Scour at Bridge Piers." Hydraulic Engineering Conference ASCE, San Francisco, California, *Proc.* (1993), pp. 1061-1066.
245. Parker, G., "Scour in Coarse-Bedded Streams." Alberta Department of the Environment, *Report RMD 80-34B* (1981).
246. Parker, G., "Modeling of Scour and Fill in the Minnesota River." Workshop on Bridge Hydraulics and other aspects of stream crossing design, Banff, Alberta, Canada, *Proc.* (1983), pp. 231-259.
247. Parker, G. and Andres, D., "Detrimental Effects of River Channelization." Symposium on Inland Waters for Navigation, Flood Control and Water Diversions, Colorado, *Proc.* (1976), pp. 1248-1266.
248. Parker, G., Paola, C., Whipple, K. X. and Mohrig, D., "Alluvial Fans Formed by Channelized Fluvial and Sheet Flow." *Journal of Hydraulic Engineering, ASCE* (1998) in press.

- 249.Parola, A. C. and Jones, S. D., "Sizing Riprap to Protect Bridge Piers from Scour." *Transportation Research Record*, 2-1290 (1991).
- 250.Parola, A. C., "The Stability of Riprap Used to Protect Bridge Piers." Federal Highway Administration, *Report FHWA-RD-91-063* (1991).
- 251.Parola, A. C., "Stability of Riprap at Bridge Piers." *Journal of Hydraulic Engineering, ASCE*, Vol. 119, 10 (1993), pp. 1080-1093.
- 252.Parola, A. C., "Boundary Stress and Stability of Riprap at Bridge Piers". *River, Coastal and Shoreline Protection*, John Wiley & Sons. (1995) pp. 149-159.
- 253.Parola, A. C. and Jones, J. S., "Riprap to Stabilize Existing Scour Around Bridge Piers: Preliminary Results." University of Louisville, *Report* (1988).
- 254.Parola, A. C. and Jones, J. S., "Sizing Riprap to Protect Bridge Piers from Scour." *Transportation Research Record*, Vol. 2, 1290 (1989), pp. 276.
- 255.Parola, A. C., Mahavadi, S. K., et al., "Effects of Rectangular Foundation Geometry on Local Pier Scour." University of Louisville, *Report* (1995).
- 256.Parola, A. C., Mahavadi, S. K., et al., "Effects of Rectangular Foundation Geometry on Local Pier Scour." *Journal of Hydraulic Engineering, ASCE*, Vol. 122, No.2 (1996).
- 257.Pemberton, E. L. and Lara, J. M., "Computing Degradation and Local Scour." Bureau of Reclamation, *Report PB84-222488* (1984).
- 258.(Peterson, M. S.), *River Engineering*. Prentice Hall (1986) 580 p.
- 259.Pierson, T. C., "Soil Pipes and Slope Stability." *Q. J. Eng. Geol. London*, Vol. 16, (1983), pp. 1-11.
- 260.Portland Cement Association, "Soil-Cement Slope Protection for Embankments: Planning and Design." *Report PCA, IS173.03W* (1991).
- 261.Posey, C. J., Scour at Bridge Piers, 2 - Protection of Threatened Piers, Civil Engineering, May, pp. 48-49, American Society of Civil Engineers, New York (1963).
- 262.Posey, C. J., "Tests of Scour Protection for Bridge Piers." *Journal of the Hydraulics Division, ASCE*, Vol. 100, No. HY12 (1974), pp. 1773-1783.
- 263.Posey, C. J., Appel, D. W., et al., "Investigation of Flexible Mats to Reduce Scour Around Bridge Piers." Highway Research Board, *Report 13-B* (1951).
- 264.(Prasad, K. and Bishnoi, A. S.), *Standard Specification and Code of Practice for Road Bridges*. The Indian Roads Congress (1973) 30 p.
- 265.(Prasad, K. and Bishnoi, A. S.), *Recommendations for Estimating the Resistance of Soil Below the Maximun Scour Level in the Design of Well Foundations of Bridges*. The Indian Roads Congress (1987) 30 p.
- 266.Przedwojski, B., "Bed Topography and Local Scour in Rivers with Banks Protected by Groynes." *Journal of Hydraulic Research*, Vol. 33, 2 (1995), pp. 257-273.
- 267.Qadar, A., "The Vortex Scour Mechanism at Bridge Piers." The Institution of Civil Engineers, London, England, *Proc.* Vol. 71, Part No. 2 (1981), pp. 739-757.
- 268.Quazi, M. E. and Peterson, A. W., "A Method for Bridge Pier Rip-rap Design." First Canadian Hydraulics Conference, Edmont, Canada, *Proc.* (1973), pp. 96-106.
- 269.Racin, J. A., "Gabion Mesh Corrosion Comparisons." California Department of Transportation, Sacramento, California, 94 p., *Report No. FHWA-CA-TL-91-04* (1991).
- 270.Racin, J. A., "Gabion Facilities Along the Pacific Coast Highway." California Department of Transportation, Sacramento, California, 60 pp., *Report No. FHWA-CA-TL-93-17* (1993).

271. Rantz, S. E., "Measurement and Computation of Streamflow: Volume 1. Measurement of Stage and Discharge." U.S. Department of the Interior, *Report 2175* (1982a).
272. Rantz, S. E., "Measurement and Computation of Streamflow: Volume 2. Computation of Discharge." U.S. Department of the Interior, *Report Geological Survey Water-Supply Paper No. 2175* (1982b).
273. Raudkivi, A. J., "Functional Trends of Scour at Bridge Piers." *Journal of Hydraulic Engineering, ASCE*, Vol. 112, No. 1 (1986), pp. 1-13.
274. Raudkivi, A. J., "Scour at Bridge Piers". *Scouring*, Rotterdam/Brookfield, A.A. Balkema. (1991) pp. 61-99.
275. Raudkivi, A. J. and Ettema, R., "Scour at Cylindrical Bridge Piers in Armored Beds." *Journal of Hydraulic Engineering, ASCE*, Vol. 111, Apr. '85 (1985), pp. 713-31.
276. (Raudkivi, A. J. and Sutherland, A. J.), *Scour at Bridge Crossings*. National Roads Board, Road Research Unit Bulletin No. 54 (1981) 100 p.
277. Resource Consultants & Engineers, "Hydraulic Stability of Tri-Lock 4010 Revetment in High Velocity Flow." American Excelsior Company, *Report 92-857* (1993).
278. Richards, N. A., "Review of Channel Stability Assessment Techniques, Pier Scour Equations and Countermeasures." Federal Highway Administration, *Report FHWA/CE 695BY* (1991).
279. Richardson, E. V., Harrison, L. J., et al., "Evaluating Scour at Bridges." U. S. Department of Transportation FHWA, *Report 18 (HEC-18) FHWA-IP-90-017* (1992).
280. Richardson, E. V. and Huber, F. W., "Evaluation of Bridge Vulnerability to Hydraulic Forces, Stream." *Transportation Research Record*, Vol. 1, 1290 (1990), pp. 25.
281. Richardson, E. V. and Lagasse, P. F., "Instrumentation for Measuring Scour at Bridge Piers and Abutments; Phase II." NCHRP, *Report No. 21-3* (1994).
282. Richardson, E. V. and Simon, D. B., "Spurs and Guide Banks." Engineering Research Center, Colorado State University, Fort Collins, Colorado, *Report* (1974).
283. Richardson, E. V., Simons, D. B., et al., "Highways in the River Environment." U.S. Department of Transportation, Federal Highway Administration, Washington, D.C., *Report No. FHWA-HI-90-016* (1990).
284. Richardson, J. R. and Richardson, E. V., "Countermeasures for Scour and Stream Instability at Bridges." *Transportation Research Record*, Vol. 2, 1.1290 (1990), pp. 268.
285. Rosenbaum, D. B., "Protecting Bridges From Floods." *Engineering News Record*, Vol. 230, 8 (1993), pp. 38.
286. Santoro, V. C., Julien, P. Y., et al., "Velocity Profiles and Scour Depth Measurements Around Bridge." *Transportation Research Record*, Vol. 1319, (1991), pp. 137-142.
287. Sanyal, T., "Laying of Geomattresses for Bed Protection in the River Hugli - A Case Study." *Geotextiles and Geomembranes*, Vol. 10, (1991), pp. 357-377.
288. Schuster, R. C., "Gabions in Highway Construction." Transportation Research Board, *Report 148* (1974).
289. Searcy, J. K., "Use of Riprap for Bank Protection." Bureau of Public Roads, Washington, *Report 11* (1967).
290. Shen, H. W., "Scour Near Piers". *River Mechanics*, (1971) pp. 23-1 - 23-25.
291. Shen, H. W., Schneider, V. R., et al., "Local Scour Around Bridge Piers." *Journal of the Hydraulics Division, ASCE*, Vol. 95, No. HY6 (1969), pp. 1919-1939.

292. Shen, H. W., Schneider, V. R., et al., "Mechanics of Local Scour." Engineering Research Center, Colorado State University, *Report No. CER66HWS22* (1966a).
293. Shen, H. W., Schneider, V. R., et al., "Mechanics of Local Scour Supplement: Methods of Reducing Scour." Engineering Research Center, Colorado State University, *Report No. CER66HWS36* (1966b).
294. Sheppard, D. M., Zhao, G., et al., "Local Scour Near Multiple Pile Piers in Steady Currents." ASCE Conference on Water Resources Engineering, San Antonio, Texas, *Proc.* (1995), pp. 5.
295. Silano, L. G. and Sela, E., "Environmental Controls Related to Bridge Rehabilitation". *Bridge Inspection and Rehabilitation. A Practical Guide*, New York, John Wiley & Sons Inc. (1992a) pp. 277-80.
296. Silano, L. G. and Sela, E., "Substructures". *Bridge Inspection and Rehabilitation. A Practical Guide*, New York, John Wiley & Sons Inc. (1992b) pp. 167-79.
297. Simon, A., "Methodologies to Identify and Analyze Channel-Stability Problems, and the Applicability of Mitigation Measures, Loess Area, Midwestern United States." Federal Highway Administration, *Report* (1995).
298. Simon, A. and Downs, P. W., "An Interdisciplinary Approach to Evaluation of Potential Instability in Alluvial Channels." University of Nottingham, *Report* (1995).
299. Simon, A. and Hupp, C. R., "Geomorphic and Vegetative Recovery Processes along Modified Stream Channels of West Tennessee." U. S. Geological Survey, Tennessee Department of Transportation, *Report 91-502* (1992).
300. Simons, D. B., Chen, Y. H., et al., "Hydraulic Test to Develop Design Criteria for the Use of Reno Mattresses." Civil Engineering Department - Engineering Research Center, Colorado State University, Fort Collins Colorado, *Report* (1984).
301. Skinner, J. V., "Measurement of Scour-Depth Near Bridge Piers." U.S. Geological Survey, *Report USGS/85-4106* (1986).
302. Son, K. and Urroz, G. E., "Local Scour Potential for Large Bed Material with Shallow Tailwater Depth." Hydraulic Engineering, Buffalo, New York, *Proc. Vol. 2* (1994), pp. 1146-1150.
303. Sousa-Pinto, N. L., "Rip-rap Protection Against Scour Around Bridge Piers." *M.S. Thesis*, University of Iowa, Iowa City (1959).
304. Southard, R. E., "Scour Around Bridge Piers on Streams in Arkansas." U.S. Geological Survey, *Report USGS/92-4126* (1992).
305. Stein, S., Young, K., et al., "Using Risk to Direct Bridge Foundation Scour Research Needs." Hydraulic Engineering '95, San Antonio, *Proc.* (1995), pp. 5.
306. Stevens, M. A., Gasser, M. M., et al., "Wake Vortex Scour at Bridge Piers." *Journal of Hydraulic Engineering, ASCE*, Vol. 117, 7 (1991), pp. 891-904.
307. Straub, L. G., "Dredge Fill Closure of Missouri River at Fort Randall." Minnesota Int'l. Hydraulics Conference, Minneapolis, MN, *Proc. Vol. September* (1953), pp. 61-75.
308. Sturm, T. W. and Janjua, S., "Clear-water Scour Around Abutments in Floodplains." *Journal of Hydraulic Engineering, ASCE*, Vol. 120, 8 (1994), pp. 956-972.
309. Susuki, K., Yamamoto, H., et al., "Conditions for Effective Protection Works by Stones or Gravel against Local Scour of Sand Bed." *Journal of Hydraulic Engineering, JSCE*, Vol. 39, 2 (1995), pp. 695-700.
310. Swamee, P. K., Discussion of "Bridge Pier Scour with Debris Accumulation." by Bruce W. Melville and D. M. Dongol, *Journal of Hydraulic Engineering, ASCE*, Vol. 120, 4 (1994), p. 522.



311. Tanaka, S. and Yano, M., "Local Scour around a Circular Cylinder." 12th IAHR Congress, Delft, The Netherlands, *Proc. Vol. 3* (1967), pp. 193-201.
312. Tey, C. B., "Local Scour at Bridge Abutments." School of Engineering, University of Auckland, NZ, *Report No. 329* (1984).
313. Thomas, Z., "An Interesting Hydraulic Effect Occurring at Local Scour." 12th IAHR Congress, Delft, The Netherlands, *Proc. Vol. 3* (1967), pp. 125-134.
314. Thorne, C. R., "Field Measurements of Rates of Bank Erosion and Bank Material Strength." Proceedings of the Florence Symposium, *Proc. Vol. Publication No. 133* (1981), pp. 503-512.
315. Tominaga, A., Fujiwara, K., et al., "Effects of Permeable and Non-Permeable Protection Works against Bridge Pier Scour and Their Influence on Local Flow Structure." *Journal of Hydraulic Engineering, JSCE*, Vol. 39, 2 (1995), pp. 677-685.
316. Torum, A. and Tesaker, E., "Local Scour and Scour Protection in Offshore Platforms and Pipelines." *Proc. Vol. 13* (1987), pp. 349-385.
317. Transportation Research Board, "Results of Laboratory Experiments on Riprap Sizing." Transportation Research Board, *Report* (1990).
318. Tsuchiya, Y. and Iwagaki, Y., "On the Mechanism of the Local Scour from Flows Downstream of an Outlet." 12th Hydraulic Conference, IAHR, Colorado State University, *Proc. Vol. C7* (1967), pp. 55.
319. Tsujimoto, T., "Local Scour around Bridge Pier and Migration of Dunes." 3rd Inter. Symp. River Sedimentation, *Proc.* (1986), pp. 1105-1113.
320. Tsujimoto, T. and Motohashi, K., "Effect of Armoring on Local Scour Around a Circular Cylinder." *Journal of Hydrosience and Hydraulic Engineering*, Vol. 6, 1 (1989), pp. 23-34.
321. Turk, G. F. and Melby, J. A., "Core-Loc(TM). A Major Development in Concrete Armor." *The REMR Bulletin*, Vol. 12, 1 (1995), pp. 1-5.
322. U.N. and Nations, U., "River Training and Bank Protection." U. N. Economic Commission for Asia and the Far East, *Report 1953, II. F.6* (1953).
323. (U.S. Army Corps of Engineers), *Shore Protection Manual*. U.S. Army Coastal Engineering Research Center (1977) p.
324. U.S. Army Corps of Engineers, "The Streambank Erosion Control Evaluation and Demonstration Act of 1974." U. S. Army Corps of Engineers, *Report* (1978).
325. U.S. Army Corps of Engineers, "Streambank Protection Guidelines." U.S. Army Engineer Waterways Experiment Station, Vicksburg, Mississippi, *Report* (1983).
326. U.S. Army Corps of Engineers, "Bank Protection, Master Specifications for Revetment Work." U. S. Army Corps of Engineers, *Report* (1987).
327. U.S. Army Corps of Engineers, "Scour and Deposition in Rivers and Reservoirs." U.S. Army Corps of Engineers, *Report* (1991a).
328. U.S. Army Corps of Engineers, "Wire Mesh Gabions." U.S. Army Corps of Engineers, *Report CW-02541* (1991b).
329. U.S. Army Corps of Engineers, "Hydraulic Design of Flood Control Channels," EM 1110-2-1601, Washington, D.C. (1991c)
330. U.S. Geological Survey, "Bridge Scour Symposium." Federal Highway Administration, *Report FHWA-RD-90-035* (1989).
331. U.S. Geological Survey, "Scour Around Bridge Piers on Streams in Arkansas." U.S. Geological Survey, *Report USGS/92-4126* (1992).

332. United Nations, "River Training and Bank Protection." U. N. Economic Commission for Asia and the Far East, *Report 1953, II. F.6* (1953).
333. Ushijima, S. and Tanaka, N., "Numerical Prediction Method for Local Scour with 3D Body-Fitted Coordinates." *Journal of Hydraulic Engineering, JSCE*, Vol. 39, 2 (1995), pp. 683-688.
334. Varzeliotis, A. N., "Model Studies of Scour Around Bridge Piers and Stone Aprons." *Master of Science Thesis*, The University of Alberta (1960), 159 p.
335. Verstappen, E. L., "Non-Steady Local Scour at a Cylindrical Pier." University of Canterbury, NZ, *Report Research Report No.78/5* (1978).
336. Vittal, N., Kothiyari, U. C., et al., "Clear-water scour around bridge pier group." *Journal of Hydraulic Engineering, ASCE*, Vol. 120, 11 (1994), pp. 1309-1319.
337. Wang, S.-Y. and Shen, H. W., "Incipient Sediment Motion and Riprap Design." *Journal of Hydraulic Engineering, ASCE*, Vol. 111, No. 3 (1985), pp. 520-538.
338. (Wang, S. S. Y.), *Advances in Hydro-Science and Engineering*. Center for Computational Hydroscience and Engineering (1993) 2174 p.
339. Wang, S. S. Y. and Li, J., "Computational Modeling and Hydroscience Research". *Advances in Hydro-Science and Engineering*, Beijing, China, Tsing Hua University. (1995) pp. 2147-2157.
340. Wang, T.-W. and Chang, S.-Z., "The Area of Scour Hole Around Bridge Piers." National Taiwan University, *Report* (1989).
341. Wang, T. W., "A Study of Pier Scouring and Scour Reduction." 9th Congress of the APD of the IAHR, Singapore, *Proc. Vol. 2* (1994), pp. 18-28.
342. White, J. and Dewey W., "Evaluation of Membrane-Type Materials for Streambank Erosion Protection." U.S. Army Engineer Waterways Experiment Station, *Report GL-81-4* (1981).
343. Williams, D. T. and Julien, P. Y., "On the Selection of Sediment Transport Equations." Hydraulic Engineering Conference, ASCE, *Proc.* (1981).
344. Worman, A., "Erosion Mechanisms in a Riprap Protection Around a Bridge Pier." Hydraulics Laboratory, Royal Institute of Technology, Stockholm, Sweden, *Report TRITA-VBI-136* (1987).
345. Worman, A., "Riprap Protection without Filter Layers." *Journal of Hydraulic Engineering, ASCE*, Vol. 115, 12 (1989), pp. 1615-1630.
346. Yanmaz, A. M. and Altmbilek, H. D., "Study of Time-Dependent Local Scour Around Bridge Piers." *Journal of Hydraulic Engineering, ASCE*, Vol. 117, 10 (1991), pp. 1247-1268.
347. Yee, M. C., "Scour Protection at Bridge Piers." *Journal of Hydraulic Engineering, ASCE*, Vol. 118, 9 (1992), pp. 1260-1269.
348. Yen, C. L. and Song, C. C. S., "Numerical Simulation of Flow and Scour Around Bridge Pier." National Taiwan University, *Report NSC 81-0410-E-002-608* (1993).

**APPENDIX A - DATA TABLES**



UNIVERSITY OF MINNESOTA												
Summary Data: SAFL Tilting Flume												
Series	Description	Run	Pier type	$T_p$ (hr)	$S_p$	$v_o$ (m)	U (m/s)	U/U <sub>o</sub>	d (m)	d/D	d/d <sub>o</sub>	
TF-NP1	No protection (1)	2	Circular	5.00	1.22E-03	0.100	0.536	3.068	0.100	0.987	0.991	n/a
"		"	Rectangular	5.00	1.22E-03	0.100	0.536	3.068	0.152	1.492	1.022	n/a
"		3	Circular	2.00	4.00E-03	0.150	0.860	4.925	0.102	1.008	0.912	n/a
"		"	Rectangular	2.00	4.00E-03	0.150	0.860	4.925	0.157	1.542	0.892	n/a
"		4a	Circular	0.75	4.00E-03	0.200	1.094	6.261	0.125	1.232	0.885	n/a
"		"	Rectangular	0.75	4.00E-03	0.200	1.094	6.261	0.151	1.484	0.745	n/a
"		4b	Circular	0.60	4.00E-03	0.200	1.094	6.261	0.147	1.442	1.036	n/a
"		"	Rectangular	0.60	4.00E-03	0.200	1.094	6.261	0.193	1.904	0.955	n/a
TF-NP2	No protection (2)	2	Circular	6.00	1.22E-03	0.112	0.478	2.736	0.102	1.005	1.009	n/a
"		"	Rectangular	6.00	1.22E-03	0.117	0.457	2.616	0.145	1.429	0.978	n/a
"		3	Circular	2.00	4.00E-03	0.195	0.661	3.783	0.122	1.203	1.088	n/a
"		"	Rectangular	2.00	4.00E-03	0.186	0.693	3.965	0.195	1.916	1.108	n/a
"		4	Circular	1.50	4.00E-03	0.257	0.850	4.865	0.136	1.342	0.964	n/a
"		"	Rectangular	1.50	4.00E-03	0.246	0.890	5.097	0.212	2.082	1.045	n/a
TF-RR1	Riprap no geotextile	2	Circular	8.00	1.22E-03	0.099	0.542	3.100	0.031	0.304	0.306	69%
"	(1) (original)	"	Rectangular	8.00	1.22E-03	0.102	0.523	2.994	0.036	0.350	0.240	76%
"		3a	Circular	2.00	4.00E-03	0.183	0.704	4.028	-0.004	-0.035	-0.032	100%
"		"	Rectangular	2.00	4.00E-03	0.180	0.719	4.114	0.104	1.023	0.591	41%
"		3b	Circular	2.00	4.00E-03	0.194	0.667	3.817	-0.017	-0.165	-0.149	100%
"		"	Rectangular	2.00	4.00E-03	0.190	0.679	3.889	-0.019	-0.190	-0.110	100%
"		3c	Circular	1.00	4.00E-03	0.177	0.728	4.165	-0.007	-0.066	-0.059	100%
"		"	Rectangular	1.00	4.00E-03	0.174	0.744	4.257	0.110	1.082	0.626	37%
"		3d	Circular	0.75	4.00E-03	0.179	0.720	4.121	0.001	0.005	0.005	100%
"		"	Rectangular	0.75	4.00E-03	0.175	0.737	4.217	0.108	1.066	0.616	38%
"		4a	Circular	0.75	4.00E-03	0.244	0.897	5.134	0.081	0.800	0.574	43%
"		"	Rectangular	0.75	4.00E-03	0.239	0.914	5.233	0.144	1.415	0.710	29%

UNIVERSITY OF MINNESOTA												
Summary Data: SAFL Tilting Flume												
Series	Description	Run	Pier type	$T_s$ (hr)	$S_w$	$y_s$ (m)	$U$ (m/s)	$U/U_c$	$d_s$ (m)	$d/D$	$d_s/d_c$	$r$
"		4b	Circular	0.50	4.00E-03	0.239	0.916	5.242	0.013	0.129	0.093	91%
"		"	Rectangular	0.50	4.00E-03	0.231	0.945	5.409	0.155	1.522	0.763	24%
"		4c	Circular	0.50	4.00E-03	0.236	0.927	5.305	0.028	0.277	0.199	80%
"		"	Rectangular	0.50	4.00E-03	0.227	0.964	5.521	0.156	1.538	0.771	23%
"		4d	Circular	0.50	4.00E-03	0.257	0.852	4.877	0.068	0.673	0.483	52%
"		"	Rectangular	0.50	4.00E-03	0.260	0.843	4.825	0.099	0.976	0.489	51%
TF-RR2	Riprap no geotextile	2	Circular	4.50	1.22E-03	0.124	0.433	2.481	-0.024	-0.239	-0.240	100%
"	(2) (original)	"	Rectangular	4.50	1.22E-03	0.144	0.371	2.125	-0.041	-0.403	-0.276	100%
"		3a	Circular	2.00	4.00E-03	0.188	0.687	3.931	-0.023	-0.230	-0.208	100%
"		"	Rectangular	2.00	4.00E-03	0.186	0.694	3.973	0.128	1.260	0.729	27%
"		3b	Circular	1.50	4.00E-03	0.189	0.684	3.917	-0.024	-0.236	-0.214	100%
"		"	Rectangular	1.50	4.00E-03	0.194	0.667	3.818	0.117	1.155	0.668	33%
"		3c	Circular	1.00	4.00E-03	0.187	0.689	3.946	-0.023	-0.223	-0.202	100%
"		"	Rectangular	1.00	4.00E-03	0.178	0.723	4.141	0.136	1.334	0.772	23%
"		4a	Circular	0.75	4.00E-03	0.248	0.882	5.048	0.065	0.638	0.459	54%
"		"	Rectangular	0.75	4.00E-03	0.242	0.904	5.173	0.175	1.718	0.862	14%
"		4b	Circular	0.50	4.00E-03	0.246	0.890	5.094	0.012	0.121	0.087	91%
"		"	Rectangular	0.50	4.00E-03	0.244	0.897	5.133	0.173	1.699	0.852	15%
"		4c	Circular	0.50	4.00E-03	0.250	0.874	5.002	0.063	0.616	0.443	56%
"		"	Rectangular	0.50	4.00E-03	0.240	0.911	5.214	0.161	1.586	0.796	20%
TF-RNG	Riprap no geotextile	2	Circular	2.50	1.22E-03	0.133	0.402	2.301	-0.025	-0.244	-0.245	100%
	(reconstituted)	"	Rectangular	2.50	1.22E-03	0.144	0.373	2.133	-0.025	-0.247	-0.169	100%
		3	Circular	1.00	4.00E-03	0.189	0.684	3.917	0.034	0.334	0.302	70%
		"	Rectangular	1.00	4.00E-03	0.196	0.659	3.774	0.109	1.073	0.621	38%
		4	Circular	0.75	4.00E-03	0.241	0.908	5.196	0.099	0.978	0.703	30%
		"	Rectangular	0.75	4.00E-03	0.240	0.910	5.209	0.143	1.404	0.704	30%
TF-RPG	Riprap partial	2	Circular	4.50	1.22E-03	0.116	0.462	2.647	0.022	0.218	0.218	78%
"	geotextile	"	Rectangular	4.50	1.22E-03	0.127	0.421	2.412	0.021	0.207	0.141	86%

UNIVERSITY OF MINNESOTA												
Summary Data: SAFL Tilting Flume												
Series	Description	Run	Pier type	$T_p$ (hr)	$S_w$	$y_p$ (m)	$U$ (m/s)	$U/U_c$	$d$ (m)	$d/D$	$d/d_c$	$\tau$
"		3a	Circular	1.00	4.00E-03	0.183	0.706	4.044	0.071	0.702	0.635	36%
"		"	Rectangular	1.00	4.00E-03	0.175	0.736	4.213	0.129	1.274	0.737	26%
"		3b	Circular	1.00	4.00E-03	0.197	0.655	3.747	0.031	0.309	0.280	72%
"		"	Rectangular	1.00	4.00E-03	0.192	0.671	3.844	0.011	0.108	0.063	94%
TF-CB	CT blocks no PG	2	Circular	6.00	1.22E-03	0.091	0.588	3.365	0.031	0.301	0.302	70%
"		"	Rectangular	6.00	1.22E-03	0.096	0.561	3.211	0.078	0.768	0.526	47%
"		3	Circular	2.00	4.00E-03	0.190	0.679	3.885	0.064	0.628	0.568	43%
"		"	Rectangular	2.00	4.00E-03	0.178	0.725	4.152	0.101	0.999	0.578	42%
"		4	Circular	0.75	4.00E-03	0.233	0.939	5.377	0.110	1.083	0.778	22%
"		"	Rectangular	0.75	4.00E-03	0.235	0.930	5.326	0.171	1.686	0.846	15%
TF-SP1	Sheet piles type 1	2	Circular	4.00	1.22E-03	0.112	0.480	2.747	0.070	0.684	0.687	31%
"		"	Rectangular	4.00	1.22E-03	0.117	0.458	2.619	0.095	0.931	0.637	36%
"		3	Circular	2.00	4.00E-03	0.192	0.673	3.852	0.075	0.737	0.667	33%
"		"	Rectangular	2.00	4.00E-03	0.191	0.677	3.874	0.127	1.248	0.722	28%
"		4	Circular	1.00	4.00E-03	0.246	0.888	5.081	0.116	1.137	0.817	18%
"		"	Rectangular	1.00	4.00E-03	0.242	0.904	5.175	0.177	1.744	0.875	13%
TF-SP2	Sheet piles type 2	3	Circular	1.00	4.00E-03	0.183	0.703	4.027	0.083	0.819	0.741	26%
"		"	Rectangular	1.00	4.00E-03	0.184	0.701	4.014	0.146	1.438	0.832	17%
TF-SP3	Sheet piles type 3	2	Circular	4.50	1.22E-03	0.104	0.518	2.964	0.060	0.590	0.592	41%
"		"	Rectangular	4.50	1.22E-03	0.109	0.490	2.806	0.102	1.007	0.690	31%
"		3	Circular	1.50	4.00E-03	0.194	0.665	3.805	0.060	0.589	0.533	47%
"		"	Rectangular	1.50	4.00E-03	0.195	0.663	3.797	0.103	1.010	0.584	42%
"		4	Circular	0.75	4.00E-03	0.241	0.909	5.203	0.077	0.756	0.543	46%
"		"	Rectangular	0.75	4.00E-03	0.241	0.908	5.199	0.158	1.555	0.780	22%
TF-PV1	Pier vanes type 1	2a	Circular	2.00	1.22E-03	0.109	0.493	2.824	0.093	0.914	0.918	8%
"		"	Rectangular	2.00	1.22E-03	0.116	0.460	2.635	0.095	0.937	0.642	36%
"		2b	Circular	2.00	1.22E-03	0.105	0.508	2.908	0.083	0.820	0.823	18%
"		"	Rectangular	2.00	1.22E-03	0.108	0.495	2.833	0.091	0.893	0.611	39%

UNIVERSITY OF MINNESOTA												
Summary Data: SAFL Tilting Flume												
Series	Description	Run	Pier type	$T_a$ (hr)	$S_w$	$y_c$ (m)	$U$ (m/s)	$U/U_c$	$d_s$ (m)	$d_s/D$	$d_s/d_{s0}$	
"		3	Circular	2.00	4.00E-03	0.186	0.693	3.967	0.106	1.042	0.942	6%
"		"	Rectangular	2.00	4.00E-03	0.190	0.679	3.886	0.153	1.504	0.870	13%
"		4	Circular	0.67	4.00E-03	0.245	0.894	5.115	0.085	0.841	0.604	40%
"		"	Rectangular	0.67	4.00E-03	0.238	0.919	5.262	0.156	1.533	0.769	23%
TF-PV2	Pier vanes type 2	2	Circular	2.00	1.22E-03	0.112	0.477	2.729	0.051	0.502	0.504	50%
"		"	Rectangular	2.00	1.22E-03	0.119	0.450	2.578	0.080	0.787	0.539	46%
"		3	Circular	1.00	4.00E-03	0.178	0.727	4.159	0.076	0.752	0.680	32%
"		"	Rectangular	1.00	4.00E-03	0.174	0.742	4.245	0.156	1.537	0.889	11%
"		4	Circular	0.50	4.00E-03	0.242	0.903	5.171	0.101	0.992	0.712	29%
"		"	Rectangular	0.50	4.00E-03	0.252	0.868	4.969	0.154	1.520	0.762	24%
TF-CMB	Riprap + sheet piles	3a	Circular	2.00	4.00E-03	0.187	0.690	3.948	0.016	0.158	0.143	86%
"		"	Rectangular	2.00	4.00E-03	0.185	0.699	4.004	0.019	0.184	0.106	89%
"		3b	Circular	1.50	4.00E-03	0.192	0.673	3.852	0.011	0.112	0.102	90%
"		"	Rectangular	1.50	4.00E-03	0.188	0.687	3.932	0.015	0.151	0.087	91%
"		4	Circular	0.50	4.00E-03	0.239	0.916	5.242	0.015	0.149	0.107	89%
"		"	Rectangular	0.50	4.00E-03	0.240	0.910	5.208	0.039	0.384	0.192	81%

Notes

PG = partial geotextile

CT = cable-tied

$r_s$  = fractional reduction in scour depth achieved by a countermeasure, expressed in percent

When  $d_s/d_{s0} < 0$  the % reduction in scour is always assigned to be 100



UNIVERSITY OF MINNESOTA												
Summary Data: SAFL Main Channel												
Series	Description	Run	Pier type	T <sub>0</sub> (hrs)	S <sub>w</sub>	y <sub>0</sub> (m)	U (m/s)	U/U <sub>0</sub>	d (m)	d/D	d/d <sub>0</sub>	r <sub>s</sub>
MC-NP0	No bridge piers	1	No pier	8.0	1.27E-03	0.150	0.453	2.232	n/a	n/a	n/a	n/a
"		2	No pier	8.0	2.03E-03	0.300	0.700	3.450	n/a	n/a	n/a	n/a
"		3	No pier	8.0	2.03E-03	0.450	1.027	5.063	n/a	n/a	n/a	n/a
"		4	No pier	8.0	3.05E-03	0.600	1.398	6.896	n/a	n/a	n/a	n/a
MC-NP1	No protection (1)	2	Circular	8.0	2.03E-03	0.354	0.593	2.926	0.218	0.715	1.121	n/a
"		"	Rectangular	8.0	2.03E-03	0.323	0.649	3.199	0.343	1.124	1.012	n/a
"		3	Circular	8.0	2.03E-03	0.482	0.958	4.725	0.343	1.126	1.225	n/a
"		"	Rectangular	8.0	2.03E-03	0.486	0.951	4.690	0.451	1.481	1.089	n/a
"		4	Circular	8.0	3.05E-03	0.677	1.240	6.114	0.435	1.426	1.165	n/a
"		"	Rectangular	8.0	3.05E-03	0.669	1.253	6.181	0.604	1.982	1.120	n/a
MC-NP2	No protection (2)	2	Circular	8.0	2.03E-03	0.414	0.507	2.502	0.171	0.560	0.879	n/a
"		"	Rectangular	8.0	2.03E-03	0.399	0.525	2.591	0.334	1.097	0.988	n/a
"		3	Circular	8.0	2.03E-03	0.595	0.776	3.827	0.217	0.713	0.775	n/a
"		"	Rectangular	8.0	2.03E-03	0.560	0.826	4.072	0.378	1.239	0.911	n/a
"		4	Circular	8.0	3.05E-03	0.787	1.066	5.257	0.311	1.022	0.835	n/a
"		"	Rectangular	8.0	3.05E-03	0.753	1.114	5.491	0.474	1.557	0.880	n/a
MC-RNG	Riprap no geotextile	2	Circular	8.0	2.03E-03	0.341	0.615	3.033	0.092	0.301	0.472	53%
"		"	Rectangular	8.0	2.03E-03	0.333	0.630	3.106	0.174	0.572	0.515	49%
"		3a	Circular	8.0	2.03E-03	0.506	0.913	4.501	0.078	0.256	0.278	72%
"		"	Rectangular	8.0	2.03E-03	0.493	0.937	4.619	0.311	1.019	0.750	25%
"		3b	Circular	8.0	2.03E-03	0.506	0.914	4.505	0.078	0.257	0.280	72%
"		"	Rectangular	8.0	2.03E-03	0.494	0.935	4.611	0.306	1.003	0.738	26%
"		4	Circular	8.0	3.05E-03	0.694	1.210	5.965	0.176	0.579	0.473	53%
"		"	Rectangular	8.0	3.05E-03	0.658	1.274	6.284	0.420	1.379	0.779	22%
MC-RPG	Riprap partial	1	Circular	8.0	1.27E-03	0.242	0.280	1.383	-0.071	-0.232	n/a	n/a
"	geotextile	"	Rectangular	8.0	1.27E-03	0.213	0.319	1.573	0.057	0.189	n/a	n/a
"		2	Circular	7.0	2.03E-03	0.389	0.540	2.663	-0.046	-0.150	-0.235	100%

UNIVERSITY OF MINNESOTA												
Summary Data: SAFL Main Channel												
Series	Description	Run	Pier type	T <sub>o</sub> (hrs)	S <sub>v</sub>	y <sub>o</sub> (m)	U (m/s)	U/U <sub>c</sub>	d <sub>o</sub> (m)	d <sub>o</sub> /D	d <sub>o</sub> /d <sub>o</sub>	τ <sub>o</sub>
"		"	Rectangular	7.0	2.03E-03	0.374	0.561	2.768	0.055	0.181	0.163	84%
"		3	Circular	11.0	2.03E-03	0.541	0.855	4.215	-0.033	-0.107	-0.116	100%
"		"	Rectangular	11.0	2.03E-03	0.533	0.867	4.278	0.074	0.244	0.179	82%
"		4	Circular	6.0	3.05E-03	0.754	1.113	5.488	0.192	0.631	0.515	48%
"		"	Rectangular	6.0	3.05E-03	0.727	1.154	5.689	0.419	1.376	0.777	22%
MC-RNX	Riprap no	2	Circular	8.5	2.03E-03	0.410	0.511	2.521	-0.068	-0.222	-0.348	100%
"	excavation	"	Rectangular	8.5	2.03E-03	0.383	0.548	2.701	0.021	0.067	0.061	94%
"		3	Circular	14.0	2.03E-03	0.583	0.793	3.911	0.027	0.089	0.096	90%
"		"	Rectangular	14.0	2.03E-03	0.549	0.842	4.152	0.117	0.383	0.281	72%
"		4	Circular	2.0	3.05E-03	0.794	1.056	5.209	0.210	0.690	0.564	44%
"		"	Rectangular	2.0	3.05E-03	0.756	1.110	5.476	0.391	1.283	0.725	27%
MC-RPL	Riprap placement	2	Rectangular	2.0	2.03E-03	0.395	0.531	2.620	0.034	0.112	0.101	90%
"		3	Rectangular	5.0	2.03E-03	0.547	0.844	4.163	0.060	0.195	0.144	86%
MC-CB1	100% CT blocks PG	1	Circular	15.0	1.27E-03	0.228	0.298	1.468	-0.057	-0.186	n/a	n/a
"		"	Rectangular	15.0	1.27E-03	0.229	0.297	1.465	0.042	0.137	n/a	n/a
"		2	Circular	12.0	2.03E-03	0.393	0.534	2.635	-0.050	-0.164	-0.257	100%
"		"	Rectangular	12.0	2.03E-03	0.366	0.573	2.825	0.114	0.373	0.336	66%
"		3	Circular	12.0	2.03E-03	0.561	0.823	4.058	0.010	0.033	0.036	96%
"		"	Rectangular	12.0	2.03E-03	0.519	0.889	4.386	0.164	0.537	0.395	61%
"		4	Circular	8.0	3.05E-03	0.768	1.092	5.384	0.000	0.000	0.000	100%
"		"	Rectangular	8.0	3.05E-03	0.732	1.146	5.653	0.186	0.611	0.345	65%
MC-CB2	80% CT blocks PG	3	Circular	7.0	2.03E-03	0.560	0.826	4.072	-0.013	-0.044	-0.048	100%
"		"	Rectangular	7.0	2.03E-03	0.495	0.934	4.606	0.290	0.951	0.700	30%
"		4	Circular	3.0	3.05E-03	0.712	1.178	5.808	0.081	0.267	0.218	78%
"		"	Rectangular	3.0	3.05E-03	0.657	1.276	6.295	0.286	0.939	0.530	47%
MC-CB3	50% CT blocks PG	2	Circular	4.0	2.03E-03	0.410	0.512	2.527	-0.016	-0.052	-0.081	100%
"		"	Rectangular	4.0	2.03E-03	0.399	0.526	2.595	0.005	0.016	0.015	99%
"		3	Circular	5.0	2.03E-03	0.551	0.839	4.137	0.046	0.151	0.164	84%

UNIVERSITY OF MINNESOTA													
Summary Data: SAFL Main Channel													
Series	Description	Run	Pier type	T <sub>c</sub> (hrs)	S <sub>c</sub>	y <sub>o</sub> (m)	U (m/s)	U/U <sub>c</sub>	d <sub>o</sub> (m)	d/D	d <sub>o</sub> /d <sub>so</sub>	r <sub>s</sub>	
"		"	Rectangular	5.0	2.03E-03	0.529	0.874	4.308	0.256	0.839	0.617	38%	
"		4	Circular	2.0	3.05E-03	0.756	1.110	5.473	0.012	0.040	0.033	97%	
"		"	Rectangular	2.0	3.05E-03	0.741	1.132	5.581	0.354	1.163	0.657	34%	
"		4b	Circular	1.0	3.05E-03	0.737	1.138	5.611	0.183	0.602	0.492	51%	
"		"	Rectangular	1.0	3.05E-03	0.722	1.162	5.732	0.374	1.227	0.694	31%	
MC-GB1	GB (parallel) PG	1	Circular	5.5	1.27E-03	0.254	0.267	1.316	-0.057	-0.188	n/a	n/a	
"		"	Rectangular	5.5	1.27E-03	0.249	0.273	1.346	-0.004	-0.012	n/a	n/a	
"		2	Circular	6.0	2.03E-03	0.403	0.521	2.569	-0.034	-0.113	-0.178	100%	
"		"	Rectangular	6.0	2.03E-03	0.376	0.558	2.753	0.028	0.091	0.082	92%	
"		3	Circular	17.0	2.03E-03	0.561	0.824	4.063	0.112	0.368	0.400	60%	
"		"	Rectangular	6.0	2.03E-03	0.519	0.889	4.386	0.278	0.912	0.671	33%	
"		4	Circular	8.5	3.05E-03	0.765	1.097	5.410	0.207	0.678	0.554	45%	
MC-GB2	GB (transverse) PG	3	Rectangular	2.0	2.03E-03	0.541	0.854	4.210	0.244	0.799	0.588	41%	
MC-GB3	GB (interlock) PG	3	Rectangular	6.0	2.03E-03	0.536	0.862	4.249	0.121	0.399	0.293	71%	
MC-GB4	Long GB (interlock) PG	3	Rectangular	3.0	2.03E-03	0.537	0.861	4.245	0.197	0.647	0.476	52%	
"		4	Rectangular	3.0	3.05E-03	0.707	1.187	5.856	0.326	1.069	0.604	40%	
MC-GB5	Long GB attached	3	Rectangular	0.5	2.03E-03	0.577	0.801	3.952	0.132	0.433	0.318	68%	
"	to PG	4	Rectangular	3.0	3.05E-03	0.735	1.141	5.627	0.361	1.183	0.668	33%	
MC-GB6	Long GB (attached	2	Rectangular	2.0	2.03E-03	0.435	0.482	2.379	-0.006	-0.019	-0.014	100%	
"	to sealed PG)	3	Rectangular	2.5	2.03E-03	0.587	0.787	3.879	-0.006	-0.019	-0.014	100%	
"		4	Rectangular	2.5	3.05E-03	0.746	1.125	5.545	0.388	1.272	0.719	28%	
MC-CMB	CT blocks and	2	Rectangular	6.0	2.03E-03	0.432	0.486	2.398	-0.002	-0.008	-0.007	100%	
"	riprap	3	Rectangular	6.0	2.03E-03	0.555	0.833	4.108	0.103	0.338	0.249	75%	
"		4	Rectangular	6.0	3.05E-03	0.781	1.074	5.298	0.035	0.116	0.066	93%	

Notes PG = partial geotextile GB = grout bags CT = cable-tied  
r<sub>s</sub> = fractional reduction in scour depth achieved by a countermeasure, expressed in percent  
When d<sub>o</sub>/d<sub>so</sub> < 0 the % reduction in scour is always assigned to be 100

UNIVERSITY OF AUCKLAND											
Basic Data for Riprap Studies with Circular Pier Part 1											
Run		Pier type	$T_d$ (hr)	$y_s$ (m)	$U_c$ (m/s)	$U$ (m/s)	$U/U_c$	$d_c$ (mm)	$d/D$	$d/d_c$	$\zeta$
NR1 (no riprap)		Crcular	24	200	0.415	0.262	0.631	80	1.143		
RR1a		Crcular	24	200	0.415	0.262	0.631	0	0.000	0.000	100.0%
RR2a		Crcular	24	200	0.415	0.262	0.631	0	0.000	0.000	100.0%
RR3a		Crcular	24	200	0.415	0.262	0.631	0	0.000	0.000	100.0%
NR2		Crcular	24	200	0.415	0.428	1.031	115	1.643		
RR4a		Crcular	24	200	0.415	0.428	1.031	13	0.186	0.113	88.7%
RR5a		Crcular	24	200	0.415	0.428	1.031	27	0.386	0.235	76.5%
RR6a		Crcular	24	200	0.415	0.428	1.031	12	0.171	0.104	89.6%
NR3		Crcular	24	200	0.415	0.520	1.253	141	2.014		
RR7a		Crcular	24	200	0.415	0.520	1.253	64	0.914	0.454	54.6%
RR7b		Crcular	24	200	0.415	0.520	1.253	47	0.671	0.333	66.7%
RR7c		Crcular	24	200	0.415	0.520	1.253	24	0.343	0.170	83.0%
NR4		Crcular	24	200	0.415	0.765	1.843	131	1.871		
RR8a		Crcular	24	200	0.415	0.765	1.843	131	1.871	1.000	0.0%
RR8b		Crcular	24	200	0.415	0.765	1.843	131	1.871	1.000	0.0%
NR5		Crcular	24	200	0.415	0.854	2.058	124	1.771		
RR9a		Crcular	24	200	0.415	0.854	2.058	124	1.771	1.000	0.0%
RR9b		Crcular	24	200	0.415	0.854	2.058	124	1.771	1.000	0.0%
RR10a		Crcular	24	200	0.415	0.765	1.843	57	0.814	0.435	56.5%
RR10b		Crcular	24	200	0.415	0.765	1.843	36	0.514	0.275	72.5%
RR10c		Crcular	24	200	0.415	0.765	1.843	19	0.271	0.145	85.5%
RR10d		Crcular	24	200	0.415	0.765	1.843	11	0.157	0.084	91.6%
RR11a		Crcular	24	200	0.415	0.854	2.058	68	0.971	0.548	45.2%
RR11b		Crcular	24	200	0.415	0.854	2.058	47	0.671	0.379	62.1%
RR11c		Crcular	24	200	0.415	0.854	2.058	22	0.314	0.177	82.3%
RR11d		Crcular	24	200	0.415	0.854	2.058	16	0.229	0.129	87.1%

UNIVERSITY OF AUCKLAND											
Basic Data for Riprap Studies with Circular Pier Part 1											
Run	Pier type	$T_p$ (hr)	$y_p$ (m)	$U_p$ (m/s)	$U$ (m/s)	$U/U_p$	$d_p$ (mm)	$d_p/D$	$d_p/d_c$	$R$	
NR6	Crcular	24	200	0.415	1.073	2.586	126	1.800			
RR12a	Crcular	24	200	0.415	1.073	2.586	75	1.071	0.595	40.5%	
RR12b	Crcular	24	200	0.415	1.073	2.586	40	0.571	0.317	68.3%	
RR12c	Crcular	24	200	0.415	1.073	2.586	29	0.414	0.230	77.0%	
RR12d	Crcular	24	200	0.415	1.073	2.586	15	0.214	0.119	88.1%	
NR7	Crcular	6	200	0.415	1.096	2.641	155	2.214			
RR13a	Crcular	6	200	0.415	1.096	2.641	90	1.286	0.581	41.9%	
RR13b	Crcular	6	200	0.415	1.096	2.641	50	0.714	0.323	67.7%	
RR13c	Crcular	6	200	0.415	1.096	2.641	32	0.457	0.206	79.4%	
RR13d	Crcular	6	200	0.415	1.096	2.641	15	0.214	0.097	90.3%	
NR8	Crcular	6	200	0.415	1.286	3.099	151	2.157			
RR14a	Crcular	6	200	0.415	1.286	3.099	95	1.357	0.629	37.1%	
RR14b	Crcular	6	200	0.415	1.286	3.099	68	0.971	0.450	55.0%	
RR14c	Crcular	6	200	0.415	1.286	3.099	52	0.743	0.344	65.6%	
RR14d	Crcular	6	200	0.415	1.286	3.099	35	0.500	0.232	76.8%	
RR15a	Crcular	6	200	0.415	1.286	3.099	72	1.029	0.477	52.3%	
RR15b	Crcular	6	200	0.415	1.286	3.099	30	0.429	0.199	80.1%	
RR15c	Crcular	6	200	0.415	1.286	3.099	25	0.357	0.166	83.4%	
RR15d	Crcular	6	200	0.415	1.286	3.099	14	0.200	0.093	90.7%	
RR16a	Crcular	24	200	0.415	1.073	2.586	50	0.714	0.397	60.3%	
RR16b	Crcular	24	200	0.415	1.073	2.586	53	0.757	0.421	57.9%	
RR16c	Crcular	24	200	0.415	1.073	2.586	20	0.286	0.159	84.1%	
RR16d	Crcular	24	200	0.415	1.073	2.586	0	0.000	0.000	100.0%	
RR17a	Crcular	24	200	0.415	0.765	1.843	54	0.771	0.412	58.8%	
RR17b	Crcular	24	200	0.415	0.765	1.843	28	0.400	0.214	78.6%	
RR17c	Crcular	24	200	0.415	0.765	1.843	13	0.186	0.099	90.1%	
RR17d	Crcular	24	200	0.415	0.765	1.843	0	0.000	0.000	100.0%	
RR18a	Crcular	6	200	0.415	1.286	3.099	4	0.057	0.026	97.4%	

UNIVERSITY OF AUCKLAND											
Basic Data for Riprap Studies with Circular Pier Part 1											
Run		Pier type	$T_o$ (hr)	$y_o$ (m)	$U_o$ (m/s)	$U$ (m/s)	$U/U_o$	$d_o$ (mm)	$d_o/D$	$d/D$	
RR18b		Crcular	6	200	0.415	1.286	3.099	0	0.000	0.000	100.0%
RR18c		Crcular	6	200	0.415	1.286	3.099	0	0.000	0.000	100.0%
RR18d		Crcular	6	200	0.415	1.286	3.099	0	0.000	0.000	100.0%
RR19a		Crcular	6	200	0.415	1.286	3.099	47	0.671	0.311	68.9%
RR19b		Crcular	6	200	0.415	1.286	3.099	35	0.500	0.232	76.8%
RR19c		Crcular	6	200	0.415	1.286	3.099	4	0.057	0.026	97.4%
RR19d		Crcular	6	200	0.415	1.286	3.099	1	0.014	0.007	99.3%
RR20a		Crcular	6	200	0.415	1.096	2.641	39	0.557	0.252	74.8%
RR20b		Crcular	6	200	0.415	1.096	2.641	38	0.543	0.245	75.5%
RR20c		Crcular	6	200	0.415	1.096	2.641	0	0.000	0.000	100.0%
RR20d		Crcular	6	200	0.415	1.096	2.641	0	0.000	0.000	100.0%
RR21a		Crcular	24	200	0.415	1.073	2.586	34	0.486	0.270	73.0%
RR21b		Crcular	24	200	0.415	1.073	2.586	16	0.229	0.127	87.3%
RR21c		Crcular	24	200	0.415	1.073	2.586	0	0.000	0.000	100.0%
RR21d		Crcular	24	200	0.415	1.073	2.586	0	0.000	0.000	100.0%
RR22a		Crcular	24	200	0.415	0.765	1.843	12	0.171	0.092	90.8%
RR22b		Crcular	24	200	0.415	0.765	1.843	0	0.000	0.000	100.0%
RR22c		Crcular	24	200	0.415	0.765	1.843	0	0.000	0.000	100.0%
RR22d		Crcular	24	200	0.415	0.765	1.843	0	0.000	0.000	100.0%
NR9		Crcular	24	600	0.415	0.700	1.687	273	1.365		
RR23a		Crcular	24	600	0.415	0.700	1.687	11	0.055	0.040	96.0%
RR23c		Crcular	24	600	0.415	0.700	1.687	5	0.025	0.018	98.2%
RR24a		Crcular	24	600	0.415	0.700	1.687	0	0.000	0.000	100.0%
NR10		Crcular	24	600	0.415	0.870	2.096	309	1.545		
RR25a		Crcular	24	600	0.415	0.870	2.096	80	0.400	0.259	74.1%
RR26a		Crcular	24	600	0.415	0.870	2.096	40	0.200	0.129	87.1%
NR11		Crcular	24	600	0.415	1.071	2.581	314	1.570		
RR27a		Crcular	24	600	0.415	1.071	2.581	110	0.550	0.350	65.0%

UNIVERSITY OF AUCKLAND											
Basic Data for Riprap Studies with Circular Pier Part 1											
Run	Pier type	$T_p$ (hr)	$y_p$ (m)	$U_c$ (m/s)	$U$ (m/s)	$U/U_c$	$d$ (mm)	$d/D$	$d/d_c$		
						2.581	70	0.350	0.223	77.7%	
RR28a	Crcular	24	600	0.415	1.071	2.581	70	0.350	0.223	77.7%	
RRt1a	Crcular	24	200	0.415	0.765	1.843	20	0.286	0.153	84.7%	
RRt1c	Crcular	24	200	0.415	0.765	1.843	69	0.986	0.527	47.3%	
RRt2a	Crcular	24	200	0.415	0.765	1.843	4	0.057	0.031	96.9%	
RRt2c	Crcular	24	200	0.415	0.765	1.843	59	0.843	0.450	55.0%	
RRt3a	Crcular	24	200	0.415	0.765	1.843	6	0.086	0.046	95.4%	
RRt3c	Crcular	24	200	0.415	0.765	1.843	75	1.071	0.573	42.7%	
RRt4a	Crcular	24	200	0.415	0.765	1.843	0	0.000	0.000	100.0%	
RRt4c	Crcular	24	200	0.415	0.765	1.843	49	0.700	0.374	62.6%	
RRt5a	Crcular	24	200	0.415	1.073	2.586	63	0.900	0.500	50.0%	
RRt5c	Crcular	24	200	0.415	1.073	2.586	100	1.429	0.794	20.6%	
RRt6a	Crcular	24	200	0.415	1.073	2.586	31	0.443	0.246	75.4%	
RRt6c	Crcular	24	200	0.415	1.073	2.586	75	1.071	0.595	40.5%	
RRt7a	Crcular	24	200	0.415	1.073	2.586	21	0.300	0.167	83.3%	
RRt7b	Crcular	24	200	0.415	1.073	2.586	73	1.043	0.579	42.1%	
RRt8a	Crcular	24	200	0.415	1.073	2.586	18	0.257	0.143	85.7%	
RRt8c	Crcular	24	200	0.415	1.073	2.586	53	0.757	0.421	57.9%	
RRt9a	Crcular	24	200	0.415	1.286	3.099	71	1.014	0.470	53.0%	
RRt9c	Crcular	24	200	0.415	1.286	3.099	107	1.529	0.709	29.1%	
RRt10a	Crcular	24	200	0.415	1.286	3.099	33	0.471	0.219	78.1%	
RRt10c	Crcular	24	200	0.415	1.286	3.099	100	1.429	0.662	33.8%	
RRt11a	Crcular	24	200	0.415	1.286	3.099	36	0.514	0.238	76.2%	
RRt11c	Crcular	24	200	0.415	1.286	3.099	93	1.329	0.616	38.4%	
RRt12a	Crcular	24	200	0.415	1.286	3.099	34	0.486	0.225	77.5%	
RRt12c	Crcular	24	200	0.415	1.286	3.099	63	0.900	0.417	58.3%	
NR12	Crcular	24	140	0.415	1.189	2.865	132	1.886			
RRy1	Crcular	24	140	0.415	1.189	2.865	50	0.714	0.379	62.1%	
NR13	Crcular	24	140	0.415	1.046	2.520	117	1.671			



UNIVERSITY OF AUCKLAND											
Basic Data for Riprap Studies with Circular Pier Part 1											
Run	Pier type	$T_p$ (hr)	$y_p$ (m)	$U_p$ (m/s)	$U$ (m/s)	$U/U_p$	$d_p$ (mm)	$d/D$	$d/d_p$		
RRy2	Crcular	24	140	0.415	1.046	2.520	47	0.671	0.402	59.8%	
NR14	Crcular	24	140	0.415	0.932	2.246	113	1.614			
RRy3	Crcular	24	140	0.415	0.932	2.246	29	0.414	0.257	74.3%	
NR15	Crcular	24	140	0.415	0.724	1.745	93	1.329			
RRy4	Crcular	24	140	0.415	0.724	1.745	17	0.243	0.183	81.7%	
RRy5	Crcular	24	140	0.415	0.724	1.745	23	0.329	0.247	75.3%	
RRy6	Crcular	24	140	0.415	0.932	2.246	43	0.614	0.381	61.9%	
RRy7	Crcular	24	140	0.415	1.046	2.520	64	0.914	0.547	45.3%	
RRy8	Crcular	24	140	0.415	1.189	2.865	73	1.043	0.553	44.7%	



UNIVERSITY OF AUCKLAND											
Basic Data for Riprap Studies with Circular Pier Part 2											
Run	c (mm)	t (mm)	Y (mm)	D (mm)	D <sub>50</sub> (mm)	y/D	t/D <sub>50</sub>	c/D	U <sub>c</sub> (m/s)	U/U <sub>c</sub>	U/U <sub>c</sub>
NR1 (no riprap)				70						0.631	
RR1a	280	32	0	70	16	2.857	2.00	4.00	1.42	0.631	0.185
RR2a	280	16	0	70	7.8	2.857	2.05	4.00	1.14	0.631	0.230
RR3a	280	44	0	70	22	2.857	2.00	4.00	1.54	0.631	0.170
NR2				70						1.031	
RR4a	280	32	0	70	16	2.857	2.00	4.00	1.42	1.031	0.301
RR5a	280	16	0	70	7.8	2.857	2.05	4.00	1.14	1.031	0.375
RR6a	280	44	0	70	22	2.857	2.00	4.00	1.54	1.031	0.278
NR3				70						1.253	
RR7a	280	16	0	70	7.8	2.857	2.05	4.00	1.14	1.253	0.456
RR7b	280	16	20	70	7.8	2.857	2.05	4.00	1.14	1.253	0.456
RR7c	280	16	40	70	7.8	2.857	2.05	4.00	1.14	1.253	0.456
NR4				70						1.843	
RR8a	280	16	0	70	7.8	2.857	2.05	4.00	1.14	1.843	0.671
RR8b	280	16	20	70	7.8	2.857	2.05	4.00	1.14	1.843	0.671
NR5				70						2.058	
RR9a	280	16	0	70	7.8	2.857	2.05	4.00	1.14	2.058	0.749
RR9b	280	16	20	70	7.8	2.857	2.05	4.00	1.14	2.058	0.749
RR10a	280	32	0	70	16	2.857	2.00	4.00	1.42	1.843	0.539
RR10b	280	32	20	70	16	2.857	2.00	4.00	1.42	1.843	0.539
RR10c	280	32	40	70	16	2.857	2.00	4.00	1.42	1.843	0.539
RR10d	280	32	60	70	16	2.857	2.00	4.00	1.42	1.843	0.539
RR11a	280	32	0	70	16	2.857	2.00	4.00	1.42	2.058	0.601
RR11b	280	32	20	70	16	2.857	2.00	4.00	1.42	2.058	0.601
RR11c	280	32	40	70	16	2.857	2.00	4.00	1.42	2.058	0.601

UNIVERSITY OF AUCKLAND											
Basic Data for Riprap Studies with Circular Pier Part 2											
Run	c (mm)	t (mm)	Y (mm)	D (mm)	D <sub>50</sub> (mm)	y <sub>c</sub> /D	t/D <sub>50</sub>	c/D	U <sub>c</sub> (m/s)	U/U <sub>c</sub>	U/U <sub>c</sub>
RR11d	280	32	60	70	16	2.857	2.00	4.00	1.42	2.058	0.601
NR6				70						2.586	
RR12a	280	32	0	70	16	2.857	2.00	4.00	1.42	2.586	0.756
RR12b	280	32	20	70	16	2.857	2.00	4.00	1.42	2.586	0.756
RR12c	280	32	40	70	16	2.857	2.00	4.00	1.42	2.586	0.756
RR12d	280	32	60	70	16	2.857	2.00	4.00	1.42	2.586	0.756
NR7				70						2.641	
RR13a	280	32	0	70	16	2.857	2.00	4.00	1.42	2.641	0.772
RR13b	280	32	20	70	16	2.857	2.00	4.00	1.42	2.641	0.772
RR13c	280	32	40	70	16	2.857	2.00	4.00	1.42	2.641	0.772
RR13d	280	32	60	70	16	2.857	2.00	4.00	1.42	2.641	0.772
NR8				70						3.099	
RR14a	280	32	0	70	16	2.857	2.00	4.00	1.42	3.099	0.906
RR14b	280	32	20	70	16	2.857	2.00	4.00	1.42	3.099	0.906
RR14c	280	32	40	70	16	2.857	2.00	4.00	1.42	3.099	0.906
RR14d	280	32	60	70	16	2.857	2.00	4.00	1.42	3.099	0.906
RR15a	280	44	0	70	22	2.857	2.00	4.00	1.54	3.099	0.835
RR15b	280	44	20	70	22	2.857	2.00	4.00	1.54	3.099	0.835
RR15c	280	44	40	70	22	2.857	2.00	4.00	1.54	3.099	0.835
RR15d	280	44	60	70	22	2.857	2.00	4.00	1.54	3.099	0.835
RR16a	280	44	0	70	22	2.857	2.00	4.00	1.54	2.586	0.697
RR16b	280	44	20	70	22	2.857	2.00	4.00	1.54	2.586	0.697
RR16c	280	44	40	70	22	2.857	2.00	4.00	1.54	2.586	0.697
RR16d	280	44	60	70	22	2.857	2.00	4.00	1.54	2.586	0.697
RR17a	280	44	0	70	22	2.857	2.00	4.00	1.54	1.843	0.497
RR17b	280	44	20	70	22	2.857	2.00	4.00	1.54	1.843	0.497
RR17c	280	44	40	70	22	2.857	2.00	4.00	1.54	1.843	0.497
RR17d	280	44	60	70	22	2.857	2.00	4.00	1.54	1.843	0.497

UNIVERSITY OF AUCKLAND											
Basic Data for Riprap Studies with Circular Pier Part 2											
Run	c (mm)	L (mm)	Y (mm)	D (mm)	D <sub>50</sub> (mm)	v <sub>0</sub> /D	U/D <sub>50</sub>	g/D	U <sub>c</sub> (m/s)	U/U <sub>c</sub>	U/U <sub>c</sub>
RR18a	280	100	0	70	50	2.857	2.00	4.00	1.81	3.099	0.710
RR18b	280	100	20	70	50	2.857	2.00	4.00	1.81	3.099	0.710
RR18c	280	100	40	70	50	2.857	2.00	4.00	1.81	3.099	0.710
RR18d	280	100	60	70	50	2.857	2.00	4.00	1.69	3.099	0.761
RR19a	280	70	0	70	35	2.857	2.00	4.00	1.69	3.099	0.761
RR19b	280	70	20	70	35	2.857	2.00	4.00	1.69	3.099	0.761
RR19c	280	70	40	70	35	2.857	2.00	4.00	1.69	3.099	0.761
RR19d	280	70	60	70	35	2.857	2.00	4.00	1.69	2.641	0.649
RR20a	280	70	0	70	35	2.857	2.00	4.00	1.69	2.641	0.649
RR20b	280	70	20	70	35	2.857	2.00	4.00	1.69	2.641	0.649
RR20c	280	70	40	70	35	2.857	2.00	4.00	1.69	2.641	0.649
RR20d	280	70	60	70	35	2.857	2.00	4.00	1.69	2.586	0.635
RR21a	280	70	0	70	35	2.857	2.00	4.00	1.69	2.586	0.635
RR21b	280	70	20	70	35	2.857	2.00	4.00	1.69	2.586	0.635
RR21c	280	70	40	70	35	2.857	2.00	4.00	1.69	2.586	0.635
RR21d	280	70	60	70	35	2.857	2.00	4.00	1.69	1.843	0.453
RR22a	280	70	0	70	35	2.857	2.00	4.00	1.69	1.843	0.453
RR22b	280	70	2	70	35	2.857	2.00	4.00	1.69	1.843	0.453
RR22c	280	70	40	70	35	2.857	2.00	4.00	1.69	1.843	0.453
RR22d	280	70	60	70	35	2.857	2.00	4.00	1.69	1.843	0.453
NR9				200						1.687	
RR23a	800	100	0	200	50	3.000	2.00	4.00	2.45	1.687	0.286
RR23c	800	100	40	200	50	3.000	2.00	4.00	2.45	1.687	0.286
RR24a	800	122	0	200	66	3.000	1.85	4.00	2.62	1.687	0.267
NR10				200						2.096	
RR25a	800	100	0	200	50	3.000	2.00	4.00	2.45	2.096	0.355
RR26a	800	122	0	200	66	3.000	1.85	4.00	2.62	2.096	0.332
NR11				200						2.581	

UNIVERSITY OF AUCKLAND											
Basic Data for Riprap Studies with Circular Pier Part 2											
Run	c (mm)	t (mm)	Y (mm)	D (mm)	D <sub>50</sub> (mm)	y <sub>c</sub> /D	t/D <sub>50</sub>	c/D	U <sub>c</sub> (m/s)	U/U <sub>c</sub>	U/U <sub>c</sub>
RR27a	800	100	0	200	50	3.000	2.00	4.00	2.45	2.581	0.437
RR28a	800	122	0	200	66	3.000	1.85	4.00	2.62	2.581	0.409
RRt1a	280	48	0	70	16	2.857	3.00	4.00	1.42	1.843	0.539
RRt1c	280	16	0	70	16	2.857	1.00	4.00	1.42	1.843	0.539
RRt2a	280	48	20	70	16	2.857	3.00	4.00	1.42	1.843	0.539
RRt2c	280	16	20	70	16	2.857	1.00	4.00	1.42	1.843	0.539
RRt3a	280	66	0	70	22	2.857	3.00	4.00	1.54	1.843	0.497
RRt3c	280	22	0	70	22	2.857	1.00	4.00	1.54	1.843	0.497
RRt4a	280	66	20	70	22	2.857	3.00	4.00	1.54	1.843	0.497
RRt4c	280	22	20	70	22	2.857	1.00	4.00	1.54	1.843	0.497
RRt5a	280	48	0	70	16	2.857	3.00	4.00	1.42	2.586	0.756
RRt5c	280	16	0	70	16	2.857	1.00	4.00	1.42	2.586	0.756
RRt6a	280	48	20	70	16	2.857	3.00	4.00	1.42	2.586	0.756
RRt6c	280	16	20	70	16	2.857	1.00	4.00	1.42	2.586	0.756
RRt7a	280	66	0	70	22	2.857	3.00	4.00	1.54	2.586	0.697
RRt7b	280	22	0	70	22	2.857	1.00	4.00	1.54	2.586	0.697
RRt8a	280	66	20	70	22	2.857	3.00	4.00	1.54	2.586	0.697
RRt8c	280	22	20	70	22	2.857	1.00	4.00	1.54	2.586	0.697
RRt9a	280	48	0	70	16	2.857	3.00	4.00	1.42	3.099	0.906
RRt9c	280	16	0	70	16	2.857	1.00	4.00	1.42	3.099	0.906
RRt10a	280	48	20	70	16	2.857	3.00	4.00	1.42	3.099	0.906
RRt10c	280	16	20	70	16	2.857	1.00	4.00	1.42	3.099	0.906
RRt11a	280	66	0	70	22	2.857	3.00	4.00	1.54	3.099	0.835
RRt11c	280	22	0	70	22	2.857	1.00	4.00	1.54	3.099	0.835
RRt12a	280	66	20	70	22	2.857	3.00	4.00	1.54	3.099	0.835
RRt12c	280	22	20	70	22	2.857	1.00	4.00	1.54	3.099	0.835
NR12				70						2.865	
RRy1	280	44	0	70	22	2.000	2.00	4.00	1.40	2.865	0.849

UNIVERSITY OF AUCKLAND											
Basic Data for Riprap Studies with Circular Pier Part 2											
Run	c (mm)	t (mm)	Y (mm)	D (mm)	D <sub>50</sub> (mm)	v <sub>50</sub> /D	U/D <sub>50</sub>	c/D	U <sub>50</sub> (m/s)	U/U <sub>50</sub>	U/U <sub>50</sub>
NR13				70						2.520	
RRy2	280	44	0	70	22	2.000	2.00	4.00	1.40	2.520	0.747
NR14				70						2.246	
RRy3	280	44	0	70	22	2.000	2.00	4.00	1.40	2.246	0.666
NR15				70						1.745	
RRy4	280	44	0	70	22	2.000	2.00	4.00	1.40	1.745	0.517
RRy5	280	32	0	70	16	2.000	2.00	4.00	1.30	1.745	0.557
RRy6	280	32	0	70	16	2.000	2.00	4.00	1.30	2.246	0.717
RRy7	280	32	0	70	16	2.000	2.00	4.00	1.30	2.520	0.805
RRy8	280	32	0	70	16	2.000	2.00	4.00	1.30	2.865	0.915

UNIVERSITY OF AUCKLAND										
Basic Data for Riprap Studies with Rectangular Pier Part 1										
Run	Pier type	$T_o$ (hr)	$y_o$ (m)	$U_c$ (m/s)	$U$ (m/s)	$U/U_c$	$d_s$ (mm)	$d_s/D$	$d/d_o$	
Recr1a	Rectangular	24	200	0.413	0.765	1.852	141	2.820		
Recr1b	Rectangular	24	200	0.413	0.765	1.852	61	1.220	0.433	56.7%
Recr1c	Rectangular	24	200	0.413	0.765	1.852	45	0.900	0.319	68.1%
Recr1d	Rectangular	24	200	0.413	0.765	1.852	13	0.260	0.092	90.8%
recn2	Rectangular	24	200	0.413	0.765	1.852	3	0.060	0.021	97.9%
Recr2a	Rectangular	24	200	0.413	0.854	2.068	152	3.040		
Recr2b	Rectangular	24	200	0.413	0.854	2.068	68	1.360	0.447	55.3%
Recr2c	Rectangular	24	200	0.413	0.854	2.068	44	0.880	0.289	71.1%
Recr2d	Rectangular	24	200	0.413	0.854	2.068	47	0.940	0.309	69.1%
recn3	Rectangular	24	200	0.413	0.854	2.068	5	0.100	0.033	96.7%
Recr3a	Rectangular	24	200	0.413	1.073	2.598	158	3.160		
Recr3b	Rectangular	24	200	0.413	1.073	2.598	75	1.500	0.475	52.5%
Recr3c	Rectangular	24	200	0.413	1.073	2.598	53	1.060	0.335	66.5%
Recr3d	Rectangular	24	200	0.413	1.073	2.598	56	1.120	0.354	64.6%
recrn4	Rectangular	24	200	0.413	1.073	2.598	16	0.320	0.101	89.9%
Recr4a	Rectangular	6	200	0.413	1.286	3.114	155	3.100		
Recr4b	Rectangular	6	200	0.413	1.286	3.114	75	1.500	0.484	51.6%
Recr4c	Rectangular	6	200	0.413	1.286	3.114	65	1.300	0.419	58.1%
Recr4d	Rectangular	6	200	0.413	1.286	3.114	39	0.780	0.252	74.8%
recn5	Rectangular	6	200	0.413	1.286	3.114	32	0.640	0.206	79.4%
Recr5a	Rectangular	6	200	0.413	1.286	3.114	155	3.100		
Recr5b	Rectangular	6	200	0.413	1.286	3.114	98	1.960	0.632	36.8%
Recr5c	Rectangular	6	200	0.413	1.286	3.114	73	1.460	0.471	52.9%
Recr5d	Rectangular	6	200	0.413	1.286	3.114	70	1.400	0.452	54.8%
Recr6a	Rectangular	6	200	0.413	1.286	3.114	51	1.020	0.329	67.1%
Recr6b	Rectangular	24	200	0.413	1.073	2.598	88	1.760	0.557	44.3%

UNIVERSITY OF AUCKLAND										
Basic Data for Riprap Studies with Rectangular Pier Part 1										
Run	Pier type	T <sub>0</sub> (hr)	y <sub>0</sub> (m)	U <sub>0</sub> (m/s)	U (m/s)	U/U <sub>0</sub>	d <sub>0</sub> (mm)	d <sub>0</sub> /D	d/d <sub>0</sub>	r <sub>0</sub>
Recr6c	Rectangular	24	200	0.413	1.073	2.598	70	1.400	0.443	55.7%
Recr6d	Rectangular	24	200	0.413	1.073	2.598	60	1.200	0.380	62.0%
Recr7a	Rectangular	24	200	0.413	1.073	2.598	58	1.160	0.367	63.3%
Recr7b	Rectangular	24	200	0.413	0.854	2.068	82	1.640	0.539	46.1%
Recr7c	Rectangular	24	200	0.413	0.854	2.068	64	1.280	0.421	57.9%
Recr7d	Rectangular	24	200	0.413	0.854	2.068	39	0.780	0.257	74.3%
Recr8a	Rectangular	24	200	0.413	0.854	2.068	11	0.220	0.072	92.8%
Recr8b	Rectangular	24	200	0.413	0.765	1.852	75	1.500	0.532	46.8%
Recr8c	Rectangular	24	200	0.413	0.765	1.852	57	1.140	0.404	59.6%
Recr8d	Rectangular	24	200	0.413	0.765	1.852	29	0.580	0.206	79.4%
recn6	Rectangular	24	200	0.413	0.765	1.852	9	0.180	0.064	93.6%
skew1a	Rectangular	24	200	0.413	0.765	1.852	202	4.040		
skew1b	Rectangular	24	200	0.413	0.765	1.852	83	1.660	0.411	58.9%
skew2a	Rectangular	24	200	0.413	0.765	1.852	56	1.120	0.277	72.3%
skew2b	Rectangular	24	200	0.413	0.765	1.852	96	1.920	0.475	52.5%
recn7	Rectangular	24	200	0.413	0.765	1.852	10	0.200	0.050	95.0%
skew3a	Rectangular	24	200	0.413	1.073	2.598	202	4.040		
skew3b	Rectangular	24	200	0.413	1.073	2.598	147	2.940	0.728	27.2%
skew4a	Rectangular	24	200	0.413	1.073	2.598	95	1.900	0.470	53.0%
skew4b	Rectangular	24	200	0.413	1.073	2.598	98	1.960	0.485	51.5%
RR16b	Rectangular	24	200	0.413	1.073	2.598	56	1.120	0.277	72.3%

UNIVERSITY OF AUCKLAND											
Basic Data for Riprap Studies with Rectangular Pier Part 2											
Run	c (mm)	t (mm)	Y (mm)	D (mm)	D <sub>50</sub> (mm)	y <sub>0</sub> /D	t/D <sub>50</sub>	c/D	U <sub>0</sub> (m/s)	U/U <sub>0</sub>	U/U <sub>0</sub> <sup>2</sup>
recn1				50						1.852	
Recr1a	200	44	0	50	22	4	2	4	1.54	1.853	0.500
Recr1b	200	44	20	50	22	4	2	4	1.54	1.853	0.500
Recr1c	200	44	40	50	22	4	2	4	1.54	1.853	0.500
Recr1d	200	44	60	50	22	4	2	4	1.54	1.853	0.500
recn2			0	50						2.068	
Recr2a	200	44	0	50	22	4	2	4	1.54	2.068	0.555
Recr2b	200	44	20	50	22	4	2	4	1.54	2.068	0.555
Recr2c	200	44	40	50	22	4	2	4	1.54	2.068	0.555
Recr2d	200	44	60	50	22	4	2	4	1.54	2.068	0.555
recn3				50						2.598	
Recr3a	200	44	0	50	22	4	2	4	1.54	2.598	0.697
Recr3b	200	44	20	50	22	4	2	4	1.54	2.598	0.697
Recr3c	200	44	40	50	22	4	2	4	1.54	2.598	0.697
Recr3d	200	44	60	50	22	4	2	4	1.54	2.598	0.697
recn4				50						3.114	
Recr4a	200	44	0	50	22	4	2	4	1.54	3.114	0.841
Recr4b	200	44	20	50	22	4	2	4	1.54	3.114	0.841
Recr4c	200	44	40	50	22	4	2	4	1.54	3.114	0.841
Recr4d	200	44	60	50	22	4	2	4	1.54	3.114	0.841
recn5			0	50						3.114	
Recr5a	200	32	0	50	16	4	2	4	1.42	3.114	0.919
Recr5b	200	32	20	50	16	4	2	4	1.42	3.114	0.919
Recr5c	200	32	40	50	16	4	2	4	1.42	3.114	0.919
Recr5d	200	32	60	50	16	4	2	4	1.42	3.114	0.919
Recr6a	200	32	0	50	16	4	2	4	1.42	2.599	0.767



UNIVERSITY OF AUCKLAND												
Basic Data for Riprap Studies with Rectangular Pier Part 2												
Run	c (mm)	L (mm)	Y (mm)	D (mm)	D <sub>50</sub> (mm)	y/D	t/D <sub>50</sub>	c/D	U <sub>c</sub> (m/s)	U/U <sub>c</sub>	U/U <sub>c</sub>	
Recr6b	200	32	20	50	16	4	2	4	1.42	2.599	0.767	
Recr6c	200	32	40	50	16	4	2	4	1.42	2.599	0.767	
Recr6d	200	32	60	50	16	4	2	4	1.42	2.068	0.610	
Recr7a	200	32	0	50	16	4	2	4	1.42	2.068	0.610	
Recr7b	200	32	20	50	16	4	2	4	1.42	2.068	0.610	
Recr7c	200	32	40	50	16	4	2	4	1.42	2.068	0.610	
Recr7d	200	32	60	50	16	4	2	4	1.42	1.853	0.546	
Recr8a	200	32	0	50	16	4	2	4	1.42	1.853	0.546	
Recr8b	200	32	20	50	16	4	2	4	1.42	1.853	0.546	
Recr8c	200	32	40	50	16	4	2	4	1.42	1.853	0.546	
Recr8d	200	32	60	50	16	4	2	4	1.42	1.852		
recn6			0	50						1.852		
skew1a	200	32	0	50	16	4	2	4	1.42	1.852	0.539	
skew1b	200	32	60	50	16	4	2	4	1.42	1.852	0.539	
skew2a	200	44	0	50	22	4	2	4	1.54	1.852	0.497	
skew2b	200	44	60	50	22	4	2	4	1.54	1.852	0.497	
recn7			0	50						2.598		
skew3a	200	32	0	50	16	4	2	4	1.42	2.598	0.756	
skew3b	200	32	60	50	16	4	2	4	1.42	2.598	0.756	
skew4a	200	44	0	50	22	4	2	4	1.54	2.598	0.697	
skew4b	200	44	60	50	22	4	2	4	1.54	2.598	0.697	

UNIVERSITY OF AUCKLAND											
Basic Data for Sacrificial Piles (Clear Water) Part 1											
Series		Pier type	$T_a$ (hr)	$y_a$ (m)	$U_c$ (m/s)	$U$ (m/s)	$U/U_c$	$d_s$ (mm)	$d_s/D$	$d_s/d_c$	
NPa	No Piles	Circular	0	600	0.415	0.265	0.640	0	0.000		
		Circular	15	600	0.415	0.265	0.640	37	0.247		
		Circular	30	600	0.415	0.265	0.640	41	0.273		
		Circular	45	600	0.415	0.265	0.640	49	0.327		
		Circular	60	600	0.415	0.265	0.640	54	0.360		
		Circular	120	600	0.415	0.265	0.640	62	0.413		
		Circular	180	600	0.415	0.265	0.640	71	0.473		
		Circular	1440	600	0.415	0.265	0.640	118	0.787		
		NPb	No Piles	Circular	0	600	0.415	0.356	0.859	0	0.000
Circular	15			600	0.415	0.356	0.859	77	0.513		
Circular	30			600	0.415	0.356	0.859	94	0.627		
Circular	45			600	0.415	0.356	0.859	101	0.673		
Circular	60			600	0.415	0.356	0.859	112	0.747		
Circular	120			600	0.415	0.356	0.859	133	0.887		
Circular	180			600	0.415	0.356	0.859	140	0.933		
Circular	1440			600	0.415	0.356	0.859	225	1.500		
SP-00-1a				Circular	0	600	0.415	0.265	0.640	0	0.000
		Circular	15	600	0.415	0.265	0.640	3	0.020	0.025	0.975
		Circular	30	600	0.415	0.265	0.640	9	0.060	0.076	0.924
		Circular	120	600	0.415	0.265	0.640	22	0.147	0.186	0.814
		Circular	180	600	0.415	0.265	0.640	22	0.147	0.186	0.814
		Circular	1440	600	0.415	0.265	0.640	61	0.407	0.517	0.483
SP-00-1b		Circular	0	600	0.415	0.356	0.859	0	0.000	0	1
		Circular	15	600	0.415	0.356	0.859	31	0.207	0.138	0.862
		Circular	30	600	0.415	0.356	0.859	40	0.267	0.178	0.822
		Circular	45	600	0.415	0.356	0.859	43	0.287	0.191	0.809

UNIVERSITY OF AUCKLAND											
Basic Data for Sacrificial Piles (Clear Water) Part 1											
Series	Pier type	$T_a$ (hr)	$y_0$ (m)	$U_c$ (m/s)	$U$ (m/s)	$U/U_c$	$d_s$ (mm)	$d_s/D$	$d_s/d_{sc}$	$F$	
	Circular	60	600	0.415	0.356	0.859	52	0.347	0.231	0.769	
	Circular	120	600	0.415	0.356	0.859	66	0.440	0.293	0.707	
	Circular	180	600	0.415	0.356	0.859	74	0.493	0.329	0.671	
	Circular	1440	600	0.415	0.356	0.859	118	0.787	0.524	0.476	
SP-30-1b	Circular	0	600	0.415	0.356	0.859	0	0.000	0.000	1.000	
	Circular	15	600	0.415	0.356	0.859	86	0.573	0.382	0.618	
	Circular	30	600	0.415	0.356	0.859	110	0.733	0.489	0.511	
	Circular	45	600	0.415	0.356	0.859	116	0.773	0.516	0.484	
	Circular	60	600	0.415	0.356	0.859	125	0.833	0.556	0.444	
	Circular	120	600	0.415	0.356	0.859	144	0.960	0.640	0.360	
	Circular	180	600	0.415	0.356	0.859	156	1.040	0.693	0.307	
	Circular	1440	600	0.415	0.356	0.859	250	1.667	1.111	-0.111	
SP-20-2a	Circular	0	600	0.415	0.265	0.640	0	0.000	0.000	1.000	
	Circular	60	600	0.415	0.265	0.640	69	0.460	0.585	0.415	
	Circular	120	600	0.415	0.265	0.640	78	0.520	0.661	0.339	
	Circular	1440	600	0.415	0.265	0.640	127	0.847	1.076	-0.076	
SP-00-2b	Circular	0	600	0.415	0.356	0.859	0	0.000	0.000	1.000	
	Circular	1440	600	0.415	0.356	0.859	98	0.653	0.436	0.564	
SP-20-2b	Circular	0	600	0.415	0.356	0.859	0	0.000	0.000	1.000	
	Circular	15	600	0.415	0.356	0.859	75	0.500	0.333	0.667	
	Circular	30	600	0.415	0.356	0.859	81	0.540	0.360	0.640	
	Circular	60	600	0.415	0.356	0.859	95	0.633	0.422	0.578	
	Circular	120	600	0.415	0.356	0.859	102	0.680	0.453	0.547	
	Circular	1440	600	0.415	0.356	0.859	188	1.253	0.836	0.164	
SP-30-2b	Circular	0	600	0.415	0.356	0.859	0	0.000	0.000	1.000	
	Circular	15	600	0.415	0.356	0.859	91	0.607	0.404	0.596	
	Circular	30	600	0.415	0.356	0.859	106	0.707	0.471	0.529	
	Circular	45	600	0.415	0.356	0.859	113	0.753	0.502	0.498	

UNIVERSITY OF AUCKLAND											
Basic Data for Sacrificial Piles (Clear Water) Part 1											
Series		Pier type	$T_a$ (hr)	$y_a$ (m)	$U_c$ (m/s)	$U$ (m/s)	$U/U_c$	$d_c$ (mm)	$d/D$	$d/d_c$	$T/T_c$
		Circular	60	600	0.415	0.356	0.859	116	0.773	0.516	0.484
		Circular	120	600	0.415	0.356	0.859	140	0.933	0.622	0.378
		Circular	180	600	0.415	0.356	0.859	157	1.047	0.698	0.302
		Circular	1440	600	0.415	0.356	0.859	239	1.593	1.062	-0.062
SP-00-2a		Circular	0	600	0.415	0.265	0.640	0	0.000	0.000	1.000
		Circular	15	600	0.415	0.265	0.640	20	0.133	0.169	0.831
		Circular	30	600	0.415	0.265	0.640	29	0.193	0.246	0.754
		Circular	60	600	0.415	0.265	0.640	35	0.233	0.297	0.703
		Circular	120	600	0.415	0.265	0.640	42	0.280	0.356	0.644
		Circular	1440	600	0.415	0.265	0.640	75	0.500	0.636	0.364
SP-20-2a		Circular	0	600	0.415	0.265	0.640	0	0.000	0.000	1.000
		Circular	30	600	0.415	0.265	0.640	33	0.220	0.280	0.720
		Circular	60	600	0.415	0.265	0.640	40	0.267	0.339	0.661
		Circular	120	600	0.415	0.265	0.640	50	0.333	0.424	0.576
		Circular	180	600	0.415	0.265	0.640	56	0.373	0.475	0.525
		Circular	1440	600	0.415	0.265	0.640	92	0.613	0.780	0.220
SP-00-2b		Circular	0	600	0.415	0.356	0.859	0	0.000	0.000	1.000
		Circular	15	600	0.415	0.356	0.859	61	0.407	0.271	0.729
		Circular	30	600	0.415	0.356	0.859	67	0.447	0.298	0.702
		Circular	45	600	0.415	0.356	0.859	71	0.473	0.316	0.684
		Circular	60	600	0.415	0.356	0.859	78	0.520	0.347	0.653
		Circular	120	600	0.415	0.356	0.859	83	0.553	0.369	0.631
		Circular	180	600	0.415	0.356	0.859	96	0.640	0.427	0.573
		Circular	1440	600	0.415	0.356	0.859	147	0.980	0.653	0.347
SP-20-2b		Circular	0	600	0.415	0.356	0.859	0	0.000	0.000	1.000
		Circular	1440	600	0.415	0.356	0.859	175	1.167	0.778	0.222
SP-30-2b		Circular	0	600	0.415	0.356	0.859	0	0.000	0.000	1.000
		Circular	15	600	0.415	0.356	0.859	68	0.453	0.302	0.698

UNIVERSITY OF AUCKLAND											
Basic Data for Sacrificial Piles (Clear Water) Part 1											
Series	Pier type	$T_p$ (hr)	$y_p$ (m)	$U_1$ (m/s)	$U_2$ (m/s)	$U_1/U_2$	$d_p$ (mm)	$d_p/D$	$d_p/d_{p0}$	$f_s$	
	Circular	30	600	0.415	0.356	0.859	74	0.493	0.329	0.671	
	Circular	45	600	0.415	0.356	0.859	81	0.540	0.360	0.640	
	Circular	60	600	0.415	0.356	0.859	89	0.593	0.396	0.604	
	Circular	120	600	0.415	0.356	0.859	102	0.680	0.453	0.547	
	Circular	180	600	0.415	0.356	0.859	111	0.740	0.493	0.507	
	Circular	1440	600	0.415	0.356	0.859	179	1.193	0.796	0.204	
SP-00-3b	Circular	0	600	0.415	0.356	0.859	0	0.000	0.000	1.000	
	Circular	60	600	0.415	0.356	0.859	64	0.427	0.284	0.716	
	Circular	120	600	0.415	0.356	0.859	69	0.460	0.307	0.693	
	Circular	1440	600	0.415	0.356	0.859	132	0.880	0.587	0.413	
SP-20-3b	Circular	0	600	0.415	0.356	0.859	0	0.000	0.000	1.000	
	Circular	60	600	0.415	0.356	0.859	94	0.627	0.418	0.582	
	Circular	120	600	0.415	0.356	0.859	105	0.700	0.467	0.533	
	Circular	1440	600	0.415	0.356	0.859	174	1.160	0.773	0.227	
SP-30-3b	Circular	0	600	0.415	0.356	0.859	0	0.000	0.000	1.000	
	Circular	60	600	0.415	0.356	0.859	90	0.600	0.400	0.600	
	Circular	1440	600	0.415	0.356	0.859	166	1.107	0.738	0.262	

UNIVERSITY OF AUCKLAND									
Basic Data for Sacrificial Piles (Clear Water) Part 2									
Series	D (mm)	d <sub>p</sub> (mm)	n	e (mm)	X (mm)	α (deg)	β (deg)	X/D	e/D
NPa	150	25					0		
	150	25					0		
	150	25					0		
	150	25					0		
	150	25					0		
	150	25					0		
	150	25					0		
	150	25					0		
NPb	150	25					0		
	150	25					0		
	150	25					0		
	150	25					0		
	150	25					0		
	150	25					0		
	150	25					0		
	150	25					0		
SP-00-1a	150	25	3	100	300	30	0	2	0.667
	150	25	3	100	300	30	0	2	0.667
	150	25	3	100	300	30	0	2	0.667
	150	25	3	100	300	30	0	2	0.667
	150	25	3	100	300	30	0	2	0.667
	150	25	3	100	300	30	0	2	0.667
SP-00-1b	150	25	3	100	300	30	0	2	0.667
	150	25	3	100	300	30	0	2	0.667
	150	25	3	100	300	30	0	2	0.667
	150	25	3	100	300	30	0	2	0.667



UNIVERSITY OF AUCKLAND									
Basic Data for Sacrificial Piles (Clear Water) Part 2									
Series	D (mm)	d <sub>p</sub> (mm)	n	e (mm)	X (mm)	α (deg)	β (deg)	X/D	e/D
	150	25	5	100	300	30	30	2	0.667
	150	25	5	100	300	30	30	2	0.667
	150	25	5	100	300	30	30	2	0.667
	150	25	5	100	300	30	30	2	0.667
SP-00-2a	150	25	5	100	300	53.6	0	2	0.667
	150	25	5	100	300	53.6	0	2	0.667
	150	25	5	100	300	53.6	0	2	0.667
	150	25	5	100	300	53.6	0	2	0.667
	150	25	5	100	300	53.6	0	2	0.667
	150	25	5	100	300	53.6	0	2	0.667
	150	25	5	100	300	53.6	0	2	0.667
SP-20-2a	150	25	5	100	300	53.6	0	2	0.667
	150	25	5	100	300	53.6	0	2	0.667
	150	25	5	100	300	53.6	0	2	0.667
	150	25	5	100	300	53.6	0	2	0.667
	150	25	5	100	300	53.6	0	2	0.667
	150	25	5	100	300	53.6	0	2	0.667
	150	25	5	100	300	53.6	0	2	0.667
SP-00-2b	150	25	5	100	300	53.6	0	2	0.667
	150	25	5	100	300	53.6	0	2	0.667
	150	25	5	100	300	53.6	0	2	0.667
	150	25	5	100	300	53.6	0	2	0.667
	150	25	5	100	300	53.6	0	2	0.667
	150	25	5	100	300	53.6	0	2	0.667
	150	25	5	100	300	53.6	0	2	0.667
	150	25	5	100	300	53.6	0	2	0.667
SP-20-2b	150	25	5	100	300	53.6	20	2	0.667
	150	25	5	100	300	53.6	20	2	0.667
SP-30-2b	150	25	5	100	300	53.6	30	2	0.667
	150	25	5	100	300	53.6	30	2	0.667



UNIVERSITY OF AUCKLAND									
Basic Data for Sacrificial Piles (Clear Water) Part 2									
Series	D (mm)	d <sub>c</sub> (mm)	n	e (mm)	X (mm)	α (deg)	β (deg)	X/D	e/D
	150	25	5	100	300	53.6	30	2	0.667
	150	25	5	100	300	53.6	30	2	0.667
	150	25	5	100	300	53.6	30	2	0.667
	150	25	5	100	300	53.6	30	2	0.667
	150	25	5	100	300	53.6	30	2	0.667
	150	25	5	100	300	53.6	30	2	0.667
SP-00-3b	150	25	5	150	375	30	0	2.5	1.000
	150	25	5	150	375	30	0	2.5	1.000
	150	25	5	150	375	30	0	2.5	1.000
	150	25	5	150	375	30	0	2.5	1.000
SP-20-3b	150	25	5	150	375	30	30	2.5	1.000
	150	25	5	150	375	30	30	2.5	1.000
	150	25	5	150	375	30	30	2.5	1.000
	150	25	5	150	375	30	30	2.5	1.000
SP-30-3b	150	25	5	150	375	30	30	2.5	1.000
	150	25	5	150	375	30	30	2.5	1.000
	150	25	5	150	375	30	30	2.5	1.000

UNIVERSITY OF AUCKLAND											
Basic Data for Sacrificial Piles (Live Bed) Part 1											
Series		Pier type	$T_a$ (hr)	$y_o$ (m)	$U_o$ (m/s)	$U$ (m/s)	$U/U_o$	$d_p$ (mm)	$d/D$	$d_p/d_{50}$	$r_s$
NPc (no piles)	No Piles	Circular	100	600	0.415	0.614	1.480	228	1.520		
NPd (no piles)	No Piles	Circular	100	600	0.415	0.764	1.840	233	1.553		
SP-00-3c		Circular	100	600	0.415	0.614	1.480	188	1.253	0.825	17.54%
SP-20-3c		Circular	100	600	0.415	0.614	1.480	216	1.440	0.947	5.26%
SP-30-3c		Circular	100	600	0.415	0.614	1.480	236	1.573	1.035	-3.51%
SP-00-3d		Circular	100	600	0.415	0.764	1.840	198	1.320	0.850	15.02%
SP-20-3d		Circular	100	600	0.415	0.764	1.840	230	1.533	0.987	1.29%
SP-30-3d		Circular	100	600	0.415	0.764	1.840	246	1.640	1.056	-5.58%

UNIVERSITY OF AUCKLAND									
Basic Data for Sacrificial Piles (Live Bed) Part 2									
Series	D (mm)	$d_p$ (mm)	n	e (mm)	X (mm)	$\alpha$ (deg)	$\beta$ (deg)	X/D	e/D
NPc	150						0		
NPd	150						0		
SP-00-3c	150	25	5	150	375	30	0	2.5	1
SP-20-3c	150	25	5	150	375	30	0	2.5	1
SP-30-3c	150	25	5	150	375	30	0	2.5	1
SP-00-3d	150	25	5	150	375	30	0	2.5	1
SP-20-3d	150	25	5	150	375	30	0	2.5	1
SP-30-3d	150	25	5	150	375	30	0	2.5	1

UNIVERSITY OF AUCKLAND											
Basic Data for Iowa Vanes (Clear Water) Part 1											
Run		Pier type	$T_p$ (hr)	$y_p$ (m)	$U_p$ (m/s)	$U$ (m/s)	$U/U_p$	$d_p$ (mm)	$d/D$	$d/d_p$	$r_s$
NR1	No Vanes	Circular	24	0.290	0.415	0.353	0.850	239	1.195	1.000	0.00%
A1	Array 1	Circular	24	0.290	0.415	0.353	0.850	235	1.175	0.983	1.67%
A2	Array 2	Circular	24	0.290	0.415	0.353	0.850	208	1.040	0.870	12.97%
A3	Array 3	Circular	24	0.290	0.415	0.353	0.850	190	0.950	0.795	20.50%
A4	Array 4	Circular	24	0.290	0.415	0.353	0.850	193	0.965	0.808	19.25%
A5	Array 5	Circular	24	0.290	0.415	0.353	0.850	200	1.000	0.837	16.32%
A6	Array 6	Circular	24	0.290	0.415	0.353	0.850	196	0.980	0.820	17.99%
A7	Array 7	Circular	24	0.290	0.415	0.353	0.850	208	1.040	0.870	12.97%
A8	Array 8	Circular	24	0.290	0.415	0.353	0.850	206	1.030	0.862	13.81%
A9	Array 9	Circular	24	0.290	0.415	0.353	0.850	210	1.050	0.879	12.13%
A10	Array 10	Circular	24	0.290	0.415	0.353	0.850	185	0.925	0.774	22.59%
A11	Array 11	Circular	24	0.290	0.415	0.353	0.850	213	1.065	0.891	10.88%
A12	Array 12	Circular	24	0.290	0.415	0.353	0.850	206	1.030	0.862	13.81%
A13	Array 13	Circular	24	0.290	0.415	0.353	0.850	190	0.950	0.795	20.50%
A14	Array 14	Circular	24	0.290	0.415	0.353	0.850	190	0.950	0.795	20.50%

UNIVERSITY OF AUCKLAND									
Basic Data for Iowa Vanes (Clear Water) Part 2									
Run	D (mm)	n <sub>v</sub>	T <sub>v</sub> (mm)	e <sub>v</sub> (mm)	X <sub>v</sub> (mm)	Z <sub>v</sub> (mm)	L (mm)	H <sub>v</sub> (mm)	α (deg)
No Vanes	-	-	-	-	-	-	-	-	-
Array 1	200	6	90	150	400	200	70	200	15
Array 2	200	6	90	150	400	100	70	200	15
Array 3	200	6	90	100	275	100	70	200	15
Array 4	200	6	165	100	275	100	70	125	15
Array 5	200	6	90	100	275	100	70	200	25
Array 6	200	6	90	75	200	100	70	200	15
Array 7	200	4	90	100	175	100	70	200	15
Array 8	200	6	90	100	275	200/100/60	70	200	15
Array 9	200	6	190	100	275	100	70	100	15
Array 10	200	6	90	100	275	100	70	200	35
Array 11	200	6	90	100	275	100	35	200	15
Array 12	200	12	90	100	275	100/60	35	200	35
Array 13	200	6	90	100	275	100	35	200	35
Array 14	200	8	90	100	275	100	35	200	35

UNIVERSITY OF AUCKLAND												
Basic Data for Iowa Vanes (Live Bed) Part 1												
Series		Run	Pier type	$T_c$ (hr)	$Y_c$ (m)	$U_c$ (m/s)	$U$ (m/s)	$U/U_c$	$d_c$ (mm)	$d/D$	$d/d_c$	$r_c$
NR2	No Vanes	A	Circular	24	0.600	0.415	0.6142	1.48	273	1.365	1.000	0.00%
NR3		B	Circular	24	0.600	0.415	0.7636	1.84	309	1.545	1.000	0.00%
LV1	Array 1	A	Circular	24	0.600	0.415	0.6142	1.48	293	1.465	1.073	-7.33%
LV2	Array 2	A	Circular	24	0.600	0.415	0.6142	1.48	249	1.245	0.912	8.79%
LV3	Array 3	A	Circular	24	0.600	0.415	0.6142	1.48	284	1.420	1.040	-4.03%
LV4	Array 4	A	Circular	24	0.600	0.415	0.6142	1.48	255	1.275	0.934	6.59%
LV5	Array 5	A	Circular	24	0.600	0.415	0.6142	1.48	236	1.180	0.864	13.55%
LV6a	Array 6	A	Circular	24	0.600	0.415	0.7636	1.84	304	1.520	0.984	1.62%
LV6b		B	Circular	24	0.600	0.415	0.6142	1.48	243	1.215	0.890	10.99%
LV7	Array 7	A	Circular	24	0.600	0.415	0.6142	1.48	240	1.200	0.879	12.09%
LV8	Array 8	A	Circular	24	0.600	0.415	0.6142	1.48	247	1.235	0.905	9.52%
LV9	Array 9	A	Circular	24	0.600	0.415	0.6142	1.48	258	1.290	0.945	5.49%
LV10	Array 10	A	Circular	24	0.600	0.415	0.6142	1.48	179	0.895	0.656	34.43%
LV11a	Array 11	A	Circular	24	0.600	0.415	0.7636	1.84	294	1.470	0.951	4.85%
LV11b		B	Circular	24	0.600	0.415	0.6142	1.48	222	1.110	0.813	18.68%
LV12a	Array 12	A	Circular	24	0.600	0.415	0.6142	1.48	293	1.465	0.948	5.18%
LV12b		B	Circular	24	0.600	0.415	0.7636	1.84	207	1.035	0.758	24.18%
LV13	Array 13	A	Circular	24	0.600	0.415	0.6142	1.48	229	1.145	0.839	16.12%
LV14	Array 14	A	Circular	24	0.600	0.415	0.6142	1.48				

UNIVERSITY OF AUCKLAND									
Basic Data for Iowa Vanes (Live Bed) Part 2									
Run	D (mm)	$n_v$	$T_v$ (mm)	$e_v$ (mm)	$X_v$ (mm)	$z_v$ (mm)	$L_v$ (mm)	$H_v$ (mm)	$\alpha_v$ (deg)
NR2	200	-	-	-	-	-	-	-	-
NR3	200	-	-	-	-	-	-	-	-
LV1	200	6	200	100	275	200	70	400	15
LV2	200	6	200	100	275	200	70	400	35
LV3	200	6	200	100	275	100	70	400	15
LV4	200	6	200	100	275	100	70	400	35
LV5	200	6	200	100	375	100	70	400	35
LV6a	200	6	500	300	850	600	300	100	15
LV6b	200	6	400	300	850	600	300	100	15
LV7	200	6	400	300	850	600	300	200	15
LV8	200	6	500	450	1200	360	300	100	15
LV9	200	6	400	300	900	600	300	200	15
LV10	200	4	500	300	550	600	300	100	15
LV11a	200	6	500	300	850	600	300	100	30
LV11b	200	6	500	300	850	600	300	100	30
LV12a	200	6	500	300	850	600	300	100	20
LV12b	200	6	500	300	850	600	300	100	20
LV13	200	6	500	400	1050	600	300	100	15
LV14	200	6	500	300	850	800	300	100	15

NANYANG UNIVERSITY														
Summary Data: Riprap experiments														
Series	Run	$d_{50}$ (mm)	$D_{85}$ (mm)	D (mm)	c/D	$\sqrt{D_{50}}$	$y_0$ (m)	U (m/s)	U/U <sub>c</sub>	d (m)	d/D	d/d <sub>50</sub>	$r_c$	
A1	1	0.26	9.1	70	4	2	250	0.14	0.51	0	0.00	0.00	100%	
	"	2	0.26	9.1	70	4	2	250	0.19	0.68	0	0.00	0.00	100%
	"	3	0.26	9.1	70	4	2	250	0.26	0.95	0	0.00	0.00	100%
	"	4	0.26	9.1	70	4	2	250	0.33	1.23	0.029	0.41	0.15	85%
	"	5	0.26	9.1	70	4	2	250	0.44	1.64	0.039	0.56	0.21	79%
	"	6	0.26	9.1	70	4	2	250	0.52	1.91	0.101	1.44	0.54	46%
	"	7	0.26	9.1	70	4	2	250	0.65	2.39	0.146	2.09	0.78	22%
	"	8	0.26	9.1	70	4	2	250	0.96	3.55	0.186	2.66	0.99	1%
	"	9	0.26	9.1	70	4	2	250	1.29	4.73	0.186	2.66	0.99	1%
A2	1	0.26	5.8	25	4	2	250	0.26	0.95	0	0.00	0.00	100%	
	"	2	0.26	5.8	25	4	2	250	0.39	1.43	0.002	0.08	0.02	98%
	"	3	0.26	5.8	25	4	2	250	0.52	1.91	0.025	1.00	0.26	74%
	"	4	0.26	5.8	25	4	2	250	0.65	2.39	0.075	3.00	0.77	23%
	"	5	0.26	5.8	25	4	2	250	0.96	3.55	0.097	3.88	1.00	0%
	"	6	0.26	5.8	25	4	2	250	1.11	4.09	0.097	3.88	1.00	0%
A3	1	0.26	9.1	70	4	12	250	0.14	0.51	0	0.00	0.00	100%	
	"	2	0.26	9.1	70	4	12	250	0.26	0.95	0	0.00	0.00	100%
	"	3	0.26	9.1	70	4	12	250	0.41	1.50	0	0.00	0.00	100%
	"	4	0.26	9.1	70	4	12	250	0.52	1.91	0.002	0.03	0.01	99%
	"	5	0.26	9.1	70	4	12	250	0.65	2.39	0.057	0.81	0.30	70%
	"	6	0.26	9.1	70	4	12	250	0.78	2.86	0.147	2.10	0.79	21%
	"	7	0.26	9.1	70	4	12	250	0.87	3.20	0.161	2.30	0.86	14%
	"	8	0.26	9.1	70	4	12	250	0.96	3.55	0.176	2.51	0.94	6%
	"	9	0.26	9.1	70	4	12	250	1.11	4.09	0.176	2.51	0.94	6%
	"	10	0.26	9.1	70	4	12	250	0.96	3.55	0.176	2.51	0.94	6%
A4	1	0.26	9.1	25	4	2	250	0.26	0.95	0	0.00	0.00	100%	

NANYANG UNIVERSITY													
Summary Data: Riprap experiments													
Series	Run	$d_{50}$ (mm)	$D_{150}$ (mm)	D (mm)	c/D	$t/D_{150}$	$y_c$ (m)	U (m/s)	U/U <sub>c</sub>	$d_c$ (m)	$d_c/D$	$d_c/d_{50}$	$\tau_c$
"	2	0.26	9.1	25	4	2	250	0.41	1.50	0	0.00	0.00	100%
"	3	0.26	9.1	25	4	2	250	0.52	1.91	0.02	0.80	0.21	79%
"	4	0.26	9.1	25	4	2	250	0.65	2.39	0.074	2.96	0.76	24%
"	5	0.26	9.1	25	4	2	250	0.78	2.86	0.091	3.64	0.94	6%
"	6	0.26	9.1	25	4	2	250	0.87	3.20	0.097	3.88	1.00	0%
"	7	0.26	9.1	25	4	2	250	0.98	3.61	0.097	3.88	1.00	0%
"	8	0.26	9.1	25	4	2	250	1.11	4.09	0.097	3.88	1.00	0%
A5	1	0.26	9.1	70	4	2	80	0.12	0.49	0	0.00	0.00	100%
"	2	0.26	9.1	70	4	2	80	0.23	0.98	0	0.00	0.00	100%
"	3	0.26	9.1	70	4	2	80	0.43	1.84	0.006	0.09	0.05	95%
"	4	0.26	9.1	70	4	2	80	0.67	2.85	0.1	1.43	0.87	13%
"	5	0.26	9.1	70	4	2	80	0.72	3.07	0.11	1.57	0.96	4%
"	6	0.26	9.1	70	4	2	80	1.04	4.42	0.11	1.57	0.96	4%
A6	1	0.26	9.1	70	4	12	70	0.13	0.57	0	0.00	0.00	100%
"	2	0.26	9.1	70	4	12	70	0.26	1.14	0	0.00	0.00	100%
"	3	0.26	9.1	70	4	12	70	0.50	2.14	0	0.00	0.00	100%
"	4	0.26	9.1	70	4	12	70	0.67	2.92	0.063	0.90	0.58	42%
"	5	0.26	9.1	70	4	12	70	0.73	3.14	0.087	1.24	0.81	19%
"	6	0.26	9.1	70	4	12	70	1.19	5.15	0.11	1.57	1.02	0%
A7	1	0.26	9.1	70	4	4	210	0.17	0.62	0	0.00	0.00	100%
"	2	0.26	9.1	70	4	4	210	0.39	1.45	0	0.00	0.00	100%
"	3	0.26	9.1	70	4	4	210	0.51	1.91	0.056	0.80	0.31	69%
"	4	0.26	9.1	70	4	4	210	0.64	2.40	0.117	1.67	0.65	35%
"	5	0.26	9.1	70	4	4	210	0.85	3.19	0.176	2.51	0.98	2%
"	6	0.26	9.1	70	4	4	210	1.19	4.47	0.176	2.51	0.98	2%
B1	1	1.01	71.6	70	4	2	210	0.17	0.39	0	0.00	0.00	100%
"	2	1.01	71.6	70	4	2	210	0.42	1.00	0.013	0.19	0.07	93%
"	3	1.01	71.6	70	4	2	210	0.73	1.73	0.08	1.14	0.44	56%



NANYANG UNIVERSITY													
Summary Data: Riprap experiments													
Series	Run	$d_{50}$ (mm)	$D_{75}$ (mm)	D (mm)	c/D	$V/D_{50}$	$y_0$ (m)	U (m/s)	U/U <sub>c</sub>	d (m)	d/D	d/d <sub>50</sub>	$\tau_c$
"	4	1.01	71.6	70	4	2	210	1.21	2.89	0.133	1.90	0.73	27%
"	5	1.01	71.6	70	4	2	210	1.64	3.91	0.145	2.07	0.80	20%
"	6	1.01	71.6	70	4	2	210	2.27	5.41	0.145	2.07	0.80	20%
B2	1	1.01	71.6	38	7	2	210	0.17	0.39	0	0.00	0.00	100%
"	2	1.01	71.6	38	7	2	210	0.42	1.00	0	0.00	0.00	100%
"	3	1.01	71.6	38	7	2	210	0.73	1.73	0.028	0.74	0.24	76%
"	4	1.01	71.6	38	7	2	210	1.21	2.89	0.088	2.32	0.77	23%
"	5	1.01	71.6	38	7	2	210	1.64	3.91	0.124	3.26	1.08	0%
"	6	1.01	71.6	38	7	2	210	2.27	5.41	0.124	3.26	1.08	0%
B3	1	1.01	71.6	70	4	2	210	0.17	0.39	0	0.00	0.00	100%
"	2	1.01	71.6	70	4	2	210	0.42	1.00	0	0.00	0.00	100%
"	3	1.01	71.6	70	4	2	210	0.73	1.73	0.071	1.01	0.39	61%
"	4	1.01	71.6	70	4	2	210	1.21	2.89	0.123	1.76	0.68	32%
"	5	1.01	71.6	70	4	2	210	1.64	3.91	0.158	2.26	0.87	13%
"	6	1.01	71.6	70	4	2	210	2.27	5.41	0.158	2.26	0.87	13%



## APPENDIX B. GUIDE TO VIDEO ON BRIDGE SCOUR

In the course of conducting experiments at St. Anthony Falls Laboratory, University of Minnesota for the project "Countermeasures to Protect Bridge Piers from Scour" (NCHRP 24-7) an extensive set of video images were recorded from inside four model bridge piers with transparent walls. The two bridge piers in the Main Channel at St. Anthony Falls Laboratory, one circular and one rectangular, each had a width  $D$  of 0.305 m (1 ft). The rectangular pier was 0.914 m (3 ft) long. The two bridge piers in the Tilting Flume at the same institution, one circular and one rectangular, each had a width of 0.102 m (4 in). The rectangular pier had a length of 0.305 m (1 ft). The video images provide a revealing view of scour processes and how they interact with countermeasures against scour under the severe conditions characteristic of sand bed streams in flood. They have been condensed to a single videotape of educational value. This document provides a guide to the videotape. The videotape itself is available from St. Anthony Falls Laboratory at a nominal price.

1. **Scour at unprotected piers** The first sequence shows the scour process from inside circular and rectangular bridge piers. The flow conditions are intense, and accurately model flood conditions in sand bed channels. Intense sediment transport and suspension, the intermittent action of the horseshoe vortex, the fluctuating scour and periodically failing avalanche face on the upstream side of the scour hole are vividly rendered. The strong interaction between migrating dunes and the scour hole is illustrated.

2. **Performance of riprap without a geotextile or filter layer at a pier** The images illustrate the tendency for riprap to gradually sink and disperse in response to the effect of migrating dunes, even under conditions for which it is never directly entrained by the flow. Intense leaching of sand from the interstices of the riprap is captured. Failure of the riprap by entrainment is illustrated at very intense flow.

3. **Performance of riprap underlain by a geotextile** The tendency of the geotextile to suppress leaching of sand is illustrated. This notwithstanding, leaching is observed between the geotextile and the face of the pier. Uplift failure of the geotextile is observed at flows sufficiently intense to entrain the riprap. Good anchoring of the geotextile is realized by gradual edge failure of the riprap.

4. **Performance of riprap underlain by a geotextile sealed to the pier** The video images show how such a configuration brings a halt to both sediment leaching and settling of the riprap. The beneficial process of anchoring of the geotextile along its outer edge by settling riprap is illustrated. At a sufficiently intense flow the riprap is plucked away and the geotextile exposed.

5. **Performance of cable tied blocks without a geotextile.** The video captures leaching of sand from the interstices of the blocks that is sufficiently intense to create a sizable scour hole *underneath* the block mattress. At a sufficiently high flow the block mattress fails by uplift and is wrapped against the pier. In so far as the block mattress falls back into place when the flow is reduced, the video images illustrate a failure that would not easily be detected by inspection after the fact.

6. **Performance of cable tied blocks underlain by a geotextile** The video documents considerably improved performance, with excellent self-anchoring along the outer edge. Local leaching of sand from the gap between the geotextile and the pier nevertheless causes noticeable settling. At a sufficiently intense flow the block mattress is seen to undergo incipient failure.

7. **Performance of cable tied blocks underlain by a geotextile sealed to the pier.** The excellent performance of this configuration is illustrated. A thin layer of riprap was placed on top of the geotextile along the pier. This riprap is observed to fail at an intense flow, but the block mattress continues to perform well under very adverse conditions.

8. **Grout filled bags** The ease with which these bags slide and disperse, and their lack of flexibility (as compared to angular riprap) is illustrated. Very long grout filled sausages remain stable, but

scour readily progresses underneath them due to their lack of flexibility. The geotextile underneath is observed to fail even though the sausages do not move.

9. **Pier attached vanes** This intriguing concept is shown to offer little protection to bridge piers under mobile bed conditions typical of sand bed rivers in flood. If the scour proceeds below the lowest pier attached to the vane, the resulting scour hole is larger than if there were no vanes attached.

10. **Submerged permeable sheet piles** These devices, placed upstream of bridge piers, are intended to operate on the same principle as snow fences to encourage deposition. Of themselves, they are seen to offer little scour protection under intense flood conditions in sand bed streams. They can, however, help stabilize otherwise undersized riprap around a bridge pier.

## APPENDIX C. NOTATIONS

$a_{cb}$	coefficient defined by Eq. (3.10b);
$c$	areal cover of a riprap layer;
$d_p$	pile diameter;
$d$	characteristic diameter of the ambient bed sediment;
$d_{save}$	average scour depth;
$d_{50}$	median size of the ambient bed sediment;
$d_s$	maximum depth of scour below local average level of ambient bed;
$d_{so}$	time-averaged maximum depth of scour in the absence of any pier protection;
$D$	pier diameter for cylindrical (circular) pier; pier width for rectangular pier;
DG	degradation level
$D_r$	characteristic size of the riprap;
$D_{r50}$	median size of the riprap;
$e$	longitudinal spacing between the pile;
$e_v$	transverse spacing between vanes;
<b>Fr</b>	Froude number defined in Eq. (3.6);
$g$	gravitational acceleration;
$H_{cb}$	height of blocks in cable tied block mattress;
$H_v$	vane height;
$K$	coefficient in Eq. (3.7b);
$L_v$	vane length;
$n$	number of piles;
$n_v$	number of vanes;
$N_{cb}$	dimensionless parameter governing cable tied block mattress as defined in Eq. (3.11);
$N_{sc}$	dimensionless parameter governing riprap stability defined in Eq. (3.8);
$p$	fraction pore space in cable tied block mattress;
$r_s$	fractional reduction in maximum scour depth achieved by a countermeasure as compared to the absence of any countermeasure equal to $1-(d_s/d_{so})$ ;
$R_{ep}$	particle Reynolds number defined in Eq. (3.5b);
$S_w$	average slope of the water surface;
$t$	thickness of a riprap layer;
$T_d$	time duration of a run;
$T_v$	depth of submergence of the vanes below the water surface;

$u_{*rc}$	critical value of shear velocity for motion of the ambient bed sediment;
$U$	depth averaged approach flow velocity upstream of pier;
$U_c$	critical value of $U$ for the initiation of motion of the ambient bed sediment;
$U_{cb}$	critical value of $U$ for failure of cable tied block mattress;
$U_{rc}$	critical value of $U$ for the initiation of motion of the riprap;
$u_{*c}$	critical value of shear velocity for motion of the ambient bed sediment;
$u_{*s}$	portion of shear velocity ascribed to skin friction, defined in Eq. (3.3b);
$X$	displacement of the most upstream pile from the pier;
$X_v$	displacement of the most upstream vane from the pier;
$y_o$	depth of ambient flow in the vicinity of the bridge pier;
$Y$	initial elevation of the top of the riprap layer below the average bed level;
$z_v$	lateral spacing between vanes;
$\alpha$	wedge angle defined by the pile array;
$\alpha_v$	angle of orientation of each vane to the flow;
$\beta$	angle of skew or attack;
$\Delta$	average dune height;
$\rho$	density of water;
$\rho_{cb}$	density of blocks in cable tied block mattress;
$\rho_r$	density of riprap;
$\rho_s$	density of ambient bed sediment;
$\sigma_g$	geometric standard deviation of the bed sediment;
$\tau^*$	dimensionless Shields stress, defined in Eq. (3.2a);
$\tau_s^*$	portion of Shields stress ascribable to skin friction, defined in Eq. (3b);
$\nu$	kinematic viscosity of water.
$\zeta$	bulk weight per unit area of cable tied block mattress;