

UNIVERSITY OF MINNESOTA
ST. ANTHONY FALLS HYDRAULIC LABORATORY

Project Report No. 202

AN EXPERIMENTAL INVESTIGATION OF THE INFLUENCE OF AN
AIR BUBBLE LAYER ON RADIATED NOISE AND SURFACE PRESSURE
FLUCTUATIONS IN A TURBULENT BOUNDARY LAYER

by

JOHN M. KILLEN
St. Anthony Falls Hydraulic Laboratory
University of Minnesota
Minneapolis, Minnesota 55455

*Final Report for Period January 1980-September 1981
Contract N00014-80-C-0209*

Approved for public release; distribution unlimited

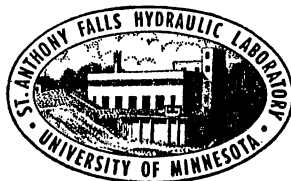

Prepared for

OFFICE OF NAVAL RESEARCH
Department of the Navy
Arlington, Virginia 22217

DAVID W. TAYLOR NAVAL SHIP RESEARCH
AND DEVELOPMENT CENTER
Bethesda, Maryland 20084

September, 1981

Minneapolis, Minnesota

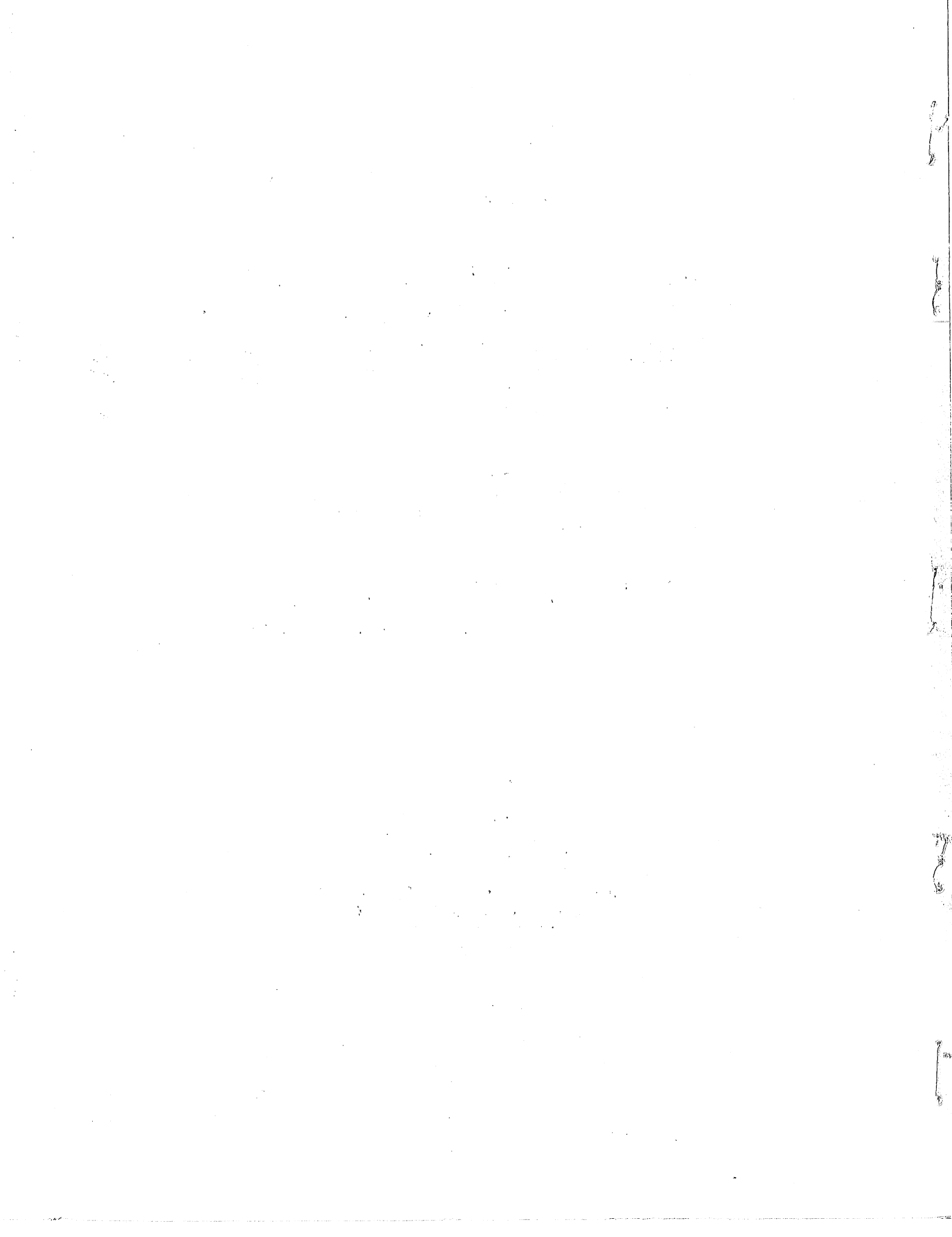

Unclassified

SECURITY CLASSIFICATION OF THIS PAGE (When Data Entered)

REPORT DOCUMENTATION PAGE		READ INSTRUCTIONS BEFORE COMPLETING FORM
1. REPORT NUMBER Project Report No. 202	2. GOVT ACCESSION NO.	3. RECIPIENT'S CATALOG NUMBER
4. TITLE (and Subtitle) AN EXPERIMENTAL INVESTIGATION OF THE INFLUENCE OF AN AIR BUBBLE LAYER ON RADIATED NOISE AND SURFACE PRESSURE FLUCTUATIONS IN A TURBULENT BOUNDARY LAYER		5. TYPE OF REPORT & PERIOD COVERED Final Report Jan. 1980 thru Sept. 1981
		6. PERFORMING ORG. REPORT NUMBER Project Report No. 202
7. AUTHOR(s) John M. Killen		B. CONTRACT OR GRANT NUMBER(s) N00014-80-C-0209
		10. PROGRAM ELEMENT, PROJECT, TASK AREA & WORK UNIT NUMBERS SR2301; TAC 001; PDC 32R; Element 61153 N; Task 19077
9. PERFORMING ORGANIZATION NAME AND ADDRESS St. Anthony Falls Hydraulic Laboratory University of Minnesota Minneapolis, Minnesota 55455		12. REPORT DATE September, 1981
		13. NUMBER OF PAGES 24
11. CONTROLLING OFFICE NAME AND ADDRESS Office of Naval Research Arlington, Virginia 22217		15. SECURITY CLASS. (of this report) Unclassified
		15a. DECLASSIFICATION/DOWNGRADING SCHEDULE
14. MONITORING AGENCY NAME & ADDRESS (if different from Controlling Office) David W. Taylor Naval Ship Research and Development Center Bethesda, Maryland 20084		
16. DISTRIBUTION STATEMENT (of this Report) Approved for public release; distribution unlimited.		
17. DISTRIBUTION STATEMENT (of the abstract entered in Block 20, if different from Report) 15 copies forwarded to NSRDC, Code 1505, Bldg. 19, Rm 129B.		
18. SUPPLEMENTARY NOTES		
19. KEY WORDS (Continue on reverse side if necessary and identify by block number) Boundary layer noise, Kinetic energy dissipation, Air bubble layer, Maximum stable bubble size, bubble noise spectra		
20. ABSTRACT (Continue on reverse side if necessary and identify by block number) An experimental investigation is described which shows relationships between the noise spectra of a layer of air bubbles in a turbulent flow and a maximum stable bubble size which can exist in the same flow. An air bubble layer with individual bubble sizes greater than a maximum stable size was introduced into the boundary layer of water flowing along a smooth flat plate. It was found that the maximum stable bubble size was related to the turbulent kinetic energy dissipation as had been previously shown by other investigators		

DD FORM 1473
1 JAN 73

EDITION OF 1 NOV 65 IS OBSOLETE
S/N 0102-LF-014-6601

Unclassified

SECURITY CLASSIFICATION OF THIS PAGE (When Data Entered)

UNCLASSIFIED

SECURITY CLASSIFICATION OF THIS PAGE (When Data Entered)

for a variety of turbulent flows. A unique "corner frequency" of the noise spectra which resulted from the bubble splitting down to a maximum stable size could be also related to the turbulent kinetic energy dissipation of the boundary layer flow.

UNCLASSIFIED

SECURITY CLASSIFICATION OF THIS PAGE(When Data Entered)

PREFACE

This research was carried out under the Naval Sea Systems Command General Hydromechanics Research Program Subproject SR 023 01 01, and administered by the David W. Taylor Naval Ship Research and Development Center, under Contract N00014-80-C-0209.

The University of Minnesota is committed to the policy that all persons shall have equal access to its programs, facilities, and employment without regard to race, creed, color, sex, national origin, or handicap.

TABLE OF CONTENTS

	Page
Preface	1
List of Figures	4
INTRODUCTION	5
EXPERIMENTAL	7
RESULTS	8
DISCUSSION	11
REFERENCES	14
Figures 1 through 11	16

LIST OF FIGURES

Figure No.

- 1 Schematic of High Speed, Variable Pressure, Water Tunnel.
- 2 Pressure Distribution on Water Tunnel Test Section Upper Surface.
- 3 Measured Boundary Layer Displacement Thickness on Water Tunnel Wall.
- 4 Data Processing Equipment.
- 5 Surface Pressure Fluctuation.
- 6 Surface Pressure Spectra with an Air Bubble Layer Q/V Constant.
- 7 Conceptual Change of Bubble Size with Distance at a Given Velocity.
- 8 Air Bubble Noise Spectra for a Range of Air Flow Rates Velocity Constant.
- 9 Bubble Size Estimation from Spectra Corner Frequency.
- 10 Bubble Noise Spectra. Air Injected 97 cm Upstream of the Transducer.
- 11 Bubble Noise Spectra with a Chamber Mounted Pressure Transducer.

AN EXPERIMENTAL INVESTIGATION OF THE INFLUENCE OF
AN AIR BUBBLE LAYER ON RADIATED NOISE
AND SURFACE PRESSURE FLUCTUATIONS IN A TURBULENT BOUNDARY LAYER

Final Report

INTRODUCTION

A layer of air bubbles when introduced along a boundary in flowing water has many associated acoustic and hydrodynamic effects of considerable practical value as well as theoretical interest. Possibly the two most useful applications of a bubble layer are for the reduction of cavitation damage (Peterka, 1953) and attenuation of acoustic noise. Air bubble layers are sometimes introduced into the flow as a by-product of some other effort such as the ventilation of struts, hydrofoils, or the wake of supercavitating flows.

There is some evidence (Stefan and Anderson, 1964) that a bubble layer will provide drag reduction at the rather large concentration of 10 per cent. A reduction in friction factor, however, was not observed in the case of bubbly mixtures in pipes (James and Silberman, 1958).

The useful phenomena associated with an air bubble layer in water in some instances is not without some important adverse effects such as the impairment of performance of pumps (Killen and Wetzel, 1981) or heat exchangers. The potential for compromise between beneficial and adverse effect is possible only when the necessary and limiting parameters of the conflicting phenomena are well known. For example, it has been found that a cooling pump will tolerate less than 4 per cent air by volume in the inlet flow without serious degradation in performance. At the same time, the air concentration for quieting by a bubble layer can be much less than this value if uniformity of the screen can be maintained. The use of a bubble screen for cavitation damage prevention or drag reduction, which requires 5-10 per cent concentration, would be incompatible if

such a bubbly flow could enter a cooling pump at the same time. The role of bubble size in either cavitation damage reduction or pump performance degradation is at present an unknown quantity. The equilibrium size of an air bubble in a boundary layer is only indirectly known from studies on other devices (Sevik and Park, 1973; Cliff et al., 1978) and limited experimental measurement on large spillways (Cain, 1975), the latter being a model comparable to ship boundary layers.

The acoustic properties of an air bubble layer have been known for a considerable time for their effect on sound attenuation and velocity of propagation (Mallock, 1910; Minnaert, 1933). The very high attenuation of a bubbly mixture over a broad range of frequencies reaching 4×10^4 VdB/cm in a frequency range 20-100 KHz where V is the volume concentration has been very useful for sound isolation application (Kuhl et al., 1947).

It is only recently that the acoustic properties of air bubble screens have been suspected of having both a sound amplification capability as well as attenuation (Crighton et al., 1969; Junger and Cole, 1980). However, experimental evidence of amplification has been lacking.

It is suspected that in many applications involving the use of bubble screens for quieting, a superabundant quantity of bubbles are used. If secondary problems such as improved pump performance could be solved by a concentration reduction, then confidence in the reliability of the quieting feature would need to be established if adverse effects such as sound amplification is to be avoided.

Possibly the most significant evidence of increased noise from a bubble layer was the experiments of Franklin and McMillan (1976) on wall pressure measurements in bubbly flow in which they showed a 20 dB rise in the signal sensed by a surface pressure transducer with the addition of air to the boundary layer. The present investigation is concerned with a further description of this phenomena--the nature of the acoustic signal and its relation to air bubble size and concentration. Measurements were made of surface pressure fluctuation under the boundary layer of a smooth plane surface with a nearly zero pressure gradient far downstream of the transition. Air was injected through an orifice or orifice manifold at various distances upstream of the surface pressure fluctuation

observation point. A range of bubble concentrations was used which was changed by altering the air flow rate through the upstream orifice. A range of bubble sizes resulted from various combinations of air flow rates and boundary layer velocities. Correlation measurements were made between two surface pressure transducers at various separation points, both streamwise and cross-stream. High speed photographs and motion pictures were made of the bubble layer produced by the orifice as it flowed past the pressure transducers. From these photos bubble size and information on acoustic signal could be obtained.

EXPERIMENTAL

The experiments were performed in the St. Anthony Falls Hydraulic Laboratory's free-surface water tunnel. Although the free-surface feature was not used, a number of additional devices which were required with the free-surface capability proved to be quite useful in these experiments. The water tunnel, Fig. 1, is equipped with a very large efficient air separator which was used to remove the accumulated air from the bubble injector so that recirculation of bubbles would not occur. An unusually large contraction ratio of 100:1 exists as a consequence of the presence of the air separator. A low water velocity occurs in all but the test section, and as a further consequence the noise background of the water tunnel was quite low, which is an advantage for acoustic measurements. The upper surface of the test section was covered with a 1/4 in. lucite sheet contoured to match the former free-surface. The surface was further shaped by a trial procedure to give a nearly zero pressure gradient along this surface in the test region. Figure 2 shows the measured pressure distribution for a series of taps placed along the lucite plate centerline. The distance covered begins from a short distance into the contraction region to a little beyond the pressure transducer location.

Velocity profiles were measured with a stagnation tube at the location of pressure fluctuation measurement. Boundary layer displacement thickness was determined from a graphical integration of the measured velocity profile. Figure 3 shows the measured displacement thickness compared with an empirical relationship for turbulent boundary layer thickness (Schlichting, 1979). The transition was located from the more rapid dispersion of bubbles that occurred at this point.

A flooded chamber now exists above the test section which is a useful location for mounting hydrophones to measure radiated noise.

While the test section is free of visible bubbles, the water in the tunnel becomes saturated with air so that rather high test section pressure must be used to suppress cavitation. Cavitation and its associated noise is regarded as an unwanted complication to the noise measurements.

Air was injected through a manifold of one to eight, 2 mm holes, 25 to 90 cm, upstream from the pressure transducers. It was soon found that the noise spectra did not change in form or magnitude with either a single orifice or a number of orifices. Flow through a single orifice is easier to describe than a multiplicity of holes which can interfere with each other; therefore, the experiments were carried out with a single orifice for injection.

The surface pressure transducers were either an NSRDC produced 3 mm transducer or a BBN Model 377 sensor with a 2 mm active area.

Figure 4 is a block diagram of the data analysis equipment. The use of analog type rather than sampling type data analysis equipment was found more convenient for dealing with random pulse type physical data as it occurs here. Both types of equipment are available at the St. Anthony Falls Hydraulic Laboratory.

RESULTS

Measurement of surface pressure fluctuation for a range of velocities of 3.66 - 18.29 mps and a test section pressure of 50.8 cm of mercury are shown on Fig. 5. A 3 mm transducer was used. No correction has been made for the finite transducer size. The results are comparable to measurement by other investigators for the same size of transducers (Silberman, 1978; Nisewanger, 1965). The coordinates are $\Phi(\omega) V^{1/4} \rho^{1/2} V^4 \delta^*$ vs. $\frac{\omega \delta}{V}$, where $\Phi(\omega)$ is the measured power spectra, ω is 2π times frequency, ρ the density, V the fluid velocity outside the boundary layer, and δ^* the boundary layer displacement thickness. Air was then added to the boundary layer at a flow rate that would produce a near maximum increase in noise. The results are shown on Fig. 6. *It was found that the spectra for various water velocities would superimpose if Q/V was held constant

where Q is the flow rate of the air in m^3/sec , and the same coordinates as on Fig. 5 were used. An air jet discharging into water through a 2 mm orifice produced bubbles whose diameter is given by the following relationship: $d = 3.16\sqrt{Q/V}$ (Silberman, 1957; Hughes et al., 1979). A constant Q/V would indicate a constant bubble size. That the spectra from various velocities will superimpose on these coordinates with a constant Q/V must be regarded as fortuitous. A possible explanation is that the constant Q/V provides a constant concentration of bubbles and that the bubbles, if introduced at the same diameter, are then sheared down in a distance l from the point of introduction to an observation point (SPT location) in proportion to the flow velocity. A similar suggestion to this has been made by Sleicher (1962) and is shown graphically by Fig. 7.

Further insight into the air bubble noise flow relationship can be seen from Fig. 8, which shows the bubble noise spectra at a constant water flow velocity with a range of air flow rates. The most identifiable feature of these curves is the "corner frequency" which is emphasized by superimposing two straight lines on the data points. These corner frequencies were converted into an equivalent bubble diameter based on the free natural frequency of bubbles in their fundamental mode of vibration. The equivalent bubble size for each "corner frequency" is shown on Fig. 9 along with a range of flow rates and the corresponding range of bubble sizes observed from photographs at the test section. Examination of the bubble size range shown compared to those expected for the corresponding $d = 3.16\sqrt{Q/V}$ meters is found to be much smaller than predicted. This observation tends to verify the idea that bubbles are sheared down to a much smaller size proportional in some way to the original size introduced into the flow. The air was introduced in Fig. 10 as far upstream in the water tunnel test section as possible (≈ 90 cm). The corner frequency in this case can be observed to change very little as the flow rate changes, indicating that the bubble sizes corresponding to a Q/V value are sheared down to an equilibrium size range. This is shown as a dotted line in Figs. 7, 9, and 10. No photographic measurement was made of the bubble size distribution for the last conditions.

Bubble spectra measurements were also made with a 1.27 cm diameter surface pressure transducer which was constructed by mounting a 3 mm transducer in a shallow liquid-filled chamber with a 1.27 cm lucite diaphragm. Some attenuation and some resonant response peaks were introduced by this procedure; however, the qualitative results shown are quite significant. The conclusions which can be drawn from Fig. 11 are that the bubble noise spectra are the same as with the 3 mm unit if the attenuation and resonant peaks are ignored. The surface pressure fluctuations are much attenuated, as expected, from the use of a larger diameter transducer (Corcos, 1963). This establishes that the bubble induced part of the noise spectra which is not affected by transducer size is a radiated noise, that the bubbles are responding to the flow pressure structure as evidenced by the correlation with flow parameters typical of surface pressure fluctuation, and that the bubble suspension causes little modification of the flow structure responsible for the generation of surface pressure fluctuations.

A high-pass filter with a pass-band above 5 KHz was incorporated into the noise measuring system. The bubble noise could be observed as a random distribution of pulses in time in which the peak amplitudes exceeded 140 decibels above a 1 micro-Pascal reference pressure. Detailed examination of the radiated pressure pulses showed them to be damped sinusoids, as would be expected from impulse excitation of an air bubble at their lowest resonant mode. The possibility is evident that the damped resonant size of these bubbles can be determined from the dominant frequency of the decaying pulse.

Further information was sought through the examination of the sound pulse from each of two identical pressure transducers for various separations from 3 mm to 5 cm, as displayed on a dual beam oscilloscope. The gain was set at each of a series of separations to give equal amplitude of the displayed pulses. From this, it was found that the pulse amplitude was reduced proportional to $1/r$, where r is the transducer separation distance. The velocity of propagation, as estimated from the time delay between pulses, equals that of sound in pure water. The reduction in amplitude versus distance indicated that the pulses of greatest amplitude were originating within 3 mm of the transducer.

Two photographic methods were used to determine how the bubbles were excited to emit sound pulses. The first assumed that splitting of the bubble from large to smaller would produce the pulse of sound. This pulse was made to trip a flash lamp to photograph the region of the transducers at the same instant of time. It was expected that a pair of bubbles would be found within a few mm of the transducer face which could be possible candidates for the source of the noise. Single bubbles were photographed sufficiently near the transducer to have been the source of the noise. The number of bubble pairs were so few that doubt began to arise with regard to splitting as the only source of bubble noise, although many bubble pairs were found in more remote points in the field. High speed motion pictures were then attempted (5000 frames/sec) with a superimposed trace of the sound pulse on the same film. Again, very few splitting events were observed which were close enough to the transducer to have been a likely source with the amplitude observed. However, no other unusual motion of the bubbles was observed, which might impart an impulse of excitation except possibly the impact of the bubble on the surface. A practical difficulty of this phenomena arises with high-speed motion pictures. If it is desired to reduce the number of bubbles in the photographic field sufficiently so that only a few will be near the transducer at any time so that significant bubbles can be identified, then the number of pulses per second are so few that an entire reel of film can be exposed with no sound pulse occurring.

DISCUSSION

The presence of air bubbles in a boundary layer has been established as an active source of radiated noise. The spectral intensity of the sound was found to be dependent on bubble concentration, and the radiated frequency is related to the size of the air bubbles in the layer.

The size of the bubbles in a layer is dependent on the size of the bubble introduced into the flow. If given sufficient time, however, they will reach an equilibrium size independent of bubble size larger than the equilibrium (Sevik and Park, 1973; Sleicher, 1962).

The radiated sound was observed to consist of damped sinusoids whose amplitudes are inversely proportional to the distance from source to observation point for a single bubble size. Pressure pulses such as these are typical of impulse excitation of second order resonant systems. If it is

assumed that the impulse pressure arrives at the transducer in a random manner, as for example the impact noise of rain drops on a surface, then the expected spectrum can be written (Bendat, 1958),

$$S(\omega) = \bar{n} G(\omega) \quad (1)$$

where \bar{n} is the average number of impulses arriving per unit time and $G(\omega)$ is the Fourier transform of a typical single event of the pressure wave arriving at the transducer when frequencies below 5 KHz are filtered out.

The analytic form chosen for $G(\omega)$ for an exponentially damped sinusoid (Bendat, 1958) is

$$G(\omega) = \frac{K}{\left(1 - \frac{\omega^2}{\omega_o^2}\right)^2 + \frac{4b^2}{\omega_o^2} \left(\frac{\omega}{\omega_o}\right)^2} \quad (2)$$

where K is a constant depending on amplitude,

$\omega = 2\pi \times$ frequency f in Hertz,

$\omega_o =$ the undamped natural frequency of the air bubble in radians/sec,

and $b =$ a constant related to the damping of the bubble oscillation τ .

The measured value of τf ranged between 3-10 when substituted in the above relationship for $G(\omega)$ giving a peaked spectra whose maxima correspond to the corner frequency. The actual measured spectra shown on the figures are a result of averaging over a range of bubble size and frequencies. In mean terms, bubble size would appear as a broad band or highly damped system.

The location point of the bubble excitation region is necessary in order to specify concentration and possible magnitude of the impulse. If as proposed by Fitzpatrick and Strasberg (1969) that bubble splitting is the predominant source of impulsion force thereby causing the observed oscillation of the air bubble, then the most likely region of the splitting of the bubble would be in a region of the boundary layer of greatest kinetic energy dissipation (Sevik and Park, 1973). The greatest kinetic energy dissipation occurs very close to the boundary surface. High speed motion picture observations of the air bubbles and the corresponding

sound pulse did not show recognizable associated splitting events. This might mean that the bubble size is below the splitting threshold (Sevik and Park, 1973); however, the bubble is deformed never-the-less by the same mechanism which would have split a larger bubble. Alternatively, the bubbles are impulsively deformed by their impact on the boundary layer wall. Since only a fraction of the bubbles located in the boundary layer are expected to participate in the noise production, absolute value of concentration based on the air concentration in the entire layer is only of limited usefulness. A simple series of experiments in which the air was injected into the flow at various distances from the wall could have given some insight into the bubble excitation region.

REFERENCES

- Bendat, J. S. (1958). *Principles and Application of Random Noise Theory*, John Wiley & Sons, Inc., pp. 191-197.
- Cain, Paul (1975). Private communication from thesis, Department of Civil Engineering, University of Canterbury, New Zealand.
- Cliff, R., Grace, J., Weber, M. (1978). *Bubble Drops and Particles*, Academic Press, Inc.
- Corcos, G. M. (1963). "Resolution of Pressure in Turbulence," Jour. Acoustical Soc. of America, 35(2), p. 192.
- Crighton, D. G. and Efwowcs-Williams, J. E. (1969). "Sound Generation by Turbulent Two-Phase Flow," Jour. Fluid Mechanics, 36:3, pp. 585-603.
- Fitzpatrick, H. M. and Strasberg, M. (1959). "Hydrodynamic Sources of Sound," DTMB Report 1269.
- Franklin, R. E. and McMillan, J. (1976). "Wall Pressure Fluctuations in a Bubble Flow," Report No. 1157/76, Dept. of Engineering Science, University of Oxford.
- Hughes, N. H., Reischman, Holzman, J. M. (1979). "Digital Image Analysis of Two-Phase Flow Data," Sixth Biennial Symposium on Turbulence, Dept. of Chemical Engineering, University of Missouri, Rolla.
- James, W. and Silberman, E. (1958). "Two Phase Flow Studies in Horizontal Pipes with Special References to Bubbly Mixtures," University of Minnesota, St. Anthony Falls Hydraulic Laboratory, Technical Paper 26-B.
- Junger, M. and Cole, J. (1980). "Bubbly Swarm Acoustics: Insertion Loss of a Layer on a Plate," Jour. Acoustical Society of America, 68(1), pp. 241-247.
- Killen, J. and Wetzal, J. (1981). "An Evolution of the Effect of Air Ingestion on the Performance of a Centrifugal Pump," University of Minnesota, St. Anthony Falls Hydraulic Laboratory, Project Report No. 201.
- Kuhl, W., Meyer, E., Oberst, H., Skudryzk, E., and Tamm, K. (1947). "Sound Absorption and Sound Absorbers in Water," Bureau of Ships, Translation, pp. 140.

- Nisewanger, C. R. and Sperling, F. B. (1965). "Flow Noise Inside Boundary Layer of Buoyancy Propelled Vehicles," U. S. Naval Ordnance Test Station, Report No. 8519.
- Mallock, A. (1910). "The Damping of Sound by Frothy Liquid," Proc. Royal Soc., London, H84, p. 391.
- Minnaert, M. (1933). "Musical Air Bubbles and the Sounds of Running Water," Philosophical Magazine, Vol. 16, pp. 235-248.
- Peterka, A. J. (1953). "The Effect of Entrained Air on Cavitation Pitting," Proc. Minnesota Int'l Hydraulic Convention, IAHR, P. 504.
- Schlichting, H. (1979). *Boundary Layer Theory*, 7th Edition, McGraw Hill Book Co., p. 644.
- Sevik, M. and Park, S. H. (1973). "The Splitting of Drops and Bubbles by Turbulent Fluid Flow," Journal Fluids Engineering, ASME, pp. 53-60.
- Silberman, E. (1957). "Production of Bubbles by the Disintegration of Gas Jets in Liquids," Fifth Midwestern Conf. on Fluid Mechanics, University of Michigan.
- Silberman, E., (1978). "An Experimental Investigation of the Effect of Drag Reducing Polymer Additives on Surface Pressure Fluctuations on Bodies of Revolution with Rough Surfaces," University of Minnesota, St. Anthony Falls Hydraulic Laboratory, Project Report No. 172.
- Sleicher, C.A. (1962). "Maximum Stable Drop Size in Turbulent Flow," Jour. A.I.Ch.E., Vol. 8, No. 4, pp. 471-477.
- Stefan, H., Anderson, A. G. (1964). "Cavity Formation and Associated Drag in a Supercavitating Flow over Wedges in a Boundary Layer," University of Minnesota, St. Anthony Falls Hydraulic Laboratory, Project Report No. 69.
- Strasberg, M. (1956). "Gas Bubbles as Sources of Sound in Liquids," Jour. Acoustical Soc. of America, Vol. 28, No. 1, pp. 20-26.

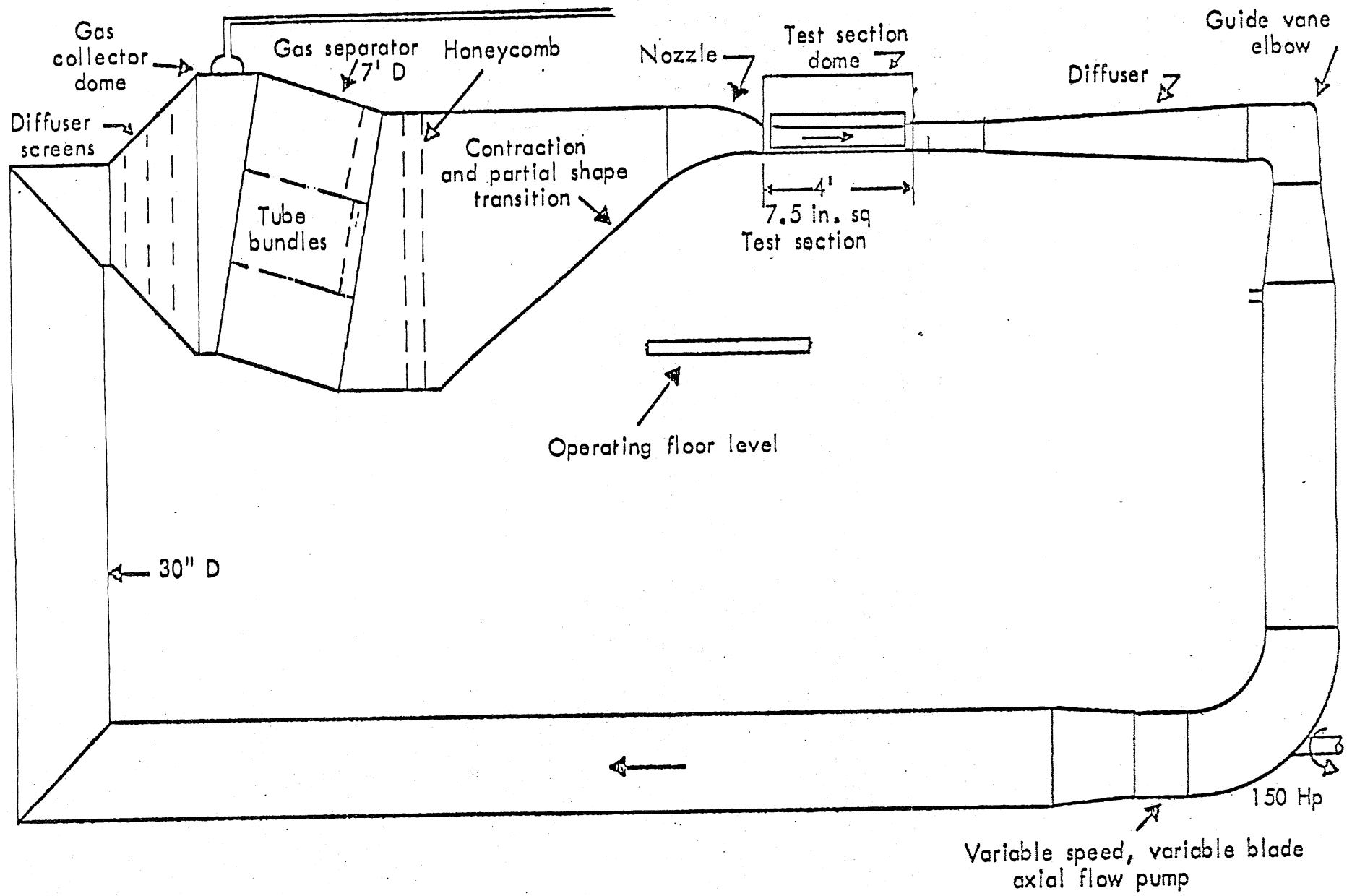

Fig. 1. Schematic of High Speed, Variable Pressure, Water Tunnel.

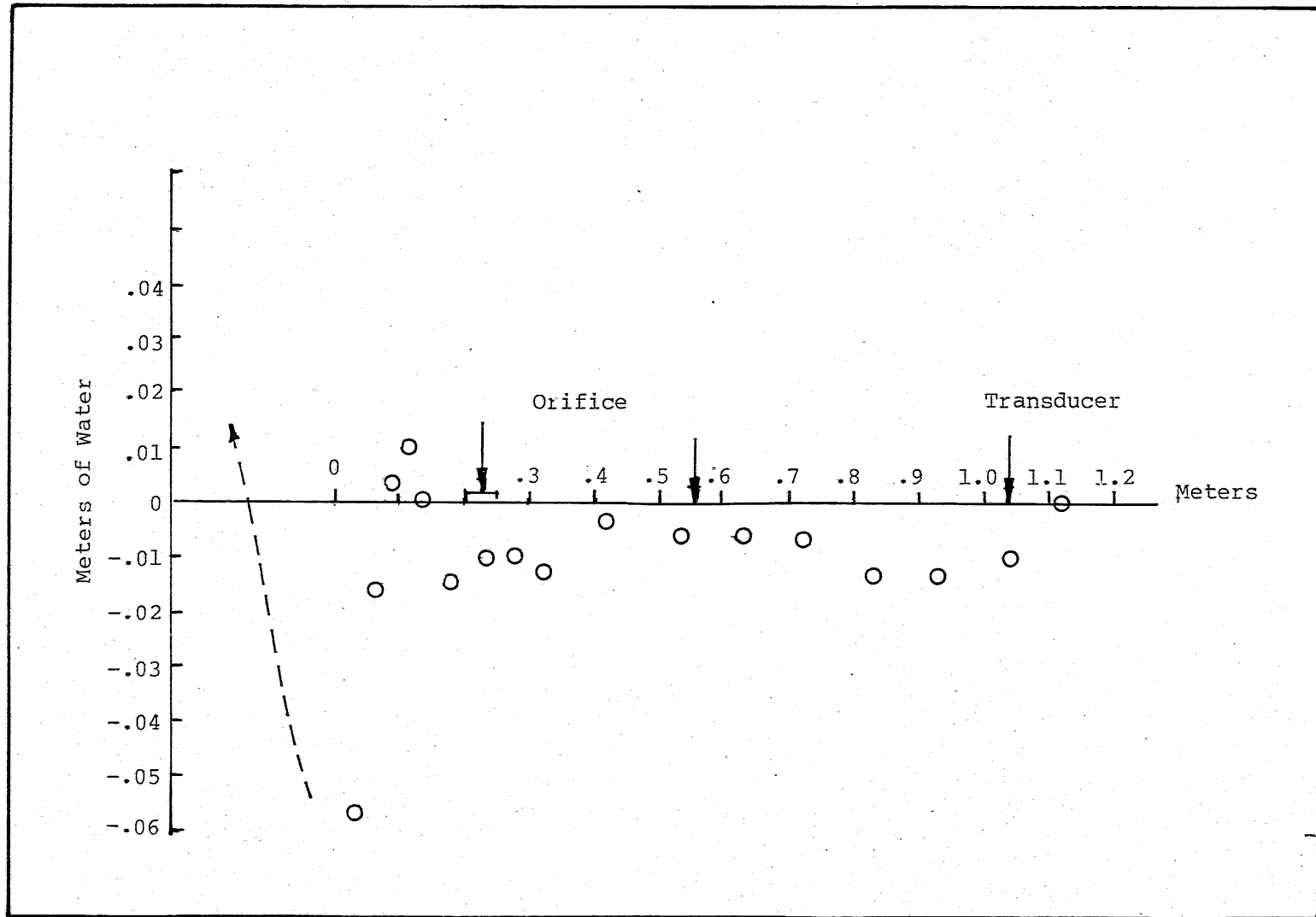

Fig. 2. Pressure Distribution on Water Tunnel Test Section Upper Surface.

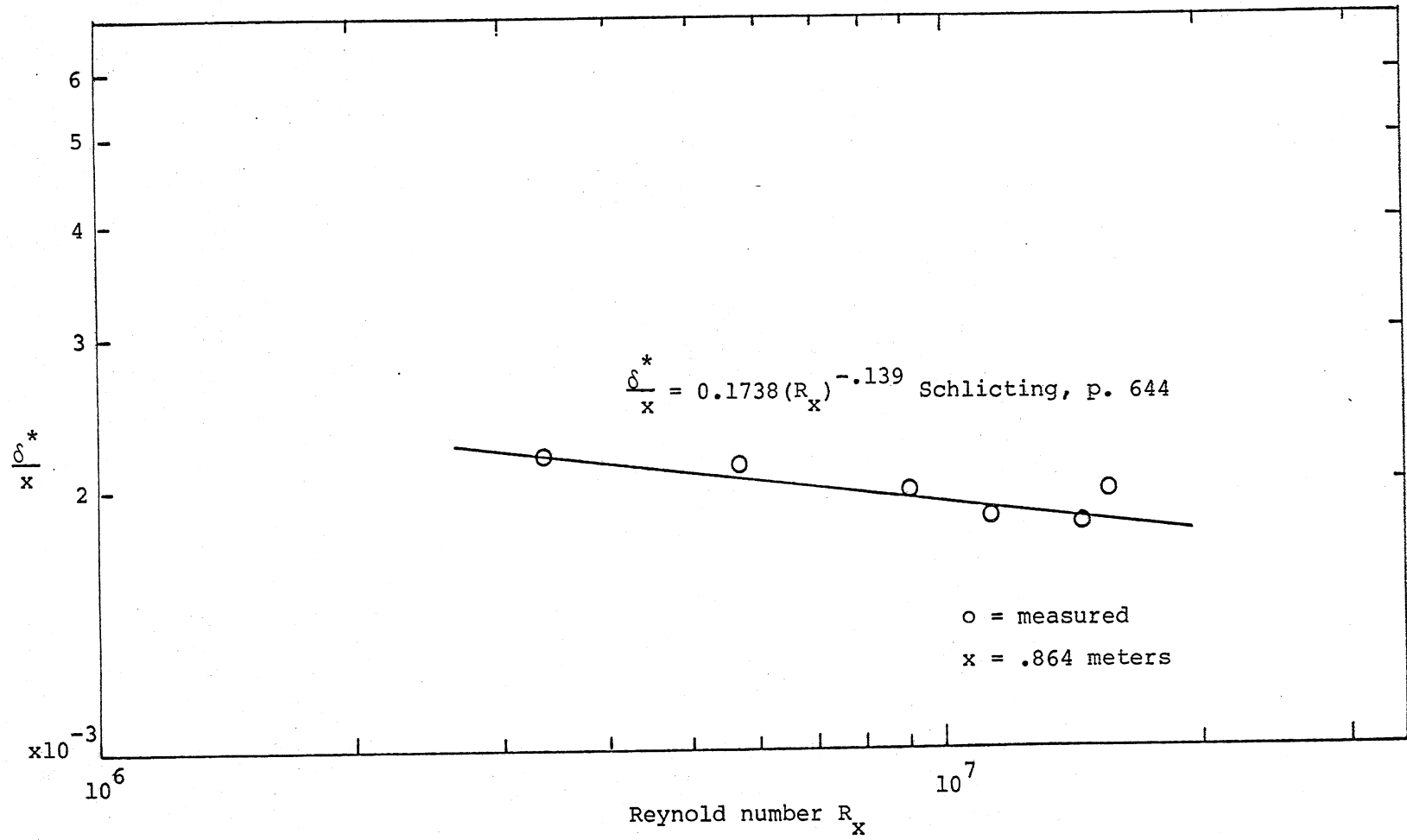

Fig. 3. Boundary Layer Displacement Thickness.

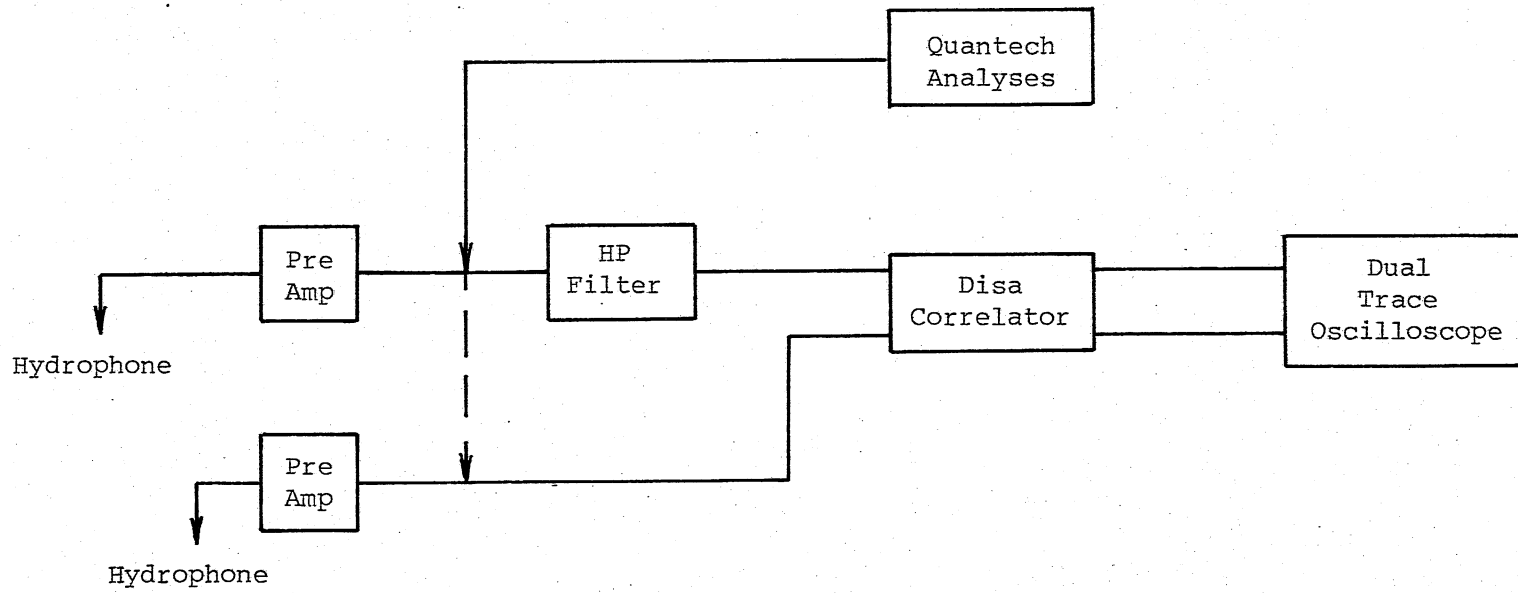

Fig. 4. Data Processing Equipment.

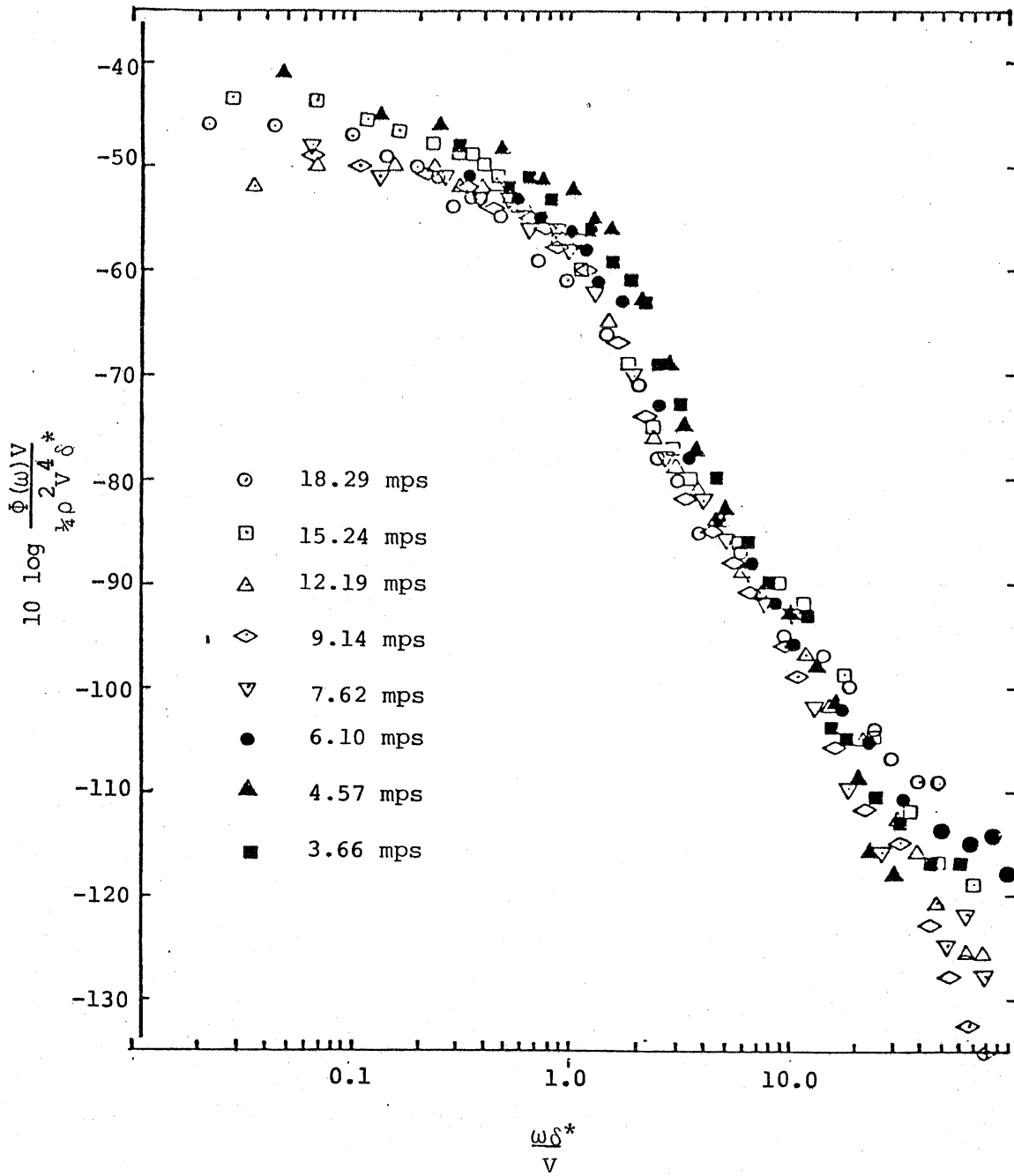

Fig. 5. Surface Pressure Fluctuation.

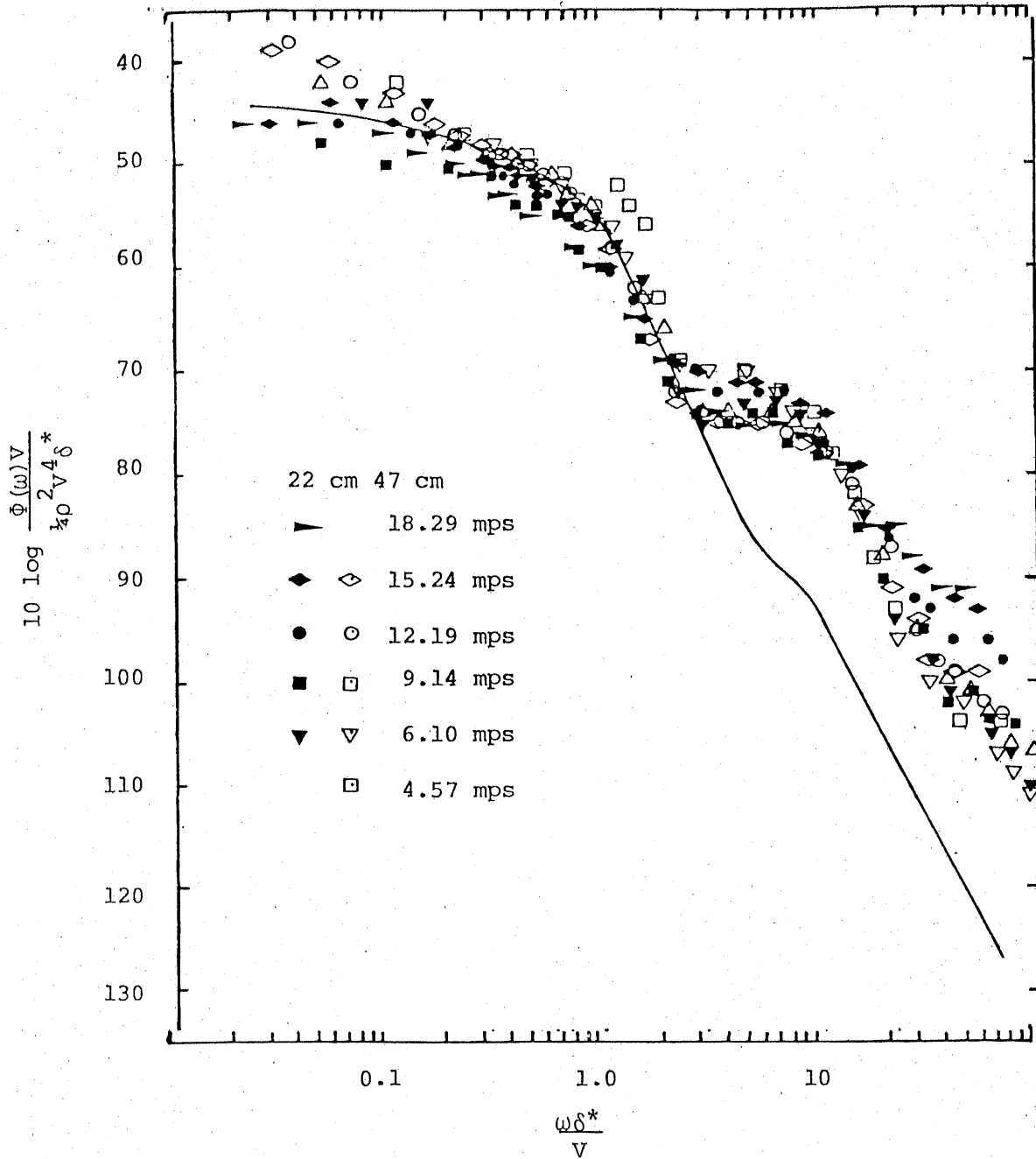

Fig. 6. Surface Pressure Spectra with an Air Bubble Layer Q/V Constant.

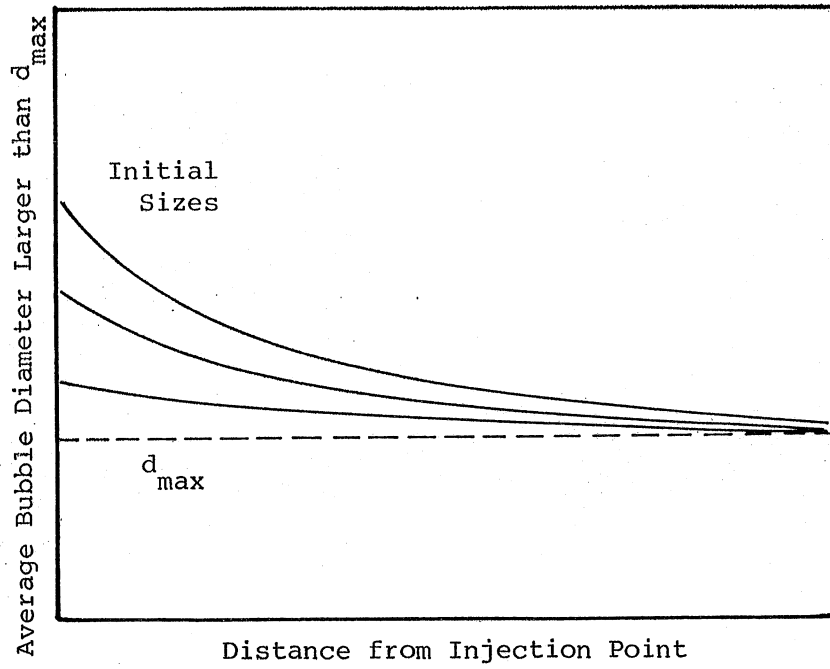

Fig. 7. Conceptual Change of Bubble Size with Distance at a Given Velocity.

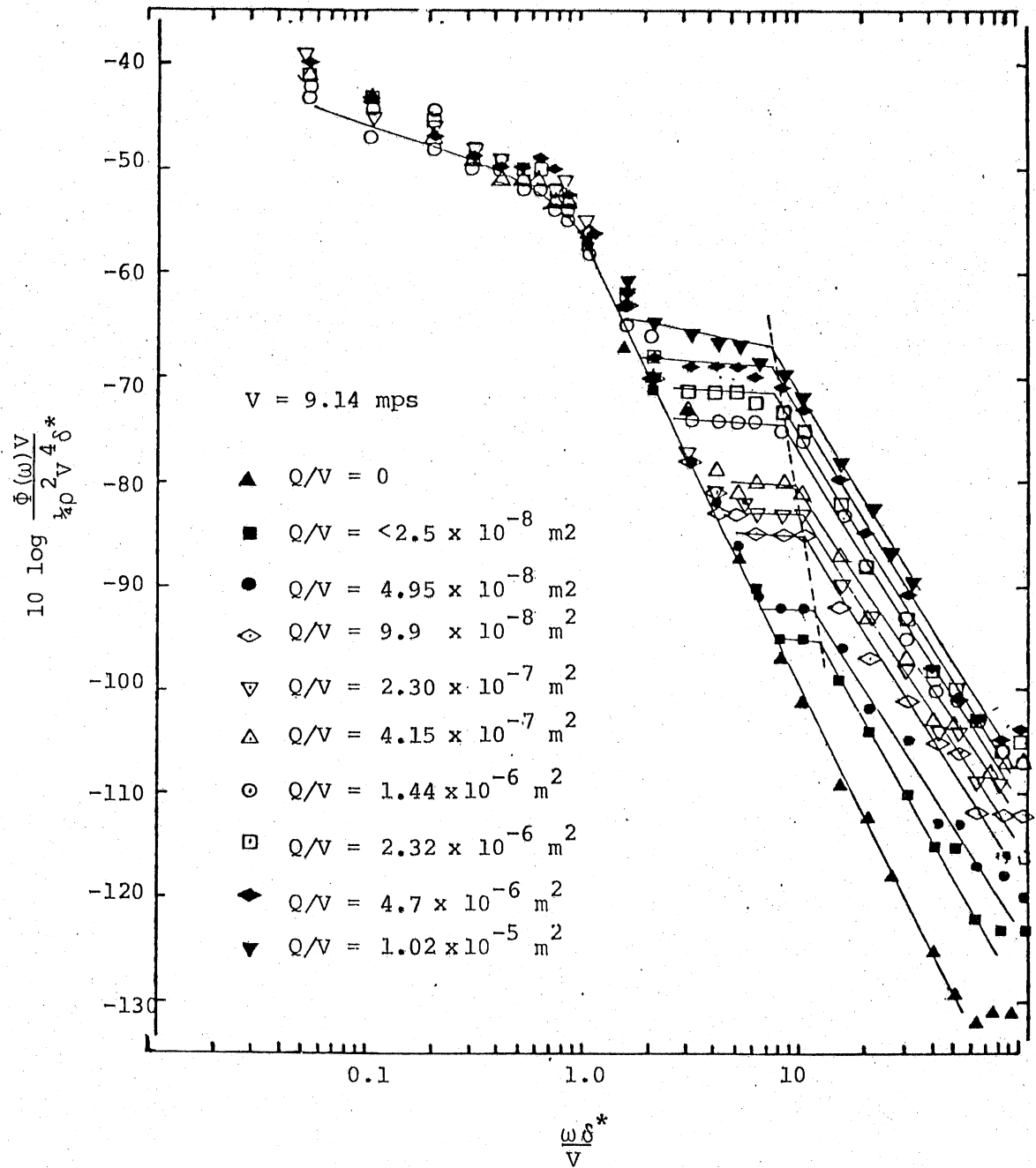

Fig. 8. Air Bubble Noise Spectra for a Range of Air Flow Rates Velocity Constant.

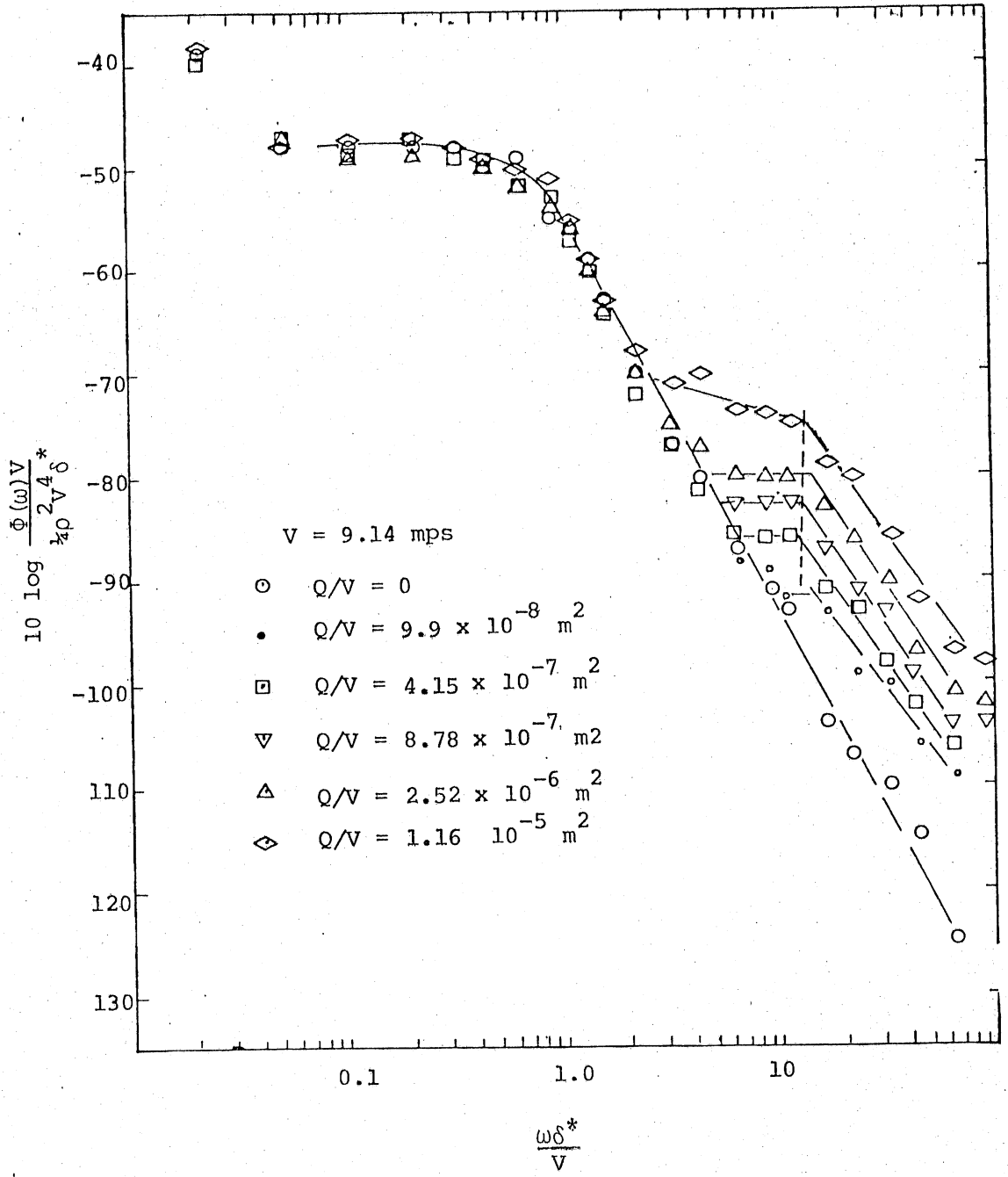

Fig. 10. Bubble Noise Spectra. Air Injected 92 cm Upstream of the Transducer.

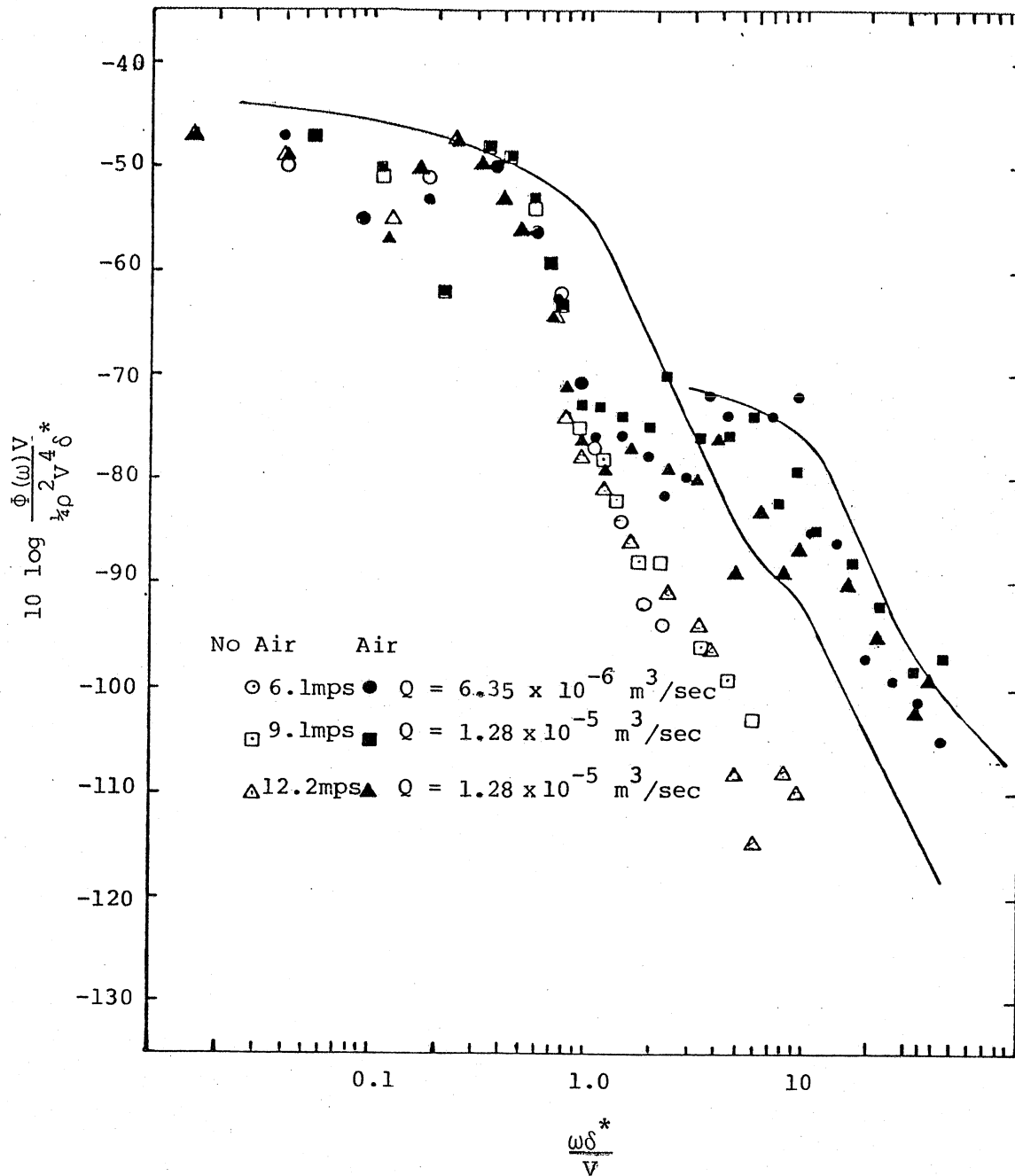

Fig. 11. Bubble Noise Spectra With a Chamber Mounted Pressure Transducer.

10

11

12

13

14