

EDITORIAL COPY

UNIVERSITY OF MINNESOTA
ST. ANTHONY FALLS HYDRAULIC LABORATORY
LORENZ G. STRAUB, Director

Technical Paper No. 35, Series B

MODEL STUDIES OF STORM-SEWER DROP SHAFTS

by

SIGURD H. ANDERSON

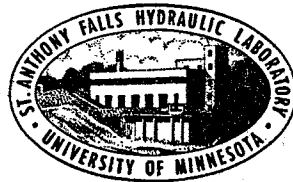

Prepared for
DEPARTMENT OF PUBLIC WORKS
City of St. Paul

December 1961
Minneapolis, Minnesota

UNIVERSITY OF MINNESOTA
ST. ANTHONY FALLS HYDRAULIC LABORATORY
LORENZ G. STRAUB, Director

Technical Paper No. 35, Series B

MODEL STUDIES OF STORM-SEWER DROP SHAFTS

by

SIGURD H. ANDERSON

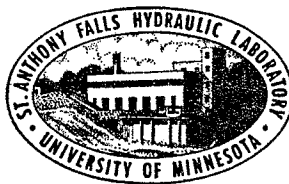

Prepared for
DEPARTMENT OF PUBLIC WORKS
City of St. Paul

December 1961
Minneapolis, Minnesota

Reproduction in whole or in part is permitted
for any purpose of the United States Government

P R E F A C E

The Department of Public Works of the City of St. Paul, Minnesota, sponsored the work herein reported. Mr. George Shepard, Engineering Co-ordinator, gave general direction to the program. Other Public Works Department staff members concerned with the development were the late Arthur W. Tews, Chief Engineer; Eugene Avery, present Chief Engineer; John Holmboe; and John Des Lauriers.

This study was conducted at the St. Anthony Falls Hydraulic Laboratory of the University of Minnesota, under the general direction of Dr. Lorenz G. Straub, Director. Mr. C. E. Bowers of the Laboratory staff guided the initial phases of the model study program and reviewed the several reports issued. W. W. Parmenter performed many of the model tests and photographed many of the models.

A B S T R A C T

A long-range program of storm-sewer construction prompted the Department of Public Works of the City of St. Paul, Minnesota, to develop an improved design for high-head drop shafts. Past designs required frequent inspection and maintenance at the base of the shaft to prevent failure of the structure. Preliminary model tests indicated that destructive forces of the falling water were primarily responsible for the damage to the base of the shaft. An experimental study led to the development of an impact-type of energy dissipator which removed excess energy from the flow and created stable outflow conditions, with a minimum air entrainment.

C O N T E N T S

	Page
Preface	iii
Abstract	iv
List of Illustrations	vii
I. INTRODUCTION	1
II. STATEMENT OF THE PROBLEM	1
III. REVIEW OF PAST WORK	3
A. Well Hole	3
B. Cascades	3
C. Backdrops	4
D. Energy-Dissipating Structures	4
IV. LABORATORY INVESTIGATION PROGRAM	5
V. DESCRIPTION OF THE MODELS	7
VI. DEVELOPMENT OF BASIC DESIGN	8
A. Inlets	8
B. Elbow Inlet	9
C. Straight Drop Shafts	10
D. Modified Drop Shafts	10
1. Straight Shaft with Contraction	10
2. Taper Shaft	11
3. Radius Elbow	11
E. Sump Chamber	12
1. Preliminary Design	12
2. Variable-Model Sump	13
F. Sump Design	15
1. Diameter of Impact Cup	15
2. Impact Pressures	16
3. Location	16
4. Cup Sidewall	16
5. Baffle Slab	17
6. Sump Diameter	17
7. Vents	18
VII. DEVELOPMENT OF FINAL DESIGN	18
A. Series 11	19
B. Series 12	20
C. Series 13	20
D. Series 14	20
E. Series 15	20
F. Series 17	21
G. Series 18	21
H. Series 19	21
I. Series 20	21
J. Series 21	22
K. Series 22	22

	Page
VIII. SUMMARY.	22
List of References.	24
Figures 1 through 54.	27
Appendix	
I. REVIEW OF "FLOW IN VERTICAL SHAFTS"	57
A. Models.	57
B. Model Tests	57
1. Shaft Entrance.	57
2. Spiral (Vortex) Entrance (Unflooded Shaft).	57
3. Vortex-Type Entrance.	58
4. Stilling Chamber.	58
5. Air Entrainment	58
C. Comments on Vortex Inlet.	59
II. REVIEW OF "VORTEX FLOW THROUGH HORIZONTAL ORIFICES"	59
Figures A-1 through A-3	61

L I S T O F I L L U S T R A T I O N S

Figure		Page
1	Well Hole at St. Paul	27
2	Well Hole, Minneapolis.	27
3	Well Hole, Cleveland.	27
4	Flight Sewer, Philadelphia.	28
5	Cascade for Water	28
6	Backdrop.	28
7	Typical Sumps Used for Air Removal and Energy Dissipation in French Water Power Collecting Systems	29
8	Typical Sumps Used for Air Removal and Energy Dissipation in French Water Power Collecting Systems	29
9	Typical Sumps Used for Air Removal and Energy Dissipation in French Water Power Collecting Systems	29
10	Typical Sumps Used for Air Removal and Energy Dissipation in French Water Power Collecting Systems	29
11	Drop Shaft Design Based on Preliminary Model Studies.	30
12	Rectangular Sump, 22 ft Wide, 30 ft Long and 40 ft Deep. Jet Penetrates to Bottom of Sump. Discharge 600 cfs.	31
13	Rectangular Sump (20 ft Deep) With Perforated Impact Plate 4 ft Below End of Drop Shaft. Discharge 600 cfs.	31
14	Rectangular Sump 22 ft by 15 ft and 20 ft Deep, with Solid Wall Impact Cup 9 ft in Diameter. Discharge 600 cfs.	31
15	Rectangular Sump, 22 ft by 15 ft and 20 ft Deep, with Perforated Impact Cup. Discharge 600 cfs.	31
16	Circular Sump with Perforated Impact Cup. Sump Diameter 18 ft	32
17	Vortex Type Inlet 16 ft in Diameter with 8-ft Drop Shaft and Deep Water Cushion. Discharge 600 cfs.	32
18	Vortex Inlet 22 ft in Diameter. Depth in Chamber Greatly Increased as Compared with Fig. 17. Discharge 600 cfs.	32
19	Vortex Inlet 22 ft in Diameter. Discharge 300 cfs.	32
20	Eight-ft Diameter Shaft with Elbow Inlet and Deep Sump. Discharge 600 cfs. High Ratio of Air to Water in Interceptor Tunnel	33
21	Elbow Inlet with Deep Water Cushion. Discharge 900 cfs	33
22	Elbow Inlet, 8 ft Diameter Shaft with 16 ft Diameter Sump. Impact Cup in Low Position. Discharge 600 cfs.	33
23	Circular Sump and Perforated Impact Cup with Discharge Conduit at Base of Chamber. Discharge 600 cfs.	33

Figure		Page
24	Circular Sumps and Perforated Impact Cup with Restriction in Drop Shaft at the Top of Sump. Diameter of Sump 16 ft. Discharge 600 cfs.	34
25	Vortex Inlet and Tapered Shaft. Vortex Extends to Base of Shaft. Discharge 300 cfs.	34
26	Vortex Inlet and Tapered Shaft. Discharge Increased to 450 cfs With Large Increase in Head at Inlet.	34
27	Drop Shaft With 1-1/2 D Radius Elbow at Base. Unsteady Flow in Discharge Conduit. Discharge 600 cfs	34
28	Drop Shaft with 1-1/2 D Radius Elbow. Energy Dissipating Sill Placed in Discharge Conduit. Discharge 300 cfs.	35
29	Drop Shaft with 1-1/2 D Radius Elbow. Energy Dissipating Sill Placed in Discharge Conduit. Discharge 600 cfs.	35
30	Drop Shaft Without Water Cushion. High Air-Water Ratio in Discharge Conduit. Discharge 600 cfs	35
31	Drop Shaft with Deep Water Cushion. Air-Water Ratio Similar to Fig. 30. Discharge 900 cfs.	35
32	Rectangular Sump 22 ft by 15 ft by 20 ft Deep, With Inclined Baffle on Right Side.	36
33	Circular Sump and Impact Cup and Curved Baffle Open at Top and Bottom. Discharge 600 cfs.	36
34	Circular Sump and Impact Cup With Curved Baffle Open at Bottom Only. Discharge 600 cfs	36
35	Circular Sump (18 ft in Diameter) With Perforated Impact Cup. Baffle Open Top and Bottom. Discharge Conduit at Base of Sump. Discharge 600 cfs.	36
36	Pressures on Perforated Cup Sidewall.	37
37	Air-Water Discharge from Sump Chamber	37
38	Series 11. Straight Drop Shaft with Water Cushion Sump. Scale 1:24. Drop 100 ft.	38
39	Series 12. Drop Shaft with 16-ft Diameter Circular Sump and Perforated Impact Cup Based on Preliminary Design as Shown in Fig. 11. Scale 1:24. Drop 100 ft	39
40	Series 13. Drop Shaft with 16-ft Diameter Circular Sump and Perforated Impact Cup with Extended Discharge Chamber. Scale 1:24. Drop 100 ft.	40
41	Series 14. Drop Shaft with 23-ft Diameter Circular Sump and Perforated Impact Cup and Short Discharge Chamber. Scale 1:24. Drop 100 ft.	41
42	Series 15. Drop Shaft with 23-ft Diameter Circular Sump and Perforated Impact Cup. Discharge Conduit Increased from 8 ft to 11 ft in Diameter. Scale 1:24. Drop 100 ft.	42

Figure		Page
43	Series 17. Drop Shaft with 23-ft Circular Sump and Perforated Impact Cup. Sloping Roof Discharge Chamber. Scale 1:24. Drop 100 ft.	43
44	Series 18. Drop Shaft with 19-1/2-ft Diameter Circular Sump and Perforated Impact Cup. Sloping Roof Discharge Chamber. Scale 1:24. Drop 100 ft.	44
45	Series 19. Drop Shaft with 16-ft Diameter Circular Sump and Perforated Impact Cup. Sloping Roof Discharge Chamber. Scale 1:24. Drop 100 ft.	45
46	Series 20. Normal Grade Line. Recommended Design with 23-ft Diameter Sump and Perforated Impact Cup. Scale 1:24. Drop 100 ft	46
47	Series 20. Grade Line 30 ft. Recommended Design with 23-ft Diameter Sump and Perforated Impact Cup. Drop 100 ft. Scale 1:24.	47
48	Series 20. Grade Line 50 ft. Recommended Design with 23-ft Diameter Sump and Perforated Impact Cup. Drop 100 ft. Scale 1:24.	48
49	Series 21. Normal Grade Line. Recommended Design with 23-ft Diameter Sump and Perforated Impact Cup. Drop 135 ft. Scale 1:24.	49
50	Series 21. Grade Line 40 ft. Recommended Design with 23-ft Diameter Sump and Perforated Impact Cup. Drop 135 ft. Scale 1:24.	50
51	Series 21. Grade Line 60 ft. Recommended Design with 23-ft Diameter Sump and Perforated Impact Cup. Drop 135 ft. Scale 1:24.	51
52	Series 22. Normal Grade Line. Recommended Design with 23-ft Diameter Sump and Perforated Impact Cup. Drop 62 ft. Scale 1:24.	52
53	Series 22. Grade Line 20 ft. Recommended Design with 23-ft Diameter Sump and Perforated Impact Cup. Drop 62 ft. Scale 1:24.	53
54	Series 22. Grade Line 30 ft. Recommended Design with 23-ft Diameter Sump and Perforated Impact Cup. Drop 62 ft . . .	54

M O D E L S T U D I E S O F S T O R M - S E W E R D R O P S H A F T S

I. INTRODUCTION

Through the increased urban development and growth of freeways within urban limits has come a need for more soundly designed storm-water disposal systems. In heavily populated areas with many demands on available space the surface runoff must be removed by underground networks of conduits or tunnels.

Final disposal elevations of the drainage system usually determine the depth of the subterranean network. It is not unusual for outlet conditions to require tunnels to be located 100 ft or more below the surface. Conductance of surface discharges to the underground interceptors has been of necessity, for space and economic reasons, by means of vertical drop shafts. These shafts have been constructed in many forms, largely by "rule of thumb" methods, and due to their unobservable locations little is known of their hydraulic behavior.

Many structures in use for a number of years have shown deterioration and damage--either because of faulty construction or improper consideration of the high amounts of kinetic energy derived from the free fall of water through large vertical distances.

The Department of Public Works of the City of St. Paul, Minnesota, presently engaged in a program of enlarging their storm-sewer system, has found it desirable to develop a drop-shaft design which will reduce the possibility of impact damage to the structure and also insure stable flow conditions in the underground interceptors. Through their sponsorship a program of study of the hydraulic action of large drop-shaft structures was undertaken at the St. Anthony Falls Hydraulic Laboratory of the University of Minnesota. By means of hydraulic model studies a number of past design types were investigated, after which a development study to design an efficient energy-dissipating type of structure was carried out.

II. STATEMENT OF THE PROBLEM

The hydraulic design of a drop structure must consider the following factors:

- (1) Capacity of the inlet and drop shaft
- (2) Energy dissipation after the drop
- (3) De-aeration of the flow and venting of the system
- (4) Stability of the outflow
- (5) Loads applied by hydraulic forces
- (6) Odor prevention or septic action

Of foremost importance is the problem of dissipation of kinetic energy of the water falling down the drop shaft. Damage to the lower end of the drop shaft is largely due to the high impact forces acting on the surfaces at the bottom of the shaft. Unless these forces can be absorbed or reduced by scattering over a larger area, severe wearing by impact and erosion is likely to occur on even the hardest surfaces.

Inlet capacity of the shaft is of lesser importance and generally adequate if the shaft area is equal in area to the surface interceptor. A 90-degree straight or rounded intersection of the upper conduit with the drop shaft may be used with assurance that a drop shaft of equal diameter will be sufficient to carry the maximum open-channel flow of the upper interceptor.

If it is desirable to limit the discharge of the drop shaft, an inlet of the vortex-chamber type will give good control for this purpose. This type of inlet limits the flow through action of the vortex, and discharges above the system's capacity are by-passed by an overflow weir.

Stability of the flow and discharge section of the drop-shaft chamber is of major importance for the following reasons. Uncontrolled discharge from the sump chamber without de-energization of the flow results in large-scale surges within the lower conduit system. This surging combined with the entrainment of large amounts of air will affect the operation of other drop shafts located downstream. Entrained air will accumulate in the lower interceptor and either blow downstream when excess pressure is reached or vent back through the originating drop shaft. Uncontrolled discharges may also result in high maintenance costs through action of large hydraulic forces occurring at unsuspected locations.

The sump type of drop shaft, while appearing to offer a simple solution of energy dissipation, has the disadvantage of creating a septic body of water at the bottom of the shaft during periods of low or intermittent flow. Offensive odors resulting from these installations are certainly to be avoided in populous districts.

III. REVIEW OF PAST WORK

Over a period of years many types of drop structures have been built for the disposal of sewage and storm-runoff water. These structures can be divided into three main types. The well hole consisting of a vertical shaft leading to an underground interceptor line is probably the most common type in use. A second type of drop is a system of steps or cascades by which the sewage flows down a number of small drops, each step being in effect a stilling pool. A third type is the backdrop, which is a drop shaft located outside of a manhole. Discharge enters at the base of the manhole.

A. Well Hole

The well hole may assume several shapes and can be subdivided into three component parts: the inlet area at the top of the shaft, the drop shaft, and the outlet or sump chamber.

The inlet of the drop shaft may be designed to pass a maximum quantity to the drop shaft, or it may be used as a flow-limiting device to limit the discharge to the interceptor when it becomes necessary not to overburden a sewage treatment plant during periods of high runoff.

Well hole drop shafts have been designed with a uniform diameter, tapered diameter, and with a number of restrictive projections extending out from the walls and intended to dissipate the energy of the falling water (Figs. 1, 2 and 3) [1, 2]*. Most shafts were no doubt overdesigned as to capacity due to a lack of understanding of the hydraulics of the structure. It is questionable whether most shafts ever experienced full pipe flow. In most cases the storm discharge occupies only a fraction of the area of the drop shaft.

The sump or discharge section of the drop shaft often takes the shape of a pit or well at the bottom of the shaft with a pool of water extending some distance below the lower interceptor line. The purpose of this pool or well is to absorb the excess energy of the free fall.

B. Cascades

The step or cascade drop is another method of conveying sewage to underground conduits. It consists of a number of steps which may be level or

*Numbers in brackets refer to the List of References on p. 24.

inclined opposite to the direction of flow, each step being in effect a stilling pool. The disadvantages of this design are that it is difficult to design for operation over a wide range of discharge due to the possibility of the pool being "washed out" by high rates of flow; high drops require long slopes or the alternative of spiraling the flow around a central shaft; and during the periods of low rates of flow the individual pools become ponds of stagnant sewage which generate objectionable odors (Figs. 4 and 5) [2, 3].

C. Backdrops

The backdrop type of structure has a main shaft or manhole with an auxiliary shaft located outside the manhole. The auxiliary shaft conveys the discharge to the bottom of the manhole as a sump or stilling basin. This type of structure is limited to relatively small installations and is not of great importance. The auxiliary shaft would have the same disadvantages as a straight drop shaft (Fig. 6) [3].

D. Energy-Dissipating Structures

During the exploratory model study program information concerning a more recent innovation of energy dissipation was found in the work of several investigators in other parts of the world [4, 5]. In France drop shafts have been used in conjunction with underground networks of tunnels conveying water to power plants in mountainous areas. Runoff from small watersheds is collected and carried to the gathering system by shafts driven, in most cases, through several hundred feet of rock. Water falling great distances, such as these, entrains large amounts of air which must be removed so that the turbine operation will not be disturbed.

A number of methods of handling this problem were developed, the choice being determined largely by the local situation and the economic feasibility. Inclined drop shafts, which are in effect steep, open channels, were one method used. Keeping the lower end of the shaft flooded permitted de-aeration of the flow in the lower portion of the shaft. Venting of the inclined shaft was accomplished without interference by the falling water (Fig. 8) [4].

Underground side chambers or galleries equipped with baffles and vent pipes leading to the surface were another method used in dealing with the de-aeration problem. In this instance air removal took place under pressure (Fig. 7) [4].

A third scheme used was the suppression of air entrainment by preventing the water from falling in air, either by use of a siphon or by float-controlled inlet or through a shaft completely under pressure at all times (Fig. 8) [4].

A fourth device and one which parallels the work in this study eliminates the air in the falling water by de-energizing the flow by means of impact on a rigid surface, followed by a reduction of velocity sufficient to eliminate penetration of air into the outflow. This is accomplished by either a flat table-like surface or cup-shaped unit either submerged or above the level of the outflow. The "impact cup" is surrounded by a solid wall sump chamber with a minimum diameter several times the drop-shaft diameter. Reduction of excess energy is obtained and velocities reduced sufficiently so that bubble rise can be accomplished before the discharge reaches the outflow section of the chamber (Figs. 9 and 10) [4].

The above methods are cited here not for their importance as de-aerating devices but because they have demonstrated an important approach to the problem of energy dissipation at the base of a vertical shaft. The ability of a structure to remove entrained air at the base of a drop shaft is a good measure of its value as a de-energizing chamber.

IV. LABORATORY INVESTIGATION PROGRAM

A preliminary investigation of drop-shaft designs was made, guided by the review of past work. The principal designs appearing in literature were briefly studied by means of a small-scale hydraulic model. These experiments, though simply done, gave a better understanding of the basic problems involved. A model constructed of transparent plastic materials made possible observations of the various sections of the drop structure. The model had a fixed upper interceptor and a fixed lower interceptor. The inlet, drop shaft, and sump chamber were designed for easy alteration and had simple connecting joints sealed by standard O-rings.

Features such as the vortex inlet, stepped shaft, tapered shaft, water cushion, sump, and radius elbow were readily observed and compared.

These exploratory observations preceded development of the impact-type energy-dissipating chamber. The first tests involved a relatively deep

sump chamber of large cross-sectional area. This was done to establish the active area surrounding the falling water.

The deep sump or water cushion was easily penetrated by the force of the jet and indicated that the water cushion above was not an effective means of energy dissipation unless the surrounding pool was large in relation to the shaft diameter and the point of outflow located at a distance from the jet impingement area (Fig. 12). By experimentation it was found that a perforated plate placed horizontally a short distance below the termination of the drop pipe was quite effective in limiting the penetration of the jet (Fig. 13). With this primary interfering surface the depth of the water cushion could be greatly reduced; however, such a surface completely covering the cross section of the chamber is not practical since it is subject to plugging and excessive restriction of the flow area.

To provide an interfering surface and not wholly restrict the flow area, the perforated plate idea was modified and led to the substitution of a solid-wall circular cup slightly larger than the diameter of the drop shaft (Fig. 14). Following this improvement, perforated sidewalls were added to the horizontal plate forming a cup-like unit (Fig. 15). With addition of a vertical baffle wall, which forced the outflow to the lower part of the chamber, and vent pipes leading to the top of the shaft, a generalized design for an energy-dissipating and de-aerating chamber was obtained. Consideration of the proper shape for a sump chamber led logically to the circular form which was more adaptable for both hydraulic and construction purposes (Fig. 16).

Restriction of the drop shaft to create a column of nonaerated water for purposes of air removal was also studied. However, since the rate of discharge through the system would vary, it would be difficult to maintain stable levels of the hydraulic grade line that would be required to insure necessary levels in the drop shaft. In addition, changes in the grade line caused by other drop structures in the system would make restrictive controls undependable.

Favorable results obtained from these tests on the small-scale model (1:48) encouraged a more detailed investigation of the impact-cup idea with a larger model where more accurate observations of the hydraulic forces could be made. A 1:24 scale model (based on a drop-shaft diameter of 8 ft) was constructed with a simulated vertical drop of 100-ft prototype, round sump

chamber, and perforated-wall impact cup. The level of the sump floor was located above the invert of the main interceptor line. Twelve test series were performed with this model with variations which included different sump diameters, shape of outlets, transition section, and various baffle and venting conditions. In addition, for test series 20, 21, and 22, the height of the hydraulic grade line was varied from full pipe condition to 50 ft above the bottom of the lower interceptor. Series 20, which resulted in the accepted design, was based on the preceding tests, but special consideration was given to developing a practical design for construction purposes. Test series 21 and 22 were performed with the height of the drop changed to 135 and 62 ft respectively.

The preliminary work on the 1:48 scale model was concerned with determining areas of the structure which were in need of improvement or correction. Visual observations were used to judge the superiority of one design over another. Effective de-aeration by the sump was the criterion used to measure the efficiency of a particular design in energy dissipation and flow stabilization.

In the photographs of the various tests a large number of bubbles appearing in the outflow conduit indicates poor removal of entrained air, while for the designs having a high degree of energy dissipation very few bubbles are seen in the outflow conduit.

On the larger scale model (1:24) pressure measurements on the floor and sidewalls of the sump were made by the use of piezometers. Pressure fluctuations at the perforated wall of the impact cup were recorded by strain gage pressure pickup cells. In addition, the volume of air escaping the sump chamber was measured volumetrically by means of a bell jar under atmospheric pressure.

V. DESCRIPTION OF THE MODELS

The models and their component parts were constructed of transparent plastic sheet and tubing material. This method of construction permitted observation of all parts of the flow area and made possible the use of photographic records as an adjunct to conventional measurements.

Except for the preliminary work on the 1:48 scale model where the action of a vortex chamber inlet was tested, the inlet for the remaining tests

was limited to a single design as shown on the plan of Fig. 11. Since this inlet was found to have a capacity of 50 per cent above the design flow, it was adequate for all of the tests.

To determine the effect of the water cushion the 1:48 scale model was first constructed with an adjustable sump whose depth could be varied by raising or lowering a piston in the bottom of the sump shaft.

The 1:24 scale model was limited to the development of the energy-dissipating chamber and transition section. The sump bottom was located at an elevation above the invert of the lower interceptor to provide drainage and avoid septic conditions in the prototype. The hydraulic grade line was controlled by an adjustable weir located in the waste box at the outflow end of the model.

Pressures at the base of the sump and at the sidewall were measured by piezometers connected to a common manometer board. Pressure fluctuations on the sidewalls of the impact cup were recorded by means of a diaphragm-type strain gage.

VI. DEVELOPMENT OF BASIC DESIGN

The 1:48 scale model was used primarily for exploratory studies into the action of existing structures and also for development of the basic design of the impact-type energy-dissipating chamber. These first tests were largely used in evaluating the effectiveness of typical structures of past use and were chiefly of a qualitative nature. The findings of these tests are presented to point out the inadequacies of many of the past designs and reveal probable causes of structural failure.

A. Inlets

Recently, considerable interest has been shown in a circular inlet which employs a vortex flow to conduct the storm runoff from the below-surface interceptor to the head of the drop shaft. Two studies have been made dealing with this principle and are summarized in the Appendix [6, 7].

Development of vortex flow in a drop shaft would appear to have considerable merit. Since the vortex would force a spiral flow to follow the wall of the drop shaft, the frictional losses would necessarily be greater

than for free-fall conditions. Two circular inlets were tested with diameters of 2 and 2.75 times the diameter of the drop shaft.

The theory of vortex flow states that the velocity distribution in a free vortex is a product of the velocity and the radius and is a constant quantity ($vr = c$). Thus, with an increase in the radius of the vortex, the velocity would be reduced and the depth of flow would be increased. This is confirmed by comparing Figs. 17 and 18 which show two designs in which the only difference is in the diameter of the inlet chamber. For the same discharge, 600 cfs, it can be seen that depth in the larger chamber is more than twice that of the smaller. Figure 19, showing the larger diameter chamber, has a depth of flow approximately equal to Fig. 17, yet the discharge is only one-half that of the smaller chamber. The inflow to the vortex chamber is in a tangential direction along the circumference of the chamber. As the flow approaches the center of the chamber, the velocity is accelerated and after dropping into the shaft follows the walls in a vertical spiral motion, leaving the center of the shaft open to provide venting of the entrained air. Although no measurements of the quantity of air entrained were made for either type of inlet, it is apparent that the vortex-type inlet does introduce the flow to the drop shaft with less turbulence than the elbow-type inlet. However, if Fig. 20 is compared with Figs. 17 and 18, there is no significant reduction of entrained air by use of the vortex inlet.

The chief drawback to the use of the vortex-type inlet, other than requiring a greater head on the inlet, would be its large size as compared to the elbow inlet. Based on information from Mr. Laushey's report on "Flow in Vertical Shafts" [7], a design discharge of 600 cfs would require an inlet-chamber diameter of from 32 to 48 ft and a depth of 18 to 28 ft, depending on the ratio of the shaft diameter to the inlet chamber. (See Fig. 3 of the Appendix.) It would appear that the slight gain in air-entrainment reduction would be greatly overbalanced by increased construction costs.

B. Elbow Inlet

A more conventional type of inlet is the 90-degree intersection of the near surface interceptor with the drop shaft. The shape of this inlet corresponds to a pipe elbow and may be modified to connect to a street man-hole above the shaft, permitting access to the structure. The invert of the intersection is often curved downward toward the drop shaft, thus giving a smoother transition from the horizontal to vertical direction.

The elbow inlet used on all other tests, except the vortex inlet, was modeled from the design of inlet shown on the preliminary plan for the St. Anthony Freeway structure (Fig. 11). In combination with an 8-ft diameter straight drop shaft, it was found to have a capacity of approximately 900 cfs without raising the grade line above the crown of the top interceptor (Fig. 21). For the design flow of 600 cfs this inlet is very stable and when vented shows no tendency for priming to occur in the drop shaft. For a flow of 1000 cfs the inlet may at times flood, and the drop shaft would momentarily flow as a full pipe. Other tests, using an elbow of radius one and one-half times the pipe diameter, indicate that this elbow is as satisfactory as the St. Anthony design and would possibly be somewhat more economical to construct (Fig. 22).

C. Straight Drop Shafts

A straight drop shaft of the same diameter as the inlet serves as little more than a boundary to surround the falling jet unless the hydraulic grade line in the lower interceptor is maintained high enough to cause the shaft to be flooded to some extent. In most cases of a large drop and a free fall, the flowage area is only a fraction of the area of the shaft. The high velocities developed in the shaft provide excellent conditions for the entrainment of air. In addition, the jet usually enters the shaft in a direction not parallel to the axis of the shaft and as a result rebounds from side to side in the shaft further increasing the turbulence of the jet (Fig. 20).

When a vortex-type inlet is used the turbulence in the drop shaft is materially reduced and a higher head loss results than that obtained with the elbow inlet (compare Fig. 20 with Fig. 17). However, the total turbulence at the bottom of the shaft does not appear to be appreciably less.

D. Modified Drop Shafts

1. Straight Shaft with Contraction

Another type of drop shaft which has certain beneficial qualities is a shaft in which the diameter is abruptly reduced. Several variations of this arrangement were tried including contracting the pipe diameter from 8 to 4 ft at the top quarter point of the shaft, near the lower quarter point, and finally placing the contraction at the lower end of the shaft. In general, the contraction causes the hydraulic grade line to be raised in the shaft

forming a pool to absorb the impact of the falling jet. It also reduces the velocity to some extent and thus promotes de-aeration of the flow by giving opportunity for the entrained air to rise to the free surface. A comparison of Figs. 23 and 24 shows that although the contraction at the base of the shaft does raise the hydraulic grade line in the shaft, the flow conditions in the lower interceptor do not appear to be much better than for a straight shaft. The contracted shaft, of course, would reduce the total capacity of the system depending upon the amount of area reduction placed in the shaft. For simplicity of design and over-all freedom from maintenance and erosive effects of the high-velocity flow, the straight uniform-diameter shaft should be most favorably considered.

2. Taper Shaft

A taper shaft is shown in Figs. 25 and 26. The core of the vortex extends down the entire length of the shaft, and though the shaft is essentially full, the pressure at the base of the shaft is only slightly above atmospheric indicating that the entire length of shaft is near atmospheric pressure. The major disadvantage of the tapered shaft is that it acts as a flow restrictor and limits the discharge under a given head. When used in conjunction with an elbow inlet the taper shaft has no merit over a straight shaft.

3. Radius Elbow

As a means of investigating the possibility of utilizing the hydraulic jump to obtain energy dissipation, the model was altered to substitute a 90-degree radius elbow at the base of the drop shaft. This elbow was the same diameter as the drop shaft. The radius of the centerline was equal to 1-1/2 shaft diameters. Figure 27 shows this model with a discharge of 600 cfs. With the hydraulic grade line raised above the top of the pipe no defined jump exists and a slight change in the grade line will cause the turbulent area to move in either direction. The unstable flow conditions developed by the elbow would no doubt extend a great distance downstream in the lower interceptor.

Control of the hydraulic jump was attempted by locating an obstruction in the bottom of the interceptor pipe a short distance below the radius elbow. Figure 28 shows the effect of the obstruction on a flow of 300 cfs. The jump is incompletely formed and unstable with a great amount of turbulence being transmitted downstream. Figure 29 reveals the large amount of air that would be carried downstream when the discharge is increased to 600 cfs.

Although a hydraulic jump might be established for one set of discharge and grade line conditions, it is unlikely that satisfactory performance could be obtained throughout the complete range of flows. In addition, past experience has shown that the radius elbow would be especially vulnerable to damage by the high velocities developed by the falling jet. Although many large power projects have utilized drop shafts terminating in radius elbows operating without damage, they are not subject to the high volume of abrasive materials which exist in storm discharges from urban areas. Also, the power-project drop shafts normally discharge into tunnels without regard to energy dissipation which is generally accomplished downstream of the tunnel portal.

E. Sump Chamber

After the inlet tests had been performed, it was evident that inlet conditions had little influence on flow diversion at the bottom of the drop shaft. The excess kinetic energy developed in the drop was the chief destructive force acting on the lower portion of the model. Attention was subsequently directed toward a practical means of absorbing this excess energy.

1. Preliminary Design

The preliminary model had a sump at the base of the drop shaft of the same diameter as the shaft with the flow diverted from the vertical to horizontal direction within the boundaries of this sump. Below the horizontal outlet a continuation of the shaft allowed for a cushion of water to absorb the impact of the jet. The model was so constructed that the depth of the cushion could be varied by raising or lowering a self-sealing piston in the bottom of the shaft.

Figures 30 and 31 indicate that the depth of water cushion is of no great value as far as reduction of air entrainment and stability of flow is concerned; however, it is beneficial in reducing scour or erosion.

Due to the "bulking" in volume caused by the combined flow of air and water, the flow area is in effect greatly reduced; consequently, the water velocities remain quite high and sweep the entrained air along into the lower interceptor pipe. The nonuniform entrainment of air in the drop shaft causes an unstable pattern of flow in the sump. The high energy content of the air-water mixture makes it difficult to obtain satisfactory energy dissipation and flow diversion in the limited space of the sump.

2. Variable-Model Sump

To facilitate comprehensive study of the area at the base of the drop shaft, a rectangular-shaped enclosure was constructed so that by alteration of the interior of this unit the several variables affecting the flow could be studied without requiring a separate model for each variation. The over-all dimensions of this chamber were 22 ft wide by 30 ft long and 40 ft in depth, a volume which would be most uneconomical for use.

The initial tests were made with an 8-ft diameter drop shaft discharging directly into the chamber with the outflow pipe separated by a solid baffle extending to within 4 ft of the bottom. Figure 12 shows that in spite of the great depth of water cushion the jet penetration extends 40 ft below the end of the drop shaft. However, the large volume of the chamber removes much of the fluctuation in flow.

The first step was to reduce the depth of the chamber and add a perforated plate 6 ft below the top of the chamber. The perforations in the plate were 9 inches in diameter spaced on a 15-in. equilateral-triangle pattern. The porosity of the perforated plate was 33 per cent. Figure 13 shows the effective manner in which the perforated plate reduces the penetration of the jet. The steadiness of the flow is also greatly increased with the above arrangement; however, the volume of the chamber is still quite beyond economic desirability. An additional reduction in chamber volume was made by installing two walls 15 ft apart. The left or upstream wall extended from the bottom to within 3 ft of the top of the chamber and permitted the venting of air. The right or downstream wall had an opening 4 ft high at the bottom for outflow and a 3-ft opening at the top for air venting. This wall could also be inclined from the vertical if this was found to improve the discharge pattern. Figure 32 shows the above-described changes plus the added feature of a horizontal plate supported in the center of the chamber area directly below the drop shaft. The downstream baffle wall is inclined toward the interceptor pipe. The arrangement is quite effective in breaking the force of the fall water and promotes a stable flow out of the chamber with only a slight amount of air carried to the interceptor pipe.

To the basic design of the flat or impact plate was added a circular sidewall making a cup-shaped unit whose diameter was 9 ft with a depth of 4 ft. Figure 14 shows that the impact cup confines the energy dissipation to

the upper part of the chamber. To reduce the stress in the cup sidewalls, the solidwall was replaced with a perforated wall having physical characteristics previously described for the perforated-plate baffle. Compare Fig. 15 with Fig. 14.

Design variations in the drop shaft show that the action derived from the impact cup was not significantly affected by tapering the shaft or the contractions placed at various levels. The impact cup was found to be most effective if located near the top of the chamber.

For discharges up to 600 cfs the rectangular chamber and circular impact cup would remove nearly all the air before the discharge reached the lower interceptor pipe. In addition, enough energy was lost in the chamber to bring the hydraulic grade line down to slightly above the top of the pipe, thus creating a comparatively stable flow. If some air could be tolerated in the lower interceptor, the capacity of the drop shaft could be increased to 900 cfs without serious instability developing in the system.

At this point in the test program it became apparent that the key to the successful operation of the drop shaft was in the elimination of all energy not required for flow in the lower interceptor line and that the impact cup seemed the most likely means to accomplish this requirement. As a refinement toward a more symmetrical flow pattern and also for a practical construction design, the sump chamber was changed from a rectangular to circular cross section with a reduction of 15 per cent in area (Fig. 16). Outflow was from a 4-ft high opening at the bottom and the air release was a 3-ft opening at the top venting through a 5-ft diameter tube. These openings covered one quadrant of the circumference of the chamber. The impact cup was adjustable vertically to determine the optimum operating position. Two positions of the outlet pipe were provided. Figure 33 shows operation with much air being vented and with only a small portion being drawn down along the top of the interceptor. This air is quickly vented within 10 pipe diameters downstream. The impact cup is in a high position with the sidewall at the level of the top wall vent. Figure 34 shows another modification of the sump chamber. The top of the exit chamber has been closed to prevent air from entering the interceptor pipe. Also, a horizontal baffle plate restricts air from passing under the chamber wall at the outflow. The drop shaft has been reduced to 4 ft in diameter at the top of the chamber, raising the grade line to near the top elbow. Air discharge is almost completely through the upper vents.

The possibility that the sediment could collect below the level of the interceptor line and cause plugging of the sump required changing the out-flow to the low position as shown in Fig. 23. This change has the effect of lowering the grade line in the sump chamber and is evidenced by the increased amount of air. Figure 28 shows flow with the top of the exit chamber open to air flow with results equal to Fig. 35.

F. Sump Design

The basic variables affecting the action of an energy-dissipating drop-shaft sump have been investigated by means of the 1:24 scale models. These factors are diameter of the sump, diameter of the impact cup, height of the impact cup, location of the horizontal baffle slab, size of the conduit leading to the interceptor main, and location and size of vents. Where possible, forces which will govern the structural design have been determined, either by direct pressure measurement or by use of devices such as pressure cells.

Since it seemed likely that a drop structure would be used in multiple, i.e., more than one unit feeding into a common interceptor, the model was built with the drop shaft placed alongside of the main interceptor and the discharge conducted to the main through an intersection of the drop-shaft outlet and the main. Also, it was deemed advisable to have the sump self-draining, so the bottom of the sump was placed slightly above the bottom of the main interceptor.

Observations of the two intersections used in the model study indicated that no particular problem arose with this arrangement, and a slope sufficient for drainage of the sump would not affect the operation of the structure. Photographic records of discharges ranging from 300 cfs to 900 cfs have been made for all series of tests reported, but only those for the design discharge of 600 cfs are presented with each test series chart.

1. Diameter of Impact Cup

Several diameter sizes were tried and the optimum diameter appeared to be 9 ft, or 1 ft larger than the drop shaft. Observations made with a stroboscopic light source revealed that the 9-ft diameter was sufficient to contain the jet at all discharges. As mentioned in the previous report, the falling water never fills the cross section of the shaft and the surface of

the jet is extremely rough and unsteady in shape. This is readily seen in the photos included in the text.

2. Impact Pressures

Impact pressures on the face of the impact cup never reach the theoretical maximum values which might be expected. For the low flows where the discharge enters the drop shaft rather smoothly, the highest impact pressures are recorded. As the flow increases, these pressures decrease to a minimum for discharges near the design flow, and then rise slightly with a further increase in discharge.

The decrease in impact pressure as the discharge increases is explained by the manner in which the water enters the top of the drop shaft. At the lower discharges the trajectory of the jet carries the flow to the far wall where it follows along the shaft down to the impact cup with less mixing with air and a higher density than for the larger flows. As the flow increases, the shaft area becomes more turbulent with greater air entrainment and an ensuing decrease in density. This process continues until larger discharges fill the shaft area more completely and the flow becomes more "solid."

Pressures were measured at the center, at the midpoint between the center and outside edge, and near the outer edge of the cup. The highest pressures were recorded at the outer edge, and it is these pressures that are shown on the charts of each series. Variations in sizes of holes and diameters of the impact cup were tested for over-all performance, but the 9-ft diameter cup with 9-in. holes spaced on 1-ft centers was judged to be most effective. Only the 9-in. diameter perforations were used in making measurements of the forces involved in the impact cup.

3. Location

The impact cup was placed at a number of positions in the chamber, from near the floor to close to the roof. For locations near the floor, the amount of air escaping the sump was high due to the shorter path of travel, with less time for the bubbles to rise to the surface before entering the exit section. Positions near the roof of the sump tended to fill the upper area with turbulence and prevent efficient de-aeration.

4. Cup Sidewall

The sidewall of the impact cup had previously been subjected to study in the 1:48 scale model, and the perforated wall cup was judged to give the

best performance. Several variations of hole spacing and size were tested and their relative effectiveness was observed. As a result of these observations, a pattern having 9-in. diameter holes spaced 12 in. apart in rows on 12-in. centers was chosen, and was used throughout the subsequent test series.

Forces due to the impact of the falling water have been determined at four vertical positions in the circumference of the cup and are shown in Fig. 36. The pressures shown are the maximum found around the perimeter of the cup. In general, the highest values are found at the bottom of the cup.

5. Baffle Slab

Test observations indicated that considerable air was drawn into the exit section of the sump on the outlet or downstream side of the impact cup. This was the result of the flow taking the shortest path to the outlet and giving insufficient time for de-aeration to take place. As a measure to correct this situation, a horizontal slab was extended from the sump wall to the impact cup, blocking the downstream half of the chamber and forcing the flow to take a considerably longer path to the exit section. Further tests indicated that the best position for the baffle slab was to have the underside even with the top of the exit conduit. The impact cup and baffle slab could, in this fashion, be made an integral unit, thus eliminating any lateral ties to the other side of the sump, and at the same time providing a means of lateral stability to the impact cup.

6. Sump Diameter

The diameter of the sump has an important influence on the energy-dissipating capacity of the structure. If the sump diameter is too small, the velocities of the flow below the impact cup will remain high and the necessary de-aeration of flow will not be accomplished. Merely increasing the diameter until complete de-aeration is accomplished is neither practical from a structural viewpoint nor economical of materials and excavation quantities. Various modifications and additions to the sump were studied and are reported in detail under "Test Results." One of the first modifications to the round sump was to add a section between the sump and the outlet conduit. This unit also served as a transition from the sump area to the outlet conduit and provided an additional area in which the entrained air had an opportunity to separate from the water. In addition, this area or exit chamber served as a collecting and venting area.

7. Vents

Venting of the air from the top of the sump and the exit chamber is an important phase of the design. Unless this air can be carried away, it will be drawn along the outlet conduit and discharged into the main interceptor. It is anticipated that an access shaft will be driven alongside the drop shaft and that this will be utilized for the removal of air to the surface. Actually, the vented air can be returned to the top of the drop shaft and be allowed to recirculate in the system. In this manner the vented air would replace the air normally drawn down the drop shaft by the falling water. By this method, objectionable discharges of air at the ground level would be kept to a minimum and large unsightly surface vents would not be required. Large volumes of air gathered at the top of the sump were easily vented by an opening in the downstream side near the top of the sump wall.

VII. DEVELOPMENT OF FINAL DESIGN

Following the preliminary tests, the program was enlarged to incorporate the findings in a larger scale model (1:24).

A series of tests (numbers 11 through 19) were run using modifications of the impact-cup design to investigate the effect of varying the principal dimensions of the model.

Series 11 was a typical design of a water-cushion type of structure and was studied to provide a comparison with the subsequent tests.

The sump diameter for series 12, 13, and 19 was 16 ft; for series 14, 15, and 17 the diameter was increased to 23 ft. Test series 18 was performed with the diameter at 19-1/2 ft, midway between the other two groups.

In general, the larger the sump diameter the greater its capacity for air removal. Two other variables influencing the air removal are the volume of the exit chamber and the diameter of the outflow conduit. Since velocities in the sump below the impact cup affect the rate of air rising in a unit distance, any scheme that would reduce these velocities would promote de-aeration of the discharge. Using this premise, test series 15 was made with the diameter of the outlet conduit increased from 8 ft to 11 ft. This results in a velocity reduction of 50 per cent of the previous rates. Comparison of test series 14 and 15 for a design flow of 600 cfs shows equivalent

performance although the exit chamber in series 14 was eliminated from series 15.

Figure 37 gives the relation of water to air discharge for all the models tested at the 1:24 scale. The larger diameter sumps are more effective in removing entrained air; however, the volume of the exit chamber also has an influence on total air removed.

For test series 11 through 19, the proportions were selected to conform to a drop structure having a vertical drop of 100 ft and a drop-shaft diameter of 8 ft. Other dimensions of the model were varied as necessary to develop satisfactory action of the structure. As previously mentioned, the exit conduits included both 8-ft and 11-ft diameter pipes.

To determine hydrostatic loadings on various parts of the structure a number of pressure-measuring taps were included in the model. Wall pressures were measured at eight points on the sidewall and are plotted in proper location on each test series chart. These pressures were found to be steady and are assumed to be average loads at these points. Impact pressures on the face of the impact cup were measured at three points. Since slow fluctuations of the pressure were observed, the maximum pressure was recorded and shown on the chart.

The difference between the pressure on the impact-cup floor and the pressure on the sump floor is the measure of the amount of energy dissipated by the structure.

All the tests in this series were made with the main interceptor flowing full. Although the design discharge for this construction was specified as 600 cfs, the test flows were carried to 50 per cent higher than this value to provide for a safety factor.

A. Series 11

This model simulates a uniform diameter drop shaft and sump without air vents and energy-dissipating devices. The only measurements made on this model were air discharge determinations which are included in Fig. 37. Figure 38 shows this model with a flow of 600 cfs and is presented solely for purposes of comparison with other designs.

B. Series 12

This model was the first impact-type design tested at a 1:24 scale and represents the minimum in size that was considered practical. A short transition of straight sidewalls connects the circular chamber with the exit conduit. The short transition and high velocities (12 fps for 600 cfs) resulted in considerable amounts of air being carried downstream to the main interceptor. The photo shows that approximately a 50-ft length of conduit is traversed before all the air rises to the top of the interceptor (Fig. 39).

C. Series 13

Features of this design are similar to series 12 with the exception that the transition or exit chamber length was increased by 8-1/2 ft and an additional vented section was added at the beginning of the conduit. The change provided greater capacity for air removal and resulted in a reduction of air escaping the sump chamber of over 85 per cent (Fig. 40).

D. Series 14

This model is an enlarged version of series 12. The diameter of the sump was increased from 16 ft to 23 ft while the length of the exit chamber remained approximately equal to that of series 12. Due to the increased sump diameter the volume of the exit chamber was increased by about 20 per cent. While series 14 was not as effective in removal of air for the 600 cfs flow, the difference between series 13 and 14 is probably not significant. However, at discharges of 750 and 900 cfs this model was approximately 15 per cent more efficient in air removal than series 13 (Fig. 41).

E. Series 15

This design included a 23-ft diameter sump directly connected to an 11-ft exit conduit. A short exit section 5 ft long and the width of the conduit extended to the top of the sump chamber and terminated in a 5-ft diameter vent shaft. As seen in the test photo, better de-aeration occurs in the bottom of the sump than in any of the preceding models. Areas of clear water exist near the junction of the sump and the conduit. The efficiency of air removal is approximately equal to series 14 (Fig. 42).

F. Series 17

By adding a 5- by 11-ft vent section in the top of the conduit to the series 15 model a greater amount of air was removed than for any other test series. Only a negligible amount of air passes to the main interceptor. Due to the construction necessary in the model the vent area was divided into two chambers; however, it is quite probable that the separating wall could be eliminated, making a single vent chamber (Fig. 43).

G. Series 18

The diameter of the sump chamber of series 17 was reduced from 23 to 19-1/2 ft with a reduction in volume of slightly more than 25 per cent. The air discharge rate for a 600 cfs discharge increases from 5 cfs to 43 cfs. For higher rates of flow this design compares favorably with series 17 (Fig. 44).

H. Series 19

This model is a revision of series 12 to include an additional air vent in the top of the exit conduit. The performance is improved to some extent with a 25 per cent reduction in air discharge at the design flow (Fig. 45).

I. Series 20

At the conclusion of the testing program covering test series 11 to 19, the design of series 17 was selected for further consideration. Construction problems encountered in excavating a sump chamber with a flat ceiling led to the proposal of a chamber with a cone-shaped roof. This shape would permit a stepped-back method of rock excavation and allow the lower ledges to support the rock layers above. The side slope of the cone is 1:1. A semi-circular roof section is used in the exit chamber. Another change is that the impact cup is supported on four columns rather than by a single central pedestal as in the previous designs.

The enlarged volume of the sump and exit chambers resulted in almost complete air removal before the flow entered the outflow conduit. Figure 37 shows that the amount of air escaping from the sump to the outflow conduit is far less for this design than any of the preceding arrangements.

Additional tests were run with the grade line raised at the foot intervals from the top of the conduit to a maximum of 50 ft above the conduit floor. An increase in the height of the grade line results in a considerable portion of the energy dissipation taking place in the drop shaft. Pressures on the sump floor are essentially the same as in the exit conduit, proving that the impact cup is working efficiently as an energy dissipator. Figures 46, 47, and 48 show the action of the chamber with normal grade line or full pipe flow and with the grade line 30 and 50 ft above the floor of the chamber.

J. Series 21

This series of tests was performed with the height of the drop increased from 100 to 135 ft with the design of the sump chamber the same as for series 20.

The hydraulic action encountered in the higher drop is quite similar to the 100-ft drop and the impact cup continues to do an efficient job of energy dissipation. The pressures on the impact cup are of course greater than for the smaller drops but again not as large as could be expected from the fall height.

K. Series 22

The height of the drop for this series was reduced to 62 ft from the centerline of the upper interceptor to the base of the sump chamber. Again, as in the series 21 test, the action of the chamber is very similar to that observed for the 100-ft and 135-ft drops. The pressures on the impact cup are also less than the maximum that could be expected. Air flow escaping from the sump is the smallest of any of the tests observed, since it is practically zero for the design discharge.

VIII. SUMMARY

These tests have shown that the impact-cup type of drop structure can be effectively used to convey storm run-off waters from the surface to subterranean collecting systems with a minimum of air entrainment and a reduction in possible damage at the base of the drop. The design presented in test series 20 is the recommended design as developed during the study. Its ample volume in the cone area of the sump chamber and exit section give excellent conditions for air removal. Test series 21 and 22 have shown that it

can be used with either higher or lower drops without impairing its effectiveness as an energy dissipator. Air escaping to the discharge conduit is the least for any of the designs tested.

The data collected by this study have been used to design a specific structure and can be used within limits for higher or lower drops than were used in these tests. However, a number of factors, which are all interrelated in the action of the structure, make it difficult to extrapolate this information to a wide variety of discharges and drop-shaft sizes. For example, the impact pressures on the horizontal surface of the cup are influenced by the rate of flow into the top of the drop shaft and the manner in which the flow enters the shaft. For lower discharges the flow tends to cling to the sides of the drop shaft and not entrain as high a volume of air as for the larger discharges. The higher unit density of the low flows would account for the relatively high impact pressures observed for some low rates of discharge. As the discharge rate increases, the entrainment of air also increases and the impact forces appear to be near the minimum for the design discharge of 600 cfs. A further increase in the rate of flow is accompanied by an apparent increase in the "solidity" of the bulk flow, and the impact forces rise to greater values.

Throughout the tests the amount of entrained air escaping to the discharge conduit was used as a criterion in judging the efficiency of the particular design. This measure is a good indicator of the completeness of energy dissipation obtained by the impact cup and of the stability of the flow leaving the sump chamber.

Although the models utilizing impact cups indicate in most cases that the air discharge into the outflow conduit is very small, the prototype can be expected to have larger volumes of entrained air carried to the interceptor. It is known that the rate of rise of single or chains of bubbles reach a maximum rate of rise. However, little is known at present of the rate of rise for an aggregate of bubbles or how they are affected by variable pressure gradients. Figure 37 is presented as a valid comparison of the relative performance of the various designs tested.

L I S T O F R E F E R E N C E S

- [1] Babbitt, H. E. Sewerage and Sewage Treatment. John Wiley. 1932.
- [2] Metcalf, L. and Eddy, H. American Sewerage Practice, Vol. 1. McGraw-Hill. 1914.
- [3] Escrit, L. B. "Use and Design of Drop-Manholes," The Surveyor, pp. 671-673. November 11, 1949.
- [4] Cotillon, J. "Supply Shafts for Power Tunnels and the Problem of Air Entrainment," Proceedings of the 8th Congress of the International Association of Hydraulic Research. Montreal. August 1959.
- [5] Boughton, N. O. "Laboratory Studies on the Use of Siphons and Vortex Chambers for Exclusion of Air at Secondary Intakes," Proceedings of the 8th Congress of the International Association of Hydraulic Research. Montreal. August 1959.
- [6] Stevens, J. C. and Kolf, R. B. "Vortex Flow Through Horizontal Orifices," Proceedings of the American Society of Civil Engineers, Sanitary Engineering Division, no. 3004, 124:871.
- [7] Laushey, Louis M. Flow in Vertical Shafts. Carnegie Institute of Technology, Department of Civil Engineering. August 1952.

F I G U R E S
(1 through 54)

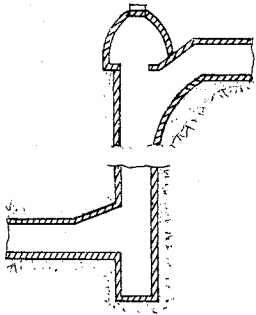

Fig. 1 - Well Hole at St. Paul

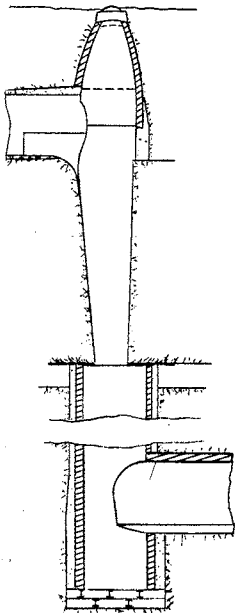

Fig. 2 - Well Hole, Minneapolis

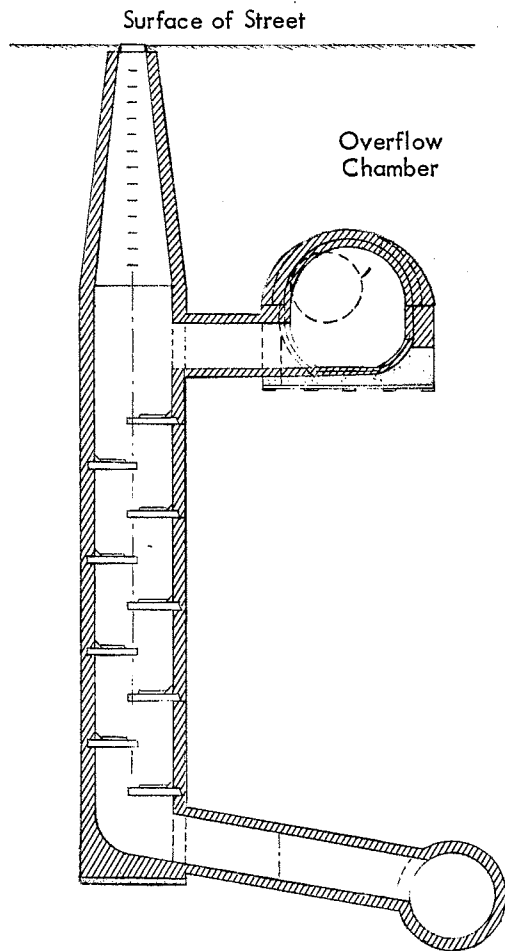

Fig. 3 - Well Hole, Cleveland

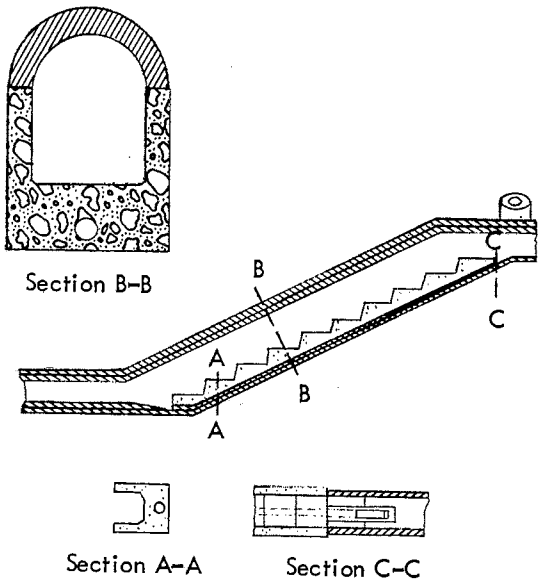

Fig. 4 - Flight Sewer, Philadelphia

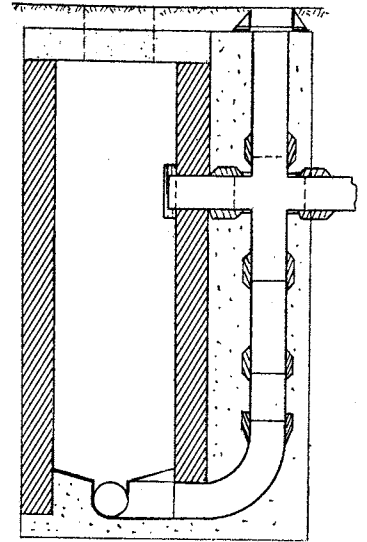

Fig. 6 - Backdrop

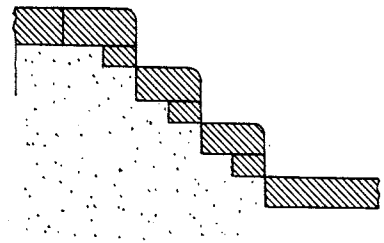
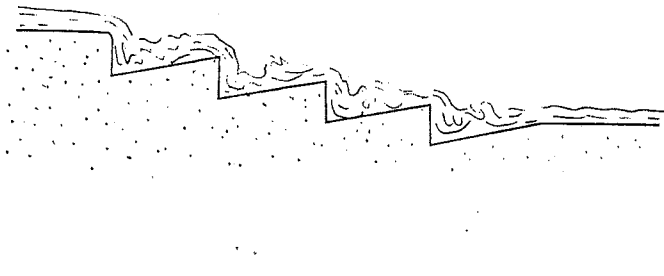

Fig. 5 - Cascade for Water

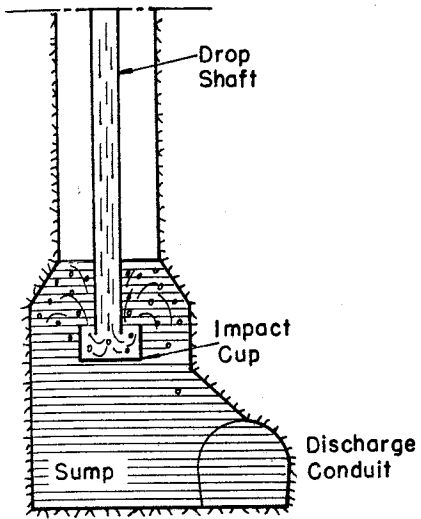

Fig. 7

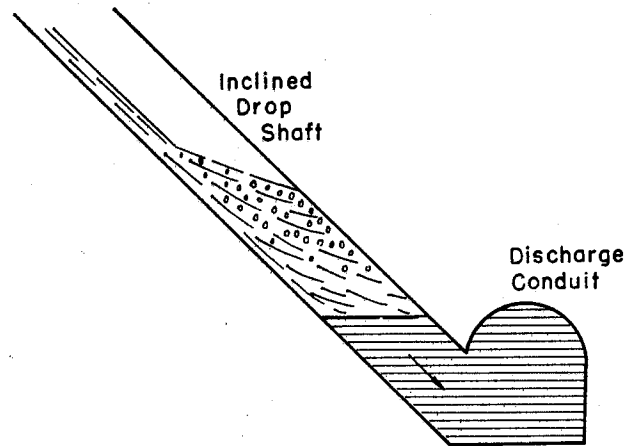

Fig. 8

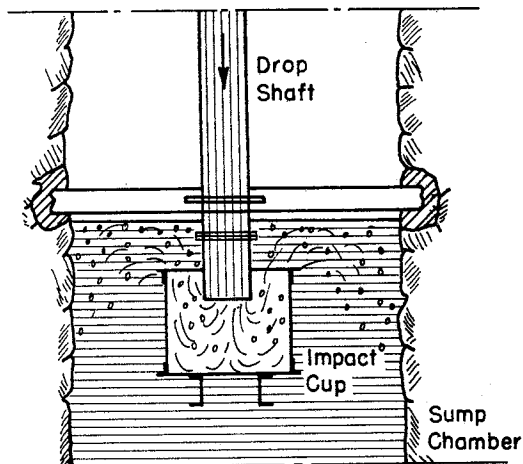

Fig. 9

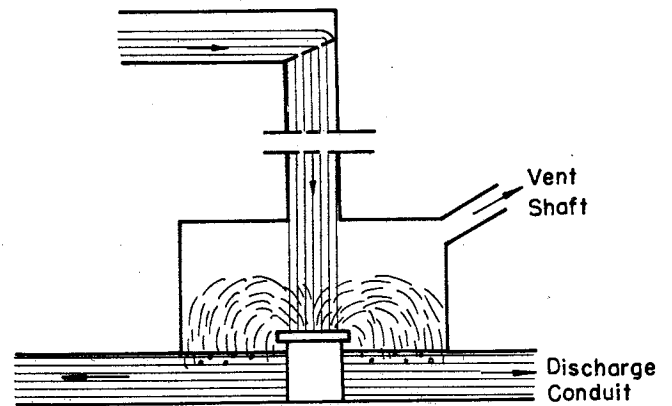

Fig. 10

Source: J. Cotillon

"Supply Shafts for Power Tunnels and the Problem of Air Entrainment."

Proceedings of 8th Congress IAHR - Montreal August, 1959

Figs. 7 through 10 - Typical Sumps Used for Air Removal and Energy Dissipation in French Water Power Collecting Systems

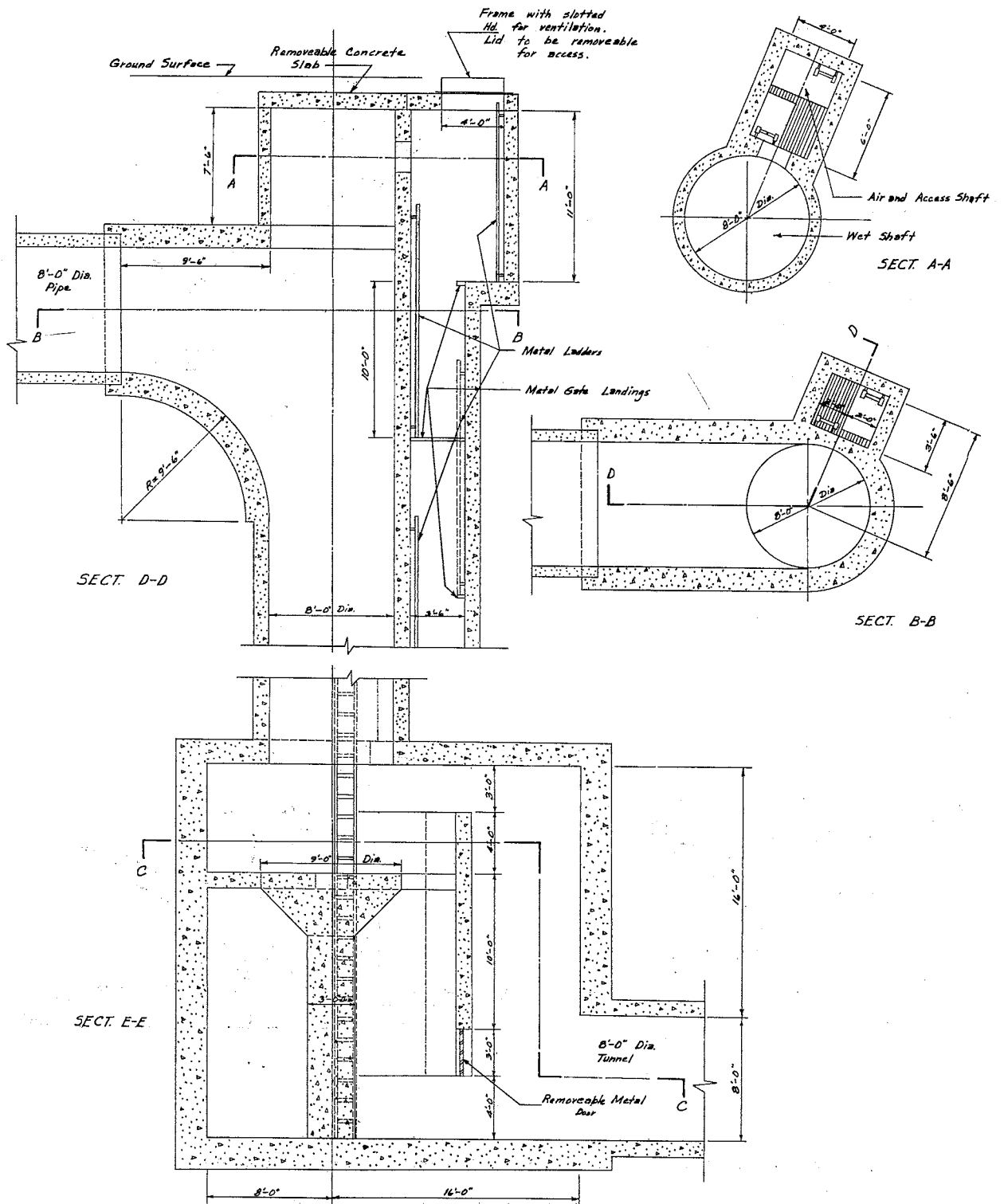

Fig. 11 - Drop Shaft Design Based on Preliminary Model Studies

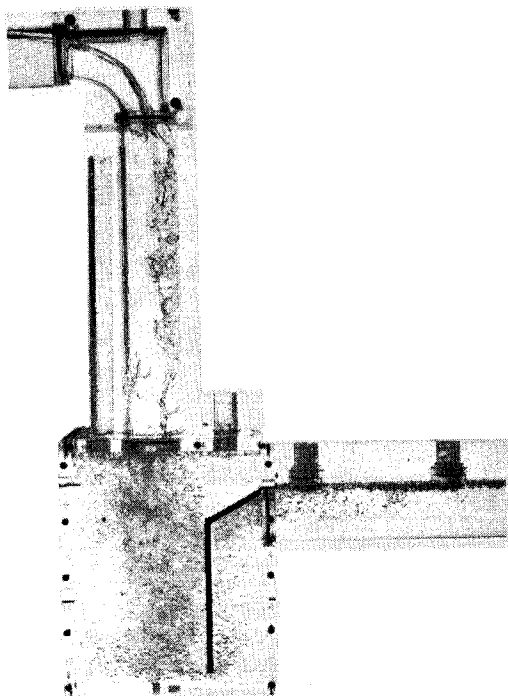

Fig. 12 - Rectangular Sump, 22 ft Wide, 30 ft Long, and 40 ft Deep. Jet Penetrates to Bottom of Sump. Discharge 600 cfs

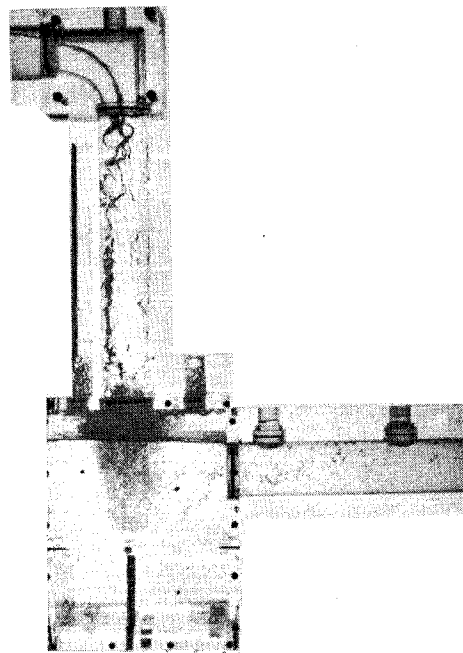

Fig. 13 - Rectangular Sump (20 ft Deep) With Perforated Impact Plate 4 ft Below End of Drop Shaft. Discharge 600 cfs

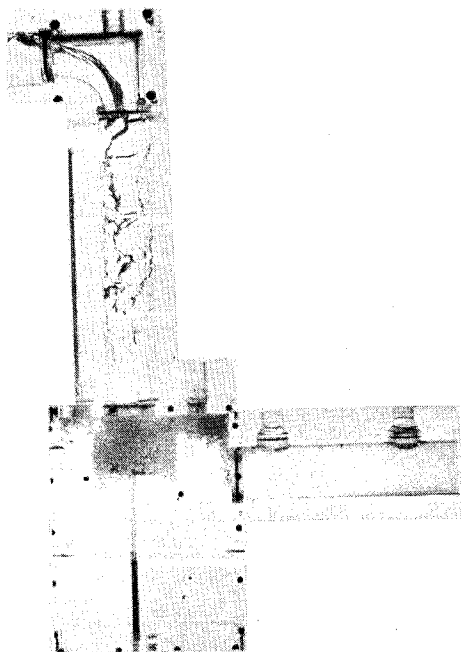

Fig. 14 - Rectangular Sump 22 ft by 15 ft and 20 ft Deep, with Solid Wall Impact Cup 9 ft in Diameter. Discharge 600 cfs

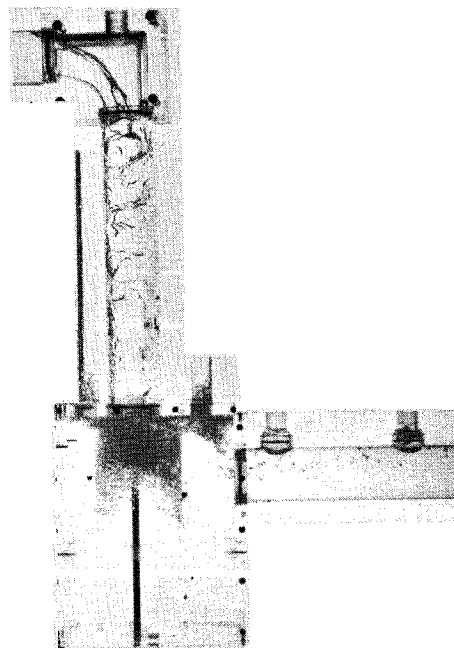

Fig. 15 - Rectangular Sump, 22 ft by 15 ft and 20 ft Deep, with Perforated Impact Cup. Discharge 600 cfs

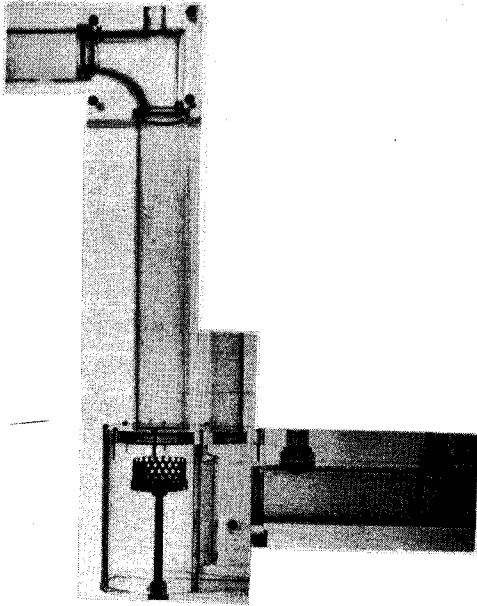

Fig 16 - Circular Sump with Perforated Impact Cup. Sump Diameter 18 ft

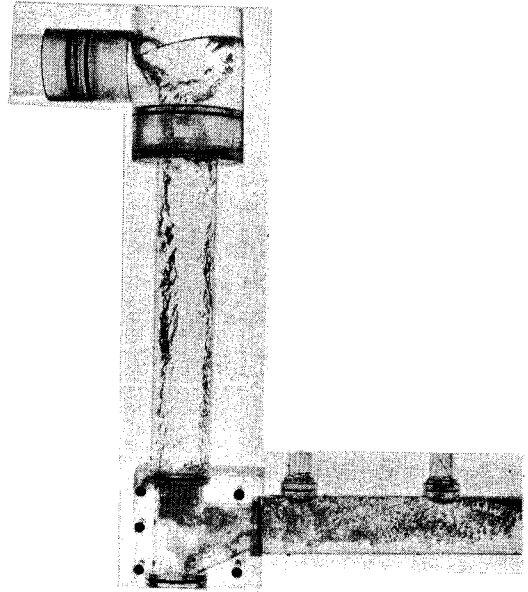

Fig. 17 - Vortex Type Inlet 16 ft in Diameter with 8-ft Drop Shaft and Deep Water Cushion. Discharge 600 cfs

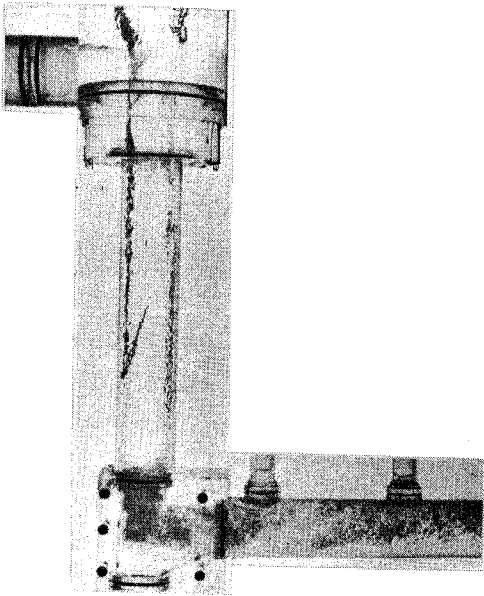

Fig. 18 - Vortex Inlet 22 ft in Diameter. Depth in Chamber Greatly Increased as Compared with Fig. 17. Discharge 600 cfs

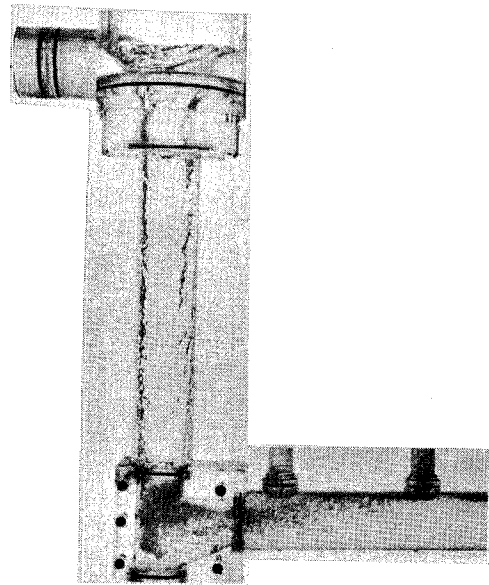

Fig. 19 - Vortex Inlet 22 ft in Diameter. Discharge 300 cfs

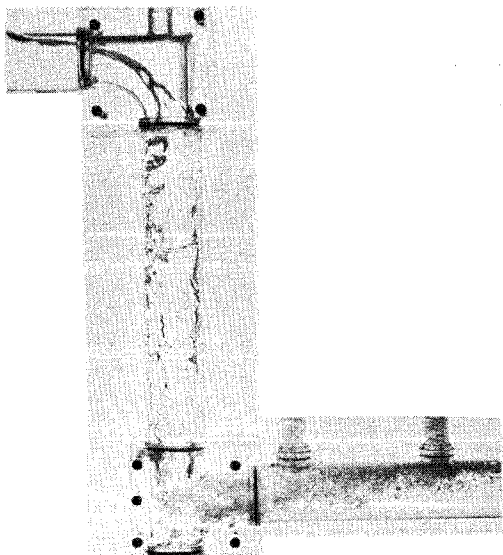

Fig. 20 - Eight-ft Diameter Shaft with Elbow Inlet and Deep Sump. Discharge 600 cfs. High Ratio of Air to Water in Interceptor Tunnel

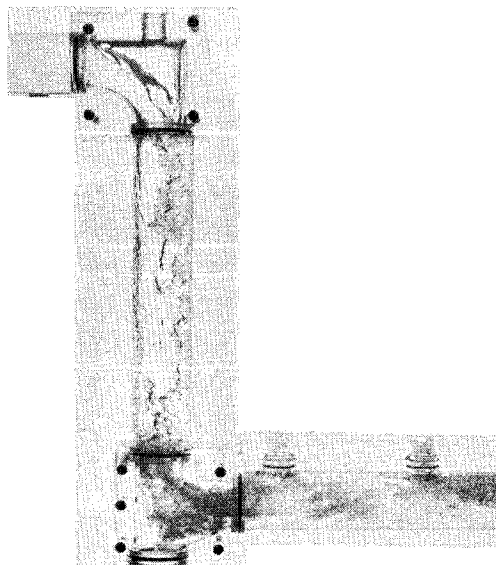

Fig. 21 - Elbow Inlet with Deep Water Cushion. Discharge 900 cfs

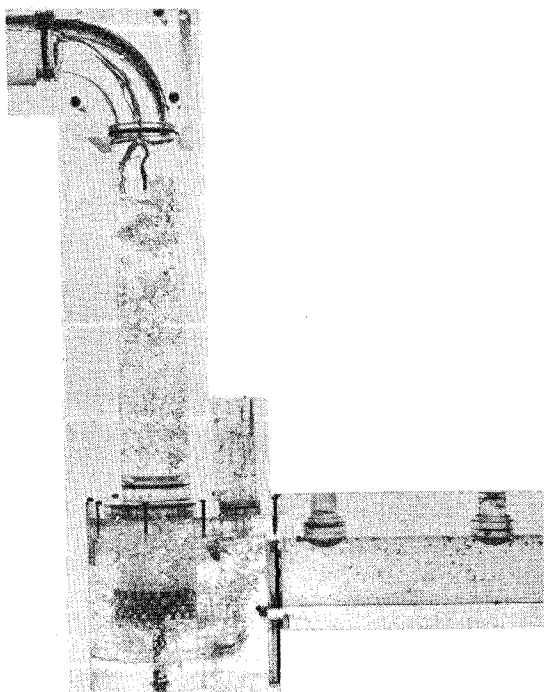

Fig. 22 - Elbow Inlet, 8 ft Diameter Shaft with 16 ft Diameter Sump. Impact Cup in Low Position. Discharge 600 cfs

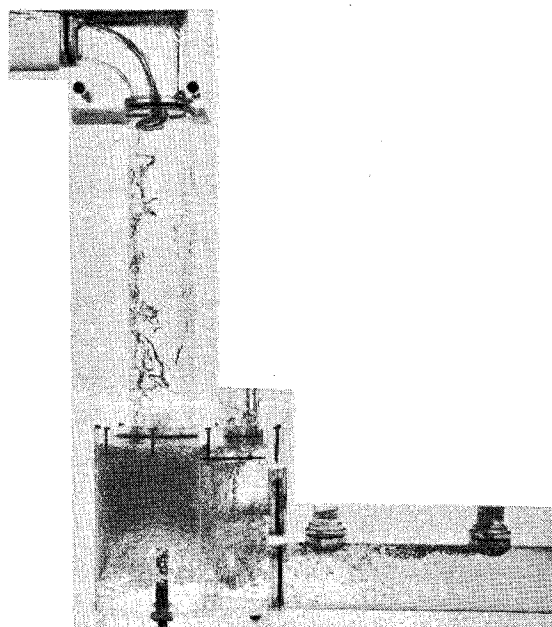

Fig. 23 - Circular Sump and Perforated Impact Cup with Discharge Conduit at Base of Chamber. Discharge 600 cfs

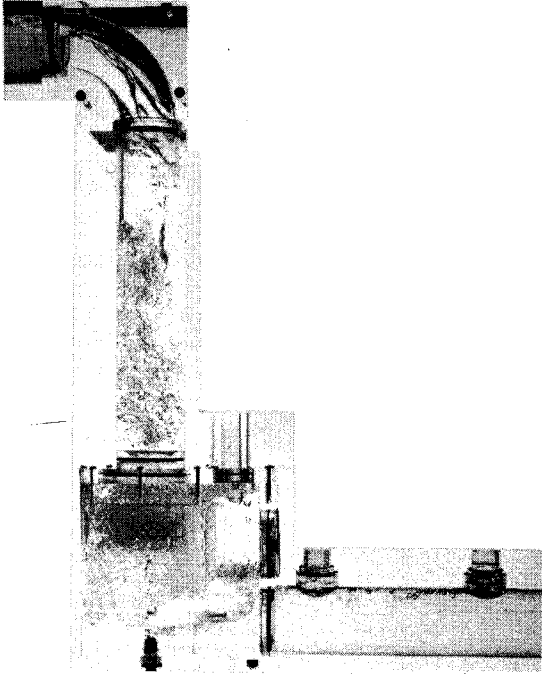

Fig. 24 - Circular Sumps and Perforated Impact Cup with Restriction in Drop Shaft at the Top of Sump. Diameter of Sump 16 ft. Discharge 600 cfs

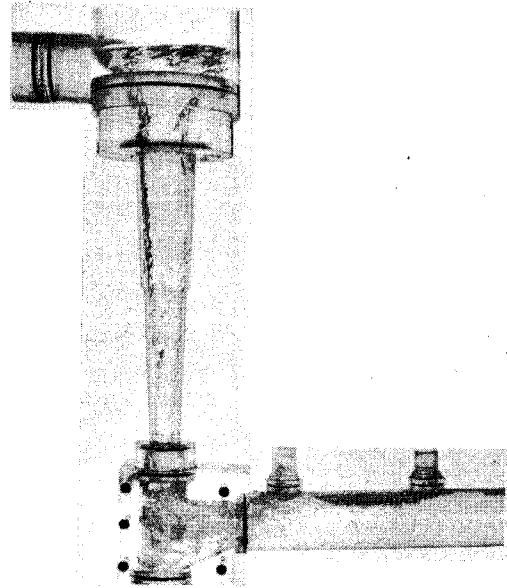

Fig. 25 - Vortex Inlet and Tapered Shaft. Vortex Extends to Base of Shaft. Discharge 300 cfs

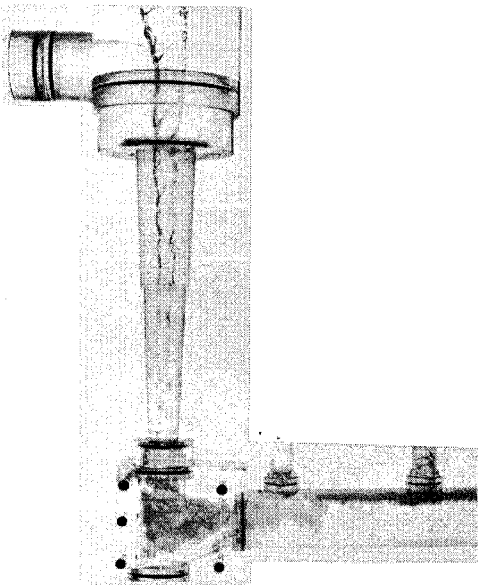

Fig. 26 - Vortex Inlet and Tapered Shaft. Discharge Increased to 450 cfs With Large Increase in Head at Inlet

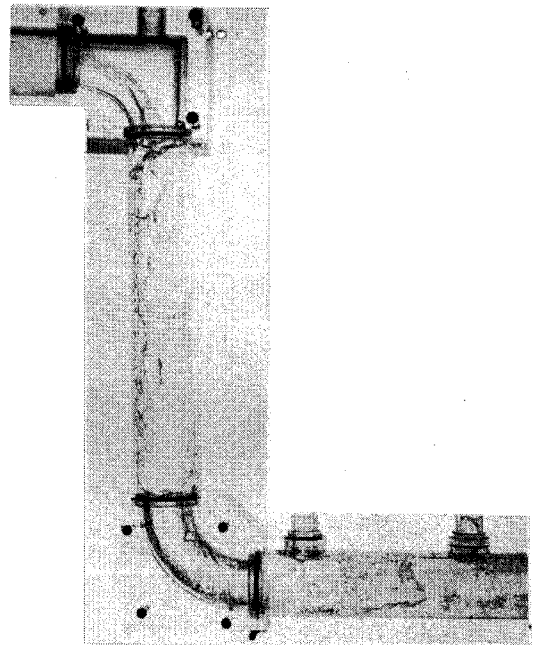

Fig. 27 - Drop Shaft With 1-1/2 D Radius Elbow at Base. Unsteady Flow in Discharge Conduit. Discharge 600 cfs

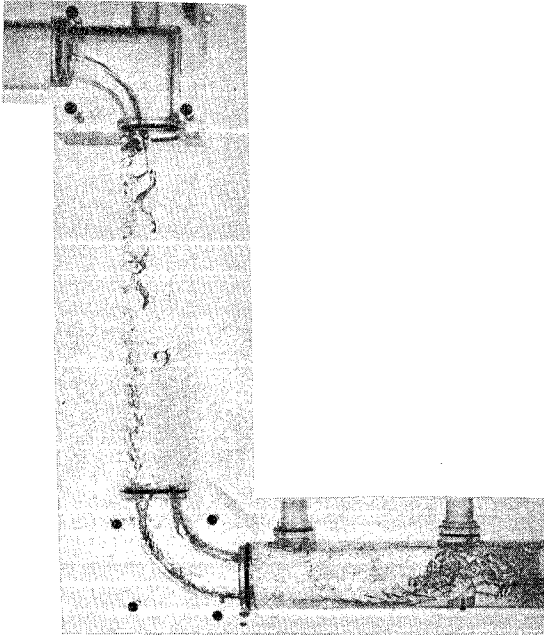

Fig. 28 - Drop Shaft with 1-1/2 D Radius Elbow. Energy Dissipating Sill Placed in Discharge Conduit. Discharge 300 cfs

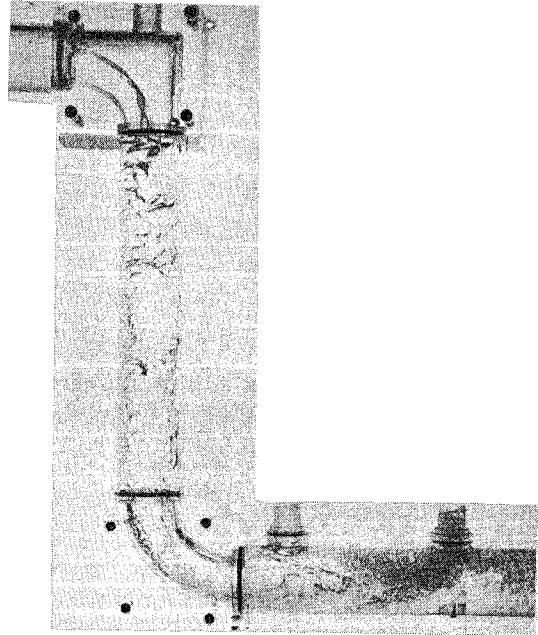

Fig. 29 - Drop Shaft with 1-1/2 D Radius Elbow. Energy Dissipating Sill Placed in Discharge Conduit. Discharge 600 cfs

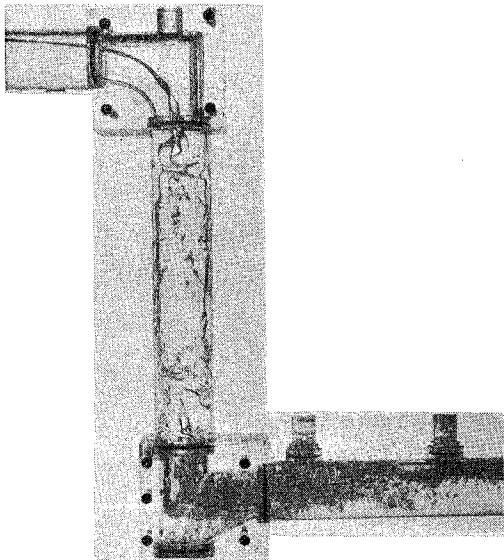

Fig. 30 - Drop Shaft Without Water Cushion. High Air-Water Ratio in Discharge Conduit. Discharge 600 cfs

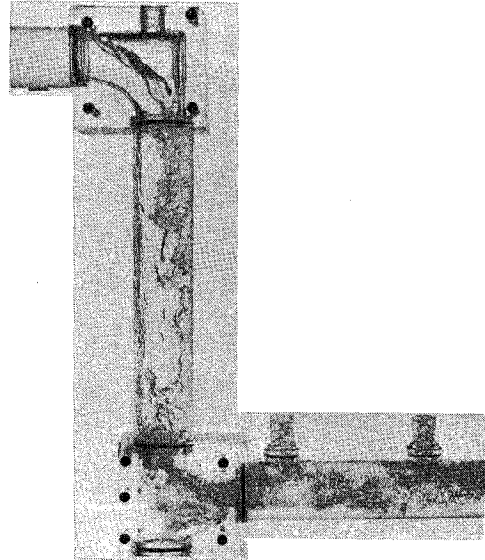

Fig. 31 - Drop Shaft with Deep Water Cushion. Air-Water Ratio Similar to Fig. 30. Discharge 900 cfs

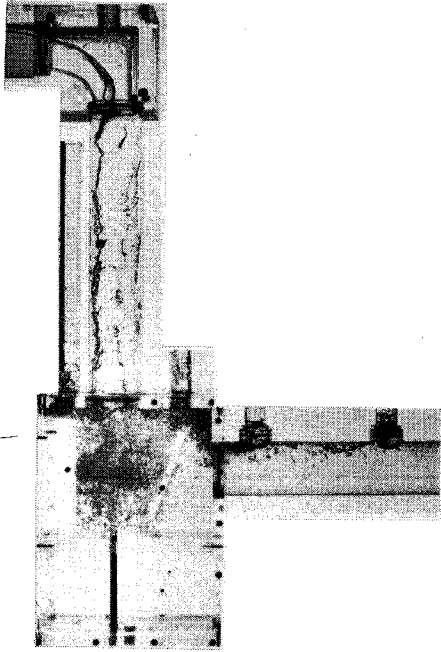

Fig. 32 - Rectangular Sump 22 ft by 15 ft by 20 ft Deep, With Inclined Baffle on Right Side

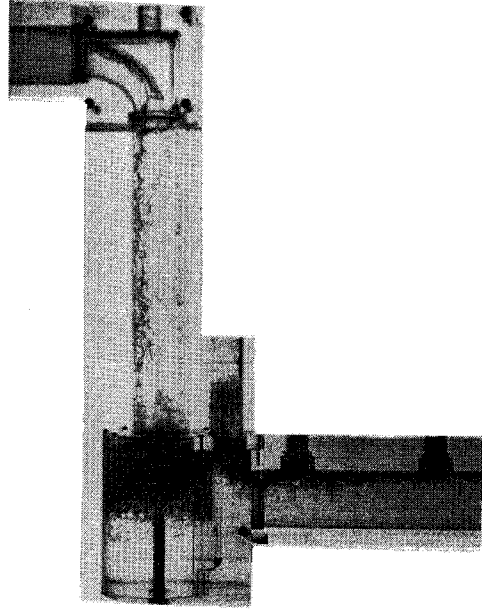

Fig. 33 - Circular Sump and Impact Cup and Curved Baffle Open at Top and Bottom. Discharge 600 cfs

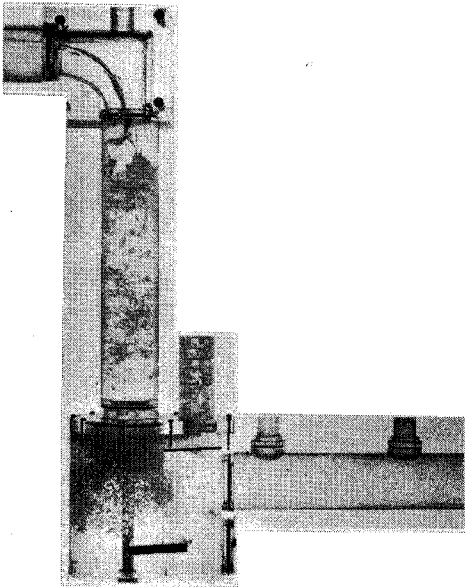

Fig. 34 - Circular Sump and Impact Cup With Curved Baffle Open at Bottom Only. Discharge 600 cfs

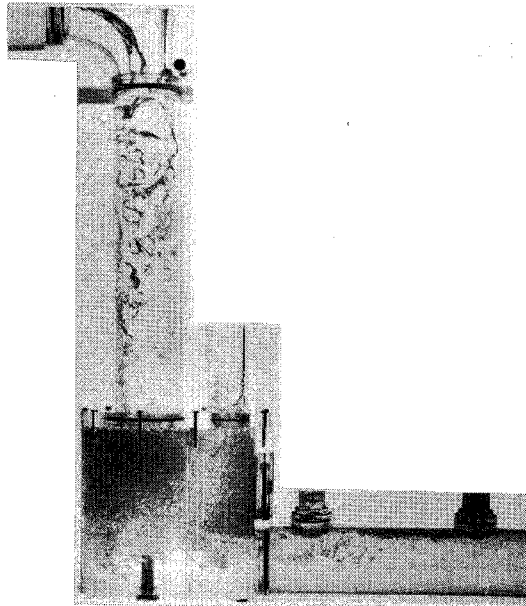

Fig. 35 - Circular Sump (18 ft in Diameter) With Perforated Impact Cup. Baffle Open Top and Bottom. Discharge Conduit at Base of Sump. Discharge 600 cfs

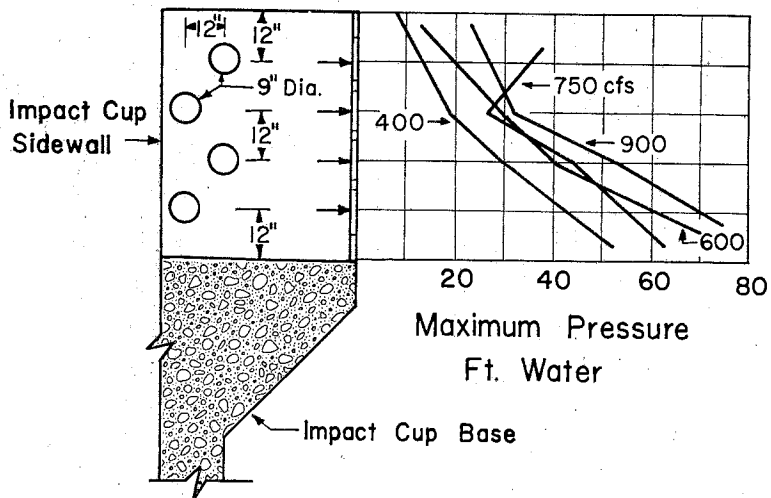

Fig. 36 - Pressures on Perforated Cup Sidewall

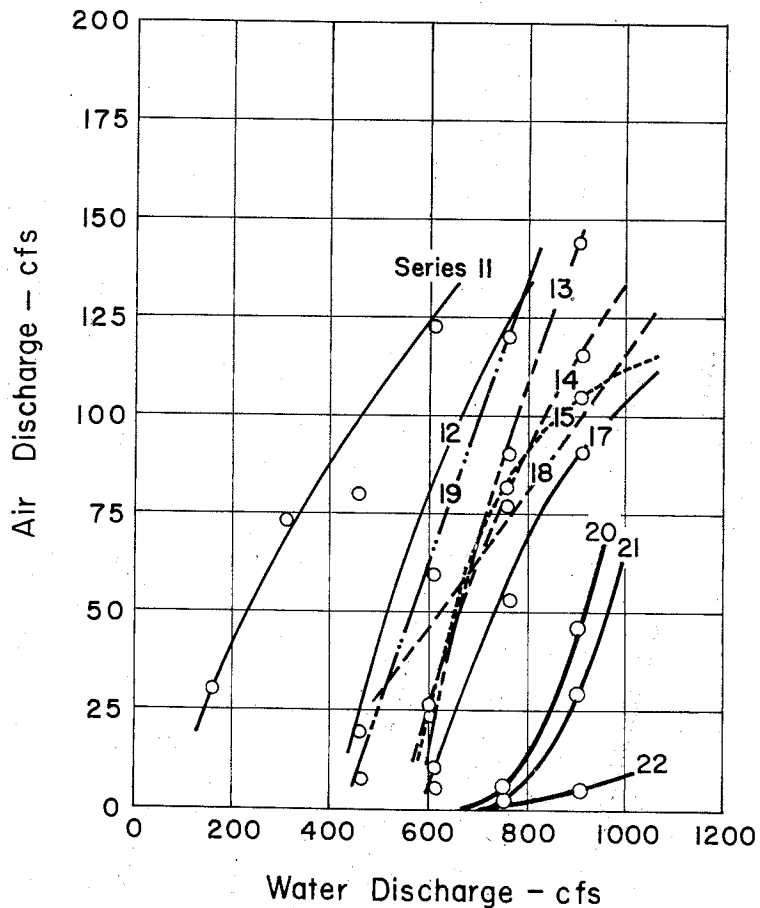

Fig. 37 - Air-Water Discharge from Sump Chamber

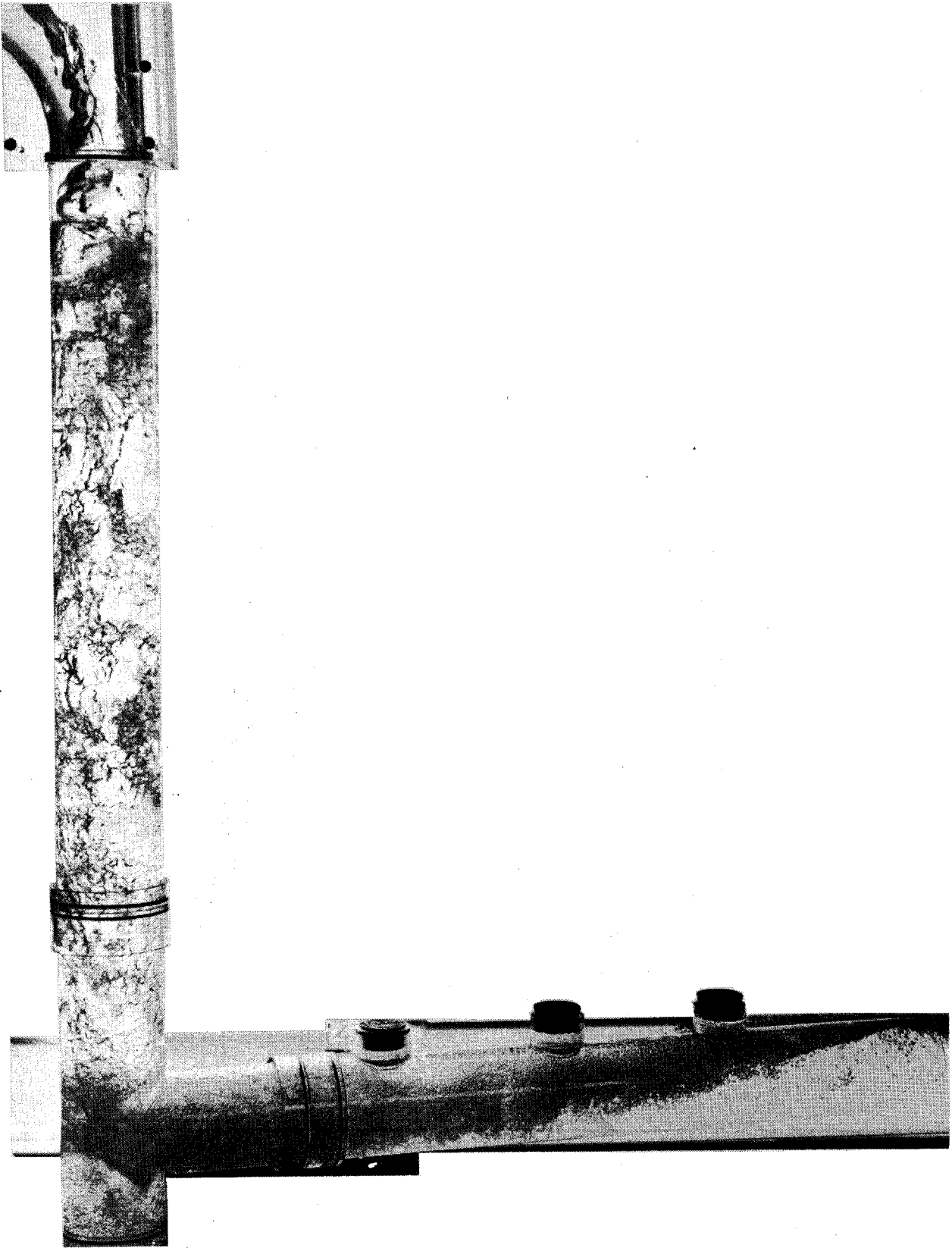
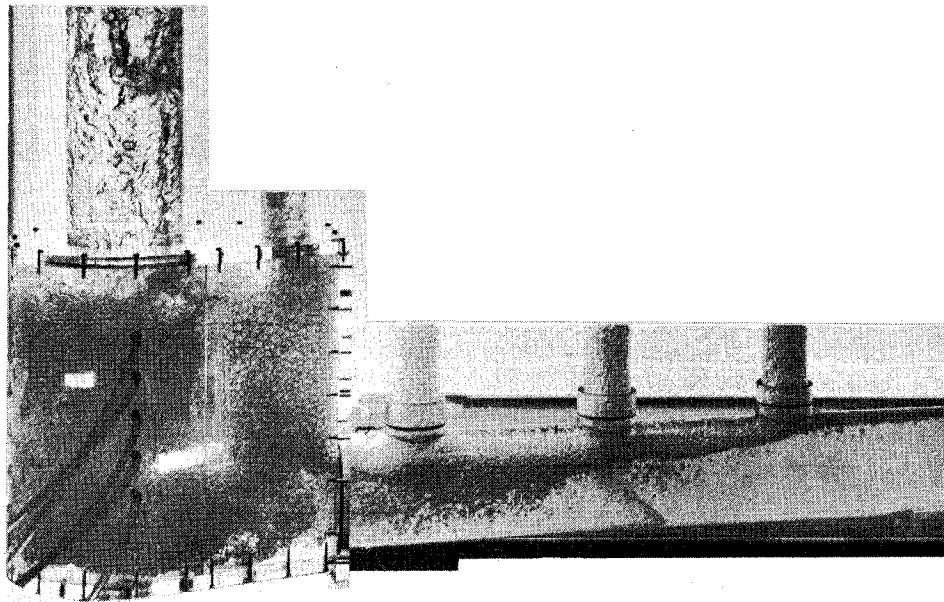
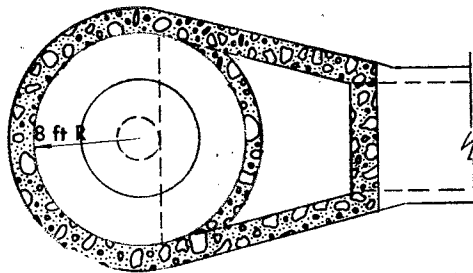

Fig. 38 - Series 11. Straight Drop Shaft with Water Cushion Sump. Scale 1:24.
Drop 100 ft



Discharge - 600 cfs



SECTION A - A.

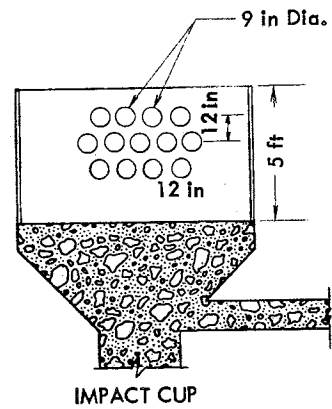

IMPACT CUP

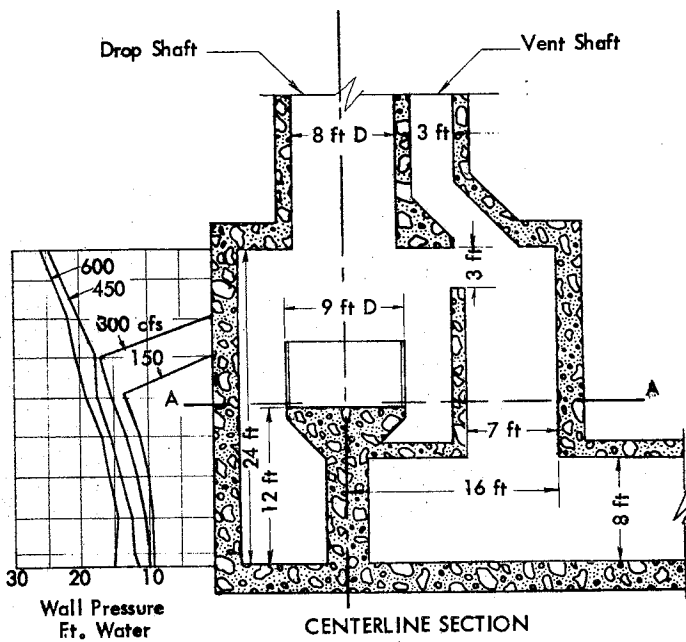

CENTERLINE SECTION

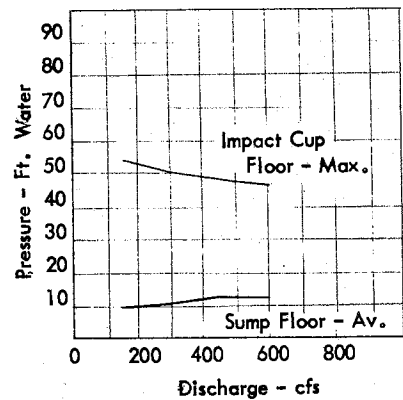
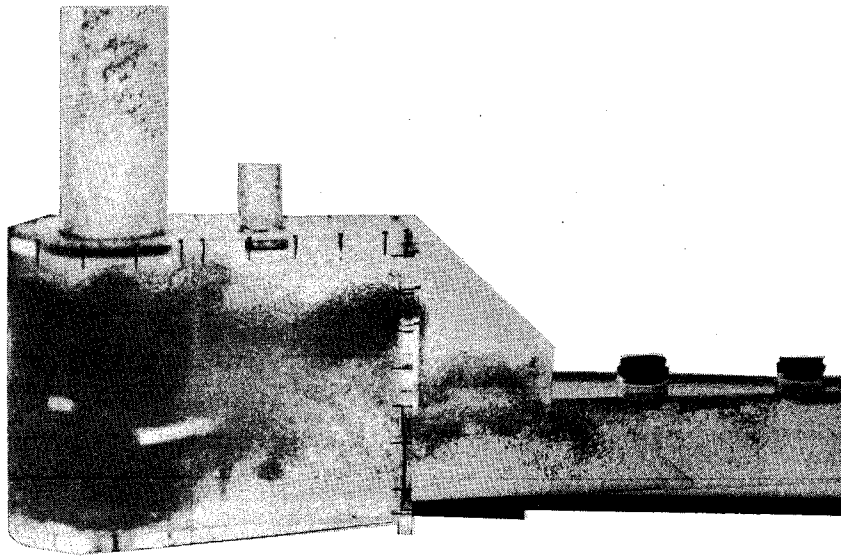
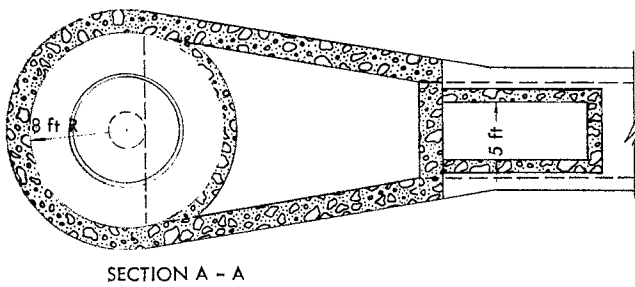

Fig. 39 - Series 12. Drop Shaft with 16-ft Diameter Circular Sump and Perforated Impact Cup Based on Preliminary Design as Shown in Fig. 11. Scale 1:24. Drop 100 ft



Discharge - 600 cfs



SECTION A - A

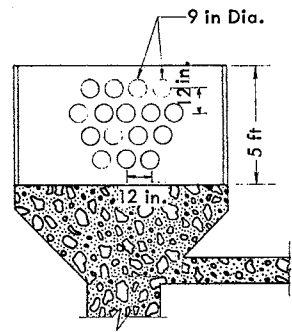

IMPACT CUP

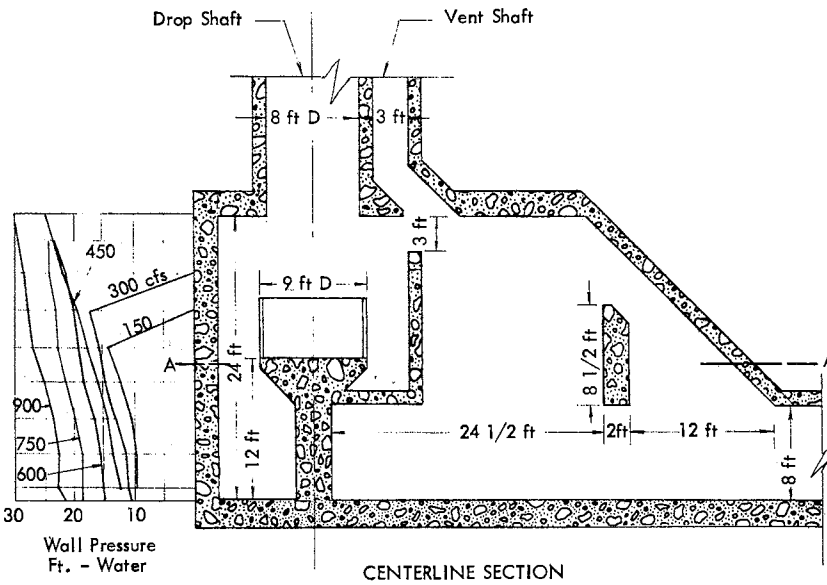

CENTERLINE SECTION

Wall Pressure
Ft. - Water

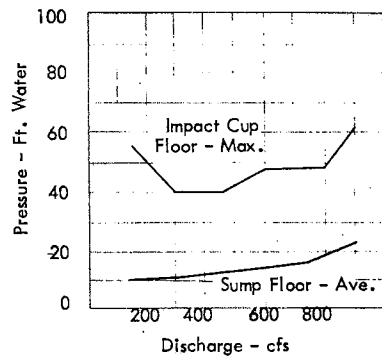
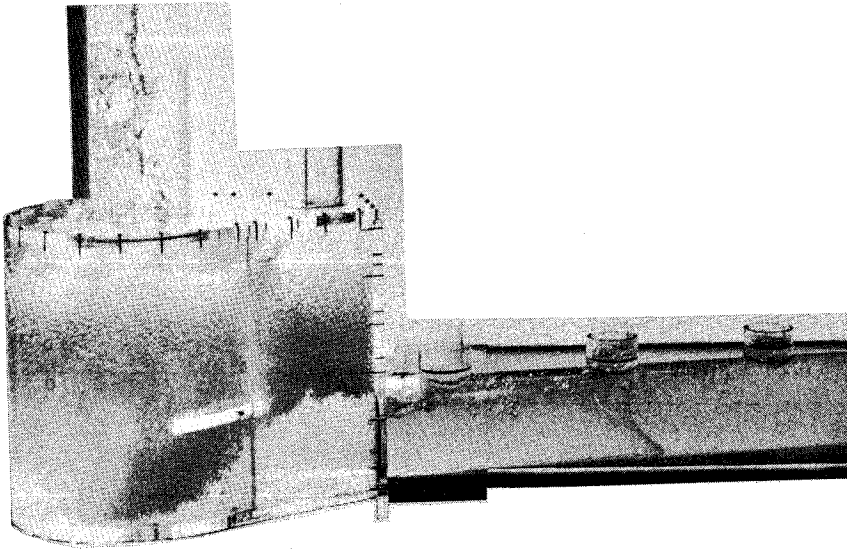

Fig. 40 - Series 13. Drop Shaft with 16-ft Diameter Circular Sump and Perforated Impact Cup with Extended Discharge Chamber. Scale 1:24. Drop 100 ft



Discharge - 600 cfs

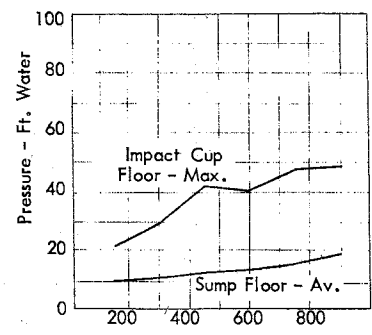
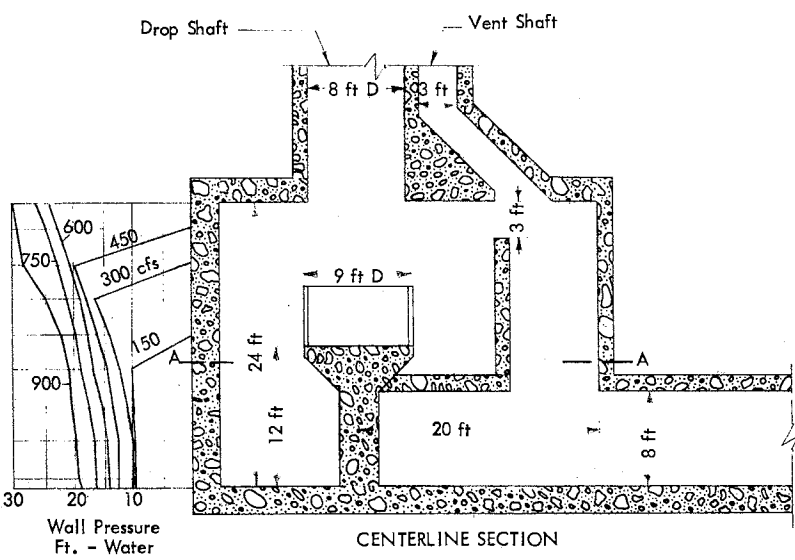
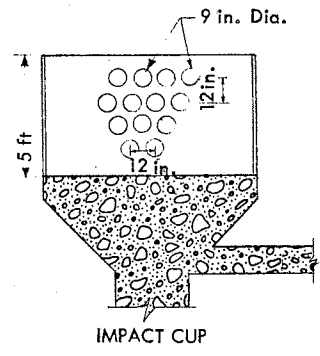
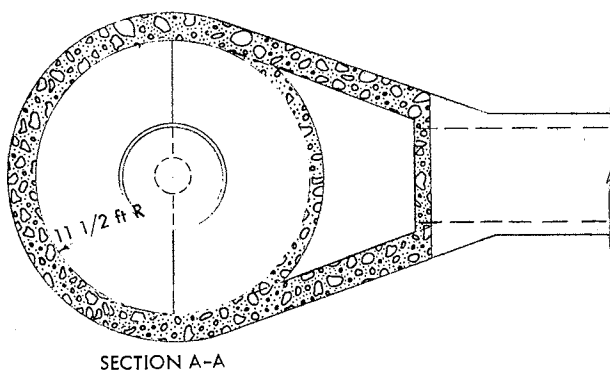
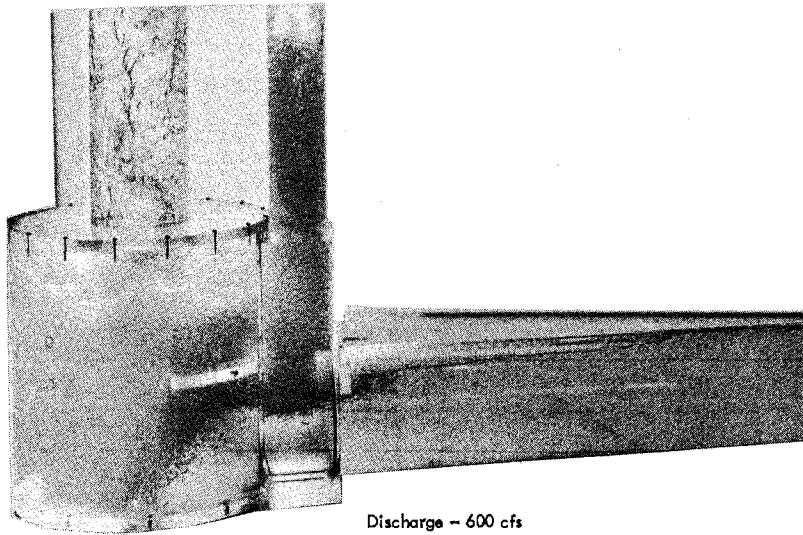
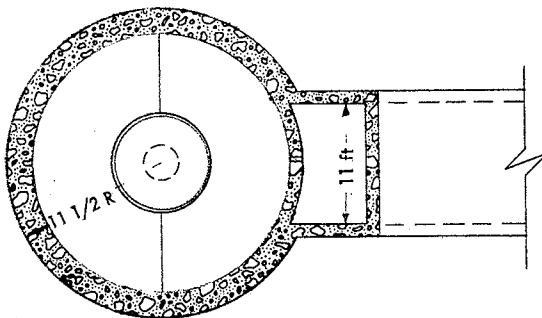

Fig. 41 - Series 14. Drop Shaft with 23-ft Diameter Circular Sump and Perforated Impact Cup and Short Discharge Chamber. Scale 1:24. Drop 100 ft



Discharge - 600 cfs



SECTION A - A

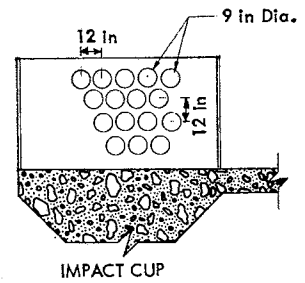

IMPACT CUP

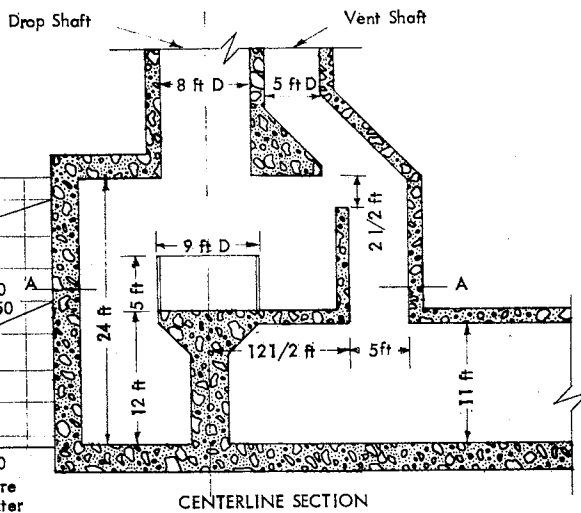

CENTERLINE SECTION

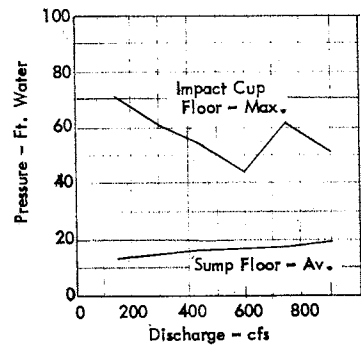
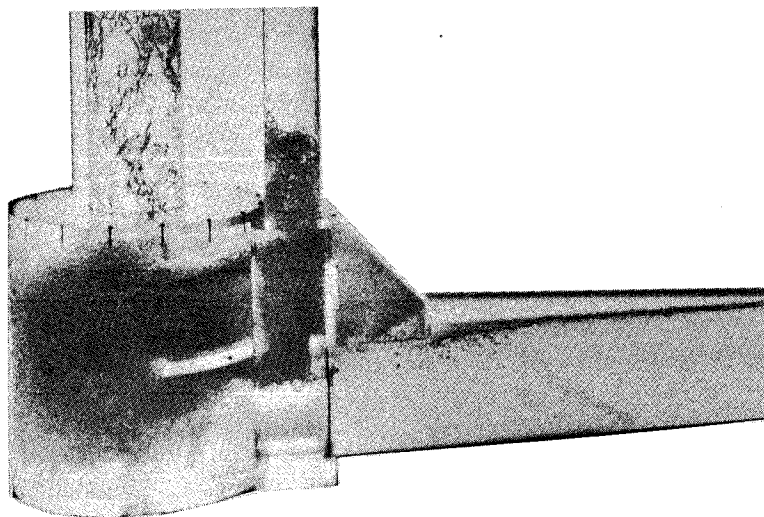
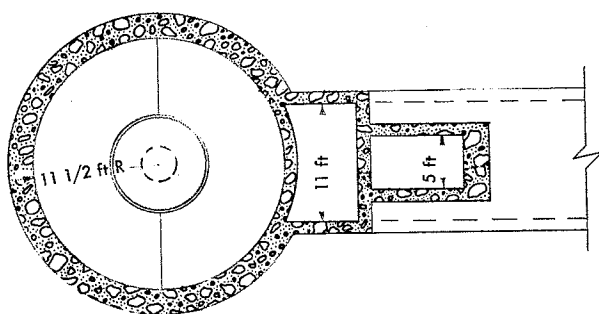

Fig. 42 - Series 15. Drop Shaft with 23-ft Diameter Circular Sump and Perforated Impact Cup. Discharge Conduit Increased from 8 ft to 11 ft in Diameter. Scale 1:24. Drop 100 ft



Discharge - 600 cfs



SECTION A - A

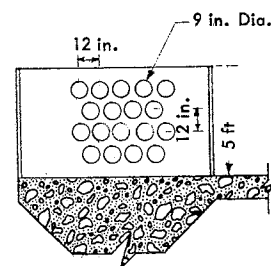

IMPACT CUP

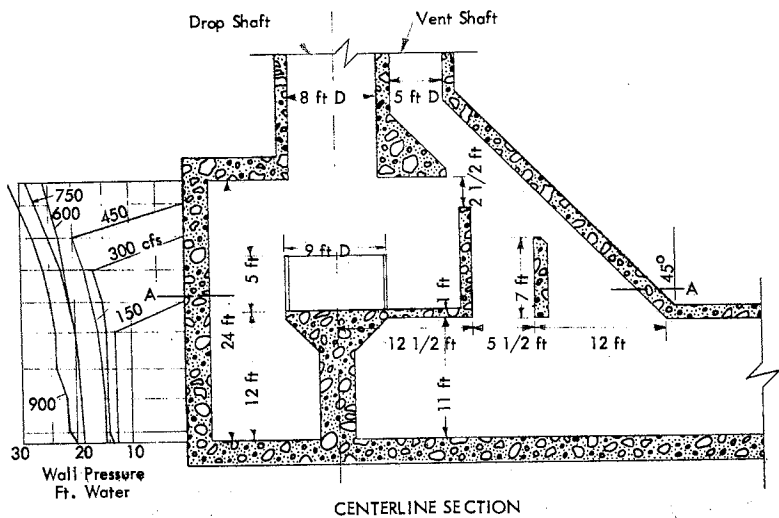

CENTERLINE SECTION

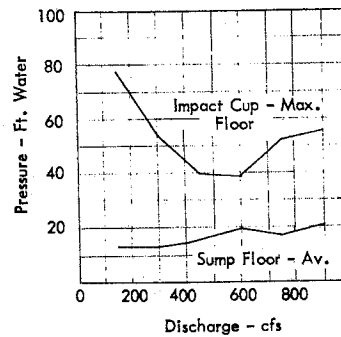
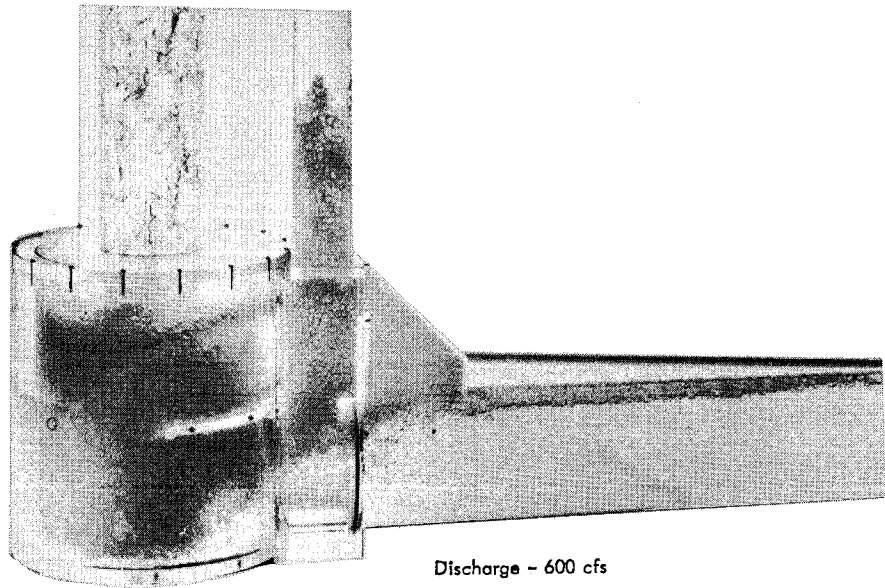
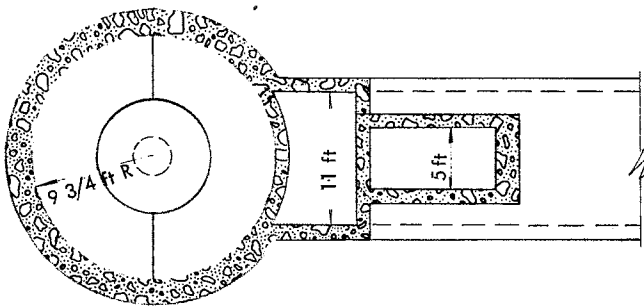

Fig. 43 - Series 17. Drop Shaft with 23-ft Circular Sump and Perforated Impact Cup. Sloping Roof Discharge Chamber. Scale 1:24. Drop 100 ft



Discharge - 600 cfs



SECTION A - A

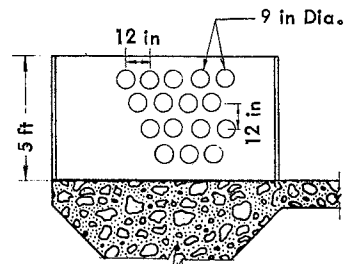

IMPACT CUP

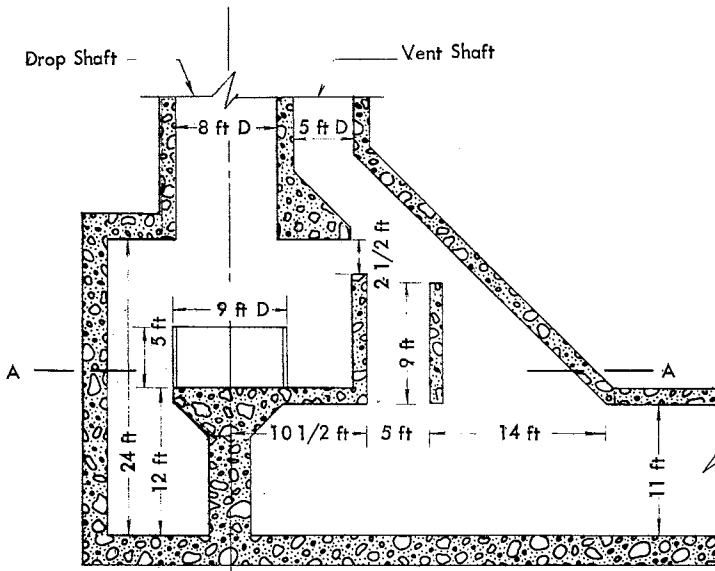

CENTERLINE SECTION

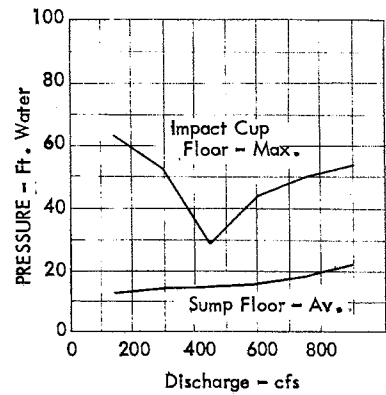
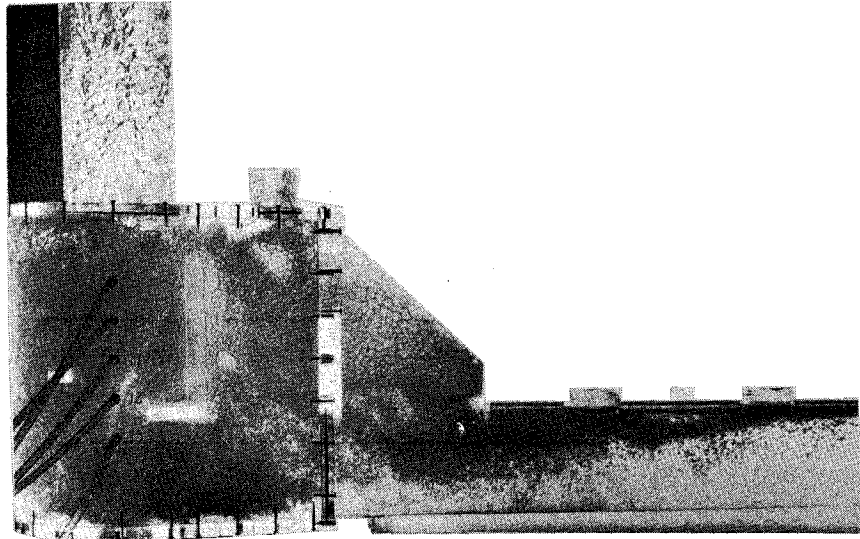
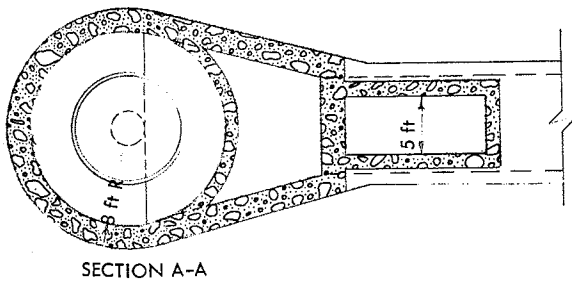

Fig. 44 - Series 18. Drop Shaft with 19-1/2-ft Diameter Circular Sump and Perforated Impact Cup. Sloping Roof Discharge Chamber. Scale 1:24. Drop 100 ft



Discharge - 600 cfs



SECTION A-A

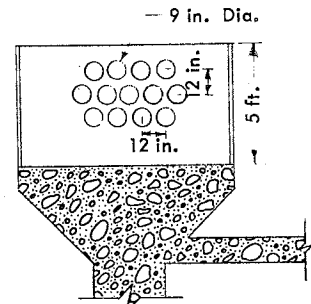

IMPACT CUP

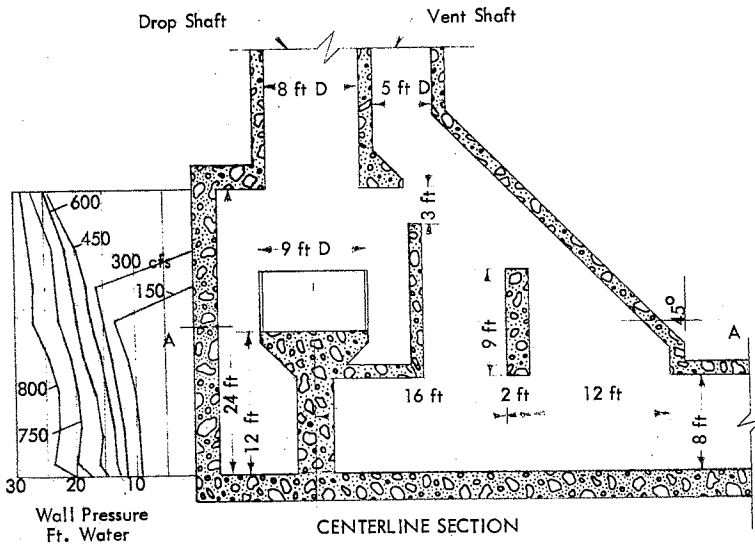

CENTERLINE SECTION

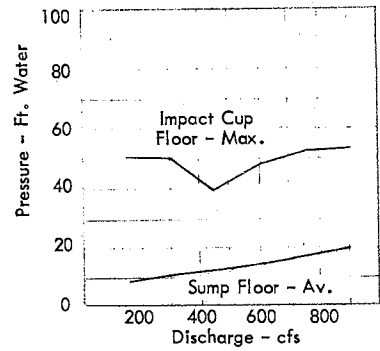
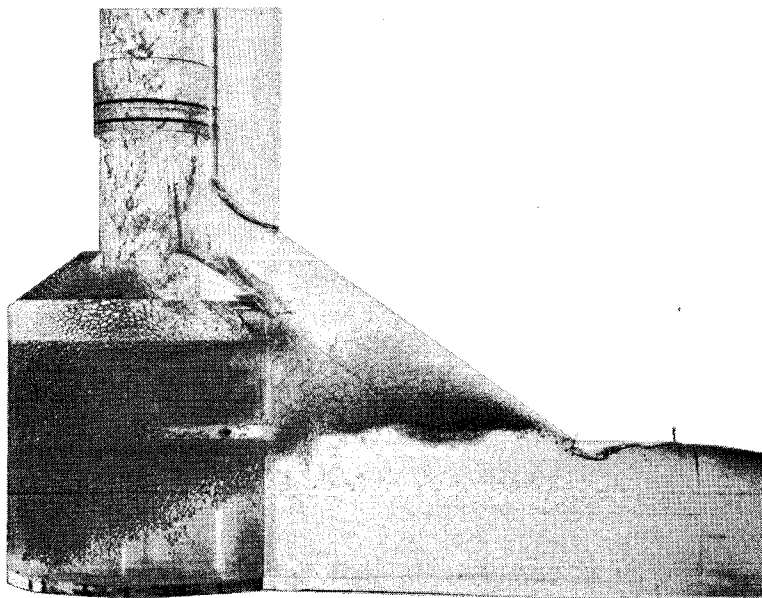
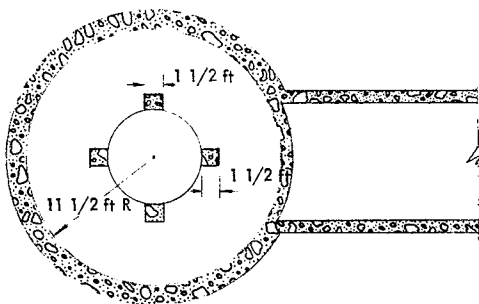

Fig. 45 - Series 19. Drop Shaft with 16-ft Diameter Circular Sump and Perforated Impact Cup. Sloping Roof Discharge Chamber. Scale 1:24. Drop 100 ft



Discharge 600 cfs



SECTION A-A

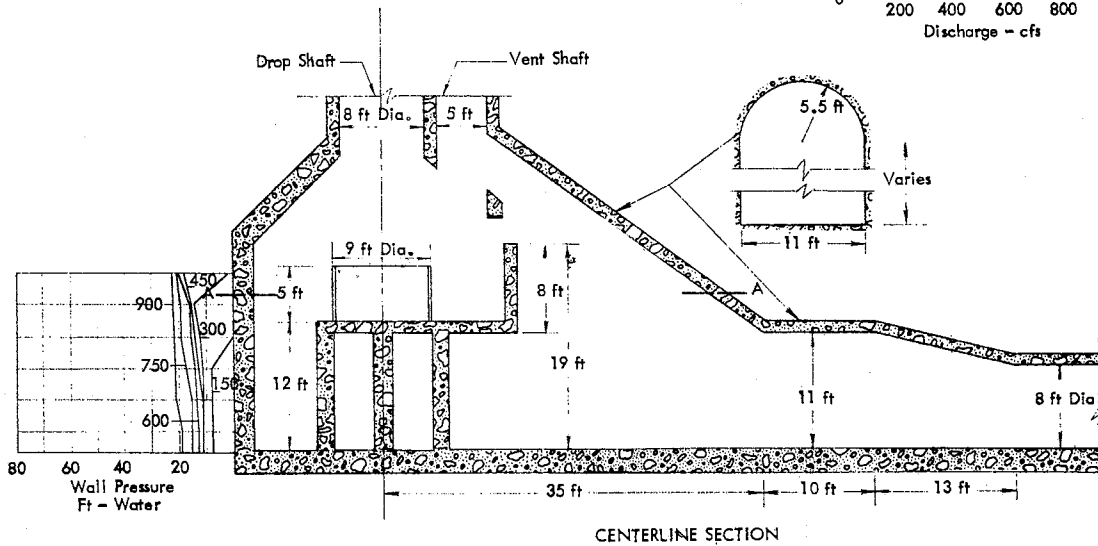
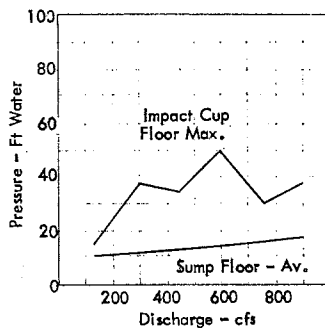

CENTERLINE SECTION

Fig. 46 - Series 20. Normal Grade Line. Recommended Design with 23-ft Diameter Sump and Perforated Impact Cup. Scale 1:24. Drop 100 ft

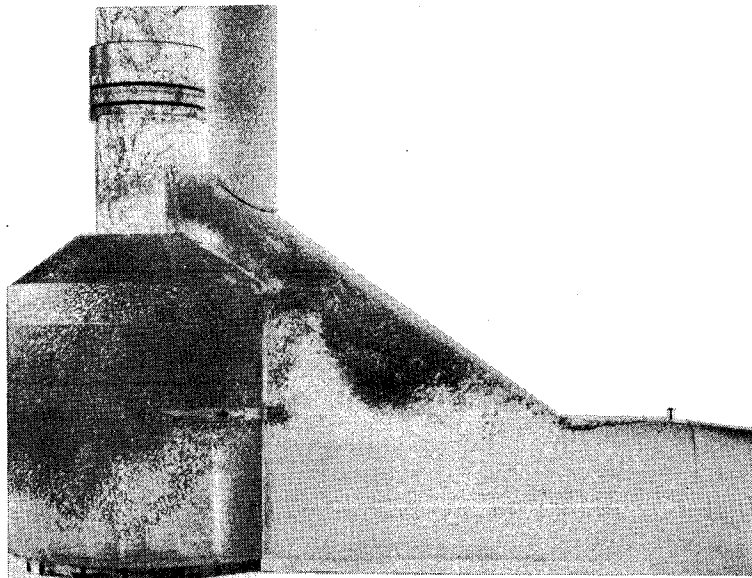

Discharge 600 cfs

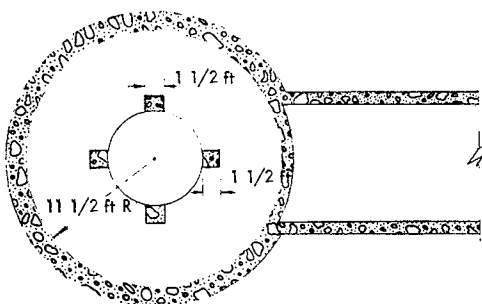

SECTION A-A

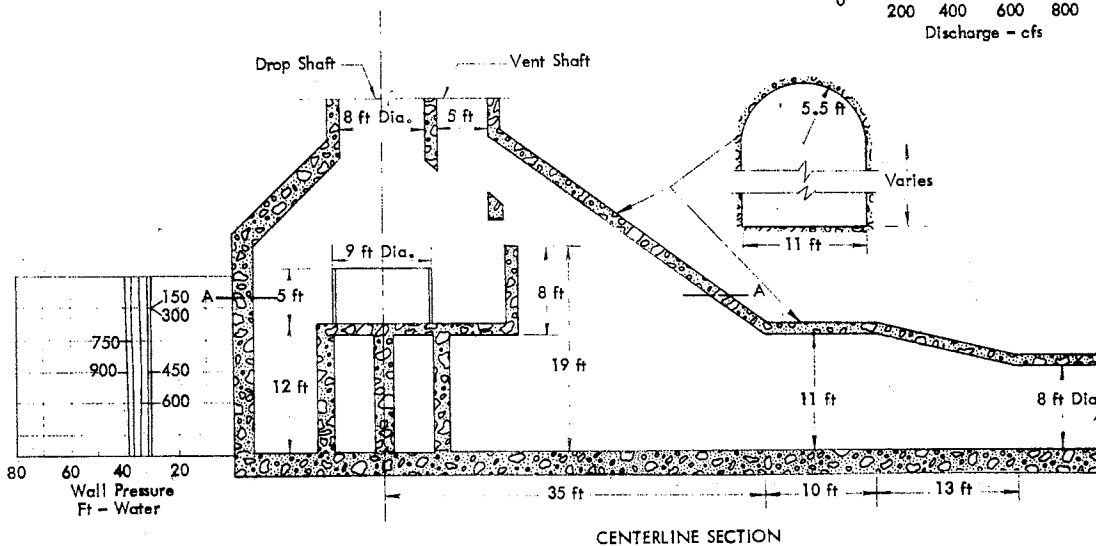
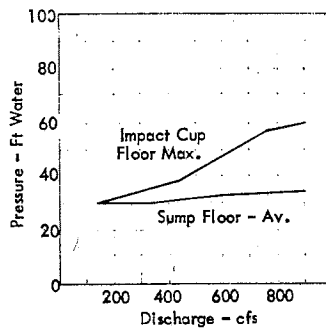

CENTERLINE SECTION

Fig. 47 - Series 20. Grade Line 30 ft. Recommended Design with 23-ft Diameter Sump and Perforated Impact Cup. Drop 100 ft. Scale 1:24

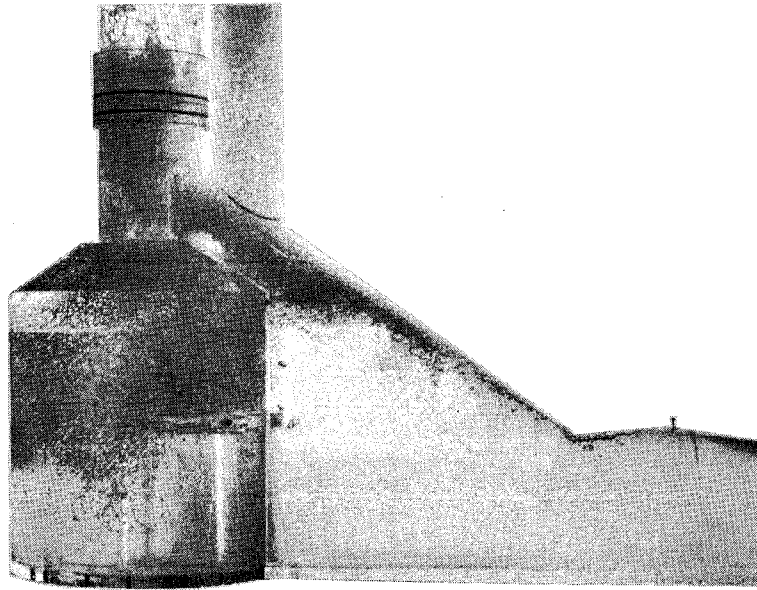

Discharge 600 cfs

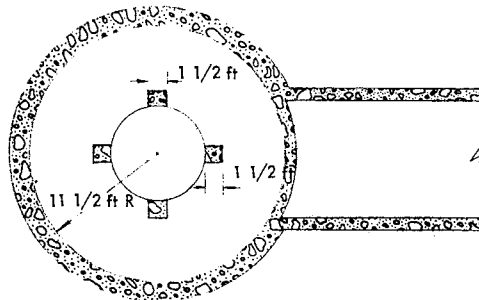

SECTION A-A

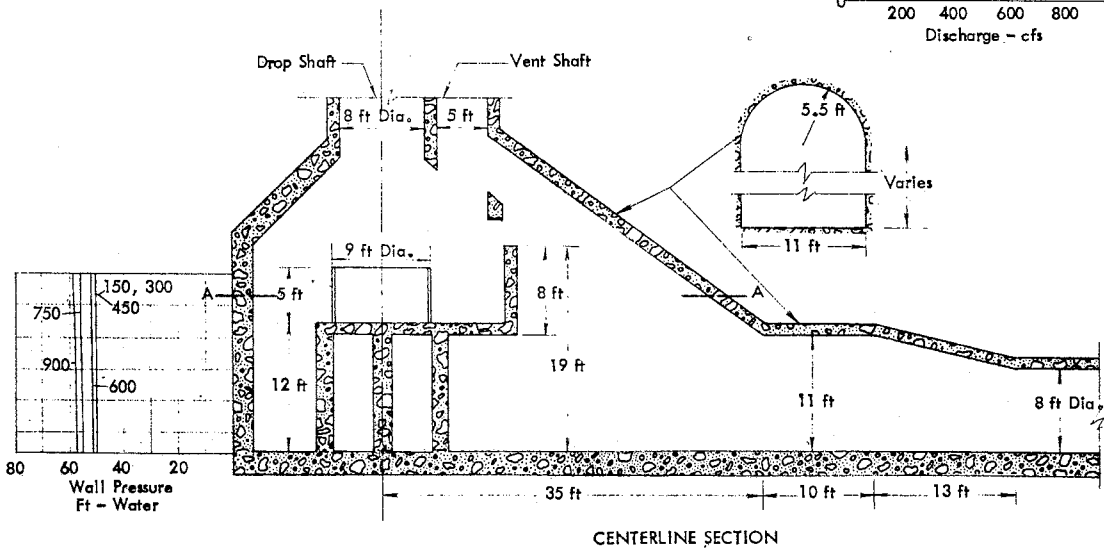
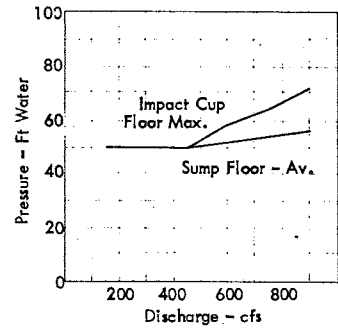

CENTERLINE SECTION

Fig. 48 - Series 20. Grade Line 50 ft. Recommended Design with 23-ft Diameter Sump and Perforated Impact Cup. Drop 100 ft. Scale 1:24

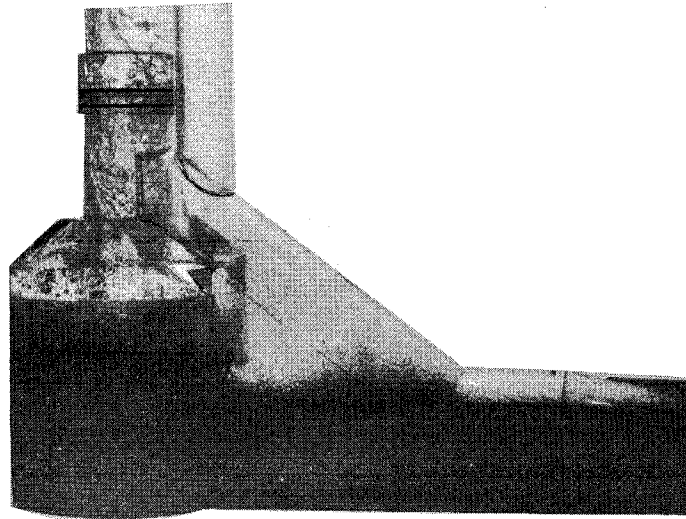

Discharge 600 cfs

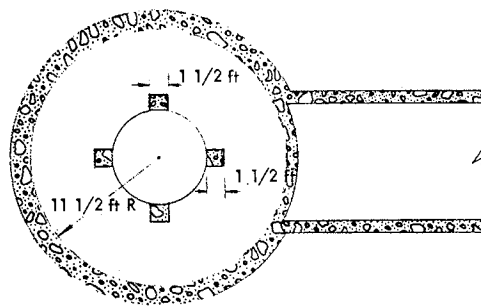

SECTION A-A

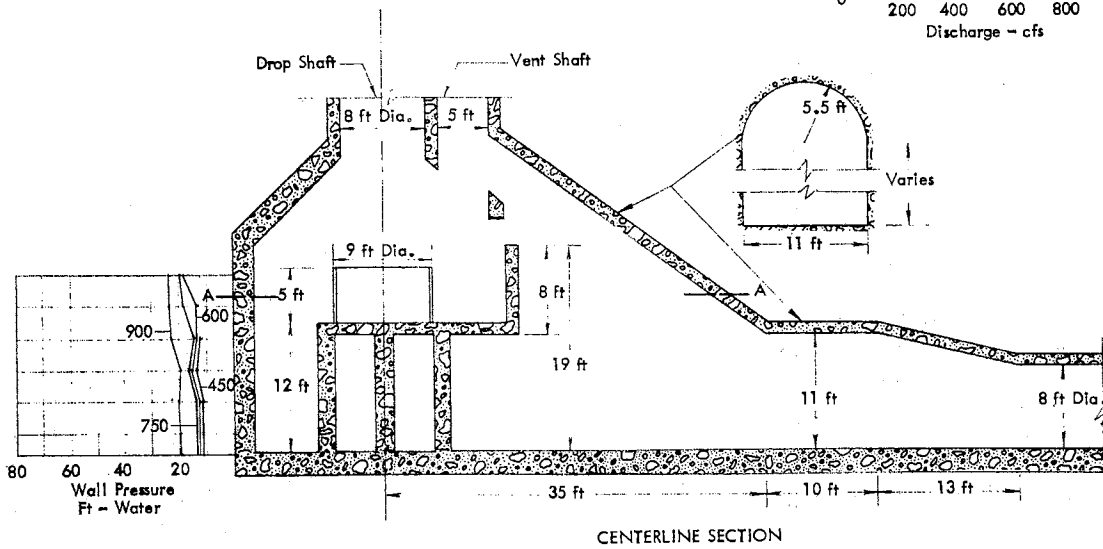
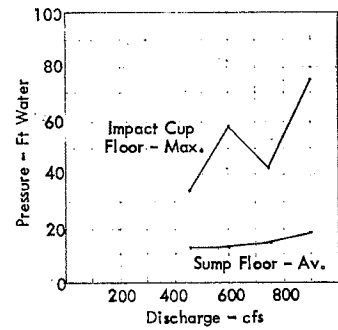

CENTERLINE SECTION

Fig. 49 - Series 21. Normal Grade Line. Recommended Design with 23-ft Diameter Sump and Perforated Impact Cup. Drop 135 ft. Scale 1:24

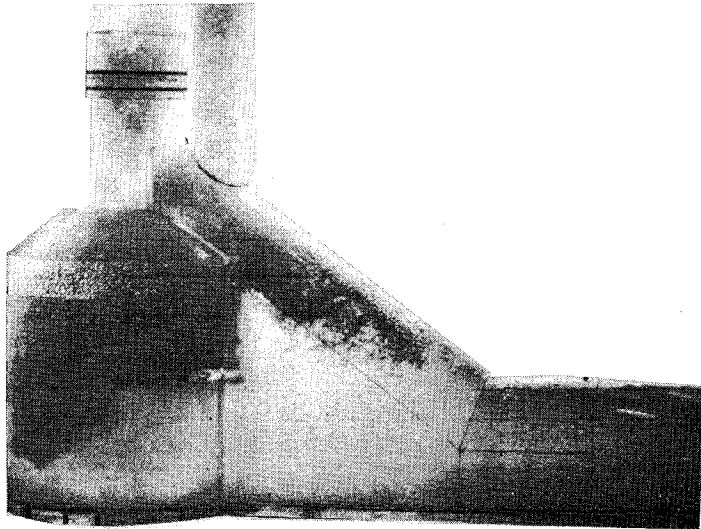

Discharge 600 cfs

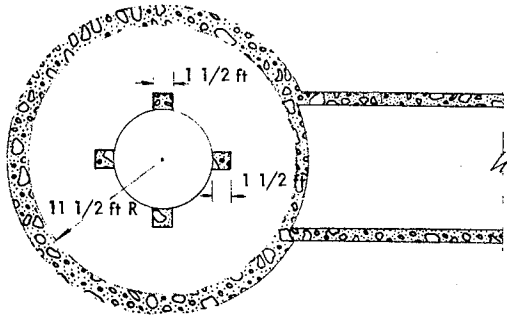

SECTION A-A

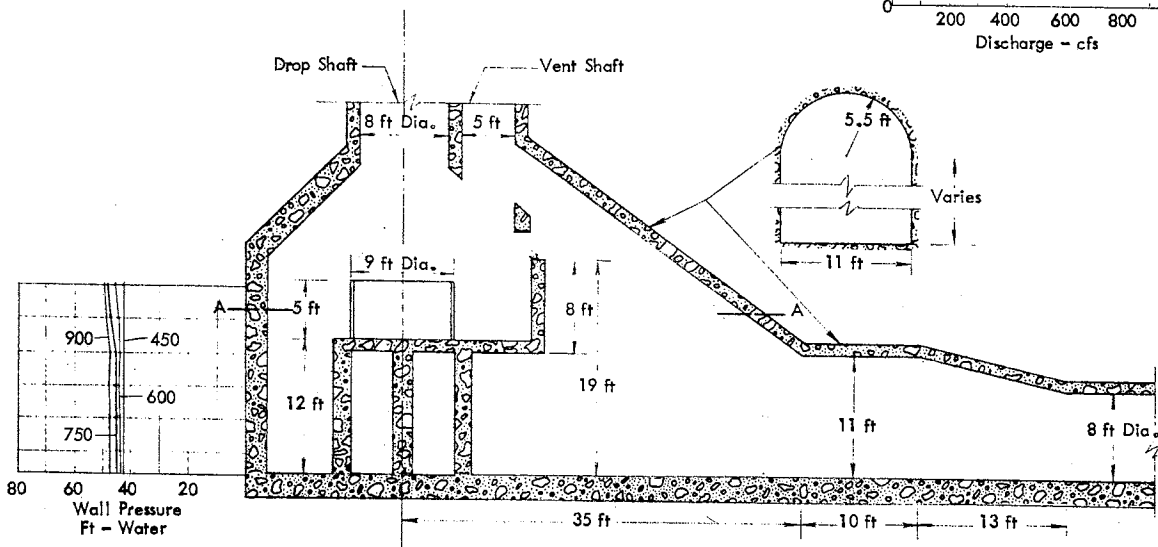
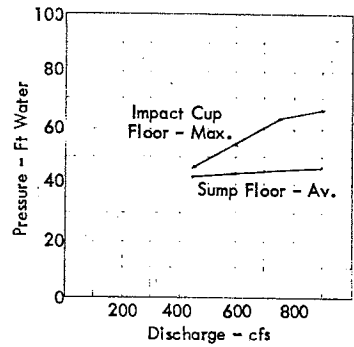

CENTERLINE SECTION

Fig. 50 - Series 21. Grade Line 40 ft. Recommended Design with 23-ft Diameter Sump and Perforated Impact Cup. Drop 135 ft. Scale 1:24

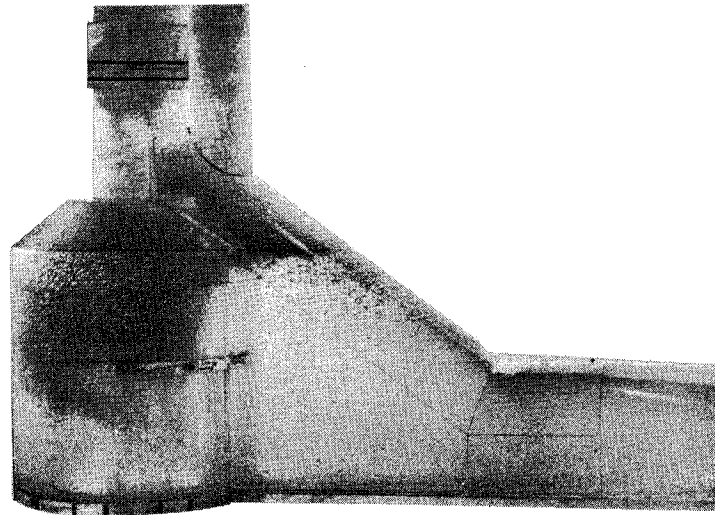

Discharge 600 cfs

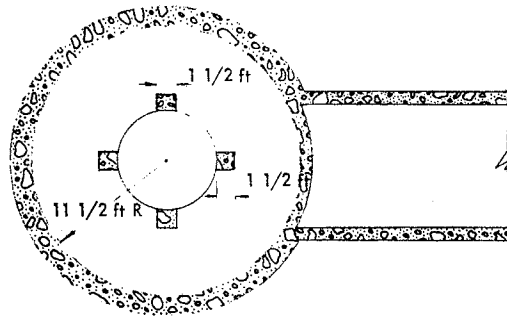

SECTION A-A

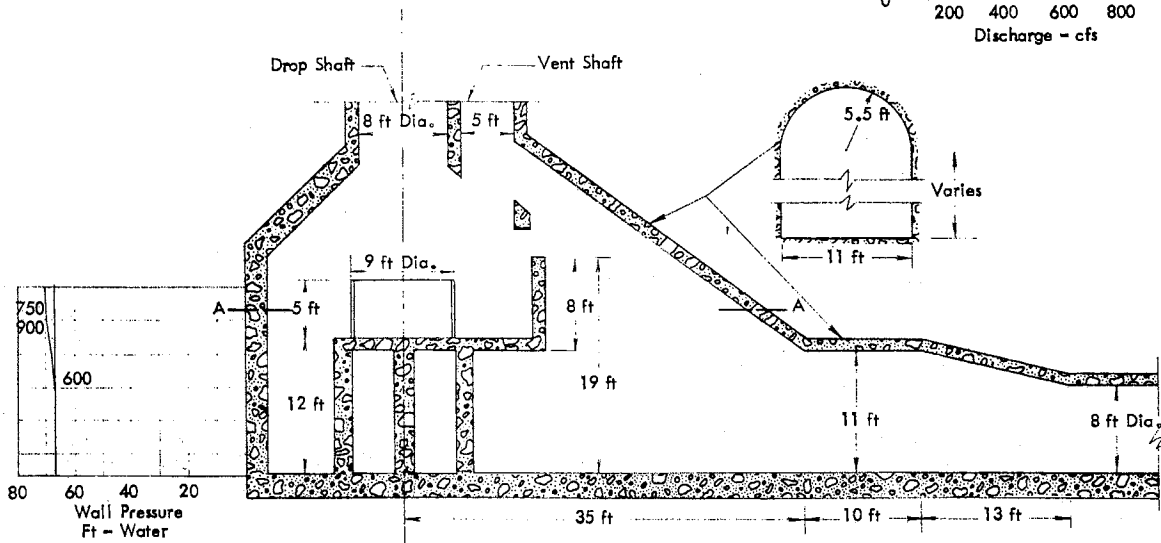
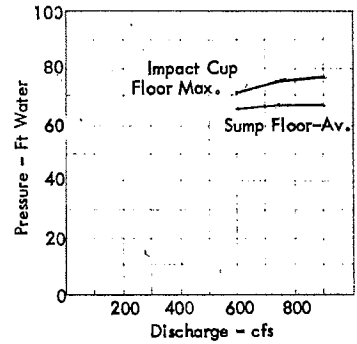

CENTERLINE SECTION

Fig. 51 - Series 21. Grade Line 60 ft. Recommended Design with 23-ft Diameter Sump and Perforated Impact Cup. Drop 135 ft. Scale 1:24

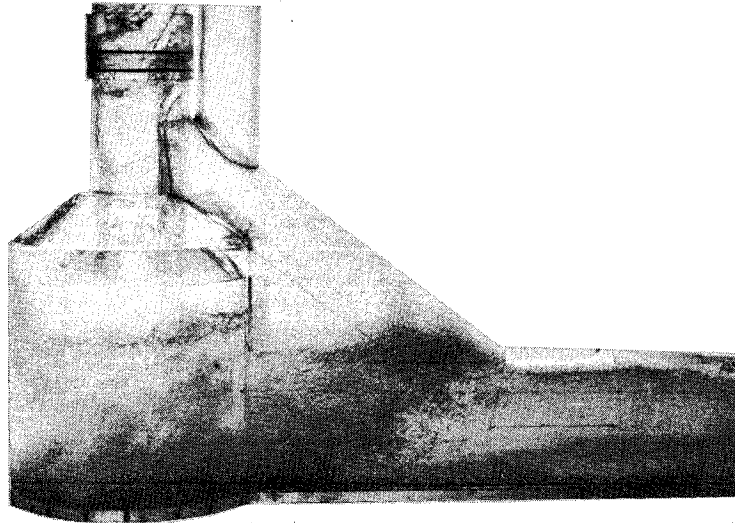

Discharge 600 cfs

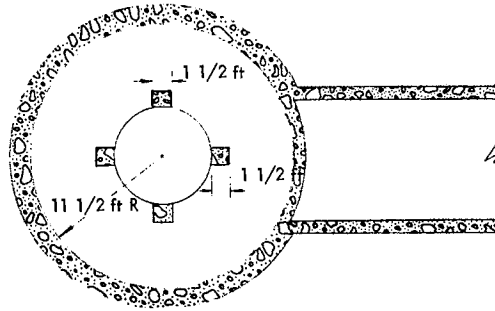

SECTION A-A

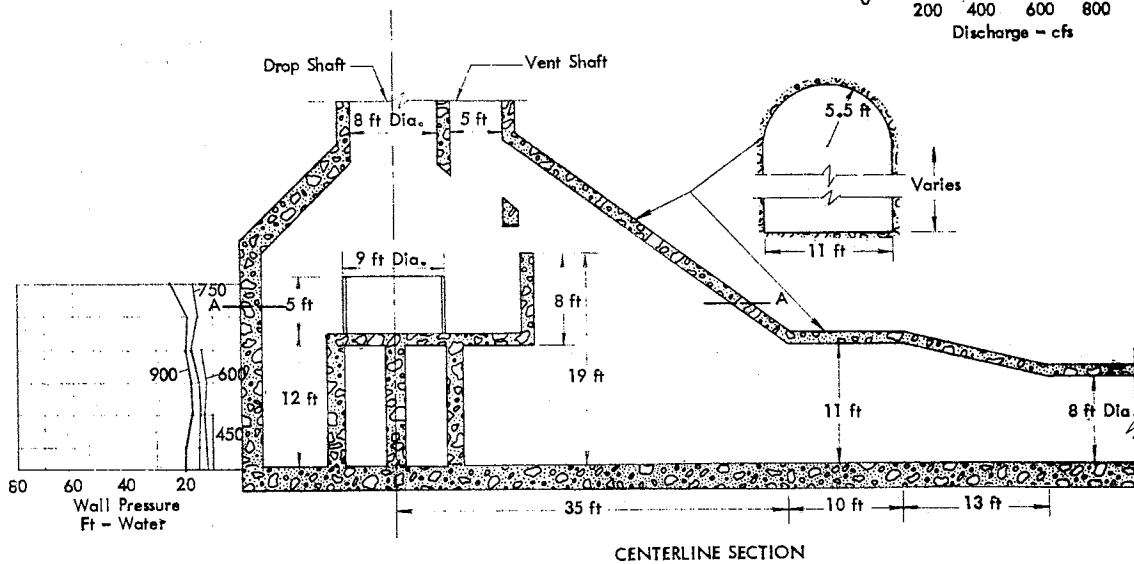
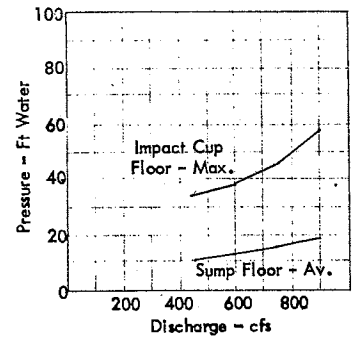

CENTERLINE SECTION

Fig. 52 - Series 22. Normal Grade Line. Recommended Design with 23-ft Diameter Sump and Perforated Impact Cup. Drop 62 ft. Scale 1:24

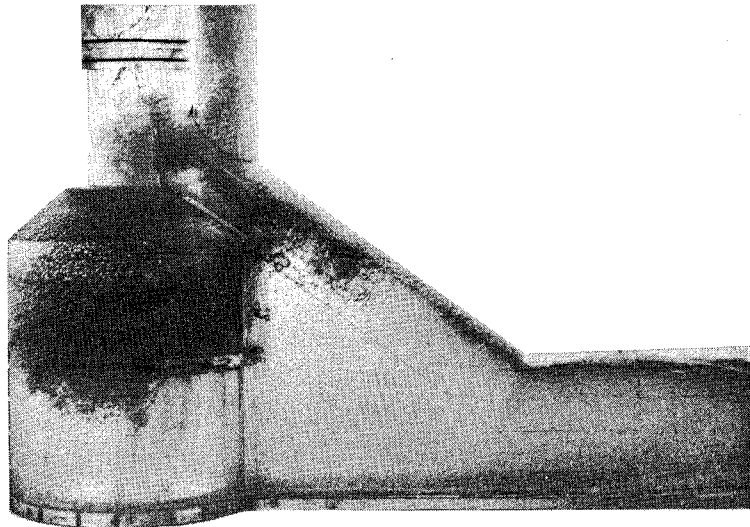

Discharge 600 cfs

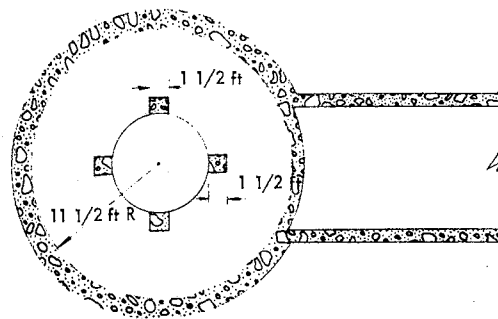

SECTION A-A

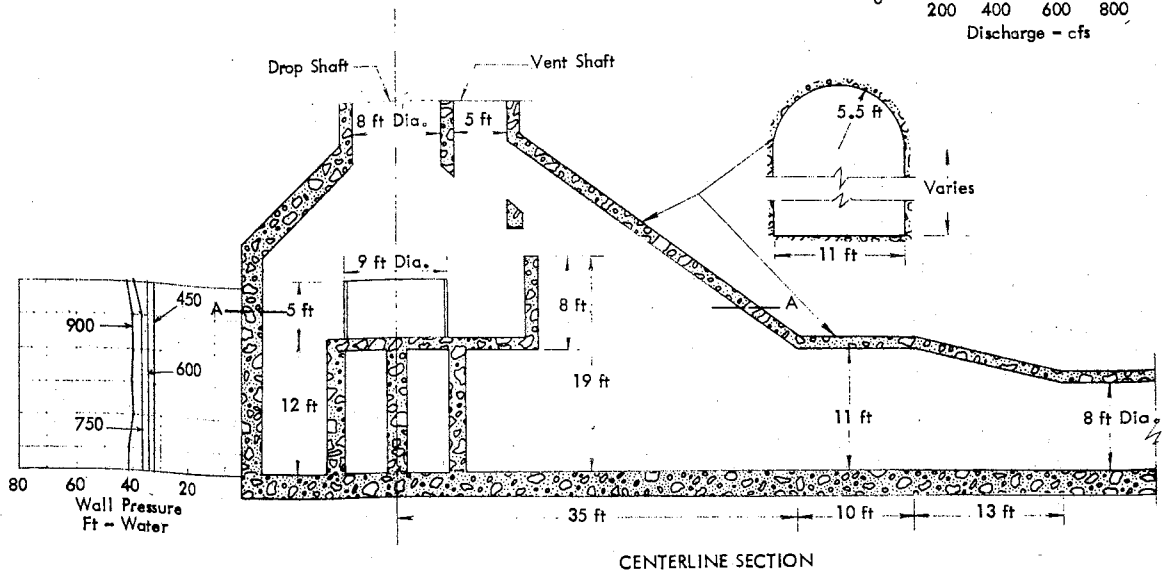
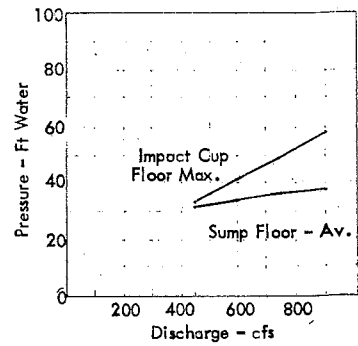

CENTERLINE SECTION

Fig. 53 - Series 22. Grade Line 20 ft. Recommended Design with 23-ft Diameter Sump and Perforated Impact Cup. Drop 62 ft. Scale 1:24

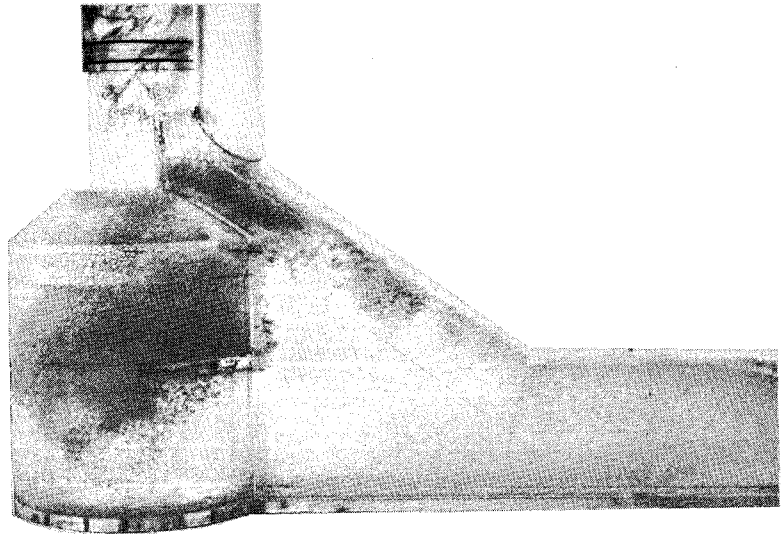

Discharge 600 cfs

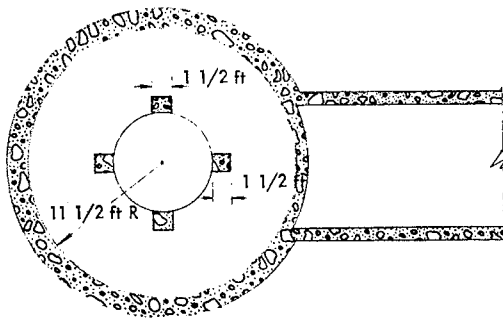

SECTION A-A

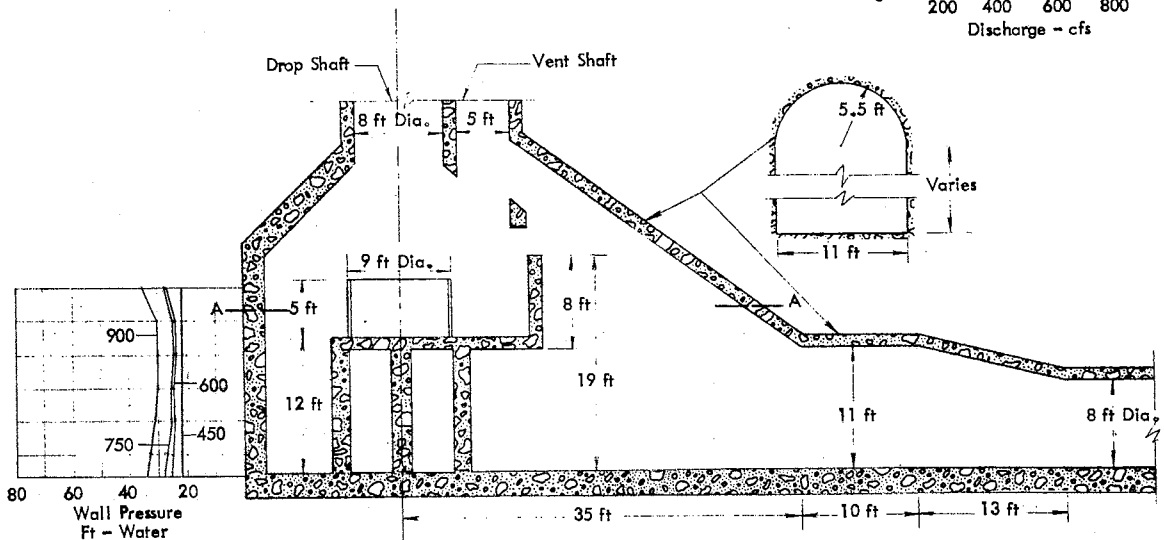
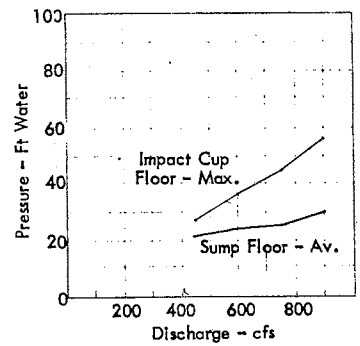

CENTERLINE SECTION

Fig. 54 - Series 22. Grade Line 30 ft. Recommended Design with 23-ft Diameter Sump and Perforated Impact Cup. Drop 62 ft

A P P E N D I X

A P P E N D I X

I. REVIEW OF "FLOW IN VERTICAL SHAFTS"

The purpose of this study was to provide aid for the Allegheny County Sanitary Authority in the design of a new interceptor system. The study was to cover the flow in the vertical shafts, dissipation of kinetic energy, and control of air entrained in the interceptor system.

A. Models

Two models were studied: the shaft-interceptor model and the diversion-structure model.

The shaft-interceptor model had a shaft diameter of 5.6 in. and a vertical drop of 32 ft ending in a stilling chamber at the bottom of the shaft. A horizontal pipe representing the lower interceptor line carried the flow from the stilling chamber. The hydraulic grade line on the system could be varied by regulation of a butterfly valve at the end of the lower horizontal interceptor line. Air vents were provided in the stilling chamber and also in the horizontal interceptor line.

The diversion-structure model was used to determine the adequacy of the design of the gate stilling tank with respect to the shaft inlet chamber. The results of the diversion-chamber tests have no bearing on the remainder of this study.

B. Model Tests

1. Shaft Entrance

Three types of shaft entrances were studied. Radial-entrance inlets gave high rates of discharge for small heads but resulted in negative pressures below the intake which were possible sources of cavitation and air entrainment. The flow was also unsteady and large slugs of air were drawn into the shaft. The addition of guide fins or vanes would have been required to insure "steady" radial flow.

2. Spiral (Vortex) Entrance (Unflooded Shaft)

In this model the flow was guided from the inlet at the chamber wall to the shaft by a spiral-shaped wall. This design resulted in a smoother water

surface with less air discharge than the radial flow design, but a greater head was required. The pressures in the shaft above the hydraulic grade line were atmospheric.

3. Vortex-Type Entrance

The shaft inlet tank for this series of tests was circular in plan, and the inlet was located in one corner and was a rectangular vertical slot the full depth of the inlet tank. The width of the inlet slot was varied from $3/4$ to 1 diameter of the drop shaft. Inlet-tank diameters recommended varied from 4 to 6 times the drop-shaft diameter. Tests on this type of inlet were made with various levels of the hydraulic grade line from open-channel flow in the horizontal interceptor to full-pipe flow with the inlet being flooded out.

When the freely falling water reached the hydraulic grade line in the shaft a "boil" developed similar to the hydraulic jump. Large losses in kinetic energy occurred at the boil. Air entrained at the boil was carried through the interface and down the shaft in amounts varying with the position of the hydraulic grade line. The lower the grade line the greater the air-water ratio.

Pressures in the shaft were measured by means of piezometers for the range of flow from open-channel flow in the interceptor to full flow. The inlet tank was "flooded out" by the boil in the shaft at approximately the same time that the hydraulic grade line reached the inlet.

4. Stilling Chamber

Very little comment is made on the de-aeration of the flow in the stilling chamber at the bottom of the shaft, and it would appear that since the grade line was kept quite high this area was not considered important. An estimate of the velocities at the bottom of the shaft developed by the free fall of the water from the inlet places a reduction at approximately 50 per cent due to the frictional losses of the spiraling water against the sides of the shaft.

5. Air Entrainment

Air carried down the shaft was collected in the stilling chamber and metered through an orifice. Figure A-1 shows the relation between air-water discharge ratios and the height of the hydraulic grade line above the stilling basin for both vortex and radial flow.

For high grade lines in the vertical shaft the volume of air entrained is relatively small, but as the grade line falls the air entrainment becomes greater and is a maximum for the condition of open-channel flow in the horizontal interceptor. It is apparent that the vortex-type entrance causes the least air entrainment; however, no indication of the relative size and arrangement of the stilling basin is given in the report.

Figure A-2 shows the effect of inlet-chamber diameter on the entrainment of air in the vertical shaft. The small-size chamber, while giving a greater discharge for a given head, also produces a larger air discharge.

C. Comments on Vortex Inlet

Figure A-3 is a summary of the test data showing the head-discharge relationship for vortex-type inlets of three diameter ratios.

Based on this information an inlet chamber for the maximum design flow of 600 cfs would have to be from 32 to 48 ft in diameter, assuming a drop-shaft diameter of 8 ft. The head required would range from 18 to 28 ft to obtain the desired design discharge of 600 cfs.

Obviously, the vortex inlet is a flow-limiting device and has been so used in other reported designs. The reduction in air entrainment secured with this device is far overshadowed by the increased cost of this inlet chamber as compared to the elbow-type inlet. At this point in our study the stilling-chamber area should be intensively explored with emphasis on air removal and energy dissipation.

II. REVIEW OF "VORTEX FLOW THROUGH HORIZONTAL ORIFICES"

The purpose of this study was to investigate vortex-type flow in connection with the diversion of sewage from combined sewers. A large part of the study concerns the theoretical aspects of vortex flow through an orifice and the discharge coefficient-vortex number relationship is presented. Model studies were performed both at the University of Wisconsin and at Portland, Oregon.

The Wisconsin studies were concerned with flow through the orifice and used a series of tank-diameter to orifice-diameter ratios in determining the flow characteristics. A composite curve of all data from these tests is presented in Fig. A-1.

The Portland tests were concerned with the application of vortex flow to sewage diversion.

The vortex chamber was placed adjacent to the main sewer line, and flow was diverted to the interceptor line through this chamber. As far as can be determined from this report only a small drop existed between the vortex chamber and the interceptor line.

Sanitary flows were diverted through the vortex chamber by placing a dam in the main sewer line of such height that the maximum sanitary flow would be completely diverted, but during storm flows only a limited discharge would be carried to the treatment plant.

This work has little bearing on the drop-shaft type of structure.

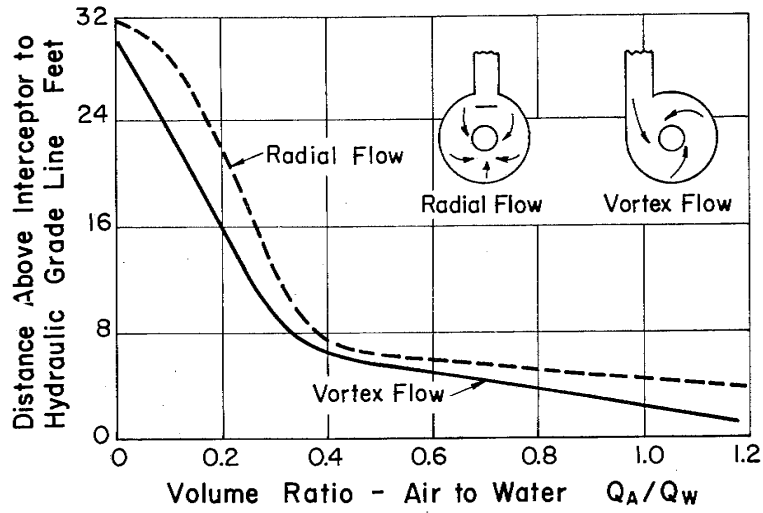

Fig. A-1

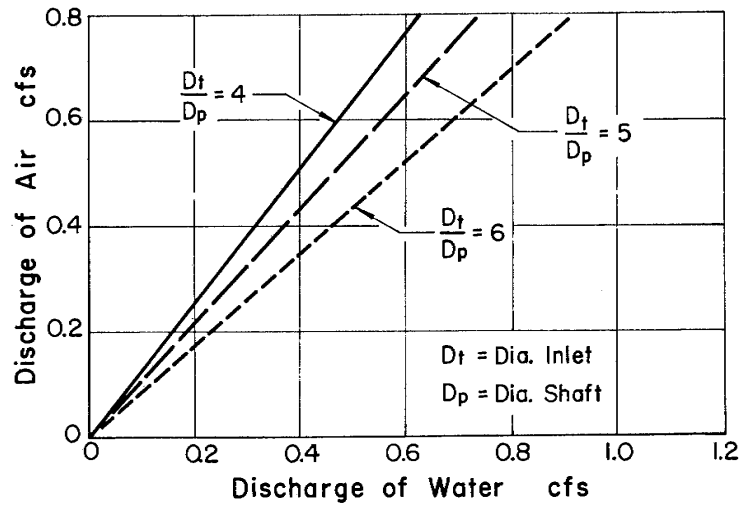

Fig. A-2

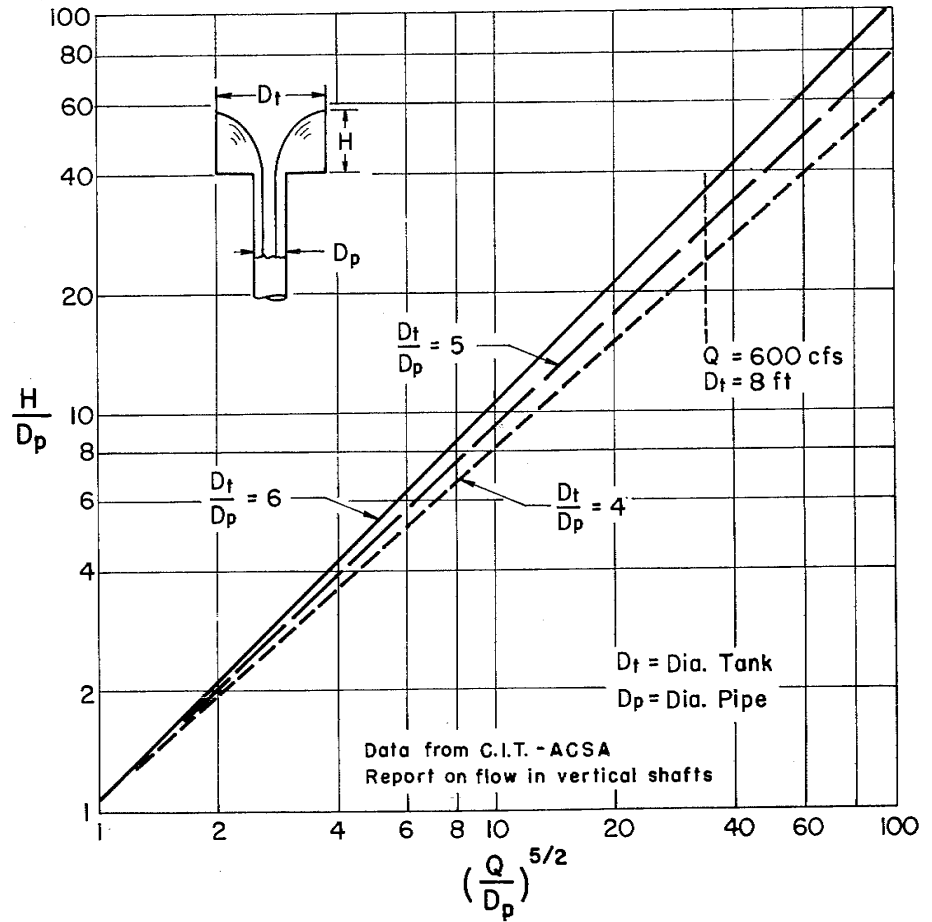

Fig. A-3